

SECTION INDEX Click on any section below to go that portion for a detailed Table of Contents



A. System Overview

B. Bundle

1. Cable Ties
2. Cable Accessories
3. Stainless Steel Cable Ties and Accessories

C. Route/Protect

1. Wiring Duct
2. Surface Raceway
3. Abrasion Protection
4. Cable Management

D. Terminate

1. Terminals
2. Power Connectors
3. Grounding Connectors

HELPFUL LINKS

See bottom of page for other helpful links

E. Identification and Safety Solutions

1. Labeling Systems
2. Labels
3. Pre-Printed and Write-On Markers
4. Permanent Identification
5. Lockout/Tagout and Safety Solutions

F. Part Number Index

CLICK on any of the tabs on this page to jump to that location within the catalog

A.
System
Overview

B1.
Cable Ties

B2.
Cable
Accessories

B3.
Stainless
Steel Ties

C1.
Wiring
Duct

C2.
Surface
Raceway

C3.
Abrasion
Protection

C4.
Cable
Management

D1.
Terminals

D2.
Power
Connectors

D3.
Grounding
Connectors

E1.
Labeling
Systems

E2.
Labels

E3.
Pre-Printed
& Write-On
Markers

E4.
Permanent
Identification

E5.
Lockout/
Tagout
& Safety
Solutions

F.
Index



Click on the logo above to go to www.panduit.com

up to date product information
find a local distributor
technical information

Search

Click above for instructions on how to search for part numbers and other terms in this catalog

Contact Panduit

Click above for contact information worldwide and regional headquarters

HELP!

Click above for helpful user tips on navigating this catalog and technical info about this software

To order a printed catalog, ask for SA-ELCB10
To order a catalog on CD, ask for SA-CPCD08

A.
System
Overview

Table of Contents SA-ELCB10 (replaces SA-ELCB03)

[Click Here for Instruction
on Searching by
Part Number](#)

B1.
Cable Ties

System Overview

| | |
|-----------------------------------|-------------|
| System Overview | A1.1 |
| Solutions Overview | A1.2 – A1.3 |
| Control Panel Solutions | A1.4 |
| Harness Solutions | A1.5 |
| Contractor Solutions | A1.6 |
| MRO Solutions | A1.6 |
| Harsh Environment Solutions | A1.7 |
| Transportation Solutions | A1.7 |
| Application Standards | A1.8 – A1.9 |
| Programs | A1.10 |

C1.
Wiring
Duct

Cable Ties

| | |
|--|---------------|
| Cable Ties | B1.1 |
| Cable Tie Selection Chart | B1.2 – B1.3 |
| Cable Tie Styles Overview | B1.4 – B1.5 |
| Features and Benefits – <i>PAN-TY</i> ® Cable Ties | B1.6 |
| Selection Guide – <i>PAN-TY</i> ® Cable Ties | B1.7 |
| <i>PAN-TY</i> ® Cable Ties – Nylon 6.6 | B1.8 |
| <i>PAN-TY</i> ® Lashing Ties – Nylon 6.6 | B1.9 |
| <i>PAN-TY</i> ® Cable Ties – Weather Resistant Nylon 6.6 | B1.10 |
| <i>PAN-TY</i> ® Lashing Ties – Weather Resistant Nylon 6.6 | B1.11 |
| <i>PAN-TY</i> ® Cable Ties – Heat Stabilized Nylon 6.6 | B1.12 |
| <i>PAN-TY</i> ® Cable Ties – Heat Stabilized Weather Resistant Nylon 6.6 | B1.13 |
| <i>PAN-TY</i> ® Cable Ties – Flame Retardant Nylon 6.6 | B1.14 |
| Cable Tie Mounts – Flame Retardant Nylon 6.6 | B1.14 |
| <i>PAN-TY</i> ® Cable Ties – Weather Resistant Nylon 12 | B1.15 |
| <i>PAN-TY</i> ® Cable Ties – Polypropylene – Distinctive Green Color | B1.16 |
| <i>PAN-TY</i> ® Cable Ties – Weather Resistant Polypropylene | B1.17 |
| <i>PAN-TY</i> ® Cable Ties – HALAR▲ – Distinctive Maroon Color | B1.18 |
| <i>PAN-TY</i> ® Cable Ties – TEFZEL■ – Distinctive Aqua Blue Color | B1.19 |
| Cable Tie Mounts – TEFZEL■ | B1.19 |
| ★ <i>PAN-TY</i> ® Cable Ties – PEEK (Polyetheretherketone) | B1.20 |
| ★ <i>PAN-TY</i> ® Cable Ties – Metal Detectable Nylon 6.6 | B1.21 |
| <i>PAN-TY</i> ® Releasable Cable Ties – Nylon 6.6 | B1.22 |
| <i>PAN-TY</i> ® Releasable Lashing Ties – Nylon 6.6 | B1.22 |
| <i>PAN-TY</i> ® Releasable Cable Ties – Weather Resistant and Heat Stabilized Nylon 6.6 | B1.23 |
| <i>PAN-TY</i> ® Releasable Lashing Ties – Weather Resistant Nylon 6.6 | B1.24 |
| Lashing Tie Mounting Clip – Weather Resistant Nylon 6.6 | B1.24 |
| <i>PAN-TY</i> ® Releasable Lashing Ties – Weather Resistant Polypropylene | B1.25 |
| <i>PAN-TY</i> ® Clamp Ties – Nylon 6.6 | B1.26 |
| <i>PAN-TY</i> ® Clamp Ties – Weather Resistant and Heat Stabilized Nylon 6.6 | B1.27 |
| <i>PAN-TY</i> ® Wing Push Mount Ties – Nylon 6.6 | B1.28 |
| <i>PAN-TY</i> ® Wing Push Mount Ties – Weather Resistant and Heat Stabilized Nylon 6.6 | B1.29 |
| <i>PAN-TY</i> ® Releasable Wing Push Mount Ties | B1.30 |
| <i>PAN-TY</i> ® Center Mounted Wing Push Mount Ties – Heat Stabilized Nylon 6.6 | B1.31 |
| <i>PAN-TY</i> ® Ladder Style Releasable Wing Push Mount Ties – Heat Stabilized Nylon 6.6 | B1.32 |
| <i>PAN-TY</i> ® Umbrella Wing Push Mount Ties – Nylon and Heat Stabilized Nylon 6.6 | B1.32 |
| <i>PAN-TY</i> ® Push Mount Ties | B1.33 |
| <i>PAN-TY</i> ® Marker and Flag Ties | B1.34 |
| <i>PAN-TY</i> ® Cable Ties Material and Color Chart | B1.35 – B1.37 |
| Features and Benefits – <i>SUPER-GRIP</i> ® Cable Ties | B1.38 |
| Selection Guide – <i>SUPER-GRIP</i> ® Cable Ties | B1.39 |
| <i>SUPER-GRIP</i> ® Cable Ties – Nylon 6.6 | B1.40 |
| <i>SUPER-GRIP</i> ® Cable Ties – Weather Resistant and Heat Stabilized Nylon 6.6 | B1.41 |
| <i>SUPER-GRIP</i> ® Cable Ties and Mounts Material and Color Chart | B1.42 |
| Features and Benefits – <i>DOME-TOP</i> ® Barb Ty Cable Ties | B1.43 |
| Selection Guide – <i>DOME-TOP</i> ® Barb Ty and <i>DURA-TY</i> ™ Cable Ties | B1.44 |
| <i>DOME-TOP</i> ® Barb Ty Cable Ties – Nylon 6.6 | B1.45 |
| <i>DOME-TOP</i> ® Barb Ty Cable Ties – Weather Resistant Nylon 6.6 | B1.46 |
| <i>DOME-TOP</i> ® Barb Ty Cable Ties – Heat Stabilized Nylon 6.6 | B1.47 |
| <i>DOME-TOP</i> ® Barb Ty Clamp Ties – Nylon 6.6 | B1.48 |
| <i>DOME-TOP</i> ® Barb Ty Clamp Ties – Weather Resistant and Heat Stabilized Nylon 6.6 | B1.49 |
| <i>DOME-TOP</i> ® Barb Ty Wing Push Mount Ties – Nylon and Weather Resistant Nylon 6.6 | B1.50 |
| <i>DOME-TOP</i> ® Barb Ty Push Mount Ties – Weather Resistant Nylon 6.6 | B1.51 |

■ TEFZEL is a registered trademark of E.I. du Pont de Nemours and Company. ▲ HALAR is a registered trademark of Solvay Solexis, Inc.

★ Represents new product offering.

Table of Contents

| | |
|---|-----------------|
| Permanent Marking Pens | B1.51 |
| <i>DOME-TOP</i> ® Barb Ty Marker and Flag Ties | B1.52 |
| ★ <i>DURA-TY</i> ™ Cable Ties – Weather Resistant Acetal – Heavy Cross Section | B1.53 |
| <i>DURA-TY</i> ™ Cable Ties – Weather Resistant Acetal – Extra-Heavy Cross Section | B1.53 |
| Stackable Aerial Cable Spacer – Weather Resistant Polypropylene | B1.54 |
| <i>DOME-TOP</i> ® Barb Ty and <i>DURA-TY</i> ™ Cable Ties Material and Color Chart | B1.54 – B1.55 |
| Features and Benefits – Parallel-Entry Cable Ties | B1.56 |
| Selection Guide – Parallel-Entry Cable Ties | B1.57 |
| <i>CONTOUR-TY</i> ® Cable Ties – Nylon 6.6 | B1.58 |
| <i>CONTOUR-TY</i> ® Cable Ties – Weather Resistant Nylon 6.6 | B1.59 |
| <i>CONTOUR-TY</i> ® Cable Ties – Heat Stabilized and Flame Retardant Nylon 6.6 | B1.60 |
| <i>BELT-TY</i> ™ In-Line Cable Ties – Nylon and Weather Resistant Nylon 6.6 | B1.61 |
| ★ <i>HYPER-V</i> ™ In-Line Cable Ties – Weather Resistant Nylon 6.6 | B1.62 |
| ★ <i>HYPER-V</i> ™ Cable Tie Mounts | B1.62 |
| IN-LINE Cable Ties – Weather Resistant Nylon 6.6 | B1.63 |
| Parallel-Entry Cable Ties Material and Color Chart | B1.64 |
| Features and Benefits – <i>STA-STRAP</i> ® Cable Ties | B1.65 |
| Selection Guide – <i>STA-STRAP</i> ® Cable Ties | B1.66 |
| <i>STA-STRAP</i> ® Cable Ties – Nylon 6.6 | B1.67 |
| <i>STA-STRAP</i> ® Cable Ties – Weather Resistant Nylon 6.6 | B1.68 |
| <i>STA-STRAP</i> ® Cable Ties – Heat Stabilized Nylon 6.6 | B1.69 |
| <i>STA-STRAP</i> ® Clamp Ties | B1.70 |
| <i>STA-STRAP</i> ® Marker Ties – Nylon and Weather Resistant Nylon 6.6 | B1.71 |
| <i>STA-STRAP</i> ® Cable Ties Material and Color Chart | B1.72 |
| Selection Guide – Specialty Ties | B1.73 |
| <i>PAN-TY</i> ® Stud Mounted Cable Ties – Heat Stabilized and Heat Stabilized Weather Resistant Nylon 6.6 | B1.74 |
| <i>PAN-TY</i> ® Ladder Style Stud Mounted Cable Tie – Heat Stabilized Nylon 6.6 | B1.75 |
| <i>PAN-TY</i> ® Double Loop Cable Ties | B1.76 |
| <i>STA-STRAP</i> ® <i>BOW-TY</i> ™ Cable Ties | B1.77 |
| <i>PAN-TY</i> ® Triple Loop Cable Tie – Weather Resistant Nylon 6.6 | B1.78 |
| Double Hose Clamp – Weather Resistant Nylon 6.6 | B1.78 |
| <i>STA-STRAP</i> ® Chassis/Panel Mount Tie – Heat Stabilized Weather Resistant Nylon 6.6 | B1.79 |
| Cable Marker Straps – Polyethylene | B1.80 |
| Specialty Cable Ties Material and Color Chart | B1.81 |
| <i>PAN-TY</i> ® Striped Cable Ties – Nylon 6.6 | B1.82 |
| Telephone Cable Identification Kits | B1.83 |
| Cable Tie Kits in Steel Boxes | B1.83 |
| Cable Tie Kits in Plastic Boxes and Bags | B1.84 |
| Features and Benefits – Hook and Loop Cable Ties | B1.85 |
| Selection Guide – Hook and Loop Cable Ties | B1.86 |
| <i>TAK-TY</i> ® Hook & Loop Cable Ties | B1.87 |
| <i>TAK-TY</i> ® Hook & Loop Cable Ties – Plenum-Rated | B1.88 |
| <i>TAK-TAPE</i> ™ Hook & Loop Cable Tie Rolls | B1.88 |
| <i>ULTRA-CINCH</i> ™ Hook & Loop Cable Ties | B1.89 |
| Hook and Loop Cable Ties | B1.90 |
| Hot Stamping Service – Custom Printed Cable Ties | B1.91 |
| <i>PANDUIT</i> Cable Tie Approvals | B1.92 |
| Military Cross Reference | B1.93 – B1.95 |
| Cable Tie Selection and Specification Guidelines | B1.96 |
| Weathering | B1.97 – B1.98 |
| Flammability | B1.99 – B1.100 |
| Radiation/Moisture/Temperature/Tensile Strength | B1.101 |
| Chemical Resistance Table | B1.102 – B1.105 |
| Manual Cable Tie Installation Tools | B1.107 |
| Selection Guide – Hand Tools, Accessories, and Kits | B1.108 |
| Cable Tie Tools – Tool Controlled Tension and Cut-Off | B1.109 |
| Cable Tie Tools – Installer Controlled Tension and Cut-Off | B1.110 |
| Pneumatic Hand Tools – Tool Controlled Tension and Cut-Off | B1.111 |
| Pneumatic Tool Accessories | B1.111 |
| Tool Tension Locking Kits | B1.112 |
| Blade Replacement Kits | B1.112 |
| Hand Tool Holster | B1.112 |
| ★ Cushion Sleeve Kits | B1.112 |
| Automatic Cable Tie Installation Systems | B1.113 |
| Selection Guide – Automatic Installation Systems and Reel-Fed Cable Ties | B1.114 |
| System Selection Guide | B1.115 |
| Tool Head | B1.115 |
| Dispenser | B1.115 |

★ Represents new product offering.

| |
|--|
| A. System Overview |
| B1. Cable Ties |
| B2. Cable Accessories |
| B3. Stainless Steel Ties |
| C1. Wiring Duct |
| C2. Surface Raceway |
| C3. Abrasion Protection |
| C4. Cable Management |
| D1. Terminals |
| D2. Power Connectors |
| D3. Grounding Connectors |
| E1. Labeling Systems |
| E2. Labels |
| E3. Pre-Printed & Write-On Markers |
| E4. Permanent Identification |
| E5. Lockout/ Tagout & Safety Solutions |
| F. Index |

A.
System
Overview

Table of Contents

| | | |
|--------------------------------|--|--------|
| B1. Cable Ties | Transfer Hose | B1.116 |
| | Dispenser Frame | B1.116 |
| | Filter/Regulator and Air Supply Hose | B1.117 |
| | Bench Mount | B1.117 |
| B2. Cable Accessories | Data Interface Software and Ethernet Enabled Dispenser | B1.117 |
| | BT-XMR Reel-Fed Cable Ties | B1.118 |
| | PLT-XMR Reel-Fed Cable Ties | B1.119 |
| | PLT-VMR Reel-Fed Cable Ties | B1.120 |
| B3. Stainless Steel Ties | Tie Harness Mount for Single Cable Tie – Nylon and Heat Stabilized Nylon 6.6 | B1.121 |
| | Tie Harness Mounts – Nylon and Heat Stabilized Nylon 6.6 | B1.121 |

Cable Accessories

| | | |
|--|---|---------------|
| C1. Wiring Duct | Cable Accessories | B2.1 |
| | 4-Way Adhesive Backed Cable Tie Mounts | B2.2 – B2.3 |
| | ABMQ Multiple Bridge Mounts | B2.4 |
| | <i>SUPER-GRIP</i> ® Adhesive Back Mounts | B2.5 |
| | Combination Adhesive Mount/Cable Ties | B2.6 |
| C2. Surface Raceway | Snap-In Cable Tie Mounts – Mechanically Applied | B2.6 |
| | Epoxy Applied Mounts | B2.7 |
| | Epoxy Applied Swivel Mount | B2.7 |
| | Epoxy Applied Cable Tie Mount Kits | B2.8 |
| C3. Abrasion Protection | Cable Tie Mounts | B2.9 |
| | <i>TAK-TY</i> ® Hook & Loop Cable Tie Mounts | B2.10 |
| | Extra-Heavy Cable Tie Mounts | B2.10 |
| | Tie Mounts – Applied with User Supplied Adhesives | B2.11 |
| | Low Profile Tie Mounts – User Supplied Adhesive Mounts | B2.11 |
| C4. Cable Management | Swivel Mounts | B2.11 |
| | Stud Tie Mounts | B2.12 |
| | Tie Anchor Mounts – Screw Applied | B2.12 |
| | Tie Anchor Mounts | B2.13 |
| | Low Profile Mounts – Screw Applied | B2.13 |
| D1. Terminals | ★ <i>HYPER-V</i> ™ Cable Tie Mounts | B2.13 |
| | <i>SUPER-GRIP</i> ® Tie Mounts | B2.14 |
| | Low Profile Mounts – Push Rivet Applied | B2.14 |
| D2. Power Connectors | Cable Tie Plates | B2.15 |
| | Multiple Tie Plates | B2.15 – B2.16 |
| | Contour Multiple Tie Plates | B2.16 |
| | Right Angle Mounts | B2.17 |
| | Lightening Hole Mounts | B2.17 |
| D3. Grounding Connectors | Metal Clip-On Mounts | B2.18 |
| | Metal Screw-On Mount | B2.18 |
| | Push Barb Cable Tie Mounts | B2.18 |
| | Push Mounts | B2.19 |
| | Push Button Mount | B2.19 |
| E1. Labeling Systems | Masonry Push Mounts | B2.20 |
| | ★ <i>SUPER-GRIP</i> ® Masonry Push Mounts | B2.20 |
| | ★ <i>HYPER-V</i> ™ Masonry Cable Tie Mounts | B2.21 |
| | Wood Push Mount | B2.21 |
| E2. Labels | ★ Push Mounts with Umbrella | B2.22 |
| | ★ Push Mount Assemblies | B2.22 |
| | Control Panel Mounts | B2.23 |
| | <i>PAN-POST</i> ™ Standoff | B2.23 |
| E3. Pre-Printed & Write-On Markers | Flat <i>PAN-POST</i> ™ Standoffs | B2.24 |
| | Right Angle Bases | B2.24 |
| | Flat Cable Mounting System – FCB Base and FCPI Plate | B2.25 |
| | Closed Connector Rings | B2.26 |
| | Open Connector Ring | B2.26 |
| E4. Permanent Identification | Cable Spacers | B2.26 |
| | Cable Spacer Cross | B2.27 |
| | Stackable Aerial Cable Spacer | B2.27 |
| | Aerial Support Ties – Weather Resistant Polypropylene | B2.28 |
| E5. Lockout/ Tagout & Safety Solutions | Permanent Marking Pens | B2.28 |
| | Marker Plates – Loose Piece | B2.29 |
| | Cable and Wire Mounting Devices (used without cable ties) | B2.30 |
| | Adhesive Backed Mounting Devices | B2.30 |
| | <i>CLINCHER</i> ™ Adjustable Releasable Clamp | B2.30 |
| F. Index | Adhesive Backed Cord Clips | B2.31 |

★ Represents new product offering.

Table of Contents

| | |
|---|---------------|
| Push Mount Cord Clip | B2.31 |
| “J” Clips | B2.32 |
| A1C Type Clips | B2.32 |
| A2C Type Clips | B2.33 |
| Metal Adhesive Backed Cord Clips | B2.33 |
| Latching Wire Clips | B2.34 |
| Bevel Entry Clips | B2.35 |
| Adhesive Backed Dual Cord Clip | B2.36 |
| Adhesive Backed Mount Cord Clip | B2.36 |
| Vertical Cord Clips | B2.36 |
| Adhesive Backed Latching Clips | B2.37 |
| Cable Holder – Adhesive Backed | B2.37 |
| Low Profile Flat Cable Mounts | B2.37 |
| Latching Flat Cable Mounts | B2.38 |
| Latching Flat Cable Holders | B2.38 |
| Flat Cable Clips | B2.39 |
| <i>PAN-CLAMP™</i> Heavy Duty Fixed Diameter Clamps | B2.39 |
| Fixed Diameter Cable Clamps | B2.40 |
| Wire Retainers | B2.41 |
| Tack Clips | B2.41 |
| Siding Clips | B2.42 |
| Wire Standoffs | B2.42 |
| Snap-In Clips | B2.43 |
| Wire Saddles | B2.43 |
| Optical Fiber Network Saddle | B2.44 |
| Harness Clips | B2.44 |
| ★ Nylon Edge Clips | B2.45 |
| Wire Bundle Strap | B2.45 |
| Circuit Board Posts | B2.46 |
| Circuit Board Locking Supports | B2.46 |
| Harness Board Accessories | B2.47 |
| Elastic Retainers | B2.47 |
| Elastic Retainers – ER Type | B2.47 |
| Bundle Retainers | B2.48 |
| Corner Posts | B2.48 |
| T-Junction Fixture | B2.48 |
| Wire End Holder | B2.49 |
| Harness Board Nails | B2.49 |
| Fanning Strip System | B2.50 |
| Spring Wire Breakout System | B2.50 |
| Harness Board Standoff Posts and Adaptor | B2.51 |
| Physical Properties and Colors of Cable Accessory Materials | B2.52 |
| Selection and Use of Adhesive Mounts | B2.52 – B2.54 |

Stainless Steel Cable Ties and Accessories

| | |
|--|---------------|
| PAN-STEEL® System | B3.1 |
| <i>PAN-STEEL®</i> Products Overview | B3.2 – B3.3 |
| Features and Benefits – <i>PAN-STEEL®</i> Cable Ties | B3.4 |
| Part Number System for <i>PAN-STEEL®</i> Cable Ties | B3.5 |
| <i>PAN-STEEL®</i> Self-Locking Cable Ties – MLT Series | B3.5 – B3.7 |
| <i>PAN-STEEL®</i> Polyester Fully Coated Cable Ties – MLTFC Series | B3.8 |
| <i>PAN-STEEL®</i> Nylon 11 Selectively Coated Ties – MLTC Series | B3.9 |
| ★ <i>PAN-ALUM™</i> Aluminum Cable Ties – MLT Series | B3.10 |
| <i>PAN-STEEL®</i> Double Wrapped Cable Ties – MLTD Series | B3.11 |
| <i>PAN-STEEL®</i> Custom Length Banding – MBS, MBH, MBEH and MBSH Series | B3.12 – B3.13 |
| <i>PAN-STEEL®</i> Custom Length Banding Heads – MTH Series | B3.13 |
| GS4MT Hand Operated Installation Tool | B3.14 |
| Tool Tension Locking Kits | B3.14 |
| ST2MT Installation Tool | B3.15 |
| ★ RT1HT and RT1HTN Installation Tools | B3.15 |
| HTMT Installation Tool | B3.15 |
| PPTMT Pneumatic Installation Tool | B3.16 |
| Adjustment Features for PPTMT and GS4MT Tools | B3.16 |
| Features and Benefits – <i>PAN-STEEL®</i> Retained Tension Ties – MRT/MRS Series | B3.17 |
| Part Number System for <i>PAN-STEEL®</i> Retained Tension Ties – MRT Series | B3.18 |
| ★ <i>PAN-STEEL®</i> Retained Tension Ties – MRT Series | B3.18 |
| Part Number System for <i>PAN-STEEL®</i> 360° Radial Seal Retained Tension Ties – MRS Series | B3.19 |

★ Represents new product offering.

| |
|--|
| A. System Overview |
| B1. Cable Ties |
| B2. Cable Accessories |
| B3. Stainless Steel Ties |
| C1. Wiring Duct |
| C2. Surface Raceway |
| C3. Abrasion Protection |
| C4. Cable Management |
| D1. Terminals |
| D2. Power Connectors |
| D3. Grounding Connectors |
| E1. Labeling Systems |
| E2. Labels |
| E3. Pre-Printed & Write-On Markers |
| E4. Permanent Identification |
| E5. Lockout/ Tagout & Safety Solutions |
| F. Index |

Table of Contents

A.
System
Overview

B1.
Cable Ties

B2.
Cable
Accessories

B3.
Stainless
Steel Ties

C1.
Wiring
Duct

C2.
Surface
Raceway

C3.
Abrasion
Protection

C4.
Cable
Management

D1.
Terminals

D2.
Power
Connectors

D3.
Grounding
Connectors

E1.
Labeling
Systems

E2.
Labels

E3.
Pre-Printed
& Write-On
Markers

E4.
Permanent
Identification

E5.
Lockout/
Tagout
& Safety
Solutions

F.
Index

| | |
|--|-------|
| ★ <i>PAN-STEEL</i> ® 360° Radial Seal Retained Tension Ties – MRS Series | B3.19 |
| ★ Retained Tension Installation Tools | B3.20 |
| MRT/MRS Installation Steps | B3.20 |
| Features and Benefits – <i>PAN-STEEL</i> ® Strapping System | B3.21 |
| The <i>PANDUIT</i> Method Reduces Installation Time | B3.22 |
| Part Number System for Discrete Length Strapping | B3.22 |
| Part Number System for Coil Strapping | B3.22 |
| Part Number System for Strapping Buckles | B3.22 |
| <i>PAN-STEEL</i> ® Strapping – MS Series | B3.23 |
| <i>PAN-STEEL</i> ® Nylon 11 Coated Strapping – MSC Series | B3.24 |
| <i>PAN-STEEL</i> ® Custom Length Strapping | B3.25 |
| <i>PAN-STEEL</i> ® Buckles for Custom Length Strapping | B3.25 |
| BT1HT Hand Operated Installation Tool for Strapping | B3.26 |
| PCS Cushion Sleeve | B3.26 |
| Stainless Steel Tie Mounts | B3.27 |
| Stainless Steel Push Mount | B3.27 |
| Stainless Steel Push Button Mount | B3.28 |
| Stainless Steel 2-Way Tie Mount | B3.28 |
| Stainless Steel Bulkhead Mount | B3.29 |
| Stainless Steel Technical Information | B3.30 |
| <i>PANDUIT</i> Stainless Steel Cable Tie and Strapping Approvals | B3.30 |
| Chemical Resistance at 70°F (21°C) Temperature | B3.31 |
| Rigorous Tests and Physical Properties of Stainless Steel | B3.32 |
| Military Cross Reference (AS23190) | B3.32 |

Wiring Duct

| | |
|--|---------------|
| Wiring Duct | C1.1 |
| Wiring Duct for Control Panel Applications | C1.2 – C1.3 |
| Features and Benefits – <i>PANDUCT</i> ® <i>PANELMAX</i> ™ Corner Wiring Duct | C1.4 |
| ★ <i>PANELMAX</i> ™ Corner Wiring Duct | C1.5 |
| Features and Benefits – <i>PANDUCT</i> ® Type H and HN Hinged Cover Wiring Duct | C1.6 |
| ★ <i>PANDUCT</i> ® Type HN Hinged Cover Narrow Slot Wiring Duct | C1.7 |
| <i>PANDUCT</i> ® Type H Hinged Cover Wide Slot Wiring Duct | C1.7 |
| <i>PANDUCT</i> ® Type HS Hinged Cover Solid Wall Raceway | C1.7 |
| Features and Benefits – <i>PANDUCT</i> ® Type G Wide Slot Wiring Duct | C1.8 |
| <i>PANDUCT</i> ® Type G Wide Slot Wiring Duct | C1.9 |
| Features and Benefits – <i>PANDUCT</i> ® Type F Narrow Slot Wiring Duct | C1.10 |
| <i>PANDUCT</i> ® Type F Narrow Slot Wiring Duct | C1.11 |
| Features and Benefits – <i>PANDUCT</i> ® Flush Cover Type D Round Hole Wiring Duct | C1.12 |
| <i>PANDUCT</i> ® Flush Cover Type D Round Hole Wiring Duct | C1.13 |
| Features and Benefits – <i>PANDUCT</i> ® Type MC Metric Narrow Slot Wiring Duct | C1.14 |
| <i>PANDUCT</i> ® Type MC Metric Narrow Slot Wiring Duct | C1.15 |
| Features and Benefits – <i>PANDUCT</i> ® Type FS Solid Wall Raceway | C1.16 |
| <i>PANDUCT</i> ® Type FS Solid Wall Raceway | C1.17 |
| Wiring Duct for Special Environments | C1.18 – C1.19 |
| Features and Benefits – <i>PANDUCT</i> ® Type NNC Halogen-Free Metric Wiring Duct | C1.20 |
| <i>PANDUCT</i> ® Type NNC Halogen-Free Metric Wiring Duct | C1.21 |
| <i>PANDUCT</i> ® Type NNC Divider Wall | C1.21 |
| Features and Benefits – <i>PANDUCT</i> ® Type TMC Low Smoke/Low Toxicity Wiring Duct | C1.22 |
| <i>PANDUCT</i> ® Type TMC Low Smoke/Low Toxicity Wiring Duct | C1.23 |
| <i>PANDUCT</i> ® Type TMC Low Smoke/Low Toxicity Solid Divider Wall | C1.23 |
| <i>PANDUCT</i> ® Type NE NORYL* Halogen-Free Wiring Duct | C1.24 |
| Wiring Duct Tools and Accessories | C1.25 |
| <i>PANDUCT</i> ® Type FL Flexible Wiring Duct | C1.26 |
| <i>PANDUCT</i> ® Divider Wall | C1.26 |
| <i>PANDUCT</i> ® Type NNC Divider Wall | C1.27 |
| <i>PANDUCT</i> ® Type TMC Low Smoke/Low Toxicity Solid Divider Wall | C1.27 |
| <i>PANDUCT</i> ® Type G and H Wiring Duct Wire Retainers | C1.28 |
| <i>PANDUCT</i> ® Solid Wall Raceway Type FS and Type D Wiring Duct Wire Retainer | C1.28 |
| <i>PANDUCT</i> ® Type F, HN, MC and TMC Duct Wire Retainers/Labeling Device | C1.29 |
| <i>PANDUCT</i> ® Duct Corner Strip with 1 Inch Bend Radius Control | C1.29 |
| <i>PANDUCT</i> ® Duct Corner Strips | C1.30 |
| <i>PANDUCT</i> ® Duct Joining Strips | C1.30 |
| <i>PANDUCT</i> ® Snap-Clip Mounting Brackets | C1.31 |
| <i>PANDUCT</i> ® Snap-Clip Mounting Bracket – Type NE Wiring Duct | C1.31 |
| Adhesive Tape for Wiring Duct | C1.32 |
| Specifications for Factory Applied Tape | C1.32 |

★ Represents new product offering.

*NORYL is a registered trademark of General Electric Company.

Table of Contents

| | |
|---|---------------|
| Adhesive Tape Guide | C1.33 |
| PANDUCT® Installation Tools | C1.34 |
| PANDUCT® PANELMAX™ Corner Wiring Duct Dimensions | C1.35 |
| PANDUCT® Type G and D Wiring Duct Dimensions | C1.36 |
| PANDUCT® Type F Wiring Duct and FS Raceway Dimensions | C1.37 |
| PANDUCT® Type MC and TMC Wiring Duct Dimensions | C1.38 |
| PANDUCT® Type NNC Wiring Duct Dimensions | C1.39 |
| PANDUCT® Type NE Wiring Duct Dimensions | C1.40 |
| PANDUCT® Type H and HS Wiring Duct Dimensions | C1.41 |
| PANDUCT® Type HN Wiring Duct Dimensions | C1.41 |
| PANDUCT® Type FL Wiring Duct Dimensions | C1.42 |
| PANDUCT® PANELMAX™ Corner Wiring Duct – Wirefill Capacity | C1.42 |
| PANDUCT® Type H, HN and HS Wiring Duct – Wirefill Capacity | C1.42 |
| PANDUCT® Type D, G, F and FS Wiring Duct – Wirefill Capacity | C1.43 |
| PANDUCT® Type MC, NNC and TMC Wiring Duct – Wirefill Capacity | C1.44 |
| PANDUCT® Type NE Wiring Duct – Wirefill Capacity | C1.45 |
| PANDUCT® Type FL Wiring Duct – Wirefill Capacity | C1.45 |
| Wirefill Formula | C1.46 |
| PANDUCT® Wiring Duct and Raceway – Material Specifications | C1.47 |
| PANDUCT® Wiring Duct and Raceway – Color and Size Selection | C1.48 |
| Installation Tips | C1.49 |
| Part Number System for Wiring Duct | C1.49 |
| PANDUCT® Wiring Duct Approvals and Compliances | C1.50 – C1.51 |
| FIBER-DUCT™ Routing System | C1.53 |
| 2x2 and 4x4 FIBER-DUCT™ Routing Systems Roadmap | C1.54 – C1.55 |
| 2x2 and 4x4 FIBER-DUCT™ Routing Systems | C1.56 |
| FIBER-DUCT™ System Fittings | C1.56 – C1.57 |
| FIBER-DUCT™ Spillouts | C1.58 |
| FIBER-DUCT™ Bend Radius Control Trumpets | C1.59 |
| FIBER-DUCT™ Accessories | C1.59 |
| FIBER-DUCT™ Mounting Brackets | C1.60 – C1.61 |
| Cable Fills 2x2 and 4x4 FIBER-DUCT™ Cable Routing Systems | C1.62 |

Surface Raceway

| | |
|---|---------------|
| PAN-WAY® Metal Raceway | C2.1 |
| PMR40 Raceway Roadmap | C2.2 – C2.3 |
| PMR40 Configurations | C2.4 |
| ★ PAN-WAY® PMR40 Metal Raceway System | C2.5 |
| ★ PAN-WAY® PMR40 Metal Raceway Fittings | C2.5 – C2.6 |
| Cable Fill Capacities for PMR40 Metal Raceway | C2.7 |
| PMR5/7 Raceway Roadmap | C2.8 – C2.9 |
| PMR5/PMR7 Configurations | C2.10 |
| ★ PAN-WAY® PMR5/PMR7 Metal Raceway System | C2.11 |
| ★ PAN-WAY® PMR5/PMR7 Metal Raceway Fittings | C2.12 |
| ★ PMR5 and PMR7 Raceway Accessories | C2.13 |
| Cable Fill Capacities for PMR5/PMR7 Metal Raceway | C2.14 |
| ★ PAN-WAY® Metal Raceway Boxes | C2.15 – C2.16 |
| ★ PAN-WAY® Metal Raceway Faceplates | C2.17 |
| PAN-WAY® Non-Metallic Surface Raceway | C2.18 |
| PAN-WAY® TG-70 Non-Metallic Surface Raceway | C2.19 |
| TG-70 Raceway Roadmap | C2.20 – C2.21 |
| TG-70 Configurations | C2.22 – C2.23 |
| PAN-WAY® TG-70 Surface Raceway System | C2.24 |
| PAN-WAY® TG-70 Raceway Fittings | C2.25 |
| PAN-WAY® TG-70 Raceway Accessories | C2.26 |
| Cable Fill Capacities for TG-70 Raceway | C2.27 |
| PAN-WAY® T-70 and Twin-70 Non-Metallic Surface Raceway | C2.29 |
| T-70 Raceway Roadmap | C2.30 – C2.31 |
| T-70 Configurations | C2.32 – C2.33 |
| Twin-70 Raceway Roadmap | C2.34 – C2.35 |
| PAN-WAY® T-70 Surface Raceway System | C2.36 |
| PAN-WAY® T-70 Raceway Fittings | C2.36 – C2.37 |
| PAN-WAY® Twin-70 Surface Raceway System | C2.38 |
| PAN-WAY® Twin-70 Raceway Fittings | C2.39 |
| PAN-WAY® T-70 and Twin-70 Raceway Accessories | C2.40 |
| Cable Fill Capacities for T-70 Raceway | C2.41 |
| Cable Fill Capacities for Twin-70 Raceway | C2.42 |

★ Represents new product offering.

| |
|--|
| A. System Overview |
| B1. Cable Ties |
| B2. Cable Accessories |
| B3. Stainless Steel Ties |
| C1. Wiring Duct |
| C2. Surface Raceway |
| C3. Abrasion Protection |
| C4. Cable Management |
| D1. Terminals |
| D2. Power Connectors |
| D3. Grounding Connectors |
| E1. Labeling Systems |
| E2. Labels |
| E3. Pre-Printed & Write-On Markers |
| E4. Permanent Identification |
| E5. Lockout/ Tagout & Safety Solutions |
| F. Index |

Table of Contents

A.
System
Overview

B1.
Cable Ties

B2.
Cable
Accessories

B3.
Stainless
Steel Ties

C1.
Wiring
Duct

C2.
Surface
Raceway

C3.
Abrasion
Protection

C4.
Cable
Management

D1.
Terminals

D2.
Power
Connectors

D3.
Grounding
Connectors

E1.
Labeling
Systems

E2.
Labels

E3.
Pre-Printed
& Write-On
Markers

E4.
Permanent
Identification

E5.
Lockout/
Tagout
& Safety
Solutions

F.
Index

| | |
|--|-----------------|
| PAN-WAY® T-45 Non-Metallic Surface Raceway | C2.43 |
| T-45 Raceway Roadmap | C2.44 – C2.45 |
| T-45 Configurations | C2.46 – C2.47 |
| PAN-WAY® T-45 Surface Raceway System | C2.48 |
| PAN-WAY® Type T-45 Raceway Fittings | C2.49 |
| Cable Fill Capacities for T-45 Raceway | C2.50 |
| PAN-WAY® Snap-On Faceplates and Surface Mount Outlet Boxes | C2.51 |
| PAN-WAY® FAST-SNAP™ Surface Mount Outlet Boxes | C2.52 |
| PAN-WAY® Classic Series Snap-On Faceplates for Use with PANDUIT® MINI-COM® Modules | C2.52 |
| Component Labels for PAN-WAY® Classic Series Snap-On Faceplates for Use with PANDUIT® MINI-COM® Modules and Inserts | C2.52 |
| PAN-WAY® Classic Series Snap-On Faceplates for Use with PANDUIT® MINI-COM® Inserts | C2.53 |
| PAN-WAY® Classic Series Snap-On Faceplates for Communication/Power | C2.53 |
| PANDUIT® NETKEY® Snap-On Sloped Keystone Faceplates | C2.54 |
| PANDUIT® NETKEY® Snap-On Flush Universal Keystone Faceplates | C2.54 |
| PAN-WAY® Snap-On Faceplates for SYSTIMAX® Communication Modules | C2.55 |
| PAN-WAY® Snap-On Faceplates for Nordx/CDT® Communication Modules | C2.56 |
| PAN-WAY® Low Voltage Surface Mount Outlet Boxes | C2.57 |
| PAN-WAY® Power Rated Surface Mount Outlet Boxes | C2.58 |
| PAN-WAY® Classic Series Faceplates for Power and Communication Applications | C2.59 |
| PAN-WAY® Stainless Steel Faceplates | C2.60 |
| PAN-WAY® Electrical Outlets | C2.60 |
| PAN-WAY® Surface Mount Outlet Box with 20 A Electrical Outlet | C2.60 |
| Selection Chart for using PAN-WAY® Surface Raceway with PAN-WAY® Surface Mount Outlet Boxes | C2.61 |
| PAN-WAY® LD Profile Non-Metallic Surface Raceway | C2.63 |
| LD2P10 Profile Raceway Roadmap | C2.64 – C2.65 |
| LD2P10 Configurations | C2.66 – C2.67 |
| LD Profile Raceway Roadmap | C2.68 – C2.69 |
| LD Configurations | C2.70 – C2.71 |
| LDPH Profile Raceway Roadmap | C2.72 – C2.73 |
| LDPH Configurations | C2.74 |
| PAN-WAY® Type LD2P10 Multi-Channel Surface Raceway System | C2.75 |
| Multi-Channel Fittings for LD2P10 | C2.75 |
| PAN-WAY® LD Surface Raceway System | C2.76 |
| PAN-WAY® LDPH Surface Raceway System | C2.77 |
| PAN-WAY® LDS Surface Raceway System | C2.78 |
| Method for Bending Type LDS Raceway (Low Voltage Applications) | C2.78 |
| Standard Fittings for Low Voltage Applications | C2.79 |
| One Inch Bend Radius Fittings for TIA/EIA Compliance | C2.80 |
| Power Rated Fittings for Power to 600 V – LDPH/LDS/LD2P Raceway Only | C2.81 |
| Raceway Adapters for LD Raceway | C2.82 |
| Cable Fill Capacities for LD Profile Raceway | C2.82 |
| Floor Guard | C2.83 |
| PAN-WAY® Surface Raceway Cutting Tool | C2.83 |
| Foam Tape | C2.84 |
| PAN-WAY® Cove Raceway | C2.85 |
| Cove Raceway Roadmap | C2.86 – C2.87 |
| Cove Configurations | C2.88 – C2.89 |
| PAN-WAY® Cove Raceway System | C2.90 |
| PAN-WAY® Cove Raceway Fittings | C2.91 |
| Cable Fill Capacities for Cove Raceway | C2.92 |
| PAN-WAY® Office Furniture Raceway | C2.93 |
| Office Furniture Raceway Roadmap | C2.94 – C2.95 |
| Office Furniture Configurations | C2.96 – C2.97 |
| PAN-WAY® Office Furniture Raceway System | C2.98 |
| PAN-WAY® Office Furniture Raceway Fittings | C2.98 – C2.101 |
| Cable Fill Capacities for Office Furniture Raceway | C2.102 |
| PAN-POLE™ Power and Communication Poles | C2.103 |
| PAN-POLE™ Power Pole | C2.104 |
| Installation of Communication Outlets on PAN-POLE™ Power Pole | C2.105 – C2.106 |
| PAN-POLE™ Communication Pole | C2.107 |
| Installation of Communication Outlets on PAN-POLE™ Communication Pole | C2.108 – C2.109 |
| PAN-POLE™ Extension Kits | C2.110 |
| PAN-POLE™ Power Addition Kits and Standard Faceplate Bracket | C2.110 |
| PAN-POLE™ Replacement Parts | C2.111 |
| Cable Fill Capacities for PAN-POLE™ Power and Communication Poles | C2.112 |

*SYSTIMAX is a registered trademark of Commscope, Inc.

**Nordx/CDT is a registered trademark of Nordx/CDT, Inc.

Table of Contents

Abrasion Protection

| | |
|---|---------------|
| Abrasion Protection | C3.1 |
| <i>PAN-WRAP</i> ™ Split Harness Wrap | C3.2 |
| <i>PAN-WRAP</i> ™ Installation Tools | C3.2 |
| Part Number System for Spiral Wrap | C3.3 |
| Spiral Wrap | C3.4 – C3.7 |
| Part Number System for Grommet Edging | C3.8 |
| Grommet Edging | C3.8 – C3.10 |
| Part Number System for Corrugated Loom Tubing | C3.11 |
| Corrugated Loom Tubing – Slit | C3.11 – C3.12 |
| Corrugated Loom Tubing Fittings | C3.12 |
| Part Number System for Braided Expandable Sleeving | C3.13 |
| Braided Expandable Sleeving – Polyethylene Terephthalate (PET) | C3.13 |
| Braided Expandable Sleeving – Flame Retardant Polyethylene Terephthalate | C3.14 |
| Tooling Head | C3.14 |
| Fray Resistant Braided Expandable Sleeving | C3.15 |
| Part Number System for Non-Shrink PVC Tubing | C3.16 |
| Non-Shrink PVC Tubing | C3.16 |
| Duct Seal – Sealing Compounds | C3.16 |
| Flammability Tests and Classification | C3.17 |
| Abrasion Protection Materials Technical Data | C3.18 – C3.19 |
| <i>PANDUIT</i> Heat Shrink Tubing Selection Guide | C3.20 |
| Part Number System for Thin Wall Heat Shrink | C3.21 |
| HSTT Heat Shrink 4 Foot Pieces | C3.22 – C3.23 |
| HSTT Heat Shrink on 25 Foot Reels | C3.23 |
| Heat Shrink in 6 Inch Pieces; Single Color, Single Diameter | C3.24 |
| Heat Shrink in 6 Inch Pieces; Multi-Color, Single Diameter | C3.24 |
| Heat Shrink in 6 Inch Pieces; Black, Multiple Diameters | C3.25 |
| Heat Shrink in 6 Inch Pieces; Yellow/Green Stripe, Multiple Diameters | C3.25 |
| HSTTV Heat Shrink 4 Foot Pieces | C3.26 |
| HSTTV Heat Shrink on 100 Foot Reels | C3.27 |
| HSTTV Heat Shrink on Bulk Reels | C3.28 |
| HSTTV Heat Shrink on 25 Foot Reels | C3.29 |
| HSTTV Heat Shrink 6 Inch Pieces | C3.29 |
| HSTTP PVC Heat Shrink | C3.30 |
| HSTTPN Crystal Clear PVC Heat Shrink | C3.31 |
| HSTTN Neoprene Heat Shrink | C3.31 |
| TEFLON [®] Heat Shrink | C3.32 |
| HSTTK KYNAR [®] Heat Shrink 4 Foot Pieces | C3.33 |
| HSTTVA Heat Shrink 4 Foot Pieces | C3.33 – C3.34 |
| HSTTA Heat Shrink 4 Foot and 6 Inch Pieces | C3.34 |
| HSTTRA Heat Shrink 4 Foot pieces | C3.35 |
| Thick Wall Polyolefin Heat Shrink | C3.35 – C3.36 |
| Heat Shrink End Caps | C3.37 |
| Plastic Heat Shrink Tubing Kit Boxes – For Dry Locations | C3.38 |
| Heat Shrink Tools and Accessories | C3.38 |
| Heat Shrink Installation Instructions | C3.39 |
| Recommended Tubing Size for Common Wire Types Based on Location | C3.40 |
| IP (Ingress Protection) as defined by the International Standard IEC 529 | C3.41 |
| <i>DRY-SHRINK</i> ™, <i>DAMP-SHRINK</i> ™, and <i>WET-SHRINK</i> ™ Heat Shrink Tubing | C3.42 |

Cable Management

| | |
|---|-------------|
| Cable Management | C4.1 |
| ★ <i>COOL BOOT</i> ™ Raised Floor Assembly | C4.2 – C4.3 |
| <i>J-PRO</i> ™ Cable Support System | C4.4 – C4.6 |
| <i>J-MOD</i> ® Cable Support System | C4.7 |
| Conduit Waterfall | C4.8 |
| Waterfall Accessories | C4.8 |
| ★ Double Waterfall Accessory | C4.9 |
| Stackable Cable Rack Spacers | C4.9 |
| Threaded Rod Cover | C4.10 |
| Vertical D-Rings | C4.10 |
| <i>TAK-TY</i> ® Hook & Loop Cable Tie Mounts | C4.11 |
| Flat <i>PAN-POST</i> ™ Standoffs | C4.11 |
| Communication Cable Management Kit for Cabinets | C4.12 |

★TEFLON is a registered trademark of E.I. du Pont de Nemours and Company.

★KYNAR is a registered trademark of Atofina Chemicals, Inc.

★ Represents new product offering.

Table of Contents

Terminals

| | | |
|--|--|--|
| A. System Overview | | |
| B1. Cable Ties | | |
| B2. Cable Accessories | | |
| B3. Stainless Steel Ties | | |
| C1. Wiring Duct | | |
| C2. Surface Raceway | | |
| C3. Abrasion Protection | | |
| C4. Cable Management | | |
| D1. Terminals | | |
| D2. Power Connectors | | |
| D3. Grounding Connectors | | |
| E1. Labeling Systems | | |
| E2. Labels | | |
| E3. Pre-Printed & Write-On Markers | | |
| E4. Permanent Identification | | |
| E5. Lockout/ Tagout & Safety Solutions | | |
| F. Index | | |

| | |
|---|---------------|
| PAN-TERM® Terminals | D1.1 |
| Features and Benefits – <i>PAN-TERM®</i> Terminals | D1.2 |
| Selection Guide – <i>PAN-TERM®</i> Ring Terminals | D1.3 |
| Selection Guide – <i>PAN-TERM®</i> Fork Terminals | D1.4 |
| Part Number System for <i>PAN-TERM®</i> Terminals | D1.5 |
| Ring Terminal, Nylon Insulated | D1.6 |
| Ring Terminal, Nylon Insulated – Expanded Insulation | D1.7 |
| Ring Terminal, Nylon Insulated – Funnel Entry | D1.8 |
| Multiple Stud Terminal, Nylon Insulated | D1.9 |
| Ring Terminal, Vinyl Insulated – Funnel Entry | D1.10 |
| Ring Terminal, Vinyl Expanded Insulation | D1.11 |
| Multiple Stud Terminal, Vinyl Insulated – Funnel Entry | D1.12 |
| Ring Terminal, KYNAR® Insulated | D1.12 |
| Heat Shrink, Ring Terminal | D1.13 |
| Ring Terminal, Heavy Duty, Nylon Insulated | D1.13 |
| Ring Terminal, Heavy Duty, Vinyl Insulated – Funnel Entry | D1.14 |
| Ring Terminal, Large Wire, Vinyl Insulated | D1.15 |
| Ring Terminal, Large Wire, Vinyl Expanded Insulation | D1.16 |
| Ring Terminal, Non-Insulated | D1.17 |
| Multiple Stud Terminal, Non-Insulated | D1.18 |
| Ring Terminal, Non-Insulated – High Temperature | D1.18 |
| Ring Terminal, Heavy Duty Non-Insulated | D1.19 |
| Ring Terminal, Large Wire Non-Insulated | D1.19 |
| Tubular Ring Terminal, Non-Insulated | D1.20 |
| Fork Terminal, Nylon Insulated | D1.21 |
| Fork Terminal, Nylon Insulated – Funnel Entry | D1.22 |
| Fork Terminal, Vinyl Insulated – Funnel Entry | D1.23 |
| Fork Terminal, Vinyl Insulated – Expanded Insulation | D1.24 |
| Locking Fork Terminal, Nylon Insulated | D1.24 |
| Locking Fork Terminal, Nylon Insulated – Funnel Entry | D1.25 |
| Locking Fork Terminal, Vinyl Insulated – Funnel Entry | D1.25 |
| Locking Fork Terminal, Vinyl Insulated – Expanded Insulation | D1.26 |
| Short Locking Fork Terminal, Nylon Insulated | D1.26 |
| Short Locking Fork Terminal, Nylon Insulated – Funnel Entry | D1.27 |
| Short Locking Fork Terminal, Vinyl Insulated – Funnel Entry | D1.27 |
| Flanged Fork Terminal, Nylon Insulated | D1.28 |
| Flanged Fork Terminal, Vinyl Insulated – Funnel Entry | D1.28 |
| Fork Terminal, Non-Insulated | D1.29 |
| Flanged Fork Terminal, Non-Insulated | D1.30 |
| Locking Fork Terminal, Non-Insulated | D1.30 |
| Short Locking Fork Terminal, Non-Insulated | D1.31 |
| Heat Shrink, Fork Terminal | D1.31 |
| Features and Benefits – <i>PAN-TERM®</i> Metric Terminals | D1.32 |
| Part Number System for <i>PAN-TERM®</i> Metric Terminals | D1.33 |
| Metric Ring Terminal, Nylon Insulated – Funnel Entry | D1.33 |
| Metric Ring Terminal, Vinyl Insulated – Funnel Entry | D1.34 |
| Metric Ring Terminal, Non-Insulated | D1.34 |
| Metric Fork Terminal, Nylon Insulated – Funnel Entry | D1.35 |
| Metric Fork Terminal, Vinyl Insulated – Funnel Entry | D1.35 |
| Metric Fork Terminal, Non-Insulated | D1.36 |
| Plastic Box Terminal Kits | D1.36 |
| Steel Kit Boxes | D1.37 |
| Steel Slide Racks | D1.37 |
| Industrial Maintenance Kits | D1.38 |
| PAN-TERM® Disconnects | D1.39 |
| Features and Benefits – <i>PAN-TERM®</i> Disconnects | D1.40 – D1.41 |
| Selection Guide – <i>PAN-TERM®</i> Disconnects | D1.42 |
| Part Number System for <i>PAN-TERM®</i> Disconnects | D1.43 |
| <i>SUPRA-GRIP™</i> Female Disconnect, Nylon Fully Insulated – Funnel Entry | D1.43 |
| <i>DISCO-LOK™</i> Female Disconnect, Nylon Fully Insulated – Funnel Entry | D1.44 |
| Male/Female Coupler, Nylon Fully Insulated – Funnel Entry | D1.44 |
| Female Disconnect Nylon Fully Insulated – Funnel Entry | D1.45 |
| Female Disconnect, Nylon Fully Insulated – Funnel Entry, Metal Collar | D1.45 |
| <i>DISCOGRIP™</i> Male Disconnect, Premium Nylon Fully Insulated – Funnel Entry | D1.46 |
| <i>DISCOGRIP™</i> Female Disconnect, Premium Nylon Fully Insulated – Funnel Entry | D1.46 |
| Heat Shrink Disconnects, Fully Insulated – Funnel Entry | D1.47 |
| Female Disconnect, Nylon Barrel Insulated – Funnel Entry | D1.47 |

*KYNAR is a registered trademark of Atofina Chemicals, Inc.

Table of Contents

| | |
|--|---------------|
| Female Disconnect, Vinyl Barrel Insulated – Funnel Entry | D1.48 |
| Female Disconnect, Vinyl Barrel Insulated – Butted Seam | D1.48 |
| Female Disconnect, Non-Insulated – Metal Sleeve | D1.49 |
| Right Angle Female Disconnect, Nylon Fully Insulated – Funnel Entry | D1.49 |
| Right Angle Female Disconnect, Nylon Insulated – Funnel Entry | D1.50 |
| Right Angle Female Disconnect, Non-Insulated – Metal Sleeve | D1.50 |
| Right Angle Female Disconnect Non-Insulated | D1.51 |
| Piggyback Disconnect, Vinyl Insulated | D1.51 |
| Disconnect Adapter, Non-Insulated | D1.51 |
| Male Disconnect, Nylon Barrel Insulated – Funnel Entry | D1.52 |
| Male Disconnect, Vinyl Barrel Insulated – Funnel Entry | D1.52 |
| Male Disconnect, Non-Insulated – Butted Seam | D1.53 |
| Selection Guide – Specialty Terminals | D1.54 |
| Pin Terminal, Vinyl Insulated – Funnel Entry | D1.54 |
| Pin Terminal, Non-Insulated | D1.54 |
| Male Blade Adapter, Vinyl Insulated – Funnel Entry | D1.55 |
| Male Blade Adapter, Non-Insulated | D1.55 |
| Features and Benefits – <i>PAN-TERM</i> ® Metric Disconnects | D1.56 |
| Part Number System for <i>PAN-TERM</i> ® Metric Disconnects | D1.57 |
| Female Metric Disconnect, Fully Insulated Nylon – Funnel Entry | D1.57 |
| Female Metric Disconnect, Nylon Barrel Insulated – Funnel Entry | D1.58 |
| Female Metric Disconnect, Vinyl Barrel Insulated – Funnel Entry | D1.58 |
| Female Metric Disconnect, Non-Insulated – Metal Sleeve | D1.58 |
| Piggyback Metric Disconnect, Vinyl Barrel Insulated | D1.59 |
| Male Metric Disconnect, Fully Insulated Nylon – Funnel Entry | D1.59 |
| Male Metric Disconnect, Nylon Barrel Insulated – Funnel Entry | D1.59 |
| Male Metric Disconnect, Non-Insulated – Butted Seam | D1.60 |
| Metric Pin Terminal, Vinyl Insulated – Funnel Entry | D1.60 |
| Metric Pin Terminal, Non-Insulated | D1.60 |
| <i>PAN-TERM</i>® Splices | D1.61 |
| Features and Benefits – <i>PAN-TERM</i> ® Splices and Wire Joints | D1.62 – D1.63 |
| Selection Guide – <i>PAN-TERM</i> ® Splices and Wire Joints | D1.64 |
| Part Number System for <i>PAN-TERM</i> ® Splices | D1.64 |
| Part Number System for <i>PAN-TERM</i> ® Wire Joints | D1.64 |
| Butt Splice, Nylon Insulated | D1.65 |
| Butt Splice, Vinyl Insulated | D1.65 |
| Butt Splice, Non-Insulated | D1.66 |
| Parallel Splice, Nylon Insulated | D1.66 |
| Parallel Splice, Non-Insulated | D1.67 |
| Wire Joint, Nylon Insulated | D1.67 |
| Wire Joint, Non-Insulated | D1.68 |
| Heat Shrink, Butt Splices | D1.68 |
| Metric Butt Splice, Vinyl Insulated | D1.68 |
| Metric Butt Splice, Non-Insulated | D1.69 |
| Metric Wire Joints, Nylon Insulated | D1.69 |
| <i>PAN-TERM</i>® Ferrules | D1.70 |
| Features and Benefits – <i>PAN-TERM</i> ® Ferrules | D1.71 |
| Selection Guide – <i>PAN-TERM</i> ® Ferrules | D1.72 |
| Part Number System for <i>PAN-TERM</i> ® Ferrules | D1.72 |
| Insulated Ferrules – Single Wire DIN End Sleeve | D1.73 |
| Insulated Ferrules – Single Wire French End Sleeve | D1.74 |
| Insulated Ferrules – Twin Wire DIN End Sleeve | D1.75 |
| ★ Insulated Ferrules on Strips – Single Wire | D1.75 |
| Ferrules, Non-Insulated | D1.76 – D1.77 |
| Ferrule Assortment Kits | D1.78 |
| Terminal Crimping Tools | D1.79 |
| Crimping Guidelines for <i>PANDUIT</i> ® <i>PAN-TERM</i> ® Terminals, Disconnects, Splices and Wire Joints | D1.80 – D1.82 |
| Hand Operated Plier Type Tools | D1.83 |
| Wire and Cable Stripping Tools | D1.83 |
| <i>CONTOUR CRIMP</i> ™ Controlled Cycle Tools | D1.84 |
| Controlled Cycle Crimping Tools | D1.85 |
| Controlled Cycle Crimping Tools – Ferrule End Sleeve | D1.85 |
| ★ Semiautomatic Ferrule Crimping Tool CT-1000 | D1.86 |
| Controlled Cycle Crimping Tools – In-Line | D1.86 |
| Pneumatic Crimping Tool | D1.86 |
| Die Type, Manual, Crimping Tool | D1.87 |
| CD-720 Crimping Dies | D1.87 |
| ★ CT-2500 Battery Powered Crimping Tool | D1.88 |
| Tooling Selection Guide for <i>PANDUIT</i> Terminals, Splices, and Disconnects | D1.89 – D1.91 |
| Tooling Selection Guide for <i>PANDUIT</i> Tubular Ring Terminals | D1.92 |

★ Represents new product offering.

| | |
|-----|-----------------------------------|
| A. | System Overview |
| B1. | Cable Ties |
| B2. | Cable Accessories |
| B3. | Stainless Steel Ties |
| C1. | Wiring Duct |
| C2. | Surface Raceway |
| C3. | Abrasion Protection |
| C4. | Cable Management |
| D1. | Terminals |
| D2. | Power Connectors |
| D3. | Grounding Connectors |
| E1. | Labeling Systems |
| E2. | Labels |
| E3. | Pre-Printed & Write-On Markers |
| E4. | Permanent Identification |
| E5. | Lockout/Tagout & Safety Solutions |
| F. | Index |

Table of Contents

| | | |
|--|---|---------------|
| A. System Overview | | |
| B1. Cable Ties | Tooling Selection Guide for <i>PANDUIT</i> Ferrules | D1.93 |
| | Technical Specification and Selection Information | D1.94 |
| | <i>PANDUIT</i> Terminal Approvals | D1.94 |
| | Performance Requirements | D1.95 |
| B2. Cable Accessories | <i>PANDUIT</i> ® <i>PAN-TERM</i> ® Terminal Military Cross Reference | D1.95 |
| | Stud Size Chart (Inches/mm) | D1.96 |
| | Equivalent Tables | D1.97 |
| | Common Conductor Size Chart (Stranded Wire) | D1.97 |
| | Common Conductor Sizes and Strandings Reference Chart | D1.98 – D1.99 |
| B3. Stainless Steel Ties | REEL SMART™ System | D1.101 |
| | Features and Benefits – <i>REEL SMART</i> ™ Termination System | D1.102 |
| | <i>REEL SMART</i> ™ CA9 <i>EZAIR</i> ™ Universal Applicator | D1.102 |
| | Nylon Insulated Terminals with Insulation Grip Sleeve (Funnel and Non-Funnel Entry Types) | D1.102 |
| C1. Wiring Duct | Part Number System for <i>REEL SMART</i> ™ Terminals | D1.103 |
| | Ring Terminals, Nylon Insulated – Non-Funnel Entry | D1.103 |
| | Ring Terminals, Nylon Insulated – Funnel Entry | D1.104 |
| | Ring Terminals, Vinyl Insulated – Funnel Entry | D1.105 |
| | Multiple Stud Ring Terminals, Vinyl Insulated – Funnel Entry | D1.105 |
| C2. Surface Raceway | Ring Terminals, Nylon Insulated – Heavy Duty | D1.106 |
| | Ring Terminals, Vinyl Insulated – Heavy Duty | D1.106 |
| | Fork Terminals, Nylon Insulated – Non-Funnel Entry | D1.107 |
| | Fork Terminals, Nylon Insulated – Funnel Entry | D1.108 |
| | Fork Terminals, Vinyl Insulated – Funnel Entry | D1.109 |
| C3. Abrasion Protection | Locking Fork Terminals, Nylon Insulated – Non-Funnel Entry | D1.110 |
| | Locking Fork Terminals, Nylon Insulated – Funnel Entry | D1.110 |
| | Locking Fork Terminals, Vinyl Insulated – Funnel Entry | D1.111 |
| | Short Locking Fork Terminals, Nylon Insulated – Non-Funnel Entry | D1.112 |
| C4. Cable Management | Short Locking Fork Terminals, Nylon Insulated – Funnel Entry | D1.112 |
| | Short Locking Fork Terminals, Vinyl Insulated – Funnel Entry | D1.113 |
| | Flanged Fork Terminals, Nylon Insulated – Non-Funnel Entry | D1.113 |
| | Flanged Fork Terminals, Nylon Insulated – Funnel Entry | D1.114 |
| | Flanged Fork Terminals, Vinyl Insulated – Funnel Entry | D1.114 |
| D1. Terminals | Features and Benefits – <i>REEL SMART</i> ™ Metric Terminals | D1.115 |
| | Part Number System for <i>REEL SMART</i> ™ Metric Terminals | D1.115 |
| | ★ Metric Ring Terminals, Nylon Insulated – Non-Funnel Entry | D1.116 |
| | ★ Metric Ring Terminals, Nylon Insulated – Funnel Entry | D1.117 |
| | ★ Metric Ring Terminals, Vinyl Insulated – Funnel Entry | D1.118 |
| D2. Power Connectors | ★ Metric Fork Terminals, Nylon Insulated – Non-Funnel Entry | D1.119 |
| | ★ Metric Fork Terminals, Nylon Insulated – Funnel Entry | D1.119 |
| | ★ Metric Fork Terminals, Vinyl Insulated – Funnel Entry | D1.120 |
| | Features and Benefits – <i>REEL SMART</i> ™ Disconnects | D1.121 |
| D3. Grounding Connectors | Part Number System for <i>REEL SMART</i> ™ Disconnects | D1.122 |
| | <i>SUPRA-GRIP</i> ™ Female Disconnects, Nylon Fully Insulated – Funnel Entry | D1.122 |
| | <i>DISCO-LOK</i> ™ Female Disconnects, Nylon Fully Insulated – Funnel Entry | D1.123 |
| | Female Disconnects, Nylon Fully Insulated – Funnel Entry | D1.123 |
| | <i>DISCO</i> ™ Female Disconnects, Nylon Fully Insulated – Expanded Wire Entry | D1.124 |
| | <i>DISCO</i> ™ Female Disconnects, Nylon Fully Insulated – Right Angle | D1.124 |
| | <i>DISCO</i> ™ Female Disconnects, Vinyl Barrel Insulated – Funnel Entry | D1.125 |
| | <i>DISCOGRIP</i> ™ Female Disconnects, Fully Insulated | D1.126 |
| | <i>DISCOGRIP</i> ™ Male Disconnects, Fully Insulated | D1.127 |
| | <i>DISCO</i> ™ Male Disconnects, Nylon Fully Insulated – Funnel Entry | D1.128 |
| | <i>DISCO</i> ™ Male Disconnects, Nylon Fully Insulated – Expanded Wire Entry | D1.128 |
| E1. Labeling Systems | <i>DISCO</i> ™ Male Disconnects, Nylon Barrel Insulated – Funnel Entry | D1.129 |
| | <i>DISCO</i> ™ Male Disconnects, Vinyl Barrel Insulated – Funnel Entry | D1.129 |
| | Pin Terminals, Vinyl Insulated – Funnel Entry | D1.130 |
| | Male Blade Adapters, Vinyl Insulated – Funnel Entry | D1.130 |
| | Butt Splices Nylon Insulated and Premium Grade Nylon | D1.130 |
| | Features and Benefits – <i>REEL SMART</i> ™ Metric Disconnects | D1.131 |
| | Part Number System for <i>REEL SMART</i> ™ Metric Disconnects | D1.132 |
| | ★ Metric <i>SUPRA-GRIP</i> ™ Female Disconnects, Nylon Fully Insulated – Funnel Entry | D1.132 |
| | ★ Metric <i>DISCO-LOK</i> ™ Female Disconnects, Nylon Fully Insulated – Funnel Entry | D1.133 |
| E2. Labels | ★ Metric Female Disconnects, Nylon Fully Insulated – Funnel Entry | D1.133 |
| | ★ Metric <i>DISCO</i> ™ Female Disconnects, Nylon Fully Insulated – Expanded Wire Entry | D1.134 |
| | ★ Metric <i>DISCO</i> ™ Female Disconnects, Nylon Fully Insulated – Right Angle | D1.134 |
| | ★ Metric <i>DISCO</i> ™ Female Disconnects, Vinyl Barrel Insulated – Funnel Entry | D1.135 |
| | ★ Metric <i>DISCOGRIP</i> ™ Female Disconnects, Fully Insulated – Funnel Entry | D1.135 |
| | ★ Metric <i>DISCOGRIP</i> ™ Male Disconnects, Fully Insulated – Funnel Entry | D1.136 |
| | ★ Metric <i>DISCO</i> ™ Male Disconnects, Nylon Fully Insulated – Funnel Entry | D1.136 |
| | ★ Metric <i>DISCO</i> ™ Male Disconnects, Nylon Fully Insulated – Expanded Wire Entry | D1.137 |
| | ★ Metric <i>DISCO</i> ™ Male Disconnects, Nylon Barrel Insulated – Funnel Entry | D1.137 |
| E3. Pre-Printed & Write-On Markers | | |
| E4. Permanent Identification | | |
| E5. Lockout/ Tagout & Safety Solutions | | |
| F. Index | | |

★ Represents new product offering.

Table of Contents

- ★ Metric *DISCO*™ Male Disconnects, Vinyl Barrel Insulated – Funnel EntryD1.138
- ★ Metric Pin Terminals, Vinyl Insulated – Funnel EntryD1.138
- ★ Metric Male Blade Adapters, Vinyl Insulated – Funnel EntryD1.139
- ★ Metric Butt Splices, Nylon InsulatedD1.139
 - Features and Benefits – *REEL SMART*™ FerrulesD1.140
 - Part Number System for *REEL SMART*™ FerrulesD1.140
- ★ Insulated Ferrules on Strips – Single WireD1.141
- ★ Semiautomatic Ferrule Crimping Tool – CT-1000D1.142
- ★ Insulated Ferrules on Reels – Single WireD1.142
- ★ *REEL SMART*™ Ferrule Applicator – CA10D1.143
 - CA9 *EZAIR*™ and CA-800EZ ApplicatorsD1.143
- ★ Electric Bench PressD1.144
 - Die Sharpening KitsD1.144
 - Die InformationD1.145 – D1.146
 - CA10, CA9 *EZAIR*™, CA-800EZ and CA-800 Applicators Wire Processing Machine
 - Manufacturer/Press CompatibilityD1.147
 - Performance RequirementsD1.148

Power Connectors

- Compression Connector Reference InformationD2.0
- PAN-LUG*™ Compression Connectors**D2.1
 - Features and Benefits – *PAN-LUG*™ Compression ConnectorsD2.2
 - Selection Guide – *PAN-LUG*™ Copper Compression Connectors for Copper Code ConductorD2.3
 - Selection Guide – *PAN-LUG*™ Copper Compression Connectors for Copper Code and/or Flex ConductorD2.4
 - Selection Guide – *PAN-LUG*™ Aluminum Compression Connectors for Aluminum or Copper Code ConductorD2.5
 - Part Number System for LugsD2.6
 - Code Conductor, One-Hole, Short Barrel with Window LugD2.7 – D2.8
 - Code Conductor, One-Hole, Short Barrel with Window Lug, 45° AngleD2.9 – D2.10
 - Code Conductor, One-Hole, Short Barrel with Window Lug, 90° AngleD2.11 – D2.12
 - Code Conductor, One-Hole, Standard Barrel with Window LugD2.13 – D2.14
 - Code Conductor, One-Hole, Standard Barrel with Window Lug, 45° AngleD2.15 – D2.16
 - Code Conductor, One-Hole, Standard Barrel with Window Lug, 90° AngleD2.17 – D2.18
 - Code Conductor, One-Hole, Standard Barrel with Window, Narrow Tongue LugD2.19 – D2.20
 - Code Conductor, Short Blank Tongue, Standard Barrel with Window LugD2.21
 - Code Conductor, One-Hole, Long Barrel LugD2.22 – D2.23
 - Code Conductor, One-Hole, Long Barrel Lug, 45° AngleD2.24 – D2.25
 - Code Conductor, One-Hole, Long Barrel Lug, 90° AngleD2.26 – D2.27
 - Code Conductor, One-Hole, Long Barrel with Window LugD2.28
 - Code Conductor, One-Hole, Long Barrel with Window Lug, 45° AngleD2.29
 - Code Conductor, One-Hole, Long Barrel with Window Lug, 90° AngleD2.29
 - Code Conductor, One-Hole, Long Barrel with Corona Relief Taper LugD2.30
 - Code Conductor, Two-Hole, Standard Barrel with Window LugD2.31 – D2.32
 - Code Conductor, Two-Hole, Standard Barrel with Window Lug, 45° AngleD2.33 – D2.34
 - Code Conductor, Two-Hole, Standard Barrel with Window Lug, 90° AngleD2.35 – D2.36
 - Code Conductor, Two-Hole, Standard Barrel with Window, Narrow Tongue LugD2.37
 - Code Conductor, Two-Hole, Standard Barrel with Window, Narrow Tongue Lug, 45°D2.38
 - Code Conductor, Two-Hole, Standard Barrel with Window, Narrow Tongue Lug, 90°D2.39
 - Code Conductor, Long Blank Tongue, Standard Barrel with Window LugD2.40
 - Code Conductor, Two-Hole, Long Barrel LugD2.41 – D2.42
 - Code Conductor, Two-Hole, Long Barrel Lug, 45° AngleD2.43 – D2.44
 - Code Conductor, Two-Hole, Long Barrel Lug, 90° AngleD2.45 – D2.46
 - Code Conductor, Two-Hole, Long Barrel with Window LugD2.47 – D2.49
 - Code Conductor, Two-Hole, Long Barrel with Window Lug, 45° AngleD2.50 – D2.52
 - Code Conductor, Two-Hole, Long Barrel with Window Lug, 90° AngleD2.53 – D2.55
 - Code Conductor, Two-Hole, Long Barrel with Window, Narrow Tongue LugD2.55
 - Code Conductor, Two-Hole, Long Barrel with Corona Relief Taper LugD2.56
 - Code Conductor, Blank Tongue, Long Barrel LugD2.57
 - Code Conductor, Blank Tongue, Long Barrel with Window LugD2.58
 - Code Conductor, Short Barrel, Butt SpliceD2.59
 - Code Conductor, Standard Barrel, Butt SpliceD2.60
 - Code Conductor, Long Barrel, Butt SpliceD2.61
 - Code Conductor, Long Barrel with Corona Relief Taper SpliceD2.62
 - Code Conductor, Long Barrel, T SpliceD2.63
 - ★ Code Conductor, Color-Coded Parallel SpliceD2.64
 - Copper Compression Parallel SpliceD2.65
 - Flex Conductor, One-Hole, Standard Barrel with Window LugD2.66 – D2.67
 - Flex Conductor, One-Hole, Standard Barrel with Window Lug, 45° AngleD2.68 – D2.69
 - Flex Conductor, One-Hole, Standard Barrel with Window Lug, 90° AngleD2.70 – D2.71
 - Flex Conductor, One-Hole, Standard Barrel with Window, Narrow Tongue LugD2.72

★ Represents new product offering.

- A. System Overview
- B1. Cable Ties
- B2. Cable Accessories
- B3. Stainless Steel Ties
- C1. Wiring Duct
- C2. Surface Raceway
- C3. Abrasion Protection
- C4. Cable Management
- D1. Terminals
- D2. Power Connectors
- D3. Grounding Connectors
- E1. Labeling Systems
- E2. Labels
- E3. Pre-Printed & Write-On Markers
- E4. Permanent Identification
- E5. Lockout/Tagout & Safety Solutions
- F. Index

Table of Contents

A.
System
Overview

B1.
Cable Ties

B2.
Cable
Accessories

B3.
Stainless
Steel Ties

C1.
Wiring
Duct

C2.
Surface
Raceway

C3.
Abrasion
Protection

C4.
Cable
Management

D1.
Terminals

D2.
Power
Connectors

D3.
Grounding
Connectors

E1.
Labeling
Systems

E2.
Labels

E3.
Pre-Printed
& Write-On
Markers

E4.
Permanent
Identification

E5.
Lockout/
Tagout
& Safety
Solutions

F.
Index

| | |
|---|-----------------|
| Flex Conductor, One-Hole, Standard Barrel with Window, Narrow Tongue Lug, 45° | D2.72 |
| Flex Conductor, One-Hole, Standard Barrel with Window, Narrow Tongue Lug, 90° | D2.73 |
| Flex Conductor, One-Hole, Standard Barrel with Window, Flared NEBS Lug | D2.74 – D2.75 |
| Flex Conductor, One-Hole, Standard Barrel with Window, Flared NEBS Lug, 45° Angle | D2.76 – D2.77 |
| Flex Conductor, One-Hole, Standard Barrel with Window, Flared NEBS Lug, 90° Angle | D2.78 – D2.79 |
| Flex Conductor, One-Hole, Long Barrel with Window Lug | D2.80 |
| Flex Conductor, One-Hole, Long Barrel with Window Lug, 45° Angle | D2.81 |
| Flex Conductor, One-Hole, Long Barrel with Window Lug, 90° Angle | D2.82 |
| Flex Conductor, Two-Hole, Standard Barrel with Window Lug | D2.83 – D2.84 |
| Flex Conductor, Two-Hole, Standard Barrel with Window Lug, 45° Angle | D2.85 – D2.86 |
| Flex Conductor, Two-Hole, Standard Barrel with Window Lug, 90° Angle | D2.87 – D2.88 |
| Flex Conductor, Two-Hole, Standard Barrel with Window, Narrow Tongue Lug | D2.89 |
| Flex Conductor, Two-Hole, Standard Barrel with Window, Narrow Tongue Lug, 45° | D2.90 |
| Flex Conductor, Two-Hole, Standard Barrel with Window, Narrow Tongue Lug, 90° | D2.90 |
| Flex Conductor, Two-Hole, Long Barrel with Window Lug | D2.91 – D2.92 |
| Flex Conductor, Two-Hole, Long Barrel with Window Lug, 45° Angle | D2.93 – D2.94 |
| Flex Conductor, Two-Hole, Long Barrel with Window Lug, 90° Angle | D2.95 – D2.96 |
| Flex Conductor, Two-Hole, Long Barrel, Flared NEBS Lug | D2.97 – D2.98 |
| Flex Conductor, Two-Hole, Long Barrel, Flared NEBS Lug, 45° Angle | D2.99 – D2.100 |
| Flex Conductor, Two-Hole, Long Barrel, Flared NEBS Lug, 90° Angle | D2.101 – D2.102 |
| Flex Conductor, Standard Barrel, Flared, NEBS Butt Splice | D2.103 |
| Code/Flex Conductor, with Window, In-Line Reducing Splice Kit | D2.104 – D2.105 |
| Code/Flex Conductor, with Window, In-Line Reducing Splice | D2.106 – D2.107 |
| Part Number System for Metric Lugs | D2.108 |
| ★ Metric Conductor, One-Hole, Standard Barrel with Window Lug | D2.108 – D2.109 |
| ★ Metric Conductor, Two-Hole, Standard Barrel with Window Lug | D2.110 – D2.111 |
| ★ Metric Conductor, Standard Barrel, Butt Splice | D2.112 |
| PANDUIT Custom Copper Compression Lugs for Special Applications | D2.113 |
| Custom Lugs Spec Sheet Instructions | D2.114 |
| Custom Lugs Preliminary Spec Sheet | D2.115 |
| Code Conductor, One-Hole, Aluminum Lug | D2.116 |
| Code Conductor, Two-Hole, Aluminum Lug | D2.117 |
| Belleville Compression Washers | D2.118 |
| Code Conductor, Aluminum Splice | D2.119 |
| Code Conductor, Aluminum, Reducing Splice | D2.120 |
| Code Conductor, Aluminum, Bi-Metallic Pin Connector | D2.121 |
| Code Conductor, Aluminum HTAP | D2.122 |
| Black Covers for Copper CTAPs and Aluminum HTAPs | D2.123 |
| Joint Compounds | D2.123 |
| PAN-LUG™ Mechanical Connectors | D2.125 |
| Features and Benefits – PAN-LUG™ Mechanical Connectors | D2.126 |
| Selection Guide – PAN-LUG™ Mechanical Connectors, Cast Copper | D2.127 |
| Selection Guide – PAN-LUG™ Mechanical Connectors, Stamped and Formed | D2.128 |
| Selection Guide – PAN-LUG™ Mechanical Connectors, Aluminum | D2.129 |
| Selection Guide – PAN-LUG™ Mechanical Connectors, Split Bolts and Multi-Taps | D2.130 |
| Split Bolt, Copper | D2.131 |
| Split Bolt, Copper, Tin-Plated | D2.132 |
| Split Bolt, Aluminum | D2.133 |
| Two-Bolt Connector, Bronze | D2.133 |
| Two-Bolt Connector, Bronze, Tin-Plated | D2.134 |
| One-Hole, Straight Tongue, Barrel Post Lug | D2.134 |
| One-Hole, Straight Tongue, Tin-Plated, Barrel Post Lug | D2.135 |
| One-Hole, Straight Tongue Lug | D2.135 |
| One-Hole, Straight Tongue Lug with Internal Pressure Plate | D2.136 |
| One-Hole, Straight Tongue, Flag Lug | D2.136 |
| One-Hole, Straight Tongue, 90° Lug | D2.137 |
| Two-Hole, Straight Tongue Lug | D2.137 |
| Two-Hole, Straight Tongue Lug with Internal Pressure Plate | D2.138 |
| Two-Hole, Straight Tongue Lug with NEMA Hole Sizes and Spacing | D2.139 |
| Two-Hole, Straight Tongue, Tandem Set Screw Lug | D2.139 |
| Two-Hole, Straight Tongue, Two-Barrel Lug | D2.140 |
| Two-Hole, Straight Tongue, Two-Barrel, Tin-Plated Lug | D2.140 |
| Two-Set Screw Splice | D2.141 |
| Two-Set Screw Splice with Internal Pressure Plate | D2.141 |
| One-Hole, Straight Fixed Tongue Lug | D2.142 |
| One-Hole, Straight Fixed Tongue, Tin-Plated Lug | D2.142 |
| One-Hole, Straight Floating Tongue Lug | D2.143 |
| Two-Hole, Straight Floating Tongue Lug | D2.144 |
| One-Hole, Offset Floating Tongue Lug | D2.145 |
| One-Hole, Offset Floating Tongue, Two-Barrel Lug | D2.145 |

★ Represents new product offering.

Table of Contents

| | |
|--|-----------------|
| Two-Hole, Offset Floating Tongue Lug | D2.146 |
| One-Hole, Single Barrel Lug | D2.147 |
| Two-Hole, Single Barrel Lug | D2.148 |
| One-Hole, Two-Barrel Lug | D2.148 |
| One-Hole, Vertical Two-Barrel Lug | D2.149 |
| Two-Hole, Two-Barrel Lug | D2.149 |
| Two-Hole, Vertical Two-Barrel Lug | D2.150 |
| Two-Hole, Three-Barrel Lug | D2.150 |
| Two-Hole, Vertical Three-Barrel Lug | D2.151 |
| Four-Hole, Three-Barrel Lug | D2.151 |
| Two-Hole, Vertical Four-Barrel Lug | D2.152 |
| Four-Hole, Four-Barrel Lug | D2.152 |
| Transformer Lug Kit | D2.153 |
| Splicer/Reducer | D2.154 |
| Multi-Tap Connector with Clear Insulation, Single-Sided | D2.155 |
| Multi-Tap Connector with Clear Insulation, Double-Sided | D2.156 – D2.157 |
| In-Line Splicer/Reducer with Clear Insulation | D2.158 |
| Multi-Tap Connector with Clear Insulation, Single-Sided, with Mounting Holes | D2.159 |
| Multi-Tap Connector with Clear Insulation, Double-Sided, with Mounting Holes | D2.160 |
| Belleville Compression Washers | D2.161 |
| Joint Compounds | D2.161 |
| Guidelines for Installing Aluminum Mechanical Connectors | D2.162 |
| PANDUIT Power Connector Approvals | D2.163 |
| Recommended Termination Hardware | D2.164 |
| Conductor Sizes | D2.165 – D2.167 |
| Common Conductor Sizes and Strandings Reference Chart | D2.168 – D2.169 |
| Stud Size Chart (Inches/Millimeters) | D2.170 |
| Equivalent Tables | D2.171 |

Grounding Connectors

| | |
|---|---------------|
| STRUCTUREDGROUND™ Grounding Connectors | D3.1 |
| Features and Benefits – STRUCTUREDGROUND™ Compression Connectors | D3.2 |
| Service Entrance Grounding Roadmap | D3.3 |
| ★ Access Floor Grounding Clamp | D3.4 |
| BICSI/J-STD-607-A Telecommunications Grounding Busbars | D3.5 |
| Component Labels for BICSI/J-STD-607-A Telecommunications Grounding Busbars | D3.5 |
| Telecommunications Grounding and Bonding Conductor Label Kit | D3.5 |
| Code Conductor, Thin Wall, CTAP | D3.6 |
| Code Conductor, Heavy Duty, CTAP | D3.7 |
| Clear Covers for HTCT HTAPs | D3.8 |
| Black Covers for Copper CTAPs and Aluminum HTAPs | D3.8 |
| Code/Flex Conductor HTAP | D3.9 – D3.10 |
| Code/Flex Conductor HTAP Kit | D3.11 – D3.12 |
| Features and Benefits – STRUCTUREDGROUND™ Mechanical Connectors | D3.13 |
| Selection Guide – STRUCTUREDGROUND™ Mechanical Connectors | D3.14 – D3.15 |
| PANDUIT Grounding Connector Approvals | D3.16 |
| Service Post Connector, Male Stud, Single Conductor, Bronze | D3.17 |
| Service Post Connector, Male Stud, Two Conductor, Bronze | D3.18 |
| Service Post Connector, Female Thread, Single Conductor, Bronze | D3.19 |
| Service Post Connector, Female Thread, Two Conductor, Bronze | D3.20 |
| ★ One-Hole Aluminum Lay-In Lug | D3.21 |
| Joint Compounds | D3.21 |
| Grounding Clamp, U-Bolt, Bronze | D3.22 |
| Grounding Clamp, U-Bolt, for Two Cables, Bronze | D3.23 |
| Grounding Clamp for Water Pipes, Bronze | D3.23 |
| Grounding Clamp for Water Pipe with Copper Strap, Bronze | D3.24 |
| Grounding Clamp for Conduit, Bronze | D3.24 |
| Grounding Clamp for Water Pipes, Aluminum | D3.25 |
| Grounding Rod Clamp, Bronze | D3.25 |
| Grounding Clamp with Spacer for Flat Surfaces, Bronze | D3.26 |
| Grounding Clamp for Flat Surfaces, Bronze | D3.26 |
| Compression Connector Crimping Tools | D3.27 |
| Crimping Guidelines for PANDUIT® PAN-LUG™ Compression Lugs and Splices | D3.28 |
| Crimping Guidelines for PANDUIT® STRUCTUREDGROUND™ Compression Connectors | D3.29 |
| Selection Guide – Compression Connector Tools | D3.30 – D3.32 |
| Die Type, Manual, Crimping Tool | D3.33 |
| CD-720 Crimping Dies | D3.33 |
| Die Type, Manual, Crimping Tool and Die Kits | D3.34 |
| Cable Stripping Tool for Large Cable Sizes | D3.34 |

★ Represents new product offering.

| |
|---------------------------------------|
| A. System Overview |
| B1. Cable Ties |
| B2. Cable Accessories |
| B3. Stainless Steel Ties |
| C1. Wiring Duct |
| C2. Surface Raceway |
| C3. Abrasion Protection |
| C4. Cable Management |
| D1. Terminals |
| D2. Power Connectors |
| D3. Grounding Connectors |
| E1. Labeling Systems |
| E2. Labels |
| E3. Pre-Printed & Write-On Markers |
| E4. Permanent Identification |
| E5. Lockout/Tagout & Safety Solutions |
| F. Index |

Table of Contents

| | |
|--|--|
| A. System Overview | |
| B1. Cable Ties | Wire and Cable Stripping Tools D3.34 Die Type, Manual Hydraulic, 14 Ton, Crimping Tool D3.35 Die Type, Battery Powered Hydraulic, 6 Ton, Crimping Tool with Closed Head D3.36 Die Type, Battery Powered Hydraulic, 6 Ton, Crimping Tool with Open “C-Head” D3.37 |
| B2. Cable Accessories | CD-2001 Crimping Dies D3.38 Die Type, Battery Powered Hydraulic, 12 Ton, Crimping Tool D3.39 Die Type, Battery Powered Hydraulic, 15 Ton, Crimping Tool D3.40 Die Type, Remote Hydraulic, 14 Ton, Crimp Head D3.41 Die Type, Remote Hydraulic, 15 Ton, Crimp Head D3.42 |
| B3. Stainless Steel Ties | Hydraulic Pump and Accessories, Electric, 10,000 PSI D3.43 Die Type, Remote Hydraulic, 10.5 Ton, Crimp Head D3.44 Hydraulic Pump and Accessories, Electric, 7,500 PSI D3.45 CD-920 Crimping Dies D3.46 CD-940 Crimping Dies D3.47 |
| C1. Wiring Duct | UNI-DIE™ Dieless, Manual Hydraulic, 6.2 Ton, Crimping Tool D3.48 UNI-DIE™ Dieless, Battery Powered Hydraulic, 6.2 Ton, Crimping Tool, 12 VDC D3.49 UNI-DIE™ Dieless, Remote Hydraulic, 6.2 Ton, Crimp Head D3.50 UNI-DIE™ Dieless, Remote Hydraulic, 4.7 Ton, Crimp Head D3.50 |
| C2. Surface Raceway | Pressure Gauges D3.51 Accessories for Battery Powered Hydraulic Crimping Tools D3.51 Installation Tooling and Die Selections for: Types LCAS and SCSS D3.52 – D3.53 Installation Tooling and Die Selections for: Types LCA, LKAN, LCD, LCDN and SCS D3.54 – D3.57 Installation Tooling and Die Selections for: Types LCB, LCBN, LCC, LCCN and SCL D3.58 – D3.61 Installation Tooling and Die Selections for: Types LCBH, LCCH and SCH D3.62 – D3.63 |
| C3. Abrasion Protection | Installation Tooling and Die Selections for: Type SCT D3.64 – D3.65 Installation Tooling and Die Selections for: Types LCAX, LCAXN, LCBX, LCDX, LCDXN and LCCX D3.66 – D3.69 Installation Tooling and Die Selections for: Types LCAF, LCCF and SCSF D3.70 – D3.71 Installation Tooling and Die Selections for: Type RSC In-Line Reducing Splice D3.72 – D3.77 |
| C4. Cable Management | Installation Tooling and Die Selections for: Type PSC D3.78 Installation Tooling and Die Selections for: Type LCMA, LCMD, and SCMS D3.79 Installation Tooling and Die Selections for: Types LAA, LAB and SA D3.80 – D3.81 Installation Tooling and Die Selections for: Type SAR D3.82 – D3.83 Installation Tooling and Die Selections for: Type BPC D3.84 – D3.85 Installation Tooling and Die Selections for: Type HTAP D3.86 Installation Tooling and Die Selections for: Type HTCT D3.87 Installation Tooling and Die Selections for: Type CTAPP D3.88 – D3.89 Installation Tooling and Die Selections for: Type CTAP D3.90 |
| D1. Terminals | |
| D2. Power Connectors | |
| D3. Grounding Connectors | |
| E1. Labeling Systems | |
| E2. Labels | |
| E3. Pre-Printed & Write-On Markers | |
| E4. Permanent Identification | |
| E5. Lockout/ Tagout & Safety Solutions | |
| F. Index | |

Labeling Systems

| | |
|---|------------------|
| Labeling Systems | E1.0 |
| Printers: Thermal Transfer Desktop and Hand-Held | E1.1 |
| ★ <i>PANTHER</i> ™ LS8E Hand-Held Thermal Transfer Printer and Accessories | E1.2 |
| ★ <i>COUGAR</i> ™ LS9 Hand-Held Thermal Transfer Printer and Accessories | E1.2 |
| <i>P1</i> ™ Self-Laminating Label Cassettes for <i>PANTHER</i> ™ LS8E Hand-Held Thermal Transfer Printer | E1.3 – E1.4 |
| Part Number System for Wire/Cable Labeling | E1.3, E1.5, E1.7 |
| <i>P1</i> ™ Non-Laminated Label Cassettes | E1.5 |
| <i>P1</i> ™ Military Grade Continuous Heat Shrink Label Cassettes for <i>PANTHER</i> ™ LS8E or <i>COUGAR</i> ™ LS9 Hand-Held Thermal Transfer Printers | E1.6 |
| <i>P1</i> ™ Military Grade Die-Cut Heat Shrink Label Cassettes for <i>PANTHER</i> ™ LS8E Hand-Held Thermal Transfer Printer | E1.7 |
| <i>P1</i> ™ General Component Label Cassettes for <i>PANTHER</i> ™ LS8E Hand-Held Thermal Transfer Printers | E1.8 |
| Part Number System for Component Labeling | E1.8 |
| <i>P1</i> ™ Continuous Tape Cassettes for <i>PANTHER</i> ™ LS8E and <i>COUGAR</i> ™ LS9 Hand-Held Thermal Transfer Printers | E1.9 – E1.10 |
| Part Number System for Continuous Tapes | E1.9 |
| TDP43MY Thermal Transfer Desktop Printer and Accessories | E1.11 |
| Ribbons for Use with the TDP43MY Thermal Transfer Desktop Printer | E1.11 |
| TDP42HY, TDP43HY, TDP46HY Thermal Transfer Desktop Printers | E1.12 |
| Ribbons for use with the TDP42HY, TDP43HY and TDP46HY Thermal Transfer Desktop Printers | E1.12 |
| Labeling Software | E1.13 |
| <i>EASY-MARK</i> ™ Labeling Software | E1.14 |
| <i>CAD-CONNECT</i> ™ Labeling Software | E1.14 |

Labels

| | |
|--|------|
| Labels: Laser, Ink Jet, Thermal Transfer and Dot Matrix | E2.1 |
| Laser/Ink Jet Self-Laminating Labels | E2.2 |
| Laser/Ink Jet Non-Laminated Labels | E2.3 |
| Part Number System for Non-Laminated Labels | E2.3 |

★ Represents new product offering.

Table of Contents

| | |
|-----|-----------------------------------|
| A. | System Overview |
| B1. | Cable Ties |
| B2. | Cable Accessories |
| B3. | Stainless Steel Ties |
| C1. | Wiring Duct |
| C2. | Surface Raceway |
| C3. | Abrasion Protection |
| C4. | Cable Management |
| D1. | Terminals |
| D2. | Power Connectors |
| D3. | Grounding Connectors |
| E1. | Labeling Systems |
| E2. | Labels |
| E3. | Pre-Printed & Write-On Markers |
| E4. | Permanent Identification |
| E5. | Lockout/Tagout & Safety Solutions |
| F. | Index |

| | |
|---|---------------|
| Laser/Ink Jet Flag Style Labels | E2.4 |
| Laser/Ink Jet Component Labels | E2.4 – E2.5 |
| Part Number System for Component Labels | E2.4 |
| Thermal Transfer Self-Laminating Labels | E2.6 – E2.8 |
| Part Number System for Self-Laminating Labels | E2.6 |
| Thermal Transfer Marker Plates | E2.9 |
| Thermal Transfer Non-Laminated Labels | E2.10 |
| Part Number System for Non-Laminated Labels | E2.10 |
| Thermal Transfer Commercial Grade Heat Shrink Labels | E2.11 – E2.12 |
| Part Number System for Heat Shrink Labels | E2.11 |
| Thermal Transfer Military Grade Heat Shrink Labels | E2.13 – E2.14 |
| Part Number System for Heat Shrink Labels | E2.13 |
| Heat Shrink Tools and Accessories | E2.14 |
| Thermal Transfer Component Labels | E2.15 – E2.17 |
| Part Number System for Component Labels | E2.15 |
| Thermal Transfer Continuous Tapes | E2.18 – E2.19 |
| Part Number System for Continuous Tapes | E2.18 |
| Dot Matrix Self-Laminating Labels | E2.20 – E2.21 |
| Part Number System for Self-Laminating Labels | E2.20 |
| Dot Matrix Non-Laminated Labels | E2.22 |
| Part Number System for Non-Laminated Labels | E2.22 |
| Dot Matrix Flag Style Labels | E2.23 |
| Dot Matrix Component Labels | E2.23 – E2.24 |
| Size Illustrations of Self-Laminating Labels | E2.25 – E2.26 |
| Size Illustrations of Non-Laminated and Flag Style Labels | E2.27 |
| Size Illustrations of Flattened Heat Shrink Labels | E2.28 |
| Size Illustrations for Component Labels | E2.29 – E2.30 |

Pre-Printed and Write-On Markers

| | |
|--|---------------|
| Pre-Printed and Write-On Markers | E3.1 |
| Pre-Printed Marker Books | E3.2 |
| Pre-Printed Marker Books – Self-Laminating | E3.3 |
| Pre-Printed Marker Cards PCM Type | E3.4 – E3.6 |
| Wire Marker Card Number Combination Packs | E3.6 |
| Pre-Printed Marker Cards | E3.7 |
| Pre-Printed Marker Cards PPM Type | E3.8 |
| Write-On Marker Cards – Self-Laminating | E3.9 |
| Pre-Printed Marker Tape Dispenser | E3.9 |
| Pre-Printed Marker Tape Refills | E3.10 |
| Self-Laminating Wire Marker Dispenser | E3.11 |
| Pre-Printed Clip-On Wire Markers | E3.11 – E3.12 |

Permanent Identification

| | |
|--|-------------|
| Permanent Identification | E4.1 |
| PANDUIT Factory Custom Marking Service | E4.2 |
| Stainless Steel and Brass Marker Plates and Tags | E4.3 – E4.4 |
| ★ PAN-ALUM™ Aluminum Marker Plates | E4.5 |
| Metal Embossing Tool and Tape System | E4.5 |
| ★ Metal Indenting Machine | E4.6 |
| Marker Stamp Kit | E4.6 |

Lockout/Tagout and Safety Solutions

| | |
|---|------|
| Lockout/Tagout | E5.1 |
| OSHA Lockout/Tagout Compliance Manual | E5.2 |
| Lockout/Tagout Regulations Training Video and Handbooks | E5.2 |
| Group Lockout/Tagout Training Video | E5.2 |
| Lockout/Tagout Steps/Calendar Wallet Card | E5.3 |
| Circuit Breaker Lockout Devices | E5.3 |
| “No Tool” Circuit Breaker Lockout Devices | E5.3 |
| Large Handle Circuit Breaker Lockout Device | E5.4 |
| Plug Lockout Device | E5.4 |
| Cord Lockout Devices | E5.4 |
| Receptacle Blockout Device | E5.5 |
| Toggle Switch Lockout Device | E5.5 |
| Toggle/Rocker Switch Lockout Device | E5.5 |
| Gate Valve Lockout Devices | E5.5 |
| Ball Valve Lockout Devices | E5.6 |

★ Represents new product offering.

Table of Contents

A.
System
Overview

B1.
Cable Ties

B2.
Cable
Accessories

B3.
Stainless
Steel Ties

C1.
Wiring
Duct

C2.
Surface
Raceway

C3.
Abrasion
Protection

C4.
Cable
Management

D1.
Terminals

D2.
Power
Connectors

D3.
Grounding
Connectors

E1.
Labeling
Systems

E2.
Labels

E3.
Pre-Printed
& Write-On
Markers

E4.
Permanent
Identification

E5.
Lockout/
Tagout
& Safety
Solutions

F.
Index

| | |
|--|---------------|
| Multiple Lockout Device | E5.6 |
| Pneumatic Energy Lockout Device | E5.6 |
| ★ Jack Module Blockout Device | E5.7 |
| ★ RJ45 Plug Lockin Device | E5.7 |
| Electrician Lockout Kit | E5.8 |
| Contractor Lockout Kit | E5.8 |
| MRO Lockout Kit | E5.8 |
| Power and Panel Distribution Lockout Kit | E5.8 |
| Metal Wall Mount Cabinet | E5.9 |
| Lockout Stations | E5.9 |
| Group Lock Box | E5.9 |
| Warning Label | E5.10 |
| Circuit Breaker Directory Sign | E5.10 |
| Safety Lockout Padlocks | E5.11 |
| High Security Padlocks | E5.11 |
| Laminated Steel Padlocks | E5.12 |
| Value Line Padlocks | E5.12 |
| Lockout Hasps | E5.13 |
| Self-Laminating Padlock Labels | E5.13 |
| Custom Lock Options | E5.13 |
| Metal I.D. Tags and Collars | E5.14 |
| Padlock Eyes | E5.14 |
| Chain Attachment | E5.14 |
| Write-On Safety Tags | E5.15 – E5.17 |
| Bilingual Write-On Safety Tags | E5.18 |
| ISO Symbol Safety Tags | E5.18 |
| Do It Yourself Tags | E5.18 |
| Self-Laminating Photo Tags | E5.19 |
| Permanent Marking Pens | E5.20 |
| Lockout/Tagout Safety Signs | E5.20 |
| Safety and Facility Identification | E5.21 |
| Electrical Hazard Safety Signs | E5.22 |
| ★ Short Circuit Warning Signs | E5.23 |
| ★ Photoluminescent Safety Signs | E5.23 |
| Electrical Symbols on Cards | E5.23 |
| Conductor Identification Labels | E5.24 |
| ISO Warning Symbols | E5.25 |
| Electrical Labels in Dispenser | E5.26 |
| Write-On Labels on Cards | E5.27 |
| Write-On Quality Labels in Dispenser | E5.28 |
| Inspection Plates | E5.29 |
| Inspection Arrows | E5.29 |
| Voltage and Fiber Optic Markers | E5.30 |
| Voltage and Safety Marker Books | E5.31 |
| Hazard Tape | E5.31 |
| Solid Color Adhesive Warning Tape | E5.32 |
| Photoluminescent Tapes – Thermal Transfer Printable | E5.32 |
| Underground Hazard Tape | E5.33 |
| Barricade Tapes | E5.34 |
| Vinyl Letters and Numbers | E5.34 |
| Vinyl Cloth Letters and Numbers | E5.35 – E5.36 |
| Reflective Letters and Numbers | E5.36 |
| Sign Panels – Blank Space for Custom Messages | E5.37 |
| ★ Thermal Transfer Printable Arc Flash Labels | E5.38 |
| ★ Laser Printable Adhesive Signs | E5.38 |
| Self-Laminating Adhesive Sign Carriers | E5.39 |
| Self-Laminating Cable Marker Holders for Large Cables or Cable Bundles | E5.39 |
| Self-Laminating Fiber Optic Cable Marker Tags | E5.40 |
| Ground Warning Tags | E5.40 |
| PANDUIT Corp. Generic Lock Order Form | E5.41 |
| PANDUIT Corp. Generic PVT Vinyl Tag Order Form | E5.42 |
| PANDUIT Corp. Generic Adhesive PPS Safety Sign Order Form | E5.43 |
| PANDUIT Corp. Generic Semi-Rigid PRS Safety Sign Order Form | E5.44 |
| PANDUIT Corp. Generic Conduit and Voltage Marker Order Form | E5.45 |
| PANDUIT Corp. Generic Utility Tapes Order Form | E5.46 |
| Wire Size Selection Guide | E5.47 |
| Selection Guide by Wire/Cable Size | E5.48 |

Index

| | |
|--------------------------|--------------|
| Part Number Index | F1.1 – F1.36 |
|--------------------------|--------------|

★ Represents new product offering.

SYSTEM OVERVIEW

PANDUIT is a global leader in wiring and communication products. Comprehensive solutions include everything necessary to bundle, identify, route, protect and terminate wires/cables. Supporting the most demanding application requirements customers trust *PANDUIT* for:



PANDUIT products are developed through continued focus on the needs of the customer and high level of investment in research and development. Solutions are designed for reliability, improved productivity, standards compliance and lowest total cost of ownership.

- Comprehensive, end-to-end solutions
- World-class quality and reliability
- Innovative products and tools
- Unmatched global sales and technical support

A.
System
Overview

B1.
Cable Ties

B2.
Cable
Accessories

B3.
Stainless
Steel Ties

C1.
Wiring
Duct

C2.
Surface
Raceway

C3.
Abrasion
Protection

C4.
Cable
Management

D1.
Terminals

D2.
Power
Connectors

D3.
Grounding
Connectors

E1.
Labeling
Systems

E2.
Labels

E3.
Pre-Printed
& Write-On
Markers

E4.
Permanent
Identification

E5.
Lockout/
Tagout
& Safety
Solutions

F.
Index

A.
System
Overview

SOLUTIONS OVERVIEW

PANDUIT provides innovative solutions that offer maximum reliability at the lowest installed cost from the factory and manufacturing floor, to automation and control, to the office area.

B1.
Cable Ties

B2.
Cable
Accessories

B3.
Stainless
Steel Ties

C1.
Wiring
Duct

C2.
Surface
Raceway

C3.
Abrasion
Protection

C4.
Cable
Management

D1.
Terminals

D2.
Power
Connectors

D3.
Grounding
Connectors

E1.
Labeling
Systems

E2.
Labels

E3.
Pre-Printed
& Write-On
Markers

E4.
Permanent
Identification

E5.
Lockout/
Tagout/
& Safety
Solutions

F.
Index



Industrial



MRO



Oil and Gas



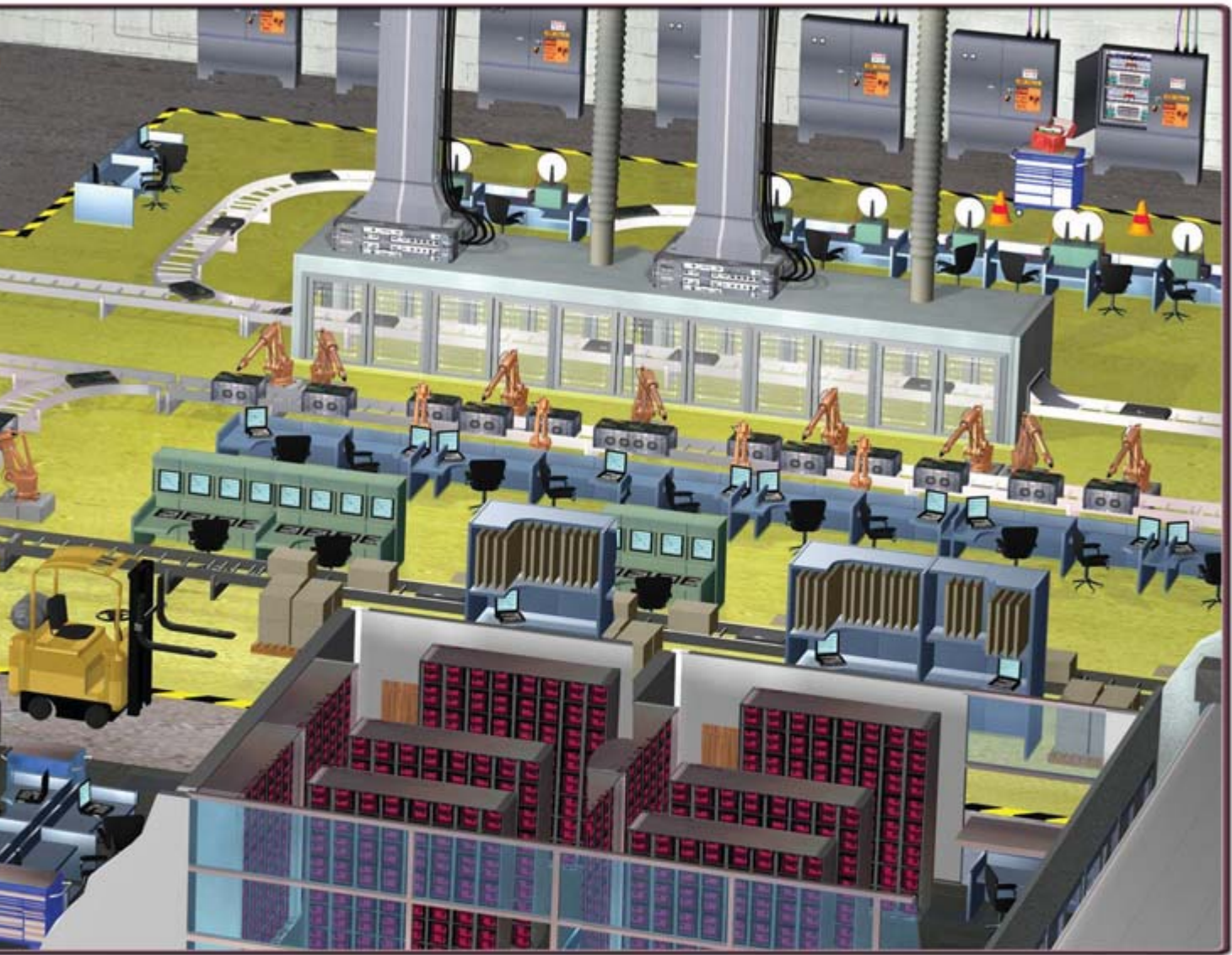

A.
System
Overview

B1.
Cable Ties

B2.
Cable
Accessories

B3.
Stainless
Steel Ties

C1.
Wiring
Duct

C2.
Surface
Raceway

C3.
Abrasion
Protection

C4.
Cable
Management

D1.
Terminals

D2.
Power
Connectors

D3.
Grounding
Connectors

E1.
Labeling
Systems

E2.
Labels

E3.
Pre-Printed
& Write-On
Markers

E4.
Permanent
Identification

E5.
Lockout/
Tagout/
& Safety
Solutions

F.
Index

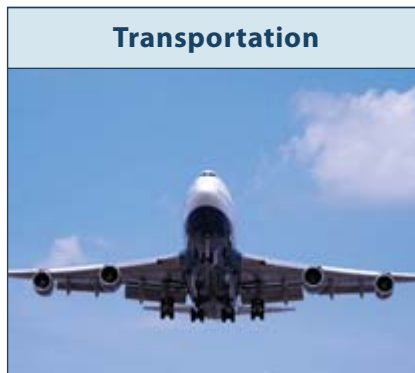

A.
System
Overview

CONTROL PANEL SOLUTIONS

PANDUIT delivers innovative solutions that support evolving technologies in automation and control. Control panel solutions from PANDUIT reduce design and assembly time, save valuable panel space, ease installation and maintenance, and improve manageability and reliability, all contributing to lower cost of ownership.

B1.
Cable Ties

B2.
Cable
Accessories

B3.
Stainless
Steel Ties

C1.
Wiring
Duct

C2.
Surface
Raceway

C3.
Abrasion
Protection

C4.
Cable
Management

D1.
Terminals

D2.
Power
Connectors

D3.
Grounding
Connectors

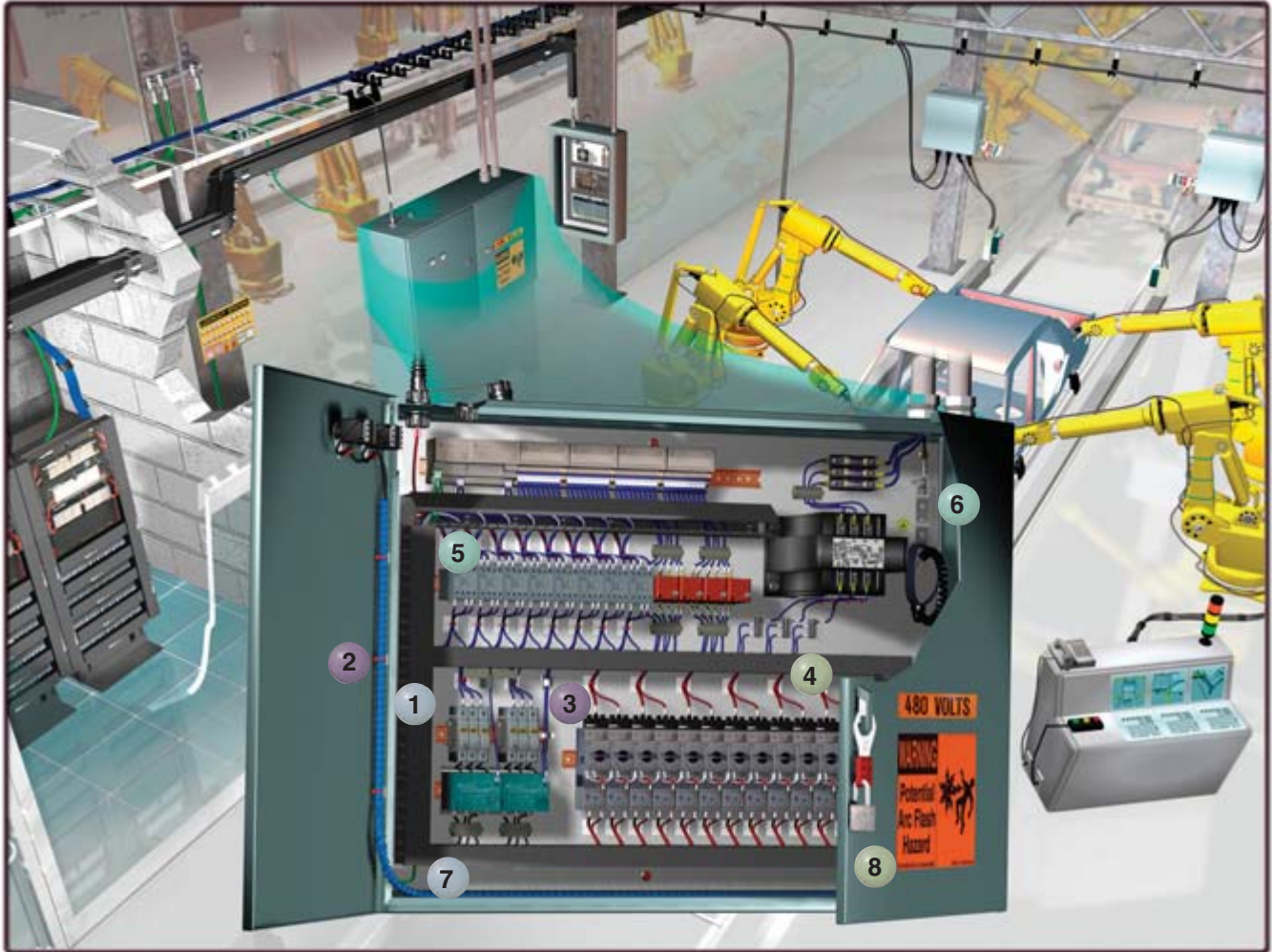

E1.
Labeling
Systems

E2.
Labels

E3.
Pre-Printed
& Write-On
Markers

E4.
Permanent
Identification

E5.
Lockout/
Tagout/
& Safety
Solutions

F.
Index

1 **Wiring Duct**

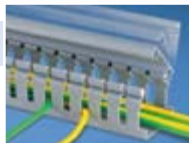

2 **Cable Ties**



3 **Cable Accessories**



4 **Labeling Systems**



5 **Terminals**



6 **Power and
Grounding
Connectors**



7 **Abrasion
Protection**



8 **Lockout/
Tagout**



For INDUSTRIALNET™ Solution, request SA-CPCB10 or visit www.panduit.com.

HARNESS SOLUTIONS

PANDUIT is a leading supplier of wire management solutions, helping OEM and CMs achieve their strategic objectives. From complete system solutions that provide the lowest installed cost to new product innovations that meet evolving application challenges, PANDUIT solutions meet a wide range of applications, volumes, and environments in white goods, gaming, vending and transportation.

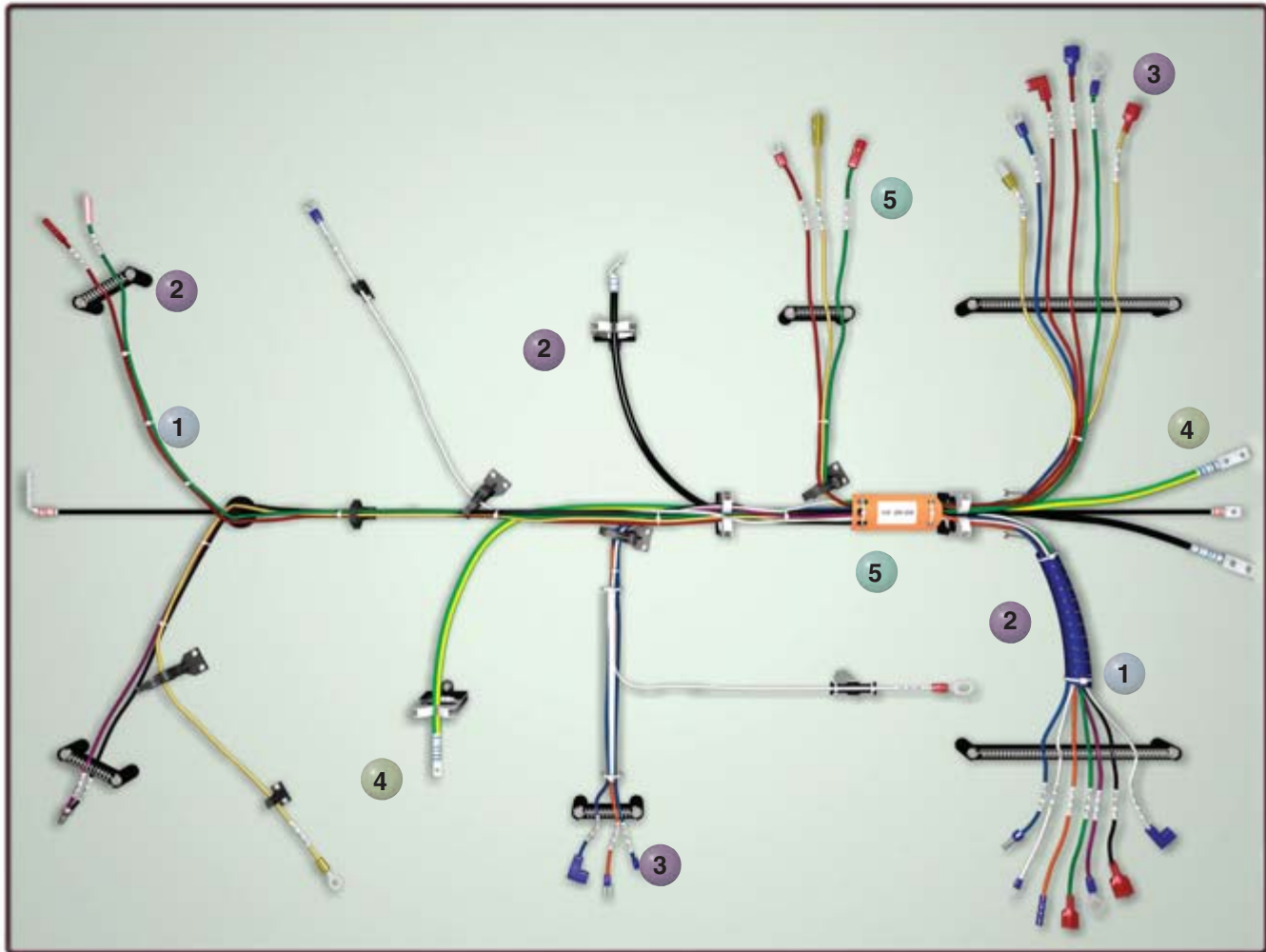

1 Cable Tie Systems



2 Cable Accessories



3 Terminal Systems



4 Power Connector Systems



5 Identification Systems



A.
System
Overview

B1.
Cable Ties

B2.
Cable
Accessories

B3.
Stainless
Steel Ties

C1.
Wiring
Duct

C2.
Surface
Raceway

C3.
Abrasion
Protection

C4.
Cable
Management

D1.
Terminals

D2.
Power
Connectors

D3.
Grounding
Connectors

E1.
Labeling
Systems

E2.
Labels

E3.
Pre-Printed
& Write-On
Markers

E4.
Permanent
Identification

E5.
Lockout/
Tagout/
& Safety
Solutions

F.
Index

A.
System
Overview

B1.
Cable Ties

B2.
Cable
Accessories

B3.
Stainless
Steel Ties

C1.
Wiring
Duct

C2.
Surface
Raceway

C3.
Abrasion
Protection

C4.
Cable
Management

D1.
Terminals

D2.
Power
Connectors

D3.
Grounding
Connectors

E1.
Labeling
Systems

E2.
Labels

E3.
Pre-Printed
& Write-On
Markers

E4.
Permanent
Identification

E5.
Lockout/
Tagout
& Safety
Solutions

F.
Index

CONTRACTOR SOLUTIONS



PANDUIT is committed to delivering innovative solutions that meet the needs of electrical and networking installations. Contractors rely on *PANDUIT* solutions for improved productivity, reliability, and safety with lower installed costs. A comprehensive range of products and tooling satisfies the most demanding applications and environments. Contractor programs further support your business needs and benefit the bottom line.

MRO SOLUTIONS



Maximizing facility uptime while containing maintenance and repair costs is a big challenge facing industrial and manufacturing facilities. Electrical and control systems repair, reconfiguration, and preventative maintenance comprise a substantial portion of the total facility spend. *PANDUIT* solutions deliver best-in-class quality for maximum reliability and defect-free installations, minimizing rework and reducing downtime. The breadth of product lines and materials selection provides extensive application and environment-specific solutions for faster, easier, and more cost-effective maintenance and repair operations (MRO).



HARSH ENVIRONMENT SOLUTIONS

When vibration, radiation, weathering, corrosion and temperature extremes are a factor, you need a high quality, reliable, and durable solution. *PANDUIT* provides everything necessary to bundle, route, protect, terminate and identify electrical and network cable in indoor and outdoor extreme conditions. These innovative solutions meet the needs of the most demanding harsh and industrial environment applications to deliver long life, increased productivity, and improved worker safety.



TRANSPORTATION SOLUTIONS

PANDUIT develops high-quality products to meet the requirements of the transportation market while providing the lowest installed cost. Performance, reliability, efficiency and availability are critical issues to success. *PANDUIT* solutions are designed to hold up under vibration, shock, and exposure to nature's elements while preventing corrosion, reducing weight, and speeding installation.

A.
System
Overview

B1.
Cable
Ties

B2.
Cable
Accessories

B3.
Stainless
Steel Ties

C1.
Wiring
Duct

C2.
Surface
Raceway

C3.
Abrasion
Protection

C4.
Cable
Management

D1.
Terminals

D2.
Power
Connectors

D3.
Grounding
Connectors

E1.
Labeling
Systems

E2.
Labels

E3.
Pre-Printed
& Write-On
Markers

E4.
Permanent
Identification

E5.
Lockout/
Tagout
& Safety
Solutions

F.
Index

APPLICATION STANDARDS

To help assure optimum quality, *PANDUIT* products are designed and manufactured to meet applicable environmental, safety, market industry and customer standards.

Restriction of Hazardous Substances (RoHS)

RoHS

The European Union (EU) directive on the Restriction of use of certain Hazardous Substances bans the use of six substances in electrical and electronic equipment within the European Economic Community (EEC) after July 1, 2006. The RoHS status of *PANDUIT* Electrical Products, shown in this catalog, can be determined by accessing www.panduit.com.

Underwriters Laboratories, Inc



Underwriters Laboratories, Inc. (UL) is an independent, not-for-profit product-safety testing and certification organization based in the United States. Since its founding in 1894, UL is becoming one of the most recognized, reputable conformity assessment providers in the world. Today, services extend to helping companies achieve global acceptance, whether for an electrical device, a programmable system, or an organization's quality process. Further information on UL marks can be found at www.ul.com/mark/.

Canadian Standards Association



The Canadian Standards Association is a not-for-profit membership based association serving business, industry, government and consumers in Canada and the global marketplace. CSA works in Canada and around the world to develop standards that enhance public safety and health. Additional information can be found at www.csa.ca.

Conformity European



CE marketing is required for certain products sold within the European Union (EU). EU Directives and Norms, specify the requirements for products. Applying the CE mark signifies compliance with those requirements.

ISO 9001



The International Standards Organization (ISO) establishes worldwide standards for products and services in recognition of increasing globalization of markets. The ISO program establishes the requirements for quality assurance systems. All *PANDUIT* component manufacturing facilities are third party registered to ISO 9001. Registration certificates are available from *PANDUIT*, www.panduit.com.

ISO/TS16949

ISO/TS16949 is a recognized supplier quality standard for the automotive industry. The ISO community of accreditation bodies and registrars considers these additions automotive "interpretations" to the global ISO 9001 standard. Appropriate *PANDUIT* locations are third party registered to this standard. Registration certificates are available from *PANDUIT*, www.panduit.com.

ISO 14001



ISO14001 is a voluntary standard for Environmental Management Systems established by the International Organization for Standardization. The international standard provides a benchmark for continual improvement in environmental performance. Business partners can be confident that *PANDUIT* manufacturing facilities around the globe are engaged in an ongoing process to maximize value while minimizing the impact on natural resources.

National Electrical Manufacturers Association (NEMA)

NEMA is the largest trade association in the U.S. representing electro-industry manufacturers. NEMA develops industry standards that are in the best interest of the industry and users of its products. NEMA standards for electrical power connector for substations covers uninsulated connectors and busbar supports which are made of metal and intended for use in substations. Included in the standard are manufacturing standards for bolt hole sizes and spacing for terminal connectors with single tangs. *PANDUIT* offers connectors that meet NEMA manufacturing standards and these are specially noted as listed within this catalog.

APPLICATION STANDARDS (continued)

Alliance for Telecommunications Industry Solutions (ATIS)



ATIS is a technical planning and standards development organization that is committed to rapidly developing and promoting technical and operations standards for the communications and related information technologies industry worldwide using a pragmatic, flexible, and open approach. Over 1,200 participants from more than 400 communications companies are active in ATIS' 22 industry committees, and its Incubator Solutions Program. Additional information can be found at www.atis.org.

J-STD-607-A-2002, Commercial Building Grounding (Earthing) and Bonding Requirements for Telecommunications is jointly developed by TIA/EIA and ATIS' technical committee T1E1. This document is available on the ATIS Document Center at www.atis.org.

Adhering to the grounding principles outlined in J-STD-607-A helps ensure that the telecommunications grounding and bonding system will perform acceptably regardless of the data and voice equipment installed. As stated in J-STD-607-A, the preferred means of connecting conductors to busbars is by using two-hole irreversible compression lugs listed by a nationally recognized testing laboratory (NRTL) such as UL. *PANDUIT PAN-LUG™* Copper Compression Connectors meet these requirements, in all barrel sizes specified by the 607 standard.

Telecommunications Industry Association (TIA)



The Telecommunications Industry Association is a leading US non-profit trade association serving the communications and information technology industry. TIA represents providers of communications and information technology products and services for the global marketplace through its core competencies in standards development.

ANSI/TIA-942 Telecommunications Infrastructure Standard for Data Centers covers a wide range of facilities issues, including grounding and bonding. It states that electrical continuity is required throughout the rack materials. Adhering to these principles protects network equipment and maintains system performance.

NEBS Level 3 Approval as Tested by Telcordia Technologies

Telcordia Technologies, formerly known as Bellcore, serves as the testing agency for the Regional Bell Operating Companies. Network Equipment-Building Systems (NEBS) was developed by Bellcore and is currently maintained by Telcordia Technologies. NEBS was developed to standardize requirements for Central Office Equipment and to develop criteria for personal safety, protection of property, and operational continuity.

NEBS Level 3 Criteria is the minimum level of environmental compatibility needed to provide maximum assurance of equipment operability within the network facility environment. The Level 3 criteria is the highest assurance of product operability. Products that meet NEBS Level 3 Criteria are suited for equipment applications which demand minimal service interruptions over the life span of the equipment. *PANDUIT* is the first in the industry to have a system of copper compression lugs and splices (#8 AWG – 1,000 kcmil) and crimping tools physically and rigorously tested by Telcordia Technologies to meet NEBS Level 3 compliance.

American Bureau of Shipping (ABS)



ABS is a not-for-profit organization that promotes the security of life, property, and the natural environment primarily through the development and verification of standards for the design, construction, and operational maintenance of marine related facilities including: merchant and naval vessels, offshore drilling units, submersibles, FPSOs, etc. *PANDUIT* has ABS Type Approval for select copper compression lugs and splices and are in compliance with ABS 2005 Steel Vessel Rules and can be installed on ABS Type Approved steel vessel machinery, electrical systems, and electrical equipment. *PANDUIT* products that meet ABS Type Approval can be found listed on the ABS website at www.typeapproval.org.

B1.
Cable Ties

B2.
Cable
Accessories

B3.
Stainless
Steel Ties

C1.
Wiring
Duct

C2.
Surface
Raceway

C3.
Abrasion
Protection

C4.
Cable
Management

D1.
Terminals

D2.
Power
Connectors

D3.
Grounding
Connectors

E1.
Labeling
Systems

E2.
Labels

E3.
Pre-Printed
& Write-On
Markers

E4.
Permanent
Identification

E5.
Lockout/
Tagout
& Safety
Solutions

F.
Index

PROGRAMS

PANDUIT maintains a dedicated global sales force of highly qualified industry experts to provide professional, consultative sales guidance. In addition, *PANDUIT* has partnered with best-in-class contractors and distributors to provide the services and support to deliver comprehensive, reliable solutions at the lowest installed cost.

Contractor Loyalty Incentive Program (CLIP)

The CLIP program was developed to strengthen relationships and form alliances with valued contractors. Use *PANDUIT* as your preferred vendor for cable ties, terminals, power connectors, identification products, surface raceway, installation tooling and a host of related products, and earn credit towards *PANDUIT* tooling.

Benefits of being a CLIP participant include annual credit incentives, continuous training, potential project leads, and alliance with a global, world-class electrical manufacturer and exclusive promotions.

For more program details, go to www.panduit.com/clip or contact *PANDUIT* Customer Service at 800-777-3300.

Tooling Partnership Program

The tooling Partnership Program is designed to make low-cost or no cost tooling available to the customer based on qualification and commitment to termination product purchases.

For more program details, go to www.panduit.com/tpp or contact *PANDUIT* Customer Service at 800-777-3300.

PC Express Program

PC Express offers the ultimate level of service for your power connector needs. PC Express is offered through select authorized *PANDUIT* distributors. The PC Express Program provides customers with the ability to receive power connector orders, via second day delivery, at no additional charge.

The customer can place an order of any size, up to a 300 lb. maximum weight, through an authorized *PANDUIT* distributor and *PANDUIT* will absorb the second day freight charges. All orders will be shipped directly to the customer. Orders received by *PANDUIT* Customer Service before 3:00 P.M. CST will be shipped on the same day, via second day delivery. Orders received after 3:00 P.M. CST will be shipped the next business day, via second day delivery.

For more program details, go to www.panduit.com/pcexpress or contact *PANDUIT* Customer Service at 800-777-3300.

Note: All programs and benefits are subject to terms and conditions.

CABLE TIES



PANDUIT offers the most complete selection of cable tie styles, sizes, materials and colors to meet our customers' needs. *PANDUIT* cable ties bundle, mount, and identify in countless indoor, outdoor, and harsh environment applications. *PANDUIT* cable ties, wiring accessories, and installation tools allow our customers to achieve the lowest total installed cost of managing wire and cable.



- *PANDUIT* continues to provide innovative new cable tie designs to meet our customers' application challenges
- *PANDUIT* cable ties and wiring accessories can be used in a variety of applications and environments, providing the optimal wire management solution
- *PANDUIT* offers a large selection of ergonomic cable tie installation tools – from high-speed automatic systems to hand operated tools; all with consistent, reliable performance



PANDUIT leads the industry in the breadth and depth of available cable tie designs created from customer feedback on their application requirements. As with all *PANDUIT* products, quality in design and production along with customer service excellence are assured.

A.
System
Overview

B1.
Cable
Ties

B2.
Cable
Accessories

B3.
Stainless
Steel Ties

C1.
Wiring
Duct

C2.
Surface
Raceway

C3.
Abrasion
Protection

C4.
Cable
Management

D1.
Terminals

D2.
Power
Connectors

D3.
Grounding
Connectors

E1.
Labeling
Systems

E2.
Labels

E3.
Pre-Printed
& Write-On
Markers

E4.
Permanent
Identification

E5.
Lockout/
Tagout/
& Safety
Solutions

F.
Index

A.
System
Overview

Cable Tie Selection Chart

Follow this step-by-step process to find the cable ties that best suit your application:

Cable Tie Function

- 1) Select the main function of the cable tie you need:
 Bundle = Standard Cable Ties
 Re-use = Nylon Releasable Ties*
 Identify = Marker and Flag Ties
 Mount = Clamp Ties, Push Mount Ties, and Stud Mount Ties

Material Properties

- 2) Determine the appropriate material for your application:
 Mechanical
 Chemical
 Thermal

Cable Tie Family

- 3) Select the cable tie family that meets your overall needs

B1.
Cable Ties

B2.
Cable
Accessories

B3.
Stainless
Steel Ties

C1.
Wiring
Duct

C2.
Surface
Raceway

C3.
Abrasion
Protection

C4.
Cable
Management

D1.
Terminals

D2.
Power
Connectors

D3.
Grounding
Connectors

E1.
Labeling
Systems

E2.
Labels

E3.
Pre-Printed
& Write-On
Markers

E4.
Permanent
Identification

E5.
Lockout/
Tagout
& Safety
Solutions

F.
Index

| | Cable Tie Function | Test Method | Bundle, Re-use, Identify, Mount | Bundle, Re-use, Identify, Mount | Bundle, Re-use, Mount | Bundle, Re-use, Mount | Bundle | Bundle |
|-------------------------|--|---------------------------|----------------------------------|---------------------------------|---|---------------------------|---------------------------|---|
| C1. Wiring Duct | Material | | Nylon 6.6 | Weather Resistant Nylon 6.6 | Impact Modified Weather Resistant Nylon 6.6 | Heat Stabilized Nylon 6.6 | Heat Stabilized Nylon 6.6 | Heat Stabilized Weather Resistant Nylon 6.6 |
| | Color | — | Natural (other colors available) | Black | Black | Black | Natural | Black |
| | Part Number Suffix (Material Designation) | — | No Suffix | 0 | 0 | 30 | 39 | 300 |
| C2. Surface Raceway | Tensile @ Yield @ 73°F(psi) | ISO 527 | 12,000 | 12,000 | 9,700 | 12,000 | 12,000 | 12,000 |
| | Water Absorption (24 Hours) | ASTM D570 | 1.2% | 1.2% | 1.2% | 1.2% | 1.2% | 1.2% |
| | Radiation Resistance (Rads) | — | 1 x 10 ⁵ | 1 x 10 ⁵ | 1 x 10 ⁵ | 1 x 10 ⁵ | 1 x 10 ⁵ | 1 x 10 ⁵ |
| | Weathering Life Expectancy (Years)/UV Resistance | — | 1 – 2 | 7 – 9 | 7 – 9 | 4 – 5 | 1 – 2 | 7 – 9 |
| C3. Abrasion Protection | Impact Resistance | — | ○ | ○ | ⊖ | ○ | ○ | ○ |
| | Salts | — | ⊖ | ⊖ | ⊖ | ⊖ | ⊖ | ⊖ |
| | Hydrocarbons (Gas, Oil, Lubricants) | — | ● | ● | ● | ● | ● | ● |
| | Chlorinated Hydrocarbons | — | ⊖ | ⊖ | ⊖ | ⊖ | ⊖ | ⊖ |
| | Acids | — | ● | ● | ● | ● | ● | ● |
| | Bases | — | ⊖ | ⊖ | ⊖ | ⊖ | ⊖ | ⊖ |
| C4. Cable Management | Acid Rain | — | ⊖ | ⊖ | ⊖ | ⊖ | ⊖ | ⊖ |
| | Max. Continuous Use Temperature (Note 1) | UL 746B | 185°F 85°C | 185°F 85°C | 185°F 85°C | 239°F 115°C | 239°F 115°C | 212°F 100°C (Note 2) |
| | Min. Application Use Temperature | EN 50146 | -76°F -60°C | -76°F -60°C | -76°F -60°C | -76°F -60°C | -76°F -60°C | -76°F -60°C |
| | Flammability Rating (Note 4) | UL 94 | V-2 | V-2 | HB | V-2 | V-2 | V-2 |
| | Low Smoke | ASTM E662 | PASS | PASS | PASS | PASS | PASS | PASS |
| | Oxygen Index | BS ISO 4589 | 28 | 28 | — | 28 | 28 | 28 |
| D1. Terminals | Halogen-Free | IEC 60754-2 | Yes | Yes | Yes | Yes | Yes | Yes |
| | Burning Fume Toxicity | BSS-7239 | PASS | PASS | PASS | PASS | PASS | PASS |
| | Heat Deflection Temperature @ 1.8 Mpa | ASTM D648 ISO 75 -1/-2 | 158°F 70°C | 158°F 70°C | 145°F 63°C | 158°F 70°C | 158°F 70°C | 158°F 70°C |
| | Relative Price | — | Low | Low | Low | Low | Low | Med |

| Cable Tie Catalog Page | Product Line | Cross Sections | | | | | |
|------------------------|---------------------------|----------------|----------------|-----------|---|---|---|
| | | | | | | | |
| | PAN-TY® (B1.6 - Note 5) | ✓ | SM, M, I, S | LH, H, EH | ✓ | ✓ | ✓ |
| | SUPER-GRIP® (B1.38) | ✓ | M, I, S, LH | H | ✓ | | |
| | DOME-TOP® Barb Ty (B1.43) | ✓ | M, I, S | LH | ✓ | ✓ | ✓ |
| | DURA-TY™ (B1.53) | | | | | | |
| | Parallel-Entry (B1.56) | ✓ | M, I, S, HS | LH | | ✓ | |
| | STA-STRAP® (B1.65) | ✓ | M, I, S, LH, H | | ✓ | | |
| | Specialty Ties (B1.73) | ✓ | | H | ✓ | | ✓ |

Check mark indicates material availability in that product line.
 Cross Sections: SM = Subminiature, M = Miniature, I = Intermediate, S = Standard, HS = Heavy-Standard, LH = Light-Heavy, H = Heavy, EH = Extra-Heavy

*For information on re-usable Hook and Loop Cable Ties, see page B1.85.

A.
System
Overview

B1.
Cable Ties

B2.
Cable
Accessories

B3.
Stainless
Steel Ties

C1.
Wiring
Duct

C2.
Surface
Raceway

C3.
Abrasion
Protection

C4.
Cable
Management

D1.
Terminals

D2.
Power
Connectors

D3.
Grounding
Connectors

E1.
Labeling
Systems

E2.
Labels

E3.
Pre-Printed
& Write-On
Markers

E4.
Permanent
Identification

E5.
Lockout/
Tagout
& Safety
Solutions

F.
Index

| Recommendation Legend | Highest | High | Acceptable | Low | Lowest |
|-----------------------|---------|------|------------|-----|--------|
| | ● | ◐ | ○ | ◑ | ● |

| Bundle | Bundle, Identify | Bundle | Bundle | Bundle, Re-use | Bundle | Bundle | Bundle | Bundle | Bundle |
|---------------------------|---------------------------|----------------------------|---------------------|---------------------------------|---------------------|---------------------|----------------------------|----------------------------|--------------------------|
| Flame Retardant Nylon 6.6 | Flame Retardant Nylon 6.6 | Weather Resistant Nylon 12 | Polypropylene | Weather Resistant Polypropylene | TEFZEL [■] | HALAR [▲] | PEEK | Metal Detectable Nylon 6.6 | Weather Resistant Acetal |
| Black | Natural Ivory | Black | Green | Black | Aqua Blue | Maroon | Translucent Brown | Blue | Black |
| 60 | 69 | 120 | 109 | 100 | 76 | 702Y | 71 | 86 | N/A |
| 11,000 | 11,000 | 6,700 | 4,100 | 4,100 | 7,500 | 7,000 | 15,200 | — | 6,500 |
| 1.1% | 1.1% | 0.3% | 0.1% | 0.1% | <0.03% | <0.05% | 0.5% | 1.2% | <0.45% |
| 1 x 10 ⁵ | 1 x 10 ⁵ | 3.5 x 10 ⁶ | 1 x 10 ⁶ | 1 x 10 ⁶ | 2 x 10 ⁸ | 2 x 10 ⁸ | 1 x 10 ⁹ | — | 6 x 10 ⁵ |
| 1 – 2 | 1 – 2 | 12 – 15 | 1 | 7 – 9 | >15 | >15 | 1 – 2 | — | >20 |
| ◑ | ◑ | ○ | ◐ | ◐ | ● | ● | ● | ○ | ◐ |
| ◑ | ◑ | ◐ | ● | ● | ● | ● | ● | ◑ | ○ |
| ● | ● | ● | ○ | ○ | ● | ● | ● | ● | ● |
| ◐ | ◐ | ◐ | ○ | ○ | ● | ● | ● | ◐ | ◐ |
| ● | ● | ○ | ● | ● | ● | ● | ○ | ● | ● |
| ◐ | ◐ | ◐ | ● | ● | ● | ● | ● | ◐ | ● |
| ◑ | ◑ | ◐ | ● | ● | ● | ● | ◐ | — | ◑ |
| 212°F 100°C | 212°F 100°C | 194°F 90°C | 239°F 115°C | 239°F 115°C | 338°F 170°C | 302°F 150°C | 500°F 260°C (Note 3) | 185°F 85°C | 185°F 85°C |
| -40°F -40°C | -76°F -60°C | -76°F -60°C | -76°F -60°C | -76°F -60°C | -76°F -60°C | -76°F -60°C | -76°F -60°C | -76°F -60°C | -76°F -60°C |
| V-0 | V-0 | HB | HB | HB | V-0 | V-0 | V-0 | HB | HB |
| PASS | PASS | — | — | — | — | — | PASS | — | PASS |
| 34 | 34 | — | — | — | 30 | 52 | 35 | — | — |
| Yes | Yes | Yes | Yes | Yes | No | No | Yes | Yes | Yes |
| PASS | PASS | — | — | — | — | — | — | — | — |
| 154°F 68°C | 154°F 68°C | 122°F 50°C | 122°F 50°C | 122°F 50°C | — | 149°F 65°C | 313°F 156°C | 145°F 63°C | 239°F 115°C |
| Med | Med | Med | Med | Med | High | High | High | Low | Med |

| | | | | | | | | | |
|---|---|---|---|---|---|---|---|---|---|
| ✓ | ✓ | ✓ | ✓ | ✓ | ✓ | ✓ | ✓ | ✓ | ✓ |
| | ✓ | | | | | | | | |
| | ✓ | | | | | | | | ✓ |
| | | | | | | | | | |
| | | | | | | | | | |

Note 1: Also known as Relative Thermal Index (RTI), see Temperature (page B1.101)

Note 2: Estimated
Note 3: Based on the UL RTI for electrical properties

Note 4: See Table B (page B1.100)
Note 5: Also available in 00 material (meets Mil Spec)

■ TEFZEL is a registered trademark of E.I. du Pont de Nemours and Company.

▲ HALAR is a registered trademark of Solvay Solexis, Inc.

A.
System
Overview

Cable Tie Styles Overview

B1.
Cable Ties

PAN-TY® Cable Ties

Pages B1.6 – B1.37

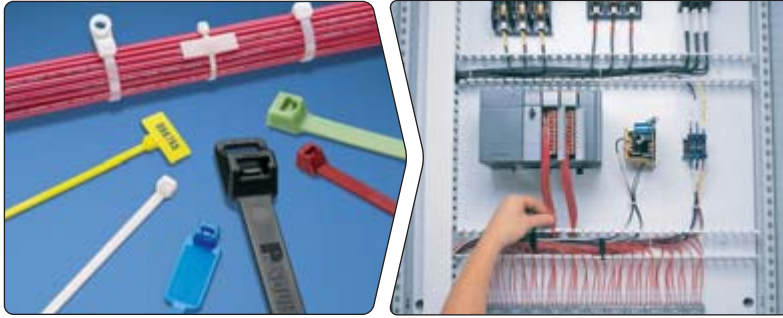

- Designed for use in numerous applications to meet a variety of needs in the OEM, MRO, and construction markets
- Largest selection of styles, materials, and sizes
- One-piece construction for consistent performance and reliability
- Lowest threading force of any one-piece cable tie in the industry

C1.
Wiring
Duct

C2.
Surface
Raceway

SUPER-GRIP® Cable Ties

Pages B1.38 – B1.42



- Designed for the strength requirements of the MRO and construction markets
- Thin, wide strap body – flexible, conforms to bundles
- Strong – withstands rough installation practices
- Grips wires tightly and resists lateral movement

C3.
Abrasion
Protection

C4.
Cable
Management

D1.
Terminals

DOME-TOP® Barb Ty Cable Ties

Pages B1.43 – B1.55



- Approved for the demanding MRO and construction requirements as typified in the oil and gas markets
- Stainless steel barb provides consistent performance and reliability
- Infinitely adjustable for tight bundles throughout entire bundle range
- Dome-top head features unique patented design with smooth, round edges

D2.
Power
Connectors

D3.
Grounding
Connectors

E1.
Labeling
Systems

E2.
Labels

Parallel-Entry Cable Ties

Pages B1.56 – B1.64



- Designed for use in the OEM and transportation markets
- All parallel-entry ties provide a low profile head which avoids snags and reduces overall bundle size
- No protrusion of tie cut-off – protects workers' arms/hands
- *CONTOUR-TY*® Cable Ties have outside teeth and smooth, round edges to protect cable jacket – perfect for high vibration applications

E3.
Pre-Printed
& Write-On
Markers

E4.
Permanent
Identification

E5.
Lockout/
Tagout
& Safety
Solutions

F.
Index

A.
System
Overview

B1.
Cable Ties

B2.
Cable
Accessories

B3.
Stainless
Steel Ties

C1.
Wiring
Duct

C2.
Surface
Raceway

C3.
Abrasion
Protection

C4.
Cable
Management

D1.
Terminals

D2.
Power
Connectors

D3.
Grounding
Connectors

E1.
Labeling
Systems

E2.
Labels

E3.
Pre-Printed
& Write-On
Markers

E4.
Permanent
Identification

E5.
Lockout/
Tagout/
& Safety
Solutions

F.
Index

STA-STRAP® Cable Ties

Pages B1.65 – B1.72



- Convenient and easy to use in OEM manual assembly operations
- Exclusive, two-piece design provides lowest threading force in the industry
- Use for normal bundling and through-panel applications
- Releasable prior to final tensioning and cut-off

Hook and Loop Cable Ties

Pages B1.85 – B1.90



- Ideal for the telecommunications, financial, education and government markets
- Adjustable, releasable, and re-usable
- No risk of over-tensioning or damaging high performance network cables
- Variety of styles, sizes, and colors

Manual Cable Tie Installation Tools

Pages B1.107 – B1.112



- Used in production, maintenance, and construction applications
- Designed for ease of use and to reduce repetitive stress injuries
- Full line of lightweight, ergonomic hand tools – PANDUIT leads the industry in reliability and performance
- Flush cut-off of cable tie limits exposure to sharp edges

Automatic Cable Tie Installation Tools

Pages B1.113 – B1.121



- An efficient solution for high volume OEM harness, assembly, fastening and packaging applications
- High-speed tools lower installed cost and reduce operator fatigue
- Wrap, tension, and cut-off cable ties in less than a second
- Reel-fed systems for miniature and standard cross section cable ties

A.
System
Overview

Features and Benefits – PAN-TY® Cable Ties

B1.
Cable Ties

One-piece design for consistent performance and reliability.
Available in lengths from 2.8 to 43.3 inches and a variety of styles, materials, and colors for specific applications.

B2.
Cable
Accessories

B3.
Stainless
Steel Ties

C1.
Wiring
Duct

C2.
Surface
Raceway

C3.
Abrasion
Protection

C4.
Cable
Management

D1.
Terminals

D2.
Power
Connectors

D3.
Grounding
Connectors

E1.
Labeling
Systems

E2.
Labels

E3.
Pre-Printed
& Write-On
Markers

E4.
Permanent
Identification

E5.
Lockout/
Tagout/
& Safety
Solutions

F.
Index

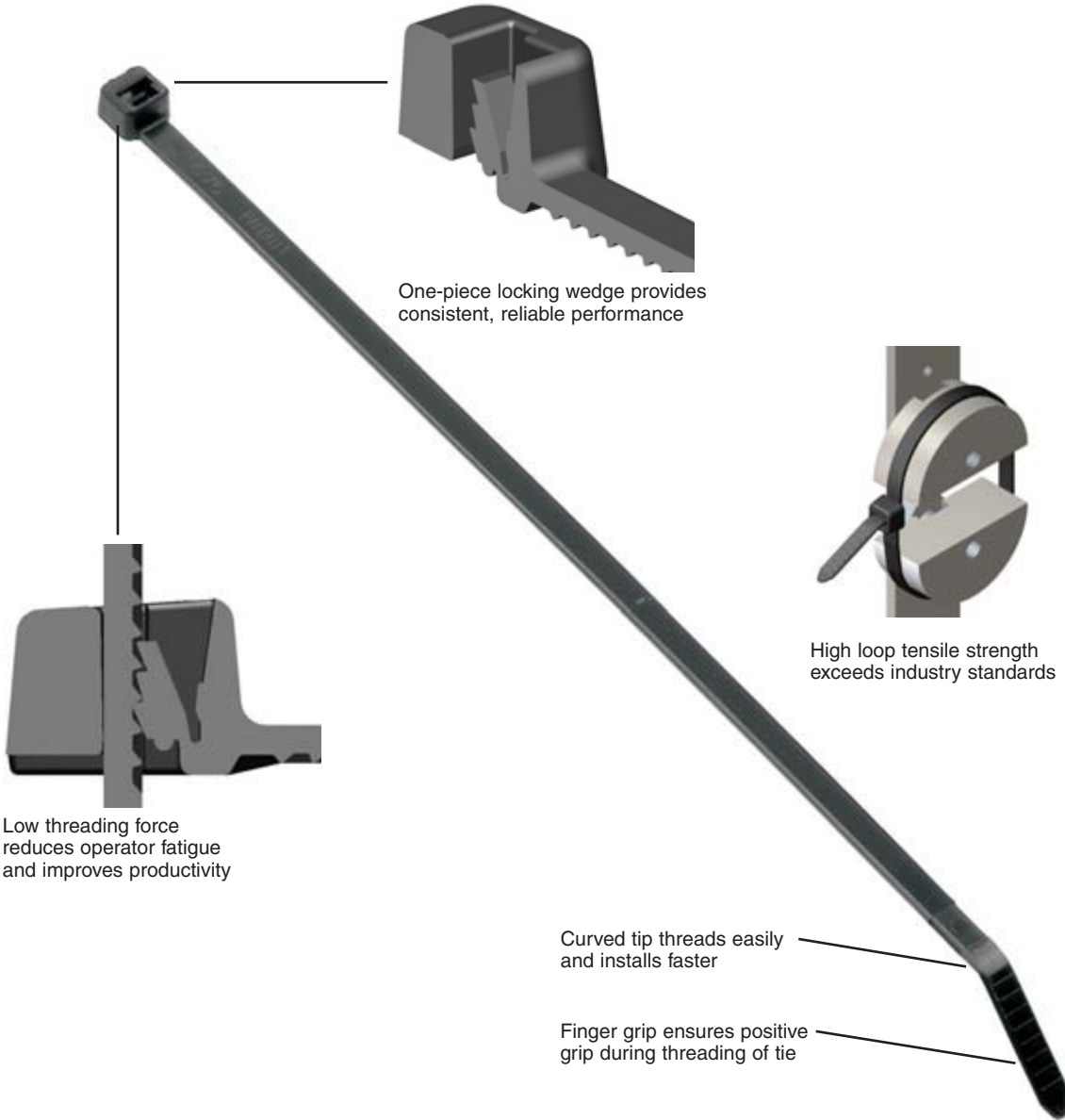

Cable tie tools speed installation and reduce total installed cost.
See pages B1.107 – B1.112.



Cable tie accessories are used to speed and simplify the mounting of wires, cables, and tubing.
See pages B2.1 – B2.29.

Selection Guide – PAN-TY® Cable Ties



| Material, Color (Suffix) | Style/Function | Part Number Prefix | Catalog Page |
|---|---------------------------|------------------------------|----------------|
| Nylon 6.6, Natural (No Suffix) | Locking Ties/Bundle | PLT | B1.8,9 |
| | Releasable Ties/Re-usable | PRT | B1.22 |
| | Clamp Ties/Mount | PLC | B1.26 |
| | Push Mount Ties/Mount | PLWP, PRWP, PLUP, PLP | B1.28,30,32,33 |
| | Marker Ties/Identify | PLF, PLM | B1.34 |
| Weather Resistant Nylon 6.6, Black (0) | Locking Ties/Bundle | PLT | B1.10,11 |
| | Releasable Ties/Re-usable | PRT | B1.23,24 |
| | Clamp Ties/Mount | PLC | B1.27 |
| | Push Mount Ties/Mount | PLWP, PRWP, PLUP, PLP | B1.29,30,31,33 |
| | Marker Ties/Identify | PLF, PLM | B1.34 |
| Heat Stabilized Nylon 6.6, Black (30) | Locking Ties/Bundle | PLT | B1.12 |
| | Releasable Ties/Re-usable | PRT | B1.23 |
| | Clamp Ties/Mount | PLC | B1.27 |
| | Push Mount Ties/Mount | PLWP, PRLWP, PRWP, PLUP, PLP | B1.29 – B1.33 |
| Heat Stabilized Weather Resistant Nylon 6.6, Black (300) | Locking Ties/Bundle | PLT | B1.13 |
| Heat Stabilized Nylon 6.6, Natural (39) | Locking Ties/Bundle | PLT | B1.12 |
| Flame Retardant Nylon 6.6, Black (60) | Locking Ties/Bundle | PLT | B1.14 |
| | Locking Ties/Bundle | PLT | B1.14 |
| Flame Retardant Nylon 6.6, Ivory (69) | Locking Ties/Bundle | PLT | B1.14 |
| | Marker Ties/Identify | PLF, PLM | B1.34 |
| Weather Resistant Nylon 12, Black (120) | Locking Ties/Bundle | PLT | B1.15 |
| Polypropylene, Green (109) | Locking Ties/Bundle | PLT | B1.16 |
| Weather Resistant Polypropylene, Black (100) | Locking Ties/Bundle | PLT | B1.17 |
| | Releasable Ties/Re-usable | PRT | B1.25 |
| HALAR [▲] , Maroon (702) TEFZEL [■] , Aqua Blue (76) | Locking Ties/Bundle | PLT | B1.18,19 |
| | Locking Ties/Bundle | PLT | B1.18,19 |
| PEEK, Translucent Brown (71) | Locking Ties/Bundle | PLT | B1.20 |
| Metal Detectable, Blue (86) | Locking Ties/Bundle | PLT | B1.21 |

▲HALAR is a registered trademark of Solvay Solexis, Inc. ■TEFZEL is a registered trademark of E.I. du Pont de Nemours and Company.

Part Number System for PAN-TY® Cable Ties

| PLT | 2 | S | — | C | — |
|---|------------|-------------------|-------------------|------------------------|----------------|
| Type | Size | Cross Section | Screw Hole Size | Package Size | Material/Color |
| PLT = Locking Tie | Approx. | SM = Subminiature | (Clamp Ties Only) | Q = 25 | See Page B1.35 |
| PRT = Releasable Tie | Maximum | M = Miniature | -S4 = #4 (M2.5) | L = 50 | |
| PLC = Locking Clamp | Bundle | I = Intermediate | -S6 = #6 (M3) | C = 100 | |
| PLF = Locking Flag | Dia. (In.) | S = Standard | -S8 = #8 (M4) | TL = 250 | |
| PLM = Locking Marker | | LH = Light-Heavy | -S10 = #10 (M5) | D = 500 | |
| PLP = Locking Push Mount | | H = Heavy | -S25 = 1/4 (M6) | M = 1000 | |
| PLWP = Locking Wing Push Mount | | EH = Extra-Heavy | | VMR = 2 reels/2500 ea. | |
| PRLWP = Releasable Ladder Wing Push Mount | | | | XMR = 2 reels/5000 ea. | |
| PRWP = Releasable Wing Push Mount | | | | | |
| PLUP = Locking Umbrella Push Mount | | | | | |

A. System Overview

UL US **UL LISTED** **CSA US** **PAN-TY® Cable Ties – Nylon 6.6**

B1. Cable Ties

- For indoor use
- Versatile cable ties can be used in countless applications
- One-piece construction for consistent performance and reliability

- Lowest threading force of any one-piece cable tie in the industry
- Curved tip is easy to pick up from flat surfaces and allows faster initial threading to speed installation
- A variety of materials and colors are available for specific applications

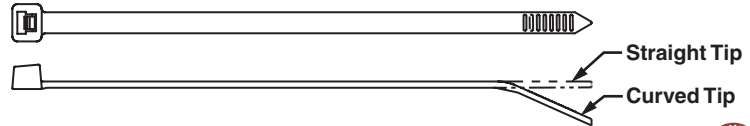

B3. Stainless Steel Ties

C1. Wiring Duct

| Part Number | Length | | Width | | Thickness | | Max. Bundle Dia. | | Min. Loop Tensile Str. | | Recommended Installation Tool | Std. Pkg. Qty. | Std. Ctn. Qty. |
|-------------|--------|----|-------|----|-----------|----|------------------|----|------------------------|---|-------------------------------|----------------|----------------|
| | In. | mm | In. | mm | In. | mm | In. | mm | Lbs. | N | | | |

C2. Surface Raceway

| | | | | | | | | | | | | | |
|-----------------------------------|-----|----|------|-----|------|----|-----|----|---|----|----------------|-----|------|
| Subminiature Cross Section | | | | | | | | | | | | | |
| PLT.6SM-C | 2.8 | 71 | .070 | 1.8 | .030 | .8 | .60 | 15 | 8 | 36 | GTS, GTSL, PTS | 100 | 1000 |

C3. Abrasion Protection

| | | | | | | | | | | | | | |
|--------------------------------|-----|-----|------|-----|------|-----|------|----|----|----|----------------------------------|-----|------|
| Miniature Cross Section | | | | | | | | | | | | | |
| PLT.7M-C | 3.1 | 79 | .090 | 2.3 | .032 | .8 | .68 | 17 | 18 | 80 | GTS, GTSL, GS2B, PTS, PPTS, STS2 | 100 | 1000 |
| PLT1M-C | 3.9 | 99 | .098 | 2.5 | .043 | 1.1 | .87 | 22 | 18 | 80 | | 100 | 1000 |
| PLT1.5M-C | 5.6 | 142 | .098 | 2.5 | .043 | 1.1 | 1.25 | 32 | 18 | 80 | | 100 | 1000 |
| PLT2M-C | 8.0 | 203 | .098 | 2.5 | .043 | 1.1 | 2.00 | 51 | 18 | 80 | | 100 | 1000 |

C4. Cable Management

| | | | | | | | | | | | | | |
|-----------------------------------|------|-----|------|-----|------|-----|------|-----|----|-----|----------------------------------|-----|------|
| Intermediate Cross Section | | | | | | | | | | | | | |
| PLT1.5I-C | 5.6 | 142 | .142 | 3.6 | .045 | 1.1 | 1.38 | 35 | 40 | 178 | GTS, GTSL, GS2B, PTS, PPTS, STS2 | 100 | 1000 |
| PLT2I-C | 8.0 | 203 | .142 | 3.6 | .045 | 1.1 | 2.00 | 51 | 40 | 178 | | 100 | 1000 |
| PLT2.5I-C | 9.7 | 246 | .145 | 3.7 | .052 | 1.3 | 2.50 | 64 | 40 | 178 | | 100 | 1000 |
| PLT3I-C | 11.4 | 290 | .145 | 3.7 | .052 | 1.3 | 3.00 | 76 | 40 | 178 | | 100 | 1000 |
| PLT4I-C | 14.5 | 368 | .145 | 3.7 | .052 | 1.3 | 4.00 | 102 | 40 | 178 | | 100 | 1000 |

D1. Terminals

| | | | | | | | | | | | | | |
|-------------------------------|------|-----|------|-----|------|-----|------|-----|----|-----|--|-----|------|
| Standard Cross Section | | | | | | | | | | | | | |
| PLT1S-C | 4.8 | 122 | .190 | 4.8 | .052 | 1.3 | 1.00 | 25 | 50 | 222 | GTS, GTSL, GS2B, GTH, GS4H, PTS, PPTS, PTH, STS2, STH2 | 100 | 1000 |
| PLT1.5S-C | 6.2 | 157 | .190 | 4.8 | .052 | 1.3 | 1.50 | 38 | 50 | 222 | | 100 | 1000 |
| PLT2S-C | 7.4 | 188 | .190 | 4.8 | .052 | 1.3 | 1.88 | 48 | 50 | 222 | | 100 | 1000 |
| PLT2.5S-C | 9.8 | 249 | .190 | 4.8 | .052 | 1.3 | 2.50 | 64 | 50 | 222 | | 100 | 1000 |
| PLT3S-C | 11.5 | 292 | .190 | 4.8 | .052 | 1.3 | 3.00 | 76 | 50 | 222 | | 100 | 1000 |
| PLT4S-C | 14.5 | 368 | .190 | 4.8 | .052 | 1.3 | 4.00 | 102 | 50 | 222 | | 100 | 1000 |
| PLT4.5S-C | 15.5 | 394 | .190 | 4.8 | .052 | 1.3 | 4.50 | 114 | 50 | 222 | | 100 | 1000 |
| PLT5S-C | 17.5 | 445 | .190 | 4.8 | .052 | 1.3 | 5.00 | 127 | 50 | 222 | | 100 | 500 |

D2. Power Connectors

D3. Grounding Connectors

| | | | | | | | | | | | | | |
|---|------|-----|------|-----|------|-----|-------|-----|-----|-----|------------------------------------|----|------|
| Light-Heavy Cross Section (Straight Tip) | | | | | | | | | | | | | |
| PLT2H-L | 8.1 | 206 | .300 | 7.6 | .075 | 1.9 | 2.00 | 51 | 120 | 534 | GTH, GS4H, GS4EH, PTH, STH2, ST3EH | 50 | 500 |
| PLT2.5H-L | 9.8 | 251 | .300 | 7.6 | .075 | 1.9 | 2.50 | 64 | 120 | 534 | | 50 | 500 |
| PLT3H-L | 11.4 | 290 | .300 | 7.6 | .075 | 1.9 | 3.00 | 76 | 120 | 534 | | 50 | 500 |
| PLT4H-L | 14.5 | 368 | .300 | 7.6 | .075 | 1.9 | 4.00 | 102 | 120 | 534 | | 50 | 500 |
| PLT6LH-L | 21.9 | 556 | .300 | 7.6 | .075 | 1.9 | 6.00 | 152 | 120 | 534 | | 50 | 500 |
| PLT7LH-L | 24.7 | 627 | .300 | 7.6 | .075 | 1.9 | 7.00 | 178 | 120 | 534 | | 50 | 500 |
| PLT8LH-L | 27.6 | 701 | .300 | 7.6 | .075 | 1.9 | 8.00 | 203 | 120 | 534 | | 50 | 500 |
| PLT9LH-L* | 30.5 | 775 | .300 | 7.6 | .075 | 1.9 | 9.00 | 229 | 120 | 534 | | 50 | 500 |
| PLT10LH-L* | 34.3 | 871 | .300 | 7.6 | .075 | 1.9 | 10.31 | 262 | 120 | 534 | | 50 | 1000 |

E1. Labeling Systems

E2. Labels

E3. Pre-Printed & Write-On Markers

E4. Permanent Identification

| | | | | | | | | | | | | | |
|---|------|------|------|-----|------|-----|-------|-----|-----|-----|------------------------------------|----|-----|
| Heavy Cross Section (Straight Tip) | | | | | | | | | | | | | |
| PLT5H-L* | 17.7 | 450 | .350 | 8.9 | .078 | 2.0 | 5.00 | 127 | 175 | 778 | GTH, GS4H, GS4EH, PTH, STH2, ST3EH | 50 | 500 |
| PLT6H-L* | 20.9 | 530 | .350 | 8.9 | .078 | 2.0 | 6.00 | 152 | 175 | 778 | | 50 | 500 |
| PLT8H-L* | 30.6 | 779 | .350 | 8.9 | .078 | 2.0 | 9.00 | 229 | 175 | 778 | | 50 | 500 |
| PLT13H-Q* | 43.3 | 1100 | .350 | 8.9 | .078 | 2.0 | 13.00 | 330 | 175 | 778 | | 25 | 500 |

E5. Lockout/Tagout & Safety Solutions

*UL Listed – meets the requirements of UL 181B-C, for use with UL non-metallic air ducts and air connectors.
Note: UL Listed for use in plenum or air handling spaces per NEC except PLT.6SM and PLT5H/6H/8H/13H.

F. Index

PAN-TY® Lashing Ties – Nylon 6.6

- For indoor use
- Typically used for heavy duty applications
- Strongest PAN-TY® Cable Tie available
- Can be used with MCEH mounting clip, see page B1.24

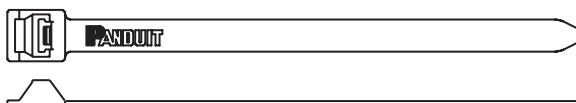

| Part Number | Length | | Width | | Thickness | | Max. Bundle Dia. | | Min. Loop Tensile Str. | | Recommended Installation Tool | Std. Pkg. Qty. | Std. Ctn. Qty. |
|----------------------------------|--------|------|-------|------|-----------|-----|------------------|-----|------------------------|------|-------------------------------|----------------|----------------|
| | In. | mm | In. | mm | In. | mm | In. | mm | Lbs. | N | | | |
| Extra-Heavy Cross Section | | | | | | | | | | | | | |
| PLT2EH-C | 9.0 | 229 | .500 | 12.7 | .075 | 1.9 | 2.00 | 51 | 250 | 1112 | GS4EH, ST3EH | 100 | 1000 |
| PLT5EH-Q | 20.1 | 511 | .500 | 12.7 | .075 | 1.9 | 5.00 | 127 | 250 | 1112 | | 25 | 250 |
| PLT6EH-Q | 22.2 | 564 | .500 | 12.7 | .075 | 1.9 | 6.00 | 152 | 250 | 1112 | | 25 | 250 |
| PLT8EH-C | 28.3 | 719 | .500 | 12.7 | .085 | 2.2 | 8.00 | 203 | 250 | 1112 | | 100 | 1000 |
| PLT10EH-C | 34.2 | 869 | .500 | 12.7 | .085 | 2.2 | 10.00 | 254 | 250 | 1112 | | 100 | 500 |
| PLT12EH-C | 40.1 | 1019 | .500 | 12.7 | .085 | 2.2 | 12.00 | 305 | 250 | 1112 | | 100 | 500 |

A. System Overview

B1. Cable Ties

B2. Cable Accessories

B3. Stainless Steel Ties

C1. Wiring Duct

C2. Surface Raceway

C3. Abrasion Protection

C4. Cable Management

D1. Terminals

D2. Power Connectors

D3. Grounding Connectors

E1. Labeling Systems

E2. Labels

E3. Pre-Printed & Write-On Markers

E4. Permanent Identification

E5. Lockout/Tagout & Safety Solutions

F. Index

A. System Overview



PAN-TY® Cable Ties – Weather Resistant Nylon 6.6

B1. Cable Ties

- Greater resistance to damage caused by ultraviolet light – indoor or outdoor use
- Versatile cable ties can be used in countless applications
- One-piece construction for consistent performance and reliability
- Lowest threading force of any one-piece cable tie in the industry
- Curved tip is easy to pick up from flat surfaces and allows faster initial threading to speed installation

B2. Cable Accessories



B3. Stainless Steel Ties

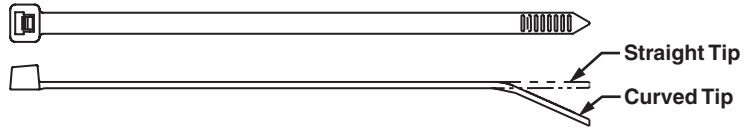

C1. Wiring Duct

C2. Surface Raceway

| Part Number | Length | | Width | | Thickness | | Max. Bundle Dia. | | Min. Loop Tensile Str. | | Recommended Installation Tool | Std. Pkg. Qty. | Std. Ctn. Qty. |
|-------------|--------|----|-------|----|-----------|----|------------------|----|------------------------|---|-------------------------------|----------------|----------------|
| | In. | mm | In. | mm | In. | mm | In. | mm | Lbs. | N | | | |

Subminiature Cross Section

| | | | | | | | | | | | | | |
|------------|-----|----|------|-----|------|----|-----|----|---|----|----------------|-----|------|
| PLT.6SM-C0 | 2.8 | 71 | .070 | 1.8 | .030 | .8 | .60 | 15 | 8 | 36 | GTS, GTSL, PTS | 100 | 1000 |
|------------|-----|----|------|-----|------|----|-----|----|---|----|----------------|-----|------|

Miniature Cross Section

| | | | | | | | | | | | | | |
|------------|-----|-----|------|-----|------|-----|------|----|----|----|----------------------------------|------|-------|
| PLT.7M-M0 | 3.1 | 79 | .090 | 2.3 | .032 | .8 | .68 | 17 | 18 | 80 | GTS, GTSL, GS2B, PTS, PPTS, STS2 | 1000 | 50000 |
| PLT1M-C0 | 3.9 | 99 | .098 | 2.5 | .043 | 1.1 | .87 | 22 | 18 | 80 | | 100 | 1000 |
| PLT1.5M-C0 | 5.6 | 142 | .098 | 2.5 | .043 | 1.1 | 1.25 | 32 | 18 | 80 | | 100 | 1000 |
| PLT2M-C0 | 8.0 | 203 | .098 | 2.5 | .043 | 1.1 | 2.00 | 51 | 18 | 80 | | 100 | 1000 |

Intermediate Cross Section

| | | | | | | | | | | | | | |
|------------|------|-----|------|-----|------|-----|------|-----|----|-----|----------------------------------|-----|------|
| PLT1.5I-C0 | 5.6 | 142 | .142 | 3.6 | .045 | 1.1 | 1.38 | 35 | 40 | 178 | GTS, GTSL, GS2B, PTS, PPTS, STS2 | 100 | 1000 |
| PLT2I-C0 | 8.0 | 203 | .142 | 3.6 | .045 | 1.1 | 2.00 | 51 | 40 | 178 | | 100 | 1000 |
| PLT2.5I-C0 | 9.7 | 246 | .145 | 3.7 | .052 | 1.3 | 2.50 | 64 | 40 | 178 | | 100 | 1000 |
| PLT3I-C0 | 11.4 | 290 | .145 | 3.7 | .052 | 1.3 | 3.00 | 76 | 40 | 178 | | 100 | 1000 |
| PLT4I-C0 | 14.5 | 368 | .145 | 3.7 | .052 | 1.3 | 4.00 | 102 | 40 | 178 | | 100 | 1000 |

Standard Cross Section

| | | | | | | | | | | | | | |
|------------|------|-----|------|-----|------|-----|------|-----|----|-----|--|-----|------|
| PLT1S-C0 | 4.8 | 122 | .190 | 4.8 | .052 | 1.3 | 1.00 | 25 | 50 | 222 | GTS, GTSL, GS2B, GTH, GS4H, PTS, PTH, PPTS, STS2, STH2 | 100 | 1000 |
| PLT1.5S-C0 | 6.2 | 157 | .190 | 4.8 | .052 | 1.3 | 1.50 | 38 | 50 | 222 | | 100 | 1000 |
| PLT2S-C0 | 7.4 | 188 | .190 | 4.8 | .052 | 1.3 | 1.88 | 48 | 50 | 222 | | 100 | 1000 |
| PLT2.5S-C0 | 9.8 | 249 | .190 | 4.8 | .052 | 1.3 | 2.50 | 64 | 50 | 222 | | 100 | 1000 |
| PLT3S-C0 | 11.5 | 292 | .190 | 4.8 | .052 | 1.3 | 3.00 | 76 | 50 | 222 | | 100 | 1000 |
| PLT4S-C0 | 14.5 | 368 | .190 | 4.8 | .052 | 1.3 | 4.00 | 102 | 50 | 222 | | 100 | 1000 |
| PLT4.5S-C0 | 15.5 | 394 | .190 | 4.8 | .052 | 1.3 | 4.50 | 114 | 50 | 222 | | 100 | 1000 |
| PLT5S-C0 | 17.5 | 445 | .190 | 4.8 | .052 | 1.3 | 5.00 | 127 | 50 | 222 | | 100 | 500 |

Light-Heavy Cross Section (Straight Tip)

| | | | | | | | | | | | | | |
|------------|------|-----|------|-----|------|-----|------|-----|-----|-----|------------------------------------|----|-----|
| PLT2H-L0 | 8.1 | 206 | .300 | 7.6 | .075 | 1.9 | 2.00 | 51 | 120 | 534 | GTH, GS4H, GS4EH, PTH, STH2, ST3EH | 50 | 500 |
| PLT2.5H-L0 | 9.8 | 251 | .300 | 7.6 | .075 | 1.9 | 2.50 | 64 | 120 | 534 | | 50 | 500 |
| PLT3H-L0 | 11.4 | 290 | .300 | 7.6 | .075 | 1.9 | 3.00 | 76 | 120 | 534 | | 50 | 500 |
| PLT4H-L0 | 14.5 | 368 | .300 | 7.6 | .075 | 1.9 | 4.00 | 102 | 120 | 534 | | 50 | 500 |
| PLT6LH-L0 | 21.9 | 556 | .300 | 7.6 | .075 | 1.9 | 6.00 | 152 | 120 | 534 | | 50 | 500 |
| PLT7LH-L0 | 24.7 | 627 | .300 | 7.6 | .075 | 1.9 | 7.00 | 178 | 120 | 534 | | 50 | 500 |
| PLT8LH-L0 | 27.6 | 701 | .300 | 7.6 | .075 | 1.9 | 8.00 | 203 | 120 | 534 | | 50 | 500 |
| PLT9LH-L0 | 30.5 | 775 | .300 | 7.6 | .075 | 1.9 | 9.00 | 229 | 120 | 534 | | 50 | 500 |

Heavy Cross Section (Straight Tip)

| | | | | | | | | | | | | | |
|-----------|------|------|------|-----|------|-----|-------|-----|-----|-----|------------------------------------|----|-----|
| PLT5H-L0 | 17.7 | 450 | .350 | 8.9 | .078 | 2.0 | 5.00 | 127 | 175 | 778 | GTH, GS4H, GS4EH, PTH, STH2, ST3EH | 50 | 500 |
| PLT6H-L0 | 20.9 | 530 | .350 | 8.9 | .078 | 2.0 | 6.00 | 152 | 175 | 778 | | 50 | 500 |
| PLT8H-L0 | 30.6 | 779 | .350 | 8.9 | .078 | 2.0 | 9.00 | 229 | 175 | 778 | | 50 | 500 |
| PLT13H-Q0 | 43.3 | 1100 | .350 | 8.9 | .078 | 2.0 | 13.00 | 330 | 175 | 778 | | 25 | 500 |

Note: UL Listed and UL Recognized except PLT.6SM and PLT2H/2.5H/3H/4H/5H/6H/8H/13H; CSA Certified except LH and H cross sections.

PAN-TY® Lashing Ties – Weather Resistant Nylon 6.6

- Greater resistance to damage caused by ultraviolet light – indoor or outdoor use
- Typically used for heavy duty applications
- Strongest PAN-TY® Cable Tie available
- Can be used with MCEH mounting clip, see page B1.24



Lashing Tie

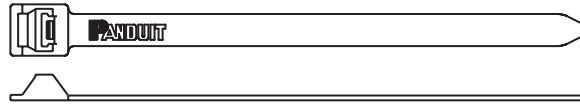

No Buckle Design

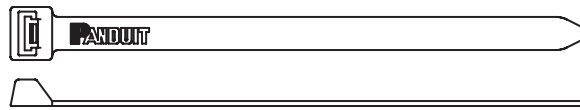

| Part Number | Length | | Width | | Thickness | | Max. Bundle Dia. | | Min. Loop Tensile Str. | | Recommended Installation Tool | Std. Pkg. Qty. | Std. Ctn. Qty. |
|---|--------|------|-------|------|-----------|-----|------------------|-----|------------------------|------|-------------------------------|----------------|----------------|
| | In. | mm | In. | mm | In. | mm | In. | mm | Lbs. | N | | | |
| Extra-Heavy Cross Section | | | | | | | | | | | | | |
| PLT2EH-Q0 | 9.0 | 229 | .500 | 12.7 | .075 | 1.9 | 2.00 | 51 | 250 | 1112 | GS4EH, ST3EH | 25 | 250 |
| PLT5EH-Q0 | 20.1 | 511 | .500 | 12.7 | .075 | 1.9 | 5.00 | 127 | 250 | 1112 | | 25 | 250 |
| PLT6EH-Q0 | 22.2 | 564 | .500 | 12.7 | .075 | 1.9 | 6.00 | 152 | 250 | 1112 | | 25 | 250 |
| PLT8EH-Q0 | 28.3 | 719 | .500 | 12.7 | .085 | 2.2 | 8.00 | 203 | 250 | 1112 | | 25 | 250 |
| PLT10EH-Q0 | 34.2 | 869 | .500 | 12.7 | .085 | 2.2 | 10.00 | 254 | 250 | 1112 | | 25 | 250 |
| PLT12EH-Q0 | 40.1 | 1019 | .500 | 12.7 | .085 | 2.2 | 12.00 | 305 | 250 | 1112 | | 25 | 250 |
| Extra-Heavy Cross Section (No Buckle Design) | | | | | | | | | | | | | |
| PLT3EH-NB-C0 | 12.2 | 310 | .500 | 12.7 | .075 | 1.9 | 3.30 | 84 | 250 | 1112 | GS4EH, ST3EH | 100 | 1000 |
| PLT5EH-NB-C0 | 19.8 | 503 | .500 | 12.7 | .075 | 1.9 | 5.00 | 127 | 250 | 1112 | | 100 | 1000 |
| PLT6EH-NB-C0 | 21.8 | 554 | .500 | 12.7 | .075 | 1.9 | 6.00 | 152 | 250 | 1112 | | 100 | 1000 |

A. System Overview

B1. Cable Ties

B2. Cable Accessories

B3. Stainless Steel Ties

C1. Wiring Duct

C2. Surface Raceway

C3. Abrasion Protection

C4. Cable Management

D1. Terminals

D2. Power Connectors

D3. Grounding Connectors

E1. Labeling Systems

E2. Labels

E3. Pre-Printed & Write-On Markers

E4. Permanent Identification

E5. Lockout/Tagout & Safety Solutions

F. Index

A. System Overview

B1. Cable Ties

B2. Cable Accessories

B3. Stainless Steel Ties

C1. Wiring Duct

C2. Surface Raceway

C3. Abrasion Protection

C4. Cable Management

D1. Terminals

D2. Power Connectors

D3. Grounding Connectors

E1. Labeling Systems

E2. Labels

E3. Pre-Printed & Write-On Markers

E4. Permanent Identification

E5. Lockout/Tagout & Safety Solutions

F. Index

UL **UL** **SP** **PAN-TY**® Cable Ties – Heat Stabilized Nylon 6.6

- For high temperature applications up to 239°F (115°C) – indoor use
- One-piece construction for consistent performance and reliability
- Lowest threading force of any one-piece cable tie in the industry
- Curved tip is easy to pick up from flat surfaces and allows faster initial threading to speed installation

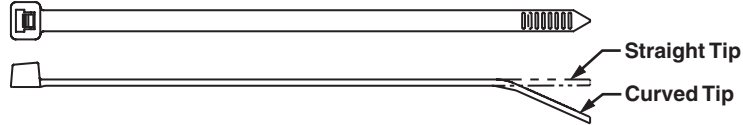

| Part Number | Length | | Width | | Thickness | | Max. Bundle Dia. | | Min. Loop Tensile Str. | | Recommended Installation Tool | Std. Pkg. Qty. | Std. Ctn. Qty. | |
|---|--------|-----|-------|-----|-----------|-----|------------------|-----|------------------------|-----|--|------------------------------------|----------------|------|
| | In. | mm | In. | mm | In. | mm | In. | mm | Lbs. | N | | | | |
| Subminiature Cross Section | | | | | | | | | | | | | | |
| PLT.6SM-M30 | 2.8 | 71 | .070 | 1.8 | .030 | .8 | .60 | 15 | 8 | 36 | GTS, GTSL, PTS | 1000 | 50000 | |
| Miniature Cross Section | | | | | | | | | | | | | | |
| PLT.7M-M30 | 3.1 | 79 | .090 | 2.3 | .032 | .8 | .68 | 17 | 18 | 80 | GTS, GTSL, GS2B, PTS, PPTS, STS2 | 1000 | 50000 | |
| PLT1M-C30 | 3.9 | 99 | .098 | 2.5 | .043 | 1.1 | .87 | 22 | 18 | 80 | | 100 | 1000 | |
| PLT1.5M-M30 | 5.6 | 142 | .098 | 2.5 | .043 | 1.1 | 1.25 | 32 | 18 | 80 | | 1000 | 50000 | |
| PLT2M-M30 | 8.0 | 203 | .098 | 2.5 | .043 | 1.1 | 2.00 | 51 | 18 | 80 | | 1000 | 25000 | |
| Intermediate Cross Section | | | | | | | | | | | | | | |
| PLT1.5I-C30 | 5.6 | 142 | .142 | 3.6 | .045 | 1.1 | 1.38 | 35 | 40 | 178 | GTS, GTSL, GS2B, PTS, PPTS, STS2 | 100 | 1000 | |
| PLT2I-C30 | 8.0 | 203 | .142 | 3.6 | .045 | 1.1 | 2.00 | 51 | 40 | 178 | | 100 | 1000 | |
| PLT3I-M30 | 11.4 | 290 | .145 | 3.7 | .052 | 1.3 | 3.00 | 76 | 40 | 178 | | 1000 | 10000 | |
| PLT4I-M30 | 14.5 | 368 | .145 | 3.7 | .052 | 1.3 | 4.00 | 102 | 40 | 178 | | 1000 | 10000 | |
| Standard Cross Section | | | | | | | | | | | | | | |
| PLT1S-M30 | 4.8 | 122 | .190 | 4.8 | .052 | 1.3 | 1.00 | 25 | 50 | 222 | GTS, GTSL, GS2B, GTH, GS4H, PTS, PTH, PPTS, STS2, STH2 | 1000 | 10000 | |
| PLT1.5S-M30 | 6.2 | 157 | .190 | 4.8 | .052 | 1.3 | 1.50 | 38 | 50 | 222 | | 1000 | 10000 | |
| PLT2S-C30 | 7.4 | 188 | .190 | 4.8 | .052 | 1.3 | 1.88 | 48 | 50 | 222 | | 100 | 1000 | |
| PLT2S-M39* | 7.4 | 188 | .190 | 4.8 | .052 | 1.3 | 1.88 | 48 | 50 | 222 | | 1000 | 10000 | |
| PLT2.5S-M30 | 9.8 | 249 | .190 | 4.8 | .052 | 1.3 | 2.50 | 64 | 50 | 222 | | 1000 | 10000 | |
| PLT3S-C30 | 11.5 | 292 | .190 | 4.8 | .052 | 1.3 | 3.00 | 76 | 50 | 222 | | 100 | 1000 | |
| PLT4S-C30 | 14.5 | 368 | .190 | 4.8 | .052 | 1.3 | 4.00 | 102 | 50 | 222 | | 100 | 1000 | |
| PLT5S-M30 | 17.5 | 445 | .190 | 4.8 | .052 | 1.3 | 5.00 | 127 | 50 | 222 | | 1000 | 5000 | |
| Light-Heavy Cross Section (Straight Tip) | | | | | | | | | | | | | | |
| PLT2H-TL30 | 8.1 | 206 | .300 | 7.6 | .075 | 1.9 | 2.00 | 51 | 120 | 534 | | GTH, GS4H, GS4EH, PTH, STH2, ST3EH | 250 | 2500 |
| PLT3H-TL30 | 11.4 | 290 | .300 | 7.6 | .075 | 1.9 | 3.00 | 76 | 120 | 534 | 250 | | 2500 | |
| PLT4H-TL30 | 14.5 | 368 | .300 | 7.6 | .075 | 1.9 | 4.00 | 102 | 120 | 534 | 250 | | 2500 | |
| PLT7LH-C30 | 24.7 | 627 | .300 | 7.6 | .075 | 1.9 | 7.00 | 178 | 120 | 534 | 100 | | 2000 | |
| PLT9LH-C30 | 30.5 | 775 | .300 | 7.6 | .075 | 1.9 | 9.00 | 229 | 120 | 534 | 100 | | 1000 | |
| Heavy Cross Section (Straight Tip) | | | | | | | | | | | | | | |
| PLT5H-C30 | 17.7 | 450 | .350 | 8.9 | .078 | 2.0 | 5.00 | 127 | 175 | 778 | GTH, GS4H, GS4EH, PTH, STH2, ST3EH | 100 | 2000 | |
| PLT6H-C30 | 20.9 | 530 | .350 | 8.9 | .078 | 2.0 | 6.00 | 152 | 175 | 778 | | 100 | 2000 | |
| PLT8H-C30 | 30.6 | 779 | .350 | 8.9 | .078 | 2.0 | 9.00 | 229 | 175 | 778 | | 100 | 1500 | |

*Natural heat stabilized material (39).
Note: UL Listed except PLT.6SM and PLT5H/6H/8H.



PAN-TY® Cable Ties – Heat Stabilized Weather Resistant Nylon 6.6

- Greater resistance to damage caused by ultraviolet light and for high temperature applications up to 212°F (100°C) – indoor or outdoor use
- One-piece construction for consistent performance and reliability

- Lowest threading force of any one-piece cable tie in the industry
- Curved tip is easy to pick up from flat surfaces and allows faster initial threading to speed installation

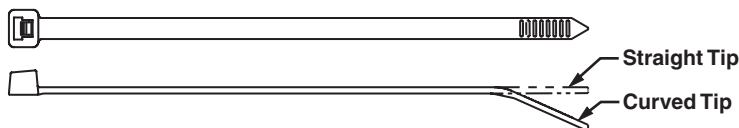

| Part Number | Length | | Width | | Thickness | | Max. Bundle Dia. | | Min. Loop Tensile Str. | | Recommended Installation Tool | Std. Pkg. Qty. | Std. Ctn. Qty. |
|---|--------|-----|-------|-----|-----------|-----|------------------|-----|------------------------|-----|--|----------------|----------------|
| | In. | mm | In. | mm | In. | mm | In. | mm | Lbs. | N | | | |
| Miniature Cross Section | | | | | | | | | | | | | |
| PLT1M-M300 | 3.9 | 99 | .098 | 2.5 | .035 | .9 | .87 | 22 | 18 | 80 | GTS, GTSL, GS2B, PTS, PPTS, STS2 | 1000 | 50000 |
| Intermediate Cross Section | | | | | | | | | | | | | |
| PLT1.5I-M300 | 5.6 | 142 | .142 | 3.6 | .045 | 1.1 | 1.38 | 35 | 40 | 178 | GTS, GTSL, GS2B, PTS, PPTS, STS2 | 1000 | 25000 |
| PLT2I-M300 | 8.0 | 203 | .142 | 3.6 | .045 | 1.1 | 2.00 | 51 | 40 | 178 | | 1000 | 25000 |
| Standard Cross Section | | | | | | | | | | | | | |
| PLT1S-M300 | 4.8 | 122 | .190 | 4.8 | .052 | 1.3 | 1.00 | 25 | 50 | 222 | GTS, GTSL, GS2B, GTH, GS4H, PTS, PTH, PPTS, STS2, STH2 | 1000 | 10000 |
| PLT2S-M300 | 7.4 | 188 | .190 | 4.8 | .052 | 1.3 | 1.88 | 48 | 50 | 222 | | 1000 | 10000 |
| PLT4S-M300 | 14.5 | 368 | .190 | 4.8 | .052 | 1.3 | 4.00 | 102 | 50 | 222 | | 1000 | 5000 |
| Light-Heavy Cross Section (Straight Tip) | | | | | | | | | | | | | |
| PLT2H-TL300 | 8.4 | 213 | .300 | 7.6 | .075 | 1.9 | 2.00 | 51 | 120 | 534 | GTH, GS4H, GS4EH, PTH, STH2, ST3EH | 250 | 2500 |
| PLT4H-TL300 | 14.5 | 368 | .300 | 7.6 | .075 | 1.9 | 4.00 | 102 | 120 | 534 | | 250 | 2500 |

A. System Overview

B1. Cable Ties

B2. Cable Accessories

B3. Stainless Steel Ties

C1. Wiring Duct

C2. Surface Raceway

C3. Abrasion Protection

C4. Cable Management

D1. Terminals

D2. Power Connectors

D3. Grounding Connectors

E1. Labeling Systems

E2. Labels

E3. Pre-Printed & Write-On Markers

E4. Permanent Identification

E5. Lockout/Tagout & Safety Solutions

F. Index

A. System Overview

B1. Cable Ties

B2. Cable Accessories

B3. Stainless Steel Ties

C1. Wiring Duct

C2. Surface Raceway

C3. Abrasion Protection

C4. Cable Management

D1. Terminals

D2. Power Connectors

D3. Grounding Connectors

E1. Labeling Systems

E2. Labels

E3. Pre-Printed & Write-On Markers

E4. Permanent Identification

E5. Lockout/Tagout & Safety Solutions

F. Index

UL US C_{UL} US PAN-TY® Cable Ties – Flame Retardant Nylon 6.6

- Flammability rating of UL 94V-0 – indoor use
- One-piece construction for consistent performance and reliability
- Lowest threading force of any one-piece cable tie in the industry
- Curved tip is easy to pick up from flat surfaces and allows faster initial threading to speed installation

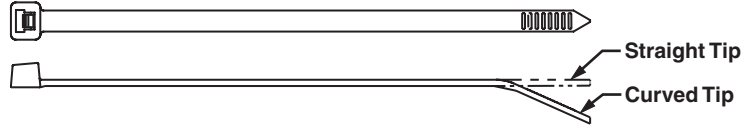

| Part Number | Length | | Width | | Thickness | | Max. Bundle Dia. | | Min. Loop Tensile Str. | | Recommended Installation Tool | Std. Pkg. Qty. | Std. Ctn. Qty. |
|---|--------|-----|-------|-----|-----------|-----|------------------|-----|------------------------|-----|--|----------------|----------------|
| | In. | mm | In. | mm | In. | mm | In. | mm | Lbs. | N | | | |
| Miniature Cross Section | | | | | | | | | | | | | |
| PLT1M-M60* | 4.0 | 102 | .098 | 2.5 | .043 | 1.1 | .87 | 22 | 18 | 80 | GTS, GTSL, GS2B, PTS, PPTS, STS2 | 1000 | 25000 |
| PLT1M-M69 | 4.0 | 102 | .098 | 2.5 | .043 | 1.1 | .87 | 22 | 18 | 80 | | 1000 | 25000 |
| PLT2M-M69 | 8.0 | 203 | .098 | 2.5 | .043 | 1.1 | 2.00 | 51 | 18 | 80 | | 1000 | 25000 |
| Intermediate Cross Section | | | | | | | | | | | | | |
| PLT1.5I-M69 | 5.6 | 142 | .142 | 3.6 | .044 | 1.1 | 1.38 | 35 | 40 | 178 | GTS, GTSL, GS2B, PTS, PPTS, STS2 | 1000 | 25000 |
| PLT2I-M69 | 8.0 | 203 | .142 | 3.6 | .044 | 1.1 | 2.00 | 51 | 40 | 178 | | 1000 | 25000 |
| Standard Cross Section | | | | | | | | | | | | | |
| PLT2S-M60* | 7.4 | 188 | .190 | 4.8 | .052 | 1.3 | 1.88 | 48 | 50 | 222 | GTS, GTSL, GS2B, GTH, GS4H, PTS, PTH, PPTS, STS2, STH2 | 1000 | 10000 |
| PLT2S-M69 | 7.4 | 188 | .190 | 4.8 | .052 | 1.3 | 1.88 | 48 | 50 | 222 | | 1000 | 10000 |
| PLT4S-M69 | 14.5 | 368 | .190 | 4.8 | .052 | 1.3 | 4.00 | 102 | 50 | 222 | | 1000 | 5000 |
| Light-Heavy Cross Section (Straight Tip) | | | | | | | | | | | | | |
| PLT4H-TL69 | 14.6 | 371 | .300 | 7.6 | .075 | 1.9 | 4.00 | 102 | 120 | 534 | GTH, GS4H, GS4EH, PTH, STH2, ST3EH | 250 | 2500 |

*Black flame retardant material (60).
Note: UL Recognized and CSA Certified except 60 material.

Cable Tie Mounts – Flame Retardant Nylon 6.6

- Flammability rating of UL 94V-0 – indoor use
- Unique cradle design provides maximum stability for the cable bundle
- Low profile design keeps bundle close to mounting surface

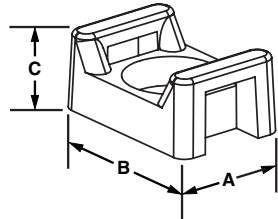

| Part Number | Used With Cable Ties* | Length B | | Width A | | Height C | | Counterbore Diameter | | Mounting Method | Std. Pkg. Qty. | Std. Ctn. Qty. |
|-------------------|-----------------------|----------|------|---------|------|----------|-----|----------------------|-----|-----------------|----------------|----------------|
| | | In. | mm | In. | mm | In. | mm | In. | mm | | | |
| TM1S4-M69 | M | .51 | 13.0 | .32 | 8.0 | .23 | 5.8 | .23 | 5.7 | #4 (M2.5) screw | 1000 | 5000 |
| TM1S6-M69 | | .51 | 13.0 | .32 | 8.0 | .23 | 5.8 | .28 | 7.0 | #6 (M3) screw | 1000 | 5000 |
| TM2S6-M69 | M, I, S | .63 | 16.0 | .43 | 10.8 | .28 | 7.0 | .29 | 7.1 | #6 (M3) screw | 1000 | 5000 |
| TM2S8-M69 | | .63 | 16.0 | .43 | 10.8 | .28 | 7.0 | .33 | 8.4 | #8 (M4) screw | 1000 | 5000 |
| TM3S8-C69 | M, I, S, LH | .86 | 21.8 | .62 | 15.5 | .38 | 9.5 | .32 | 8.1 | #8 (M4) screw | 100 | 500 |
| TM3S10-M69 | | .86 | 21.8 | .62 | 15.8 | .38 | 9.5 | .38 | 9.7 | #10 (M5) screw | 1000 | 5000 |

*Cable tie cross section sizes: M = Miniature, I = Intermediate, S = Standard and LH = Light-Heavy.

PAN-TY® Cable Ties – Weather Resistant Nylon 12

- For high moisture, corrosive (zinc chloride and dilute acids), and low temperature indoor or outdoor applications
- Cable tie of choice for making attachments to galvanized surfaces
- One-piece construction for consistent performance and reliability
- Lowest threading force of any one-piece cable tie in the industry
- Curved tip is easy to pick up from flat surfaces and allows faster initial threading to speed installation

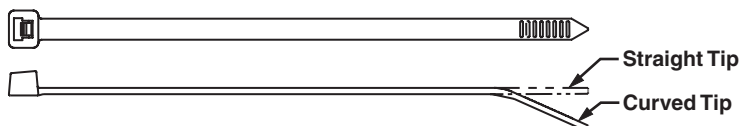

| Part Number | Length | | Width | | Thickness | | Max. Bundle Dia. | | Min. Loop Tensile Str. | | Recommended Installation Tool | Std. Pkg. Qty. | Std. Ctn. Qty. |
|---|--------|-----|-------|-----|-----------|-----|------------------|-----|------------------------|-----|--|----------------|----------------|
| | In. | mm | In. | mm | In. | mm | In. | mm | Lbs. | N | | | |
| Intermediate Cross Section | | | | | | | | | | | | | |
| PLT1.5I-M120 | 5.6 | 142 | .142 | 3.6 | .045 | 1.1 | 1.38 | 35 | 25 | 111 | GTS, GTSL, GS2B, PTS, PPTS, STS2 | 1000 | 25000 |
| Standard Cross Section | | | | | | | | | | | | | |
| PLT2S-M120 | 7.4 | 188 | .190 | 4.8 | .052 | 1.3 | 1.88 | 48 | 40 | 178 | GTS, GTSL, GS2B, GTH, GS4H, PTS, PTH, PPTS, STS2, STH2 | 1000 | 10000 |
| PLT4S-M120 | 14.5 | 368 | .190 | 4.8 | .052 | 1.3 | 4.00 | 102 | 40 | 178 | | 1000 | 5000 |
| Light-Heavy Cross Section (Straight Tip) | | | | | | | | | | | | | |
| PLT4H-TL120 | 14.5 | 368 | .300 | 7.6 | .075 | 1.9 | 4.00 | 102 | 90 | 400 | GTH, GTSL, GS4H, GS4EH, PTH, STH2, ST3EH | 250 | 2500 |
| PLT8LH-C120 | 27.6 | 701 | .300 | 7.6 | .075 | 1.9 | 8.00 | 203 | 90 | 400 | | 100 | 2000 |

A.
System
Overview

B1.
Cable Ties

B2.
Cable
Accessories

B3.
Stainless
Steel Ties

C1.
Wiring
Duct

C2.
Surface
Raceway

C3.
Abrasion
Protection

C4.
Cable
Management

D1.
Terminals

D2.
Power
Connectors

D3.
Grounding
Connectors

E1.
Labeling
Systems

E2.
Labels

E3.
Pre-Printed
& Write-On
Markers

E4.
Permanent
Identification

E5.
Lockout/
Tagout
& Safety
Solutions

F.
Index

A.
System
Overview

PAN-TY® Cable Ties – Polypropylene – Distinctive Green Color

B1.
Cable Ties

- For chemical resistance where high loop tensile strength is not required especially in the presence of hydrochloric acid, salts, and bases
- For indoor use
- Material requires lowering the tool setting (see table below)
- One-piece construction for consistent performance and reliability
- Lowest threading force of any one-piece cable tie in the industry
- Curved tip is easy to pick up from flat surfaces and allows faster initial threading to speed installation

B2.
Cable
Accessories



B3.
Stainless
Steel Ties

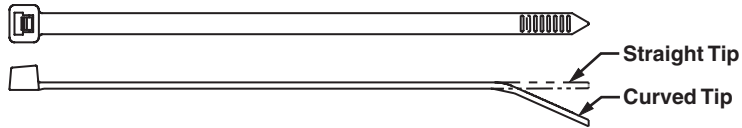

C1.
Wiring
Duct

C2.
Surface
Raceway

| Part Number | Length | | Width | | Thickness | | Max. Bundle Dia. | | Min. Loop Tensile Str. | | Recommended Installation Tool | Tool Setting | Std. Pkg. Qty. | Std. Ctn. Qty. |
|-------------|--------|----|-------|----|-----------|----|------------------|----|------------------------|---|-------------------------------|--------------|----------------|----------------|
| | In. | mm | In. | mm | In. | mm | In. | mm | Lbs. | N | | | | |

C3.
Abrasion
Protection

Miniature Cross Section

| | | | | | | | | | | | | | | |
|-------------------|-----|----|------|-----|------|-----|-----|----|----|----|----------------------------------|---|------|-------|
| PLT1M-M109 | 3.9 | 99 | .098 | 2.5 | .043 | 1.1 | .87 | 22 | 11 | 49 | GTS, GTSL, GS2B, PTS, PPTS, STS2 | 2 | 1000 | 50000 |
|-------------------|-----|----|------|-----|------|-----|-----|----|----|----|----------------------------------|---|------|-------|

Intermediate Cross Section

| | | | | | | | | | | | | | | |
|---------------------|-----|-----|------|-----|------|-----|------|----|----|----|----------------------------------|---|------|-------|
| PLT1.5I-M109 | 5.6 | 142 | .142 | 3.6 | .045 | 1.1 | 1.38 | 35 | 18 | 80 | GTS, GTSL, GS2B, PTS, PPTS, STS2 | 3 | 1000 | 25000 |
|---------------------|-----|-----|------|-----|------|-----|------|----|----|----|----------------------------------|---|------|-------|

C4.
Cable
Management

Standard Cross Section

| | | | | | | | | | | | | | | |
|-------------------|------|-----|------|-----|------|-----|------|-----|----|-----|--|---|------|-------|
| PLT2S-M109 | 7.4 | 188 | .190 | 4.8 | .052 | 1.3 | 1.88 | 48 | 30 | 133 | GTS, GTSL, GS2B, GTH, GS4H, PTS, PTH, PPTS, STS2, STH2 | 5 (GTS, GS2B, PTS, PPTS) 2 (GTH, GS4H) | 1000 | 10000 |
| PLT3S-M109 | 11.5 | 292 | .190 | 4.8 | .052 | 1.3 | 3.00 | 76 | 30 | 133 | | | 1000 | 10000 |
| PLT4S-M109 | 14.5 | 368 | .190 | 4.8 | .052 | 1.3 | 4.00 | 102 | 30 | 133 | | | 1000 | 5000 |

D1.
Terminals

Light-Heavy Cross Section (Straight Tip)

| | | | | | | | | | | | | | | |
|--------------------|------|-----|------|-----|------|-----|------|-----|----|-----|------------------------------------|---|-----|------|
| PLT2H-TL109 | 8.1 | 206 | .300 | 7.6 | .075 | 1.9 | 2.00 | 51 | 50 | 222 | GTH, GS4H, GS4EH, PTH, STH2, ST3EH | 5 | 250 | 2500 |
| PLT3H-TL109 | 11.4 | 290 | .300 | 7.6 | .075 | 1.9 | 3.00 | 76 | 50 | 222 | | 5 | 250 | 2500 |
| PLT4H-TL109 | 14.5 | 368 | .300 | 7.6 | .075 | 1.9 | 4.00 | 102 | 50 | 222 | | 5 | 250 | 2500 |

D2.
Power
Connectors

D3.
Grounding
Connectors

E1.
Labeling
Systems

E2.
Labels

E3.
Pre-Printed
& Write-On
Markers

E4.
Permanent
Identification

E5.
Lockout/
Tagout
& Safety
Solutions

F.
Index

PAN-TY® Cable Ties – Weather Resistant Polypropylene

- For chemical resistance where high loop tensile strength is not required especially in the presence of hydrochloric acid, salts, and bases
- Greater resistance to damage caused by ultraviolet light – indoor or outdoor use
- Material requires lowering the tool setting (see table below)
- One-piece construction for consistent performance and reliability
- Lowest threading force of any one-piece cable tie in the industry
- Curved tip is easy to pick up from flat surfaces and allows faster initial threading to speed installation

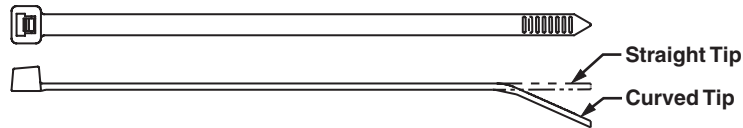

| Part Number | Length | | Width | | Thickness | | Max. Bundle Dia. | | Min. Loop Tensile Str. | | Recommended Installation Tool | Tool Setting | Std. Pkg. Qty. | Std. Ctn. Qty. |
|---|--------|-----|-------|-----|-----------|-----|------------------|-----|------------------------|-----|--|---|----------------|----------------|
| | In. | mm | In. | mm | In. | mm | In. | mm | Lbs. | N | | | | |
| Miniature Cross Section | | | | | | | | | | | | | | |
| PLT1M-M100 | 3.9 | 99 | .098 | 2.5 | .043 | 1.1 | .87 | 22 | 11 | 49 | GTS, GTSL, GS2B, PTS, PPTS, STS2 | 2 | 1000 | 50000 |
| Intermediate Cross Section | | | | | | | | | | | | | | |
| PLT1.5I-M100 | 5.6 | 142 | .142 | 3.6 | .045 | 1.1 | 1.38 | 35 | 18 | 80 | GTS, GTSL, GS2B, PTS, PPTS, STS2 | 3 | 1000 | 25000 |
| Standard Cross Section | | | | | | | | | | | | | | |
| PLT2S-M100 | 7.4 | 188 | .190 | 4.8 | .052 | 1.3 | 1.88 | 48 | 30 | 133 | GTS, GTSL, GS2B, GTH, GS4H, PTS, PTS, PPTS, STS2, STH2 | 5 (GTS, GS2B, PTS, PPTS) 2 (GTH, GS4H) | 1000 | 10000 |
| PLT3S-M100 | 11.5 | 292 | .190 | 4.8 | .052 | 1.3 | 3.00 | 76 | 30 | 133 | | | 1000 | 10000 |
| PLT4S-M100 | 14.5 | 368 | .190 | 4.8 | .052 | 1.3 | 4.00 | 102 | 30 | 133 | | | 1000 | 5000 |
| Light-Heavy Cross Section (Straight Tip) | | | | | | | | | | | | | | |
| PLT2H-TL100 | 8.1 | 206 | .300 | 7.6 | .075 | 1.9 | 2.00 | 51 | 50 | 222 | GTH, GS4H, GS4EH, PTH, STH2, ST3EH | 5 | 250 | 2500 |
| PLT3H-TL100 | 11.4 | 290 | .300 | 7.6 | .075 | 1.9 | 3.00 | 76 | 50 | 222 | | 5 | 250 | 2500 |
| PLT4H-TL100 | 14.5 | 368 | .300 | 7.6 | .075 | 1.9 | 4.00 | 102 | 50 | 222 | | 5 | 250 | 2500 |

A.
System
Overview

B1.
Cable Ties

B2.
Cable
Accessories

B3.
Stainless
Steel Ties

C1.
Wiring
Duct

C2.
Surface
Raceway

C3.
Abrasion
Protection

C4.
Cable
Management

D1.
Terminals

D2.
Power
Connectors

D3.
Grounding
Connectors

E1.
Labeling
Systems

E2.
Labels

E3.
Pre-Printed
& Write-On
Markers

E4.
Permanent
Identification

E5.
Lockout/
Tagout
& Safety
Solutions

F.
Index

A.
System
Overview



PAN-TY® Cable Ties – HALAR® – Distinctive Maroon Color

B1.
Cable Ties

- UL Listed for use in plenum or air handling spaces per NEC, Section 300-22 (C) and (D)
- Low smoke density and excellent flammability rating of UL 94V-0
- Commonly accepted solution for bundling qualified cable without conduit in air handling space applications

- Greater resistance to damage caused by ultraviolet light – indoor or outdoor use
- One-piece construction for consistent performance and reliability
- Lowest threading force of any one-piece cable tie in the industry
- Curved tip is easy to pick up from flat surfaces and allows faster initial threading to speed installation

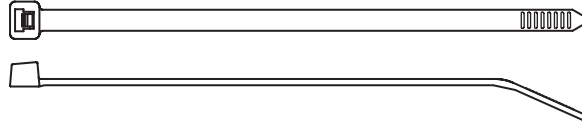

B2.
Cable
Accessories

C1.
Wiring
Duct

C2.
Surface
Raceway

C3.
Abrasion
Protection

C4.
Cable
Management

D1.
Terminals

D2.
Power
Connectors

D3.
Grounding
Connectors

E1.
Labeling
Systems

E2.
Labels

E3.
Pre-Printed
& Write-On
Markers

E4.
Permanent
Identification

E5.
Lockout/
Tagout/
& Safety
Solutions

F.
Index

| Part Number | Length | | Width | | Thickness | | Max. Bundle Dia. | | Min. Loop Tensile Str. | | Recommended Installation Tool | Std. Pkg. Qty. | Std. Ctn. Qty. |
|--------------------------------|--------|-----|-------|-----|-----------|-----|------------------|----|------------------------|-----|--|----------------|----------------|
| | In. | mm | In. | mm | In. | mm | In. | mm | Lbs. | N | | | |
| Miniature Cross Section | | | | | | | | | | | | | |
| PLT1M-C702Y | 4.0 | 102 | .098 | 2.5 | .043 | 1.1 | .87 | 22 | 18 | 80 | GTS, GTSL, GS2B, PTS, PPTS, STS2 | 100 | 1000 |
| Standard Cross Section | | | | | | | | | | | | | |
| PLT2S-C702Y | 7.4 | 188 | .190 | 4.8 | .055 | 1.4 | 1.88 | 48 | 50 | 222 | GTS, GTSL, GS2B, GTH, GS4H, PTS, PTH, PPTS, STS2, STH2 | 100 | 1000 |
| PLT3S-C702Y | 11.6 | 295 | .190 | 4.8 | .055 | 1.4 | 3.00 | 76 | 50 | 222 | | 100 | 1000 |

*HALAR is a registered trademark of Solvay Solexis, Inc.



PAN-TY® Cable Ties – TEFZEL® – Distinctive Aqua Blue Color

- Ideal for applications requiring resistance to environmental stresses such as chemical attack, gamma radiation, ultraviolet radiation and extreme high and low temperatures
- Ideal for use in nuclear power facilities and chemical processing plants and meets the requirements of IEEE 383
- Low smoke density and excellent flammability rating of UL 94V-0

- One-piece construction for consistent performance and reliability
- Lowest threading force of any one-piece cable tie in the industry
- Curved tip is easy to pick up from flat surfaces and allows faster initial threading to speed installation
- For indoor or outdoor use

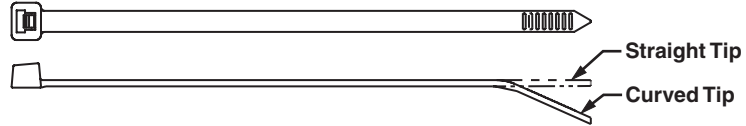
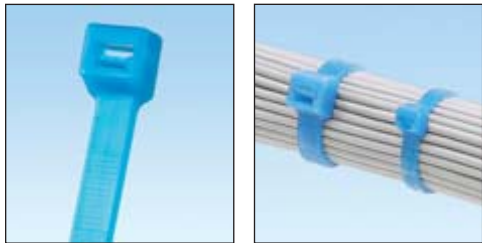

| Part Number | Length | | Width | | Thickness | | Max. Bundle Dia. | | Min. Loop Tensile Str. | | Recommended Installation Tool | Std. Pkg. Qty. | Std. Ctn. Qty. |
|---|--------|-----|-------|-----|-----------|-----|------------------|-----|------------------------|-----|--|----------------|----------------|
| | In. | mm | In. | mm | In. | mm | In. | mm | Lbs. | N | | | |
| Miniature Cross Section | | | | | | | | | | | | | |
| PLT1M-C76 | 4.0 | 102 | .098 | 2.5 | .043 | 1.1 | .87 | 22 | 18 | 80 | GTS, GTSL, GS2B, PTS, PPTS, STS2 | 100 | 1000 |
| Intermediate Cross Section | | | | | | | | | | | | | |
| PLT2I-C76 | 8.0 | 203 | .135 | 3.4 | .045 | 1.1 | 2.00 | 51 | 25 | 111 | GTS, GTSL, GS2B, PTS, PPTS, STS2 | 100 | 1000 |
| Standard Cross Section | | | | | | | | | | | | | |
| PLT2S-C76 | 7.4 | 188 | .190 | 4.8 | .055 | 1.4 | 1.88 | 48 | 50 | 222 | GTS, GTSL, GS2B, GTH, GS4H, PTS, PTH, PPTS, STS2, STH2 | 100 | 1000 |
| PLT3S-C76 | 11.6 | 295 | .190 | 4.8 | .059 | 1.5 | 3.00 | 76 | 50 | 222 | | 100 | 1000 |
| PLT4S-C76 | 14.6 | 371 | .190 | 4.8 | .059 | 1.5 | 4.00 | 102 | 50 | 222 | | 100 | 1000 |
| Light-Heavy Cross Section (Straight Tip) | | | | | | | | | | | | | |
| PLT3H-L76 | 11.5 | 292 | .300 | 7.6 | .075 | 1.9 | 3.00 | 78 | 120 | 534 | GTH, GS4H, GS4EH, PTH, STH2, ST3EH | 50 | 500 |
| PLT4H-L76 | 14.6 | 371 | .300 | 7.6 | .075 | 1.9 | 4.00 | 102 | 120 | 534 | | 50 | 500 |

TEFZEL is a registered trademark of E. I. du Pont de Nemours and Company.

PAN-TY® Cable Tie Mounts – TEFZEL®

- Flammability rating of UL 94V-0 – indoor use
- Unique cradle design provides maximum stability for the cable bundle

- Low profile design keeps bundle close to mounting surface

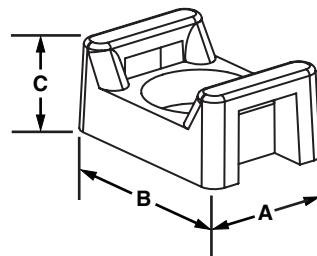

| Part Number | Used With Cable Ties* | Length B | | Width A | | Height C | | Counterbore Diameter | | Mounting Method | Std. Pkg. Qty. | Std. Ctn. Qty. |
|-------------------|-----------------------|----------|------|---------|------|----------|-----|----------------------|-----|-----------------|----------------|----------------|
| | | In. | mm | In. | mm | In. | mm | In. | mm | | | |
| TM2S8-C76 | M, I, S | .63 | 16.0 | .43 | 10.8 | .28 | 7.0 | .30 | 7.6 | #8 (M4) screw | 100 | 500 |
| TM3S8-C76 | S, LH | .86 | 21.7 | .62 | 15.5 | .38 | 9.5 | .37 | 9.4 | #8 (M4) screw | 100 | 500 |
| TM3S10-C76 | | .86 | 21.7 | .62 | 15.8 | .38 | 9.5 | .37 | 9.4 | #10 (M5) screw | 100 | 500 |

*Cable tie cross section sizes: M = Miniature, I = Intermediate, S = Standard, LH = Light-Heavy.

TEFZEL is a registered trademark of E. I. du Pont de Nemours and Company.

A. System Overview

B1. Cable Ties

B2. Cable Accessories

B3. Stainless Steel Ties

C1. Wiring Duct

C2. Surface Raceway

C3. Abrasion Protection

C4. Cable Management

D1. Terminals

D2. Power Connectors

D3. Grounding Connectors

E1. Labeling Systems

E2. Labels

E3. Pre-Printed & Write-On Markers

E4. Permanent Identification

E5. Lockout/Tagout & Safety Solutions

F. Index

A.
System
Overview



NEW! PAN-TY® Cable Ties – PEEK (Polyetheretherketone)

B1.
Cable Ties

- Ideal for harsh environments where a cable tie material is required to hold up to chemical or radiation exposure
- Non-conductive material that is excellent for high temperature applications up to 500°F (260°C)
- High strength properties over a wide range of temperatures

- Flammability rating of UL 94V-0 with low smoke and toxicity; halogen-free
- PEEK material meets MIL specification MIL-P-46183, and is approved for use by the Department of Defense
- One-piece construction for consistent performance and reliability
- Lowest threading force of any one-piece cable tie in the industry

B2.
Cable
Accessories

B3.
Stainless
Steel Ties

C1.
Wiring
Duct

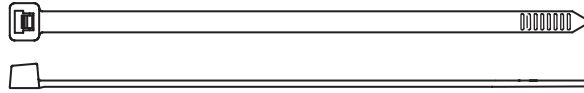

C2.
Surface
Raceway

C3.
Abrasion
Protection

C4.
Cable
Management

D1.
Terminals

D2.
Power
Connectors

D3.
Grounding
Connectors

E1.
Labeling
Systems

E2.
Labels

E3.
Pre-Printed
& Write-On
Markers

E4.
Permanent
Identification

E5.
Lockout/
Tagout
& Safety
Solutions

F.
Index

| Part Number | Length | | Width | | Thickness | | Max. Bundle Dia. | | Min. Loop Tensile Strength | | Recommended Installation Tool | Std. Pkg. Qty. | Std. Ctn. Qty. |
|-------------------------------|--------|-----|-------|-----|-----------|-----|------------------|----|----------------------------|-----|--|----------------|----------------|
| | In. | mm | In. | mm | In. | mm | In. | mm | Lbs. | N | | | |
| Standard Cross Section | | | | | | | | | | | | | |
| PLT2S-C71 | 7.4 | 188 | .190 | 4.8 | .055 | 1.4 | 1.88 | 48 | 150 | 668 | GTS, GTSL, GS2B, GTH, GS4H, PTS, PTH, PPTS, STS2, STH2 | 100 | 1000 |



PAN-TY® Cable Ties – Metal Detectable Nylon 6.6

- For indoor use
- Metal impregnated material allows identification by metal detectors or x-ray inspection equipment to help meet food, beverage, and pharmaceutical safety standards, to help reduce product contamination, loss, and recall
- One-piece construction for consistent performance and reliability
- Lowest threading force of any one-piece cable tie in the industry
- Curved tip is easy to pick up from flat surfaces and allows faster initial threading to speed installation

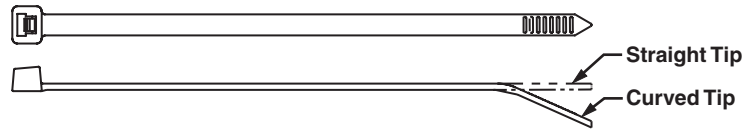

| Part Number | Length | | Width | | Thickness | | Max. Bundle Dia. | | Min. Loop Tensile Strength | | Recommended Installation Tool | Std. Pkg. Qty. | Std. Ctn. Qty. |
|---|--------|-----|-------|-----|-----------|-----|------------------|-----|----------------------------|-----|--|----------------|----------------|
| | In. | mm | In. | mm | In. | mm | In. | mm | Lbs. | N | | | |
| Miniature Cross Section | | | | | | | | | | | | | |
| PLT1M-C86 | 3.9 | 100 | .098 | 2.5 | .044 | 1.1 | .87 | 22 | 18 | 80 | GTS, GTSL, GS2B, STS2 | 100 | 1000 |
| Intermediate Cross Section | | | | | | | | | | | | | |
| PLT2I-C86 | 8.0 | 203 | .135 | 3.4 | .047 | 1.2 | 2.00 | 51 | 40 | 178 | GTS, GTSL, GS2B, STS2 | 100 | 1000 |
| Standard Cross Section | | | | | | | | | | | | | |
| PLT2S-C86 | 7.3 | 186 | .190 | 4.8 | .057 | 1.4 | 1.85 | 47 | 50 | 222 | GTS, GTSL, GS2B, GTH, GS4H, STS2, STH2 | 100 | 1000 |
| PLT3S-C86 | 11.5 | 291 | .190 | 4.8 | .057 | 1.4 | 3.00 | 76 | 50 | 222 | | 100 | 1000 |
| PLT4S-C86 | 14.4 | 366 | .190 | 4.8 | .057 | 1.4 | 4.00 | 102 | 50 | 222 | | 100 | 1000 |
| Light-Heavy Cross Section (Straight Tip) | | | | | | | | | | | | | |
| PLT3H-L86 | 11.1 | 282 | .300 | 7.6 | .075 | 1.9 | 3.00 | 76 | 120 | 120 | GTH, GS4H, GS4EH, STH2, ST3EH | 50 | 500 |
| PLT4H-L86 | 14.4 | 366 | .300 | 7.6 | .075 | 1.9 | 4.00 | 102 | 120 | 120 | | 50 | 500 |

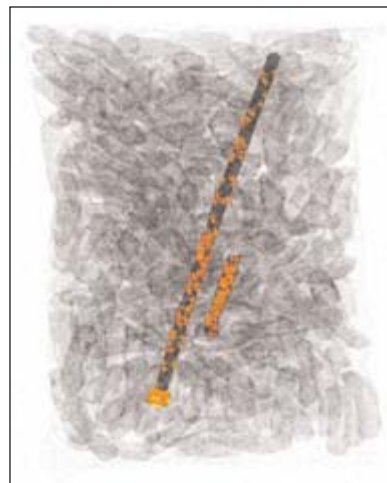

Example x-ray image of metal detectable cable tie in finished product

A. System Overview

B1. Cable Ties

B2. Cable Accessories

B3. Stainless Steel Ties

C1. Wiring Duct

C2. Surface Raceway

C3. Abrasion Protection

C4. Cable Management

D1. Terminals

D2. Power Connectors

D3. Grounding Connectors

E1. Labeling Systems

E2. Labels

E3. Pre-Printed & Write-On Markers

E4. Permanent Identification

E5. Lockout/Tagout & Safety Solutions

F. Index

A. System Overview



PAN-TY® Releasable Cable Ties – Nylon 6.6

B1. Cable Ties

- For indoor use
- Extended release tab permits easy release and re-use where changes are anticipated during development, production, or servicing in the field

- One-piece construction for consistent performance and reliability
- Curved tip is easy to pick up from flat surfaces and allows faster initial threading to speed installation

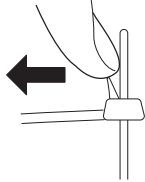

To release, grasp the head of the cable tie, deflect release tab, and pull the cable tie away from the bundle.

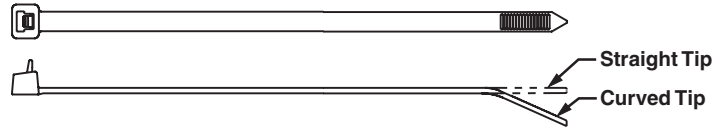

C1. Wiring Duct

| Part Number | Length | | Width | | Thickness | | Max. Bundle Dia. | | Min. Loop Tensile Str. | | Recommended Installation Tool | Std. Pkg. Qty. | Std. Ctn. Qty. |
|-------------|--------|----|-------|----|-----------|----|------------------|----|------------------------|---|-------------------------------|----------------|----------------|
| | In. | mm | In. | mm | In. | mm | In. | mm | Lbs. | N | | | |

Standard Cross Section

| | | | | | | | | | | | | | |
|----------------|------|-----|------|-----|------|-----|------|-----|----|-----|-------------------|-----|------|
| PRT1S-C | 4.8 | 122 | .190 | 4.8 | .052 | 1.3 | 1.00 | 25 | 50 | 222 | Hand install only | 100 | 1000 |
| PRT1.5S-C | 6.3 | 160 | .190 | 4.8 | .052 | 1.3 | 1.50 | 38 | 50 | 222 | | 100 | 1000 |
| PRT2S-C | 7.4 | 188 | .190 | 4.8 | .052 | 1.3 | 1.88 | 48 | 50 | 222 | | 100 | 1000 |
| PRT3S-C | 11.5 | 292 | .190 | 4.8 | .052 | 1.3 | 3.00 | 76 | 50 | 222 | | 100 | 1000 |
| PRT4S-C | 14.5 | 368 | .190 | 4.8 | .052 | 1.3 | 4.00 | 102 | 50 | 222 | | 100 | 1000 |

Light-Heavy Cross Section (Straight Tip)

| | | | | | | | | | | | | | |
|---------|------|-----|------|-----|------|-----|------|-----|----|-----|-------------------|----|-----|
| PRT2H-L | 8.4 | 213 | .300 | 7.6 | .075 | 1.9 | 2.00 | 51 | 80 | 356 | Hand install only | 50 | 500 |
| PRT3H-L | 11.4 | 290 | .300 | 7.6 | .075 | 1.9 | 3.00 | 76 | 80 | 356 | | 50 | 500 |
| PRT4H-L | 14.5 | 368 | .300 | 7.6 | .075 | 1.9 | 4.00 | 102 | 80 | 356 | | 50 | 500 |

Note: UL Listed for use in plenum or air handling spaces per NEC except PRT2H/3H/4H.

C2. Surface Raceway

C3. Abrasion Protection

C4. Cable Management

D1. Terminals

D2. Power Connectors

D3. Grounding Connectors

PAN-TY® Releasable Lashing Ties – Nylon 6.6

- For indoor use
- Release tab permits easy release and re-use where changes are anticipated during development, production, or servicing in the field

- Typically used for heavy duty applications
- Strongest PAN-TY® Cable Tie available
- Can be used with MCEH mounting clip, see page B1.24

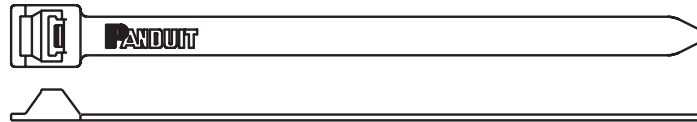

E1. Labeling Systems

E2. Labels

E3. Pre-Printed & Write-On Markers

E4. Permanent Identification

E5. Lockout/Tagout & Safety Solutions

F. Index

| Part Number | Length | | Width | | Thickness | | Max. Bundle Dia. | | Min. Loop Tensile Str. | | Recommended Installation Tool | Std. Pkg. Qty. | Std. Ctn. Qty. |
|-------------|--------|----|-------|----|-----------|----|------------------|----|------------------------|---|-------------------------------|----------------|----------------|
| | In. | mm | In. | mm | In. | mm | In. | mm | Lbs. | N | | | |

Extra-Heavy Cross Section

| | | | | | | | | | | | | | |
|-----------|------|------|------|------|------|-----|-------|-----|-----|------|-------------------|-----|------|
| PRT2EH-C | 9.0 | 229 | .500 | 12.7 | .075 | 1.9 | 2.00 | 51 | 250 | 1112 | Hand install only | 100 | 1000 |
| PRT5EH-Q | 20.1 | 511 | .500 | 12.7 | .075 | 1.9 | 5.00 | 127 | 250 | 1112 | | 25 | 250 |
| PRT6EH-Q | 22.2 | 564 | .500 | 12.7 | .075 | 1.9 | 6.00 | 152 | 250 | 1112 | | 25 | 250 |
| PRT8EH-C | 28.3 | 719 | .500 | 12.7 | .085 | 2.2 | 8.00 | 203 | 250 | 1112 | | 100 | 1000 |
| PRT10EH-C | 34.2 | 869 | .500 | 12.7 | .085 | 2.2 | 10.00 | 254 | 250 | 1112 | | 100 | 500 |
| PRT12EH-C | 40.1 | 1019 | .500 | 12.7 | .085 | 2.2 | 12.00 | 305 | 250 | 1112 | | 100 | 500 |



PAN-TY® Releasable Cable Ties – Weather Resistant and Heat Stabilized Nylon 6.6

- Weather resistant material has greater resistance to damage caused by ultraviolet light – indoor or outdoor use
- Heat stabilized material for high temperature applications up to 239°F (115°C) – indoor use

- Extended release tab permits easy release and re-use where changes are anticipated during development, production, or servicing in the field
- One-piece construction for consistent performance and reliability
- Curved tip is easy to pick up from flat surfaces and allows faster initial threading to speed installation

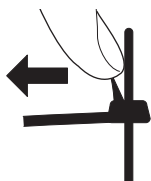

To release, grasp the head of the cable tie, deflect release tab, and pull the cable tie away from the bundle.

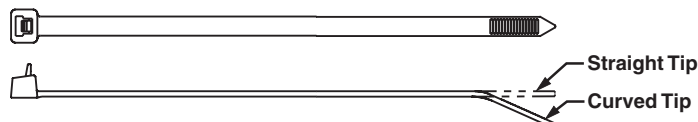

| Part Number | Length | | Width | | Thickness | | Max. Bundle Dia. | | Min. Loop Tensile Str. | | Recommended Installation Tool | Std. Pkg. Qty. | Std. Ctn. Qty. |
|-------------|--------|----|-------|----|-----------|----|------------------|----|------------------------|---|-------------------------------|----------------|----------------|
| | In. | mm | In. | mm | In. | mm | In. | mm | Lbs. | N | | | |

Weather Resistant Nylon 6.6

Standard Cross Section

| | | | | | | | | | | | | | |
|------------|------|-----|------|-----|------|-----|------|-----|----|-----|-------------------|-----|------|
| PRT1S-C0 | 4.8 | 122 | .190 | 4.8 | .052 | 1.3 | 1.00 | 25 | 50 | 222 | Hand install only | 100 | 1000 |
| PRT1.5S-C0 | 6.3 | 160 | .190 | 4.8 | .052 | 1.3 | 1.50 | 38 | 50 | 222 | | 100 | 1000 |
| PRT2S-C0 | 7.4 | 188 | .190 | 4.8 | .052 | 1.3 | 1.88 | 48 | 50 | 222 | | 100 | 1000 |
| PRT3S-C0 | 11.5 | 292 | .190 | 4.8 | .052 | 1.3 | 3.00 | 76 | 50 | 222 | | 100 | 1000 |
| PRT4S-C0 | 14.5 | 368 | .190 | 4.8 | .052 | 1.3 | 4.00 | 102 | 50 | 222 | | 100 | 1000 |

Light-Heavy Cross Section (Straight Tip)

| | | | | | | | | | | | | | |
|----------|------|-----|------|-----|------|-----|------|-----|----|-----|-------------------|----|-----|
| PRT2H-L0 | 8.4 | 213 | .300 | 7.6 | .075 | 1.9 | 2.00 | 51 | 80 | 356 | Hand install only | 50 | 500 |
| PRT3H-L0 | 11.4 | 290 | .300 | 7.6 | .075 | 1.9 | 3.00 | 76 | 80 | 356 | | 50 | 500 |
| PRT4H-L0 | 14.5 | 368 | .300 | 7.6 | .075 | 1.9 | 4.00 | 102 | 80 | 356 | | 50 | 500 |

Heat Stabilized Nylon 6.6

Standard Cross Section

| | | | | | | | | | | | | | |
|-------------|-----|-----|------|-----|------|-----|------|----|----|-----|-------------------|------|-------|
| PRT1.5S-M30 | 6.3 | 160 | .190 | 4.8 | .052 | 1.3 | 1.50 | 38 | 50 | 222 | Hand install only | 1000 | 10000 |
|-------------|-----|-----|------|-----|------|-----|------|----|----|-----|-------------------|------|-------|

Note: UL Listed, UL Recognized, and CSA Certified, except PRT2H/3H/4H.

A. System Overview

B1. Cable Ties

B2. Cable Accessories

B3. Stainless Steel Ties

C1. Wiring Duct

C2. Surface Raceway

C3. Abrasion Protection

C4. Cable Management

D1. Terminals

D2. Power Connectors

D3. Grounding Connectors

E1. Labeling Systems

E2. Labels

E3. Pre-Printed & Write-On Markers

E4. Permanent Identification

E5. Lockout/Tagout & Safety Solutions

F. Index

A. System Overview

PAN-TY® Releasable Lashing Ties – Weather Resistant Nylon 6.6

B1. Cable Ties

- Greater resistance to damage caused by ultraviolet light – indoor or outdoor use
- Release tab permits easy release and re-use where changes are anticipated during development, production, or servicing in the field
- Typically used for heavy duty applications
- Strongest PAN-TY® Cable Tie available
- Can be used with MCEH mounting clip shown below

B2. Cable Accessories

B3. Stainless Steel Ties

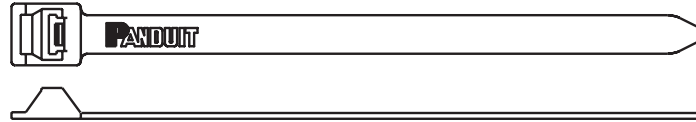

C1. Wiring Duct

C2. Surface Raceway

| Part Number | Length | | Width | | Thickness | | Max. Bundle Dia. | | Min. Loop Tensile Str. | | Recommended Installation Tool | Std. Pkg. Qty. | Std. Ctn. Qty. |
|----------------------------------|--------|------|-------|------|-----------|-----|------------------|-----|------------------------|------|-------------------------------|----------------|----------------|
| | In. | mm | In. | mm | In. | mm | In. | mm | Lbs. | N | | | |
| Extra-Heavy Cross Section | | | | | | | | | | | | | |
| PRT2EH-Q0 | 9.0 | 229 | .500 | 12.7 | .075 | 1.9 | 2.00 | 51 | 250 | 1112 | Hand install only | 25 | 250 |
| PRT5EH-Q0 | 20.1 | 511 | .500 | 12.7 | .075 | 1.9 | 5.00 | 127 | 250 | 1112 | | 25 | 250 |
| PRT6EH-Q0 | 22.2 | 564 | .500 | 12.7 | .075 | 1.9 | 6.00 | 152 | 250 | 1112 | | 25 | 250 |
| PRT8EH-Q0 | 28.3 | 719 | .500 | 12.7 | .085 | 2.2 | 8.00 | 203 | 250 | 1112 | | 25 | 250 |
| PRT10EH-Q0 | 34.2 | 869 | .500 | 12.7 | .085 | 2.2 | 10.00 | 254 | 250 | 1112 | | 25 | 250 |
| PRT12EH-Q0 | 40.1 | 1019 | .500 | 12.7 | .085 | 2.2 | 12.00 | 305 | 250 | 1112 | | 25 | 250 |

D1. Terminals

D2. Power Connectors

MCEH® Lashing Tie Mounting Clip – Weather Resistant Nylon 6.6

D3. Grounding Connectors

- Greater resistance to damage caused by ultraviolet light – indoor or outdoor use
- Converts PANDUIT lashing ties into clamps
- Easily snaps in place for a secure clamp
- Use with lashing ties shown above and on pages B1.9, B1.11, B1.22 and B1.25

E1. Labeling Systems

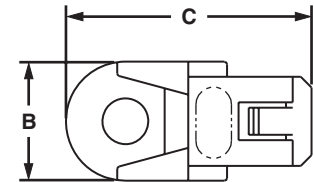

E2. Labels

E3. Pre-Printed & Write-On Markers

| Part Number | Height A | | Width B | | Length C | | Mounting Method | Std. Pkg. Qty. | Std. Ctn. Qty. |
|--------------------|----------|-----|---------|------|----------|----|--------------------------------|----------------|----------------|
| | In. | mm | In. | mm | In. | mm | | | |
| MCEH-S25-C0 | .13 | 3.3 | .67 | 17.0 | 1.38 | 35 | 1/4" (M6) screw (not flathead) | 100 | 1000 |

E4. Permanent Identification

E5. Lockout/Tagout & Safety Solutions

F. Index

PAN-TY® Releasable Lashing Ties – Weather Resistant Polypropylene

- For chemical resistance where high loop tensile strength is not required especially in the presence of hydrochloric acid, salts, and bases
- Greater resistance to damage caused by ultraviolet light – indoor or outdoor use
- Release tab permits easy release and re-use where changes are anticipated during development, production, or servicing in the field
- Typically used for heavy duty applications
- Can be used with MCEH mounting clip, see page B1.24

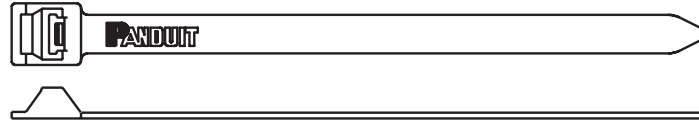

| Part Number | Length | | Width | | Thickness | | Max. Bundle Dia. | | Min. Loop Tensile Str. | | Recommended Installation Tool | Std. Pkg. Qty. | Std. Ctn. Qty. |
|----------------------------------|--------|-----|-------|------|-----------|-----|------------------|-----|------------------------|-----|-------------------------------|----------------|----------------|
| | In. | mm | In. | mm | In. | mm | In. | mm | Lbs. | N | | | |
| Extra-Heavy Cross Section | | | | | | | | | | | | | |
| PRT2EH-C100 | 9.0 | 229 | .500 | 12.7 | .075 | 1.9 | 2.00 | 51 | 90 | 400 | Hand install only | 100 | 1000 |
| PRT5EH-C100 | 20.1 | 511 | .500 | 12.7 | .075 | 1.9 | 5.00 | 127 | 90 | 400 | | 100 | 1000 |
| PRT6EH-C100 | 22.2 | 564 | .500 | 12.7 | .075 | 1.9 | 6.00 | 152 | 90 | 400 | | 100 | 1000 |
| PRT8EH-C100 | 28.3 | 719 | .500 | 12.7 | .085 | 2.2 | 8.00 | 203 | 90 | 400 | | 100 | 1000 |

A.
System
Overview

B1.
Cable
Ties

B2.
Cable
Accessories

B3.
Stainless
Steel Ties

C1.
Wiring
Duct

C2.
Surface
Raceway

C3.
Abrasion
Protection

C4.
Cable
Management

D1.
Terminals

D2.
Power
Connectors

D3.
Grounding
Connectors

E1.
Labeling
Systems

E2.
Labels

E3.
Pre-Printed
& Write-On
Markers

E4.
Permanent
Identification

E5.
Lockout/
Tagout
& Safety
Solutions

F.
Index

A.
System
Overview

UL **US** **UL** **LISTED** **CSA** **US** **PAN-TY® Clamp Ties – Nylon 6.6**

B1.
Cable Ties

- For indoor use
- Used to secure a cable bundle to another surface such as a control panel, communication rack, wall or ceiling
- Design allows for bundling before or after screwing clamp in place

- One-piece construction for consistent performance and reliability
- Curved tip is easy to pick up from flat surfaces and allows faster initial threading to speed installation

B2.
Cable
Accessories

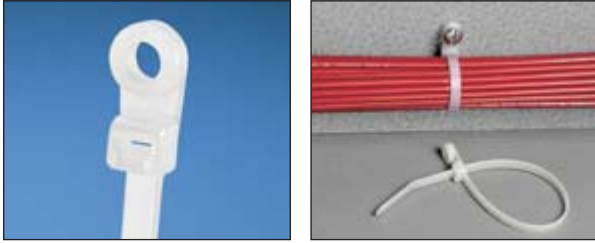

B3.
Stainless
Steel Ties

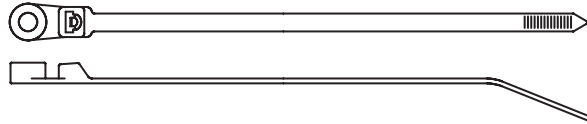

C1.
Wiring
Duct

C2.
Surface
Raceway

| Part Number | Length | | Width | | Thickness | | Nominal Hole Dia. | | Screw Size | Metric Screw Size | Max. Bundle Dia. | | Min. Loop Tensile Str. | | Recommended Installation Tool | Std. Pkg. Qty. | Std. Ctn. Qty. |
|--------------------------------|--------|-----|-------|-----|-----------|-----|-------------------|-----|------------|-------------------|------------------|----|------------------------|----|----------------------------------|----------------|----------------|
| | In. | mm | In. | mm | In. | mm | In. | mm | | | In. | mm | Lbs. | N | | | |
| Miniature Cross Section | | | | | | | | | | | | | | | | | |
| PLC1M-S4-C | 4.3 | 109 | .100 | 2.5 | .045 | 1.1 | .122 | 3.1 | #4 | M2.5 | .75 | 19 | 18 | 80 | GTS, GTSL, GS2B, PTS, PPTS, STS2 | 100 | 1000 |

C3.
Abrasion
Protection

C4.
Cable
Management

| | | | | | | | | | | | | | | | | | |
|-----------------------------------|-----|-----|------|-----|------|-----|------|-----|----|----|------|----|----|-----|----------------------------------|-----|------|
| Intermediate Cross Section | | | | | | | | | | | | | | | | | |
| PLC1.5I-S8-C | 6.1 | 155 | .135 | 3.4 | .045 | 1.1 | .174 | 4.4 | #8 | M4 | 1.25 | 32 | 40 | 178 | GTS, GTSL, GS2B, PTS, PPTS, STS2 | 100 | 1000 |

D1.
Terminals

D2.
Power
Connectors

| | | | | | | | | | | | | | | | | | |
|-------------------------------|------|-----|------|-----|------|-----|------|-----|-----|----|------|-----|----|-----|--|-----|------|
| Standard Cross Section | | | | | | | | | | | | | | | | | |
| PLC2S-S6-C | 7.9 | 201 | .190 | 4.8 | .047 | 1.2 | .148 | 3.8 | #6 | M3 | 1.84 | 47 | 50 | 222 | GTS, GTSL, GS2B, GTH, GS4H, PTS, PTH, PPTS, STS2, STH2 | 100 | 1000 |
| PLC2S-S10-C | 7.9 | 201 | .190 | 4.8 | .047 | 1.2 | .200 | 5.1 | #10 | M5 | 1.84 | 47 | 50 | 222 | | 100 | 1000 |
| PLC3S-S10-C | 12.0 | 305 | .190 | 4.8 | .047 | 1.2 | .200 | 5.1 | #10 | M5 | 3.00 | 76 | 50 | 222 | | 100 | 1000 |
| PLC4S-S10-C | 15.0 | 381 | .190 | 4.8 | .052 | 1.3 | .200 | 5.1 | #10 | M5 | 4.00 | 102 | 50 | 222 | | 100 | 1000 |

D3.
Grounding
Connectors

| | | | | | | | | | | | | | | | | | |
|----------------------------------|------|-----|------|-----|------|-----|------|-----|-----|----|------|-----|-----|-----|------------------------------------|----|-----|
| Light-Heavy Cross Section | | | | | | | | | | | | | | | | | |
| PLC2H-S25-L | 9.0 | 229 | .300 | 7.6 | .075 | 1.9 | .260 | 6.6 | 1/4 | M6 | 2.00 | 51 | 120 | 534 | GTH, GS4H, GS4EH, PTH, STH2, ST3EH | 50 | 500 |
| PLC4H-S25-L | 15.1 | 384 | .300 | 7.6 | .075 | 1.9 | .260 | 6.6 | 1/4 | M6 | 4.00 | 102 | 120 | 534 | | 50 | 500 |

E1.
Labeling
Systems

E2.
Labels

E3.
Pre-Printed
& Write-On
Markers

E4.
Permanent
Identification

E5.
Lockout/
Tagout/
& Safety
Solutions

F.
Index

UL[®] US CS[®] PAN-TY[®] Clamp Ties – Weather Resistant and Heat Stabilized Nylon 6.6

- Weather resistant material has greater resistance to damage caused by ultraviolet light – indoor or outdoor use
- Heat stabilized material for high temperature applications up to 239°F (115°C) – indoor use
- Used to secure a cable bundle to another surface such as a control panel, communication rack, wall or ceiling
- Design allows for bundling before or after screwing clamp in place
- One-piece construction for consistent performance and reliability
- Curved tip is easy to pick up from flat surfaces and allows faster initial threading to speed installation

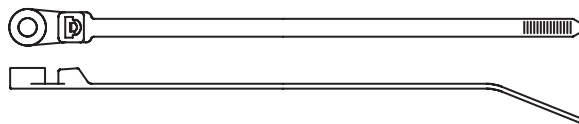

| Part Number | Length | | Width | | Thickness | | Nominal Hole Dia. | | Screw Size | Metric Screw Size | Max. Bundle Dia. | | Min. Loop Tensile Str. | | Recommended Installation Tool | Std. Pkg. Qty. | Std. Ctn. Qty. |
|-------------|--------|----|-------|----|-----------|----|-------------------|----|------------|-------------------|------------------|----|------------------------|---|-------------------------------|----------------|----------------|
| | In. | mm | In. | mm | In. | mm | In. | mm | | | In. | mm | Lbs. | N | | | |

Weather Resistant Nylon 6.6

Miniature Cross Section

| | | | | | | | | | | | | | | | | | |
|-------------|-----|-----|------|-----|------|-----|------|-----|----|------|-----|----|----|----|----------------------------------|-----|------|
| PLC1M-S4-C0 | 4.3 | 109 | .100 | 2.5 | .045 | 1.1 | .122 | 3.1 | #4 | M2.5 | .75 | 19 | 18 | 80 | GTS, GTSL, GS2B, PTS, PPTS, STS2 | 100 | 1000 |
|-------------|-----|-----|------|-----|------|-----|------|-----|----|------|-----|----|----|----|----------------------------------|-----|------|

Intermediate Cross Section

| | | | | | | | | | | | | | | | | | |
|---------------|-----|-----|------|-----|------|-----|------|-----|----|----|------|----|----|-----|----------------------------------|-----|------|
| PLC1.5I-S8-C0 | 6.1 | 155 | .135 | 3.4 | .045 | 1.1 | .174 | 4.4 | #8 | M4 | 1.25 | 32 | 40 | 178 | GTS, GTSL, GS2B, PTS, PPTS, STS2 | 100 | 1000 |
|---------------|-----|-----|------|-----|------|-----|------|-----|----|----|------|----|----|-----|----------------------------------|-----|------|

Standard Cross Section

| | | | | | | | | | | | | | | | | | |
|--------------|------|-----|------|-----|------|-----|------|-----|-----|----|------|-----|----|-----|--|-----|------|
| PLC2S-S6-C0 | 7.9 | 201 | .190 | 4.8 | .047 | 1.2 | .148 | 3.8 | #6 | M3 | 1.84 | 47 | 50 | 222 | GTS, GTSL, GS2B, GTH, GS4H, PTS, PTH, PPTS, STS2, STH2 | 100 | 1000 |
| PLC2S-S10-C0 | 7.9 | 201 | .190 | 4.8 | .047 | 1.2 | .200 | 5.1 | #10 | M5 | 1.84 | 47 | 50 | 222 | | 100 | 1000 |
| PLC3S-S10-C0 | 12.0 | 305 | .190 | 4.8 | .052 | 1.3 | .200 | 5.1 | #10 | M5 | 3.00 | 76 | 50 | 222 | | 100 | 1000 |
| PLC4S-S10-C0 | 15.0 | 381 | .190 | 4.8 | .052 | 1.3 | .200 | 5.1 | #10 | M5 | 4.00 | 102 | 50 | 222 | | 100 | 1000 |

Light-Heavy Cross Section

| | | | | | | | | | | | | | | | | | |
|---------------|------|-----|------|-----|------|-----|------|-----|-----|----|------|-----|-----|-----|------------------------------------|-----|------|
| PLC2H-S25-TL0 | 9.0 | 229 | .300 | 7.6 | .075 | 1.9 | .260 | 6.6 | 1/4 | M6 | 2.00 | 51 | 120 | 534 | GTH, GS4H, GS4EH, PTH, STH2, ST3EH | 250 | 2500 |
| PLC4H-S25-L0 | 15.1 | 384 | .300 | 7.6 | .075 | 1.9 | .260 | 6.6 | 1/4 | M6 | 4.00 | 102 | 120 | 534 | | 50 | 500 |

Heat Stabilized Nylon 6.6

Miniature Cross Section

| | | | | | | | | | | | | | | | | | |
|--------------|-----|-----|------|-----|------|-----|------|-----|----|------|-----|----|----|----|----------------------------------|------|-------|
| PLC1M-S4-M30 | 4.3 | 109 | .100 | 2.5 | .045 | 1.1 | .122 | 3.1 | #4 | M2.5 | .75 | 19 | 18 | 80 | GTS, GTSL, GS2B, PTS, PPTS, STS2 | 1000 | 50000 |
|--------------|-----|-----|------|-----|------|-----|------|-----|----|------|-----|----|----|----|----------------------------------|------|-------|

Intermediate Cross Section

| | | | | | | | | | | | | | | | | | |
|----------------|-----|-----|------|-----|------|-----|------|-----|----|----|------|----|----|-----|----------------------------------|------|-------|
| PLC1.5I-S8-M30 | 6.1 | 155 | .135 | 3.4 | .045 | 1.1 | .174 | 4.4 | #8 | M4 | 1.25 | 32 | 40 | 178 | GTS, GTSL, GS2B, PTS, PPTS, STS2 | 1000 | 25000 |
|----------------|-----|-----|------|-----|------|-----|------|-----|----|----|------|----|----|-----|----------------------------------|------|-------|

Standard Cross Section

| | | | | | | | | | | | | | | | | | |
|---------------|------|-----|------|-----|------|-----|------|-----|-----|----|------|-----|----|-----|--|------|-------|
| PLC2S-S10-M30 | 7.9 | 201 | .190 | 4.8 | .047 | 1.2 | .200 | 5.1 | #10 | M5 | 1.84 | 47 | 50 | 222 | GTS, GTSL, GS2B, GTH, GS4H, PTS, PTH, PPTS, STS2, STH2 | 1000 | 10000 |
| PLC4S-S10-M30 | 15.0 | 381 | .190 | 4.8 | .052 | 1.3 | .200 | 5.1 | #10 | M5 | 4.00 | 102 | 50 | 222 | | 1000 | 5000 |

Light-Heavy Cross Section

| | | | | | | | | | | | | | | | | | |
|----------------|------|-----|------|-----|------|-----|------|-----|-----|----|------|-----|-----|-----|------------------------------------|-----|------|
| PLC2H-S25-TL30 | 9.0 | 229 | .300 | 7.6 | .075 | 1.9 | .260 | 6.6 | 1/4 | M6 | 2.00 | 51 | 120 | 534 | GTH, GS4H, GS4EH, PTH, STH2, ST3EH | 250 | 2500 |
| PLC4H-S25-TL30 | 15.1 | 384 | .300 | 7.6 | .075 | 1.9 | .260 | 6.6 | 1/4 | M6 | 4.00 | 102 | 120 | 534 | | 250 | 2500 |

Note: UL Recognized and CSA Certified except PLC2H/4H in Weather Resistant material (0).

A.
System
Overview

B1.
Cable Ties

B2.
Cable
Accessories

B3.
Stainless
Steel Ties

C1.
Wiring
Duct

C2.
Surface
Raceway

C3.
Abrasion
Protection

C4.
Cable
Management

D1.
Terminals

D2.
Power
Connectors

D3.
Grounding
Connectors

E1.
Labeling
Systems

E2.
Labels

E3.
Pre-Printed
& Write-On
Markers

E4.
Permanent
Identification

E5.
Lockout/
Tagout/
& Safety
Solutions

F.
Index

A.
System
Overview

PAN-TY® Wing Push Mount Ties – Nylon 6.6

- For indoor use
- Cable tie, mount, and fastener in a single part
- Used to attach bundles to another surface such as a flat panel
- Anchor is easily pressed into a pre-formed hole and locks in place
- Wings provide constant tension for a stable, secure, and rattle-free installation
- Curved tip is easy to pick up from flat surfaces and allows faster initial threading to speed installation

B1.
Cable Ties

B2.
Cable
Accessories

B3.
Stainless
Steel Ties

C1.
Wiring
Duct

C2.
Surface
Raceway

C3.
Abrasion
Protection

C4.
Cable
Management

D1.
Terminals

D2.
Power
Connectors

D3.
Grounding
Connectors

E1.
Labeling
Systems

E2.
Labels

E3.
Pre-Printed
& Write-On
Markers

E4.
Permanent
Identification

E5.
Lockout/
Tagout/
& Safety
Solutions

F.
Index

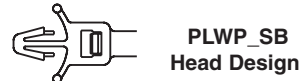
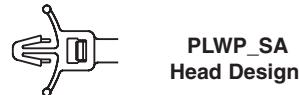
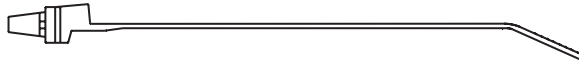
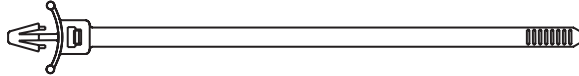

| Part Number | Length | | Width | | Thickness | | Nominal Hole Dia. | | Max. Panel Thickness | | Max. Bundle Dia. | | Min. Loop Tensile Str. | | Recommended Installation Tool | Std. Pkg. Qty. | Std. Ctn. Qty. |
|-------------|--------|----|-------|----|-----------|----|-------------------|----|----------------------|----|------------------|----|------------------------|---|-------------------------------|----------------|----------------|
| | In. | mm | In. | mm | In. | mm | In. | mm | In. | mm | In. | mm | Lbs. | N | | | |

Miniature Cross Section

| | | | | | | | | | | | | | | | | | |
|-----------------|-----|-----|------|-----|------|-----|------|-----|------|-----|-----|----|----|----|----------------------------------|-----|------|
| PLWP1M-C | 4.3 | 109 | .098 | 2.5 | .044 | 1.1 | .187 | 4.7 | .093 | 2.4 | .87 | 22 | 18 | 80 | GTS, GTSL, GS2B, PTS, PPTS, STS2 | 100 | 1000 |
|-----------------|-----|-----|------|-----|------|-----|------|-----|------|-----|-----|----|----|----|----------------------------------|-----|------|

Intermediate Cross Section

| | | | | | | | | | | | | | | | | | |
|-------------------|-----|-----|------|-----|------|-----|------|-----|------|-----|------|----|----|-----|----------------------------------|-----|------|
| PLWP1.5I-C | 6.0 | 152 | .135 | 3.4 | .045 | 1.2 | .187 | 4.7 | .093 | 2.4 | 1.25 | 32 | 40 | 178 | GTS, GTSL, GS2B, PTS, PPTS, STS2 | 100 | 1000 |
|-------------------|-----|-----|------|-----|------|-----|------|-----|------|-----|------|----|----|-----|----------------------------------|-----|------|

Standard Cross Section

| | | | | | | | | | | | | | | | | | |
|--------------------|-----|-----|------|-----|------|-----|------|-----|------|-----|------|----|----|-----|--|-----|------|
| PLWP1S-C | 5.2 | 132 | .190 | 4.8 | .052 | 1.3 | .250 | 6.4 | .105 | 2.7 | 1.00 | 25 | 50 | 222 | GTS, GTSL, GS2B, GTH, GS4H, PTS, PTH, PPTS, STS2, STH2 | 100 | 1000 |
| PLWP1SA-D | 5.1 | 130 | .190 | 4.8 | .052 | 1.3 | .187 | 4.7 | .093 | 2.4 | 1.00 | 25 | 50 | 222 | | 500 | 5000 |
| PLWP1SB-D | 5.2 | 132 | .190 | 4.8 | .052 | 1.3 | .187 | 4.7 | .157 | 4.0 | 1.00 | 25 | 50 | 222 | | 500 | 5000 |
| PLWP1.5S-D | 6.8 | 173 | .190 | 4.8 | .052 | 1.3 | .250 | 6.4 | .105 | 2.7 | 1.50 | 38 | 50 | 222 | | 500 | 5000 |
| PLWP1.5SA-D | 6.7 | 170 | .190 | 4.8 | .052 | 1.3 | .187 | 4.7 | .093 | 2.4 | 1.50 | 38 | 50 | 222 | | 500 | 5000 |
| PLWP2S-C | 7.8 | 198 | .190 | 4.8 | .052 | 1.3 | .250 | 6.4 | .105 | 2.7 | 1.75 | 45 | 50 | 222 | | 100 | 1000 |
| PLWP2SA-D | 7.7 | 196 | .190 | 4.8 | .052 | 1.3 | .187 | 4.7 | .093 | 2.4 | 1.75 | 45 | 50 | 222 | | 500 | 5000 |
| PLWP2SB-D | 7.8 | 198 | .190 | 4.8 | .052 | 1.3 | .187 | 4.7 | .157 | 4.0 | 1.75 | 45 | 50 | 222 | | 500 | 5000 |

Light-Heavy Cross Section

| | | | | | | | | | | | | | | | | | |
|------------------|------|-----|------|-----|------|-----|------|-----|------|-----|------|----|-----|-----|------------------------------------|-----|------|
| PLWP2H-TL | 8.9 | 226 | .300 | 7.6 | .075 | 1.9 | .266 | 6.8 | .105 | 2.7 | 2.00 | 51 | 120 | 534 | GTH, GS4H, GS4EH, PTH, STH2, ST3EH | 250 | 2500 |
| PLWP3H-TL | 12.0 | 305 | .300 | 7.6 | .075 | 1.9 | .266 | 6.8 | .105 | 2.7 | 3.00 | 76 | 120 | 534 | | 250 | 2500 |

Note: UL Recognized and CSA Certified except PLWP2H/3H.



PAN-TY® Wing Push Mount Ties – Weather Resistant and Heat Stabilized Nylon 6.6

- Weather resistant material has greater resistance to damage caused by ultraviolet light – indoor or outdoor use
- Heat stabilized material for high temperature applications up to 239°F (115°C) – indoor use
- Cable tie, mount, and fastener in a single part
- Used to attach bundles to another surface such as a flat panel

- Anchor is easily pressed into a pre-formed hole and locks in place
- Wings provide constant tension for a stable, secure, and rattle-free installation
- Curved tip is easy to pick up from flat surfaces and allows faster initial threading to speed installation

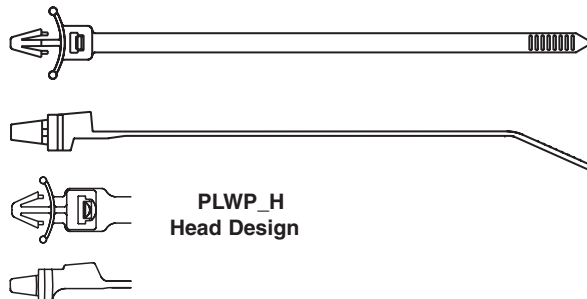

| Part Number | Length | | Width | | Thickness | | Nominal Hole Dia. | | Max. Panel Thickness | | Max. Bundle Dia. | | Min. Loop Tensile Str. | | Recommended Installation Tool | Std. Pkg. Qty. | Std. Ctn. Qty. |
|-------------|--------|----|-------|----|-----------|----|-------------------|----|----------------------|----|------------------|----|------------------------|---|-------------------------------|----------------|----------------|
| | In. | mm | In. | mm | In. | mm | In. | mm | In. | mm | In. | mm | Lbs. | N | | | |

Weather Resistant Nylon 6.6

Miniature Cross Section

| | | | | | | | | | | | | | | | | | |
|------------------|-----|-----|------|-----|------|-----|------|-----|------|-----|-----|----|----|----|----------------------------------|-----|------|
| PLWP1M-D0 | 4.3 | 109 | .098 | 2.5 | .044 | 1.1 | .187 | 4.7 | .093 | 2.4 | .87 | 22 | 18 | 80 | GTS, GTSL, GS2B, PTS, PPTS, STS2 | 500 | 5000 |
|------------------|-----|-----|------|-----|------|-----|------|-----|------|-----|-----|----|----|----|----------------------------------|-----|------|

Standard Cross Section

| | | | | | | | | | | | | | | | | | |
|------------------|-----|-----|------|-----|------|-----|------|-----|------|-----|------|----|----|-----|--|-----|------|
| PLWP1S-C0 | 5.2 | 132 | .190 | 4.8 | .052 | 1.3 | .250 | 6.4 | .105 | 2.7 | 1.00 | 25 | 50 | 222 | GTS, GTSL, GS2B, GTH, GS4H, PTS, PTH, PPTS, STS2, STH2 | 100 | 1000 |
| PLWP2S-C0 | 7.8 | 198 | .190 | 4.8 | .052 | 1.3 | .250 | 6.4 | .105 | 2.7 | 1.75 | 45 | 50 | 222 | | 100 | 1000 |

Light-Heavy Cross Section

| | | | | | | | | | | | | | | | | | |
|-------------------|------|-----|------|-----|------|-----|------|-----|------|-----|------|----|-----|-----|------------------------------------|-----|------|
| PLWP2H-TL0 | 8.9 | 226 | .300 | 7.6 | .075 | 1.9 | .266 | 6.8 | .105 | 2.7 | 2.00 | 51 | 120 | 534 | GTH, GS4H, GS4EH, PTH, STH2, ST3EH | 250 | 2500 |
| PLWP3H-TL0 | 12.0 | 305 | .300 | 7.6 | .075 | 1.9 | .266 | 6.8 | .105 | 2.7 | 3.00 | 76 | 120 | 534 | | 250 | 2500 |

Heat Stabilized Nylon 6.6

Miniature Cross Section

| | | | | | | | | | | | | | | | | | |
|-------------------|-----|-----|------|-----|------|-----|------|-----|------|-----|-----|----|----|----|----------------------------------|-----|------|
| PLWP1M-D30 | 4.3 | 109 | .098 | 2.5 | .044 | 1.1 | .187 | 4.7 | .093 | 2.4 | .87 | 22 | 18 | 80 | GTS, GTSL, GS2B, PTS, PPTS, STS2 | 500 | 5000 |
|-------------------|-----|-----|------|-----|------|-----|------|-----|------|-----|-----|----|----|----|----------------------------------|-----|------|

Intermediate Cross Section

| | | | | | | | | | | | | | | | | | |
|---------------------|-----|-----|------|-----|------|-----|------|-----|------|-----|------|----|----|-----|----------------------------------|-----|------|
| PLWP1.5I-D30 | 6.0 | 152 | .135 | 3.4 | .045 | 1.2 | .187 | 4.7 | .093 | 2.4 | 1.25 | 32 | 40 | 178 | GTS, GTSL, GS2B, PTS, PPTS, STS2 | 500 | 5000 |
|---------------------|-----|-----|------|-----|------|-----|------|-----|------|-----|------|----|----|-----|----------------------------------|-----|------|

Standard Cross Section

| | | | | | | | | | | | | | | | | | |
|---------------------|-----|-----|------|-----|------|-----|------|-----|------|-----|------|----|----|-----|--|-----|------|
| PLWP1S-D30 | 5.2 | 132 | .190 | 4.8 | .052 | 1.3 | .250 | 6.4 | .105 | 2.7 | 1.00 | 25 | 50 | 222 | GTS, GTSL, GS2B, GTH, GS4H, PTS, PTH, PPTS, STS2, STH2 | 500 | 5000 |
| PLWP1.5S-D30 | 6.8 | 173 | .190 | 4.8 | .052 | 1.3 | .250 | 6.4 | .105 | 2.7 | 1.50 | 38 | 50 | 222 | | 500 | 5000 |
| PLWP2S-D30 | 7.8 | 198 | .190 | 4.8 | .052 | 1.3 | .250 | 6.4 | .105 | 2.7 | 1.75 | 45 | 50 | 222 | | 500 | 5000 |

Light-Heavy Cross Section

| | | | | | | | | | | | | | | | | | |
|--------------------|-----|-----|------|-----|------|-----|------|-----|------|-----|------|----|-----|-----|------------------------------------|-----|------|
| PLWP2H-TL30 | 8.9 | 226 | .300 | 7.6 | .075 | 1.9 | .266 | 6.8 | .105 | 2.7 | 2.00 | 51 | 120 | 534 | GTH, GS4H, GS4EH, PTH, STH2, ST3EH | 250 | 2500 |
|--------------------|-----|-----|------|-----|------|-----|------|-----|------|-----|------|----|-----|-----|------------------------------------|-----|------|

Note: UL Recognized and CSA Certified except PLWP2H/3H.

A.
System
Overview

B1.
Cable Ties

B2.
Cable
Accessories

B3.
Stainless
Steel Ties

C1.
Wiring
Duct

C2.
Surface
Raceway

C3.
Abrasion
Protection

C4.
Cable
Management

D1.
Terminals

D2.
Power
Connectors

D3.
Grounding
Connectors

E1.
Labeling
Systems

E2.
Labels

E3.
Pre-Printed
& Write-On
Markers

E4.
Permanent
Identification

E5.
Lockout/
Tagout/
& Safety
Solutions

F.
Index

A. System Overview

UL[®] US[®] CSA[®] US[®] PAN-TY[®] Releasable Wing Push Mount Ties

B1. Cable Ties

- Natural nylon material for indoor use
- Weather resistant material has greater resistance to damage caused by ultraviolet light – indoor or outdoor use
- Heat stabilized material for high temperature applications up to 239°F (115°C) – indoor use
- Cable tie, mount, and fastener in a single part
- Used to attach bundles to another surface such as a flat panel

- Anchor is easily pressed into a pre-formed hole and locks in place
- Wings provide constant tension for a stable, secure, and rattle-free installation
- Extended release tab permits easy release and re-use where changes are anticipated during development, production, or servicing in the field
- Curved tip is easy to pick up from flat surfaces and allows faster initial threading to speed installation

B2. Cable Accessories

B3. Stainless Steel Ties

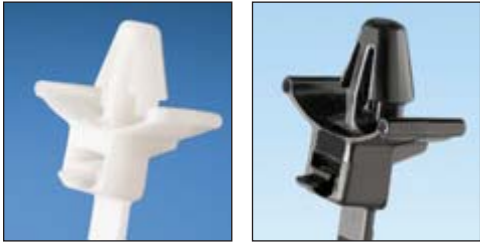

PRWP2S-D

PRWP2S-D0

C1. Wiring Duct

C2. Surface Raceway

C3. Abrasion Protection



C4. Cable Management

D1. Terminals

D2. Power Connectors

D3. Grounding Connectors

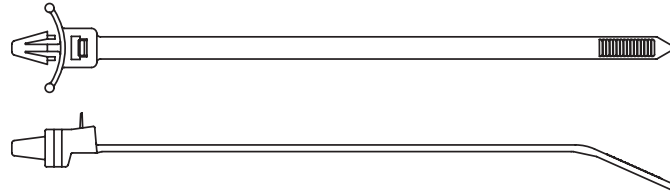

PRWP_SA Head Design

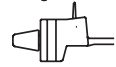

PRWP_SB Head Design

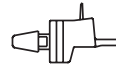

PRWP_H Head Design

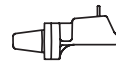

| Part Number | Length | | Width | | Thickness | | Nominal Hole Dia. | | Max. Panel Thickness | | Max. Bundle Dia. | | Min. Loop Tensile Str. | | Recommended Installation Tool | Std. Pkg. Qty. | Std. Ctn. Qty. |
|-------------|--------|----|-------|----|-----------|----|-------------------|----|----------------------|----|------------------|----|------------------------|---|-------------------------------|----------------|----------------|
| | In. | mm | In. | mm | In. | mm | In. | mm | In. | mm | In. | mm | Lbs. | N | | | |

Nylon 6.6

Standard Cross Section

| | | | | | | | | | | | | | | | | | |
|-------------------|-----|-----|------|-----|------|-----|------|-----|------|-----|------|----|----|-----|-------------------|-----|------|
| PRWP1S-C | 5.2 | 132 | .190 | 4.8 | .052 | 1.3 | .250 | 6.4 | .105 | 2.7 | 1.00 | 25 | 50 | 222 | Hand install only | 100 | 1000 |
| PRWP1SA-D | 5.1 | 130 | .190 | 4.8 | .052 | 1.3 | .187 | 4.7 | .093 | 2.4 | 1.00 | 25 | 50 | 222 | | 500 | 5000 |
| PRWP1SB-D | 5.2 | 132 | .190 | 4.8 | .052 | 1.3 | .187 | 4.7 | .157 | 4.0 | 1.00 | 25 | 50 | 222 | | 500 | 5000 |
| PRWP1.5S-D | 6.8 | 173 | .190 | 4.8 | .052 | 1.3 | .250 | 6.4 | .105 | 2.7 | 1.50 | 38 | 50 | 222 | | 500 | 5000 |
| PRWP2S-D | 7.8 | 198 | .190 | 4.8 | .052 | 1.3 | .250 | 6.4 | .105 | 2.7 | 1.75 | 45 | 50 | 222 | | 500 | 5000 |

Light-Heavy Cross Section

| | | | | | | | | | | | | | | | | | |
|-----------|-----|-----|------|-----|------|-----|------|-----|------|-----|------|----|-----|-----|-------------------|-----|------|
| PRWP2H-TL | 8.9 | 226 | .300 | 7.6 | .075 | 1.9 | .266 | 6.8 | .105 | 2.7 | 2.00 | 51 | 120 | 534 | Hand install only | 250 | 2500 |
|-----------|-----|-----|------|-----|------|-----|------|-----|------|-----|------|----|-----|-----|-------------------|-----|------|

Weather Resistant Nylon 6.6

Standard Cross Section

| | | | | | | | | | | | | | | | | | |
|--------------------|-----|-----|------|-----|------|-----|------|-----|------|-----|------|----|----|-----|-------------------|-----|------|
| PRWP1S-D0 | 5.2 | 132 | .190 | 4.8 | .052 | 1.3 | .250 | 6.4 | .105 | 2.7 | 1.00 | 25 | 50 | 222 | Hand install only | 500 | 5000 |
| PRWP1.5S-D0 | 6.8 | 173 | .190 | 4.8 | .052 | 1.3 | .250 | 6.4 | .105 | 2.7 | 1.50 | 38 | 50 | 222 | | 500 | 5000 |
| PRWP2S-D0 | 7.8 | 198 | .190 | 4.8 | .052 | 1.3 | .250 | 6.4 | .105 | 2.7 | 1.75 | 45 | 50 | 222 | | 500 | 5000 |

Heat Stabilized Nylon 6.6

Standard Cross Section

| | | | | | | | | | | | | | | | | | |
|--------------|-----|-----|------|-----|------|-----|------|-----|------|-----|------|----|----|-----|-------------------|-----|------|
| PRWP1.5S-D30 | 6.8 | 173 | .190 | 4.8 | .052 | 1.3 | .250 | 6.4 | .105 | 2.7 | 1.50 | 38 | 50 | 222 | Hand install only | 500 | 5000 |
|--------------|-----|-----|------|-----|------|-----|------|-----|------|-----|------|----|----|-----|-------------------|-----|------|

Note: UL Recognized and CSA Certified except PRWP2H.

UL US CSA US PAN-TY® Center Mounted Wing Push Mount Ties – Heat Stabilized Nylon 6.6

- For high temperature applications up to 239°F (115°C) – indoor use
- Used to center the bundle over the mount on all bundle diameters
- Cable tie, mount, and fastener in a single part
- Anchor is easily pressed into a pre-formed hole and locks in place
- Wings provide constant tension for a stable, secure, and rattle-free installation
- Curved tip is easy to pick up from flat surfaces and allows faster initial threading to speed installation



PLWP-SC – Designed for normal wire bundles.

PLWP-SD – Designed for corrugated loom tubing. Bump prevents lateral and axial movement.

PLWP-SE – Designed for corrugated loom tubing, see page C3.11. Bump prevents lateral movement.

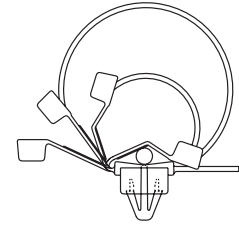

Bundle diameters from .12" to 1.97" (3mm to 50mm)

| Part Number | Length | | Width | | Thickness | | Nominal Hole Dia. | | Max. Panel Thickness | | Max. Bundle Dia. | | Min. Loop Tensile Str. | | Recommended Installation Tool | Std. Pkg. Qty. | Std. Ctn. Qty. |
|-------------------------------|--------|-----|-------|-----|-----------|-----|-------------------|-----|----------------------|-----|------------------|----|------------------------|-----|--|----------------|----------------|
| | In. | mm | In. | mm | In. | mm | In. | mm | In. | mm | In. | mm | Lbs. | N | | | |
| Standard Cross Section | | | | | | | | | | | | | | | | | |
| PLWP30SC-D30 | 5.8 | 147 | .190 | 4.8 | .050 | 1.3 | .266 | 6.8 | .118 | 3.0 | 1.18 | 30 | 50 | 222 | GTS, GTSL, GS2B, GTH, GS4H, PTS, PTH, PPTS, STS2, STH2 | 500 | 5000 |
| PLWP40SC-D30 | 7.0 | 178 | .190 | 4.8 | .050 | 1.3 | .266 | 6.8 | .118 | 3.0 | 1.58 | 40 | 50 | 222 | | 500 | 5000 |
| PLWP40SD-D30 | 7.0 | 178 | .190 | 4.8 | .050 | 1.3 | .266 | 6.8 | .118 | 3.0 | 1.58 | 40 | 50 | 222 | | 500 | 5000 |
| PLWP50SC-D30 | 8.2 | 208 | .190 | 4.8 | .050 | 1.3 | .266 | 6.8 | .118 | 3.0 | 1.97 | 50 | 50 | 222 | | 500 | 5000 |
| PLWP50SE-D30 | 8.2 | 208 | .190 | 4.8 | .050 | 1.3 | .266 | 6.8 | .118 | 3.0 | 1.97 | 50 | 50 | 222 | | 500 | 5000 |

A. System Overview

B1. Cable Ties

B2. Cable Accessories

B3. Stainless Steel Ties

C1. Wiring Duct

C2. Surface Raceway

C3. Abrasion Protection

C4. Cable Management

D1. Terminals

D2. Power Connectors

D3. Grounding Connectors

E1. Labeling Systems

E2. Labels

E3. Pre-Printed & Write-On Markers

E4. Permanent Identification

E5. Lockout/Tagout & Safety Solutions

F. Index

A. System Overview

B1. Cable Ties

B2. Cable Accessories

B3. Stainless Steel Ties

C1. Wiring Duct

C2. Surface Raceway

C3. Abrasion Protection

C4. Cable Management

D1. Terminals

D2. Power Connectors

D3. Grounding Connectors

E1. Labeling Systems

E2. Labels

E3. Pre-Printed & Write-On Markers

E4. Permanent Identification

E5. Lockout/Tagout & Safety Solutions

F. Index



PAN-TY® Ladder Style Releasable Wing Push Mount Ties – Heat Stabilized Nylon 6.6

- For high temperature applications up to 239°F (115°C) – indoor use
- Unique releasable ladder design eliminates the need for multiple clamp sizes
- Cable tie, mount, and fastener in a single part

- Used to attach bundles to another surface such as a flat panel
- Anchor is easily pressed into a pre-formed hole and locks in place
- Wings provide constant tension for a stable, secure, and rattle-free installation
- Curved tip is easy to pick up from flat surfaces and allows faster initial threading to speed installation

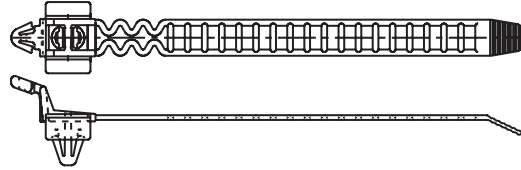
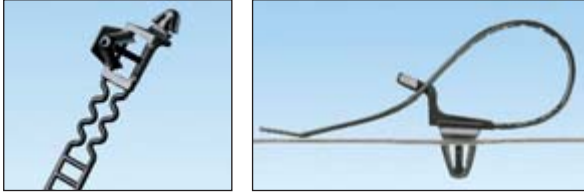

| Part Number | Length | | Width | | Thickness | | Nominal Hole Dia. | | Max. Panel Thickness | | Max. Bundle Dia. | | Min. Loop Tensile Str. | | Recommended Installation Tool | Std. Pkg. Qty. | Std. Ctn. Qty. |
|-------------------------------|--------|-----|-------|-----|-----------|-----|-------------------|-----|----------------------|-----|------------------|----|------------------------|-----|-------------------------------|----------------|----------------|
| | In. | mm | In. | mm | In. | mm | In. | mm | In. | mm | In. | mm | Lbs. | N | | | |
| Standard Cross Section | | | | | | | | | | | | | | | | | |
| PRLWP30S-D30 | 4.7 | 119 | .380 | 9.7 | .050 | 1.3 | .266 | 6.8 | .118 | 3.0 | 1.43 | 36 | 35 | 156 | Hand install only | 500 | 5000 |
| PRLWP50S-D30 | 7.1 | 180 | .380 | 9.7 | .050 | 1.3 | .266 | 6.8 | .118 | 3.0 | 2.18 | 55 | 35 | 156 | | 500 | 5000 |

PAN-TY® Umbrella Wing Push Mount Ties – Nylon and Heat Stabilized Nylon 6.6

- Natural nylon material for indoor use
- Heat stabilized material for high temperature applications up to 239°F (115°C) – indoor use
- Quick, secure way to fasten to clearance holes in panel
- Anchor is easily pressed into a pre-formed hole in a light gauge metal or plastic and locks in place

- Umbrella shaped disk provides constant tension for a stable, secure, and rattle-free installation
- Disk forms a dust-tight and semi-liquid tight seal to the panel surface
- PLUP40SE style is for use with corrugated loom tubing, see page C3.11
- Curved tip is easy to pick up from flat surfaces and allows faster initial threading to speed installation

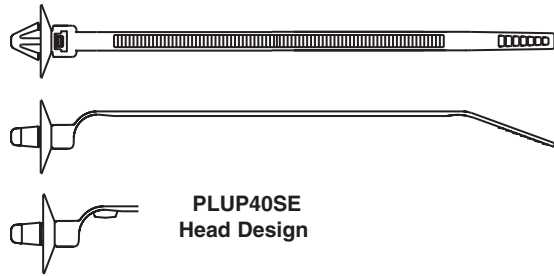
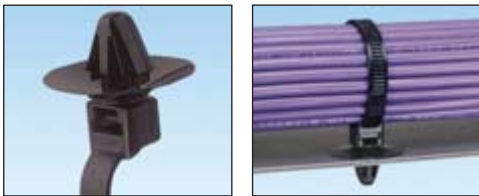

| Part Number | Length | | Width | | Thickness | | Nominal Hole Dia. | | Max. Panel Thickness | | Max. Bundle Dia. | | Min. Loop Tensile Str. | | Recommended Installation Tool | Std. Pkg. Qty. | Std. Ctn. Qty. |
|-------------------------------|--------|-----|-------|-----|-----------|-----|-------------------|-----|----------------------|-----|------------------|----|------------------------|-----|--|----------------|----------------|
| | In. | mm | In. | mm | In. | mm | In. | mm | In. | mm | In. | mm | Lbs. | N | | | |
| Standard Cross Section | | | | | | | | | | | | | | | | | |
| PLUP40S-D30* | 7.0 | 177 | .190 | 4.8 | .047 | 1.2 | .266 | 6.8 | .050 | 1.3 | 1.57 | 40 | 50 | 222 | GTS, GTSL, GS2B, GTH, GS4H, PTS, PTH, PPTS, STS2, STH2 | 500 | 5000 |
| PLUP40SE-D | 7.0 | 177 | .190 | 4.8 | .047 | 1.2 | .266 | 6.8 | .050 | 1.3 | 1.57 | 40 | 50 | 222 | | 500 | 5000 |
| PLUP40SE-D30* | 7.0 | 177 | .190 | 4.8 | .047 | 1.2 | .266 | 6.8 | .050 | 1.3 | 1.57 | 40 | 50 | 222 | | 500 | 5000 |

*Heat stabilized material (30).

PAN-TY® Push Mount Ties

- Natural nylon material for indoor use
- Weather resistant material has greater resistance to damage caused by ultraviolet light – indoor or outdoor use
- Heat stabilized material for high temperature applications up to 239°F (115°C) – indoor use
- *Wingless* design allows tie to be used in confined spaces

- Cable tie, mount, and fastener in a single part
- Economical push mount ties are used to attach bundles to another surface such as a flat panel
- Anchor is easily pressed into a pre-formed hole and locks in place
- Curved tip is easy to pick up from flat surfaces and allows faster initial threading to speed installation



PLP2S-C

PLP2S-M0

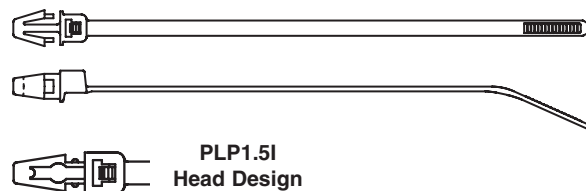

PLP1.5I Head Design

| Part Number | Length | | Width | | Thickness | | Nominal Hole Dia. | | Max. Panel Thickness | | Max. Bundle Dia. | | Min. Loop Tensile Str. | | Recommended Installation Tool | Std. Pkg. Qty. | Std. Ctn. Qty. |
|-------------|--------|----|-------|----|-----------|----|-------------------|----|----------------------|----|------------------|----|------------------------|---|-------------------------------|----------------|----------------|
| | In. | mm | In. | mm | In. | mm | In. | mm | In. | mm | In. | mm | Lbs. | N | | | |

Nylon 6.6

Intermediate Cross Section

| | | | | | | | | | | | | | | | | | |
|-----------|-----|-----|------|-----|------|-----|------|-----|------|-----|------|----|----|-----|----------------------------------|-----|------|
| PLP1.5I-C | 6.1 | 156 | .135 | 3.4 | .045 | 1.1 | .187 | 4.7 | .093 | 2.4 | 1.25 | 32 | 40 | 178 | GTS, GTSL, GS2B, PTS, PPTS, STS2 | 100 | 1000 |
|-----------|-----|-----|------|-----|------|-----|------|-----|------|-----|------|----|----|-----|----------------------------------|-----|------|

Standard Cross Section

| | | | | | | | | | | | | | | | | | |
|----------------|-----|-----|------|-----|------|-----|------|-----|------|-----|------|----|----|-----|--|------|-------|
| PLP1S-M | 5.3 | 135 | .180 | 4.6 | .050 | 1.3 | .250 | 6.4 | .125 | 3.2 | 1.00 | 25 | 50 | 222 | GTS, GTSL, GS2B, GTH, GS4H, PTS, PTH, PPTS, STS2, STH2 | 1000 | 10000 |
| PLP1.5S-M | 6.7 | 170 | .180 | 4.6 | .050 | 1.3 | .250 | 6.4 | .125 | 3.2 | 1.50 | 38 | 50 | 222 | | 1000 | 10000 |
| PLP2S-C | 7.9 | 200 | .180 | 4.6 | .050 | 1.3 | .250 | 6.4 | .125 | 3.2 | 1.75 | 45 | 50 | 222 | | 100 | 1000 |

Weather Resistant Nylon 6.6

Intermediate Cross Section

| | | | | | | | | | | | | | | | | | |
|------------|-----|-----|------|-----|------|-----|------|-----|------|-----|------|----|----|-----|----------------------------------|------|-------|
| PLP1.5I-M0 | 6.1 | 156 | .135 | 3.4 | .045 | 1.1 | .187 | 4.7 | .093 | 2.4 | 1.25 | 32 | 40 | 178 | GTS, GTSL, GS2B, PTS, PPTS, STS2 | 1000 | 25000 |
|------------|-----|-----|------|-----|------|-----|------|-----|------|-----|------|----|----|-----|----------------------------------|------|-------|

Standard Cross Section

| | | | | | | | | | | | | | | | | | |
|-----------------|-----|-----|------|-----|------|-----|------|-----|------|-----|------|----|----|-----|--|------|-------|
| PLP1S-M0 | 5.3 | 135 | .180 | 4.6 | .050 | 1.3 | .250 | 6.4 | .125 | 3.2 | 1.00 | 25 | 50 | 222 | GTS, GTSL, GS2B, GTH, GS4H, PTS, PTH, PPTS, STS2, STH2 | 1000 | 10000 |
| PLP2S-M0 | 7.9 | 200 | .180 | 4.6 | .050 | 1.3 | .250 | 6.4 | .125 | 3.2 | 1.75 | 45 | 50 | 222 | | 1000 | 10000 |

Heat Stabilized Nylon 6.6

Intermediate Cross Section

| | | | | | | | | | | | | | | | | | |
|-------------|-----|-----|------|-----|------|-----|------|-----|------|-----|------|----|----|-----|----------------------------------|------|-------|
| PLP1.5I-M30 | 6.1 | 156 | .135 | 3.4 | .045 | 1.1 | .187 | 4.7 | .093 | 2.4 | 1.25 | 32 | 40 | 178 | GTS, GTSL, GS2B, PTS, PPTS, STS2 | 1000 | 25000 |
|-------------|-----|-----|------|-----|------|-----|------|-----|------|-----|------|----|----|-----|----------------------------------|------|-------|

Standard Cross Section

| | | | | | | | | | | | | | | | | | |
|-----------|-----|-----|------|-----|------|-----|------|-----|------|-----|------|----|----|-----|--|------|-------|
| PLP1S-M30 | 5.3 | 135 | .180 | 4.6 | .050 | 1.3 | .250 | 6.4 | .125 | 3.2 | 1.00 | 25 | 50 | 222 | GTS, GTSL, GS2B, GTH, GS4H, PTS, PTH, PPTS, STS2, STH2 | 1000 | 10000 |
| PLP2S-M30 | 7.9 | 200 | .180 | 4.6 | .050 | 1.3 | .250 | 6.4 | .125 | 3.2 | 1.75 | 45 | 50 | 222 | | 1000 | 10000 |

A. System Overview

B1. Cable Ties

B2. Cable Accessories

B3. Stainless Steel Ties

C1. Wiring Duct

C2. Surface Raceway

C3. Abrasion Protection

C4. Cable Management

D1. Terminals

D2. Power Connectors

D3. Grounding Connectors

E1. Labeling Systems

E2. Labels

E3. Pre-Printed & Write-On Markers

E4. Permanent Identification

E5. Lockout/Tagout & Safety Solutions

F. Index

A. System Overview

UL US C_{UL} SP US PAN-TY® Marker and Flag Ties

- Natural nylon material for indoor use
- Weather resistant material has greater resistance to damage caused by ultraviolet light – indoor or outdoor use
- Flame retardant material has a flammability rating of UL 94V-0 – for indoor use
- Used to fasten and identify bundles at the same time
- One-piece construction for consistent performance and reliability
- Can be marked with *PANDUIT* marker pens on page B1.51 or computer printable labels
- Custom imprinting with text, symbols, or trademarks available using *PANDUIT* Custom Hot Stamping Service, see page B1.91
- Curved tip is easy to pick up from flat surfaces and allows faster initial threading to speed installation

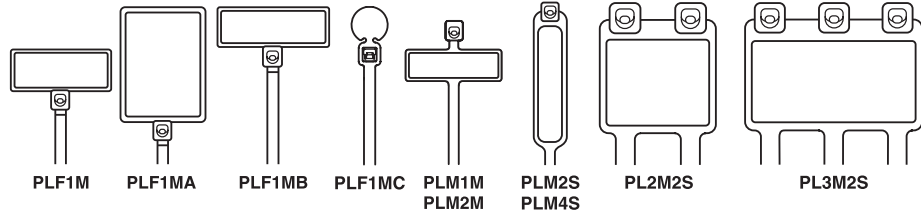
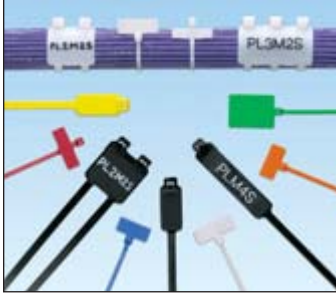

B1. Cable Ties

B2. Cable Accessories

B3. Stainless Steel Ties

C1. Wiring Duct

C2. Surface Raceway

C3. Abrasion Protection

C4. Cable Management

D1. Terminals

D2. Power Connectors

D3. Grounding Connectors

E1. Labeling Systems

E2. Labels

E3. Pre-Printed & Write-On Markers

E4. Permanent Identification

E5. Lockout/Tagout & Safety Solutions

F. Index

| Part Number | Marker Type | Length | | Width | | Thickness | | Marker Write-On Area | | Max. Bundle Dia. | | Min. Loop Tensile Str. | | Recommended Installation Tool | Std. Pkg. Qty. | Std. Ctn. Qty. |
|-------------|-------------|--------|----|-------|----|-----------|----|----------------------|----|------------------|----|------------------------|---|-------------------------------|----------------|----------------|
| | | In. | mm | In. | mm | In. | mm | In. | mm | In. | mm | Lbs. | N | | | |

Nylon 6.6

Miniature Cross Section

| | | | | | | | | | | | | | | | | |
|-----------------|------|-----|-----|------|-----|------|-----|------------|-------------|------|----|----|----|----------------------------------|------|-------|
| PLF1M-C | Flag | 4.3 | 109 | .098 | 2.5 | .045 | 1.1 | .31 x .75 | 7.9 x 19.1 | .87 | 22 | 18 | 80 | GTS, GTSL, GS2B, PTS, PPTS, STS2 | 100 | 1000 |
| PLF1MA-C | Flag | 5.1 | 130 | .098 | 2.5 | .045 | 1.1 | .76 x 1.04 | 19.1 x 26.4 | .87 | 22 | 18 | 80 | | 100 | 1000 |
| PLF1MB-C | Flag | 4.0 | 101 | .098 | 2.5 | .045 | 1.1 | .31 x .92 | 7.9 x 23.4 | .75 | 19 | 18 | 80 | | 100 | 1000 |
| PLF1MC-M | Flag | 4.3 | 109 | .098 | 2.5 | .045 | 1.1 | .29 x .32 | 7.4 x 8.0 | .87 | 22 | 18 | 80 | | 1000 | 25000 |
| PLM1M-C | Wrap | 3.9 | 99 | .098 | 2.5 | .035 | .9 | .26 x .95 | 6.6 x 24.1 | .75 | 19 | 18 | 80 | | 100 | 1000 |
| PLM2M-C | Wrap | 8.0 | 203 | .098 | 2.5 | .035 | .9 | .26 x .95 | 6.6 x 24.1 | 2.00 | 51 | 18 | 80 | | 100 | 1000 |

Standard Cross Section

| | | | | | | | | | | | | | | | | |
|-----------------|------|------|-----|------|-----|------|-----|------------|-------------|------|-----|----|-----|--|-----|------|
| PLM2S-C | Wrap | 7.4 | 188 | .185 | 4.7 | .052 | 1.3 | .44 x .87 | 11.1 x 22.1 | 1.75 | 45 | 50 | 222 | GTS, GTSL, GS2B, GTH, GS4H, PTS, PTH, PPTS, STS2, STH2 | 100 | 1000 |
| PLM4S-C | Wrap | 14.6 | 371 | .185 | 4.7 | .052 | 1.3 | .44 x 2.00 | 11.1 x 50.8 | 4.00 | 102 | 50 | 222 | | 100 | 1000 |
| PL2M2S-L | Wrap | 7.4 | 188 | .185 | 4.7 | .052 | 1.3 | .87 x 1.07 | 22.1 x 27.2 | 1.75 | 45 | 50 | 222 | | 50 | 500 |
| PL3M2S-L | Wrap | 7.4 | 188 | .185 | 4.7 | .052 | 1.3 | .87 x 1.79 | 22.1 x 45.5 | 1.75 | 45 | 50 | 222 | | 50 | 500 |

Weather Resistant Nylon 6.6

Miniature Cross Section

| | | | | | | | | | | | | | | | | |
|------------------|------|-----|-----|------|-----|------|-----|------------|-------------|------|----|----|----|----------------------------------|------|-------|
| PLF1M-C0 | Flag | 4.3 | 109 | .098 | 2.5 | .045 | 1.1 | .31 x .75 | 7.9 x 19.1 | .87 | 22 | 18 | 80 | GTS, GTSL, GS2B, PTS, PPTS, STS2 | 100 | 1000 |
| PLF1MA-M0 | Flag | 5.1 | 130 | .098 | 2.5 | .045 | 1.1 | .76 x 1.04 | 19.1 x 26.4 | .87 | 22 | 18 | 80 | | 1000 | 10000 |
| PLM1M-C0 | Wrap | 3.9 | 99 | .098 | 2.5 | .035 | .9 | .26 x .95 | 6.6 x 24.1 | .75 | 19 | 18 | 80 | | 100 | 1000 |
| PLM2M-M0 | Wrap | 8.0 | 203 | .098 | 2.5 | .035 | .9 | .26 x .95 | 6.6 x 24.1 | 2.00 | 51 | 18 | 80 | | 1000 | 25000 |

Standard Cross Section

| | | | | | | | | | | | | | | | | |
|------------------|------|------|-----|------|-----|------|-----|------------|-------------|------|-----|----|-----|--|-----|------|
| PLM2S-C0 | Wrap | 7.4 | 188 | .185 | 4.7 | .052 | 1.3 | .44 x .87 | 11.1 x 22.1 | 1.75 | 45 | 50 | 222 | GTS, GTSL, GS2B, GTH, GS4H, PTS, PTH, PPTS, STS2, STH2 | 100 | 1000 |
| PLM4S-D0 | Wrap | 14.6 | 371 | .185 | 4.7 | .052 | 1.3 | .44 x 2.00 | 11.1 x 50.8 | 4.00 | 102 | 50 | 222 | | 500 | 5000 |
| PL2M2S-L0 | Wrap | 7.4 | 188 | .185 | 4.7 | .052 | 1.3 | .87 x 1.07 | 22.1 x 27.2 | 1.75 | 45 | 50 | 222 | | 50 | 500 |
| PL3M2S-D0 | Wrap | 7.4 | 188 | .185 | 4.7 | .052 | 1.3 | .87 x 1.79 | 22.1 x 45.5 | 1.75 | 45 | 50 | 222 | | 500 | 2500 |

Flame Retardant Nylon 6.6

Miniature Cross Section

| | | | | | | | | | | | | | | | | |
|------------------|------|-----|-----|------|-----|------|-----|-----------|------------|-----|----|----|----|----------------------------------|------|-------|
| PLF1M-M69 | Flag | 4.3 | 109 | .098 | 2.5 | .045 | 1.1 | .31 x .75 | 7.9 x 19.1 | .87 | 22 | 18 | 80 | GTS, GTSL, GS2B, PTS, PPTS, STS2 | 1000 | 25000 |
| PLM1M-M69 | Wrap | 3.9 | 99 | .098 | 2.5 | .035 | .9 | .26 x .95 | 6.6 x 24.1 | .75 | 19 | 18 | 80 | | 1000 | 25000 |

PAN-TY® Cable Ties

Material and Color Chart

| Material | Color | PANDUIT Suffix |
|--|----------------|----------------|
| Nylon 6.6 | Natural | ✓ |
| Weather Resistant Nylon 6.6 | Black | 0 |
| Weather Resistant Nylon 6.6 (meets Mil. Spec.) | Black | 00 |
| Nylon 6.6 | Brown | 1 |
| Nylon 6.6 | Red | 2 |
| Nylon 6.6 | Orange | 3 |
| Nylon 6.6 | Yellow | 4Y |
| Nylon 6.6 | Green | 5 |
| Nylon 6.6 | Blue | 6 |
| Nylon 6.6 | Purple | 7 |
| Nylon 6.6 | Gray | 8 |
| Nylon 6.6 | White | 10 |
| Nylon 6.6 | Telephone Gray | 14 |
| Nylon 6.6 | Black | 20 |
| Heat Stabilized Nylon 6.6 | Black | 30 |

| Material | Color | PANDUIT Suffix |
|---|--------------------|----------------|
| Heat Stabilized Nylon 6.6 | Natural | 39 |
| Nylon 6.6 | Fluorescent Orange | 53 |
| Nylon 6.6 | Fluorescent Yellow | 54 |
| Nylon 6.6 | Fluorescent Green | 55 |
| Nylon 6.6 | Fluorescent Pink | 59 |
| Flame Retardant Nylon 6.6 | Black | 60 |
| Flame Retardant Nylon 6.6 | Natural (Ivory) | 69 |
| PEEK (Polyetheretherketone) | Translucent Brown | 71 |
| TEFZEL* | Aqua Blue | 76 |
| Metal Detectable | Blue | 86 |
| Weather Resistant Polypropylene | Black | 100 |
| Polypropylene | Green | 109 |
| Nylon 12 | Black | 120 |
| Heat Stabilized Weather Resistant Nylon 6.6 | Black | 300 |
| HALAR* | Maroon | 702Y |

✓ Denotes PANDUIT Natural Nylon 6.6 (no suffix).

*TEFZEL is a registered trademark of E.I. du Pont de Nemours and Company.

*HALAR is a registered trademark of Solvay Solexis, Inc.

Part Number Availability List

| Standard Packaging | | | Bulk Packaging | | |
|--------------------|-------------------|-----------------------|----------------|-------------------|--------------------------|
| Part Number | Natural Nylon 6.6 | Material/Color Suffix | Part Number | Natural Nylon 6.6 | Material/Color Suffix |
| PLC1M-S4-C | ✓ | 0 | PLC1M-S4-M | ✓ | 0,30 |
| PLC1.5I-S8-C | ✓ | 0 | PLC1.5I-S8-M | ✓ | 0,30 |
| PLC2S-S6-C | ✓ | 0 | PLC2S-S6-M | ✓ | 0 |
| PLC2S-S10-C | ✓ | 0,14 | PLC2S-S10-M | ✓ | 0,20,30 |
| PLC3S-S10-C | ✓ | 0 | PLC3S-S10-M | ✓ | 0 |
| PLC4S-S10-C | ✓ | 0 | PLC4S-S10-M | ✓ | 0,30 |
| PLC2H-S25-L | ✓ | | PLC2H-S25-TL | ✓ | 0,30 |
| PLC4H-S25-L | ✓ | 0 | PLC4H-S25-TL | ✓ | 0,30 |
| PLF1M-C | ✓ | 0 | PLF1M-M | ✓ | 0,2,3,4Y,6,10,69 |
| PLF1MA-C | ✓ | 3,4Y | PLF1MA-M | ✓ | 0,2,3,4Y,5,6,10 |
| PLF1MB-C | ✓ | | PLF1MB-M | ✓ | |
| | | | PLF1MC-M | | 3 |
| PLM1M-C | ✓ | 0 | PLM1M-M | ✓ | 0,1,2,3,4Y,5,6,7,8,10,69 |
| PLM2M-C | ✓ | | PLM2M-M | ✓ | 0,4Y,6 |
| PLM2S-C | ✓ | 0,4Y | PLM2S-D | ✓ | 0,2,3,4Y,5,6,8 |
| PLM4S-C | ✓ | | PLM4S-D | ✓ | 0,2,4Y,6 |

List continues on page B1.36

A.
System
Overview

B1.
Cable
Ties

B2.
Cable
Accessories

B3.
Stainless
Steel Ties

C1.
Wiring
Duct

C2.
Surface
Raceway

C3.
Abrasion
Protection

C4.
Cable
Management

D1.
Terminals

D2.
Power
Connectors

D3.
Grounding
Connectors

E1.
Labeling
Systems

E2.
Labels

E3.
Pre-Printed
& Write-On
Markers

E4.
Permanent
Identification

E5.
Lockout/
Tagout
& Safety
Solutions

F.
Index

A.
System
Overview

PAN-TY® Cable Ties (continued)

B1.
Cable Ties

B2.
Cable
Accessories

B3.
Stainless
Steel Ties

C1.
Wiring
Duct

C2.
Surface
Raceway

C3.
Abrasion
Protection

C4.
Cable
Management

D1.
Terminals

D2.
Power
Connectors

D3.
Grounding
Connectors

E1.
Labeling
Systems

E2.
Labels

E3.
Pre-Printed
& Write-On
Markers

E4.
Permanent
Identification

E5.
Lockout/
Tagout/
& Safety
Solutions

F.
Index

| Standard Packaging | | | Bulk Packaging | | |
|--------------------|-------------------|--|----------------|-------------------|---|
| Part Number | Natural Nylon 6.6 | Material/Color Suffix | Part Number | Natural Nylon 6.6 | Material/Color Suffix |
| PL2M2S-L | ✓ | 0 | PL2M2S-D | ✓ | 0,4Y,10 |
| PL3M2S-L | ✓ | | PL3M2S-D | ✓ | 0,4Y |
| PLP1.5I-C | ✓ | | PLP1.5I-M | ✓ | 0,30 |
| | | | PLP1S-M | ✓ | 0,30 |
| | | | PLP1.5S-M | ✓ | |
| PLP2S-C | ✓ | | PLP2S-M | ✓ | 0,30 |
| PLT.6SM-C | ✓ | 0 | PLT.6SM-M | ✓ | 0,30 |
| PLT.7M-C | ✓ | | PLT.7M-M | ✓ | 0,30 |
| PLT1M-C | ✓ | 0,00,1,2,3,4Y,5,6,7,8,10,14,30,76,86,702Y | PLT1M-M | ✓ | 0,00,1,2,3,4Y,5,6,7,8,10,14,20,30,53,54,55,59,60,69,76,100,109,300,702Y |
| | | | PLT1M-XMR | ✓ | 0,1,2,3,4Y,5,6,7,8,10,30 |
| PLT1.5M-C | ✓ | 0 | PLT1.5M-M | ✓ | 0,00,1,2,3,4Y,5,6,7,8,10,14,20,30 |
| | | | PLT1.5M-XMR | ✓ | 0,00,30 |
| PLT2M-C | ✓ | 0 | PLT2M-M | ✓ | 0,1,2,3,4Y,5,6,7,8,10,20,30,69 |
| PLT1.5I-C | ✓ | 0,1,2,3,4Y,5,6,7,8,10,20,30 | PLT1.5I-M | ✓ | 0,00,1,2,3,4Y,5,6,7,8,10,20,30,69,100,109,120,300 |
| PLT2I-C | ✓ | 0,14,30,76,86 | PLT2I-M | ✓ | 0,00,1,2,3,4Y,5,6,7,8,10,14,20,30,53,54,55,59,69,76,300 |
| PLT2.5I-C | ✓ | 0 | PLT2.5I-M | ✓ | 0,20 |
| PLT3I-C | ✓ | 0,14 | PLT3I-M | ✓ | 0,2,3,4Y,5,6,8,10,14,20,30 |
| PLT4I-C | ✓ | 0,14 | PLT4I-M | ✓ | 0,2,5,6,14,20,30 |
| PLT1S-C | ✓ | 0 | PLT1S-M | ✓ | 0,30,38,300 |
| PLT1.5S-C | ✓ | 0 | PLT1.5S-M | ✓ | 0,30 |
| PLT2S-C | ✓ | 0,00,1,2,3,4Y,5,6,7,8,10,20,30,71,76,86,702Y | PLT2S-M | ✓ | 0,00,1,2,3,4Y,5,6,7,8,10,20,30,38,39,53,54,55,59,60,69,71,76,100,109,120,300,702Y |
| | | | PLT2S-VMR | ✓ | 0,30 |
| PLT2.5S-C | ✓ | 0 | PLT2.5S-M | ✓ | 0,30 |
| PLT3S-C | ✓ | 0,00,2,20,30,76,86,702Y | PLT3S-M | ✓ | 0,00,1,2,3,4Y,5,6,7,8,10,20,30,53,54,55,59,76,100,109,702Y |
| PLT4S-C | ✓ | 0,00,2,3,4Y,5,6,8,20,30,76,86 | PLT4S-M | ✓ | 0,00,1,2,3,4Y,5,6,7,8,10,14,20,30,69,76,100,109,120,300 |
| PLT4.5S-C | ✓ | 0 | PLT4.5S-M | ✓ | 0 |
| PLT5S-C | ✓ | 0 | PLT5S-M | ✓ | 0,2,3,4Y,5,6,8,30 |
| PLT6LH-L | ✓ | 0 | PLT6LH-C | ✓ | 0 |
| PLT7LH-L | ✓ | 0 | PLT7LH-C | ✓ | 0,30 |
| PLT8LH-L | ✓ | 0 | PLT8LH-C | ✓ | 0,120 |
| PLT8LH-Q | | 0 | | | |
| PLT9LH-L | ✓ | 0 | PLT9LH-C | ✓ | 0,30 |
| PLT10LH-L | ✓ | | PLT10LH-C | ✓ | |
| PLT2H-L | ✓ | 0 | PLT2H-TL | ✓ | 0,2,4Y,6,30,100,109,300 |
| PLT2.5H-L | ✓ | 0 | PLT2.5H-TL | ✓ | 0 |
| PLT3H-L | ✓ | 0,76,86 | PLT3H-TL | ✓ | 0,30,76,100,109 |
| PLT4H-L | ✓ | 0,00,76,86 | PLT4H-TL | ✓ | 0,00,1,2,3,4Y,5,6,10,20,30,69,76,100,109,120,300 |
| PLT4H-C | ✓ | 0 | | | |
| PLT5H-L | ✓ | 0 | PLT5H-C | ✓ | 0,30 |
| PLT6H-L | ✓ | 0 | PLT6H-C | ✓ | 0,30 |
| PLT8H-L | ✓ | 0 | PLT8H-C | ✓ | 0,00,30 |
| PLT8H-L | ✓ | 0 | | | |
| PLT13H-Q | ✓ | 0 | PLT13H-C | ✓ | 0,3 |

| Standard Packaging | | | Bulk Packaging | | |
|--------------------|-------------------|-----------------------|----------------|-------------------|-----------------------|
| Part Number | Natural Nylon 6.6 | Material/Color Suffix | Part Number | Natural Nylon 6.6 | Material/Color Suffix |
| PLT2EH-Q | | 0 | PLT2EH-C | ✓ | 0 |
| | | | PLT3EH-NB-C | | 0 |
| PLT5EH-Q | ✓ | 0 | PLT5EH-C | ✓ | 0 |
| | | | PLT5EH-NB-C | | 0 |
| PLT6EH-Q | ✓ | 0 | PLT6EH-C | ✓ | 0 |
| | | | PLT6EH-NB-C | | 0 |
| PLT8EH-Q | | 0 | PLT8EH-C | ✓ | 0 |
| PLT10EH-Q | | 0 | PLT10EH-C | ✓ | 0 |
| PLT12EH-Q | | 0 | PLT12EH-C | ✓ | 0 |
| | | | PLUP40S-D | | 30 |
| | | | PLUP40SE-D | ✓ | 30 |
| PLWP1M-C | ✓ | | PLWP1M-D | ✓ | 0,30 |
| PLWP1.5I-C | ✓ | | PLWP1.5I-D | ✓ | 30 |
| PLWP1S-C | ✓ | 0 | PLWP1S-D | ✓ | 0,20,30 |
| | | | PLWP1SA-D | ✓ | |
| | | | PLWP1SB-D | ✓ | |
| | | | PLWP1.5S-D | ✓ | 30 |
| | | | PLWP1.5SA-D | ✓ | |
| PLWP2S-C | ✓ | 0 | PLWP2S-D | ✓ | 0,30 |
| | | | PLWP2SA-D | ✓ | |
| | | | PLWP2SB-D | ✓ | |
| | | | PLWP2H-TL | ✓ | 0,30 |
| | | | PLWP3H-TL | ✓ | 0 |
| | | | PLWP30SC-D | | 30 |
| | | | PLWP40SC-D | | 30 |
| | | | PLWP40SD-D | | 30 |
| | | | PLWP50SC-D | | 30 |
| | | | PLWP50SE-D | | 30 |
| | | | PRLWP30S-D | | 30 |
| | | | PRLWP50S-D | | 30 |
| PRT1S-C | ✓ | 0 | PRT1S-M | ✓ | 0 |
| PRT1.5S-C | ✓ | 0 | PRT1.5S-M | ✓ | 0,30 |
| PRT2S-C | ✓ | 0 | PRT2S-M | ✓ | 0,2,3,4Y,6,7 |
| PRT3S-C | ✓ | 0 | PRT3S-M | ✓ | 0 |
| PRT4S-C | ✓ | 0 | PRT4S-M | ✓ | 0,2,3,4Y,6 |
| PRT2H-L | ✓ | 0 | PRT2H-TL | ✓ | 0 |
| PRT3H-L | ✓ | 0 | PRT3H-TL | ✓ | 0 |
| PRT4H-L | ✓ | 0 | PRT4H-TL | ✓ | 0 |
| PRT2EH-Q | | 0 | PRT2EH-C | ✓ | 0,100 |
| PRT5EH-Q | ✓ | 0 | PRT5EH-C | ✓ | 0,100 |
| PRT6EH-Q | ✓ | 0 | PRT6EH-C | ✓ | 0,100 |
| PRT8EH-Q | | 0 | PRT8EH-C | ✓ | 0,100 |
| PRT10EH-Q | | 0 | PRT10EH-C | ✓ | 0 |
| PRT12EH-Q | | 0 | PRT12EH-C | ✓ | 0 |
| PRWP1S-C | ✓ | | PRWP1S-D | ✓ | 0 |
| | | | PRWP1SA-D | ✓ | |
| | | | PRWP1SB-D | ✓ | |
| | | | PRWP1.5S-D | ✓ | 0,20,30 |
| | | | PRWP2S-D | ✓ | 0 |
| | | | PRWP2H-TL | ✓ | |

A.
System
Overview

B1.
Cable Ties

B2.
Cable
Accessories

B3.
Stainless
Steel Ties

C1.
Wiring
Duct

C2.
Surface
Raceway

C3.
Abrasion
Protection

C4.
Cable
Management

D1.
Terminals

D2.
Power
Connectors

D3.
Grounding
Connectors

E1.
Labeling
Systems

E2.
Labels

E3.
Pre-Printed
& Write-On
Markers

E4.
Permanent
Identification

E5.
Lockout/
Tagout
& Safety
Solutions

F.
Index

A.
System
Overview

Features and Benefits – SUPER-GRIP® Cable Ties

One-piece design with a thin, wide strap body for improved flexibility.

B1.
Cable Ties

Dome shaped head and smooth, round strap body protect the cable insulation

B2.
Cable
Accessories

B3.
Stainless
Steel Ties

C1.
Wiring
Duct

C2.
Surface
Raceway

C3.
Abrasion
Protection

C4.
Cable
Management

D1.
Terminals

D2.
Power
Connectors

D3.
Grounding
Connectors

E1.
Labeling
Systems

E2.
Labels

E3.
Pre-Printed
& Write-On
Markers

E4.
Permanent
Identification

E5.
Lockout/
Tagout/
& Safety
Solutions

F.
Index



Thin, flared neck tolerates rough installation practices and improves small bundle performance



One-piece locking wedge provides consistent, reliable performance

Strong locking wedge improves strength and allows for rough handling



High loop tensile strength exceeds industry standards

Thin, wide strap body provides increased flexibility while maintaining loop tensile strength

Curved, tapered tip threads easily and installs faster

Aggressive grips allow temporary threading of tie before the strap teeth are engaged



Cable tie tools speed installation and reduce total installed cost. See pages B1.107 – B1.112.



Cable tie accessories are used to speed and simplify the mounting of wires, cables, and tubing. See pages B2.5, B2.7, B2.12, B2.14, B2.20.

Selection Guide – SUPER-GRIP® Cable Ties



| Material, Color (Suffix) | Style/Function | Part Number Prefix | Catalog Page |
|--|---------------------|--------------------|--------------|
| Nylon 6.6, Natural (No Suffix) | Locking Ties/Bundle | SG | B1.40 |
| Weather Resistant Nylon 6.6, Black (0) | Locking Ties/Bundle | SG | B1.41 |
| Heat Stabilized Nylon 6.6, Black (30) | Locking Ties/Bundle | SG | B1.41 |

Part Number System for SUPER-GRIP® Cable Ties

SG

Type

SG = Locking Tie

200

Length

Approx. Length (mm)

S

Cross Section

M = Miniature
I = Intermediate
S = Standard
LH = Light-Heavy
H = Heavy

—

C

Package Size

L = 50
C = 100
TL = 250
M = 1000

T

Material/Color

See Page B1.42

A. System Overview

B1. Cable Ties

B2. Cable Accessories

B3. Stainless Steel Ties

C1. Wiring Duct

C2. Surface Raceway

C3. Abrasion Protection

C4. Cable Management

D1. Terminals

D2. Power Connectors

D3. Grounding Connectors

E1. Labeling Systems

E2. Labels

E3. Pre-Printed & Write-On Markers

E4. Permanent Identification

E5. Lockout/Tagout & Safety Solutions

F. Index

A.
System
Overview



SUPER-GRIP® Cable Ties – Nylon 6.6

B1.
Cable Ties

- For indoor use
- Designed to grip the bundle tightly to resist lateral movement of the tie once installed
- High strength allows the tie to withstand rough installation practices that occur in MRO and construction environments

- Thin, wide strap body provides flexibility enabling it to conform to bundle while maintaining tensile strength
- Curved tip is easy to pick up from flat surfaces and allows faster initial threading to speed installation
- Complementary mounts available, see pages B2.5, B2.7, B2.12, B2.14 and B2.20

B2.
Cable
Accessories

B3.
Stainless
Steel Ties

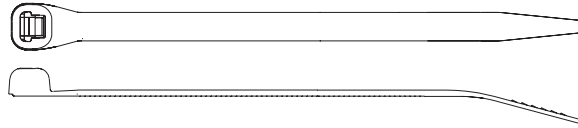

C1.
Wiring
Duct

C2.
Surface
Raceway

C3.
Abrasion
Protection

C4.
Cable
Management

D1.
Terminals

D2.
Power
Connectors

D3.
Grounding
Connectors

E1.
Labeling
Systems

E2.
Labels

E3.
Pre-Printed
& Write-On
Markers

E4.
Permanent
Identification

E5.
Lockout/
Tagout
& Safety
Solutions

F.
Index

| Part Number | Length | | Width | | Thickness | | Max. Bundle Dia. | | Min. Loop Tensile Strength | | Recommended Installation Tool | Std. Pkg. Qty. | Std. Ctn. Qty. |
|-----------------------------------|--------|-----|-------|-----|-----------|-----|------------------|-----|----------------------------|-----|--|----------------|----------------|
| | In. | mm | In. | mm | In. | mm | In. | mm | Lbs. | N | | | |
| Miniature Cross Section | | | | | | | | | | | | | |
| SG100M-C | 4.2 | 106 | .118 | 3.0 | .038 | 1.0 | .90 | 23 | 18 | 80 | GTS, GTSL, GS2B, PTS, PPTS, STS2 | 100 | 1000 |
| Intermediate Cross Section | | | | | | | | | | | | | |
| SG150I-C | 6.2 | 157 | .168 | 4.3 | .040 | 1.0 | 1.50 | 38 | 40 | 178 | GTS, GTSL, GS2B, PTS, PPTS, STS2 | 100 | 1000 |
| Standard Cross Section | | | | | | | | | | | | | |
| SG200S-C | 8.3 | 211 | .225 | 5.7 | .046 | 1.2 | 2.00 | 51 | 50 | 222 | GTS, GTSL, GS2B, GTH, GS4H, PTS, PTH, PPTS, STS2, STH2 | 100 | 1000 |
| SG250S-C | 10.4 | 264 | .225 | 5.7 | .050 | 1.3 | 2.60 | 66 | 75 | 334 | | 100 | 1000 |
| SG300S-C | 12.4 | 315 | .225 | 5.7 | .050 | 1.3 | 3.20 | 81 | 75 | 334 | | 100 | 1000 |
| SG370S-C | 15.3 | 389 | .225 | 5.7 | .052 | 1.3 | 4.20 | 107 | 75 | 334 | | 100 | 1000 |
| Light-Heavy Cross Section | | | | | | | | | | | | | |
| SG350LH-L | 15.3 | 389 | .330 | 8.4 | .064 | 1.6 | 4.13 | 105 | 120 | 534 | GTH, GS4H, GS4EH, PTH, STH2, ST3EH | 50 | 500 |
| Heavy Cross Section | | | | | | | | | | | | | |
| SG450H-L | 18.6 | 471 | .380 | 9.7 | .068 | 1.7 | 5.20 | 132 | 175 | 778 | GTH, GS4H, GS4EH, PTH, STH2, ST3EH | 50 | 500 |



SUPER-GRIP® Cable Ties – Weather Resistant and Heat Stabilized Nylon 6.6

- Weather resistant material has greater resistance to damage caused by ultraviolet light – indoor or outdoor use
- Heat stabilized material for high temperature applications up to 239°F (115°C) – indoor use
- Designed to grip the bundle tightly to resist lateral movement of the tie once installed

- High strength allows the tie to withstand rough installation practices that occur in MRO and construction environments
- Thin, wide strap body provides flexibility enabling it to conform to bundle while maintaining tensile strength
- Curved tip is easy to pick up from flat surfaces and allows faster initial threading to speed installation
- Complementary mounts available, see pages B2.5, B2.7, B2.12, B2.14 and B2.20

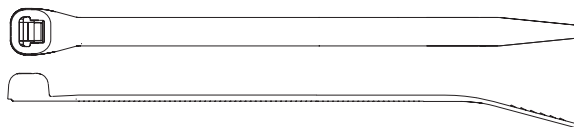

| Part Number | Length | | Width | | Thickness | | Max. Bundle Dia. | | Min. Loop Tensile Strength | | Recommended Installation Tool | Std. Pkg. Qty. | Std. Ctn. Qty. |
|-------------|--------|----|-------|----|-----------|----|------------------|----|----------------------------|---|-------------------------------|----------------|----------------|
| | In. | mm | In. | mm | In. | mm | In. | mm | Lbs. | N | | | |

Weather Resistant Nylon 6.6

Miniature Cross Section

| | | | | | | | | | | | | | |
|------------------|-----|-----|------|-----|------|-----|-----|----|----|----|----------------------------------|-----|------|
| SG100M-C0 | 4.2 | 106 | .118 | 3.0 | .038 | 1.0 | .90 | 23 | 18 | 80 | GTS, GTSL, GS2B, PTS, PPTS, STS2 | 100 | 1000 |
|------------------|-----|-----|------|-----|------|-----|-----|----|----|----|----------------------------------|-----|------|

Intermediate Cross Section

| | | | | | | | | | | | | | |
|------------------|-----|-----|------|-----|------|-----|------|----|----|-----|----------------------------------|-----|------|
| SG150I-C0 | 6.2 | 157 | .168 | 4.3 | .040 | 1.0 | 1.50 | 38 | 40 | 178 | GTS, GTSL, GS2B, PTS, PPTS, STS2 | 100 | 1000 |
|------------------|-----|-----|------|-----|------|-----|------|----|----|-----|----------------------------------|-----|------|

Standard Cross Section

| | | | | | | | | | | | | | |
|------------------|------|-----|------|-----|------|-----|------|-----|----|-----|--|-----|------|
| SG200S-C0 | 8.3 | 211 | .225 | 5.7 | .046 | 1.2 | 2.00 | 51 | 50 | 222 | GTS, GTSL, GS2B, GTH, GS4H, PTS, PTH, PPTS, STS2, STH2 | 100 | 1000 |
| SG250S-C0 | 10.4 | 264 | .225 | 5.7 | .050 | 1.3 | 2.60 | 66 | 75 | 334 | | 100 | 1000 |
| SG300S-C0 | 12.4 | 315 | .225 | 5.7 | .050 | 1.3 | 3.20 | 81 | 75 | 334 | | 100 | 1000 |
| SG370S-C0 | 15.3 | 389 | .225 | 5.7 | .052 | 1.3 | 4.20 | 107 | 75 | 334 | | 100 | 1000 |

Light-Heavy Cross Section

| | | | | | | | | | | | | | |
|-------------------|------|-----|------|-----|------|-----|------|-----|-----|-----|------------------------------------|----|-----|
| SG350LH-L0 | 15.3 | 389 | .330 | 8.4 | .064 | 1.6 | 4.13 | 105 | 120 | 534 | GTH, GS4H, GS4EH, PTH, STH2, ST3EH | 50 | 500 |
|-------------------|------|-----|------|-----|------|-----|------|-----|-----|-----|------------------------------------|----|-----|

Heavy Cross Section

| | | | | | | | | | | | | | |
|------------------|------|-----|------|-----|------|-----|------|-----|-----|-----|------------------------------------|----|-----|
| SG450H-L0 | 18.6 | 471 | .380 | 9.7 | .068 | 1.7 | 5.20 | 132 | 175 | 778 | GTH, GS4H, GS4EH, PTH, STH2, ST3EH | 50 | 500 |
|------------------|------|-----|------|-----|------|-----|------|-----|-----|-----|------------------------------------|----|-----|

Heat Stabilized Nylon 6.6

Standard Cross Section

| | | | | | | | | | | | | | |
|-------------------|------|-----|------|-----|------|-----|------|----|----|-----|--|------|-------|
| SG200S-M30 | 8.3 | 211 | .225 | 5.7 | .046 | 1.2 | 2.00 | 51 | 50 | 222 | GTS, GTSL, GS2B, GTH, GS4H, PTS, PTH, PPTS, STS2, STH2 | 1000 | 10000 |
| SG300S-M30 | 12.4 | 315 | .225 | 5.7 | .050 | 1.3 | 3.20 | 81 | 70 | 311 | | 1000 | 10000 |

Light-Heavy Cross Section

| | | | | | | | | | | | | | |
|---------------------|------|-----|------|-----|------|-----|------|-----|-----|-----|------------------------------------|-----|------|
| SG350LH-TL30 | 15.3 | 389 | .330 | 8.4 | .064 | 1.6 | 4.13 | 105 | 120 | 534 | GTH, GS4H, GS4EH, PTH, STH2, ST3EH | 250 | 2500 |
|---------------------|------|-----|------|-----|------|-----|------|-----|-----|-----|------------------------------------|-----|------|

Note: UL Listed and CSA Certified except SG450H-L0 and heat stabilized material (30).

A.
System
Overview

B1.
Cable Ties

B2.
Cable
Accessories

B3.
Stainless
Steel Ties

C1.
Wiring
Duct

C2.
Surface
Raceway

C3.
Abrasion
Protection

C4.
Cable
Management

D1.
Terminals

D2.
Power
Connectors

D3.
Grounding
Connectors

E1.
Labeling
Systems

E2.
Labels

E3.
Pre-Printed
& Write-On
Markers

E4.
Permanent
Identification

E5.
Lockout/
Tagout
& Safety
Solutions

F.
Index

A.
System
Overview

SUPER-GRIP® Cable Ties and Mounts

B1.
Cable Ties

Material and Color Chart

| Material | Color | PANDUIT Suffix |
|-----------------------------|---------|----------------|
| Nylon 6.6 | Natural | ✓ |
| Weather Resistant Nylon 6.6 | Black | 0 |
| Heat Stabilized Nylon 6.6 | Black | 30 |

✓ Denotes PANDUIT Natural Nylon 6.6 (no suffix).

C1.
Wiring
Duct

Part Number Availability List

| | Standard Packaging | | | Bulk Packaging | | |
|-------------------------------|--------------------|-------------------|-----------------------|----------------|-------------------|-----------------------|
| | Part Number | Natural Nylon 6.6 | Material/Color Suffix | Part Number | Natural Nylon 6.6 | Material/Color Suffix |
| C2. Surface Raceway | SG100M-C | ✓ | 0 | SG100M-M | ✓ | 0 |
| | SG150I-C | ✓ | 0 | SG150I-M | ✓ | 0 |
| C3. Abrasion Protection | SG200S-C | ✓ | 0 | SG200S-M | ✓ | 0,30 |
| | SG250S-C | ✓ | 0 | | | |
| C4. Cable Management | SG300S-C | ✓ | 0 | SG300S-M | ✓ | 0,30 |
| | SG370S-C | ✓ | 0 | SG370S-M | ✓ | 0 |
| | SG350LH-L | ✓ | 0 | SG350LH-TL | ✓ | 0,30 |
| | SG450H-L | ✓ | 0 | SG450H-C | ✓ | 0 |

D1.
Terminals

D2.
Power
Connectors

D3.
Grounding
Connectors

E1.
Labeling
Systems

E2.
Labels

E3.
Pre-Printed
& Write-On
Markers

E4.
Permanent
Identification

E5.
Lockout/
Tagout
& Safety
Solutions

F.
Index

Features and Benefits – *DOME-TOP®* Barb Ty Cable Ties

Two-piece design incorporates a stainless steel locking barb in a nylon cable tie.

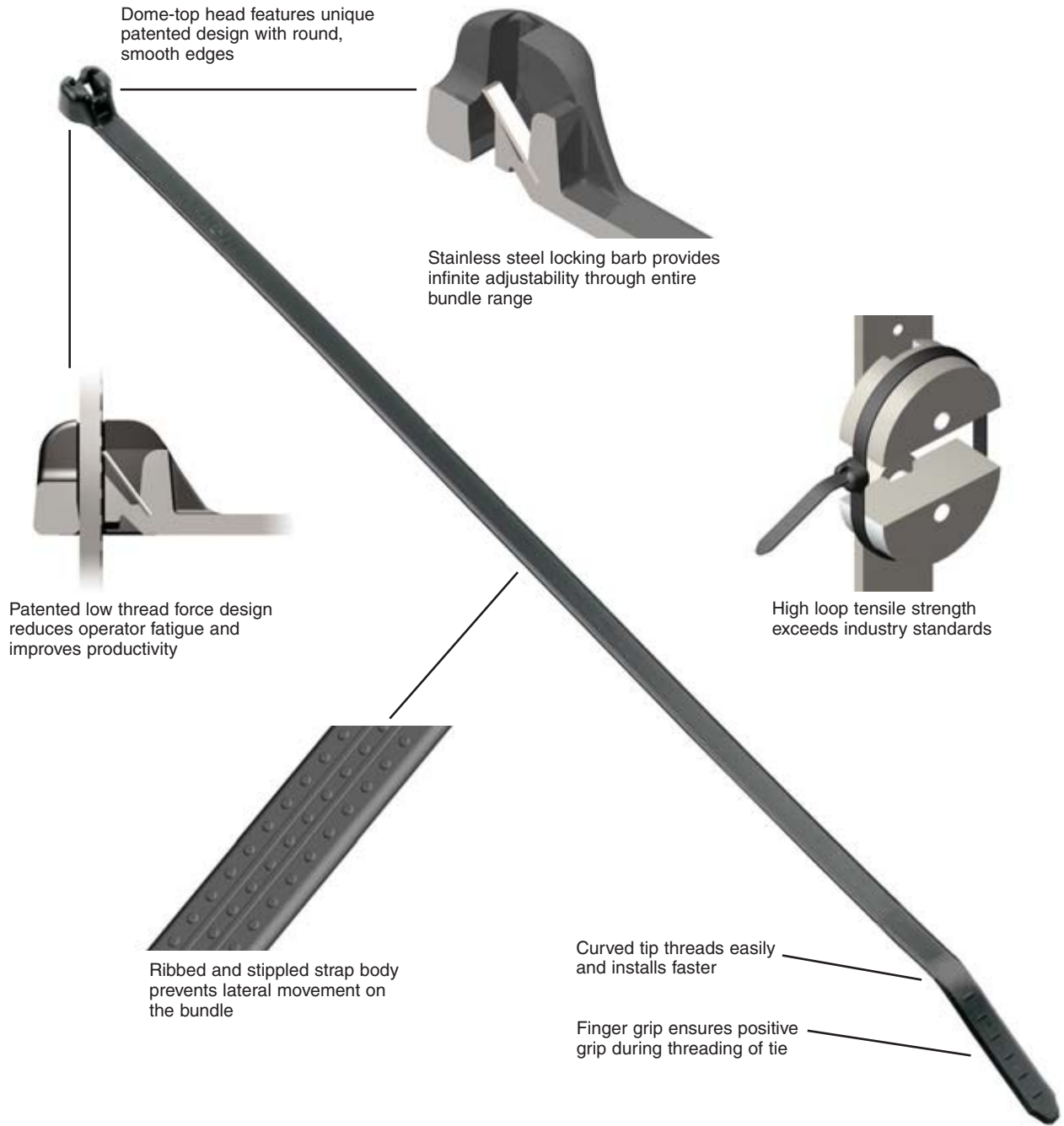

Cable tie tools speed installation and reduce total installed cost. See pages B1.107 – B1.112.



Cable tie accessories are used to speed and simplify the mounting of wires, cables, and tubing. See pages B2.1 – B2.29.

A. System Overview

B1. Cable Ties

B2. Cable Accessories

B3. Stainless Steel Ties

C1. Wiring Duct

C2. Surface Raceway

C3. Abrasion Protection

C4. Cable Management

D1. Terminals

D2. Power Connectors

D3. Grounding Connectors

E1. Labeling Systems

E2. Labels

E3. Pre-Printed & Write-On Markers

E4. Permanent Identification

E5. Lockout/Tagout & Safety Solutions

F. Index

A. System Overview

Selection Guide – *DOME-TOP*® Barb Ty and *DURA-TY*™ Cable Ties

B1. Cable Ties



B2. Cable Accessories

B3. Stainless Steel Ties

C1. Wiring Duct

C2. Surface Raceway

C3. Abrasion Protection

C4. Cable Management

D1. Terminals

D2. Power Connectors

D3. Grounding Connectors

E1. Labeling Systems

E2. Labels

E3. Pre-Printed & Write-On Markers

E4. Permanent Identification

E5. Lockout/Tagout & Safety Solutions

F. Index

| Material, Color (Suffix) | Style/Function | Part Number Prefix | Catalog Page |
|---|-----------------------|-----------------------|--------------|
| Nylon 6.6, Natural (No Suffix) | Locking Ties/Bundle | BT | B1.45 |
| | Clamp Ties/Mount | BC | B1.48 |
| | Push Mount Ties/Mount | BW | B1.50 |
| | Marker Ties/Identify | BF, BM, B2M, B3M, B4M | B1.52 |
| Weather Resistant Nylon 6.6, Black (0) | Locking Ties/Bundle | BT | B1.46 |
| | Clamp Ties/Mount | BC | B1.49 |
| | Push Mount Ties/Mount | BW, BP | B1.50,51 |
| | Marker Ties/Identify | BF, BM, B2M, B3M, B4M | B1.52 |
| Heat Stabilized Nylon 6.6, Black (30) | Locking Ties/Bundle | BT | B1.47 |
| | Clamp Ties/Mount | BC | B1.49 |
| Heat Stabilized Nylon 6.6, Natural (39) | Locking Ties/Bundle | BT | B1.47 |
| Weather Resistant Acetal, Black | Locking Ties/Bundle | DT | B1.53 |

Part Number System for *DOME-TOP*® Barb Ty and *DURA-TY*™ Cable Ties

| BT | 2 | S | — | C | — |
|--------------------------|-----------------------------------|------------------|-------------------|---------------|----------------|
| Type | Size | Cross Section | Screw Hole Size | Package Size | Material/Color |
| BT = Locking Tie | Approx. Maximum Bundle Dia. (In.) | M = Miniature | (Clamp Ties Only) | Q = 25 | See Page B1.54 |
| BC = Clamp Tie | | I = Intermediate | -S4 = #4 (M2.5) | L = 50 | |
| BF = Flag Tie | S = Standard | -S6 = #6 (M3) | C = 100 | | |
| BM = Marker Tie | LH = Light-Heavy | -S8 = #8 (M4) | TL = 250 | | |
| BP = Push Mount Tie | H = Heavy | -S10 = #10 (M5) | D = 500 | | |
| BW = Wing Push Mount Tie | EH = Extra-Heavy | -S25 = 1/4 (M6) | M = 1000 | | |
| DT = Locking Tie | | | | LR = 50' Reel | |



DOME-TOP® Barb Ty Cable Ties – Nylon 6.6

- For indoor use
- Dome-top head features unique patented design with round, smooth edges
- Stainless steel locking barb provides consistent performance, reliability, and infinite adjustability through entire bundle range

- High strength and low thread force
- A variety of materials and colors are available for specific applications
- Curved tip is easy to pick up from flat surfaces and allows faster initial threading to speed installation

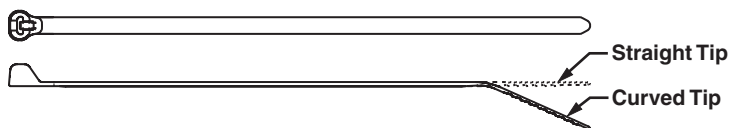

| Part Number | Length | | Width | | Thickness | | Max. Bundle Dia. | | Min. Loop Tensile Str. | | Recommended Installation Tool | Std. Pkg. Qty. | Std. Ctn. Qty. |
|---|--------|-----|-------|-----|-----------|-----|------------------|-----|------------------------|-----|--|----------------|----------------|
| | In. | mm | In. | mm | In. | mm | In. | mm | Lbs. | N | | | |
| Miniature Cross Section | | | | | | | | | | | | | |
| BT1M-C | 4.0 | 102 | .095 | 2.4 | .036 | .9 | .90 | 23 | 18 | 80 | GTS, GTSL, GS2B, PTS, PPTS, STS2 | 100 | 1000 |
| BT1.5M-C | 6.3 | 160 | .095 | 2.4 | .046 | 1.2 | 1.50 | 38 | 18 | 80 | | 100 | 1000 |
| BT2M-C | 7.9 | 201 | .095 | 2.4 | .046 | 1.2 | 2.00 | 51 | 18 | 80 | | 100 | 1000 |
| BT4M-C | 14.2 | 361 | .095 | 2.4 | .046 | 1.2 | 4.00 | 102 | 18 | 80 | | 100 | 1000 |
| Intermediate Cross Section | | | | | | | | | | | | | |
| BT1.5I-C | 6.1 | 155 | .141 | 3.6 | .041 | 1.0 | 1.50 | 38 | 40 | 178 | GTS, GTSL, GS2B, PTS, PPTS, STS2 | 100 | 1000 |
| BT2I-C | 8.0 | 203 | .141 | 3.6 | .041 | 1.0 | 2.00 | 51 | 40 | 178 | | 100 | 1000 |
| BT3I-C | 11.3 | 287 | .141 | 3.6 | .049 | 1.2 | 3.00 | 76 | 40 | 178 | | 100 | 1000 |
| BT4I-C | 14.3 | 363 | .141 | 3.6 | .049 | 1.2 | 4.00 | 102 | 40 | 178 | | 100 | 1000 |
| Standard Cross Section | | | | | | | | | | | | | |
| BT2S-C | 8.0 | 203 | .185 | 4.7 | .045 | 1.1 | 2.00 | 51 | 50 | 222 | GTS, GTSL, GS2B, GTH, GS4H, PTS, PTH, PPTS, STS2, STH2 | 100 | 1000 |
| BT3S-C | 12.0 | 305 | .185 | 4.7 | .052 | 1.3 | 3.00 | 76 | 50 | 222 | | 100 | 1000 |
| BT4S-C | 15.1 | 384 | .185 | 4.7 | .052 | 1.3 | 4.00 | 102 | 50 | 222 | | 100 | 1000 |
| Light-Heavy Cross Section (Straight Tip) | | | | | | | | | | | | | |
| BT2LH-L | 8.7 | 221 | .275 | 7.0 | .065 | 1.7 | 2.00 | 51 | 120 | 534 | GTH, GS4H, GS4EH, PTH, STH2, ST3EH | 50 | 500 |
| BT3LH-L | 11.8 | 300 | .275 | 7.0 | .065 | 1.7 | 3.00 | 76 | 120 | 534 | | 50 | 500 |
| BT4LH-L | 14.9 | 378 | .275 | 7.0 | .065 | 1.7 | 4.00 | 102 | 120 | 534 | | 50 | 500 |
| BT5LH-L | 18.1 | 460 | .275 | 7.0 | .065 | 1.7 | 5.00 | 127 | 120 | 534 | | 50 | 500 |
| BT6LH-L | 21.2 | 538 | .275 | 7.0 | .065 | 1.7 | 6.00 | 152 | 120 | 534 | | 50 | 500 |
| BT7LH-L | 24.4 | 620 | .275 | 7.0 | .065 | 1.7 | 7.00 | 178 | 120 | 534 | | 50 | 500 |
| BT8LH-L | 27.5 | 699 | .275 | 7.0 | .065 | 1.7 | 8.00 | 203 | 120 | 534 | | 50 | 500 |
| BT9LH-L | 30.7 | 780 | .275 | 7.0 | .065 | 1.7 | 9.00 | 229 | 120 | 534 | | 50 | 500 |

A. System Overview

B1. Cable Ties

B2. Cable Accessories

B3. Stainless Steel Ties

C1. Wiring Duct

C2. Surface Raceway

C3. Abrasion Protection

C4. Cable Management

D1. Terminals

D2. Power Connectors

D3. Grounding Connectors

E1. Labeling Systems

E2. Labels

E3. Pre-Printed & Write-On Markers

E4. Permanent Identification

E5. Lockout/Tagout & Safety Solutions

F. Index

A. System Overview



DOME-TOP® Barb Ty Cable Ties – Weather Resistant Nylon 6.6

B1. Cable Ties

- Greater resistance to damage caused by ultraviolet light – indoor or outdoor use
- Dome-top head features unique patented design with round, smooth edges

- Stainless steel locking barb provides consistent performance, reliability, and infinite adjustability through entire bundle range
- High strength and low thread force
- Curved tip is easy to pick up from flat surfaces and allows faster initial threading to speed installation

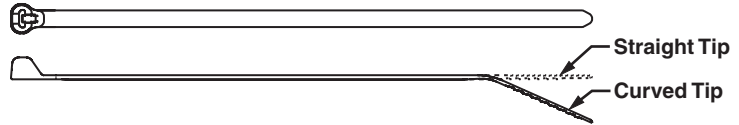

B3. Stainless Steel Ties

C1. Wiring Duct

C2. Surface Raceway

| Part Number | Length | | Width | | Thickness | | Max. Bundle Dia. | | Min. Loop Tensile Str. | | Recommended Installation Tool | Std. Pkg. Qty. | Std. Ctn. Qty. |
|-------------|--------|----|-------|----|-----------|----|------------------|----|------------------------|---|-------------------------------|----------------|----------------|
| | In. | mm | In. | mm | In. | mm | In. | mm | Lbs. | N | | | |

Miniature Cross Section

| | | | | | | | | | | | | | |
|------------------|------|-----|------|-----|------|-----|------|-----|----|----|----------------------------------|-----|------|
| BT1M-C0 | 4.0 | 102 | .095 | 2.4 | .036 | .9 | .90 | 23 | 18 | 80 | GTS, GTSL, GS2B, PTS, PPTS, STS2 | 100 | 1000 |
| BT1.5M-C0 | 6.3 | 160 | .095 | 2.4 | .046 | 1.2 | 1.50 | 38 | 18 | 80 | | 100 | 1000 |
| BT2M-C0 | 7.9 | 201 | .095 | 2.4 | .046 | 1.2 | 2.00 | 51 | 18 | 80 | | 100 | 1000 |
| BT4M-C0 | 14.2 | 361 | .095 | 2.4 | .046 | 1.2 | 4.00 | 102 | 18 | 80 | | 100 | 1000 |

Intermediate Cross Section

| | | | | | | | | | | | | | |
|------------------|------|-----|------|-----|------|-----|------|-----|----|-----|----------------------------------|-----|------|
| BT1.5I-C0 | 6.1 | 155 | .141 | 3.6 | .041 | 1.0 | 1.50 | 38 | 40 | 178 | GTS, GTSL, GS2B, PTS, PPTS, STS2 | 100 | 1000 |
| BT2I-C0 | 8.0 | 203 | .141 | 3.6 | .041 | 1.0 | 2.00 | 51 | 40 | 178 | | 100 | 1000 |
| BT3I-C0 | 11.3 | 287 | .141 | 3.6 | .049 | 1.2 | 3.00 | 76 | 40 | 178 | | 100 | 1000 |
| BT4I-C0 | 14.3 | 363 | .141 | 3.6 | .049 | 1.2 | 4.00 | 102 | 40 | 178 | | 100 | 1000 |

Standard Cross Section

| | | | | | | | | | | | | | |
|----------------|------|-----|------|-----|------|-----|------|-----|----|-----|--|-----|------|
| BT2S-C0 | 8.0 | 203 | .185 | 4.7 | .045 | 1.1 | 2.00 | 51 | 50 | 222 | GTS, GTSL, GS2B, GTH, GS4H, PTS, PTH, PPTS, STS2, STH2 | 100 | 1000 |
| BT3S-C0 | 12.0 | 305 | .185 | 4.7 | .052 | 1.3 | 3.00 | 76 | 50 | 222 | | 100 | 1000 |
| BT4S-C0 | 15.1 | 384 | .185 | 4.7 | .052 | 1.3 | 4.00 | 102 | 50 | 222 | | 100 | 1000 |

Light-Heavy Cross Section (Straight Tip)

| | | | | | | | | | | | | | |
|-----------------|------|-----|------|-----|------|-----|------|-----|-----|-----|------------------------------------|----|-----|
| BT2LH-L0 | 8.7 | 221 | .275 | 7.0 | .065 | 1.7 | 2.00 | 51 | 120 | 534 | GTH, GS4H, GS4EH, PTH, STH2, ST3EH | 50 | 500 |
| BT3LH-L0 | 11.8 | 300 | .275 | 7.0 | .065 | 1.7 | 3.00 | 76 | 120 | 534 | | 50 | 500 |
| BT4LH-L0 | 14.9 | 378 | .275 | 7.0 | .065 | 1.7 | 4.00 | 102 | 120 | 534 | | 50 | 500 |
| BT5LH-L0 | 18.1 | 460 | .275 | 7.0 | .065 | 1.7 | 5.00 | 127 | 120 | 534 | | 50 | 500 |
| BT6LH-L0 | 21.2 | 538 | .275 | 7.0 | .065 | 1.7 | 6.00 | 152 | 120 | 534 | | 50 | 500 |
| BT7LH-L0 | 24.4 | 620 | .275 | 7.0 | .065 | 1.7 | 7.00 | 178 | 120 | 534 | | 50 | 500 |
| BT8LH-L0 | 27.5 | 699 | .275 | 7.0 | .065 | 1.7 | 8.00 | 203 | 120 | 534 | | 50 | 500 |
| BT9LH-L0 | 30.7 | 780 | .275 | 7.0 | .065 | 1.7 | 9.00 | 229 | 120 | 534 | | 50 | 500 |

Note: UL Recognized, UL Listed, and CSA Certified, except LH cross section.

E3. Pre-Printed & Write-On Markers

E4. Permanent Identification

E5. Lockout/Tagout & Safety Solutions

F. Index



DOME-TOP® Barb Ty Cable Ties – Heat Stabilized Nylon 6.6

- For high temperature applications up to 239°F (115°C) – indoor use
- Dome-top head features unique patented design with round, smooth edges

- Stainless steel locking barb provides consistent performance, reliability, and infinite adjustability through entire bundle range
- Curved tip is easy to pick up from flat surfaces and allows faster initial threading to speed installation



BT2S-M30

BT2S-M39

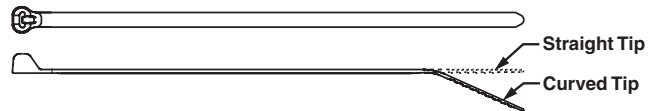

| Part Number | Length | | Width | | Thickness | | Max. Bundle Dia. | | Min. Loop Tensile Str. | | Recommended Installation Tool | Std. Pkg. Qty. | Std. Ctn. Qty. |
|-------------|--------|----|-------|----|-----------|----|------------------|----|------------------------|---|-------------------------------|----------------|----------------|
| | In. | mm | In. | mm | In. | mm | In. | mm | Lbs. | N | | | |

Heat Stabilized Nylon 6.6 – Black

Miniature Cross Section

| | | | | | | | | | | | | | |
|------------|-----|-----|------|-----|------|-----|------|----|----|----|----------------------------------|------|-------|
| BT1M-C30 | 4.0 | 102 | .095 | 2.4 | .036 | .9 | .90 | 23 | 18 | 80 | GTS, GTSL, GS2B, PTS, PPTS, STS2 | 100 | 1000 |
| BT1.5M-M30 | 6.3 | 160 | .095 | 2.4 | .046 | 1.2 | 1.50 | 38 | 18 | 80 | | 1000 | 50000 |
| BT2M-M30 | 7.9 | 201 | .095 | 2.4 | .046 | 1.2 | 2.00 | 51 | 18 | 80 | | 1000 | 25000 |

Intermediate Cross Section

| | | | | | | | | | | | | | |
|------------|------|-----|------|-----|------|-----|------|----|----|-----|----------------------------------|------|-------|
| BT1.5I-M30 | 6.1 | 155 | .141 | 3.6 | .041 | 1.0 | 1.50 | 38 | 40 | 178 | GTS, GTSL, GS2B, PTS, PPTS, STS2 | 1000 | 25000 |
| BT2I-M30 | 8.0 | 203 | .141 | 3.6 | .041 | 1.0 | 2.00 | 51 | 40 | 178 | | 1000 | 25000 |
| BT3I-M30 | 11.3 | 287 | .141 | 3.6 | .049 | 1.2 | 3.00 | 76 | 40 | 178 | | 1000 | 10000 |

Standard Cross Section

| | | | | | | | | | | | | | |
|----------|------|-----|------|-----|------|-----|------|-----|----|-----|--|------|-------|
| BT2S-M30 | 8.0 | 203 | .185 | 4.7 | .045 | 1.1 | 2.00 | 51 | 50 | 222 | GTS, GTSL, GS2B, GTS, GS4H, PTS, PTH, PPTS, STS2, STH2 | 1000 | 10000 |
| BT3S-M30 | 12.0 | 305 | .185 | 4.7 | .052 | 1.3 | 3.00 | 76 | 50 | 222 | | 1000 | 10000 |
| BT4S-M30 | 15.1 | 384 | .185 | 4.7 | .052 | 1.3 | 4.00 | 102 | 50 | 222 | | 1000 | 5000 |

Light-Heavy Cross Section (Straight Tip)

| | | | | | | | | | | | | | |
|------------|------|-----|------|-----|------|-----|------|-----|-----|-----|------------------------------------|-----|------|
| BT4LH-TL30 | 14.9 | 378 | .275 | 7.0 | .065 | 1.7 | 4.00 | 102 | 120 | 534 | GTH, GS4H, GS4EH, PTH, STH2, ST3EH | 250 | 2500 |
|------------|------|-----|------|-----|------|-----|------|-----|-----|-----|------------------------------------|-----|------|

Heat Stabilized Nylon 6.6 – Natural

Miniature Cross Section

| | | | | | | | | | | | | | |
|----------|-----|-----|------|-----|------|----|-----|----|----|----|----------------------------------|------|-------|
| BT1M-M39 | 4.0 | 102 | .095 | 2.4 | .036 | .9 | .90 | 23 | 18 | 80 | GTS, GTSL, GS2B, PTS, PPTS, STS2 | 1000 | 50000 |
|----------|-----|-----|------|-----|------|----|-----|----|----|----|----------------------------------|------|-------|

Intermediate Cross Section

| | | | | | | | | | | | | | |
|------------|-----|-----|------|-----|------|-----|------|----|----|-----|----------------------------------|------|-------|
| BT1.5I-M39 | 6.1 | 155 | .141 | 3.6 | .041 | 1.0 | 1.50 | 38 | 40 | 178 | GTS, GTSL, GS2B, PTS, PPTS, STS2 | 1000 | 25000 |
|------------|-----|-----|------|-----|------|-----|------|----|----|-----|----------------------------------|------|-------|

Standard Cross Section

| | | | | | | | | | | | | | |
|----------|------|-----|------|-----|------|-----|------|-----|----|-----|--|------|-------|
| BT2S-M39 | 8.0 | 203 | .185 | 4.7 | .045 | 1.1 | 2.00 | 51 | 50 | 222 | GTS, GTSL, GS2B, GTS, GS4H, PTS, PTH, PPTS, STS2, STH2 | 1000 | 10000 |
| BT3S-M39 | 12.0 | 305 | .185 | 4.7 | .052 | 1.3 | 3.00 | 76 | 50 | 222 | | 1000 | 10000 |
| BT4S-M39 | 15.1 | 384 | .185 | 4.7 | .052 | 1.3 | 4.00 | 102 | 50 | 222 | | 1000 | 5000 |

Light-Heavy Cross Section (Straight Tip)

| | | | | | | | | | | | | | |
|------------|------|-----|------|-----|------|-----|------|-----|-----|-----|------------------------------------|-----|------|
| BT4LH-TL39 | 14.9 | 378 | .275 | 7.0 | .065 | 1.7 | 4.00 | 102 | 120 | 534 | GTH, GS4H, GS4EH, PTH, STH2, ST3EH | 250 | 2500 |
|------------|------|-----|------|-----|------|-----|------|-----|-----|-----|------------------------------------|-----|------|

A. System Overview

B1. Cable Ties

B2. Cable Accessories

B3. Stainless Steel Ties

C1. Wiring Duct

C2. Surface Raceway

C3. Abrasion Protection

C4. Cable Management

D1. Terminals

D2. Power Connectors

D3. Grounding Connectors

E1. Labeling Systems

E2. Labels

E3. Pre-Printed & Write-On Markers

E4. Permanent Identification

E5. Lockout/Tagout & Safety Solutions

F. Index

A.
System
Overview

UL **UL** **CSA** **DOME-TOP® Barb Ty Clamp Ties – Nylon 6.6**

B1.
Cable Ties

- For indoor use
- Used to secure a cable bundle to another surface such as a control panel, communication rack, wall or ceiling
- Design allows for bundling before or after screwing clamp in place

- Stainless steel locking barb provides consistent performance, reliability, and infinite adjustability through entire bundle range
- Curved tip is easy to pick up from flat surfaces and allows faster initial threading to speed installation

B2.
Cable
Accessories

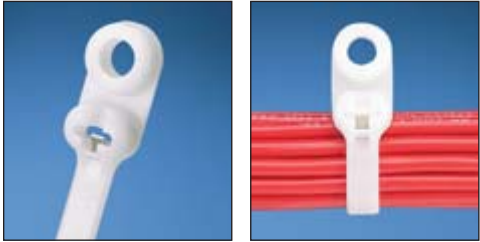

B3.
Stainless
Steel Ties

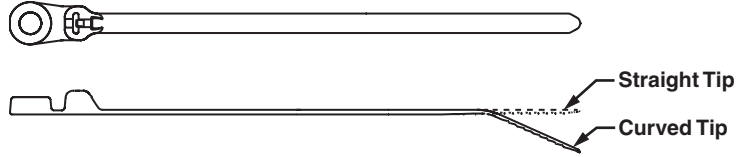

C1.
Wiring
Duct



C2.
Surface
Raceway

| Part Number | Length | | Width | | Thickness | | Nominal Hole Dia. | | Screw Size | Metric Screw Size | Max. Bundle Dia. | | Min. Loop Tensile Str. | | Recommended Installation Tool | Std. Pkg. Qty. | Std. Ctn. Qty. |
|-------------|--------|----|-------|----|-----------|----|-------------------|----|------------|-------------------|------------------|----|------------------------|---|-------------------------------|----------------|----------------|
| | In. | mm | In. | mm | In. | mm | In. | mm | | | In. | mm | Lbs. | N | | | |

C3.
Abrasion
Protection

Miniature Cross Section

| | | | | | | | | | | | | | | | | | |
|------------------|-----|-----|------|-----|------|-----|------|-----|----|------|------|----|----|----|----------------------------------|------|-------|
| BC1M-S4-M | 4.6 | 117 | .095 | 2.4 | .046 | 1.2 | .122 | 3.1 | #4 | M2.5 | .90 | 23 | 18 | 80 | GTS, GTSL, GS2B, PTS, PPTS, STS2 | 1000 | 50000 |
| BC2M-S4-M | 8.3 | 211 | .095 | 2.4 | .046 | 1.2 | .122 | 3.1 | #4 | M2.5 | 2.00 | 51 | 18 | 80 | | 1000 | 25000 |

C4.
Cable
Management

Intermediate Cross Section

| | | | | | | | | | | | | | | | | | |
|--------------------|-----|-----|------|-----|------|-----|------|-----|----|----|------|----|----|-----|----------------------------------|------|-------|
| BC1.5I-S8-M | 6.6 | 168 | .141 | 3.6 | .041 | 1.0 | .174 | 4.4 | #8 | M4 | 1.50 | 38 | 40 | 178 | GTS, GTSL, GS2B, PTS, PPTS, STS2 | 1000 | 25000 |
|--------------------|-----|-----|------|-----|------|-----|------|-----|----|----|------|----|----|-----|----------------------------------|------|-------|

D1.
Terminals

Standard Cross Section

| | | | | | | | | | | | | | | | | | |
|-------------------|------|-----|------|-----|------|-----|------|-----|-----|----|------|-----|----|-----|--|-----|------|
| BC2S-S10-C | 8.5 | 216 | .185 | 4.7 | .052 | 1.3 | .200 | 5.1 | #10 | M5 | 2.00 | 51 | 50 | 222 | GTS, GTSL, GS2B, GTH, GS4H, PTS, PTH, PPTS, STS2, STH2 | 100 | 1000 |
| BC3S-S10-D | 12.5 | 318 | .185 | 4.7 | .052 | 1.3 | .200 | 5.1 | #10 | M5 | 3.00 | 76 | 50 | 222 | | 500 | 5000 |
| BC4S-S10-C | 15.6 | 396 | .185 | 4.7 | .052 | 1.3 | .200 | 5.1 | #10 | M5 | 4.00 | 102 | 50 | 222 | | 100 | 1000 |

D2.
Power
Connectors

Light-Heavy Cross Section (Straight Tip)

| | | | | | | | | | | | | | | | | | |
|--------------------|------|-----|------|-----|------|-----|------|-----|-----|----|------|-----|-----|-----|------------------------------------|----|-----|
| BC4LH-S25-L | 15.5 | 394 | .275 | 7.0 | .065 | 1.7 | .260 | 6.6 | 1/4 | M6 | 4.00 | 102 | 120 | 534 | GTH, GS4H, GS4EH, PTH, STH2, ST3EH | 50 | 500 |
|--------------------|------|-----|------|-----|------|-----|------|-----|-----|----|------|-----|-----|-----|------------------------------------|----|-----|

D3.
Grounding
Connectors

E1.
Labeling
Systems

E2.
Labels

E3.
Pre-Printed
& Write-On
Markers

E4.
Permanent
Identification

E5.
Lockout/
Tagout/
& Safety
Solutions

F.
Index



DOME-TOP® Barb Ty Clamp Ties – Weather Resistant and Heat Stabilized Nylon 6.6

- Weather Resistant material has greater resistance to damage caused by ultraviolet light – indoor or outdoor use
- Heat stabilized material for high temperature applications up to 239°F (115°C) – indoor use
- Used to secure a cable bundle to another surface such as a control panel, communication rack, wall or ceiling
- Design allows for bundling before or after screwing clamp in place
- Stainless steel locking barb provides consistent performance, reliability, and infinite adjustability through entire bundle range
- Curved tip is easy to pick up from flat surfaces and allows faster initial threading to speed installation

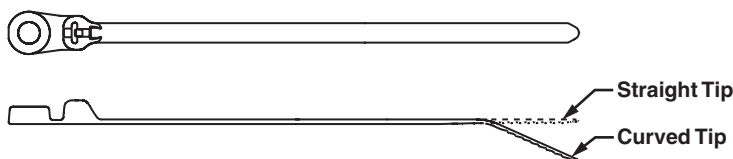

| Part Number | Length | | Width | | Thickness | | Nominal Hole Dia. | | Screw Size | Metric Screw Size | Max. Bundle Dia. | | Min. Loop Tensile Str. | | Recommended Installation Tool | Std. Pkg. Qty. | Std. Ctn. Qty. |
|-------------|--------|----|-------|----|-----------|----|-------------------|----|------------|-------------------|------------------|----|------------------------|---|-------------------------------|----------------|----------------|
| | In. | mm | In. | mm | In. | mm | In. | mm | | | In. | mm | Lbs. | N | | | |

Weather Resistant Nylon 6.6

Miniature Cross Section

| | | | | | | | | | | | | | | | | | |
|------------|-----|-----|------|-----|------|-----|------|-----|----|------|------|----|----|----|----------------------------------|------|-------|
| BC1M-S4-M0 | 4.6 | 117 | .095 | 2.4 | .046 | 1.2 | .122 | 3.1 | #4 | M2.5 | .90 | 23 | 18 | 80 | GTS, GTSL, GS2B, PTS, PPTS, STS2 | 1000 | 50000 |
| BC2M-S4-M0 | 8.3 | 211 | .095 | 2.4 | .046 | 1.2 | .122 | 3.1 | #4 | M2.5 | 2.00 | 51 | 18 | 80 | GTS, GTSL, GS2B, PTS, PPTS, STS2 | 1000 | 25000 |

Intermediate Cross Section

| | | | | | | | | | | | | | | | | | |
|--------------|-----|-----|------|-----|------|-----|------|-----|----|----|------|----|----|-----|----------------------------------|------|-------|
| BC1.5I-S8-M0 | 6.6 | 168 | .141 | 3.6 | .041 | 1.0 | .174 | 4.4 | #8 | M4 | 1.50 | 38 | 40 | 178 | GTS, GTSL, GS2B, PTS, PPTS, STS2 | 1000 | 25000 |
|--------------|-----|-----|------|-----|------|-----|------|-----|----|----|------|----|----|-----|----------------------------------|------|-------|

Standard Cross Section

| | | | | | | | | | | | | | | | | | |
|-------------|------|-----|------|-----|------|-----|------|-----|-----|----|------|-----|----|-----|--|-----|------|
| BC2S-S10-C0 | 8.5 | 216 | .185 | 4.7 | .052 | 1.3 | .200 | 5.1 | #10 | M5 | 2.00 | 51 | 50 | 222 | GTS, GTSL, GS2B, GTH, GS4H, PTS, PTH, PPTS, STS2, STH2 | 100 | 1000 |
| BC3S-S10-D0 | 12.5 | 318 | .185 | 4.7 | .052 | 1.3 | .200 | 5.1 | #10 | M5 | 3.00 | 76 | 50 | 222 | | 500 | 5000 |
| BC4S-S10-C0 | 15.6 | 396 | .185 | 4.7 | .052 | 1.3 | .200 | 5.1 | #10 | M5 | 4.00 | 102 | 50 | 222 | | 100 | 1000 |

Light-Heavy Cross Section (Straight Tip)

| | | | | | | | | | | | | | | | | | |
|--------------|------|-----|------|-----|------|-----|------|-----|-----|----|------|-----|-----|-----|------------------------------------|----|-----|
| BC4LH-S25-L0 | 15.5 | 394 | .275 | 7.0 | .065 | 1.7 | .260 | 6.6 | 1/4 | M6 | 4.00 | 102 | 120 | 534 | GTH, GS4H, GS4EH, PTH, STH2, ST3EH | 50 | 500 |
|--------------|------|-----|------|-----|------|-----|------|-----|-----|----|------|-----|-----|-----|------------------------------------|----|-----|

Heat Stabilized Nylon 6.6

Standard Cross Section

| | | | | | | | | | | | | | | | | | |
|--------------|------|-----|------|-----|------|-----|------|-----|-----|----|------|-----|----|-----|--|-----|------|
| BC4S-S10-D30 | 15.6 | 396 | .185 | 4.7 | .052 | 1.3 | .200 | 5.1 | #10 | M5 | 4.00 | 102 | 50 | 222 | GTS, GTSL, GS2B, GTH, GS4H, PTS, PTH, PPTS, STH2, STS2 | 500 | 5000 |
|--------------|------|-----|------|-----|------|-----|------|-----|-----|----|------|-----|----|-----|--|-----|------|

Note: UL Recognized and CSA Certified except BC4LH-S25-L0.

A.
System
Overview

B1.
Cable Ties

B2.
Cable
Accessories

B3.
Stainless
Steel Ties

C1.
Wiring
Duct

C2.
Surface
Raceway

C3.
Abrasion
Protection

C4.
Cable
Management

D1.
Terminals

D2.
Power
Connectors

D3.
Grounding
Connectors

E1.
Labeling
Systems

E2.
Labels

E3.
Pre-Printed
& Write-On
Markers

E4.
Permanent
Identification

E5.
Lockout/
Tagout
& Safety
Solutions

F.
Index

A. System Overview



DOME-TOP® Barb Ty Wing Push Mount Ties – Nylon and Weather Resistant Nylon 6.6

B1. Cable Ties

- Natural nylon material for indoor use
- Weather resistant material has greater resistance to damage caused by ultraviolet light – indoor or outdoor use
- Combine cable tie, mount, and fastener into a single part
- Used to attach bundles to another surface such as a flat panel
- Anchor is easily pressed into a pre-formed hole and locks in place

- Wings provide constant tension for a stable, secure, and rattle-free installation
- Stainless steel locking barb provides consistent performance, reliability, and infinite adjustability through entire bundle range
- Curved tip is easy to pick up from flat surfaces and allows faster initial threading to speed installation

B2. Cable Accessories

B3. Stainless Steel Ties



BW2S-D



BW2S-D0

C1. Wiring Duct

C2. Surface Raceway

C3. Abrasion Protection

C4. Cable Management

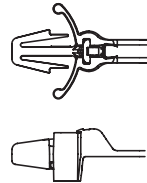
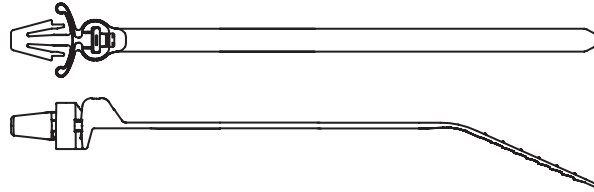

BW2S Head Design

D1. Terminals

| Part Number | Length | | Width | | Thickness | | Nominal Hole Dia. | | Max. Panel Thickness | | Max. Bundle Dia. | | Min. Loop Tensile Str. | | Recommended Installation Tool | Std. Pkg. Qty. | Std. Ctn. Qty. |
|-------------|--------|----|-------|----|-----------|----|-------------------|----|----------------------|----|------------------|----|------------------------|---|-------------------------------|----------------|----------------|
| | In. | mm | In. | mm | In. | mm | In. | mm | In. | mm | In. | mm | Lbs. | N | | | |

D2. Power Connectors

Nylon 6.6

Intermediate Cross Section

| | | | | | | | | | | | | | | | | | |
|-----------------|-----|-----|------|-----|------|-----|------|-----|------|-----|------|----|----|-----|----------------------------------|-----|------|
| BW1.5I-D | 6.6 | 168 | .141 | 3.6 | .041 | 1.0 | .187 | 4.7 | .093 | 2.4 | 1.50 | 38 | 40 | 178 | GTS, GTSL, GS2B, PTS, PPTS, STS2 | 500 | 5000 |
|-----------------|-----|-----|------|-----|------|-----|------|-----|------|-----|------|----|----|-----|----------------------------------|-----|------|

D3. Grounding Connectors

Standard Cross Section

| | | | | | | | | | | | | | | | | | |
|---------------|------|-----|------|-----|------|-----|------|-----|------|-----|------|----|----|-----|--|-----|------|
| BW2S-D | 8.5 | 216 | .185 | 4.7 | .052 | 1.3 | .250 | 6.4 | .156 | 4.0 | 2.00 | 51 | 50 | 222 | GTS, GTSL, GS2B, GTH, GS4H, PTS, PTH, PPTS, STS2, STH2 | 500 | 5000 |
| BW3S-D | 12.5 | 318 | .185 | 4.7 | .052 | 1.3 | .250 | 6.4 | .156 | 4.0 | 3.00 | 76 | 50 | 222 | | 500 | 5000 |

E1. Labeling Systems

Weather Resistant Nylon 6.6

Standard Cross Section

| | | | | | | | | | | | | | | | | | |
|----------------|------|-----|------|-----|------|-----|------|-----|------|-----|------|----|----|-----|--|-----|------|
| BW2S-D0 | 8.5 | 216 | .185 | 4.7 | .052 | 1.3 | .250 | 6.4 | .156 | 4.0 | 2.00 | 51 | 50 | 222 | GTS, GTSL, GS2B, GTH, GS4H, PTS, PTH, PPTS, STS2, STH2 | 500 | 5000 |
| BW3S-D0 | 12.5 | 318 | .185 | 4.7 | .052 | 1.3 | .250 | 6.4 | .156 | 4.0 | 3.00 | 76 | 50 | 222 | | 500 | 5000 |

E3. Pre-Printed & Write-On Markers

E4. Permanent Identification

E5. Lockout/Tagout & Safety Solutions

F. Index

UL US CS DOME-TOP® Barb Ty Push Mount Ties – Weather Resistant Nylon 6.6

- Greater resistance to damage caused by ultraviolet light – indoor or outdoor use
- Used to attach bundles to another surface such as a flat panel
- Cable tie, mount, and fastener in a single part
- Anchor is easily pressed into a pre-formed hole and locks in place

- *Wingless* design allows tie to be used in confined spaces
- Stainless steel locking barb provides consistent performance, reliability, and infinite adjustability through entire bundle range
- Curved tip is easy to pick up from flat surfaces and allows faster initial threading to speed installation

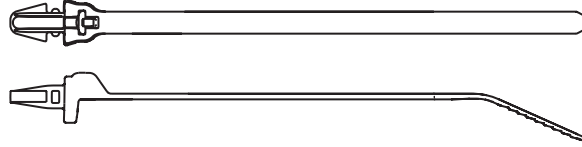
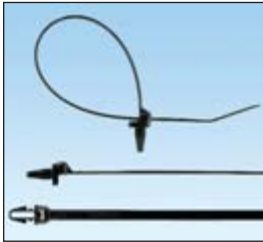

| Part Number | Length | | Width | | Thickness | | Nominal Hole Dia. | | Max. Panel Thickness | | Max. Bundle Dia. | | Min. Loop Tensile Str. | | Recommended Installation Tool | Std. Pkg. Qty. | Std. Ctn. Qty. |
|-------------------------------|--------|-----|-------|-----|-----------|-----|-------------------|-----|----------------------|-----|------------------|----|------------------------|-----|--|----------------|----------------|
| | In. | mm | In. | mm | In. | mm | In. | mm | In. | mm | In. | mm | Lbs. | N | | | |
| Standard Cross Section | | | | | | | | | | | | | | | | | |
| BP2S-D0 | 8.5 | 216 | .185 | 4.7 | .052 | 1.3 | .255 | 6.5 | .150 | 3.8 | 2.00 | 51 | 50 | 222 | GTS, GTSL, GS2B, GTH, GS4H, PTS, PTH, PPTS, STS2, STH2 | 500 | 5000 |

Permanent Marking Pens

- Fast drying, permanent ink for identification on marker ties (pages B1.34, B1.52, and B1.71), marker plates (page B2.29), or cable marker straps (page B1.80)
- May be used with any label shown in the catalog when a printer is not available



PX-0
PX-2



PFX-0
PFX-2



PX-10

| Part Number | Color | Description | Std. Pkg. Qty. | Std. Ctn. Qty. |
|-------------|-------|--|----------------|----------------|
| PX-0 | Black | Permanent marking pen – regular tip. | 12 | 144 |
| PX-2 | Red | Permanent marking pen – regular tip. | 12 | 144 |
| PFX-0 | Black | Permanent marking pen – fine tip. | 12 | 144 |
| PFX-2 | Red | Permanent marking pen – fine tip. | 12 | 144 |
| PX-10 | White | Marking pen for black or other dark colored parts – regular tip. | 12 | 300 |

A.
System
Overview

B1.
Cable Ties

B2.
Cable
Accessories

B3.
Stainless
Steel Ties

C1.
Wiring
Duct

C2.
Surface
Raceway

C3.
Abrasion
Protection

C4.
Cable
Management

D1.
Terminals

D2.
Power
Connectors

D3.
Grounding
Connectors

E1.
Labeling
Systems

E2.
Labels

E3.
Pre-Printed
& Write-On
Markers

E4.
Permanent
Identification

E5.
Lockout/
Tagout
& Safety
Solutions

F.
Index

A.
System
Overview

UL[®] US[®] CS[®] DOME-TOP[®] Barb Ty Marker and Flag Ties

B1.
Cable Ties

- Natural nylon material for indoor use
- Weather resistant material has greater resistance to damage caused by ultraviolet light – indoor or outdoor use
- Used to fasten and identify bundles at the same time

- Can be marked with *PANDUIT* marker pens on the previous page or computer printable labels
- Custom imprinting with text, symbols, or trademarks available using *PANDUIT* Custom Hot Stamping Service, see page B1.91
- Curved tip is easy to pick up from flat surfaces and allows faster initial threading to speed installation

B2.
Cable
Accessories

- Stainless steel locking barb provides consistent performance, reliability, and infinite adjustability through entire bundle range

B3.
Stainless
Steel Ties

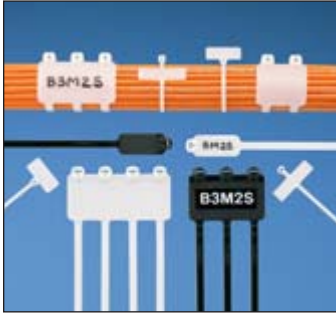

C1.
Wiring
Duct

C2.
Surface
Raceway

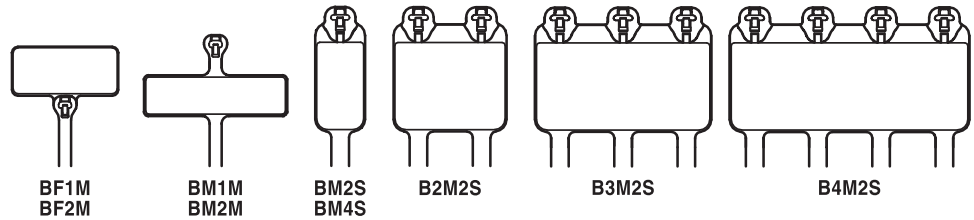

C3.
Abrasion
Protection

C4.
Cable
Management

D1.
Terminals

D2.
Power
Connectors

D3.
Grounding
Connectors

E1.
Labeling
Systems

E2.
Labels

E3.
Pre-Printed
& Write-On
Markers

E4.
Permanent
Identification

E5.
Lockout/
Tagout
& Safety
Solutions

F.
Index

| Part Number | Marker Type | Length | | Width | | Thickness | | Marker Write-On Area | | Max. Bundle Dia. | | Min. Loop Tensile Str. | | Recommended Installation Tool | Std. Pkg. Qty. | Std. Ctn. Qty. |
|-------------|-------------|--------|----|-------|----|-----------|----|----------------------|----|------------------|----|------------------------|---|-------------------------------|----------------|----------------|
| | | In. | mm | In. | mm | In. | mm | In. | mm | In. | mm | Lbs. | N | | | |

Nylon 6.6

Miniature Cross Section

| | | | | | | | | | | | | | | | | |
|---------------|------|-----|-----|------|-----|------|-----|------------|------------|------|----|----|----|----------------------------------|-----|------|
| BF1M-C | Flag | 4.6 | 117 | .095 | 2.4 | .046 | 1.2 | .36 x .81 | 9.1 x 20.6 | .90 | 23 | 18 | 80 | GTS, GTSL, GS2B, PTS, PPTS, STS2 | 100 | 1000 |
| BF2M-C | Flag | 8.3 | 211 | .095 | 2.4 | .046 | 1.2 | .36 x .81 | 9.1 x 20.6 | 2.00 | 51 | 18 | 80 | | 100 | 1000 |
| BM1M-C | Wrap | 4.2 | 107 | .095 | 2.4 | .046 | 1.2 | .29 x 1.09 | 7.4 x 27.7 | .90 | 23 | 18 | 80 | | 100 | 1000 |
| BM2M-C | Wrap | 7.9 | 201 | .095 | 2.4 | .046 | 1.2 | .29 x 1.09 | 7.4 x 27.7 | 2.00 | 51 | 18 | 80 | | 100 | 1000 |

Standard Cross Section

| | | | | | | | | | | | | | | | | |
|-----------------|------|------|-----|------|-----|------|-----|------------|-------------|------|-----|----|-----|--|-----|------|
| BM2S-C | Wrap | 8.0 | 203 | .185 | 4.7 | .045 | 1.2 | .49 x .91 | 12.4 x 23.1 | 2.00 | 51 | 50 | 222 | GTS, GTSL, GS2B, GTH, GS4H, PTS, PTH, PPTS, STS2, STH2 | 100 | 1000 |
| BM4S-C | Wrap | 15.1 | 384 | .185 | 4.7 | .052 | 1.3 | .50 x 2.13 | 12.7 x 54.1 | 4.00 | 102 | 50 | 222 | | 100 | 1000 |
| B2M2S-D | Wrap | 8.0 | 203 | .185 | 4.7 | .045 | 1.2 | 1.15 x .91 | 29.2 x 23.1 | 2.00 | 51 | 50 | 222 | | 500 | 2500 |
| B3M2S-TL | Wrap | 8.0 | 203 | .185 | 4.7 | .045 | 1.2 | 1.81 x .91 | 46.0 x 23.1 | 2.00 | 51 | 50 | 222 | | 250 | 2500 |
| B4M2S-TL | Wrap | 8.0 | 203 | .185 | 4.7 | .045 | 1.2 | 2.47 x .91 | 62.7 x 23.1 | 2.00 | 51 | 50 | 222 | | 250 | 2500 |

Weather Resistant Nylon 6.6

Miniature Cross Section

| | | | | | | | | | | | | | | | | |
|----------------|------|-----|-----|------|-----|------|-----|------------|------------|------|----|----|----|----------------------------------|------|-------|
| BF1M-M0 | Flag | 4.6 | 117 | .095 | 2.4 | .046 | 1.2 | .36 x .81 | 9.1 x 20.6 | .90 | 23 | 18 | 80 | GTS, GTSL, GS2B, PTS, PPTS, STS2 | 1000 | 25000 |
| BF2M-M0 | Flag | 8.3 | 211 | .095 | 2.4 | .046 | 1.2 | .36 x .81 | 9.1 x 20.6 | 2.00 | 51 | 18 | 80 | | 1000 | 25000 |
| BM1M-M0 | Wrap | 4.2 | 107 | .095 | 2.4 | .046 | 1.2 | .29 x 1.09 | 7.4 x 27.7 | .90 | 23 | 18 | 80 | | 1000 | 25000 |
| BM2M-M0 | Wrap | 7.9 | 201 | .095 | 2.4 | .046 | 1.2 | .29 x 1.09 | 7.4 x 27.7 | 2.00 | 51 | 18 | 80 | | 1000 | 25000 |

Standard Cross Section

| | | | | | | | | | | | | | | | | |
|------------------|------|------|-----|------|-----|------|-----|------------|-------------|------|-----|----|-----|--|-----|-------|
| BM2S-D0 | Wrap | 8.0 | 203 | .185 | 4.7 | .045 | 1.2 | .49 x .91 | 12.4 x 23.1 | 2.00 | 51 | 50 | 222 | GTS, GTSL, GS2B, GTH, GS4H, PTS, PTH, PPTS, STS2, STH2 | 500 | 10000 |
| BM4S-D0 | Wrap | 15.1 | 384 | .185 | 4.7 | .052 | 1.3 | .50 x 2.13 | 12.7 x 54.1 | 4.00 | 102 | 50 | 222 | | 500 | 5000 |
| B2M2S-D0 | Wrap | 8.0 | 203 | .185 | 4.7 | .045 | 1.2 | 1.15 x .91 | 29.2 x 23.1 | 2.00 | 51 | 50 | 222 | | 500 | 2500 |
| B3M2S-TL0 | Wrap | 8.0 | 203 | .185 | 4.7 | .045 | 1.2 | 1.81 x .91 | 46.0 x 23.1 | 2.00 | 51 | 50 | 222 | | 250 | 2500 |
| B4M2S-TL0 | Wrap | 8.0 | 203 | .185 | 4.7 | .045 | 1.2 | 2.47 x .91 | 62.7 x 23.1 | 2.00 | 51 | 50 | 222 | | 250 | 2500 |



DURA-TY™ Cable Ties – Weather Resistant Acetal – Heavy Cross Section

- Black acetal strap and head material provide 20+ years outdoor life and high impact resistance
- Excellent ultraviolet light, chemical, and moisture resistance



- Double stainless steel locking barbs provide consistent and predictable holding values
- Textured strap provides better gripping surface to prevent tie from moving laterally along the length of the bundle for tight, consistent bundles
- Robust head design allows tie to be tightened over a wide range of angles
- Convenient reel dispenser pack allows installer to cut-to-size for customized field applications; recyclable box has through-hole for attaching to belt, plus storage area for bag of heads
- Ideal for securing cables in outdoor messenger strand applications
- May be used with stackable aerial cable spacer on the next page

| Part Number | Description | Strap Length | | Strap Width | | Min. Loop Tensile Str. | | Head Height | | Head Width | | Recommended Installation Tool | Std. Pkg. Qty. | Std. Ctn. Qty. |
|--|----------------------------------|--------------|------|-------------|------|------------------------|-----|-------------|------|------------|-------|-------------------------------|----------------|----------------|
| | | Ft. | m | In. | mm | Lbs. | N | In. | mm | In. | mm | | | |
| Strapping, Heads, and Kit – Allows user to customize strap length | | | | | | | | | | | | | | |
| DTRH-LR0 | 50' reel of strapping. | 50.0 | 15.2 | .331 | 8.40 | 200 | 890 | — | — | — | — | GTH, GS4EH, STH2, STHV, ST3EH | 1 | 20 |
| DTHH-Q0 | 25 cable tie heads. | — | — | — | — | — | — | .393 | 9.98 | .557 | 14.15 | — | 25 | 500 |
| DTKH-0 | Kit: Strapping (50'), Heads (25) | 50.0 | 15.2 | .331 | 8.40 | 200 | 890 | .393 | 9.98 | .557 | 14.15 | GTH, GS4EH, STH2, STHV, ST3EH | 1 | 20 |

DURA-TY™ Cable Ties – Weather Resistant Acetal – Extra-Heavy Cross Section

- Black acetal strap and head material provide 20+ years outdoor life and high impact resistance
- Excellent ultraviolet light, chemical, and moisture resistance
- Double stainless steel locking barbs provide consistent and predictable holding values
- Ideal for securing cables in outdoor messenger strand applications
- Meets Telcordia TR-TSY-000789 industry guidelines for lashed cable supports

- Convenient reel dispenser pack allows installer to cut-to-size for customized field applications; recyclable box has through-hole for attaching to belt, plus storage area for bag of heads
- Several pre-cut sizes have lead-in style angled tips on pre-assembled straps for easy installation, even with gloved hands, to speed installation
- May be used with stackable aerial cable spacer on the next page



Formula to determine amount of strapping required:
 Diameter (inches) x 3.14 + 4.5 inches
 Diameter (mm) x 3.14 + 114mm

| Part Number | Description | Strap Length | | Strap Width | | Min. Loop Tensile Str. | | Head Height | | Head Width | | Recommended Installation Tool | Std. Pkg. Qty. | Std. Ctn. Qty. |
|--|----------------------------------|--------------|------|-------------|-------|------------------------|------|-------------|-------|------------|-------|-------------------------------|----------------|----------------|
| | | Ft. | m | In. | mm | Lbs. | N | In. | mm | In. | mm | | | |
| Strapping, Heads, and Kit – Allows user to customize strap length | | | | | | | | | | | | | | |
| DTREH-LR0 | 50' reel of strapping. | 50.0 | 15.2 | .500 | 12.70 | 250 | 1112 | — | — | — | — | GS4EH, ST3EH | 1 | 20 |
| DTHEH-Q0 | 25 cable tie heads. | — | — | — | — | — | — | .490 | 12.45 | .718 | 18.24 | — | 25 | 500 |
| DTKEH-0 | Kit: Strapping (50'), Heads (25) | 50.0 | 15.2 | .500 | 12.70 | 250 | 1112 | .490 | 12.45 | .718 | 18.24 | GS4EH, ST3EH | 1 | 20 |

| Part Number | Length | | Width | | Thickness | | Head Height | | Head Width | | Max. Bundle Dia. | Min. Loop Tensile Strength | Recommended Installation Tool | Std. Pkg. Qty. | Std. Ctn. Qty. | | |
|--|--------|------|-------|-------|-----------|------|-------------|-------|------------|-------|------------------|----------------------------|-------------------------------|----------------|----------------|-----|------|
| | In. | mm | In. | mm | In. | mm | In. | mm | In. | mm | | | | | | | |
| Discrete Lengths – Speed installation | | | | | | | | | | | | | | | | | |
| DT4EH-L0 | 13.5 | 343 | .500 | 12.70 | .059 | 1.50 | .490 | 12.45 | .718 | 18.24 | 3.8 | 98 | 250 | 1112 | GS4EH, ST3EH | 50 | 1000 |
| DT8EH-Q0 | 27.0 | 686 | .500 | 12.70 | .059 | 1.50 | .490 | 12.45 | .718 | 18.24 | 8.0 | 203 | 250 | 1112 | | 25 | 500 |
| DT14EH-L0 | 48.0 | 1219 | .500 | 12.70 | .059 | 1.50 | .490 | 12.45 | .718 | 18.24 | 14.0 | 355 | 250 | 1112 | | 50 | 250 |
| DT15EH-L0 | 53.0 | 1346 | .500 | 12.70 | .059 | 1.50 | .490 | 12.45 | .718 | 18.24 | 15.0 | 381 | 250 | 1112 | | 50 | 250 |
| DT28EH-C0 | 96.0 | 2438 | .500 | 12.70 | .059 | 1.50 | .490 | 12.45 | .718 | 18.24 | 28.0 | 711 | 250 | 1112 | | 100 | — |
| DT44EH-C0 | 144.0 | 3658 | .500 | 12.70 | .059 | 1.50 | .490 | 12.45 | .718 | 18.24 | 44.0 | 1117 | 250 | 1112 | | 100 | — |

- A. System Overview
- B1. Cable Ties
- B2. Cable Accessories
- B3. Stainless Steel Ties
- C1. Wiring Duct
- C2. Surface Raceway
- C3. Abrasion Protection
- C4. Cable Management
- D1. Terminals
- D2. Power Connectors
- D3. Grounding Connectors
- E1. Labeling Systems
- E2. Labels
- E3. Pre-Printed & Write-On Markers
- E4. Permanent Identification
- E5. Lockout/Tagout & Safety Solutions
- F. Index

A. System Overview

Stackable Aerial Cable Spacer – Weather Resistant Polypropylene

B1. Cable Ties

- Greater resistance to damage caused by ultraviolet light – indoor or outdoor use
- Each spacer snaps into another to increase spacer heights by 1/2" increments
- Designed for use in parallel or perpendicular applications
- For use with *DURA-TY™* Cable Ties shown on the previous page

B2. Cable Accessories

B3. Stainless Steel Ties

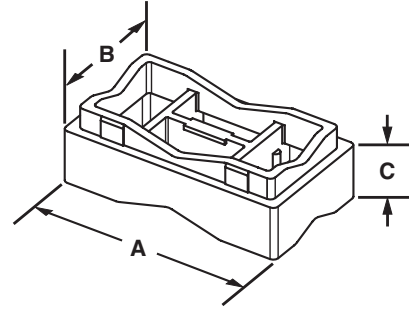

C1. Wiring Duct

C2. Surface Raceway

| Part Number | Length A | | Width B | | Height C | | Used With Cable Ties* | Std. Pkg. Qty. | Std. Ctn. Qty. |
|-------------------|----------|------|---------|------|----------|------|-----------------------|----------------|----------------|
| | In. | mm | In. | mm | In. | mm | | | |
| SACS5-T100 | 2.08 | 52.8 | 1.16 | 29.5 | .71 | 18.0 | LH, H, EH | 200 | 2000 |

*Cable tie cross section sizes: LH = Light-Heavy, H = Heavy, and EH = Extra-Heavy.

C3. Abrasion Protection

C4. Cable Management

D1. Terminals

DOME-TOP® Barb Ty and *DURA-TY™* Cable Ties

D2. Power Connectors

Material and Color Chart

D3. Grounding Connectors

| Material | Color | PANDUIT Suffix |
|-----------------------------|---------|----------------|
| Nylon 6.6 | Natural | ✓ |
| Weather Resistant Nylon 6.6 | Black | 0 |
| Nylon 6.6 | Brown | 1 |
| Nylon 6.6 | Red | 2 |
| Nylon 6.6 | Orange | 3 |
| Nylon 6.6 | Yellow | 4Y |
| Nylon 6.6 | Green | 5 |
| Nylon 6.6 | Blue | 6 |

| Material | Color | PANDUIT Suffix |
|---------------------------|-----------------|----------------|
| Nylon 6.6 | Purple | 7 |
| Nylon 6.6 | Gray | 8 |
| Nylon 6.6 | White | 10 |
| Nylon 6.6 | Telephone Gray | 14 |
| Nylon 6.6 | Black | 20 |
| Heat Stabilized Nylon 6.6 | Black | 30 |
| Heat Stabilized Nylon 6.6 | Natural | 39 |
| Flame Retardant Nylon 6.6 | Natural (Ivory) | 69 |
| Weather Resistant Acetal | Black | * |

✓ Denotes *PANDUIT* Natural Nylon 6.6 (no suffix).

*Denotes *DURA-TY™* Weather Resistant Acetal material (no suffix).

E1. Labeling Systems

E2. Labels

E3. Pre-Printed & Write-On Markers

E4. Permanent Identification

E5. Lockout/Tagout & Safety Solutions

F. Index

Part Number Availability List

| Standard Packaging | | | Bulk Packaging | | |
|--------------------|-------------------|-----------------------|----------------|-------------------|--------------------------------|
| Part Number | Natural Nylon 6.6 | Material/Color Suffix | Part Number | Natural Nylon 6.6 | Material/Color Suffix |
| | | | BC1M-S4-M | ✓ | 0 |
| | | | BC2M-S4-M | ✓ | 0 |
| | | | BC1.5I-S8-M | ✓ | 0 |
| BC2S-S10-C | ✓ | 0 | BC2S-S10-D | ✓ | 0 |
| | | | BC3S-S10-D | ✓ | 0 |
| BC4S-S10-C | ✓ | 0 | BC4S-S10-D | ✓ | 0,30 |
| BC4LH-S25-L | ✓ | 0 | BC4LH-S25-TL | ✓ | 0 |
| BF1M-C | ✓ | | BF1M-M | ✓ | 0 |
| BF2M-C | ✓ | | BF2M-M | ✓ | 0 |
| BM1M-C | ✓ | | BM1M-M | ✓ | 0 |
| BM2M-C | ✓ | | BM2M-M | ✓ | 0 |
| BM2S-C | ✓ | | BM2S-D | ✓ | 0 |
| BM4S-C | ✓ | | BM4S-D | ✓ | 0 |
| | | | BP2S-D | | 0 |
| BT1M-C | ✓ | 0,30 | BT1M-M | ✓ | 0,1,2,3,4Y,5,6,7,8,10,30,39 |
| | | | BT1M-XMR | ✓ | 0,30 |
| BT1.5M-C | ✓ | 0 | BT1.5M-M | ✓ | 0,30 |
| | | | BT1.5M-XMR | ✓ | 0,30,69 |
| BT2M-C | ✓ | 0 | BT2M-M | ✓ | 0,2,3,4Y,5,6,8,30 |
| BT4M-C | ✓ | 0 | BT4M-M | ✓ | 0 |
| BT1.5I-C | ✓ | 0 | BT1.5I-M | ✓ | 0,1,2,3,4Y,5,6,7,8,10,30,39 |
| BT2I-C | ✓ | 0 | BT2I-M | ✓ | 0,30 |
| BT3I-C | ✓ | 0 | BT3I-M | ✓ | 0,14,30 |
| BT4I-C | ✓ | 0 | BT4I-M | ✓ | 0,14 |
| BT2S-C | ✓ | 0 | BT2S-M | ✓ | 0,1,2,3,4Y,5,6,7,8,10,20,30,39 |
| BT3S-C | ✓ | 0,2 | BT3S-M | ✓ | 0,30,39 |
| BT4S-C | ✓ | 0 | BT4S-M | ✓ | 0,2,3,4Y,5,6,7,8,10,30,39 |
| BT2LH-L | ✓ | 0 | BT2LH-TL | ✓ | 0 |
| BT3LH-L | ✓ | 0 | BT3LH-TL | ✓ | 0 |
| BT4LH-L | ✓ | 0 | BT4LH-TL | ✓ | 0,30,39 |
| BT5LH-L | ✓ | 0 | BT5LH-C | ✓ | 0 |
| BT6LH-L | ✓ | 0 | BT6LH-C | ✓ | 0 |
| BT7LH-L | ✓ | 0 | BT7LH-C | ✓ | 0 |
| BT8LH-L | ✓ | 0 | BT8LH-C | ✓ | 0 |
| BT9LH-L | ✓ | 0 | BT9LH-C | ✓ | 0 |
| | | | BW1.5I-D | ✓ | |
| | | | BW2S-D | ✓ | 0 |
| | | | BW3S-D | ✓ | 0 |
| | | | B2M2S-D | ✓ | 0 |
| | | | B3M2S-TL | ✓ | 0 |
| | | | B4M2S-TL | ✓ | 0 |

DURA-TY™ Cable Ties and Strapping

| | | | | | |
|-------------------|---|--|-----------|--|---|
| DTHEH-Q0, DTHH-Q0 | * | | | | |
| DTKEH-0, DTKH-0 | * | | | | |
| DTREH-LR0 | * | | | | |
| DTRH-LR0 | * | | | | |
| DT4EH-L0 | * | | | | |
| DT8EH-Q0 | * | | | | |
| DT14EH-L0 | * | | DT14EH-C0 | | * |
| DT15EH-L0 | * | | | | |
| DT28EH-C0 | * | | | | |
| DT44EH-C0 | * | | | | |

*Denotes DURA-TY™ Weather Resistant Acetal material (no suffix).

A.
System
Overview

Features and Benefits – Parallel-Entry Cable Ties

Parallel-entry cable ties limit exposure to sharp edges and protect workers' arms/hands. The ties are designed with a low profile head to avoid snags and reduce overall bundle size.

B1.
Cable Ties

CONTOUR-TY® Cable Ties

Fully enclosed head for consistent strength

Fully rounded edges on head and strap

Outside teeth and smooth round edges protect cable jacket – ideal for high vibration applications

Curved tip threads easily and installs faster

Rounded tip and aggressive grip for faster initial threading

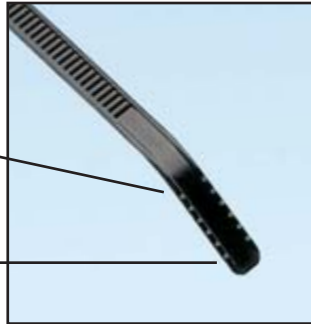

HYPER-V™ Cable Ties

Design provides for an optional threading position that allows releasable, temporary bundling

Fixed and flexible 2-wedge locking design

Tip bending serrations and threading hole facilitate installations in confined spaces

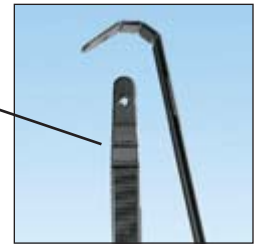
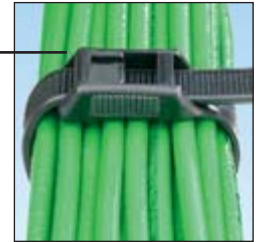

C1.
Wiring
Duct

C2.
Surface
Raceway

C3.
Abrasion
Protection

C4.
Cable
Management

D1.
Terminals

BELT-TY™ In-Line Cable Ties



"Finger grip" shaped head assures positive grip while threading tie

Parallel-entry limits exposure to sharp edges and protects workers' arms/hands



IN-LINE Cable Ties

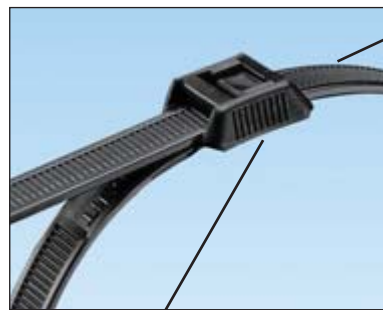

Outside teeth protect cable jacket and wire insulation

"Finger grip" shaped head with serrations assures positive grip while threading tie



D2.
Power
Connectors

D3.
Grounding
Connectors

E1.
Labeling
Systems

E2.
Labels

E3.
Pre-Printed
& Write-On
Markers

E4.
Permanent
Identification

E5.
Lockout/
Tagout
& Safety
Solutions

F.
Index



Cable tie tools speed installation and reduce total installed cost. See pages B1.107 – B1.112.



Cable tie accessories are used to speed and simplify the mounting of wires, cables, and tubing. See pages B2.1 – B2.29.

Selection Guide – Parallel-Entry Cable Ties

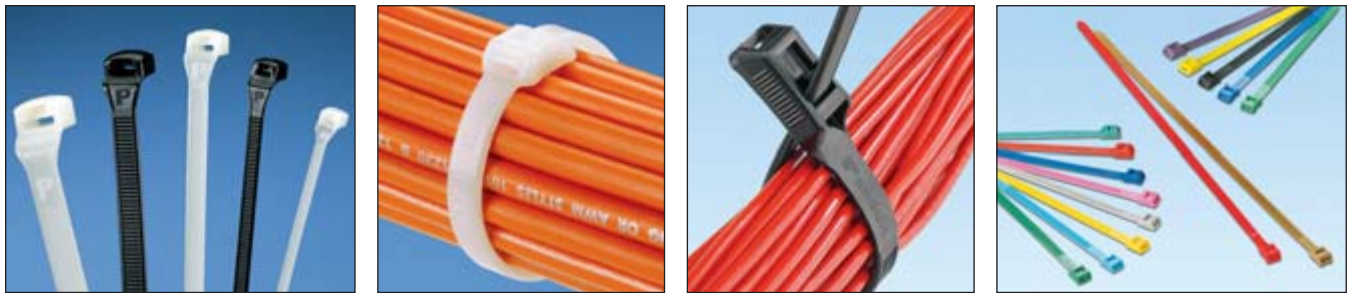

| | Material, Color (Suffix) | Style/Function | Part Number Prefix | Catalog Page |
|------------------------------------|---|---------------------|--------------------|--------------|
| CONTOUR-TY® Cable Ties | Nylon 6.6, Natural (No Suffix) | Locking Ties/Bundle | CBR | B1.58 |
| | Weather Resistant Nylon 6.6, Black (0) | Locking Ties/Bundle | CBR | B1.59 |
| | Heat Stabilized Nylon 6.6, Black (30) | Locking Ties/Bundle | CBR | B1.60 |
| | Heat Stabilized Nylon 6.6, Natural (39) | Locking Ties/Bundle | CBR | B1.60 |
| | Flame Retardant Nylon 6.6, Ivory (69) | Locking Ties/Bundle | CBR | B1.60 |
| BELT-TY™ In-Line Cable Ties | Nylon 6.6, Natural (No Suffix) | Locking Ties/Bundle | ILT | B1.61 |
| | Weather Resistant Nylon 6.6, Black (0) | Locking Ties/Bundle | ILT | B1.61 |
| HYPER-V™ Cable Ties | Weather Resistant Nylon 6.6, Black (0) | Locking Ties/Bundle | HV | B1.62 |
| IN-LINE Cable Ties | Weather Resistant Nylon 6.6, Black (0 and colors) | Locking Ties/Bundle | IT | B1.63 |

Part Number System for CONTOUR-TY® and BELT-TY™ Cable Ties

| <u>CBR</u> | <u>2</u> | <u>S</u> | — | <u>M</u> | <u> </u> |
|--|-----------------------------------|--|---|--|----------------|
| Type | Size | Cross Section | | Package Size | Material/Color |
| CBR = Locking Tie ILT = Locking Tie | Approx. Maximum Bundle Dia. (In.) | M = Miniature I = Intermediate S = Standard HS = Heavy-Standard LH = Light-Heavy | | C = 100 TL = 250 D = 500 M = 1000 | See page B1.64 |

Part Number System for HYPER-V™ and IN-LINE Cable Ties

| <u>HV</u> | <u>9</u> | <u>100</u> | — | <u>C</u> | <u> </u> |
|--------------------------------------|--------------------|----------------------------------|---|--------------|----------------|
| Type | Width | Size | | Package Size | Material/Color |
| HV = Locking Tie IT = Locking Tie | Approx. Width (mm) | Approx. Maximum Bundle Dia. (mm) | | C = 100 | See page B1.64 |

A.
System
Overview



CONTOUR-TY® Cable Ties – Nylon 6.6

B1.
Cable Ties

- For indoor use
- Unique design prevents wire and cable damage
- Low profile head avoids snags and reduces overall bundle size
- Outside teeth and smooth round edges protect cable jacket – ideal for high vibration applications
- Parallel-entry limits exposure to sharp edges and protects workers' arms/hands
- Fully enclosed head for consistent strength

- Curved tip is easy to pick up from flat surfaces and allows faster initial threading to speed installation

Note: Nylon 6.6 cable ties in natural and colors meet the testing requirements of the U.S. Military Aerospace Standard SAE-AS23190A and the dimensional requirements of Aerospace Standard SAE-AS33671.

B2.
Cable
Accessories

B3.
Stainless
Steel Ties

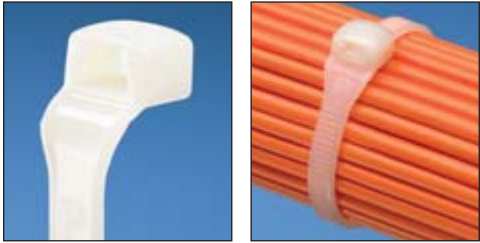

C1.
Wiring
Duct

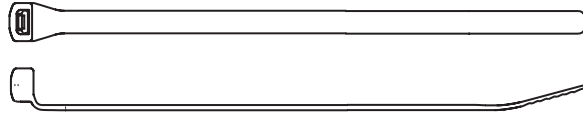

C2.
Surface
Raceway



C3.
Abrasion
Protection

C4.
Cable
Management

| Part Number | Length | | Width | | Thickness | | Max. Bundle Dia. | | Min. Loop Tensile Str. | | Recommended Installation Tool | Std. Pkg. Qty. | Std. Ctn. Qty. |
|-------------------------------------|--------|-----|-------|-----|-----------|-----|------------------|-----|------------------------|-----|--|----------------|----------------|
| | In. | mm | In. | mm | In. | mm | In. | mm | Lbs. | N | | | |
| Miniature Cross Section | | | | | | | | | | | | | |
| CBR1M-M | 4.1 | 104 | .098 | 2.5 | .038 | 1.0 | 1.00 | 25 | 18 | 80 | GTS, GTSL, GS2B, PTS, PPTS, STS2 | 1000 | 50000 |
| CBR1.5M-M | 5.6 | 142 | .098 | 2.5 | .042 | 1.1 | 1.50 | 38 | 18 | 80 | | 1000 | 50000 |
| CBR2M-M | 7.2 | 183 | .098 | 2.5 | .042 | 1.1 | 2.00 | 51 | 18 | 80 | | 1000 | 25000 |
| Intermediate Cross Section | | | | | | | | | | | | | |
| CBR1.5I-M | 5.9 | 150 | .140 | 3.6 | .040 | 1.0 | 1.50 | 38 | 40 | 178 | GTS, GTSL, GS2B, PTS, PPTS, STS2 | 1000 | 25000 |
| CBR3I-M | 10.4 | 264 | .140 | 3.6 | .052 | 1.3 | 3.00 | 76 | 40 | 178 | | 1000 | 10000 |
| CBR4I-M | 13.6 | 345 | .140 | 3.6 | .052 | 1.3 | 4.00 | 102 | 40 | 178 | | 1000 | 10000 |
| Standard Cross Section | | | | | | | | | | | | | |
| CBR2S-M | 7.6 | 193 | .190 | 4.8 | .044 | 1.1 | 2.00 | 51 | 50 | 222 | GTS, GTSL, GS2B, GTH, GS4H, PTS, PTH, PPTS, STS2, STH2 | 1000 | 10000 |
| CBR3S-M | 10.8 | 274 | .190 | 4.8 | .052 | 1.3 | 3.00 | 76 | 50 | 222 | | 1000 | 5000 |
| CBR4S-M | 14.0 | 356 | .190 | 4.8 | .052 | 1.3 | 4.00 | 102 | 50 | 222 | | 1000 | 5000 |
| Heavy-Standard Cross Section | | | | | | | | | | | | | |
| CBR2HS-D | 8.0 | 203 | .250 | 6.4 | .058 | 1.4 | 2.00 | 51 | 85 | 378 | GTH, GS4H, GS4EH, PTH, STH2, ST3EH | 500 | 5000 |
| Light-Heavy Cross Section | | | | | | | | | | | | | |
| CBR4LH-TL | 14.6 | 371 | .300 | 7.6 | .070 | 1.8 | 4.00 | 102 | 120 | 534 | GTH, GS4H, GS4EH, PTH, STH2, ST3EH | 250 | 2500 |
| CBR6LH-C | 20.9 | 531 | .300 | 7.6 | .070 | 1.8 | 6.00 | 152 | 120 | 534 | | 100 | 2000 |

E1.
Labeling
Systems

E2.
Labels

E3.
Pre-Printed
& Write-On
Markers

E4.
Permanent
Identification

E5.
Lockout/
Tagout/
& Safety
Solutions

F.
Index



CONTOUR-TY® Cable Ties – Weather Resistant Nylon 6.6

- Greater resistance to damage caused by ultraviolet light – indoor or outdoor use
- Unique design prevents wire and cable damage
- Low profile head avoids snags and reduces overall bundle size
- Outside teeth and smooth round edges protect cable jacket – ideal for high vibration applications

- Parallel-entry limits exposure to sharp edges and protects workers' arms/hands
- Fully enclosed head for consistent strength
- Curved tip is easy to pick up from flat surfaces and allows faster initial threading to speed installation

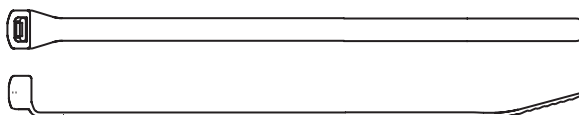

| Part Number | Length | | Width | | Thickness | | Max. Bundle Dia. | | Min. Loop Tensile Str. | | Recommended Installation Tool | Std. Pkg. Qty. | Std. Ctn. Qty. |
|-------------------------------------|--------|-----|-------|-----|-----------|-----|------------------|-----|------------------------|-----|--|----------------|----------------|
| | In. | mm | In. | mm | In. | mm | In. | mm | Lbs. | N | | | |
| Miniature Cross Section | | | | | | | | | | | | | |
| CBR1M-M0 | 4.1 | 104 | .098 | 2.5 | .038 | 1.0 | 1.00 | 25 | 18 | 80 | GTS, GTSL, GS2B, PTS, PPTS, STS2 | 1000 | 50000 |
| CBR1.5M-M0 | 5.6 | 142 | .098 | 2.5 | .042 | 1.1 | 1.50 | 38 | 18 | 80 | | 1000 | 50000 |
| CBR2M-M0 | 7.2 | 183 | .098 | 2.5 | .042 | 1.1 | 2.00 | 51 | 18 | 80 | | 1000 | 25000 |
| Intermediate Cross Section | | | | | | | | | | | | | |
| CBR1.5I-M0 | 5.9 | 150 | .140 | 3.6 | .040 | 1.0 | 1.50 | 38 | 40 | 178 | GTS, GTSL, GS2B, PTS, PPTS, STS2 | 1000 | 25000 |
| CBR3I-M0 | 10.4 | 264 | .140 | 3.6 | .052 | 1.3 | 3.00 | 76 | 40 | 178 | | 1000 | 10000 |
| CBR4I-M0 | 13.6 | 345 | .140 | 3.6 | .052 | 1.3 | 4.00 | 102 | 40 | 178 | | 1000 | 10000 |
| Standard Cross Section | | | | | | | | | | | | | |
| CBR2S-M0 | 7.6 | 193 | .190 | 4.8 | .044 | 1.1 | 2.00 | 51 | 50 | 222 | GTS, GTSL, GS2B, GTH, GS4H, PTS, PTH, PPTS, STS2, STH2 | 1000 | 10000 |
| CBR3S-M0 | 10.8 | 274 | .190 | 4.8 | .052 | 1.3 | 3.00 | 76 | 50 | 222 | | 1000 | 5000 |
| CBR4S-M0 | 14.0 | 356 | .190 | 4.8 | .052 | 1.3 | 4.00 | 102 | 50 | 222 | | 1000 | 5000 |
| Heavy-Standard Cross Section | | | | | | | | | | | | | |
| CBR2HS-D0 | 8.0 | 203 | .250 | 6.4 | .058 | 1.4 | 2.00 | 51 | 85 | 378 | GTH, GS4H, GS4EH, PTH, STH2, ST3EH | 500 | 5000 |
| Light-Heavy Cross Section | | | | | | | | | | | | | |
| CBR4LH-TL0 | 14.6 | 371 | .300 | 7.6 | .070 | 1.8 | 4.00 | 102 | 120 | 534 | GTH, GS4H, GS4EH, PTH, STH2, ST3EH | 250 | 2500 |
| CBR6LH-C0 | 20.9 | 531 | .300 | 7.6 | .070 | 1.8 | 6.00 | 152 | 120 | 534 | | 100 | 2000 |

A. System Overview

B1. Cable Ties

B2. Cable Accessories

B3. Stainless Steel Ties

C1. Wiring Duct

C2. Surface Raceway

C3. Abrasion Protection

C4. Cable Management

D1. Terminals

D2. Power Connectors

D3. Grounding Connectors

E1. Labeling Systems

E2. Labels

E3. Pre-Printed & Write-On Markers

E4. Permanent Identification

E5. Lockout/Tagout & Safety Solutions

F. Index

A. System Overview



CONTOUR-TY® Cable Ties – Heat Stabilized and Flame Retardant Nylon 6.6

B1. Cable Ties

- Heat stabilized material for high temperature applications up to 239°F (115°C) – indoor use
- Flame retardant material has a flammability rating of UL 94V-0 – indoor use
- Unique design prevents wire and cable damage
- Low profile head avoids snags and reduces overall bundle size
- Outside teeth and smooth round edges protect cable jacket – ideal for high vibration applications
- Parallel-entry limits exposure to sharp edges and protects workers' arms and hands
- Fully enclosed head for consistent strength
- Curved tip is easy to pick up from flat surfaces and allows faster initial threading to speed installation

B2. Cable Accessories

B3. Stainless Steel Ties

C1. Wiring Duct

C2. Surface Raceway



CBR2S-M30

CBR2S-M39

CBR3S-M69

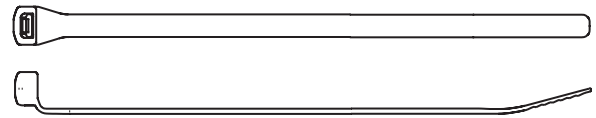

C3. Abrasion Protection

C4. Cable Management

D1. Terminals

D2. Power Connectors

D3. Grounding Connectors

E1. Labeling Systems

E2. Labels

E3. Pre-Printed & Write-On Markers

E4. Permanent Identification

E5. Lockout/Tagout & Safety Solutions

F. Index

| Part Number | Length | | Width | | Thickness | | Max. Bundle Dia. | | Min. Loop Tensile Str. | | Recommended Installation Tool | Std. Pkg. Qty. | Std. Ctn. Qty. |
|-------------|--------|-----|-------|----|-----------|----|------------------|----|------------------------|---|-------------------------------|----------------|----------------|
| | In. | mm. | In. | mm | In. | mm | In. | mm | Lbs. | N | | | |

Heat Stabilized Nylon 6.6 – Black

Miniature Cross Section

| | | | | | | | | | | | | | |
|------------------|-----|-----|------|-----|------|-----|------|----|----|----|----------------------------------|------|-------|
| CBR1M-M30 | 4.1 | 104 | .098 | 2.5 | .038 | 1.0 | 1.00 | 25 | 18 | 80 | GTS, GTSL, GS2B, PTS, PPTS, STS2 | 1000 | 50000 |
|------------------|-----|-----|------|-----|------|-----|------|----|----|----|----------------------------------|------|-------|

Intermediate Cross Section

| | | | | | | | | | | | | | |
|--------------------|-----|-----|------|-----|------|-----|------|----|----|-----|----------------------------------|------|-------|
| CBR1.5I-M30 | 5.9 | 150 | .140 | 3.6 | .040 | 1.0 | 1.50 | 38 | 40 | 178 | GTS, GTSL, GS2B, PTS, PPTS, STS2 | 1000 | 25000 |
|--------------------|-----|-----|------|-----|------|-----|------|----|----|-----|----------------------------------|------|-------|

Standard Cross Section

| | | | | | | | | | | | | | |
|------------------|------|-----|------|-----|------|-----|------|-----|----|-----|--|------|-------|
| CBR2S-M30 | 7.6 | 193 | .190 | 4.8 | .044 | 1.1 | 2.00 | 51 | 50 | 222 | GTS, GTSL, GS2B, GTH, GS4H, PTS, PTH, PPTS, STS2, STH2 | 1000 | 10000 |
| CBR3S-M30 | 10.8 | 274 | .190 | 4.8 | .052 | 1.3 | 3.00 | 76 | 50 | 222 | | 1000 | 5000 |
| CBR4S-M30 | 14.0 | 356 | .190 | 4.8 | .052 | 1.3 | 4.00 | 102 | 50 | 222 | | 1000 | 5000 |

Light-Heavy Cross Section

| | | | | | | | | | | | | | |
|--------------------|------|-----|------|-----|------|-----|------|-----|-----|-----|------------------------------------|-----|------|
| CBR4LH-TL30 | 14.6 | 371 | .300 | 7.6 | .070 | 1.8 | 4.00 | 102 | 120 | 534 | GTH, GS4H, GS4EH, PTH, STH2, ST3EH | 250 | 2500 |
| CBR6LH-C30 | 20.9 | 531 | .300 | 7.6 | .070 | 1.8 | 6.00 | 152 | 120 | 534 | | 100 | 2000 |

Heat Stabilized Nylon 6.6 – Natural

Standard Cross Section

| | | | | | | | | | | | | | |
|------------------|-----|-----|------|-----|------|-----|------|----|----|-----|--|------|-------|
| CBR2S-M39 | 7.6 | 193 | .190 | 4.8 | .044 | 1.1 | 2.00 | 51 | 50 | 222 | GTS, GTSL, GS2B, GTH, GS4H, PTS, PTH, PPTS, STS2, STH2 | 1000 | 10000 |
|------------------|-----|-----|------|-----|------|-----|------|----|----|-----|--|------|-------|

Flame Retardant Nylon 6.6 – Natural Ivory

Standard Cross Section

| | | | | | | | | | | | | | |
|------------------|------|-----|------|-----|------|-----|------|----|----|-----|--|------|------|
| CBR3S-M69 | 10.8 | 274 | .190 | 4.8 | .052 | 1.3 | 3.00 | 76 | 50 | 222 | GTS, GTSL, GS2B, GTH, GS4H, PTS, PTH, PPTS, STS2, STH2 | 1000 | 5000 |
|------------------|------|-----|------|-----|------|-----|------|----|----|-----|--|------|------|

Note: UL Recognized, UL Listed, and CSA Certified, except CBR3S-M69.

UL US LISTED **UL US LISTED** **CSA US** **BELT-TY™ In-Line Cable Ties – Nylon and Weather Resistant Nylon 6.6**

- Natural nylon material for indoor use
- Weather resistant material has greater resistance to damage caused by ultraviolet light – indoor or outdoor use
- Parallel-entry cable tie that threads like a belt (180° entry)
- Low profile head avoids snags and reduces overall bundle size
- 35% lower head height than conventional 90° ties
- Parallel-entry limits exposure to sharp edges and protects workers' arms/hands
- Curved tip is easy to pick up from flat surfaces and allows faster initial threading to speed installation



ILT2S-C



ILT2S-C0

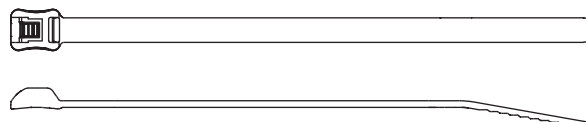

| Part Number | Length | | Width | | Thickness | | Max. Bundle Dia. | | Min. Loop Tensile Str. | | Recommended Installation Tool | Std. Pkg. Qty. | Std. Ctn. Qty. |
|-------------|--------|----|-------|----|-----------|----|------------------|----|------------------------|---|-------------------------------|----------------|----------------|
| | In. | mm | In. | mm | In. | mm | In. | mm | Lbs. | N | | | |

Nylon 6.6

Standard Cross Section

| | | | | | | | | | | | | | |
|---------|------|-----|------|-----|------|-----|------|-----|----|-----|--|-----|------|
| ILT2S-C | 8.3 | 211 | .190 | 4.8 | .052 | 1.3 | 1.88 | 48 | 50 | 222 | GTS, GTSL, GS2B, GTH, GS4H, PTS, PTH, PPTS, STS2, STH2 | 100 | 1000 |
| ILT3S-C | 11.5 | 292 | .190 | 4.8 | .052 | 1.3 | 3.00 | 76 | 50 | 222 | | 100 | 1000 |
| ILT4S-C | 14.7 | 373 | .190 | 4.8 | .052 | 1.3 | 4.00 | 102 | 50 | 222 | | 100 | 1000 |

Light-Heavy Cross Section

| | | | | | | | | | | | | | |
|-----------|------|-----|------|-----|------|-----|------|-----|-----|-----|------------------------------------|-----|------|
| ILT4LH-TL | 14.8 | 376 | .300 | 7.6 | .075 | 1.9 | 4.00 | 102 | 120 | 534 | GTH, GS4H, GS4EH, PTH, STH2, ST3EH | 250 | 2500 |
| ILT6LH-C | 21.2 | 538 | .300 | 7.6 | .075 | 1.9 | 6.00 | 152 | 120 | 534 | | 100 | 2000 |

Weather Resistant Nylon 6.6

Standard Cross Section

| | | | | | | | | | | | | | |
|----------|------|-----|------|-----|------|-----|------|-----|----|-----|--|-----|------|
| ILT2S-C0 | 8.3 | 211 | .190 | 4.8 | .052 | 1.3 | 1.88 | 48 | 50 | 222 | GTS, GTSL, GS2B, GTH, GS4H, PTS, PTH, PPTS, STS2, STH2 | 100 | 1000 |
| ILT3S-C0 | 11.5 | 292 | .190 | 4.8 | .052 | 1.3 | 3.00 | 76 | 50 | 222 | | 100 | 1000 |
| ILT4S-C0 | 14.7 | 373 | .190 | 4.8 | .052 | 1.3 | 4.00 | 102 | 50 | 222 | | 100 | 1000 |

Light-Heavy Cross Section

| | | | | | | | | | | | | | |
|------------|------|-----|------|-----|------|-----|------|-----|-----|-----|------------------------------------|-----|------|
| ILT4LH-TL0 | 14.8 | 376 | .300 | 7.6 | .075 | 1.9 | 4.00 | 102 | 120 | 534 | GTH, GS4H, GS4EH, PTH, STH2, ST3EH | 250 | 2500 |
| ILT6LH-C0 | 21.2 | 538 | .300 | 7.6 | .075 | 1.9 | 6.00 | 152 | 120 | 534 | | 100 | 2000 |

Note: Nylon 6.6 cable ties are UL Listed for use in plenum or air handling spaces per NEC. Weather resistant nylon 6.6 cable ties are UL Recognized, UL Listed, and CSA Certified, except ILT4LH/6LH.

A. System Overview

B1. Cable Ties

B2. Cable Accessories

B3. Stainless Steel Ties

C1. Wiring Duct

C2. Surface Raceway

C3. Abrasion Protection

C4. Cable Management

D1. Terminals

D2. Power Connectors

D3. Grounding Connectors

E1. Labeling Systems

E2. Labels

E3. Pre-Printed & Write-On Markers

E4. Permanent Identification

E5. Lockout/Tagout & Safety Solutions

F. Index

A. System Overview



HYPER-V™ In-Line Cable Ties – Weather Resistant Nylon 6.6

B1. Cable Ties

- Fixed and flexible two-wedge locking design provides a low threading force
- Teeth on both sides of cable tie body provide additional locking strength and improved flexibility to conform to irregular bundle shapes such as securing cables to cable tray systems
- Releasable head position for temporary bundling of cables prior to final locking; no need to replace ties when adding cables/wires to the bundle
- Teeth on full length of body support a wide range of bundle diameters
- Bending serrations on the tip of the tie allow the tip to be easily formed into an arc, enabling installer to “fish” the tie around the bundle in a confined space
- Threading hole in the tip of the tie allows an installer to hook the tip with a simple device to pull the tie through spaces with limited access
- In-Line tie design for parallel-entry of the tie into head resulting in a lower profile on cable bundles
- Complementary mounts shown below

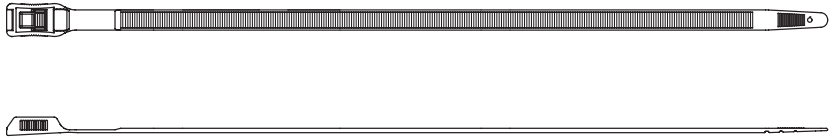

C1. Wiring Duct

C2. Surface Raceway

C3. Abrasion Protection

| Part Number | Length | | Width | | Thickness | | Max. Bundle Dia. | | Min. Loop Tensile Strength | | Recommended Installation Tool | Std. Pkg. Qty. | Std. Ctn. Qty. |
|-------------|--------|-----|-------|-----|-----------|-----|------------------|-----|----------------------------|-----|--|----------------|----------------|
| | In. | mm | In. | mm | In. | mm | In. | mm | Lbs. | N | | | |
| HV965-C0 | 10.4 | 265 | .350 | 8.9 | .076 | 1.9 | 2.60 | 65 | 160 | 710 | GTH, GS4H, GS4EH, PTH, STH2, ST3EH, STHV | 100 | 1000 |
| HV9100-C0 | 14.4 | 367 | .350 | 8.9 | .076 | 1.9 | 3.90 | 100 | 160 | 710 | | 100 | 1000 |
| HV9150-C0 | 20.7 | 525 | .350 | 8.9 | .076 | 1.9 | 5.90 | 150 | 160 | 710 | | 100 | 1000 |
| HV9250-C0 | 33.1 | 841 | .350 | 8.9 | .076 | 1.9 | 9.80 | 250 | 160 | 710 | | 100 | 1000 |

C4. Cable Management

D1. Terminals

D2. Power Connectors



HYPER-V™ Cable Tie Mounts

- Tie mount has retaining tab within window to hold cable tie in position when pre-installed in the mount; low profile design keeps bundle close to mounting surface
- Masonry mounts are used to secure wire, cable, or tubing to masonry surfaces
- For outdoor use



HVTM

HVMPM

E1. Labeling Systems

E2. Labels

E3. Pre-Printed & Write-On Markers

| Part Number | Material | Color | Mounting Method | Std. Pkg. Qty. | Std. Ctn. Qty. |
|-----------------------|---|-------|--|----------------|----------------|
| Tie Mounts | | | | | |
| HVTM3S10-C0 | Weather Resistant Nylon 6.6 | Black | #10 (6mm) screw | 100 | 500 |
| Masonry Mounts | | | | | |
| HVMPM32-C0 | Impact Modified Weather Resistant Nylon 6.6 | Black | Tree barb for .31" (7.9mm) hole diameter | 100 | 500 |

E4. Permanent Identification

E5. Lockout/Tagout & Safety Solutions

Note: UL Recognized except HVTM mount.

F. Index

IN-LINE Cable Ties – Weather Resistant Nylon 6.6

- Greater resistance to damage caused by ultraviolet light – indoor or outdoor use
- Parallel-entry cable tie that threads like a belt (180° entry)
- Wide tie body provides high tensile strength
- 50% lower head height than conventional 90° ties
- Parallel-entry limits exposure to sharp edges and protects workers' arms/hands
- Outside teeth protect cable jacket and wire insulation
- “Finger grip” shaped head with serrations assures positive grip while threading tie
- Install by hand or use *PANDUIT* GTH installation tool, see page B1.109
- Flexible – easy to handle and install
- Available in UV weather resistant colors for color coordination and UV stability

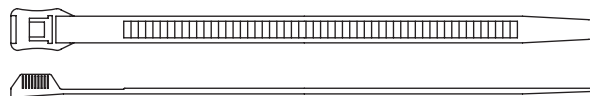

| Part Number | Color | Length | | Width | | Thickness | | Max. Bundle Dia. | | Min. Loop Tensile Str. | | Std. Pkg. Qty | Std. Ctn. Qty. |
|---------------------------|-----------------|--------|-----|-------|-----|-----------|-----|------------------|-----|------------------------|-----|---------------|----------------|
| | | In. | mm | In. | mm | In. | mm | In. | mm | Lbs. | N | | |
| Black Cable Ties | | | | | | | | | | | | | |
| IT940-C0 | UV Black | 6.8 | 173 | .350 | 8.9 | .065 | 1.7 | 1.57 | 40 | 124 | 552 | 100 | 1000 |
| IT965-C0 | UV Black | 10.1 | 257 | .350 | 8.9 | .065 | 1.7 | 2.56 | 65 | 124 | 552 | 100 | 1000 |
| IT9100-C0 | UV Black | 14.1 | 358 | .350 | 8.9 | .065 | 1.7 | 3.94 | 100 | 124 | 552 | 100 | 1000 |
| IT9115-C0 | UV Black | 15.3 | 389 | .350 | 8.9 | .065 | 1.7 | 4.53 | 115 | 124 | 552 | 100 | 1000 |
| Colored Cable Ties | | | | | | | | | | | | | |
| IT9100-CUV2 | UV Red | 14.1 | 358 | .350 | 8.9 | .065 | 1.7 | 3.94 | 100 | 124 | 552 | 100 | 1000 |
| IT9100-CUV4Y | UV Yellow | 14.1 | 358 | .350 | 8.9 | .065 | 1.7 | 3.94 | 100 | 124 | 552 | 100 | 1000 |
| IT9100-CUV6 | UV Dark Blue | 14.1 | 358 | .350 | 8.9 | .065 | 1.7 | 3.94 | 100 | 124 | 552 | 100 | 1000 |
| IT9100-CUV6A | UV Light Blue | 14.1 | 358 | .350 | 8.9 | .065 | 1.7 | 3.94 | 100 | 124 | 552 | 100 | 1000 |
| IT9100-CUV7A | UV Purple | 14.1 | 358 | .350 | 8.9 | .065 | 1.7 | 3.94 | 100 | 124 | 552 | 100 | 1000 |
| IT9100-CUV8 | UV Silver | 14.1 | 358 | .350 | 8.9 | .065 | 1.7 | 3.94 | 100 | 124 | 552 | 100 | 1000 |
| IT9100-CUV16B | UV Magenta | 14.1 | 358 | .350 | 8.9 | .065 | 1.7 | 3.94 | 100 | 124 | 552 | 100 | 1000 |
| IT9115-CUV2 | UV Red | 15.3 | 389 | .350 | 8.9 | .065 | 1.7 | 4.53 | 115 | 124 | 552 | 100 | 1000 |
| IT9115-CUV2A | UV Bright Red | 15.3 | 389 | .350 | 8.9 | .065 | 1.7 | 4.53 | 115 | 124 | 552 | 100 | 1000 |
| IT9115-CUV4Y | UV Yellow | 15.3 | 389 | .350 | 8.9 | .065 | 1.7 | 4.53 | 115 | 124 | 552 | 100 | 1000 |
| IT9115-CUV4A | UV Butterscotch | 15.3 | 389 | .350 | 8.9 | .065 | 1.7 | 4.53 | 115 | 124 | 552 | 100 | 1000 |
| IT9115-CUV5A | UV Green | 15.3 | 389 | .350 | 8.9 | .065 | 1.7 | 4.53 | 115 | 124 | 552 | 100 | 1000 |
| IT9115-CUV5B | UV Hunter Green | 15.3 | 389 | .350 | 8.9 | .065 | 1.7 | 4.53 | 115 | 124 | 552 | 100 | 1000 |
| IT9115-CUV6 | UV Dark Blue | 15.3 | 389 | .350 | 8.9 | .065 | 1.7 | 4.53 | 115 | 124 | 552 | 100 | 1000 |
| IT9115-CUV6A | UV Light Blue | 15.3 | 389 | .350 | 8.9 | .065 | 1.7 | 4.53 | 115 | 124 | 552 | 100 | 1000 |
| IT9115-CUV6B | UV Cobalt Blue | 15.3 | 389 | .350 | 8.9 | .065 | 1.7 | 4.53 | 115 | 124 | 552 | 100 | 1000 |
| IT9115-CUV7A | UV Purple | 15.3 | 389 | .350 | 8.9 | .065 | 1.7 | 4.53 | 115 | 124 | 552 | 100 | 1000 |
| IT9115-CUV8 | UV Gray | 15.3 | 389 | .350 | 8.9 | .065 | 1.7 | 4.53 | 115 | 124 | 552 | 100 | 1000 |
| IT9115-CUV11 | UV Teal | 15.3 | 389 | .350 | 8.9 | .065 | 1.7 | 4.53 | 115 | 124 | 552 | 100 | 1000 |
| IT9115-CUV16B | UV Magenta | 15.3 | 389 | .350 | 8.9 | .065 | 1.7 | 4.53 | 115 | 124 | 552 | 100 | 1000 |
| IT9115-CUV18 | UV Tan | 15.3 | 389 | .350 | 8.9 | .065 | 1.7 | 4.53 | 115 | 124 | 552 | 100 | 1000 |

A.
System
Overview

B1.
Cable Ties

B2.
Cable
Accessories

B3.
Stainless
Steel Ties

C1.
Wiring
Duct

C2.
Surface
Raceway

C3.
Abrasion
Protection

C4.
Cable
Management

D1.
Terminals

D2.
Power
Connectors

D3.
Grounding
Connectors

E1.
Labeling
Systems

E2.
Labels

E3.
Pre-Printed
& Write-On
Markers

E4.
Permanent
Identification

E5.
Lockout/
Tagout/
& Safety
Solutions

F.
Index

A.
System
Overview

Parallel-Entry Cable Ties

B1.
Cable Ties

Material and Color Chart

| Material | Color | PANDUIT Suffix | Material | Color | PANDUIT Suffix |
|-----------------------------|-----------------|----------------|-----------|--------------------------|----------------|
| Nylon 6.6 | Natural | ✓ | Nylon 6.6 | Ultraviolet Red | UV2 |
| Weather Resistant Nylon 6.6 | Black | 0 | Nylon 6.6 | Ultraviolet Bright Red | UV2A |
| Nylon 6.6 | Brown | 1 | Nylon 6.6 | Ultraviolet Yellow | UV4Y |
| Nylon 6.6 | Red | 2 | Nylon 6.6 | Ultraviolet Butterscotch | UV4A |
| Nylon 6.6 | Orange | 3 | Nylon 6.6 | Ultraviolet Green | UV5A |
| Nylon 6.6 | Yellow | 4Y | Nylon 6.6 | Ultraviolet Hunter Green | UV5B |
| Nylon 6.6 | Green | 5 | Nylon 6.6 | Ultraviolet Dark Blue | UV6 |
| Nylon 6.6 | Blue | 6 | Nylon 6.6 | Ultraviolet Light Blue | UV6A |
| Nylon 6.6 | Purple | 7 | Nylon 6.6 | Ultraviolet Cobalt Blue | UV6B |
| Nylon 6.6 | Gray | 8 | Nylon 6.6 | Ultraviolet Purple | UV7A |
| Nylon 6.6 | White | 10 | Nylon 6.6 | Ultraviolet Gray | UV8 |
| Heat Stabilized Nylon 6.6 | Black | 30 | Nylon 6.6 | Ultraviolet Teal | UV11 |
| Heat Stabilized Nylon 6.6 | Natural | 39 | Nylon 6.6 | Ultraviolet Magenta | UV16B |
| Flame Retardant Nylon 6.6 | Natural (Ivory) | 69 | Nylon 6.6 | Ultraviolet Tan | UV18 |

✓Denotes PANDUIT Natural Nylon 6.6 (no suffix).

B2.
Cable
Accessories

B3.
Stainless
Steel Ties

C1.
Wiring
Duct

C2.
Surface
Raceway

C3.
Abrasion
Protection

Part Number Availability List

| Part Number | Standard Packaging | | Part Number | Bulk Packaging | |
|-------------|--------------------|-------------------------|-------------|-------------------|---|
| | Natural Nylon 6.6 | Material/Color (Suffix) | | Natural Nylon 6.6 | Material/Color (Suffix) |
| | | | CBR1M-M | ✓ | 0,30 |
| | | | CBR1.5M-M | ✓ | 0 |
| | | | CBR2M-M | ✓ | 0,1,2,3,4Y,5,6,7 |
| | | | CBR1.5I-M | ✓ | 0,30 |
| | | | CBR3I-M | ✓ | 0,1,2,3,4Y,5,6,7,8,10 |
| | | | CBR4I-M | ✓ | 0 |
| | | | CBR2S-M | ✓ | 0,30,39 |
| | | | CBR3S-M | ✓ | 0,30,69 |
| | | | CBR4S-M | ✓ | 0,30 |
| | | | CBR2HS-D | ✓ | 0 |
| | | | CBR4LH-TL | ✓ | 0,30 |
| | | | CBR6LH-C | ✓ | 0,30 |
| | | | HV965-C | | 0 |
| | | | HV9100-C | | 0 |
| | | | HV9150-C | | 0 |
| | | | HV9250-C | | 0 |
| ILT2S-C | ✓ | 0 | ILT2S-M | ✓ | 0 |
| ILT3S-C | ✓ | 0 | ILT3S-M | ✓ | 0 |
| ILT4S-C | ✓ | 0 | ILT4S-M | ✓ | 0 |
| | | | ILT4LH-TL | ✓ | 0 |
| | | | ILT6LH-C | ✓ | 0 |
| | | | IT940-C | | 0 |
| | | | IT965-C | | 0 |
| | | | IT9100-C | | 0,UV2,UV4Y,UV6,UV6A,UV7A,UV8,UV16B |
| | | | IT9115-C | | 0,UV2,UV2A,UV4Y,UV4A,UV5A,UV5B,UV6,UV6A,UV6B,UV7A,UV8,UV11,UV16B,UV18 |

C4.
Cable
Management

D1.
Terminals

D2.
Power
Connectors

D3.
Grounding
Connectors

E1.
Labeling
Systems

E2.
Labels

E3.
Pre-Printed
& Write-On
Markers

E4.
Permanent
Identification

E5.
Lockout/
Tagout
& Safety
Solutions

F.
Index

Features and Benefits – STA-STRAP® Cable Ties

Two-piece design incorporates a separate nylon head and strap.

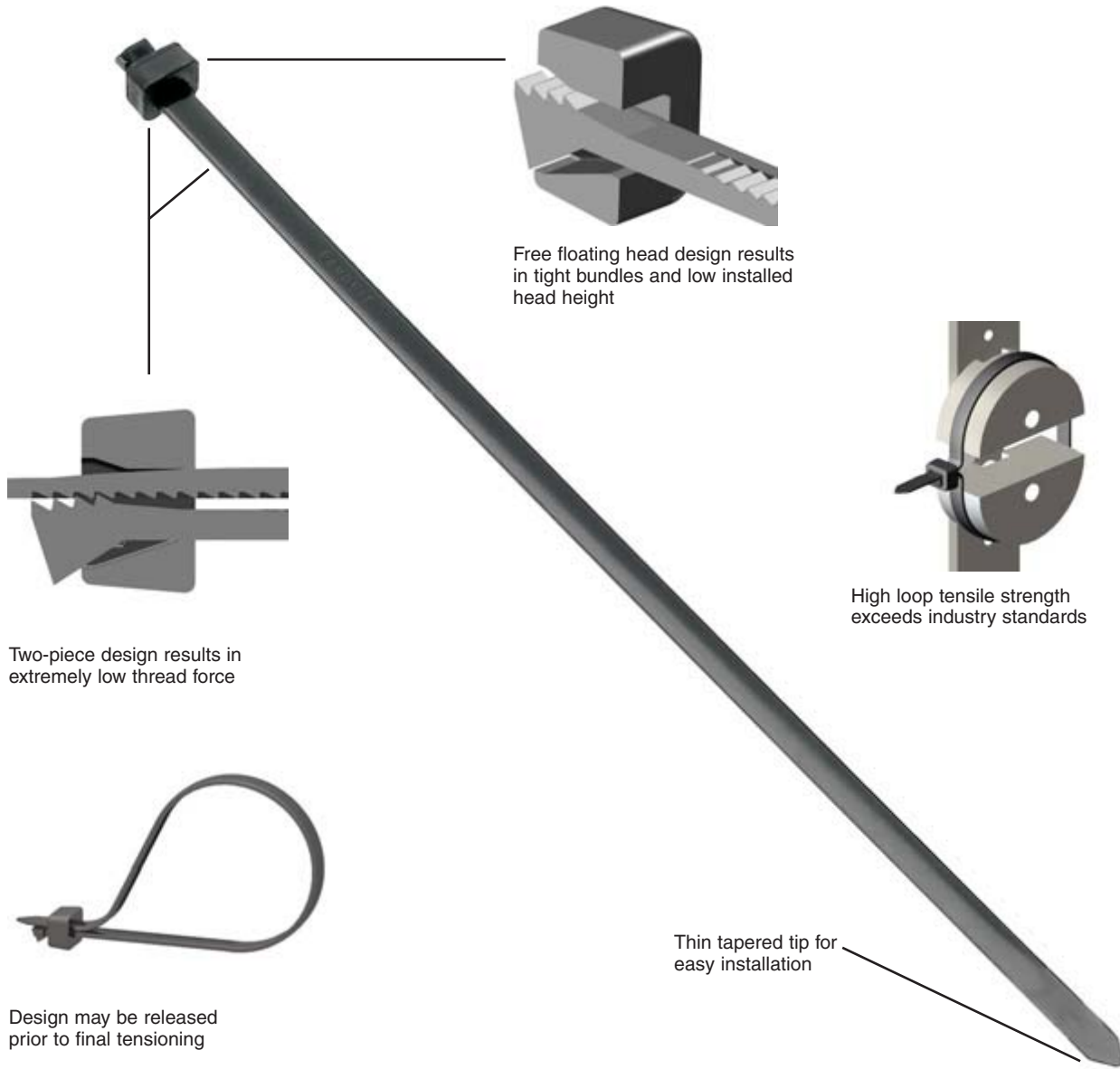

Free floating head design results in tight bundles and low installed head height

Two-piece design results in extremely low thread force

High loop tensile strength exceeds industry standards

Thin tapered tip for easy installation

Design may be released prior to final tensioning



Cable tie tools speed installation and reduce total installed cost. See pages B1.107 – B1.112.



Cable tie accessories are used to speed and simplify the mounting of wires, cables, and tubing. See pages B2.1 – B2.29.

A. System Overview

B1. Cable Ties

B2. Cable Accessories

B3. Stainless Steel Ties

C1. Wiring Duct

C2. Surface Raceway

C3. Abrasion Protection

C4. Cable Management

D1. Terminals

D2. Power Connectors

D3. Grounding Connectors

E1. Labeling Systems

E2. Labels

E3. Pre-Printed & Write-On Markers

E4. Permanent Identification

E5. Lockout/Tagout & Safety Solutions

F. Index

A.
System
Overview

Selection Guide – STA-STRAP® Cable Ties

B1.
Cable Ties



B2.
Cable
Accessories

B3.
Stainless
Steel Ties

C1.
Wiring
Duct

C2.
Surface
Raceway

C3.
Abrasion
Protection

C4.
Cable
Management

D1.
Terminals

D2.
Power
Connectors

D3.
Grounding
Connectors

E1.
Labeling
Systems

E2.
Labels

E3.
Pre-Printed
& Write-On
Markers

E4.
Permanent
Identification

E5.
Lockout/
Tagout/
& Safety
Solutions

F.
Index

| Material, Color (Suffix) | Style/Function | Part Number Prefix | Catalog Page |
|--|----------------------|--------------------|--------------|
| Nylon 6.6, Natural (No Suffix) | Locking Ties/Bundle | SST | B1.67 |
| | Clamp Ties/Mount | SSC | B1.70 |
| | Marker Ties/Identify | SSM | B1.71 |
| Weather Resistant Nylon 6.6, Black (0) | Locking Ties/Bundle | SST | B1.68 |
| | Clamp Ties/Mount | SSC | B1.70 |
| | Marker Ties/Identify | SSM | B1.71 |
| Heat Stabilized Nylon 6.6, Black (30) | Locking Ties/Bundle | SST | B1.69 |
| | Clamp Ties/Mount | SSC | B1.70 |

Part Number System for STA-STRAP® Cable Ties

| SST | 1 | M | | C | |
|--|--|---|--|--|----------------|
| Type | Size | Cross Section | Screw Hole Size | Package Size | Material/Color |
| SST = Locking Tie SSC = Clamp Tie SSM = Marker Tie | Approx. Maximum Bundle Dia. (In.) | M = Miniature I = Intermediate S = Standard H = Heavy HH = Heavy Head | (Clamp Ties Only) -S6 = #6 (M3) -S10 = #10 (M5) -S25 = 1/4 (M6) | L = 50 C = 100 D = 500 M = 1000 | See Page B1.72 |

UL[®] CS[®] STA-STRAP® Cable Ties – Nylon 6.6

- For indoor use
- Used for normal bundling and through-panel applications
- Small head height allows more efficient use of space in compact areas

- Exclusive two-piece design offers the lowest threading force in the industry
- Average 14% lighter than one-piece cable ties
- Releasable prior to final tensioning for bundle modifications

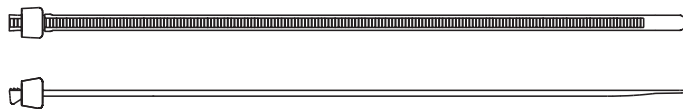

| Part Number | Length | | Width | | Thickness | | Max. Bundle Dia. | | Min. Loop Tensile Str. | | Recommended Installation Tool | Std. Pkg. Qty. | Std. Ctn. Qty. |
|-----------------------------------|--------|-----|-------|-----|-----------|-----|------------------|-----|------------------------|-----|--|----------------|----------------|
| | In. | mm | In. | mm | In. | mm | In. | mm | Lbs. | N | | | |
| Miniature Cross Section | | | | | | | | | | | | | |
| SST1M-C | 4.0 | 102 | .095 | 2.4 | .035 | .9 | .78 | 20 | 18 | 80 | GTS, GTSL, GS2B, PTS, PPTS, STS2 | 100 | 1000 |
| SST1.5M-C | 5.5 | 140 | .095 | 2.4 | .037 | .9 | 1.25 | 32 | 18 | 80 | | 100 | 1000 |
| Intermediate Cross Section | | | | | | | | | | | | | |
| SST1.5I-C | 5.3 | 137 | .135 | 3.4 | .037 | .9 | 1.25 | 32 | 40 | 178 | GTS, GTSL, GS2B, PTS, PPTS, STS2 | 100 | 1000 |
| SST2I-C | 8.1 | 206 | .135 | 3.4 | .040 | 1.0 | 2.00 | 51 | 40 | 178 | | 100 | 1000 |
| SST3I-C | 11.0 | 279 | .135 | 3.4 | .040 | 1.0 | 3.00 | 76 | 40 | 178 | | 100 | 1000 |
| SST4I-C | 14.7 | 375 | .135 | 3.4 | .040 | 1.0 | 4.00 | 102 | 40 | 178 | | 100 | 1000 |
| Standard Cross Section | | | | | | | | | | | | | |
| SST1.5S-M | 5.7 | 146 | .180 | 4.6 | .045 | 1.2 | 1.25 | 32 | 50 | 222 | GTS, GTSL, GS2B, GTH, GS4H, PTS, PTH, PPTS, STS2, STH2 | 1000 | 25000 |
| SST2S-C | 6.7 | 172 | .180 | 4.6 | .045 | 1.2 | 1.75 | 45 | 50 | 222 | | 100 | 1000 |
| SST3S-C | 11.0 | 279 | .180 | 4.6 | .048 | 1.2 | 3.00 | 76 | 50 | 222 | | 100 | 1000 |
| SST4S-C | 15.0 | 381 | .180 | 4.6 | .048 | 1.2 | 4.00 | 102 | 50 | 222 | | 100 | 1000 |
| Light-Heavy Cross Section | | | | | | | | | | | | | |
| SST2H-D | 8.0 | 203 | .300 | 7.6 | .062 | 1.6 | 2.00 | 51 | 120 | 534 | GTH, GS4H, GS4EH, PTH, STH2, ST3EH | 500 | 5000 |
| SST4H-L | 14.8 | 376 | .300 | 7.6 | .067 | 1.7 | 4.00 | 102 | 120 | 534 | | 50 | 500 |
| SST8H-L | 27.5 | 699 | .300 | 7.6 | .067 | 1.7 | 8.00 | 203 | 120 | 534 | | 50 | 500 |

A. System Overview

B1. Cable Ties

B2. Cable Accessories

B3. Stainless Steel Ties

C1. Wiring Duct

C2. Surface Raceway

C3. Abrasion Protection

C4. Cable Management

D1. Terminals

D2. Power Connectors

D3. Grounding Connectors

E1. Labeling Systems

E2. Labels

E3. Pre-Printed & Write-On Markers

E4. Permanent Identification

E5. Lockout/Tagout & Safety Solutions

F. Index

A.
System
Overview

B1.
Cable Ties

B2.
Cable
Accessories

B3.
Stainless
Steel Ties

C1.
Wiring
Duct

C2.
Surface
Raceway

C3.
Abrasion
Protection

C4.
Cable
Management

D1.
Terminals

D2.
Power
Connectors

D3.
Grounding
Connectors

E1.
Labeling
Systems

E2.
Labels

E3.
Pre-Printed
& Write-On
Markers

E4.
Permanent
Identification

E5.
Lockout/
Tagout/
& Safety
Solutions

F.
Index

UL US CSA STA-STRAP® Cable Ties – Weather Resistant Nylon 6.6

- Greater resistance to damage caused by ultraviolet light – indoor or outdoor use
- Used for normal bundling and through-panel applications
- Small head height allows more efficient use of space in compact areas
- Exclusive two-piece design offers the lowest threading force in the industry
- Average 14% lighter than one-piece cable ties
- Releasable prior to final tensioning for bundle modifications

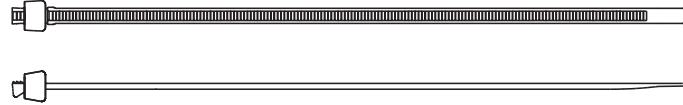

| Part Number | Length | | Width | | Thickness | | Max. Bundle Dia. | | Min. Loop Tensile Str. | | Recommended Installation Tool | Std. Pkg. Qty. | Std. Ctn. Qty. |
|-----------------------------------|--------|-----|-------|-----|-----------|-----|------------------|-----|------------------------|-----|--|----------------|----------------|
| | In. | mm | In. | mm | In. | mm | In. | mm | Lbs. | N | | | |
| Miniature Cross Section | | | | | | | | | | | | | |
| SST1M-C0 | 4.0 | 102 | .095 | 2.4 | .035 | .9 | .78 | 20 | 18 | 80 | GTS, GTSL, GS2B, PTS, PPTS, STS2 | 100 | 1000 |
| SST1.5M-M0 | 5.5 | 140 | .095 | 2.4 | .037 | .9 | 1.25 | 32 | 18 | 80 | | 1000 | 50000 |
| Intermediate Cross Section | | | | | | | | | | | | | |
| SST1.5I-M0 | 5.3 | 137 | .135 | 3.4 | .037 | .9 | 1.25 | 32 | 40 | 178 | GTS, GTSL, GS2B, PTS, PPTS, STS2 | 1000 | 25000 |
| SST2I-M0 | 8.1 | 206 | .135 | 3.4 | .040 | 1.0 | 2.00 | 51 | 40 | 178 | | 1000 | 25000 |
| SST3I-C0 | 11.0 | 279 | .135 | 3.4 | .040 | 1.0 | 3.00 | 76 | 40 | 178 | | 100 | 1000 |
| SST4I-M0 | 14.7 | 375 | .135 | 3.4 | .040 | 1.0 | 4.00 | 102 | 40 | 178 | | 1000 | 10000 |
| Standard Cross Section | | | | | | | | | | | | | |
| SST1.5S-M0 | 5.7 | 146 | .180 | 4.6 | .045 | 1.2 | 1.25 | 32 | 50 | 222 | GTS, GTSL, GS2B, GTH, GS4H, PTS, PTH, PPTS, STS2, STH2 | 1000 | 25000 |
| SST2S-C0 | 6.7 | 172 | .180 | 4.6 | .045 | 1.2 | 1.75 | 45 | 50 | 222 | | 100 | 1000 |
| SST3S-C0 | 11.0 | 279 | .180 | 4.6 | .048 | 1.2 | 3.00 | 76 | 50 | 222 | | 100 | 1000 |
| SST4S-C0 | 15.0 | 381 | .180 | 4.6 | .048 | 1.2 | 4.00 | 102 | 50 | 222 | | 100 | 1000 |
| Light-Heavy Cross Section | | | | | | | | | | | | | |
| SST2H-D0 | 8.0 | 203 | .300 | 7.6 | .062 | 1.6 | 2.00 | 51 | 120 | 534 | GTH, GS4H, GS4EH, PTH, STH2, ST3EH | 500 | 5000 |
| SST4H-L0 | 14.8 | 376 | .300 | 7.6 | .067 | 1.7 | 4.00 | 102 | 120 | 534 | | 50 | 500 |
| SST8H-L0 | 27.5 | 699 | .300 | 7.6 | .067 | 1.7 | 8.00 | 203 | 120 | 534 | | 50 | 500 |

UL[®] US CS[®] STA-STRAP® Cable Ties – Heat Stabilized Nylon 6.6

- For high temperature applications up to 239°F (115°C) – indoor use
- Used for normal bundling and through-panel applications
- *Heavy head* design is available for use in through-panel applications with a larger opening up to .400" (10.2mm)
- Small head height allows more efficient use of space in compact areas

- Exclusive two-piece design offers the lowest threading force in the industry
- Average 14% lighter than one-piece cable ties
- Releasable prior to final tensioning for bundle modifications



SST

SST2HH

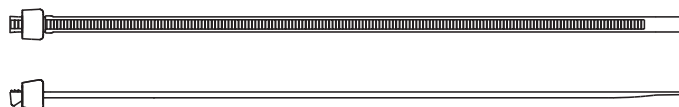

| Part Number | Length | | Width | | Thickness | | Max. Bundle Dia. | | Min. Loop Tensile Str. | | Recommended Installation Tool | Std. Pkg. Qty. | Std. Ctn. Qty. |
|----------------------------------|--------|-----|-------|-----|-----------|-----|------------------|-----|------------------------|-----|--|----------------|----------------|
| | In. | mm | In. | mm | In. | mm | In. | mm | Lbs. | N | | | |
| Miniature Cross Section | | | | | | | | | | | | | |
| SST1M-M30 | 4.0 | 102 | .095 | 2.4 | .035 | .9 | .78 | 20 | 18 | 80 | GTS, GTSL, GS2B, PTS, PPTS, STS2 | 1000 | 50000 |
| SST1.5M-M30 | 5.5 | 140 | .095 | 2.4 | .037 | .9 | 1.25 | 32 | 18 | 80 | | 1000 | 50000 |
| Standard Cross Section | | | | | | | | | | | | | |
| SST2S-M30 | 6.7 | 172 | .180 | 4.6 | .045 | 1.2 | 1.75 | 45 | 50 | 222 | GTS, GTSL, GS2B, GTH, GS4H, PTS, PTH, PPTS, STS2, STH2 | 1000 | 15000 |
| SST3S-M30 | 11.0 | 279 | .180 | 4.6 | .048 | 1.2 | 3.00 | 76 | 50 | 222 | | 1000 | 10000 |
| SST4S-M30 | 15.0 | 381 | .180 | 4.6 | .048 | 1.2 | 4.00 | 102 | 50 | 222 | | 1000 | 5000 |
| Light-Heavy Cross Section | | | | | | | | | | | | | |
| SST4H-D30 | 14.8 | 376 | .300 | 7.6 | .067 | 1.7 | 4.00 | 102 | 120 | 534 | GTH, GS4H, GS4EH, PTH, STH2, ST3EH | 500 | 2500 |
| SST8H-D30 | 27.5 | 699 | .300 | 7.6 | .067 | 1.7 | 8.00 | 203 | 120 | 534 | | 500 | 2000 |
| Heavy Head Design | | | | | | | | | | | | | |
| Light-Heavy Cross Section | | | | | | | | | | | | | |
| SST2HH-D30 | 8.0 | 203 | .300 | 7.6 | .062 | 1.6 | 2.00 | 50 | 120 | 534 | GTH, GS4H, GS4EH, PTH, STH2, ST3EH | 500 | 2500 |
| SST4HH-D30 | 14.8 | 376 | .300 | 7.6 | .062 | 1.6 | 4.00 | 102 | 120 | 534 | | 500 | 2500 |

A. System Overview

B1. Cable Ties

B2. Cable Accessories

B3. Stainless Steel Ties

C1. Wiring Duct

C2. Surface Raceway

C3. Abrasion Protection

C4. Cable Management

D1. Terminals

D2. Power Connectors

D3. Grounding Connectors

E1. Labeling Systems

E2. Labels

E3. Pre-Printed & Write-On Markers

E4. Permanent Identification

E5. Lockout/Tagout & Safety Solutions

F. Index

A. System Overview

STA-STRAP® Clamp Ties

B1. Cable Ties

- Natural nylon material for indoor use
- Weather resistant material has greater resistance to damage caused by ultraviolet light – indoor or outdoor use
- Heat stabilized material for high temperature applications up to 239°F (115°C) – indoor use
- Design allows for bundling before or after screwing clamp in place

- Exclusive two-piece design offers the lowest threading force in the industry
- Used to secure a cable bundle to another surface such as a control panel, communication rack, wall or ceiling
- Only clamp tie that is releasable prior to final tensioning

B2. Cable Accessories

B3. Stainless Steel Ties



SSC2S-S10-C

SSC2S-S10-M0

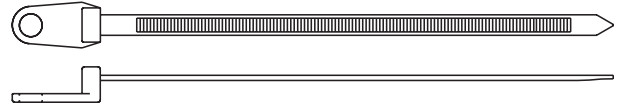

C1. Wiring Duct

C2. Surface Raceway

| Part Number | Length | | Width | | Thickness | | Nominal Hole Dia. | | Screw Size | Metric Screw Size | Max. Bundle Dia. | | Min. Loop Tensile Str. | | Recommended Installation Tool | Std. Pkg. Qty. | Std. Ctn. Qty. |
|-------------|--------|----|-------|----|-----------|----|-------------------|----|------------|-------------------|------------------|----|------------------------|---|-------------------------------|----------------|----------------|
| | In. | mm | In. | mm | In. | mm | In. | mm | | | In. | mm | Lbs. | N | | | |

C3. Abrasion Protection

Nylon 6.6

Standard Cross Section

| | | | | | | | | | | | | | | | | | |
|--------------------|------|-----|------|-----|------|-----|------|-----|-----|----|------|-----|----|-----|--|-----|------|
| SSC2S-S6-C | 7.4 | 187 | .180 | 4.6 | .045 | 1.1 | .148 | 3.8 | #6 | M3 | 1.75 | 45 | 50 | 222 | GTS, GTSL, GS2B, GTH, GS4H, PTS, PTH, PPTS, STS2, STH2 | 100 | 1000 |
| SSC2S-S10-C | 7.4 | 187 | .180 | 4.6 | .045 | 1.1 | .200 | 5.1 | #10 | M5 | 1.75 | 45 | 50 | 222 | | 100 | 1000 |
| SSC4S-S10-C | 15.7 | 398 | .180 | 4.6 | .045 | 1.1 | .200 | 5.1 | #10 | M5 | 4.00 | 102 | 50 | 222 | | 100 | 500 |

C4. Cable Management

Light-Heavy Cross Section

| | | | | | | | | | | | | | | | | | |
|-------------|------|-----|------|-----|------|-----|------|-----|-----|----|------|-----|-----|-----|------------------------------------|----|-----|
| SSC4H-S25-L | 15.6 | 395 | .300 | 7.6 | .065 | 1.7 | .260 | 6.6 | 1/4 | M6 | 4.00 | 102 | 120 | 534 | GTH, GS4H, GS4EH, PTH, STH2, ST3EH | 50 | 500 |
|-------------|------|-----|------|-----|------|-----|------|-----|-----|----|------|-----|-----|-----|------------------------------------|----|-----|

D1. Terminals

D2. Power Connectors

Weather Resistant Nylon 6.6

Standard Cross Section

| | | | | | | | | | | | | | | | | | |
|---------------------|------|-----|------|-----|------|-----|------|-----|-----|----|------|-----|----|-----|--|------|-------|
| SSC2S-S6-M0 | 7.4 | 187 | .180 | 4.6 | .045 | 1.1 | .148 | 3.8 | #6 | M3 | 1.75 | 45 | 50 | 222 | GTS, GTSL, GS2B, GTH, GS4H, PTS, PTH, PPTS, STS2, STH2 | 1000 | 10000 |
| SSC2S-S10-M0 | 7.4 | 187 | .180 | 4.6 | .045 | 1.1 | .200 | 5.1 | #10 | M5 | 1.75 | 45 | 50 | 222 | | 1000 | 10000 |
| SSC4S-S10-M0 | 15.7 | 398 | .180 | 4.6 | .045 | 1.1 | .200 | 5.1 | #10 | M5 | 4.00 | 102 | 50 | 222 | | 1000 | 5000 |

D3. Grounding Connectors

Light-Heavy Cross Section

| | | | | | | | | | | | | | | | | | |
|--------------|------|-----|------|-----|------|-----|------|-----|-----|----|------|-----|-----|-----|------------------------------------|-----|------|
| SSC4H-S25-D0 | 15.6 | 395 | .300 | 7.6 | .065 | 1.7 | .260 | 6.6 | 1/4 | M6 | 4.00 | 102 | 120 | 534 | GTH, GS4H, GS4EH, PTH, STH2, ST3EH | 500 | 2500 |
|--------------|------|-----|------|-----|------|-----|------|-----|-----|----|------|-----|-----|-----|------------------------------------|-----|------|

E1. Labeling Systems

E2. Labels

Heat Stabilized Nylon 6.6

Standard Cross Section

| | | | | | | | | | | | | | | | | | |
|----------------------|-----|-----|------|-----|------|-----|------|-----|-----|----|------|----|----|-----|--|------|-------|
| SSC2S-S10-M30 | 7.4 | 187 | .180 | 4.6 | .045 | 1.2 | .200 | 5.1 | #10 | M5 | 1.75 | 45 | 50 | 222 | GTS, GTSL, GS2B, GTH, GS4H, PTS, PTH, PPTS, STS2, STH2 | 1000 | 10000 |
| | | | | | | | | | | | | | | | | | |

E3. Pre-Printed & Write-On Markers

Light-Heavy Cross Section

| | | | | | | | | | | | | | | | | | |
|---------------|------|-----|------|-----|------|-----|------|-----|-----|----|------|-----|-----|-----|------------------------------------|-----|------|
| SSC4H-S25-D30 | 15.6 | 395 | .300 | 7.6 | .065 | 1.7 | .260 | 6.6 | 1/4 | M6 | 4.00 | 102 | 120 | 534 | GTH, GS4H, GS4EH, PTH, STH2, ST3EH | 500 | 2500 |
|---------------|------|-----|------|-----|------|-----|------|-----|-----|----|------|-----|-----|-----|------------------------------------|-----|------|

E4. Permanent Identification

E5. Lockout/Tagout & Safety Solutions

F. Index

UL US CSA US STA-STRAP® Marker Ties – Nylon and Weather Resistant Nylon 6.6

- Natural nylon material for indoor use
- Weather resistant material has greater resistance to damage caused by ultraviolet light – indoor or outdoor use
- Used to fasten and identify bundles at the same time
- Unique design allows tie to be used as a wrap-around or flag marker

- Can be marked with *PANDUIT* Marker Pens on page B1.51 or computer printable labels
- Custom imprinting with text, symbols, or trademarks available using *PANDUIT* Custom Hot Stamping Service, see page B1.91



SSM2S-C



SSM2S-D0

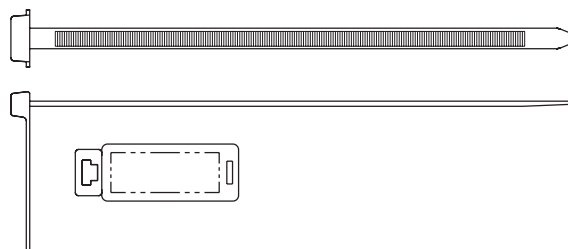

| Part Number | Marker Type | Length | | Width | | Thickness | | Marker Write-On Area | | Max. Bundle Dia. | | Min. Loop Tensile Str. | | Recommended Installation Tool | Std. Pkg. Qty. | Std. Ctn. Qty. |
|-------------|-------------|--------|----|-------|----|-----------|----|----------------------|----|------------------|----|------------------------|---|-------------------------------|----------------|----------------|
| | | In. | mm | In. | mm | In. | mm | In. | mm | In. | mm | Lbs. | N | | | |

Nylon 6.6

Standard Cross Section

| | | | | | | | | | | | | | | | | |
|----------------|-----------|------|-----|------|-----|------|-----|-----------|-------------|------|-----|----|-----|--|-----|------|
| SSM2S-C | Wrap/Flag | 6.7 | 170 | .180 | 4.6 | .045 | 1.1 | .44 x .96 | 11.2 x 24.4 | 1.75 | 45 | 50 | 222 | GTS, GTSL, GS2B, GTH, GS4H, PTS, PTH, PPTS, STS2, STH2 | 100 | 500 |
| SSM4S-D | Wrap/Flag | 14.9 | 378 | .180 | 4.6 | .045 | 1.1 | .44 x .96 | 11.2 x 24.4 | 4.00 | 102 | 50 | 222 | GTS, GTSL, GS2B, GTH, GS4H, PTS, PTH, PPTS, STS2, STH2 | 500 | 5000 |

Weather Resistant Nylon 6.6

Standard Cross Section

| | | | | | | | | | | | | | | | | |
|-----------------|-----------|-----|-----|------|-----|------|-----|-----------|-------------|------|----|----|-----|--|-----|-------|
| SSM2S-D0 | Wrap/Flag | 6.7 | 170 | .180 | 4.6 | .045 | 1.1 | .44 x .96 | 11.2 x 24.4 | 1.75 | 45 | 50 | 222 | GTS, GTSL, GS2B, GTH, GS4H, PTS, PTH, PPTS, STS2, STH2 | 500 | 10000 |
|-----------------|-----------|-----|-----|------|-----|------|-----|-----------|-------------|------|----|----|-----|--|-----|-------|

A. System Overview

B1. Cable Ties

B2. Cable Accessories

B3. Stainless Steel Ties

C1. Wiring Duct

C2. Surface Raceway

C3. Abrasion Protection

C4. Cable Management

D1. Terminals

D2. Power Connectors

D3. Grounding Connectors

E1. Labeling Systems

E2. Labels

E3. Pre-Printed & Write-On Markers

E4. Permanent Identification

E5. Lockout/Tagout & Safety Solutions

F. Index

A.
System
Overview

STA-STRAP® Cable Ties

B1.
Cable Ties

Material and Color Chart

| Material | Color | PANDUIT Suffix |
|-----------------------------|---------|----------------|
| Nylon 6.6 | Natural | ✓ |
| Weather Resistant Nylon 6.6 | Black | 0 |
| Nylon 6.6 | Red | 2 |

| Material | Color | PANDUIT Suffix |
|---------------------------|-------|----------------|
| Nylon 6.6 | Black | 20 |
| Heat Stabilized Nylon 6.6 | Black | 30 |

✓Denotes PANDUIT Natural Nylon 6.6 (no suffix).

C1.
Wiring
Duct

C2.
Surface
Raceway

C3.
Abrasion
Protection

Part Number Availability List

| Standard Packaging | | | Bulk Packaging | | |
|--------------------|-------------------|-----------------------|----------------|-------------------|-----------------------|
| Part Number | Natural Nylon 6.6 | Material/Color Suffix | Part Number | Natural Nylon 6.6 | Material/Color Suffix |
| SSC2S-S6-C | ✓ | | SSC2S-S6-M | ✓ | 0 |
| SSC2S-S10-C | ✓ | | SSC2S-S10-M | ✓ | 0,30 |
| SSC4S-S10-C | ✓ | | SSC4S-S10-M | ✓ | 0 |
| SSC4H-S25-L | ✓ | | SSC4H-S25-D | ✓ | 0 |
| SSM2S-C | ✓ | | SSM2S-D | ✓ | 0 |
| | | | SSM4S-D | ✓ | |
| SST1M-C | ✓ | 0 | SST1M-M | ✓ | 0,20,30 |
| SST1.5M-C | ✓ | | SST1.5M-M | ✓ | 0,20,30 |
| SST1.5I-C | ✓ | | SST1.5I-M | ✓ | 0 |
| SST2I-C | ✓ | | SST2I-M | ✓ | 0 |
| SST3I-C | ✓ | 0 | SST3I-M | ✓ | 0 |
| SST4I-C | ✓ | | SST4I-M | ✓ | 0 |
| | | | SST1.5S-M | ✓ | 0 |
| SST2S-C | ✓ | 0 | SST2S-M | ✓ | 0,20,30 |
| SST3S-C | ✓ | 0 | SST3S-M | ✓ | 0,20,30 |
| SST4S-C | ✓ | 0 | SST4S-M | ✓ | 0,2,30 |
| | | | SST2H-D | ✓ | 0 |
| | | | SST2HH-D | | 30 |
| SST4H-L | ✓ | 0 | SST4H-D | ✓ | 0,30 |
| | | | SST4HH-D | | 30 |
| SST8H-L | ✓ | 0 | SST8H-D | ✓ | 0,30 |

E3.
Pre-Printed
& Write-On
Markers

E4.
Permanent
Identification

E5.
Lockout/
Tagout/
& Safety
Solutions

F.
Index

Selection Guide – Specialty Ties



| | Material, Color (Suffix) | Style/Function | Part Number Prefix | Catalog Page |
|-------------------------------------|--|----------------------|--------------------|--------------|
| Stud Mounted Cable Ties | Heat Stabilized Nylon 6.6, Black (30) | Locking Ties/Bundle | PLST | B1.74 |
| | | Releasable/Re-usable | PRST | B1.74 |
| | Heat Stabilized Weather Resistant Nylon 6.6, Black (300) | Locking/Bundle | PLST | B1.74 |
| Ladder Style Stud Mount | Heat Stabilized Nylon 6.6, Black (30) | Releasable/Re-usable | PRST | B1.75 |
| Double Loop Ties – One-Piece | Nylon 6.6, Natural (No Suffix) | Locking/Bundle | PLB | B1.76 |
| | Weather Resistant Nylon 6.6, Black (0) | | | |
| | Heat Stabilized Nylon 6.6, Black (30) | | | |
| Double Loop Ties – Two-Piece | Nylon 6.6, Natural (No Suffix) | Locking/Bundle | SSB | B1.77 |
| | Weather Resistant Nylon 6.6, Black (0) | | | |
| | Heat Stabilized Nylon 6.6, Black (30) | | | |
| Triple Loop Ties | Weather Resistant Nylon 6.6, Black (0) | Locking/Bundle | PL3B | B1.78 |
| Double Hose Clamp | Weather Resistant Nylon 6.6, Black (0) | Locking/Bundle | DHC | B1.78 |
| Chassis/ Panel Mount Ties | Heat Stabilized Weather Resistant Nylon 6.6, Black (300) | Locking/Bundle | SSPM | B1.79 |
| Cable Marker Strap | Polyethylene (No Suffix) | Releasable/Re-usable | CM4S | B1.80 |

Part Number System for Specialty Cable Ties

PLST

Type

CM4S = Cable Marker Strap
 PLB = Locking Bow Tie
 PL3B = Triple Loop Tie
 DHC = Double Hose Clamp
 PLST = Locking Stud Mounted Tie
 PRST = Releasable Stud Mount Ladder Style
 SSB = STA-STRAP® BOW-TY™ Tie
 SSPM = STA-STRAP® Panel Mount

4

Size

Approx. Maximum Bundle Dia. (In.)

H

Cross Section

S = Standard
 H = Heavy
 EH = Extra-Heavy

S25

Stud Size

-S25 = M6
 -SC = 5mm
 -S14 = 5mm

—

TL

Package Size

L = 50
 C = 100
 TL = 250
 D = 500
 M = 1000

300

Material/Color

See Page B1.81



Cable tie tools speed installation and reduce total installed cost. See pages B1.107 – B1.112.



Cable tie accessories are used to speed and simplify the mounting of wires, cables, and tubing. See pages B2.1 – B2.29.

A. System Overview

B1. Cable Ties

B2. Cable Accessories

B3. Stainless Steel Ties

C1. Wiring Duct

C2. Surface Raceway

C3. Abrasion Protection

C4. Cable Management

D1. Terminals

D2. Power Connectors

D3. Grounding Connectors

E1. Labeling Systems

E2. Labels

E3. Pre-Printed & Write-On Markers

E4. Permanent Identification

E5. Lockout/Tagout & Safety Solutions

F. Index

A. System Overview



PAN-TY® Stud Mounted Cable Ties – Heat Stabilized and Heat Stabilized Weather Resistant Nylon 6.6

B1. Cable Ties

- Heat stabilized material for high temperature applications up to 239°F (115°C) – indoor use
- Heat stabilized weather resistant material has greater resistance to damage caused by ultraviolet light and for high temperature applications up to 212°F (100°C) – indoor or outdoor use
- Integral mount pushes onto a threaded stud and tie wraps around bundle

- Mid-mount style (PLST_SC) centers the wire bundle over the stud
- Tie can be removed from the stud by turning counterclockwise
- Releasable style available (PRST)
- Curved tip is easy to pick up from flat surfaces and allows faster initial threading to speed installation

B2. Cable Accessories

B3. Stainless Steel Ties

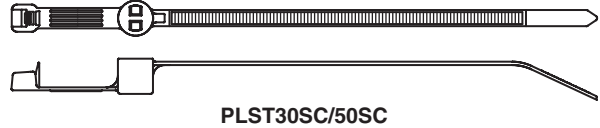

C1. Wiring Duct

C2. Surface Raceway



C3. Abrasion Protection

C4. Cable Management



D1. Terminals

D2. Power Connectors

D3. Grounding Connectors

| Part Number | Length | | Width | | Thickness | | Recommended Stud Size | | Max. Bundle Dia. | | Min. Loop Tensile Str. | | Recommended Installation Tool | Std. Pkg. Qty. | Std. Ctn. Qty. |
|-------------|--------|----|-------|----|-----------|----|-----------------------|----|------------------|----|------------------------|---|-------------------------------|----------------|----------------|
| | In. | mm | In. | mm | In. | mm | In. | mm | In. | mm | Lbs. | N | | | |

Heat Stabilized Nylon 6.6

Standard Cross Section

| | | | | | | | | | | | | | | | |
|--------------|-----|-----|------|-----|------|-----|-------|-----|------|----|----|-----|--|-------------------|------|
| PLST30SC-D30 | 5.7 | 146 | .190 | 4.8 | .050 | 1.3 | 10-24 | 5.0 | 1.18 | 30 | 50 | 222 | GTS, GTSL, GS2B, GTH, GS4H, PTS, PTH, PPTS, STS2, STH2 | 500 | 5000 |
| PLST50SC-D30 | 8.1 | 207 | .190 | 4.8 | .050 | 1.3 | 10-24 | 5.0 | 1.97 | 50 | 50 | 222 | | 500 | 5000 |
| PRST40SC-D30 | 6.9 | 176 | .190 | 4.8 | .050 | 1.3 | 10-24 | 5.0 | 1.57 | 40 | 50 | 222 | | Hand install only | 500 |

Heat Stabilized Weather Resistant Nylon 6.6

Light-Heavy Cross Section

| | | | | | | | | | | | | | | | |
|-----------------|------|-----|------|-----|------|-----|--------|-----|------|-----|-----|-----|------------------------------------|-----|------|
| PLST4HS25-TL300 | 15.3 | 389 | .300 | 7.6 | .075 | 1.9 | 1/4-20 | 6.4 | 4.00 | 102 | 120 | 534 | GTH, GS4H, GS4EH, PTH, STH2, ST3EH | 250 | 2500 |
|-----------------|------|-----|------|-----|------|-----|--------|-----|------|-----|-----|-----|------------------------------------|-----|------|

Note: UL Recognized and CSA Certified except PLST4H.

E5. Lockout/Tagout & Safety Solutions

F. Index

UL **CS** **PAN-TY**® Ladder Style Stud Mounted Cable Tie – Heat Stabilized Nylon 6.6

- For high temperature applications up to 239°F (115°C) – indoor use
- Integral mount pushes onto a threaded stud and tie wraps around bundle

- Tie can be removed from the stud by turning counterclockwise
- Adjustable, releasable, and re-usable
- Install by hand – no tools required

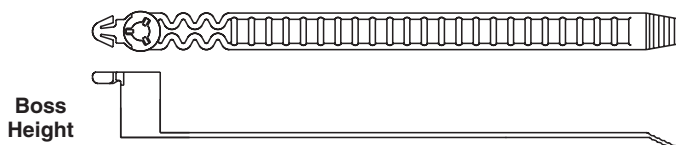

| Part Number | Length | | Width | | Thickness | | Boss Height | | Recommended Stud Size | | Max. Bundle Dia. | | Min. Loop Tensile Str. | | Std. Pkg. Qty. | Std. Ctn. Qty. |
|-------------|--------|----|-------|----|-----------|----|-------------|----|-----------------------|----|------------------|----|------------------------|---|----------------|----------------|
| | In. | mm | In. | mm | In. | mm | In. | mm | In. | mm | In. | mm | Lbs. | N | | |

Standard Cross Section

| | | | | | | | | | | | | | | | | |
|-----------------|-----|-----|------|-----|------|-----|-----|----|-------|-----|------|----|----|-----|------|-------|
| PRST30S-S14-M30 | 5.2 | 132 | .380 | 9.7 | .050 | 1.3 | .59 | 15 | 10-24 | 5.0 | 1.18 | 30 | 35 | 156 | 1000 | 10000 |
|-----------------|-----|-----|------|-----|------|-----|-----|----|-------|-----|------|----|----|-----|------|-------|

A.
System
Overview

B1.
Cable Ties

B2.
Cable
Accessories

B3.
Stainless
Steel Ties

C1.
Wiring
Duct

C2.
Surface
Raceway

C3.
Abrasion
Protection

C4.
Cable
Management

D1.
Terminals

D2.
Power
Connectors

D3.
Grounding
Connectors

E1.
Labeling
Systems

E2.
Labels

E3.
Pre-Printed
& Write-On
Markers

E4.
Permanent
Identification

E5.
Lockout/
Tagout/
& Safety
Solutions

F.
Index

A. System Overview

B1. Cable Ties

B2. Cable Accessories

B3. Stainless Steel Ties

C1. Wiring Duct

C2. Surface Raceway

C3. Abrasion Protection

C4. Cable Management

D1. Terminals

D2. Power Connectors

D3. Grounding Connectors

E1. Labeling Systems

E2. Labels

E3. Pre-Printed & Write-On Markers

E4. Permanent Identification

E5. Lockout/Tagout & Safety Solutions

F. Index

UL[®] US[®] CS[®] PAN-TY[®] Double Loop Cable Ties

- Natural nylon material for indoor use
- Weather resistant material has greater resistance to damage caused by ultraviolet light – indoor or outdoor use
- Heat Stabilized material for high temperature applications up to 239°F (115°C) – indoor use

- A fast and economical method to secure and separate two bundles
- Reduces part number inventory – single part covers multiple bundle sizes
- Installs easily by hand – second loop can be installed with *PANDUIT* cable tie installation tools



PLB4H
Head Design



PLB2S/3S/4S
Head Design

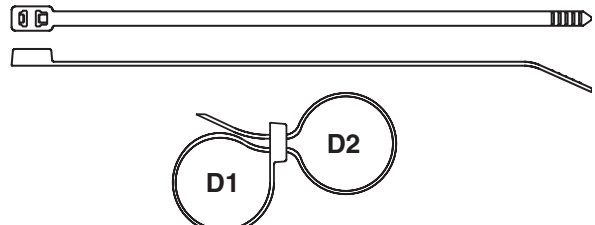

Assembled View

| Part Number | Max. Combined Bundle Dia. D1 + D2 | | Length | | Width | | Thickness | | Min. Loop Tensile Str. | | Recommended Installation Tool | Std. Pkg. Qty. | Std. Ctn. Qty. |
|-------------|-----------------------------------|----|--------|----|-------|----|-----------|----|------------------------|---|-------------------------------|----------------|----------------|
| | In. | mm | In. | mm | In. | mm | In. | mm | Lbs. | N | | | |

Nylon 6.6 Standard Cross Section

| | | | | | | | | | | | | | |
|----------------|------|-----|------|-----|------|-----|------|-----|----|-----|--|-----|------|
| PLB2S-C | 1.80 | 46 | 7.6 | 193 | .190 | 4.8 | .052 | 1.3 | 50 | 222 | GTS, GTSL, GS2B, GTH, GS4H, PTS, PTH, PPTS, STS2, STH2 | 100 | 1000 |
| PLB3S-C | 3.00 | 76 | 11.8 | 300 | .190 | 4.8 | .052 | 1.3 | 50 | 222 | | 100 | 1000 |
| PLB4S-C | 4.10 | 104 | 14.8 | 376 | .190 | 4.8 | .052 | 1.3 | 50 | 222 | | 100 | 1000 |

Light-Heavy Cross Section

| | | | | | | | | | | | | | |
|-----------------|------|----|------|-----|------|-----|------|-----|-----|-----|------------------------------------|-----|------|
| PLB4H-TL | 3.60 | 91 | 14.7 | 373 | .300 | 7.6 | .075 | 1.9 | 120 | 534 | GTH, GS4H, GS4EH, PTH, STH2, ST3EH | 250 | 2500 |
|-----------------|------|----|------|-----|------|-----|------|-----|-----|-----|------------------------------------|-----|------|

Weather Resistant Nylon 6.6 Standard Cross Section

| | | | | | | | | | | | | | |
|-----------------|------|-----|------|-----|------|-----|------|-----|----|-----|--|------|------|
| PLB2S-C0 | 1.80 | 46 | 7.6 | 193 | .190 | 4.8 | .052 | 1.3 | 50 | 222 | GTS, GTSL, GS2B, GTH, GS4H, PTS, PTH, PPTS, STS2, STH2 | 100 | 1000 |
| PLB3S-C0 | 3.00 | 76 | 11.8 | 300 | .190 | 4.8 | .052 | 1.3 | 50 | 222 | | 100 | 1000 |
| PLB4S-M0 | 4.10 | 104 | 14.8 | 376 | .190 | 4.8 | .052 | 1.3 | 50 | 222 | | 1000 | 5000 |

Light-Heavy Cross Section

| | | | | | | | | | | | | | |
|------------------|------|----|------|-----|------|-----|------|-----|-----|-----|------------------------------------|-----|------|
| PLB4H-TL0 | 3.60 | 91 | 14.7 | 373 | .300 | 7.6 | .075 | 1.9 | 120 | 534 | GTH, GS4H, GS4EH, PTH, STH2, ST3EH | 250 | 2500 |
|------------------|------|----|------|-----|------|-----|------|-----|-----|-----|------------------------------------|-----|------|

Heat Stabilized Nylon 6.6 Standard Cross Section

| | | | | | | | | | | | | | |
|------------------|------|-----|------|-----|------|-----|------|-----|----|-----|--|------|-------|
| PLB2S-M30 | 1.80 | 46 | 7.6 | 193 | .190 | 4.8 | .052 | 1.3 | 50 | 222 | GTS, GTSL, GS2B, GTH, GS4H, PTS, PTH, PPTS, STS2, STH2 | 1000 | 10000 |
| PLB3S-M30 | 3.00 | 76 | 11.8 | 300 | .190 | 4.8 | .052 | 1.3 | 50 | 222 | | 1000 | 10000 |
| PLB4S-M30 | 4.10 | 104 | 14.8 | 376 | .190 | 4.8 | .052 | 1.3 | 50 | 222 | | 1000 | 5000 |

Light-Heavy Cross Section

| | | | | | | | | | | | | | |
|-------------------|------|----|------|-----|------|-----|------|-----|-----|-----|------------------------------------|-----|------|
| PLB4H-TL30 | 3.60 | 91 | 14.7 | 373 | .300 | 7.6 | .075 | 1.9 | 120 | 534 | GTH, GS4H, GS4EH, PTH, STH2, ST3EH | 250 | 2500 |
|-------------------|------|----|------|-----|------|-----|------|-----|-----|-----|------------------------------------|-----|------|

Note: UL Recognized and CSA Certified except PLB4H-TL0.

UL US C US STA-STRAP® BOW-TY™ Cable Ties

- Natural nylon material for indoor use
- Weather resistant material has greater resistance to damage caused by ultraviolet light – indoor or outdoor use
- Heat Stabilized material for high temperature applications up to 239°F (115°C) – indoor use

- A fast and economical method to secure and separate two bundles
- Exclusive two-piece design offers the lowest threading force in the industry
- First loop is releasable prior to final tensing

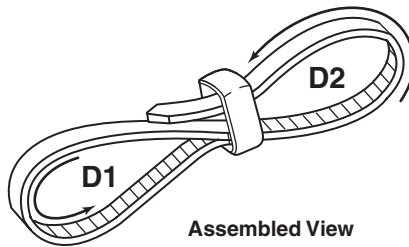
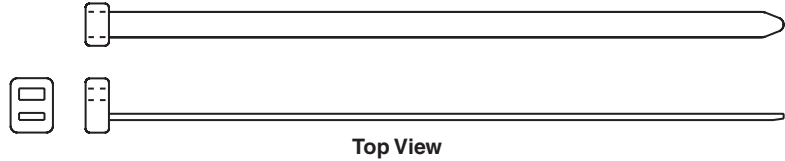

| Part Number | Max. Combined Bundle Dia. D1 + D2 | | Length | | Width | | Thickness | | Min. Loop Tensile Str. | | Recommended Installation Tool | Std. Pkg. Qty. | Std. Ctn. Qty. |
|-------------|-----------------------------------|----|--------|----|-------|----|-----------|----|------------------------|---|-------------------------------|----------------|----------------|
| | In. | mm | In. | mm | In. | mm | In. | mm | Lbs. | N | | | |

Nylon 6.6

Standard Cross Section

| | | | | | | | | | | | | | |
|---------|------|----|-----|-----|-----|-----|------|-----|----|-----|-------------------|-----|------|
| SSB2S-C | 1.25 | 32 | 6.8 | 172 | .18 | 4.6 | .045 | 1.1 | 30 | 133 | Hand install only | 100 | 1000 |
|---------|------|----|-----|-----|-----|-----|------|-----|----|-----|-------------------|-----|------|

Weather Resistant Nylon 6.6

Standard Cross Section

| | | | | | | | | | | | | | |
|----------|------|----|-----|-----|-----|-----|------|-----|----|-----|-------------------|------|-------|
| SSB2S-M0 | 1.25 | 32 | 6.8 | 172 | .18 | 4.6 | .045 | 1.1 | 30 | 133 | Hand install only | 1000 | 10000 |
|----------|------|----|-----|-----|-----|-----|------|-----|----|-----|-------------------|------|-------|

Heat Stabilized Nylon 6.6

Standard Cross Section

| | | | | | | | | | | | | | |
|-----------|------|----|-----|-----|-----|-----|------|-----|----|-----|-------------------|------|-------|
| SSB2S-M30 | 1.25 | 32 | 6.8 | 172 | .18 | 4.6 | .045 | 1.1 | 30 | 133 | Hand install only | 1000 | 10000 |
|-----------|------|----|-----|-----|-----|-----|------|-----|----|-----|-------------------|------|-------|

A. System Overview

B1. Cable Ties

B2. Cable Accessories

B3. Stainless Steel Ties

C1. Wiring Duct

C2. Surface Raceway

C3. Abrasion Protection

C4. Cable Management

D1. Terminals

D2. Power Connectors

D3. Grounding Connectors

E1. Labeling Systems

E2. Labels

E3. Pre-Printed & Write-On Markers

E4. Permanent Identification

E5. Lockout/Tagout & Safety Solutions

F. Index

A. System Overview

PAN-TY® Triple Loop Cable Tie – Weather Resistant Nylon 6.6

B1. Cable Ties

- Greater resistance to damage caused by ultraviolet light – indoor or outdoor use
- A fast and economical method to secure and separate three bundles
- Third loop can be installed with *PANDUIT* cable tie installation tools

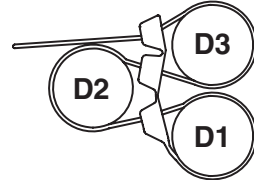
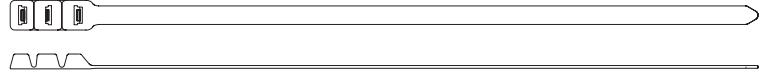

Assembled View

C1. Wiring Duct

C2. Surface Raceway

| Part Number | Max. Combined Bundle Dia. D1 + D2 + D3 | | Length | | Width | | Thickness | | Min. Loop Tensile Str. | | Recommended Installation Tool | Std. Pkg. Qty. | Std. Ctn. Qty. |
|----------------------------------|--|-----|--------|-----|-------|------|-----------|-----|------------------------|-----|-------------------------------|----------------|----------------|
| | In. | mm | In. | mm | In. | mm | In. | mm | Lbs. | N | | | |
| Extra-Heavy Cross Section | | | | | | | | | | | | | |
| PL3B5EH-C0 | 5.00 | 127 | 20.0 | 508 | .500 | 12.7 | .075 | 1.9 | 125 | 556 | GS4EH, ST3EH | 100 | 1000 |

C3. Abrasion Protection

C4. Cable Management

Double Hose Clamp – Weather Resistant Nylon 6.6

- Greater resistance to damage caused by ultraviolet light – indoor or outdoor use
- Holds and separates two gasoline, hydraulic, or pneumatic hoses
- Holds each hose individually to prevent abrasion and twisting

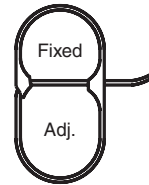
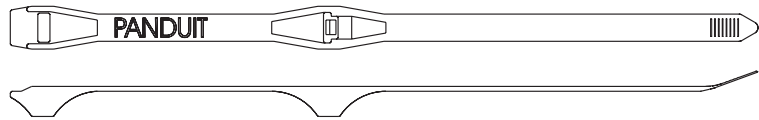

Assembled View

D1. Terminals

D2. Power Connectors

D3. Grounding Connectors

E1. Labeling Systems

| Part Number | Length | | Width | | Thickness | | Fixed Loop Dia. | | Adjustable Loop Dia. | | Min. Loop Tensile Str. | | Recommended Installation Tool | Std. Pkg. Qty. | Std. Ctn. Qty. |
|------------------------|--------|-----|-------|-----|-----------|-----|-----------------|----|----------------------|-------|------------------------|-----|-------------------------------|----------------|----------------|
| | In. | mm | In. | mm | In. | mm | In. | mm | In. | mm | Lbs. | N | | | |
| DHC1.12X1.75-D0 | 11.0 | 279 | .280 | 7.1 | .050 | 1.3 | 1.12 | 28 | 1.00–1.75 | 25–44 | 100 | 445 | GTH, GS4H, PTH, STH2, ST3EH | 500 | 2500 |

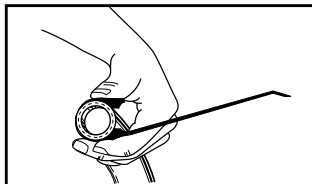

1) Wrap clamp around hose

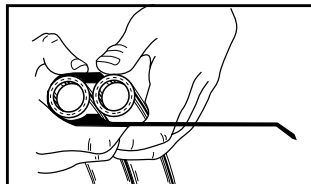

2) Position second hose in clamp

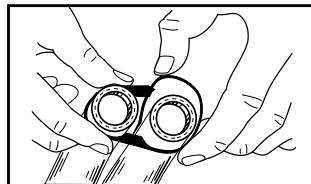

3) Loop tail around second hose and thread tail through both spacer heads

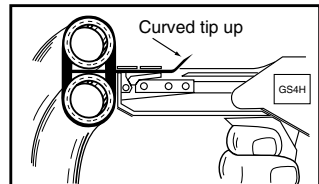

4) Tension and cut off with recommended tool

E4. Permanent Identification

E5. Lockout/Tagout & Safety Solutions

F. Index



STA-STRAP® Chassis/Panel Mount Tie – Heat Stabilized Weather Resistant Nylon 6.6

- Greater resistance to damage caused by ultraviolet light and for high temperature applications up to 212°F (100°C) – indoor or outdoor use
- Unique design allows tie to secure a bundle directly to a chassis or panel without the need for separate fasteners or mounting devices

- Releasable prior to final tensioning for bundle modifications
- Engages clearance hole with optional centering pilot to prevent tie from shifting or abrading in high vibration environments

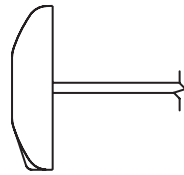
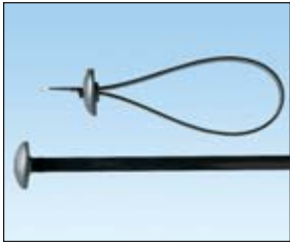

Without Centering Pilot

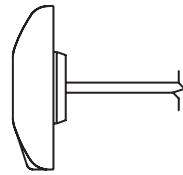

With Centering Pilot

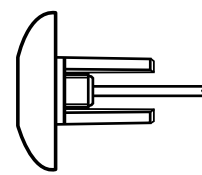

With Long Centering Pilot

| Part Number | Length | | Width | | Thickness | | Hole Diameter Range | | Max. Bundle Dia. | | Min. Loop Tensile Str. | | Recommended Installation Tool | Std. Pkg. Qty. | Std. Ctn. Qty. |
|----------------------------------|--------|-----|-------|-----|-----------|-----|---------------------|-------------|------------------|-----|------------------------|-----|------------------------------------|----------------|----------------|
| | In. | mm | In. | mm | In. | mm | In. | mm | In. | mm | Lbs. | N | | | |
| Without Centering Pilot | | | | | | | | | | | | | | | |
| SSPM2.5H-L300 | 10.1 | 257 | .300 | 7.6 | .062 | 1.6 | .316 – .820 | 8.0 – 21.0 | 2.76 | 70 | 120 | 534 | GTH, GS4H, GS4EH, PTH, STH2, ST3EH | 50 | 2500 |
| SSPM4H-L300 | 14.8 | 376 | .300 | 7.6 | .062 | 1.6 | .316 – .820 | 8.0 – 21.0 | 4.00 | 102 | 120 | 534 | GTH, GS4H, GS4EH, PTH, STH2, ST3EH | 50 | 2500 |
| With Centering Pilot | | | | | | | | | | | | | | | |
| SSPM2.5HP-L300 | 10.1 | 257 | .300 | 7.6 | .062 | 1.6 | .440 – .820 | 11.2 – 21.0 | 2.76 | 70 | 120 | 534 | GTH, GS4H, GS4EH, PTH, STH2, ST3EH | 50 | 2500 |
| SSPM4HP-L300 | 14.8 | 376 | .300 | 7.6 | .062 | 1.6 | .440 – .820 | 11.2 – 21.0 | 4.00 | 102 | 120 | 534 | GTH, GS4H, GS4EH, PTH, STH2, ST3EH | 50 | 2500 |
| With Long Centering Pilot | | | | | | | | | | | | | | | |
| SSPM4HLP-TL300 | 14.8 | 376 | .300 | 7.6 | .062 | 1.6 | .440 – .820 | 11.2 – 21.0 | 4.00 | 102 | 120 | 534 | GTH, GS4H, GS4EH, PTH, STH2, ST3EH | 250 | 2500 |

Through-Panel Mount Installation in Three Easy Steps:

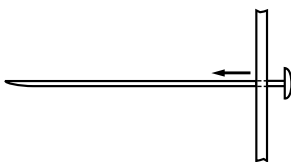

1) Insert tip of cable tie through the pre-drilled hole in the panel.

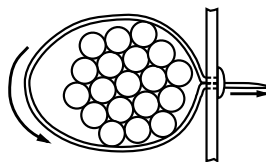

2) Wrap cable tie around the bundle and insert tip back through the hole and head of the cable tie.

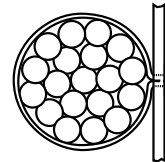

3) Pull tip until cable tie is snug on bundle. Tension and cut off excess portion with installation tool.

A.
System
Overview

Cable Marker Straps – Polyethylene

B1.
Cable Ties

- Identify and code telephone and fiber optic cable
- Eliminate the need for costly and cumbersome lead marking tags
- Lightweight and easy to install
- Use as wrap-around or flag marker

- For underground identification applications
- Can be marked with *PANDUIT* marker pens, see page B1.51
- Custom imprinting with text, symbols, or trademarks available using *PANDUIT* Custom Hot Stamping Service, see page B1.91

B2.
Cable
Accessories

B3.
Stainless
Steel Ties



C1.
Wiring
Duct

C2.
Surface
Raceway

C3.
Abrasion
Protection

C4.
Cable
Management



**Wrap-Around
Marker**
(Min. Dia.: 1.27")

Flag Marker
(Min. Dia.: .25")

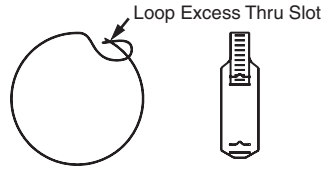
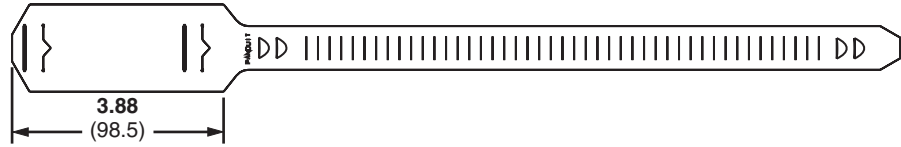

D1.
Terminals

D2.
Power
Connectors

D3.
Grounding
Connectors

| Part Number | Length | | Width | | Thickness | | Color | Marker Write-On Area | | Max. Bundle Dia. | | Recommended Installation Tool | Std. Pkg. Qty. | Std. Ctn. Qty. |
|-------------------------------|--------|-----|-------|------|-----------|-----|-------|----------------------|-------------|------------------|-----|-------------------------------|----------------|----------------|
| | In. | mm | In. | mm | In. | mm | | In. | mm | In. | mm | | | |
| Standard Cross Section | | | | | | | | | | | | | | |
| CM4S-L2 | 15.3 | 387 | .750 | 19.1 | .033 | .84 | Red | 1.50 x 2.62 | 38.1 x 66.5 | 4.38 | 111 | Hand install only | 50 | 500 |
| CM4S-L8 | 15.3 | 387 | .750 | 19.1 | .033 | .84 | Gray | 1.50 x 2.62 | 38.1 x 66.5 | 4.38 | 111 | | 50 | 500 |

E1.
Labeling
Systems

E2.
Labels

E3.
Pre-Printed
& Write-On
Markers

E4.
Permanent
Identification

E5.
Lockout/
Tagout/
& Safety
Solutions

F.
Index

Specialty Cable Ties

Material and Color Chart

| Material | Color | PANDUIT Suffix |
|-----------------------------|---------|----------------|
| Nylon 6.6 | Natural | ✓ |
| Weather Resistant Nylon 6.6 | Black | 0 |
| Nylon 6.6 | Red | 2 |
| Nylon 6.6 | Gray | 8 |

| Material | Color | PANDUIT Suffix |
|---|-------|----------------|
| Heat Stabilized Nylon 6.6 | Black | 30 |
| Heat Stabilized Weather Resistant Nylon 6.6 | Black | 300 |

✓ Denotes PANDUIT Natural Nylon 6.6 (no suffix).

Part Number Availability List

| Standard Packaging | | | Bulk Packaging | | |
|--------------------|-------------------|-----------------------|----------------|-------------------|-----------------------|
| Part Number | Natural Nylon 6.6 | Material/Color Suffix | Part Number | Natural Nylon 6.6 | Material/Color Suffix |
| CM4S-L | | 2,8 | | | |
| | | | DHC1.12X1.75-D | | 0 |
| PLB2S-C | ✓ | 0 | PLB2S-M | ✓ | 0,30 |
| PLB3S-C | ✓ | 0 | PLB3S-M | ✓ | 0,30 |
| PLB4S-C | ✓ | | PLB4S-M | ✓ | 0,30 |
| | | | PLB4H-TL | ✓ | 0,30 |
| | | | PL3B5EH-C | | 0 |
| | | | PLST4HS25-TL | | 300 |
| | | | PLST30SC-D | | 30 |
| | | | PLST50SC-D | | 30 |
| | | | PRST30S-S14-M | | 30 |
| | | | PRST40SC-SD | | 30 |
| SSB2S-C | ✓ | | SSB2S-M | ✓ | 0,30 |
| SSPM2.5H-L | | 300 | SSPM2.5H-TL | | 300 |
| SSPM2.5HP-L | | 300 | SSPM2.5HP-TL | | 300 |
| SSPM4H-L | | 300 | SSPM4H-TL | | 300 |
| SSPM4HP-L | | 300 | SSPM4HP-TL | | 300 |
| | | | SSPM4HLP-TL | | 300 |

A.
System
Overview

B1.
Cable Ties

B2.
Cable
Accessories

B3.
Stainless
Steel Ties

C1.
Wiring
Duct

C2.
Surface
Raceway

C3.
Abrasion
Protection

C4.
Cable
Management

D1.
Terminals

D2.
Power
Connectors

D3.
Grounding
Connectors

E1.
Labeling
Systems

E2.
Labels

E3.
Pre-Printed
& Write-On
Markers

E4.
Permanent
Identification

E5.
Lockout/
Tagout
& Safety
Solutions

F.
Index

A.
System
Overview

PAN-TY® Striped Cable Ties – Nylon 6.6

B1.
Cable Ties

- Nylon material for indoor use
- Striped *PAN-TY®* Cable Ties in 25 color combinations match the universally accepted Even-Count Color Code

- Solid color ties are available for identification of “super groups” in cable containing more than 600 pairs
- Each 50-piece package fits in the *PAN-POUCH™* Kit or pocket pouch shown on the next page

B2.
Cable
Accessories



B3.
Stainless
Steel Ties

C1.
Wiring
Duct

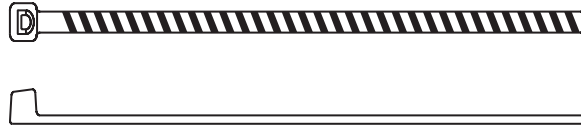

C2.
Surface
Raceway

| Part Number | Color | Length | | Width | | Thickness | | Max. Bundle Dia. | | Min. Loop Tensile Str. | | Std. Pkg. Qty. | Std. Ctn. Qty. |
|---|----------------------|--------|-----|-------|-----|-----------|----|------------------|----|------------------------|----|----------------|----------------|
| | | In. | mm | In. | mm | In. | mm | In. | mm | Lbs. | N | | |
| Miniature Cross Section (Straight Tip) | | | | | | | | | | | | | |
| PLT1M-L6-10 | Blue/White Stripe | 4.0 | 102 | .100 | 2.5 | .036 | .9 | .82 | 21 | 18 | 80 | 50 | 1000 |
| PLT1M-L3-10 | Orange/White Stripe | 4.0 | 102 | .100 | 2.5 | .036 | .9 | .82 | 21 | 18 | 80 | 50 | 1000 |
| PLT1M-L5-10 | Green/White Stripe | 4.0 | 102 | .100 | 2.5 | .036 | .9 | .82 | 21 | 18 | 80 | 50 | 1000 |
| PLT1M-L1-10 | Brown/White Stripe | 4.0 | 102 | .100 | 2.5 | .036 | .9 | .82 | 21 | 18 | 80 | 50 | 1000 |
| PLT1M-L8-10 | Slate/White Stripe | 4.0 | 102 | .100 | 2.5 | .036 | .9 | .82 | 21 | 18 | 80 | 50 | 1000 |
| PLT1M-L6-2 | Blue/Red Stripe | 4.0 | 102 | .100 | 2.5 | .036 | .9 | .82 | 21 | 18 | 80 | 50 | 1000 |
| PLT1M-L3-2 | Orange/Red Stripe | 4.0 | 102 | .100 | 2.5 | .036 | .9 | .82 | 21 | 18 | 80 | 50 | 1000 |
| PLT1M-L5-2 | Green/Red Stripe | 4.0 | 102 | .100 | 2.5 | .036 | .9 | .82 | 21 | 18 | 80 | 50 | 1000 |
| PLT1M-L1-2 | Brown/Red Stripe | 4.0 | 102 | .100 | 2.5 | .036 | .9 | .82 | 21 | 18 | 80 | 50 | 1000 |
| PLT1M-L8-2 | Slate/Red Stripe | 4.0 | 102 | .100 | 2.5 | .036 | .9 | .82 | 21 | 18 | 80 | 50 | 1000 |
| PLT1M-L6-0 | Blue/Black Stripe | 4.0 | 102 | .100 | 2.5 | .036 | .9 | .82 | 21 | 18 | 80 | 50 | 1000 |
| PLT1M-L3-0 | Orange/Black Stripe | 4.0 | 102 | .100 | 2.5 | .036 | .9 | .82 | 21 | 18 | 80 | 50 | 1000 |
| PLT1M-L5-0 | Green/Black Stripe | 4.0 | 102 | .100 | 2.5 | .036 | .9 | .82 | 21 | 18 | 80 | 50 | 1000 |
| PLT1M-L1-0 | Brown/Black Stripe | 4.0 | 102 | .100 | 2.5 | .036 | .9 | .82 | 21 | 18 | 80 | 50 | 1000 |
| PLT1M-L8-0 | Slate/Black Stripe | 4.0 | 102 | .100 | 2.5 | .036 | .9 | .82 | 21 | 18 | 80 | 50 | 1000 |
| PLT1M-L6-4 | Blue/Yellow Stripe | 4.0 | 102 | .100 | 2.5 | .036 | .9 | .82 | 21 | 18 | 80 | 50 | 1000 |
| PLT1M-L3-4 | Orange/Yellow Stripe | 4.0 | 102 | .100 | 2.5 | .036 | .9 | .82 | 21 | 18 | 80 | 50 | 1000 |
| PLT1M-L5-4 | Green/Yellow Stripe | 4.0 | 102 | .100 | 2.5 | .036 | .9 | .82 | 21 | 18 | 80 | 50 | 1000 |
| PLT1M-L1-4 | Brown/Yellow Stripe | 4.0 | 102 | .100 | 2.5 | .036 | .9 | .82 | 21 | 18 | 80 | 50 | 1000 |
| PLT1M-L8-4 | Slate/Yellow Stripe | 4.0 | 102 | .100 | 2.5 | .036 | .9 | .82 | 21 | 18 | 80 | 50 | 1000 |
| PLT1M-L6-7 | Blue/Violet Stripe | 4.0 | 102 | .100 | 2.5 | .036 | .9 | .82 | 21 | 18 | 80 | 50 | 1000 |
| PLT1M-L3-7 | Orange/Violet Stripe | 4.0 | 102 | .100 | 2.5 | .036 | .9 | .82 | 21 | 18 | 80 | 50 | 1000 |
| PLT1M-L5-7 | Green/Violet Stripe | 4.0 | 102 | .100 | 2.5 | .036 | .9 | .82 | 21 | 18 | 80 | 50 | 1000 |
| PLT1M-L1-7 | Brown/Violet Stripe | 4.0 | 102 | .100 | 2.5 | .036 | .9 | .82 | 21 | 18 | 80 | 50 | 1000 |
| PLT1M-L8-7 | Slate/Violet Stripe | 4.0 | 102 | .100 | 2.5 | .036 | .9 | .82 | 21 | 18 | 80 | 50 | 1000 |
| PLT1M-L0 | Black | 4.0 | 102 | .100 | 2.5 | .036 | .9 | .82 | 21 | 18 | 80 | 50 | 1000 |
| PLT1M-L1 | Brown | 4.0 | 102 | .100 | 2.5 | .036 | .9 | .82 | 21 | 18 | 80 | 50 | 1000 |
| PLT1M-L2 | Red | 4.0 | 102 | .100 | 2.5 | .036 | .9 | .82 | 21 | 18 | 80 | 50 | 1000 |
| PLT1M-L3 | Orange | 4.0 | 102 | .100 | 2.5 | .036 | .9 | .82 | 21 | 18 | 80 | 50 | 1000 |
| PLT1M-L4Y | Yellow | 4.0 | 102 | .100 | 2.5 | .036 | .9 | .82 | 21 | 18 | 80 | 50 | 1000 |
| PLT1M-L5 | Green | 4.0 | 102 | .100 | 2.5 | .036 | .9 | .82 | 21 | 18 | 80 | 50 | 1000 |
| PLT1M-L6 | Blue | 4.0 | 102 | .100 | 2.5 | .036 | .9 | .82 | 21 | 18 | 80 | 50 | 1000 |
| PLT1M-L8 | Slate | 4.0 | 102 | .100 | 2.5 | .036 | .9 | .82 | 21 | 18 | 80 | 50 | 1000 |

Note: CSA Certified on solid colors only.

F.
Index

Telephone Cable Identification Kits

- *PAN-POUCH™* Kit is made of two-ply laminated black nylon/vinyl and folds for easy storage
- Easily hang pouch from cable by using hook and loop fasteners
- Pocket pouch holds five (50-piece) packages and is made of a white vinyl



PPC25X50F



PP5X50F

| Part Number | Description | Dimensions | | Std. Pkg. Qty. |
|-------------|--|--------------------------------|--------------------------------|----------------|
| | | Open | Closed | |
| PPC25X50F | Pouch filled with 1,250 cable ties (50 each of all 24 striped ties and 50 solid red ties) | 10.5" x 38" (267mm x 965mm) | 10.5" x 6" (267mm x 152mm) | 1 |
| PPC25X50 | Empty pouch | 10.5" x 38" (267mm x 965mm) | 10.5" x 6" (267mm x 152mm) | 1 |
| PP5X50F | Pocket pouch filled with 250 cable ties (50 of each color: blue, orange, green, brown and slate – all with white stripe) | — | 3.5" x 5.25" (89mm x 133mm) | 1 |

Cable Tie Kits in Steel Boxes



K-205



K-504/SR2

| Part Number | Part Description | Std. Pkg. Qty. |
|-------------|--|----------------|
| K-205 | Kit for Indoor Use <i>PAN-TY®</i> Cable Ties, cable tie installation tool, terminals, splices and crimp tool: (1) GTS tool (1) CT-100 crimp tool <u>Natural Nylon 6.6 Cable Ties</u> (100) PLT1M (100) PLT1.5I (100) PLT2S <u>Terminals</u> (100) PV18-6LF (100) PV14-8LF (100) PV14-10LF (50) PV10-10LF <u>Splices</u> (50) BSV10X (100) BSV14X (100) BSV18X | 1 |
| K-504 | Kit for Indoor Use <i>PAN-TY®</i> Cable Ties, cable tie installation tool, and mounts: (1) STS2 tool <u>Natural Nylon 6.6 Cable Ties</u> (100) PLT1M (100) PLT1.5I (100) PLT2S (100) PLC2S-S10 <u>Mounts</u> (100) TM2S8 (100) ABM2S-A | 1 |
| SR2 | Two-drawer slide rack to hold K-504 cable tie kit or K-1000 series terminal kit. Dimensions: 6.25"H x 15.25"W x 11.75"D (158.7mm x 387.4mm x 298.5mm) | 1 |

A.
System
Overview

B1.
Cable Ties

B2.
Cable
Accessories

B3.
Stainless
Steel Ties

C1.
Wiring
Duct

C2.
Surface
Raceway

C3.
Abrasion
Protection

C4.
Cable
Management

D1.
Terminals

D2.
Power
Connectors

D3.
Grounding
Connectors

E1.
Labeling
Systems

E2.
Labels

E3.
Pre-Printed
& Write-On
Markers

E4.
Permanent
Identification

E5.
Lockout/
Tagout
& Safety
Solutions

F.
Index

A.
System
Overview

Cable Tie Kits in Plastic Boxes and Bags

B1.
Cable Ties



KP-506A

B2.
Cable
Accessories



KP-506A-0

B3.
Stainless
Steel Ties

C1.
Wiring
Duct

C2.
Surface
Raceway

C3.
Abrasion
Protection



KP-509

C4.
Cable
Management

D1.
Terminals



KB-550

D2.
Power
Connectors

D3.
Grounding
Connectors

E1.
Labeling
Systems



KB-551

E2.
Labels

E3.
Pre-Printed
& Write-On
Markers

E4.
Permanent
Identification

E5.
Lockout/
Tagout/
& Safety
Solutions

F.
Index

| Part Number | Part Description | Std. Pkg. Qty. |
|------------------|--|----------------|
| KP-506A | Kit for Indoor Use <i>PAN-TY</i> ® Cable Ties and Mounts: <u>Natural Nylon 6.6</u> (100) PLT1M (100) PLT1.5I (100) PLT2S (50) ABM2S-A mounts | 1 |
| KP-506A-0 | Kit for Outdoor Use <i>PAN-TY</i> ® Cable Ties and Mounts: <u>Black Weather Resistant Nylon 6.6</u> (100) PLT1M-0 (100) PLT1.5I-0 (100) PLT2S-0 (50) ABM2S-AT-0 mounts | 1 |
| KP-509 | Kit for Indoor Use For prototyping and new product development – contains over 600 pcs. <i>PAN-TY</i> ® Cable Ties in different styles, sizes, and colors. Huge assortment of cable tie mounts and wiring accessories. | 1 |
| KB-550 | Assortment Pack for Indoor and Outdoor Use <i>PAN-TY</i> ® Cable Ties: <u>Natural Nylon 6.6</u> (15) PLT1M (15) PLT1.5I (15) PLT2S (15) PLT3S <u>Black Weather Resistant Nylon 6.6</u> (10) PLT1M-0 (10) PLT1.5I-0 (10) PLT2S-0 (10) PLT3S-0 | 1 |
| KB-551 | Assortment Pack for Indoor and Outdoor Use <i>DOME-TOP</i> ® Barb Ty Cable Ties: <u>Natural Nylon 6.6</u> (15) BT1M (15) BT1.5I (15) BT2S (15) BT3S <u>Black Weather Resistant Nylon 6.6</u> (10) BT1M-0 (10) BT1.5I-0 (10) BT2S-0 (10) BT3S-0 | 1 |

Features and Benefits – Hook and Loop Cable Ties

The comprehensive family of hook and loop cable ties delivers reliability by protecting against over-tensioning of high performance fiber and copper cables. These ties are adjustable, releasable, and re-usable to effectively support frequent moves, adds, and changes (MACs). A wide range of colors provides flexibility and an aesthetically pleasing appearance. The complete line of *PANDUIT* Hook and Loop Cable Ties help maintain the reliable, scalable, and aesthetic requirements of data centers.

TAK-TY® Hook & Loop Cable Ties – Premium, durable designs and sizes

Loop Style



Allows for pre-wrapping of bundles

Roll/Strip Style



Available in continuous or perforated rolls

Plenum-Rated



Distinctive maroon color (also available in black)

TAK-TAPE™ Hook & Loop Rolls



Strong, low profile hook and loop material

Convenient packaging



ULTRA-CINCH™ Hook & Loop Cable Ties



Unique same-sided material secures a greater range of bundle diameters

Available in three styles and eight colors; grommet styles used for bundle mounting applications

Low profile contoured cinch ring reduces overall bundle size



Wire management accessories speed and simplify the mounting of high performance cabling.

See pages B2.2, B2.3, B2.10, B2.20, B2.21, B2.24, C4.8 and C4.11

A.
System
Overview

B1.
Cable
Ties

B2.
Cable
Accessories

B3.
Stainless
Steel
Ties

C1.
Wiring
Duct

C2.
Surface
Raceway

C3.
Abrasion
Protection

C4.
Cable
Management

D1.
Terminals

D2.
Power
Connectors

D3.
Grounding
Connectors

E1.
Labeling
Systems

E2.
Labels

E3.
Pre-Printed
& Write-On
Markers

E4.
Permanent
Identification

E5.
Lockout/
Tagout
& Safety
Solutions

F.
Index

A.
System
Overview

Selection Guide – Hook and Loop Cable Ties

B1.
Cable Ties



B2.
Cable
Accessories

B3.
Stainless
Steel Ties

C1.
Wiring
Duct

| Product, Color (Suffix) | Style/Function | Part Number Prefix | Catalog Page |
|-------------------------|----------------|--------------------|--------------|
|-------------------------|----------------|--------------------|--------------|

C2.
Surface
Raceway

| | | | |
|-------------------------|-----------------------------|----------|-------|
| TAK-TY® Ties, Black (0) | Loop Ties/Re-usable | HLT | B1.87 |
| | Strip Ties/Re-usable | HLS | B1.87 |
| | 15' and 75' Rolls/Re-usable | HLM, HLS | B1.87 |

C3.
Abrasion
Protection

| | | | |
|---|----------------------|------|-------|
| TAK-TY® Plenum-Rated Ties, UL Listed Black, Maroon (0, 12) | Loop Ties/Re-usable | HLTP | B1.88 |
| | Strip Ties/Re-usable | HLSP | B1.88 |

C4.
Cable
Management

| | | | |
|----------------------------|-----------------------------|-----|-------|
| TAK-TAPE™ Rolls, Black (0) | 20' and 35' Rolls/Re-usable | TTS | B1.88 |
|----------------------------|-----------------------------|-----|-------|

D1.
Terminals

| | | | |
|------------------------------|--|-------|-------|
| ULTRA-CINCH™ Ties, Black (0) | Cinch Ties/Re-usable | UCT | B1.89 |
| | Cinch Ties – Center Mount Grommet/Re-usable | UGCTC | B1.89 |
| | Cinch Ties – End Mount Grommet/Re-usable | UGCTE | B1.89 |

D2.
Power
Connectors

D3.
Grounding
Connectors

E1.
Labeling
Systems

Part Number System for Hook and Loop Ties

E2.
Labels

HLT

2

I

–

X

0

E3.
Pre-Printed
& Write-On
Markers

Type

Size

Cross Section

Package Size

Color

E4.
Permanent
Identification

| | | | | | |
|-------|--|------------|------------------|-----------------------|-------------------|
| HL | = Hook and Loop | Approx. | I = Intermediate | X = 10 | See page B1.90 |
| HLM | = HL Miniature | Maximum | S = Standard | 15R = 15' Roll | |
| HLT | = HL Loop Tie | Bundle | | 20R = 20' Roll | |
| HLTP | = HL Loop Tie Plenum-Rated | Dia. (In.) | | 35R3 = 35' Rolls (3) | |
| HLS | = HL Strip Tie | | | 35RX = 35' Rolls (10) | |
| HLSP | = HL Strip Tie Plenum-Rated | | | 75R = 75' Roll | |
| TTS | = TAK-TAPE™ Roll | | | | |
| UCT | = ULTRA-CINCH™ Tie | | | | |
| UGCTC | = UCT Grommet Cinch Tie – Center Mount | | | | |
| UGCTE | = UCT Grommet Cinch Tie – End Mount | | | | |

E5.
Lockout/
Tagout/
& Safety
Solutions

F.
Index

TAK-TY® Hook & Loop Cable Ties

- Soft, premium material is safe to use on high performance cabling protecting against over-tensioning
- Broadest selection of durable designs and sizes to meet your application needs
- Adjustable, releasable, and re-usable multiple times – ideal for applications requiring frequent moves, adds, or changes

- A full range of colors
- Operating temperature range: 0°F to 220°F (-18°C to 104°C)
- Complementary mounts available, see page B2.10

Note: Minimum 2" overlap required to achieve loop tensile rating.



HLT (Loop Ties)



HLS (Strip Ties)



HLM/HLS (Rolls)



| Part Number | Length | | Width | | Max. Bundle Dia. | | Min. Loop Tensile Str. | | Std. Pkg. Qty. | Std. Ctn. Qty. |
|--|--------|-----|-------|------|------------------|----|------------------------|-----|----------------|----------------|
| | In. | mm | In. | mm | In. | mm | Lbs. | N | | |
| Loop Ties – Slot allows for pre-wrapping of bundles | | | | | | | | | | |
| HLT2I-X0 | 8.0 | 203 | .500 | 12.7 | 1.91 | 49 | 40 | 178 | 10 | 100 |
| HLT3I-X0 | 12.0 | 305 | .500 | 12.7 | 3.18 | 81 | 40 | 178 | 10 | 100 |

| | | | | | | | | | | |
|--|------|-----|------|------|------|-----|----|-----|----|-----|
| Strip Ties – Perforated in convenient 6", 12", and 18" strips | | | | | | | | | | |
| HLS1.5S-X0 | 6.0 | 152 | .750 | 19.1 | 1.50 | 38 | 50 | 222 | 10 | 100 |
| HLS3S-X0 | 12.0 | 305 | .750 | 19.1 | 3.20 | 81 | 50 | 222 | 10 | 100 |
| HLS5S-X0 | 18.0 | 457 | .750 | 19.1 | 5.00 | 127 | 50 | 222 | 10 | 100 |

| Part Number | Length | | Width | | Max. Bundle Dia. | | Min. Loop Tensile Str. | | Std. Pkg. Qty. | Std. Ctn. Qty. |
|---|--------|------|-------|------|------------------|---------|------------------------|-----|----------------|----------------|
| | Ft. | m | In. | mm | In. | mm | Lbs. | N | | |
| 15' and 75' Continuous Rolls – Can be cut to desired length, eliminating waste | | | | | | | | | | |
| HLM-15R0 | 15.0 | 4.6 | .330 | 8.4 | Various | Various | 18 | 80 | 1 | 10 |
| HLS-15R0 | 15.0 | 4.6 | .750 | 19.1 | Various | Various | 50 | 222 | 1 | 10 |
| HLS-75R0 | 75.0 | 22.9 | .750 | 19.1 | Various | Various | 50 | 222 | 1 | 10 |

| | | | | | | | | | | |
|-----------------|------|------|------|------|---------|---------|----|-----|---|----|
| HLM-15R0 | 15.0 | 4.6 | .330 | 8.4 | Various | Various | 18 | 80 | 1 | 10 |
| HLS-15R0 | 15.0 | 4.6 | .750 | 19.1 | Various | Various | 50 | 222 | 1 | 10 |
| HLS-75R0 | 75.0 | 22.9 | .750 | 19.1 | Various | Various | 50 | 222 | 1 | 10 |

A. System Overview

B1. Cable Ties

B2. Cable Accessories

B3. Stainless Steel Ties

C1. Wiring Duct

C2. Surface Raceway

C3. Abrasion Protection

C4. Cable Management

D1. Terminals

D2. Power Connectors

D3. Grounding Connectors

E1. Labeling Systems

E2. Labels

E3. Pre-Printed & Write-On Markers

E4. Permanent Identification

E5. Lockout/Tagout & Safety Solutions

F. Index

A. System Overview



TAK-TY® Hook & Loop Cable Ties – Plenum-Rated

- Soft, premium material is safe to use on high performance cabling protecting against over-tensioning
- UL Listed for use in plenum or air handling spaces (such as ceiling voids and underfloor areas) per NEC, Section 300-22 (C) and (D)
- Flammability rating: UL 94V-2

- Adjustable, releasable, and re-usable multiple times – ideal for applications requiring frequent moves, adds, or changes
- Operating temperature range: 0°F to 122°F (-18°C to 50°C)

Note: Minimum 2" overlap required to achieve loop tensile rating.

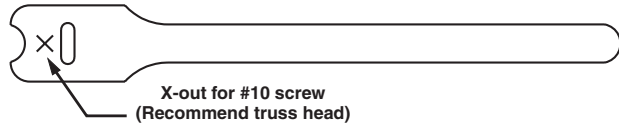

B1. Cable Ties

B2. Cable Accessories

B3. Stainless Steel Ties

C1. Wiring Duct

C2. Surface Raceway

C3. Abrasion Protection

C4. Cable Management

D1. Terminals

D2. Power Connectors

D3. Grounding Connectors

E1. Labeling Systems

E2. Labels

E3. Pre-Printed & Write-On Markers

E4. Permanent Identification

E5. Lockout/Tagout & Safety Solutions

F. Index

| Part Number | Length | | Width | | Max. Bundle Dia. | | Min. Loop Tensile Str. | | Std. Pkg. Qty. | Std. Ctn. Qty. |
|---|--------|-----|-------|------|------------------|-----|------------------------|-----|----------------|----------------|
| | In. | mm | In. | mm | In. | mm | Lbs. | N | | |
| UL Listed Loop Ties (Maroon) – Slot allows for pre-wrapping of bundles | | | | | | | | | | |
| HLTP2I-X12 | 8.0 | 203 | .500 | 12.7 | 1.91 | 49 | 40 | 178 | 10 | 100 |
| HLTP3I-X12 | 12.0 | 305 | .500 | 12.7 | 3.18 | 81 | 40 | 178 | 10 | 100 |
| UL Listed Loop Ties (Black) – Slot allows for pre-wrapping of bundles | | | | | | | | | | |
| HLTP2I-X0 | 8.0 | 203 | .500 | 12.7 | 1.91 | 49 | 18 | 80 | 10 | 100 |
| HLTP3I-X0 | 12.0 | 305 | .500 | 12.7 | 3.18 | 81 | 18 | 80 | 10 | 100 |
| UL Listed Strip Ties (Maroon) – Perforated in convenient 6", 12", and 18" strips | | | | | | | | | | |
| HLSP1.5S-X12 | 6.0 | 152 | .750 | 19.1 | 1.50 | 38 | 50 | 222 | 10 | 100 |
| HLSP3S-X12 | 12.0 | 305 | .750 | 19.1 | 3.20 | 81 | 50 | 222 | 10 | 100 |
| HLSP5S-X12 | 18.0 | 457 | .750 | 19.1 | 5.00 | 127 | 50 | 222 | 10 | 100 |
| UL Listed Strip Ties (Black) – Perforated in convenient 6", 12", and 18" strips | | | | | | | | | | |
| HLSP1.5S-X0 | 6.0 | 152 | .750 | 19.1 | 1.50 | 38 | 18 | 80 | 10 | 100 |
| HLSP3S-X0 | 12.0 | 305 | .750 | 19.1 | 3.20 | 81 | 18 | 80 | 10 | 100 |
| HLSP5S-X0 | 18.0 | 457 | .750 | 19.1 | 5.00 | 127 | 18 | 80 | 10 | 100 |

TAK-TAPE™ Hook & Loop Cable Tie Rolls

- Strong, low profile, flexible material is safe to use on high performance cabling protecting against over-tensioning
- Adjustable, releasable, and re-usable
- Cost-effective for general purpose bundling
- Continuous rolls can be easily cut to size – PANDUIT cutter included with TTS-35RX0
- Handy, re-usable plastic case with TTS-20R0, keeps material clean

- Leaves no residue
- Available in black color
- Operating temperature range: -22°F to 194°F (-30°C to 90°C)
- Complementary mounts available, see page B2.10

Note: Minimum 2" overlap required to achieve loop tensile rating.



| Part Number | Length | | Width | | Max. Bundle Dia. | | Min. Loop Tensile Str. | | Std. Pkg. Qty. | Std. Ctn. Qty. |
|-------------|--------|------|-------|------|------------------|---------|------------------------|-----|----------------|----------------|
| | Ft. | m | In. | mm | In. | mm | Lbs. | N | | |
| TTS-20R0 | 20.0 | 6.1 | .750 | 19.1 | Various | Various | 40 | 178 | 1 | 10 |
| TTS-35R3-0 | 35.0 | 10.7 | .750 | 19.1 | Various | Various | 40 | 178 | 1 | 8 |
| TTS-35RX0 | 35.0 | 10.7 | .750 | 19.1 | Various | Various | 40 | 178 | 1 | 10 |

Std. Pkg. Qty. of TTS-35R3-0 denotes 1 package of three 35' rolls, TTS-35RX0 denotes 1 package of ten 35' rolls.

ULTRA-CINCH™ Hook & Loop Cable Ties

- Unique material with hooks and loops on same side allows user to secure a greater range of bundle diameters, including smaller bundles
- Soft, premium material is safe to use on high performance cabling, protecting against over-tensioning
- Adjustable, releasable, and re-usable multiple times – ideal for applications requiring frequent moves, adds, or changes
- Low profile contoured cinch ring provides extra strength and bundle tightness while reducing overall bundle size
- Grommet (UGCTC and UGCTE styles) offers strength and assures reliable installations that resist pullout when bundling and mounting cables within cabinet applications
- Tapered tip facilitates easy, snag-free threading to speed installation
- Use flat-head screws for grommet applications shown below

Note: Minimum 2" overlap required to achieve loop tensile rating.

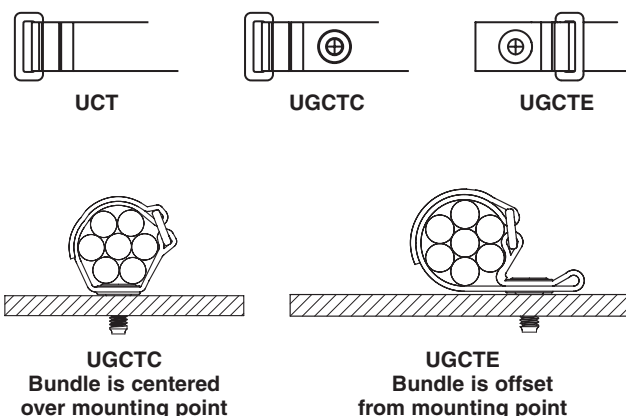

| Part Number | Length | | Width | | Max. Bundle Dia. | | Min. Loop Tensile Str. | | Std. Pkg. Qty. | Std. Ctn. Qty. |
|---|--------|-----|-------|------|------------------|-----|------------------------|-----|----------------|----------------|
| | In. | mm | In. | mm | In. | mm | Lbs. | N | | |
| Cinch Ties | | | | | | | | | | |
| UCT3S-X0 | 12.0 | 305 | .850 | 21.6 | 3.00 | 76 | 50 | 222 | 10 | 100 |
| UCT5S-X0 | 18.0 | 457 | .850 | 21.6 | 5.00 | 127 | 50 | 222 | 10 | 100 |
| Cinch Ties – Center Mount Grommet (Bundle is centered over mounting point) | | | | | | | | | | |
| UGCTC3S-X0 | 12.0 | 305 | .850 | 21.6 | 3.00 | 76 | 50 | 222 | 10 | 100 |
| UGCTC5S-X0 | 18.0 | 457 | .850 | 21.6 | 5.00 | 127 | 50 | 222 | 10 | 100 |
| Cinch Ties – End Mount Grommet (Bundle is offset from mounting point) | | | | | | | | | | |
| UGCTE3S-X0 | 12.0 | 305 | .850 | 21.6 | 3.00 | 76 | 50 | 222 | 10 | 100 |
| UGCTE5S-X0 | 18.7 | 475 | .850 | 21.6 | 5.00 | 127 | 50 | 222 | 10 | 100 |

Note: 1/4" (6mm) diameter mounting hole on grommet style cinch ties.

Flat Head Screws for Grommet Cinch Ties

| Part Number | Part Description | Std. Pkg. Qty. | Std. Ctn. Qty. |
|-------------|--|----------------|----------------|
| UCTGS1224-X | 12-24 UNC x 5/8mm (.625") flat head phillips screw | 10 | 100 |
| UCTGSM5-X | M5 x 16mm flat head phillips screw | 10 | 100 |
| UCTGSM6-X | M6 x 16mm flat head phillips screw | 10 | 100 |

A. System Overview

B1. Cable Ties

B2. Cable Accessories

B3. Stainless Steel Ties

C1. Wiring Duct

C2. Surface Raceway

C3. Abrasion Protection

C4. Cable Management

D1. Terminals

D2. Power Connectors

D3. Grounding Connectors

E1. Labeling Systems

E2. Labels

E3. Pre-Printed & Write-On Markers

E4. Permanent Identification

E5. Lockout/Tagout & Safety Solutions

F. Index

A.
System
Overview

Hook and Loop Cable Ties

B1.
Cable Ties

Color Chart

| Color | PANDUIT Suffix | Color | PANDUIT Suffix |
|--------|----------------|--------|----------------|
| Black | 0 | Blue | 6 |
| Red | 2 | Gray | 8 |
| Orange | 3 | White | 10 |
| Yellow | 4 | Maroon | 12 |
| Green | 5 | | |

C1.
Wiring
Duct

C2.
Surface
Raceway

Part Number Availability List

C3.
Abrasion
Protection

| Standard Packaging | |
|--------------------|------------------|
| Part Number | Color |
| HLM-15R | 0,2,3,4,5,6,8,10 |
| HLS-15R | 0,2,3,4,5,6,8,10 |
| HLS-75R | 0,2,3,4,5,6,8,10 |
| HLS1.5S-X | 0,2,3,4,5,6,8,10 |
| HLS3S-X | 0,2,3,4,5,6,8,10 |
| HLS5S-X | 0,2,3,4,5,6,8,10 |
| HLSP1.5S-X | 0,12 |
| HLSP3S-X | 0,12 |
| HLSP5S-X | 0,12 |
| HLT2I-X | 0,2,3,4,5,6,8,10 |
| HLT3I-X | 0,2,3,4,5,6,8,10 |
| HLTP2I-X | 0,12 |
| HLTP3I-X | 0,12 |
| TTS-20R | 0 |
| TTS-35RX | 0 |
| TTS-35R3 | 0 |
| UCT3S-X | 0,2,3,4,5,6,8,10 |
| UCT5S-X | 0,2,3,4,5,6,8,10 |
| UGCTC3S-X | 0,2,3,4,5,6,8,10 |
| UGCTC5S-X | 0,2,3,4,5,6,8,10 |
| UGCTE3S-X | 0,2,3,4,5,6,8,10 |
| UGCTE5S-X | 0,2,3,4,5,6,8,10 |

C4.
Cable
Management

D1.
Terminals

D2.
Power
Connectors

D3.
Grounding
Connectors

E1.
Labeling
Systems

E2.
Labels

E3.
Pre-Printed
& Write-On
Markers

E4.
Permanent
Identification

E5.
Lockout/
Tagout/
& Safety
Solutions

F.
Index

Hot Stamping Service Custom Printed Cable Ties

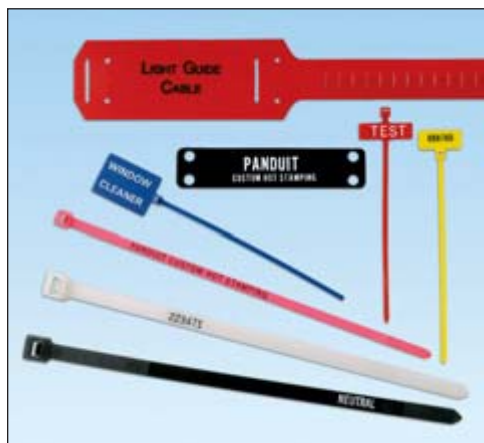

Custom Hot Stamping Service provides a permanent, high quality imprinted message on *PANDUIT* cable ties and marker plates. Graphics, text, numbers and colors provide a variety of choices for customization.

Hot stamped cable ties and marker plates are typically used for identification, or for labeling critical components. *PANDUIT* cable ties, marker ties, marker plates and marker straps are available to suit your application.

Your choice of:

- Seven text colors (black, blue, green, red, yellow, orange, white)
- A variety of characters and fonts
- Sequential numbering
- Special customer logos and diagrams

FAST! TWO WEEK LEAD TIME

Minimum Order: (Pieces/part number and message)

- 5,000 for Miniature, Intermediate, Standard and Heavy-Standard cross section cable ties
- 3,000 for Light-Heavy, Heavy, and Extra-Heavy cross section cable ties

For hot stamping orders and inquiries, please call 1-800-777-3300

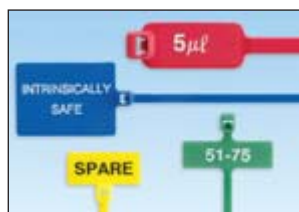

Cable Ties

- Used wherever you need to bundle wire, cable, hose or tubing
- A variety of colors for color-coding applications
- Cross Sections: Intermediate, Standard, Heavy-Standard, Light-Heavy, Heavy and Extra-Heavy

Marker and Flag Ties

- Fasten and identify bundles at the same time
- A variety of colors for color-coding applications
- Cross Sections: Miniature and Standard

Marker Plates

- Mount in any direction, either vertically or horizontally as flags, tags, or wrap-around identification plates.
- White or Weather Resistant black color
- Marker plate sizes:

| | |
|--------------|---------------|
| 1.50" x .75" | 2.50" x .75" |
| 1.75" x .75" | 3.50" x .75" |
| 2.00" x .75" | 2.50" x 1.75" |

Cable Marker Straps

- Identify and code telephone and fiber optic cable – replaces costly and cumbersome lead marking tags
- Lightweight and easy to install
- Can be used as **wrap-around** or **flag** marker
- Also can be used in underground identification applications
- Polyethylene material available in red and gray
- Marking area: 1.50" x 2.62"

A.
System
Overview

B1.
Cable Ties

B2.
Cable
Accessories

B3.
Stainless
Steel Ties

C1.
Wiring
Duct

C2.
Surface
Raceway

C3.
Abrasion
Protection

C4.
Cable
Management

D1.
Terminals

D2.
Power
Connectors

D3.
Grounding
Connectors

E1.
Labeling
Systems

E2.
Labels

E3.
Pre-Printed
& Write-On
Markers

E4.
Permanent
Identification

E5.
Lockout/
Tagout
& Safety
Solutions

F.
Index



PANDUIT Cable Tie Approvals

| | Logo (Symbol) | Agency | Spec/Approval | Requirement | Applicable Products |
|---------------------------------------|---------------|-------------------------------------|---|---|--|
| A. System Overview | | | | | |
| B1. Cable Ties | | | | | |
| B2. Cable Accessories | | Underwriters Laboratories, Inc. | File E56854 and MH29590 | ZODZ(7), ZODZ(8), ALKW | Most miniature, intermediate, standard, light-heavy and heavy cross section ties are Recognized or Listed in the US and Canada |
| B3. Stainless Steel Ties | | Canadian Standards Association | File 031212 | C22.2 No. 18.5-02 under the category "Fittings – Positioning Devices" | Most miniature, intermediate, standard, light-heavy and heavy cross section ties are Recognized or Listed in the US and Canada |
| C1. Wiring Duct | | Conformity European | Low Voltage Directive 73/23/EEC (amended 93/68/EEC). <i>PAN-TY</i> ® and <i>DOME-TOP</i> ® Barb Ty Cable Ties also meet the requirements from EN50146 | CE Marking is required for products sold within the European Union. CE Marking Directives specify the minimum performance of these products. Applying the CE mark signifies compliance with essential requirements of specific directives. | All cable tie products |
| C2. Surface Raceway | | | | | |
| C3. Abrasion Protection | | ABS (American Bureau of Shipping) | 05-HS463235-PDA | 2005 Vessel Rules 1-1-4/7.7, 4-8/421.9.3 2001 MODU Rules 4-3-3/5.9.1 | PLT Series, BT Series |
| C4. Cable Management | | Bureau Veritas | Cert 05968/C0 BV 1178B/BVN/04 File ACE 14/601/01 | Bureau Veritas Rules for the Classification of Steel Ships | PLT Series, BT Series, PRT Series, CBR Series |
| D1. Terminals | | Det Norske Veritas | E-6405 | Det Norske Veritas' Rules for Classification of Ships and Mobile Offshore Units | PLT Series, PLC Series, PLM Series, PRT Series, PLWP Series, PRWP Series, PRST Series |
| D2. Power Connectors | | Germanischer Lloyd | 30562-83HH, 32666-83HH, 51796-89HH, 98731-96HH | Germanischer Lloyd Approval | PLT Series, BT Series |
| D3. Grounding Connectors | | Germany (VG) Military | K17/96066 | VG 95 387 – 100 MS 3367F | PLT Series, BT Series, SST Series |
| E1. Labeling Systems | | Korean Register of Shipping | NYK06431-EL001, EL002, EL003 | Type Approval for the Rules for Classification of Steel Ships | PLT Series, BT Series, Mounts |
| E2. Labels | | Lloyd's Register of Shipping | 89/60111 (E1) | Lloyd's Register Type Approval | PLT Series, BT Series, SST Series |
| E3. Pre-Printed & Write-On Markers | | NRC (Nuclear Regulatory Commission) | NRC 10CFR50 | Quality Assurance Criteria for Nuclear Plants and Reprocessing Plants | All cable tie products |
| E4. Permanent Identification | | Nippon Kaiji Kyokai | 85VZ004B, 85BZ005B, 85VZ006B | Nippon Kaiji Kyokai Type Approval | PLT2H-12H, PLT2EH-12EH, PRT2EH-12EH, SST2H-8H |
| E5. Lockout/Tagout & Safety Solutions | | Plenum-Rated | <i>PANDUIT</i> logo | <i>PANDUIT</i> symbol indicates that the cable ties represented are suitable for use in plenum or air handling spaces in accordance with Sec. 300.22 (C) and (D) of the National Electrical Code and Rules 12-010 (3), (4), and (5) and 12-020 of the Canadian Electrical Code, Part I. | HALAR [▲] (702Y), Hook and Loop Cable Ties (HLSP/HLTP), and select Nylon 6.6 cable ties as noted throughout catalog ▲HALAR is a registered trademark of Solvay Solexis, Inc. |
| F. Index | | US Military Aerospace Standard | QPL-AS23190-2 | SAE spec AS23190 | See Military Cross Reference Page B1.93 |
| | | AQA International | ISO/TS16949 | AQA registration. Quality management system assessment certificate | Tinley Park, Illinois Manufacturing Operations (Cable Tie Division) Quality Management System |

Military Cross Reference

The PANDUIT cable ties and marker ties listed in the following tables meet all of the testing requirements of Aerospace Standard SAE-AS23190A (formerly MIL-S-23190E) and the dimensional requirements of Aerospace Standards SAE-AS33671 (formerly MS3367) and SAE-AS33681 (formerly MS3368).

| Cable Tie Cross Reference | | | | | | |
|---------------------------|---------|-------------------------|-------------------|-------------|------------------|-------------|
| Mil. Std. Part Number | Color | PAN-TY® | DOME-TOP® Barb Ty | STA-STRAP® | BELT-TY™ In-Line | CONTOUR-TY® |
| MS3367-1-0 | Black* | PLT2S-C00, -M00 | — | — | — | — |
| MS3367-1-1 | Brown | PLT2S-C1, -M1 | BT2S-M1 | — | — | — |
| MS3367-1-2 | Red | PLT2S-C2, -M2 | BT2S-M2 | — | — | — |
| MS3367-1-3 | Orange | PLT2S-C3, -M3 | BT2S-M3 | — | — | — |
| MS3367-1-4 | Yellow | PLT2S-C4Y, -M4Y | BT2S-M4Y | — | — | — |
| MS3367-1-5 | Green | PLT2S-C5, -M5 | BT2S-M5 | — | — | — |
| MS3367-1-6 | Blue | PLT2S-C6, -M6 | BT2S-M6 | — | — | — |
| MS3367-1-7 | Purple | PLT2S-C7, -M7 | BT2S-M7 | — | — | — |
| MS3367-1-8 | Gray | PLT2S-C8, -M8 | BT2S-M8 | — | — | — |
| MS3367-1-9 | Natural | PLT2S-C, -M, -VMR | BT2S-C, -M | SST2S-C, -M | — | — |
| MS3367-2-0 | Black* | PLT4S-C00, -M00 | — | — | — | — |
| MS3367-2-1 | Brown | PLT4S-M1 | — | — | — | — |
| MS3367-2-2 | Red | PLT4S-C2, -M2 | BT4S-M2 | SST4S-M2 | — | — |
| MS3367-2-3 | Orange | PLT4S-C3, -M3 | BT4S-M3 | — | — | — |
| MS3367-2-4 | Yellow | PLT4S-C4Y, -M4Y | BT4S-M4Y | — | — | — |
| MS3367-2-5 | Green | PLT4S-C5, -M5 | BT4S-M5 | — | — | — |
| MS3367-2-6 | Blue | PLT4S-C6, -M6 | BT4S-M6 | — | — | — |
| MS3367-2-7 | Purple | PLT4S-C7, -M7 | BT4S-M7 | — | — | — |
| MS3367-2-8 | Gray | PLT4S-C8, -M8 | BT4S-M8 | — | — | — |
| MS3367-2-9 | Natural | PLT4S-C, -M | BT4S-C, -M | SST4S-C, -M | — | — |
| MS3367-3-0 | Black* | PLT4H-L00, -TL00 | — | — | — | — |
| MS3367-3-1 | Brown | PLT4H-TL1 | — | — | — | — |
| MS3367-3-2 | Red | PLT4H-TL2 | — | — | — | — |
| MS3367-3-3 | Orange | PLT4H-TL3 | — | — | — | — |
| MS3367-3-4 | Yellow | PLT4H-TL4Y | — | — | — | — |
| MS3367-3-5 | Green | PLT4H-TL5 | — | — | — | — |
| MS3367-3-6 | Blue | PLT4H-TL6 | — | — | — | — |
| MS3367-3-9 | Natural | PLT4H-L, -C, -TL | BT4LH-L, -TL | SST4H-L, -D | — | — |
| MS3367-4-0 | Black* | PLT1M-C00, -M00, -XMR00 | — | — | — | — |
| MS3367-4-0 | Black* | PLT1.5M-XMR00 | — | — | — | — |
| MS3367-4-1 | Brown | PLT1M-C1, -M1, -XMR1 | BT1M-M1 | — | — | — |
| MS3367-4-2 | Red | PLT1M-C2, -M2, -XMR2 | BT1M-M2 | — | — | — |
| MS3367-4-3 | Orange | PLT1M-C3, -M3, -XMR3 | BT1M-M3 | — | — | — |
| MS3367-4-4 | Yellow | PLT1M-C4Y, -M4Y, -XMR4Y | BT1M-M4Y | — | — | — |
| MS3367-4-5 | Green | PLT1M-C5, -M5, -XMR5 | BT1M-M5 | — | — | — |
| MS3367-4-6 | Blue | PLT1M-C6, -M6, -XMR6 | BT1M-M6 | — | — | — |
| MS3367-4-7 | Purple | PLT1M-C7, -M7, -XMR7 | BT1M-M7 | — | — | — |
| MS3367-4-8 | Gray | PLT1M-C8, -M8, -XMR8 | BT1M-M8 | — | — | — |
| MS3367-4-9 | Natural | PLT1M-C, -M, -XMR | BT1M-C, -M, -XMR | SST1M-C, -M | — | — |
| MS3367-4-9 | Natural | PLT.7M-C, -M | — | — | — | — |
| MS3367-4-9 | Natural | PLT1.5M-XMR | BT1.5M-XMR | — | — | — |
| MS3367-5-0 | Black* | PLT1.5I-M00 | — | — | — | — |
| MS3367-5-1 | Brown | PLT1.5I-C1, -M1 | BT1.5I-M1 | — | — | — |
| MS3367-5-2 | Red | PLT1.5I-C2, -M2 | BT1.5I-M2 | — | — | — |
| MS3367-5-3 | Orange | PLT1.5I-C3, -M3 | BT1.5I-M3 | — | — | — |
| MS3367-5-4 | Yellow | PLT1.5I-C4Y, -M4Y | BT1.5I-M4Y | — | — | — |

*Weather resistant per ASTM D 4066-94B.

Table continues on page B1.94

A.
System
Overview

Military Cross Reference (continued)

B1.
Cable Ties

B2.
Cable
Accessories

B3.
Stainless
Steel Ties

C1.
Wiring
Duct

C2.
Surface
Raceway

C3.
Abrasion
Protection

C4.
Cable
Management

D1.
Terminals

D2.
Power
Connectors

D3.
Grounding
Connectors

E1.
Labeling
Systems

E2.
Labels

E3.
Pre-Printed
& Write-On
Markers

E4.
Permanent
Identification

E5.
Lockout/
Tagout/
& Safety
Solutions

F.
Index

Cable Tie Cross Reference

| Mil. Std. Part Number | Color | PAN-TY® | DOME-TOP® Barb Ty | STA-STRAP® | BELT-TY™ In-Line | CONTOUR-TY® |
|-----------------------|---------|-----------------|-------------------|---------------|------------------|-------------|
| MS3367-5-5 | Green | PLT1.5I-C5, -M5 | BT1.5I-M5 | — | — | — |
| MS3367-5-6 | Blue | PLT1.5I-C6, -M6 | BT1.5I-M6 | — | — | — |
| MS3367-5-7 | Purple | PLT1.5I-C7, -M7 | BT1.5I-M7 | — | — | — |
| MS3367-5-8 | Gray | PLT1.5I-C8, -M8 | BT1.5I-M8 | — | — | — |
| MS3367-5-9 | Natural | PLT1.5I-C, -M | BT1.5I-C, -M | SST1.5I-C, -M | — | — |
| MS3367-6-9 | Natural | PLT8LH-L, -C | BT8LH-L, -C | SST8H-L, -D | — | — |
| MS3367-6-9 | Natural | — | BT9LH-L, -C | — | — | — |
| MS3367-7-0 | Black* | PLT3S-C00, -M00 | — | — | — | — |
| MS3367-7-1 | Brown | PLT3S-M1 | — | — | — | — |
| MS3367-7-2 | Red | PLT3S-C2, -M2 | BT3S-C2 | — | — | — |
| MS3367-7-3 | Orange | PLT3S-M3 | — | — | — | — |
| MS3367-7-4 | Yellow | PLT3S-M4Y | — | — | — | — |
| MS3367-7-5 | Green | PLT3S-M5 | — | — | — | — |
| MS3367-7-6 | Blue | PLT3S-M6 | — | — | — | — |
| MS3367-7-7 | Purple | PLT3S-M7 | — | — | — | — |
| MS3367-7-8 | Gray | PLT3S-M8 | — | — | — | — |
| MS3367-7-9 | Natural | PLT3S-C, -M | BT3S-C, -M | SST3S-C, -M | — | — |
| MS3367-8-9 | Natural | PLT5H-L, -C | — | — | — | — |
| MS3367-9-9 | Natural | PLT6H-L, -C | — | — | — | — |
| MS3367-11-9 | Natural | PLT8H-L, -C | — | — | — | — |
| MS3367-14-9 | Natural | PLT13H-Q, -C | — | — | — | — |
| MS3367-20-9 | Natural | PLT5EH-Q, -C | — | — | — | — |
| MS3367-21-9 | Natural | PLT6EH-Q, -C | — | — | — | — |
| MS3367-22-9 | Natural | PLT8EH-C | — | — | — | — |
| MS3367-23-9 | Natural | — | — | — | ILT2S-C, -M | — |
| MS3367-24-9 | Natural | — | — | — | ILT4S-C, -M | — |
| MS3367-25-9 | Natural | — | — | — | ILT4LH-TL | — |
| MS3367-29-9 | Natural | — | — | — | ILT3S-C, -M | — |
| MS3367-30-9 | Natural | — | — | — | — | CBR1M-M |
| MS3367-31-9 | Natural | — | — | — | — | CBR1.5M-M |
| MS3367-32-1 | Brown | — | — | — | — | CBR2M-M1 |
| MS3367-32-2 | Red | — | — | — | — | CBR2M-M2 |
| MS3367-32-3 | Orange | — | — | — | — | CBR2M-M3 |
| MS3367-32-4 | Yellow | — | — | — | — | CBR2M-M4Y |
| MS3367-32-5 | Green | — | — | — | — | CBR2M-M5 |
| MS3367-32-6 | Blue | — | — | — | — | CBR2M-M6 |
| MS3367-32-7 | Purple | — | — | — | — | CBR2M-M7 |
| MS3367-32-9 | Natural | — | — | — | — | CBR2M-M |
| MS3367-33-9 | Natural | — | — | — | — | CBR1.5I-M |
| MS3367-34-1 | Brown | — | — | — | — | CBR3I-M1 |
| MS3367-34-2 | Red | — | — | — | — | CBR3I-M2 |
| MS3367-34-3 | Orange | — | — | — | — | CBR3I-M3 |
| MS3367-34-4 | Yellow | — | — | — | — | CBR3I-M4Y |
| MS3367-34-5 | Green | — | — | — | — | CBR3I-M5 |
| MS3367-34-6 | Blue | — | — | — | — | CBR3I-M6 |
| MS3367-34-7 | Purple | — | — | — | — | CBR3I-M7 |
| MS3367-34-8 | Gray | — | — | — | — | CBR3I-M8 |
| MS3367-34-9 | Natural | — | — | — | — | CBR3I-M |
| MS3367-35-9 | Natural | — | — | — | — | CBR4I-M |

*Weather resistant per ASTM D 4066-94B.

A.
System
Overview

B1.
Cable Ties

B2.
Cable
Accessories

B3.
Stainless
Steel Ties

C1.
Wiring
Duct

C2.
Surface
Raceway

C3.
Abrasion
Protection

C4.
Cable
Management

D1.
Terminals

D2.
Power
Connectors

D3.
Grounding
Connectors

E1.
Labeling
Systems

E2.
Labels

E3.
Pre-Printed
& Write-On
Markers

E4.
Permanent
Identification

E5.
Lockout/
Tagout
& Safety
Solutions

F.
Index

Cable Tie Cross Reference

| Mil. Std. Part Number | Color | PAN-TY® | DOME-TOP® Barb Ty | STA-STRAP® | BELT-TY™ In-Line | CONTOUR-TY® |
|-----------------------|---------|-----------------|-------------------|-------------|------------------|-------------|
| MS3367-36-9 | Natural | — | — | — | — | CBR2S-M |
| MS3367-37-9 | Natural | — | — | — | — | CBR3S-M |
| MS3367-38-9 | Natural | — | — | — | — | CBR4S-M |
| MS3367-39-9 | Natural | — | — | — | — | CBR2HS-D |
| MS3367-40-9 | Natural | — | — | — | — | CBR4LH-TL |
| MS3367-41-9 | Natural | — | — | — | — | CBR6LH-C |
| MS3368-1-2A | Red | PLM2S-D2 | — | — | — | — |
| MS3368-1-3A | Orange | PLM2S-D3 | — | — | — | — |
| MS3368-1-4A | Yellow | PLM2S-C4Y, -D4Y | — | — | — | — |
| MS3368-1-5A | Green | PLM2S-D5 | — | — | — | — |
| MS3368-1-6A | Blue | PLM2S-D6 | — | — | — | — |
| MS3368-1-8A | Gray | PLM2S-D8 | — | — | — | — |
| MS3368-1-9A | Natural | PLM2S-C, -D | BM2S-C, -D | — | — | — |
| MS3368-1-9B | Natural | — | — | SSM2S-C, -D | — | — |
| MS3368-2-2A | Red | PLM4S-D2 | — | — | — | — |
| MS3368-2-4A | Yellow | PLM4S-D4Y | — | — | — | — |
| MS3368-2-6A | Blue | PLM4S-D6 | — | — | — | — |
| MS3368-2-9A | Natural | PLM4S-C, -D | BM4S-C, -D | — | — | — |
| MS3368-2-9B | Natural | — | — | SSM4S-D | — | — |
| MS3368-3-4C | Yellow | PL2M2S-D4Y | — | — | — | — |
| MS3368-3-9C | Natural | PL2M2S-L, -D | B2M2S-D | — | — | — |
| MS3368-4-4D | Yellow | PL3M2S-D4Y | — | — | — | — |
| MS3368-4-9D | Natural | PL3M2S-L, -D | B3M2S-TL | — | — | — |
| MS3368-5-1E | Brown | PLM1M-M1 | — | — | — | — |
| MS3368-5-2E | Red | PLM1M-M2 | — | — | — | — |
| MS3368-5-3E | Orange | PLM1M-M3 | — | — | — | — |
| MS3368-5-4E | Yellow | PLM1M-M4Y | — | — | — | — |
| MS3368-5-5E | Green | PLM1M-M5 | — | — | — | — |
| MS3368-5-6E | Blue | PLM1M-M6 | — | — | — | — |
| MS3368-5-7E | Purple | PLM1M-M7 | — | — | — | — |
| MS3368-5-8E | Gray | PLM1M-M8 | — | — | — | — |
| MS3368-5-9E | Natural | PLM1M-C, -M | BM1M-C, -M | — | — | — |

Installation Tools

The *PANDUIT* installation tools listed in the table below meet all of the testing requirements of MIL-T-81306 and the dimensional requirements of MS90387.

| Mil. Std. Part Number | PANDUIT P/N |
|-----------------------|-------------|
| MS90387-1 | GTS, GS2B |
| MS90387-2 | GS4H |

A.
System
Overview

Cable Tie Selection and Specification Guidelines

B1.
Cable Ties

Selecting the Proper Cable Tie Material for Your Application

B2.
Cable
Accessories

By using the information on our material selection chart on pages B1.2 and B1.3 as a guide, the user will be better equipped to select the best cable tie and material suited to perform its intended function over a long period of time.

B3.
Stainless
Steel Ties

For long life and dependable service, there are many factors to consider when selecting the proper cable tie for each application. Since it is impossible for *PANDUIT* to provide data on all the various combinations of conditions which may arise, it is suggested that this data be used as a guide. Sample cable ties should be tested under actual end-use conditions to determine the correct cable tie for the application.

C1.
Wiring
Duct

To select the optimum cable tie for a specific application, the chart on pages B1.2 and B1.3 can be used as a reference. First, determine the most critical design criteria and then read across the table to find which material is most suitable to meet this need. Next, review the other criteria by scanning in a vertical direction on the chart and then make your final selection.

C2.
Surface
Raceway

Example No. 1

| Application | Selection |
|---|---|
| The application requires high radiation (2 x 10 ⁹ rads) resistance and excellent resistance to hydrocarbons. | The best choice is PEEK, TEFZEL [■] , or HALAR [▲] . The price is higher than other materials, but all have high ratings in resistance to radiation and hydrocarbons. |

C4.
Cable
Management

Example No. 2

| Application | Selection |
|---|---|
| The application requires a low cost material, good ultraviolet resistance, and good resistance to acid rains. | The best choice is Weather Resistant Polypropylene. Price is medium, the UV rating is 6, and the acid resistance rating is 9. |

D1.
Terminals

■TEFZEL is a registered trademark of E.I. du Pont de Nemours and Company.
▲HALAR is a registered trademark of Solvay Solexis, Inc.

D2.
Power
Connectors

D3.
Grounding
Connectors

E1.
Labeling
Systems

E2.
Labels

E3.
Pre-Printed
& Write-On
Markers

E4.
Permanent
Identification

E5.
Lockout/
Tagout/
& Safety
Solutions

F.
Index

Weathering

Over a period of time, ultraviolet light (a component of sunlight) attacks most plastic materials and reduces their properties by breaking the molecular chain. The material breakdown is accompanied by reductions in tensile strength and elongation, increased brittleness, color changes and loss of surface gloss.

Carbon black, which is used in *PANDUIT* nylon, polypropylene, and acetal cable ties, is one of the most effective stabilizers known today. A uniform dispersion of carbon black provides good ultraviolet light resistance without adversely affecting physical properties. The addition of carbon black, or any other ultraviolet light stabilizer, prolongs the useful outdoor life of plastic products, but it does not totally eliminate the destructive effects of the light. Some plastics, such as TEFZEL[■] or HALAR[▲], are intrinsically very resistant to ultraviolet light and do not require stabilizing additives.

Weathering Test Methods

In order to monitor the effects of ultraviolet light and the effectiveness of ultraviolet stabilizers, *PANDUIT*, in conformance with industry standards, adopted two methods of weatherability testing: Outdoor Aging and Accelerated Weather Aging.

Outdoor Aging

The Outdoor Aging method is probably the best and most realistic method of the two. It is conducted in accordance with ASTM D 1435 Standard Practice for Outdoor Weathering of Plastics, and allows the material to be affected by not only ultraviolet light, but by all other outdoor elements as well. Although this may more closely approximate an actual application, two drawbacks do exist. The period of time required to produce property decay and material failure may be quite long, and varying adverse chemical environments cannot be tested.

Accelerated Weather Aging

Accelerated weathering tests are conducted to estimate the rate of degradation due to a combination of ultraviolet light, temperature, and moisture. The methods used are in accordance with the following standards:

- ASTM D 1499, Operating Light and Water Exposure Apparatus (Carbon-Arc type) for exposure to plastics
- ASTM G 154-04, Operating Light and Water Exposure (Fluorescent UV Condensation type) for exposure of non-metallic materials

The condition specified in ASTM D 1499 utilizes a water spray and a carbon arc to simulate natural sunshine. The test chamber is operated 20 hrs/day with a two-hour cycle of 108 minutes of simulated sunshine and twelve minutes of sunshine and water spray. The temperature of a black body inside the chamber is approximately 63°C (145°F) during the “sunshine only” portion of the cycle. Humidity is not controlled inside the chamber.

The test chamber per ASTM G 154-04 uses fluorescent sun lamps to generate ultraviolet light only. A heated water pan produces condensation during a portion of the cycle. The daily cycle is composed of 20 hours of light followed by 4 hours of condensation. Black body temperatures during the light cycle are 50°C (122°F) and 40°C (104°F) during the condensation cycle.

PANDUIT has also designed a special chamber, which is used to simulate the effect of acid rain and ultraviolet light on cable tie materials. The effects of other common chemicals, such as road salt, are also evaluated in this chamber.

These methods are effective in quickly determining the ultraviolet light resistance of the various cable tie materials, but it must be emphasized that there are no exact correlations between accelerated aging and actual outdoor exposure.

[■]TEFZEL is a registered trademark of E.I. du Pont de Nemours and Company.

[▲]HALAR is a registered trademark of Solvay Solexis, Inc.

A.
System
Overview

B1.
Cable Ties

B2.
Cable
Accessories

B3.
Stainless
Steel Ties

C1.
Wiring
Duct

C2.
Surface
Raceway

C3.
Abrasion
Protection

C4.
Cable
Management

D1.
Terminals

D2.
Power
Connectors

D3.
Grounding
Connectors

E1.
Labeling
Systems

E2.
Labels

E3.
Pre-Printed
& Write-On
Markers

E4.
Permanent
Identification

E5.
Lockout/
Tagout
& Safety
Solutions

F.
Index

A.
System
Overview

Weathering (continued)

B1.
Cable Ties

Material Failure Testing

Property decay can lead to three different modes of failure: loss of strength, loss of toughness, or change in appearance. The critical mode for any given application would depend upon the application and the requirements it places upon the material itself.

B2.
Cable
Accessories

Loss of strength is monitored by tensile testing samples of the material before and after it has been weathered. This test will reveal the decreasing strength accompanied by extended weathering.

B3.
Stainless
Steel Ties

Loss of toughness can be monitored by measuring changes in elongation and impact strength. As ultraviolet light exposure time increases and the material becomes brittle, its elongation and impact strength are greatly reduced. It is important to note that brittle failures can occur even when the tensile strength shows no change.

C1.
Wiring
Duct

Although change in appearance is normally not a failure mode for cable ties, the plastic does tend to discolor and lose its surface gloss as exposure increases. These changes can be measured by color difference using Adams units, which are similar to National Bureau of Standard units.

C2.
Surface
Raceway

PANDUIT has its own weathering test program to determine estimated life of various cable tie materials. This includes examining many previously aged samples obtained throughout the world.

C3.
Abrasion
Protection

In all cases, the amount of property decay increased with increasing exposure to ultraviolet light. The principal signs of degradation were found to be brittleness, cracking, and loss of surface gloss. It was also determined that the time for failure to occur was shorter than indicated from industry tests performed on material samples. This discrepancy is in part due to the fact that cable ties were tested in an end use, stressed condition, while most plastic resin suppliers conduct weathering tests using unstressed test bars.

C4.
Cable
Management

Five cable tie materials have superior ultraviolet light resistance: TEFZEL[■], HALAR[▲], Weather Resistant Acetal, Nylon 12 and Stainless Steel.

D1.
Terminals

Determining the outdoor life expectancy of any material is difficult since there are other factors, besides ultraviolet light stability, which have to be considered. These factors are listed below and should be considered before specifying a cable tie material.

D2.
Power
Connectors

Table A – External Factors That Affect the Life of a Cable Tie

| Factor | Effect on Cable Tie Life |
|--------------------|--|
| Chemicals | Applications which have chemicals present can reduce the life of a tie. This is the most detrimental factor to the life of a tie. |
| Bundle diameter | As the bundle diameter is reduced, the tie has more bending stress. A thick strap on a small bundle diameter has more stress. |
| Loading | If the tie is under high loading, this will add additional stress on the tie body. |
| Thickness | A thinner tie will have a decreased life since surface cracks will penetrate the thickness of the tie faster. |
| Vibration | Applications with high vibrations will cause impact, which will propagate any surface cracks. |
| Degree of exposure | No shield or shade, southern exposure, higher altitudes and high temperatures, decrease the life of a cable tie. |
| Moisture | High humidity plus high temperature can result in degradation due to hydrolysis in nylon. |
| Galvanized metals | Acid rain and acid moisture acting on galvanized metals release chemicals known to attack Nylon 6.6. |

| Weathering Life Expectancy | |
|--|---------|
| Material, Color (Part Number Suffix) | Years* |
| Polypropylene, Green (109) | 1 |
| Nylon 6.6, Natural (No suffix) | 1 – 2 |
| Flame Retardant Nylon 6.6, Black (60) | 1 – 2 |
| Flame Retardant Nylon 6.6, Ivory (69) | 1 – 2 |
| Heat Stabilized Nylon 6.6, Natural (39) | 1 – 2 |
| PEEK, Polyetheretherketone, Translucent Brown (71) | 1 – 2 |
| Heat Stabilized Nylon 6.6, Black (30) | 4 – 5 |
| Weather Resistant Polypropylene, Black (100) | 7 – 9 |
| Weather Resistant Nylon 6.6, Black (0 and 00) | 7 – 9 |
| Heat Stabilized Weather Resistant Nylon 6.6, Black (300) | 7 – 9 |
| Weather Resistant Nylon 12, Black (120) | 12 – 15 |
| TEFZEL [■] , Aqua Blue (76) | >15 |
| HALAR [▲] , Maroon (702Y) | >15 |
| Weather Resistant Acetal, Black | >20 |
| Stainless Steel | >30 |

*Based on the assumption of minimum loading, no chemical attack and impact-free conditions.

■TEFZEL is a registered trademark of E.I. du Pont de Nemours and Company.

▲HALAR is a registered trademark of Solvay Solexis, Inc.

E5.
Lockout/
Tagout
& Safety
Solutions

F.
Index

Flammability

Flammability

A number of test procedures have been developed which can be used for the evaluation and comparison of various materials to support combustion.

UL 94 Vertical Burning Test

Samples of a material, with dimensions 127mm by 12.7mm and the thickness of the intended end use product, are tested in an unaged “as manufactured” state and in an aged state (seven days at 158°F, 70°C). The test requires the placement of a precisely controlled flame under a vertically supported specimen for a ten second period. The controlled flame is removed and the duration of flaming combustion of the specimen is recorded. When the flaming combustion of the specimen extinguishes, it is immediately subjected to an additional controlled flame exposure. After the additional ten seconds of exposure, the controlled flame is removed, and the duration of flaming combustion of the specimen is recorded. A piece of surgical cotton is placed under the specimen. If drips ignite the cotton, this fact is also recorded.

Materials Classed 94V-0

Requirements:

- None of the specimens will burn with flaming combustion for more than ten seconds after either application of the controlled flame
- The total flaming combustion time will not exceed 50 seconds for the ten controlled flame applications (two controlled flame applications for each of the five specimens)
- None of the specimens will burn with flaming or glowing combustion up to the holding clamp
- None of the specimens will drip flaming particles that ignite the dry absorbent surgical cotton located 12 inches (305mm) below the test specimen
- None of the specimens will exhibit glowing combustion that persists for more than 30 seconds after the second removal of the controlled flame

Materials Classed 94V-1

Requirements:

- None of the specimens will burn with flaming combustion for more than 30 seconds after either application of the controlled flame
- The total flaming combustion time will not exceed 250 seconds for the ten controlled flame applications (two controlled flame applications for each of the five specimens)
- None of the specimens will burn with flaming or glowing combustion up to the holding clamp
- Specimens may drip flaming particles which burn only briefly, and may not ignite the dry absorbent surgical cotton located 12 inches (305mm) below the test specimen
- None of the specimens will exhibit glowing combustion that persists for more than 60 seconds after the second removal of the controlled flame

Materials Classed 94V-2

Requirements:

- None of the specimens will burn with flaming combustion for more than 30 seconds after either application of the controlled flame
- The total flaming combustion time will not exceed 250 seconds for the ten controlled flame applications (two controlled flame applications for each of the five specimens)
- None of the specimens will burn with flaming or glowing combustion up to the holding clamp
- Specimens may drip flaming particles which burn only briefly, and may ignite the dry absorbent surgical cotton placed 12 inches (305mm) below the test specimen
- None of the specimens will exhibit glowing combustion that persists for more than 60 seconds after the second removal of the controlled flame

A.
System
Overview

B1.
Cable Ties

B2.
Cable
Accessories

B3.
Stainless
Steel Ties

C1.
Wiring
Duct

C2.
Surface
Raceway

C3.
Abrasion
Protection

C4.
Cable
Management

D1.
Terminals

D2.
Power
Connectors

D3.
Grounding
Connectors

E1.
Labeling
Systems

E2.
Labels

E3.
Pre-Printed
& Write-On
Markers

E4.
Permanent
Identification

E5.
Lockout/
Tagout
& Safety
Solutions

F.
Index

Flammability (continued)

ASTM D 635

Samples of a material, with dimensions 125mm by 12.5mm and the thickness of the intended end use product, are tested in an unaged “as manufactured” state. A precisely controlled flame is applied to the specimen and a stopwatch is started. The flame is applied for 30 seconds. The stopwatch is stopped when burning or glowing combustion ceases or when the flame has proceeded to a mark 100mm from the free end. Ten specimens are tested. If any of the specimens burn to the 100mm mark, an additional ten specimens are tested.

Burning Rate

- If two or more specimens have burned to the 100mm mark then Average Burning Rate (cm/min.) shall be reported as the average of the burning rates of all specimens which have burned to the 100mm mark

Average Time of Burning and Average Extent of Burning

- Average time of burning and average extent of burning of the sample shall be reported if none of the ten samples or no more than one of the twenty specimens have burned to the 100mm mark

- Average Time of Burning (ATB):

$$ATB, s = \frac{\sum_0^N [time(sec) - 30(sec)]}{N}$$

N = Number of specimens tested
Rounded to the nearest 5 seconds

- Average Extent of Burning (AEB):

$$AEB, mm = \frac{\sum_0^N [10(mm) - unburned length(mm)]}{N}$$

N = Number of specimens tested
Rounded to the nearest 5mm

Table B – Flammability Ratings

| Materials | P/N Suffix | UL 94 | ASTM D 635 |
|---|------------|-----------------|---------------------------------|
| Nylon 6.6, Natural | None | 94V-2 @ .71mm | AEB = 20mm ATB = 5 seconds |
| Weather Resistant Nylon 6.6, Black (Meets Mil. Spec.) | 00 | 94V-2 @ .71mm | AEB = 20mm ATB = 5 seconds |
| Weather Resistant Nylon 6.6, Black* | 0 | 94V-2** @ .71mm | AEB = 20mm ATB = 5 seconds |
| Heat Stabilized Nylon 6.6, Black | 30 | 94V-2 @ .71mm | AEB = 20mm ATB = 5 seconds |
| Heat Stabilized Nylon 6.6, Natural | 39 | 94V-2 @ .71mm | AEB = 20mm ATB = 5 seconds |
| Heat Stabilized Weather Resistant Nylon 6.6, Black | 300 | 94V-2 @ .71mm | AEB = 20mm ATB = 5 seconds |
| Flame Retardant Nylon 6.6, Black | 60 | 94V-0 @ .81mm | AEB = 15mm ATB = < 5 seconds |
| Flame Retardant Nylon 6.6, Natural (Ivory) | 69 | 94V-0 @ .81mm | AEB = 15mm ATB = < 5 seconds |
| PEEK, Polyetheretherketone, Translucent Brown | 71 | 94V-0 @ 1.5mm | — |
| Metal Detectable Nylon 6.6, Blue | 86 | 94 HB @ .71mm | AEB = 20mm ATB = 5 seconds |
| Weather Resistant Nylon 12, Black | 120 | 94 HB @ 1.6mm | Avg. Burning Rate 1.6cm/min. |
| Polypropylene, Green | 109 | 94 HB @ .94mm | Avg. Burning Rate 2cm/min. |
| Weather Resistant Polypropylene, Black | 100 | 94 HB @ .94mm | Avg. Burning Rate 2cm/min. |
| TEFZEL■, Aqua Blue | 76 | 94V-0 @ 1.5mm | AEB = 15mm ATB = < 5 seconds |
| HALAR▲, Maroon | 702Y | 94V-0 @ .18mm | AEB = 15mm ATB = < 5 seconds |
| Weather Resistant Acetal, Black | DT Prefix | 94 HB @ 1.5mm | Avg. Burning Rate 2.8cm/min |

*UL Recognized cable ties meet stated ratings. **UL Recognized -0 parts

■TEFZEL is a registered trademark of E.I. du Pont de Nemours and Company.

▲HALAR is a registered trademark of Solvay Solexis, Inc.

Radiation/Moisture/Temperature/Tensile Strength

Radiation

Installed cable ties of various materials have been exposed to different amounts of radiation to determine the maximum acceptable limit. These tests were conducted by *PANDUIT* to determine the acceptability for use in various areas of nuclear power plants (for radiation exposure accumulated over a 40 year life). See Cable Tie Selection Chart (pages B1.2 and B1.3) for radiation resistance rating.

Moisture

Many plastics when exposed to high relative humidity absorb water and, as such, the tensile strength of the material can change dramatically. Nylon 6.6 when exposed to 100% relative humidity, will absorb as much as 8.5% water which will reduce tensile strength by 50% when compared to a dry cable tie. Polypropylene, HALAR[▲], Type 12 Nylon, TEFZEL[■], Acetal and PEEK are low water absorbing materials and, as such, the effect of water is minimal. See Cable Tie Selection Chart (pages B1.2 and B1.3) for moisture absorption.

Proper Storage

Nylon 6.6 is a hygroscopic material (affected by atmospheric moisture variations). The optimum storage requirement for Nylon 6.6 cable ties is 73°F (± 15°F) and 50% RH (relative humidity) in sealed containers. Improper storage, especially in cold/dry conditions can result in moisture loss, which impedes cable tie performance. *PANDUIT* packaging provides Nylon 6.6 cable ties conditioned to 2.5% moisture added by weight in heavy-wall, polyethylene heat-sealed bags.

Temperature

Plastic materials normally undergo property loss due to oxidation caused by exposure to high temperatures. The maximum continuous use temperature for cable tie materials depends upon the time at the elevated temperature as well as other environmental conditions. Initially, plastics become more flexible and weaker when exposed to high temperatures. After a period of time, oxidation may occur which will cause embrittlement, making plastic cable ties more susceptible to failure from impact and vibration.

The maximum continuous use temperature, is based on the UL Relative Thermal Index (mechanical without impact) as determined by UL per UL 746B. It is one indicator of a material's ability to retain a particular physical property when exposed to elevated temperatures over an extended period of time. It is based on the assumption that there is no loading, no chemical attack, and impact-free condition. The maximum continuous use temperatures for cable tie materials are listed in the Cable Tie Selection Chart (pages B1.2 and B1.3).

Low temperature exposure will also make most plastics more brittle during the exposure, but little property loss occurs when the material is returned to room temperatures. The minimum application use temperatures for cable tie materials are listed in the Cable Tie Selection Chart (pages B1.2 and B1.3).

Tensile Strength

Most cable ties are selected based on material, length, and minimum loop tensile strength. Minimum loop tensile strength was established under SAE Aerospace Standard AS23190. Each cable tie cross section (SM = Subminiature, M = Miniature, I = Intermediate, S = Standard, HS = Heavy-Standard, LH = Light-Heavy, H = Heavy and EH = Extra-Heavy) has a different loop tensile strength when tested per AS23190.

The cable tie is first conditioned at 49°C (120°F), 20% relative humidity for 24 hours, then the cable tie is installed on a split mandrel and the halves of the mandrel separated at a rate of 1 inch (25.4mm) per minute. The separating force required to unlock or break the cable tie is the loop tensile strength. Loop tensile strength is dependent both on the locking design and the tensile strength (psi) of the material. As an example, the tensile strength of polypropylene material is approximately 1/2 to 1/3 of Nylon 6.6; thus the loop tensile strength of a given cross section tie made of polypropylene would be much less than a tie made of Nylon 6.6. This is another property to be considered when selecting a cable tie. The various representative loop tensile strengths are listed in the Cable Tie Selection Chart (pages B1.2 and B1.3).

Halogen-Free

All *PANDUIT* cable ties (with the exception of TEFZEL[■] and HALAR[▲]) are halogen-free per IEC Specification 61249-2-21.

[▲]HALAR is a registered trademark of Solvay Solexis, Inc.

[■]TEFZEL is a registered trademark of E.I. du Pont de Nemours and Company.

A.
System
Overview

B1.
Cable Ties

B2.
Cable
Accessories

B3.
Stainless
Steel Ties

C1.
Wiring
Duct

C2.
Surface
Raceway

C3.
Abrasion
Protection

C4.
Cable
Management

D1.
Terminals

D2.
Power
Connectors

D3.
Grounding
Connectors

E1.
Labeling
Systems

E2.
Labels

E3.
Pre-Printed
& Write-On
Markers

E4.
Permanent
Identification

E5.
Lockout/
Tagout
& Safety
Solutions

F.
Index

Table C – Chemical Resistance Table

Many factors combine to determine the useful life of a cable tie material and none is as important as chemical exposure. Various chemicals will have different effects on plastics depending on such variables as chemical concentrations, temperature, stress and ultraviolet light. This table is an excellent guideline for the selection of the best cable tie material for various cable tie environments. It should be noted that the exposure for this chemical resistance chart is at 70°F (21°C).

Resistance of *PANDUIT* cable tie materials to chemical attack at 70°F (21°C)

A = Excellent

B = Satisfactory

C = Slight Attack

D = Attacked

— = Not Tested

¹ = Pitting occurs under some conditions

² = Attack may occur if sulfuric acid present

Aq. = Aqueous

C.S. = Cold Saturated

| Agent | Percent Concentration | Nylon 6.6* | Nylon 12 | Polypropylene | TEFZEL [■] | HALAR [▲] | PEEK | 304 Stainless Steel | 316 Stainless Steel |
|----------------------------|-----------------------|------------|----------|---------------|---------------------|--------------------|------|---------------------|---------------------|
| Acetaldehyde | 90 | B | — | C | A | A | A | — | — |
| Acetic Acid | 97 | D | D | A | A | A | A | A | A |
| Acetic Acid | 10 | C | B | A | A | A | — | A | A |
| Acetic Anhydride | 90 | — | B | A | A | A | — | A | A |
| Acetone | 100 | A | A | A | A | A | A | A | A |
| Acetophenone | 100 | — | — | B | A | A | — | A | A |
| Acetylene | 100 | — | — | A | A | A | A | A | A |
| Aluminum Chloride | 10 | B | A | A | A | A | A | D | C |
| Aluminum Fluoride | 10 | B | A | A | A | A | — | D | C |
| Aluminum Hydroxide | Aq. C.S. | — | A | A | A | A | — | A | A |
| Aluminum Potassium Sulfate | 10 | B | A | A | A | A | — | A ¹ | A ¹ |
| Ammonia | All | — | A | A | A | A | A | A | A |
| Ammonium Carbonate | 1 to 5 | — | A | — | A | A | — | A | A |
| Ammonium Chloride | 10 to 25 | D | A | A | A | A | A | A ¹ | A |
| Ammonium Hydroxide | 10 | A | — | — | A | A | A | — | — |
| Ammonium Nitrate | 100 | — | A | A | A | A | A | A | A ¹ |
| Ammonium Sulfate | 10 | — | A | A | A | A | A | E ¹ | A |
| Amyl Acetate | 100 | — | — | C | A | A | A | A | A |
| Aniline | 100 | — | B | A | A | A | A | A | A |
| Antimony Trichloride | All | D | — | A | A | A | A | A | A |
| Arsenic Acid | 1 to 80 | — | — | A | A | A | — | A | A |
| Barium Carbonate | All | — | A | A | A | A | — | A | A |
| Barium Chloride | All | — | A | A | A | A | — | A ¹ | A |
| Barium Sulfate | All | — | A | A | A | A | — | A | A |
| Barium Sulfide | All | — | A | A | A | A | — | A | A |
| Benzene | 100 | A | A | C | A | A | A | A | A |
| Benzoic Acid | 100 | D | A | A | A | A | A | A | A |
| Benzoyl Chloride | 100 | — | — | C | A | A | — | — | — |
| Benzyl Alcohol | 100 | — | — | A | A | A | A | — | — |
| Boric Acid | All | D | A | A | A | A | A | B | — |
| Bromine | 100 | D | D | D | A | A | D | D | D |
| Butadiene | 100 | — | — | C | A | A | — | A | A |
| Butane | 100 | — | A | A | A | A | A | A | A |
| Butanediol | 100 | — | — | A | A | A | — | — | — |
| Butyl Acetate | 100 | — | A | C | A | A | A | — | — |
| N. Butyl Alcohol | 100 | — | A | A | A | A | A | A | A |
| Butyl Phthalate | 100 | — | — | A | A | A | — | — | — |
| Butyraldehyde | 100 | — | — | A | A | A | — | — | — |
| Butyric Acid | 10 to 100 | D | — | A | A | A | — | A | A |
| Calcium Carbonate | Aq. C.S. | — | — | A | A | A | A | A | A |
| Calcium Chlorate | Aq. C.S. | — | — | A | A | A | — | A | A |

*Includes all 6.6 Nylons (weather resistant, heat stabilized, and flame retardant).

■TEFZEL is a registered trademark of E.I. du Pont de Nemours and Company.

▲HALAR is a registered trademark of Solvay Solexis, Inc.

| Agent | Percent Concentration | Nylon 6.6* | Nylon 12 | Polypropylene | TEFZEL [®] | HALAR [®] | PEEK | 304 Stainless Steel | 316 Stainless Steel |
|----------------------|-----------------------|------------|----------|---------------|---------------------|--------------------|------|---------------------|--------------------------------|
| Calcium Chloride | 5 | C | A | A | A | A | A | A ¹ | A ¹ |
| Calcium Hydroxide | 50 | — | — | A | A | A | A | A | A |
| Calcium Hypochlorite | 2 | D | — | A | A | A | A | A ¹ | A ¹ |
| Calcium Nitrate | 50 | — | A | A | A | A | A | — | — |
| Calcium Sulfate | 2 | C | — | A | A | A | A | A | A |
| Carbon Tetrachloride | 100 | A | A | D | A | A | A | A | A |
| Carbon Tetrachloride | Aq. 10 | — | — | — | — | A | — | C ¹ | A ¹ |
| Chlorine | Dry | — | D | D | A | A | D | C | C |
| Chlorine | Wet | — | D | C | A | A | D | D | D |
| Chloroacetic Acid | 10 to 50 | D | — | A | A | A | A | D | C |
| Chlorobenzene | 100 | — | C | A | A | A | A | — | — |
| Chloroform | 100 | A | C | C | A | A | A | A | A |
| Chlorosulphonic Acid | 10 to 100 | D | D | D | B | A | D | D | D |
| Chromic Acid | 10 to 50 | D | D | A | A | A | A | C | C |
| Citric Acid | 10 to 50 | B | B | A | — | A | A | A | A |
| Copper Chloride | 1 to 10 | D | — | A | A | A | A | A ¹ -D | A ¹ -C ¹ |
| Copper Cyanide | Aq. C.S. | — | — | A | A | A | A | A | A |
| Copper Nitrate | 50 | — | — | A | A | A | A | A | A |
| Cresol | 100 | D | D | — | A | A | — | A | A |
| Crotonaldehyde | 100 | — | — | A | A | A | — | — | — |
| Cyclohexane | 100 | — | A | C | A | A | A | A | — |
| Cyclohexanol | 100 | — | A | A | A | A | A | A | — |
| Cyclohexanone | 100 | — | A | C | A | A | A | A | — |
| Dibutyl Phthalate | 100 | — | — | A | A | A | A | — | — |
| Dichloroethane | 100 | — | — | A | — | A | A | A | A |
| Dichloroethylene | 100 | — | — | C | A | A | — | — | — |
| Diesel Fuel | 100 | — | A | C | A | A | A | A | A |
| Diethyl Ether | 100 | — | A | A | A | A | A | A | A |
| Diglycolic Acid | Aq. C.S. | — | — | A | A | A | — | — | — |
| Diisobutyl Ketone | 100 | — | — | A | A | A | — | — | — |
| Dimethyl Amine | 100 | — | — | A | A | A | — | — | — |
| Dimethyl Formamide | 100 | — | A | A | A | A | A | A | — |
| Dimethyl Sulfate | 100 | — | — | C | A | A | — | — | — |
| Diocetyl Phthalate | 100 | — | — | A | A | A | A | A | — |
| 1,4-Dioxane | 100 | — | B | C | A | A | A | A | — |
| Ethyl Acetate | 100 | A | A | B | A | A | A | A | A |
| Ethyl Alcohol | 100 | A | A | A | A | A | A | A | A |
| Ethyl Chloride | 100 | — | — | C | A | A | — | A | A |
| Ethylene Chloride | 100 | A | C | C | A | A | — | A | A |
| Ethylene Glycol | 100 | A | A | A | A | A | A | A | A |
| Ethylene Oxide | 100 | — | — | C | A | A | A | — | — |
| Fatty Acids | 100 | — | — | A | A | A | — | — | — |
| Ferric Chloride | 50 | D | — | A | A | A | C | D | D |
| Ferric Hydroxide | All | — | — | A | A | A | — | A | A |
| Ferric Nitrate | All | — | — | A | A | A | A | A | A |
| Ferrous Chloride | Aq. C.S. | D | — | A | A | A | A | D | C |
| Ferrous Sulfate | 10 | — | — | A | A | A | A | A ¹ | A |
| Fluorine (Dry) | 100 | — | — | D | A | — | D | D | D |
| Formaldehyde | 40 | A | B | A | A | A | A | A ¹ | A |
| Formic Acid | All | D | D | A | A | A | C | A | A |
| Freons | 100 | A | — | — | A | A | A | — | — |
| Fuel Oil | 100 | — | A | — | A | A | A | A | A |
| Furfural | 100 | A | — | — | A | A | — | A | A |
| Gallic Acid | Aq. C.S. | — | — | — | A | A | — | A | A |
| Gasoline | 100 | A | — | C | A | A | A | A | A |
| Glycerin | 100 | — | A | A | — | A | — | A | A |
| Glycolic Acid | 40 | D | — | A | A | A | — | — | — |
| Heptane | 100 | — | A | A | A | A | A | A | A |
| Hexane | 100 | — | A | A | A | A | A | A | A |
| Hydrobromic Acid | All | D | D | A | A | A | D | D | D |

*Includes all 6.6 Nylons (weather resistant, heat stabilized, and flame retardant).

[®]TEFZEL is a registered trademark of E.I. du Pont de Nemours and Company.

[®]HALAR is a registered trademark of Solvay Solexis, Inc.

Table continues on page B1.104

A.
System
Overview

B1.
Cable Ties

B2.
Cable
Accessories

B3.
Stainless
Steel Ties

C1.
Wiring
Duct

C2.
Surface
Raceway

C3.
Abrasion
Protection

C4.
Cable
Management

D1.
Terminals

D2.
Power
Connectors

D3.
Grounding
Connectors

E1.
Labeling
Systems

E2.
Labels

E3.
Pre-Printed
& Write-On
Markers

E4.
Permanent
Identification

E5.
Lockout/
Tagout
& Safety
Solutions

F.
Index

Table C – Chemical Resistance Table (continued)

| | Agent | Percent Concentration | Nylon 6.6* | Nylon 12 | Polypropylene | TEFZEL [■] | HALAR [▲] | PEEK | 304 Stainless Steel | 316 Stainless Steel |
|---------------------------------------|-------------------------|-----------------------|------------|----------|---------------|---------------------|--------------------|------|---------------------|---------------------|
| A. System Overview | Hydrochloric Acid | All | D | D | A | A | A | A | D | D |
| | Hydrocyanic Acid | All | — | D | A | A | A | A | C | C |
| | Hydrofluoric Acid | All | D | D | A | A | A | D | D | D |
| B1. Cable Ties | Hydrofluorosilicic Acid | 30 | — | D | A | A | A | — | D | D |
| | Hydrogen Peroxide | 30 | D | B | B | A | A | A | B | A |
| | Hydrogen Sulfide | Dry | — | — | A | A | A | A | A | A |
| B2. Cable Accessories | Hydrogen Sulfide | Wet | D | — | A | A | A | — | C ² | A ² |
| | Hydroquinone | 100 | — | — | A | A | A | — | — | — |
| | Iodine | 100 | — | — | A | A | A | C | D | D |
| B3. Stainless Steel Ties | Iodoform | 100 | — | — | — | A | A | — | A | A |
| | Isopropyl Alcohol | 100 | A | A | A | A | A | A | A | A |
| | Jet Fuel | 100 | A | — | A | A | A | A | A | A |
| C1. Wiring Duct | Lactic Acid | 10 | A | B | A | A | A | — | A | A |
| | Lanolin | 10 | A | A | A | A | A | — | A | A |
| | Lead Acetate | Aq. C.S. | — | — | A | A | A | A | A | A |
| C2. Surface Raceway | Linseed Oil | 100 | A | A | A | A | A | — | A | A |
| | Magnesium Carbonate | Aq. C. S. | — | A | A | A | A | — | A | A |
| | Magnesium Chloride | Aq. C.S. | C | A | A | A | A | A | A ¹ | A ¹ |
| C3. Abrasion Protection | Magnesium Nitrate | Aq. C. S. | — | A | A | A | A | — | A | A |
| | Maleic Acid | 100 | — | — | A | A | A | A | — | — |
| | Malic Acid | Aq. C.S. | — | — | A | A | A | — | A | A |
| C4. Cable Management | Mercuric Chloride | Dilute | — | A | A | A | A | A | D | D |
| | Mercury | 100 | — | A | A | A | A | A | A | A |
| | Methyl Alcohol | 100 | A | A | A | A | A | A | A | A |
| D1. Terminals | Methyl Bromide | 100 | — | — | D | A | A | — | — | — |
| | Methyl Chloride | 100 | — | — | C | A | A | — | — | A |
| | Methyl Chloroform | 100 | A | — | C | A | A | — | — | — |
| D2. Power Connectors | Methyl Ethyl Ketone | 100 | — | A | C | A | A | A | A | A |
| | Methyl Isobutyl Ketone | 100 | A | — | C | A | A | — | A | A |
| | Methylene Chloride | 100 | C | D | C | A | A | A | A | A |
| D3. Grounding Connectors | Naphtha | 100 | — | — | A | A | A | A | A | A |
| | Naphthalene | 100 | — | B | A | A | A | A | A | A |
| | Nickel Chloride | Aq. C.S. | — | A | A | A | A | A | A ¹ | A ¹ |
| E1. Labeling Systems | Nickel Sulfate | Aq. C.S. | — | A | A | A | A | A | A ¹ | A ¹ |
| | Nitric Acid | 10 to 30 | D | D | A | A | A | — | A | A |
| | Nitric Acid | 30 to 68 | D | D | D | B | A | C | A | A |
| E2. Labels | Nitro Benzene | 100 | — | C | C | A | A | A | A | A |
| | Nitro Methane | 100 | A | — | — | A | A | — | — | — |
| | Nitrous Acid | 5 | — | — | — | A | A | A | A | A |
| E3. Pre-Printed & Write-On Markers | Oleic Acid | 100 | — | C | A | A | A | A | A | A |
| | Oxalic Acid | 10 | — | C | A | A | A | A | A | A |
| | Oxygen | All | — | — | A | A | A | A | — | — |
| E4. Permanent Identification | Paraffin | 100 | A | A | A | A | A | — | A | A |
| | Perchloroethylene | 100 | — | — | C | A | A | A | A | A |
| | Petroleum Ether | 100 | — | A | A | A | A | A | A | A |
| E5. Lockout/Tagout & Safety Solutions | Phenol | 90 | D | D | A | A | A | D | A | A |
| | Phosphoric Acid | 10 | D | D | A | A | A | A | A | A |
| | Phosphorous Pentoxide | 100 | — | D | A | A | A | A | — | — |
| F. Index | Phosphorous Trichloride | 100 | — | D | C | A | A | — | A | A |
| | Phthalic Acid | 50 | — | — | C | A | A | — | A | A |
| | Picric Acid | 1 | — | — | A | A | A | A | A | A |
| F. Index | Potassium Borate | 1 | — | — | A | A | A | — | — | — |
| | Potassium Bromide | Aq. C.S. | — | — | A | A | A | A | A ¹ | A ¹ |
| | Potassium Carbonate | Aq. C.S. | — | C | A | A | A | A | A | A |
| F. Index | Potassium Chlorate | Aq. C. S. | — | B | A | A | A | A | A | A |
| | Potassium Chloride | 5 | — | A | A | A | A | A | A ¹ | A ¹ |
| | Potassium Dichromate | Aq. C.S. | — | D | A | A | A | A | A | A |
| F. Index | Potassium Ferrocyanide | 25 | — | — | A | A | A | A | A | A |
| | Potassium Hydroxide | 30 | C | — | A | A | A | A | C | C |

*Includes all 6.6 Nylons (weather resistant, heat stabilized, and flame retardant).

■TEFZEL is a registered trademark of E.I. du Pont de Nemours and Company.

▲HALAR is a registered trademark of Solvay Solexis, Inc.

| Agent | Percent Concentration | Nylon 6.6* | Nylon 12 | Polypropylene | TEFZEL [■] | HALAR [▲] | PEEK | 304 Stainless Steel | 316 Stainless Steel |
|------------------------|-----------------------|------------|----------|---------------|---------------------|--------------------|------|---------------------|---------------------|
| Potassium Iodide | Aq. C.S. | — | A | A | — | A | — | A | A |
| Potassium Nitrate | Aq. C.S. | — | A | A | A | A | A | A | A |
| Potassium Perchlorate | 1 | — | — | A | A | A | — | — | — |
| Potassium Permanganate | 5 | D | D | A | A | A | A | A | A |
| Potassium Persulfate | All | — | — | A | A | A | — | — | — |
| Potassium Sulfate | Aq. C.S. | — | A | A | A | A | A | A | A |
| Potassium Sulfide | Aq. C.S. | — | — | A | A | A | A | A | A |
| Propionic Acid | 50 | — | — | A | A | A | — | — | — |
| Propyl Alcohol | 100 | A | — | A | A | A | A | A | A |
| Pyridine | 100 | — | A | C | A | A | A | C | C |
| Sea Water | 100 | — | A | A | A | A | — | A ¹ | A ¹ |
| Silver Chloride | Aq. C.S. | — | A | A | A | A | — | D | D |
| Silver Nitrate | 10 | — | A | A | A | A | A | A | A |
| Sodium Acetate | Aq. C.S. | A | — | A | A | A | A | A ¹ | A |
| Sodium Benzoate | Aq. C.S. | — | — | A | A | A | — | — | — |
| Sodium Bicarbonate | Aq. C.S. | A | A | A | A | A | A | A | A |
| Sodium Bisulfate | 10 | — | — | A | A | A | — | A | A |
| Sodium Bisulfite | Aq. C.S. | — | B | A | A | A | — | A | A |
| Sodium Borate | Aq. C.S. | — | — | A | A | A | — | A | A |
| Sodium Carbonate | 2 | A | A | A | A | A | A | A | A |
| Sodium Chlorate | 25 | — | C | A | A | A | A | A | A |
| Sodium Chloride | 10 | A | A | A | A | A | A | A ¹ | A ¹ |
| Sodium Chromate | Aq. C.S. | D | — | A | A | A | — | A | A |
| Sodium Fluoride | 5 | — | — | A | A | A | — | A ¹ | A ¹ |
| Sodium Hydroxide | 10 | A | A | A | A | A | A | A | A |
| Sodium Hypochlorite | 5 | B | C | A | A | A | A | C ¹ | A ¹ |
| Sodium Hyposulfite | Aq.C.S. | — | — | — | A | A | — | A | A |
| Sodium Nitrate | 5 | A | A | A | A | A | A | A | A |
| Sodium Perborate | Aq. C.S. | — | B | A | A | A | — | — | C |
| Sodium Perchlorate | 10 | — | — | — | A | A | — | A | A |
| Sodium Phosphate | 5 | — | A | A | A | A | — | A | A |
| Sodium Sulfate | 5 | — | A | A | A | A | A | A | A |
| Sodium Sulfide | 5 | — | A | A | A | A | A | A ¹ | A |
| Sodium Thiosulfate | 25 | — | A | A | A | A | — | A ² | A ² |
| Stannic Chloride | Aq. C.S. | D | — | A | A | A | A | D | C |
| Stannous Chloride | Aq. C.S. | — | A | A | A | A | A | C | B |
| Stearic Acid | 100 | — | C | A | A | A | — | A | A |
| Succinic Acid | 100 | — | B | A | A | A | — | — | — |
| Sulfur | 100 | — | A | A | A | A | A | B | C |
| Sulfur Dioxide | All | D | — | C | A | A | A | A | A |
| Sulfuric Acid | 5 | D | C | A | A | A | C | C | A |
| Sulfuric Acid | 50 | D | D | A | A | A | D | D | C |
| Sulfuric Acid | Concentrate | D | D | C | A | A | D | C | C |
| Sulfurous Acid | 10 | A | — | A | A | A | A | C ¹ | A ¹ |
| Tannic Acid | 10 | — | A | A | A | A | A | A | A |
| Tartaric Acid | 50 | — | B | A | A | A | A | A | A |
| Tetrahydrofuran | 100 | — | C | C | A | A | A | A | A |
| Toluene | 100 | A | A | C | A | A | A | A | A |
| Trichloroacetic Acid | 10 | D | — | B | A | A | — | D | D |
| Trichloroethylene | 100 | — | D | C | A | A | A | A ¹ | A ¹ |
| Turpentine | 100 | — | B | D | A | A | A | A | A |
| Urea | 50 | — | A | A | A | A | — | — | — |
| Vinyl Acetate | 100 | — | — | A | A | A | — | — | — |
| Xylene | 100 | A | — | D | A | A | A | A | A |
| Zinc Chloride | 70 | D | A | A | A | A | A | A | A |
| Zinc Nitrate | Aq. C.S. | — | A | A | A | A | — | A | A |
| Zinc Sulfate | Aq. C.S. | — | A | A | A | A | A | A | A |

*Includes all 6.6 Nylons (weather resistant, heat stabilized, and flame retardant).

■TEFZEL is a registered trademark of E.I. du Pont de Nemours and Company.

▲HALAR is a registered trademark of Solvay Solexis, Inc.

A.
System
Overview

B1.
Cable Ties

B2.
Cable
Accessories

B3.
Stainless
Steel Ties

C1.
Wiring
Duct

C2.
Surface
Raceway

C3.
Abrasion
Protection

C4.
Cable
Management

D1.
Terminals

D2.
Power
Connectors

D3.
Grounding
Connectors

E1.
Labeling
Systems

E2.
Labels

E3.
Pre-Printed
& Write-On
Markers

E4.
Permanent
Identification

E5.
Lockout/
Tagout
& Safety
Solutions

F.
Index

A.
System
Overview

B1.
Cable Ties

B2.
Cable
Accessories

B3.
Stainless
Steel Ties

C1.
Wiring
Duct

C2.
Surface
Raceway

C3.
Abrasion
Protection

C4.
Cable
Management

D1.
Terminals

D2.
Power
Connectors

D3.
Grounding
Connectors

E1.
Labeling
Systems

E2.
Labels

E3.
Pre-Printed
& Write-On
Markers

E4.
Permanent
Identification

E5.
Lockout/
Tagout/
& Safety
Solutions

F.
Index

NOTES

MANUAL CABLE TIE INSTALLATION TOOLS

PANDUIT provides the most preferred hand-operated tools in the industry. These versatile tools can be used for production, maintenance, or construction applications.



PANDUIT cable tie installation tools promote worker safety, help reduce downtime, improve productivity and provide the lowest total installed cost. As with all PANDUIT products, quality in design and production along with customer service excellence, are assured.

Tool Highlights:

- Tool controlled tension and cut-off
 - Ergonomic tools are durable, lightweight, and easy to use
 - Manual tools
 - Pneumatic tools
- Installer controlled tension and cut-off
 - Large selection of tools available for complete range of PANDUIT cable ties
 - Cost-effective alternative for small volume applications

A.
System
Overview

B1.
Cable
Ties

B2.
Cable
Accessories

B3.
Stainless
Steel Ties

C1.
Wiring
Duct

C2.
Surface
Raceway

C3.
Abrasion
Protection

C4.
Cable
Management

D1.
Terminals

D2.
Power
Connectors

D3.
Grounding
Connectors

E1.
Labeling
Systems

E2.
Labels

E3.
Pre-Printed
& Write-On
Markers

E4.
Permanent
Identification

E5.
Lockout/
Tagout
& Safety
Solutions

F.
Index

A. System Overview

Selection Guide – Hand Tools, Accessories, and Kits

Hand Tools

Manual

Tool Controlled Tension and Cut-Off

Recommended usage: under 50,000 ties/year

Typical applications: Low to medium volume tie usage in OEM, MRO, or construction

| Cross Section | Tool Part Number – Page B1.109 | | | | | |
|---------------|--------------------------------|------|------|-----|------|-------|
| | GTS | GTSL | GS2B | GTH | GS4H | GS4EH |
| SM | X | X | | | | |
| M | X | X | X | | | |
| I | X | X | X | | | |
| S | X | X | X | X | X | |
| HS | | | | X | X | |
| LH | | | | X | X | X |
| H | | | | X | X | X |
| EH | | | | | | X |

Cross Sections

| | | |
|----|---|----------------|
| SM | = | Subminiature |
| M | = | Miniature |
| I | = | Intermediate |
| S | = | Standard |
| HS | = | Heavy-Standard |
| LH | = | Light-Heavy |
| H | = | Heavy |
| EH | = | Extra-Heavy |

Installer Controlled Tension and Cut-Off

Recommended usage: under 10,000 ties/year

Typical applications: MRO or construction

| Cross Section | Tool Part Number – Page B1.110 | | | |
|---------------|--------------------------------|------|-------|------|
| | STS2 | STH2 | ST3EH | STHV |
| M | X | | | |
| I | X | | | |
| S | X | X | | |
| HS | | X | | |
| LH | | X | X | X |
| H | | X | X | X |
| EH | | | X | |

Pneumatic

Recommended usage: under 250,000 ties/year

Typical applications: Medium to high volume tie usage in OEM

| Cross Section | Tool Part Number – Page B1.111 | |
|---------------|--------------------------------|-----|
| | PTS | PTH |
| SM | X | |
| M | X | |
| I | X | |
| S | X | X |
| HS | | X |
| LH | | X |
| H | | X |

Accessories/Kits

Manual

| | Part Number | For Tool | Page |
|---|-------------|-----------------------------------|--------|
| Tool Tension Locking Kits | KGSTL | GTS, GTSL | B1.112 |
| | KGHTL | GTH | B1.112 |
| | TTLK3 | GS2B, GS4H | B1.112 |
| Blade Replacement Kits | KGTSBLD | GTS, GTSL | B1.112 |
| | KGTHBLD | GTH | B1.112 |
| | K2-BLD2 | GS2B | B1.112 |
| | K4H-BLD | GS4H | B1.112 |
| Tool Holster | GHH | GTS, GTSL, GS2B, GTH, GS4H, GS4EH | B1.112 |
| | | | |
| Cushion Sleeve Kit | KGTSBLV | GTS | B1.112 |
| | KGTHSLV | GTH | B1.112 |
| Pneumatic Hose Assembly, Filter/Regulator, Adapter Fittings | | | |

Pneumatic

| Part Number | For Tool | Page |
|-------------|----------------|--------|
| KPTSTL | PTS, PTH | B1.112 |
| TTLK3 | PPTS | B1.112 |
| KGTSBLD | PTS | B1.112 |
| KPTHBLD | PTH | B1.112 |
| K2-BLD2 | PPTS | B1.112 |
| GHH | PTS, PPTS | B1.112 |
| PPH10 | PTS, PTH, PPTS | B1.111 |
| PL289N1 | | B1.111 |
| PHCAQ | | B1.111 |
| PHCAT | | B1.111 |

Cable Tie Tools – Tool Controlled Tension and Cut-Off



GTS

- Used in production, maintenance, or construction applications
- Tool controlled tension provides flush cut-off and speeds installation to lower installed cost
- Lightweight and balanced
- Easy to change tension adjustment and easy to operate
- A combination of design, operation, and construction features, provides a long service life
- Replacement blades available, see page B1.112
- No special maintenance required



GTS



GTSL



GS2B



GTH



GS4H



GS4EH

| Part Number | Used with Cable Ties | Weight | | Part Features | Standards | Std. Pkg. Qty. |
|-------------|----------------------|--------|-----|--|---|----------------|
| | | Oz. | g | | | |
| GTS | SM, M, I, S | 9.8 | 278 | Ergonomic design with impact resistant resin housing, narrow nose, and cushion handle. | QPL per Mil. Std. MS90387-1 and Mil. Spec. MIL-T-81306A | 1 |
| GTSL | SM, M, I, S | 8.8 | 249 | Ergonomic design with impact resistant resin housing, narrow nose, and cushion handle. Shorter handle reach (than GTS) for users with smaller hands. | QPL per Mil. Std. MS90387-1 and Mil. Spec. MIL-T-81306A | 1 |
| GS2B | M, I, S | 11.5 | 327 | Metal tool with a durable powder coat finish. | QPL per Mil. Std. MS90387-1 and Mil. Spec. MIL-T-81306A | 1 |
| GTH | S, HS, LH, H | 12.0 | 340 | Ergonomic design with impact resistant resin housing, narrow nose, and cushion handle. | — | 1 |
| GS4H | S, HS, LH, H | 16.0 | 454 | Metal tool with a durable powder coat finish. | QPL per Mil. Std. MS90387-2 and Mil. Spec. MIL-T-81306A | 1 |
| GS4EH | LH, H, EH | 16.0 | 454 | Metal tool with a durable powder coat finish. | — | 1 |

Cable tie cross section sizes: SM = Subminiature, M = Miniature, I = Intermediate, S = Standard, HS = Heavy-Standard, LH = Light-Heavy, H = Heavy, EH = Extra-Heavy.

A.
System
Overview

B1.
Cable Ties

B2.
Cable
Accessories

B3.
Stainless
Steel Ties

C1.
Wiring
Duct

C2.
Surface
Raceway

C3.
Abrasion
Protection

C4.
Cable
Management

D1.
Terminals

D2.
Power
Connectors

D3.
Grounding
Connectors

E1.
Labeling
Systems

E2.
Labels

E3.
Pre-Printed
& Write-On
Markers

E4.
Permanent
Identification

E5.
Lockout/
Tagout
& Safety
Solutions

F.
Index

A.
System
Overview

Cable Tie Tools – Installer Controlled Tension and Cut-Off

B1.
Cable Ties

B2.
Cable
Accessories

B3.
Stainless
Steel Ties



STS2

- Economical series of tools for maintenance or construction applications
- Excellent tools for low volume applications

C1.
Wiring
Duct



STS2

C2.
Surface
Raceway



STH2

C3.
Abrasion
Protection



ST3EH

C4.
Cable
Management

D1.
Terminals

D2.
Power
Connectors

D3.
Grounding
Connectors



STHV

E1.
Labeling
Systems

E2.
Labels

E3.
Pre-Printed
& Write-On
Markers

E4.
Permanent
Identification

E5.
Lockout/
Tagout/
& Safety
Solutions

F.
Index

| Part Number | Used with Cable Ties | Color | Weight | | Part Features | Std. Pkg. Qty. |
|-------------|----------------------|------------|--------|-----|---|----------------|
| | | | Oz. | g | | |
| STS2 | M, I, S | Black | 2.5 | 71 | Economical tool with short handle span and top loading feature for right- or left-handed users. | 1 |
| STH2 | S, HS, LH, H | Red | 2.5 | 71 | Economical tool with short handle span and top loading feature for right- or left-handed users. | 1 |
| ST3EH | LH, H, EH | Blue/Black | 9.0 | 256 | Durable, all steel construction with comfortable plastic handles. | 1 |
| STHV | LH, H | Yellow | 12.0 | 341 | Durable all steel construction and "travel stop" to prevent pinched fingers. | 1 |

Cable tie cross section sizes: SM = Subminiature, M = Miniature, I = Intermediate, S = Standard, HS = Heavy-Standard, LH = Light-Heavy, H = Heavy, EH = Extra-Heavy.

Installation Procedure (STS2/STH2/ST3EH):
Install cable tie around bundle and tension tie by squeezing tool handle. Reduce tension slightly and twist tool 1/4" turn either direction to cut off excess cable tie.

Installation Procedure (STHV):
Install cable tie around bundle and tension tie by squeezing tool handle. A separate lever cuts off excess cable tie.

Pneumatic Hand Tools – Tool Controlled Tension and Cut-Off



PTS

- Pneumatic, push button operation tensions and cuts off excess tie in a fraction of a second
- Durable, lightweight, ergonomic design is easy to operate and designed to reduce operator fatigue
- Easy to change tension adjustment
- Operates on non-lubricated air, without special maintenance



PTS



PTH

| Part Number | Used with Cable Ties | Weight | | Part Features | Std. Pkg. Qty. |
|-------------|----------------------|--------|-----|--|----------------|
| | | Oz. | g | | |
| PTS | SM, M, I, S | 17.3 | 490 | Ergonomic design with impact resistant resin housing and black knob; replacement parts can be part of a scheduled maintenance program. | 1 |
| PTH | S, HS, LH, H | 32.0 | 907 | Ergonomic design with impact resistant resin housing and red knob; replacement parts can be part of a scheduled maintenance program. | 1 |

Note: All tools require the PPH10 hose and PL289N1 filter/regulator for proper operation.

Cable tie cross section sizes: SM = Subminiature, M = Miniature, I = Intermediate, S = Standard, HS = Heavy-Standard, LH = Light-Heavy, H = Heavy.

Pneumatic Tool Accessories



PL289N1/PPH10



PHCAQ



PHCAT

| Part Number | Used with Installation Tool | Part Description | Std. Pkg. Qty. |
|-------------|-----------------------------|---|----------------|
| PL289N1 | PTS, PPTS, PTH | Filter/regulator .5 micron element, regulated range 3 – 100 psig, features 1/8" NPT female output port (to hose PPH10) and 1/4" male quick disconnect to source air line. | 1 |
| PPH10 | PTS, PPTS, PTH | 10.0' (3m) hose assembly (regulator to tool); includes a 1/8" NPT male connector (to regulator) and 1/8" female quick disconnect (to tool). | 1 |
| PHCAQ | PTS, PPTS, PTH | Adapter fitting for 10.0' (3m) hose (PPH10) to regulator with 1/4" female quick disconnect output, features 1/8" NPT female connection (to hose) and 1/4" male quick disconnect (to regulator). | 1 |
| PHCAT | PTS, PPTS, PTH | Adapter fitting for 10.0' (3m) hose (PPH10) to regulator with 1/4" NPT female output port, features 1/8" NPT female connection (to hose) and 1/4" NPT male connection (to regulator). | 1 |

A.
System
Overview

B1.
Cable Ties

B2.
Cable
Accessories

B3.
Stainless
Steel Ties

C1.
Wiring
Duct

C2.
Surface
Raceway

C3.
Abrasion
Protection

C4.
Cable
Management

D1.
Terminals

D2.
Power
Connectors

D3.
Grounding
Connectors

E1.
Labeling
Systems

E2.
Labels

E3.
Pre-Printed
& Write-On
Markers

E4.
Permanent
Identification

E5.
Lockout/
Tagout
& Safety
Solutions

F.
Index

A.
System
Overview

Hand Tool Accessories: Tool Tension Locking Kits

B1.
Cable Ties

- For applications requiring a locking device on either the selector knob (one cross section size and tension only) or tension level adjustment (but allow cross section size changes)



KGTHL

| Part Number | Used with Installation Tool | Contents | Std. Pkg. Qty. |
|---------------|-----------------------------|------------------------------------|----------------|
| KGSTL | GTS, GTSL | Lockout cap and screw. | 1 |
| KGHTL | GTH | Lockout cap and screw. | 1 |
| KPTSTL | PTS, PTH | Lockout cap and screw. | 1 |
| TTLK3 | GS2B, GS4H, PPTS | Selection locking clip and screws. | 1 |

C1.
Wiring
Duct

Blade Replacement Kits

C2.
Surface
Raceway

- Blade replacement kits can be part of a user's scheduled maintenance plan or used when cut-offs are not clean and crisp



KGTSBLD

| Part Number | Used with Installation Tool | Contents | Std. Pkg. Qty. |
|-----------------|-----------------------------|--|----------------|
| KGTSBLD | GTS, GTSL, PTS | Threadlocker, screw, washer and replacement blade. | 1 |
| KGTHBLD | GTH | Threadlocker, screw, and replacement blade. | 1 |
| K2-BLD2 | GS2B, PPTS | Threadlocker, screws, and replacement blade. | 1 |
| K4H-BLD | GS4H | Threadlocker, screws, and replacement blade. | 1 |
| K4EH-BLD | GS4EH | Threadlocker, screw, and replacement blade. | 1 |
| KPTHBLD | PTH | Threadlocker, screw, and replacement blade. | 1 |

C3.
Abrasion
Protection

C4.
Cable
Management

D1.
Terminals

Hand Tool Holster

D2.
Power
Connectors

- Durable leather construction holster with rivets and extra tie-down strap to hold tool in place – easily fits on belt



| Part Number | Used with Installation Tool | Color | Std. Pkg. Qty. |
|-------------|---|-------|----------------|
| GHH | GTS, GTSL, GS2B, GTH, GS4H, GS4EH, PTS, PPTS, ST3EH | Black | 1 |

D3.
Grounding
Connectors

E1.
Labeling
Systems

E2.
Labels

NEW! Cushion Sleeve Kits

E3.
Pre-Printed
& Write-On
Markers

- Cushion sleeve can be added to existing GTS or GTH hand tool
- Reduce operator fatigue
- Reduce the amount of shock an operator may experience while tensioning and cutting off cable ties
- Unique thermoplastic elastomer material that won't split or fall off the tool over time



KGTSLLV

| Part Number | Used with Installation Tool | Color | Contents | Std. Pkg. Qty. |
|----------------|-----------------------------|-------|-------------------------------|----------------|
| KGTSLLV | GTS | Black | Cushion sleeve and lubricant. | 1 |
| KGTHSLV | GTH | Red | Cushion sleeve and lubricant. | 1 |

E4.
Permanent
Identification

E5.
Lockout/
Tagout
& Safety
Solutions

F.
Index

AUTOMATIC CABLE TIE INSTALLATION SYSTEMS



The complete line of *PANDUIT* automatic cable tie installation systems offers a superior solution for high volume harness, assembly, fastening and packaging applications. These ergonomic systems increase productivity, provide consistent performance, and reduce activities that lead to repetitive motion injuries. A variety of tool options provide users with flexible solutions for their unique application needs.



System Highlights

Three systems improve productivity, reliability, and versatility:

- Install a cable tie in less than one second
- Multiple cable tie styles and sizes for maximum productivity
- Optional software for advanced system monitoring and performance



Combined, these innovations improve reliability, maximize productivity, and lower installed costs. As with all *PANDUIT* products, quality in design and production along with customer service excellence, are assured.

A.
System
Overview

B1.
Cable Ties

B2.
Cable
Accessories

B3.
Stainless
Steel Ties

C1.
Wiring
Duct

C2.
Surface
Raceway

C3.
Abrasion
Protection

C4.
Cable
Management

D1.
Terminals

D2.
Power
Connectors

D3.
Grounding
Connectors

E1.
Labeling
Systems

E2.
Labels

E3.
Pre-Printed
& Write-On
Markers

E4.
Permanent
Identification

E5.
Lockout/
Tagout/
& Safety
Solutions

F.
Index

A.
System
Overview

B1.
Cable Ties

B2.
Cable
Accessories

B3.
Stainless
Steel Ties

C1.
Wiring
Duct

C2.
Surface
Raceway

C3.
Abrasion
Protection

C4.
Cable
Management

D1.
Terminals

D2.
Power
Connectors

D3.
Grounding
Connectors

E1.
Labeling
Systems

E2.
Labels

E3.
Pre-Printed
& Write-On
Markers

E4.
Permanent
Identification

E5.
Lockout/
Tagout
& Safety
Solutions

F.
Index

Selection Guide – Automatic Installation Systems and Reel-Fed Cable Ties

Recommended for annual usage of over 250,000 cable ties/year
Typical applications: High volume OEM/contract manufacturing

PAT1M/PAT1.5M Systems

Tool Head for use with MINIATURE Cross Section

| Part Number | Description | Page |
|-------------|---|--------|
| PAT1M | For miniature cross section up to .82" (21mm) bundle diameter | B1.115 |
| PAT1.5M | For miniature cable ties up to 1.31" (33mm) bundle diameter | B1.115 |

Dispenser

| Part Number | Description | Page |
|-------------|--|--------|
| PDM | Stationary dispenser | B1.115 |
| PDM-DI | Dispenser and data interface software | B1.117 |
| PD-DIA | Data interface accessory – software and interface card | B1.117 |

Transfer Hose

| Part Number | Description | Page |
|-------------|--------------------------|--------|
| PHM1 | 3.2' (1m) transfer hose | B1.116 |
| PHM2 | 6.5' (2m) transfer hose | B1.116 |
| PHM3 | 10.0' (3m) transfer hose | B1.116 |
| PHM4 | 13.1' (4m) transfer hose | B1.116 |

Optional System Accessories

| Part Number | Description | Page |
|-------------|----------------------------|--------|
| PDH10-37 | Air hose | B1.117 |
| PL283N1 | Filter/regulator | B1.117 |
| PATMBM | Bench mount and foot pedal | B1.117 |

Reel-Fed Cable Ties

MINIATURE Cross Section

| Part Number | Description | Color | Page |
|--|--|---------------|--------|
| Barbed Tie – Max. Bundle Dia.: .82" (21mm), 30 lbs. | | | |
| BT1M-XMR | Nylon 6.6 | Natural | B1.118 |
| BT1M-XMR0 | Weather Resistant Nylon 6.6 | Black | B1.118 |
| BT1M-XMR30 | Heat Stabilized Nylon 6.6 | Black | B1.118 |
| Barbed Tie – Max. Bundle Dia.: 1.31" (33mm), 30 lbs. | | | |
| BT1.5M-XMR | Nylon 6.6 | Natural | B1.118 |
| BT1.5M-XMR0 | Weather Resistant Nylon 6.6 | Black | B1.118 |
| BT1.5M-XMR30 | Heat Stabilized Nylon 6.6 | Black | B1.118 |
| BT1.5M-XMR69 | Flame Retardant Nylon 6.6 | Natural Ivory | B1.118 |
| All-Nylon Tie – Max. Bundle Dia.: .82" (21mm), 18 lbs. | | | |
| PLT1M-XMR | Nylon 6.6 | Natural | B1.119 |
| PLT1M-XMR0 | Weather Resistant Nylon 6.6 | Black | B1.119 |
| PLT1M-XMR00 | Weather Resistant Nylon 6.6 (Meets Mil Spec) | Black | B1.119 |
| PLT1M-XMR30 | Heat Stabilized Nylon 6.6 | Black | B1.119 |
| All-Nylon Tie – Max. Bundle Dia.: 1.31" (33mm), 18 lbs. | | | |
| PLT1.5M-XMR | Nylon 6.6 | Natural | B1.119 |
| PLT1.5M-XMR0 | Weather Resistant Nylon 6.6 | Black | B1.119 |
| PLT1.5M-XMR00 | Weather Resistant Nylon 6.6 (Meets Mil Spec) | Black | B1.119 |
| PLT1.5M-XMR30 | Heat Stabilized Nylon 6.6 | Black | B1.119 |

PAT2S System

Tool Head for use with STANDARD Cross Section

| Part Number | Description | Page |
|-------------|---|--------|
| PAT2S | For standard cross section up to 2.00" (51mm) bundle diameter | B1.115 |

Dispenser

| Part Number | Description | Page |
|-------------|--|--------|
| PDS | Stationary dispenser | B1.115 |
| PDS-DI | Dispenser and data interface software | B1.117 |
| PD-DIA | Data interface accessory – software and interface card | B1.117 |

Transfer Hose

| Part Number | Description | Page |
|-------------|--------------------------|--------|
| PHS2 | 6.5' (2m) transfer hose | B1.116 |
| PHS3 | 10.0' (3m) transfer hose | B1.116 |

Dispenser Frame

| Part Number | Description | Page |
|-------------|-----------------|--------|
| PDSF | Dispenser frame | B1.116 |

Optional System Accessories

| Part Number | Description | Page |
|-------------|----------------------------|--------|
| PDH10-37 | Air hose | B1.117 |
| PL283N1 | Filter/regulator | B1.117 |
| PAT2SBM | Bench mount and foot pedal | B1.117 |

Reel-Fed Cable Ties

STANDARD Cross Section

| Part Number | Description | Color | Page |
|--|--|---------|--------|
| All-Nylon Tie – Max. Bundle Dia.: 2.00" (51mm), 50 lbs. | | | |
| PLT2S-VMR | Nylon 6.6 | Natural | B1.120 |
| PLT2S-VMR0 | Weather Resistant Nylon 6.6 | Black | B1.120 |
| PLT2S-VMR00 | Weather Resistant Nylon 6.6 (Meets Mil Spec) | Black | B1.120 |
| PLT2S-VMR30 | Heat Stabilized Nylon 6.6 | Black | B1.120 |

System Selection Guide

| Maximum Bundle Dia. | | Tool Head | Dispenser/Frame | Transfer Hose | Reel-Fed Cable Ties |
|---------------------|----|-----------|-----------------|------------------------|-------------------------|
| In. | mm | | | | |
| .82 | 21 | PAT1M | PDM | PHM1, PHM2, PHM3, PHM4 | BT1M-XMR, PLT1M-XMR |
| 1.31 | 33 | PAT1.5M | PDM | | BT1.5M-XMR, PLT1.5M-XMR |
| 2.00 | 51 | PAT2S | PDS/PDSF | PHS2, PHS3 | PLT2S-VMR |

Tool Head – Three Sizes Accommodate a Wide Variety of Applications

- Ergonomic, lightweight design reduces operator fatigue and repetitive motion injuries – no counter balance required
- Right or left hand operation
- Durable, one-piece cable tie tip collector (for cut-off tips)
- Includes tension adjustment
- Built-in safety interlock prevents false triggering if anything obstructs jaw path



PAT1M



PAT1.5M



PAT2S

| Part Number | Max. Bundle Dia. | | Dispenser/Frame | Transfer Hose | Used with Cable Ties | Std. Pkg. Qty. |
|-------------|------------------|----|-----------------|------------------------|-------------------------|----------------|
| | In. | mm | | | | |
| PAT1M | .82 | 21 | PDM | PHM1, PHM2, PHM3, PHM4 | PLT1M-XMR, BT1M-XMR | 1 |
| PAT1.5M | 1.31 | 33 | PDM | | PLT1.5M-XMR, BT1.5M-XMR | 1 |
| PAT2S | 2.00 | 51 | PDS/PDSF | PHS2, PHS3 | PLT2S-VMR | 1 |

Dispenser

- Microprocessor based controller monitors system performance through LCD display; provides production data and reporting, including error detection and cycle count for improved reliability
- Online HELP menu through LCD display in five languages (English, Spanish, German, Italian or French), is user-friendly for quick and simple training



PDM



PDS

| Part Number | Used with Tool Head | Description | Std. Pkg. Qty. |
|-------------|---------------------|--|----------------|
| PDM | PAT1M, PAT1.5M | Stationary dispenser with electronic display. Online help menu through LCD display; multi-language; alarm sounds if error occurs. The system operates on 65 psig. (minimum) non-lubricated filtered air and 100 – 240 VAC/50 or 60 Hz – automatically adjusts within this range. | 1 |
| PDS | PAT2S | | 1 |

A. System Overview

B1. Cable Ties

B2. Cable Accessories

B3. Stainless Steel Ties

C1. Wiring Duct

C2. Surface Raceway

C3. Abrasion Protection

C4. Cable Management

D1. Terminals

D2. Power Connectors

D3. Grounding Connectors

E1. Labeling Systems

E2. Labels

E3. Pre-Printed & Write-On Markers

E4. Permanent Identification

E5. Lockout/Tagout & Safety Solutions

F. Index

A.
System
Overview

Transfer Hose



PHM3

| Part Number | Used with Tool Head | Part Description | Length | | Std. Pkg. Qty. |
|-------------|---------------------|---|--------|---|----------------|
| | | | Ft. | m | |
| PHM1 | PAT1M, PAT1.5M | Transfers cable tie and signal from dispenser to tool head; electrical connectors designed for easy attachment provide a reliable, secure connection. | 3.2 | 1 | 1 |
| PHM2 | | | 6.5 | 2 | 1 |
| PHM3 | | | 10.0 | 3 | 1 |
| PHM4 | | | 13.1 | 4 | 1 |
| PHS2 | PAT2S | | 6.5 | 2 | 1 |
| PHS3 | | | 10.0 | 3 | 1 |

B1.
Cable Ties

B2.
Cable
Accessories

B3.
Stainless
Steel Ties

C1.
Wiring
Duct

Dispenser Frame



| Part Number | Used with Dispenser | Description | Std. Pkg. Qty. |
|-------------|---------------------|---|----------------|
| PDSF | PDS (PAT2S) | Metal frame supports the PDS dispenser above the cable tie reel as ties are loaded into dispenser; can be used as a free-standing unit or permanently mounted to a bench or cart. | 1 |

C2.
Surface
Raceway

C3.
Abrasion
Protection

C4.
Cable
Management

Optional System Accessories:

Filter/Regulator and Air Supply Hose

D1.
Terminals



PL283N1

PDH10-37

| Part Number | Used with Dispenser | Description | Std. Pkg. Qty. |
|-------------|---------------------|--|----------------|
| PL283N1 | PDM, PDS | Regulates air flow to dispenser. Filter/regulator 25 micron (max.) element, 3/8" ports. Includes a male connector and a 3/8" port. | 1 |
| PDH10-37 | PDM, PDS | Air hose from filter/regulator to dispenser; 10.0' (3m) – includes standard air fittings. | 1 |

D2.
Power
Connectors

D3.
Grounding
Connectors

E1.
Labeling
Systems

Bench Mount



PATMBM

| Part Number | Used with Tool Head | Description | Std. Pkg. Qty. |
|-------------|---------------------|--|----------------|
| PATMBM | PAT1M, PAT1.5M | Allows hands-free operation for high volume usage. Includes bench mount fixture and foot pedal assembly. | 1 |
| PAT2SBM | PAT2S | | 1 |

E2.
Labels

E3.
Pre-Printed
& Write-On
Markers

E4.
Permanent
Identification



E5.
Lockout/
Tagout/
& Safety
Solutions

F.
Index

Data Interface Software and Ethernet Enabled Dispenser

PANDUIT exclusive Ethernet enabled dispenser and customized data interface software allow production personnel to monitor real-time data in a shop floor environment.

The Ethernet enabled dispenser provides a physical connection between the cable tie installation system and an Industrial Ethernet Network via an RJ45 connection and internal Ethernet card.

- Allows production and/or engineering personnel the capability to measure and track production performance such as job tracking, cycle counts, tool and dispenser serial numbers, and routine maintenance
- Provides the ability to send email notifications for specific system messages
- Data extraction and reporting capabilities on system performance through an exportable electronic log; helps identify operator training needs
- Ability to monitor alerts from remote desktop locations



| Part Number | Used with Dispenser | Description | Std. Pkg. Qty. |
|-------------|---------------------|---|----------------|
| PDM-DI | PDM | Ethernet enabled PDM dispenser and data interface software. | 1 |
| PDS-DI | PDS | Ethernet enabled PDS dispenser and data interface software. | 1 |
| PD-DIA | PDM/PDS | Data interface accessory for existing PDM, PDS dispensers; software and network interface card. | 1 |

A.
System
Overview

B1.
Cable Ties

B2.
Cable
Accessories

B3.
Stainless
Steel Ties

C1.
Wiring
Duct

C2.
Surface
Raceway

C3.
Abrasion
Protection

C4.
Cable
Management

D1.
Terminals

D2.
Power
Connectors

D3.
Grounding
Connectors

E1.
Labeling
Systems

E2.
Labels

E3.
Pre-Printed
& Write-On
Markers

E4.
Permanent
Identification

E5.
Lockout/
Tagout
& Safety
Solutions

F.
Index

A.
System
Overview

BT-XMR Reel-Fed Cable Ties

- Continuously molded cable ties (5,000 ties/reel) provide continuous feeding for high productivity and reduced downtime due to fewer reel changes
- Reel-fed cable ties with exclusive stainless steel locking barb and 30 lbs. minimum loop tensile strength permit higher tension for demanding applications
- Metal locking barb and tie body design provide greater bundle tightness, reducing both rotational and lateral movement of the tie

B1.
Cable Ties

B2.
Cable
Accessories

B3.
Stainless
Steel Ties



BT_XMR



BT_XMR (0, 30)

C1.
Wiring
Duct

C2.
Surface
Raceway

C3.
Abrasion
Protection

C4.
Cable
Management



| Part Number | Tie Style | Material | Color | Max. Bundle Dia. | | Length | | Width | | Min. Loop Tensile Str. | |
|---|-----------|-----------------------------|---------|------------------|----|--------|-----|-------|-----|------------------------|-----|
| | | | | In. | mm | In. | mm | In. | mm | Lbs. | N |
| Reel-Fed Cable Ties for PAT1M System | | | | | | | | | | | |
| BT1M-XMR | Barbed | Nylon 6.6 | Natural | .82 | 21 | 4.0 | 102 | .100 | 2.5 | 30 | 133 |
| BT1M-XMR0 | Barbed | Weather Resistant Nylon 6.6 | Black | .82 | 21 | 4.0 | 102 | .100 | 2.5 | 30 | 133 |
| BT1M-XMR30 | Barbed | Heat Stabilized Nylon 6.6 | Black | .82 | 21 | 4.0 | 102 | .100 | 2.5 | 30 | 133 |

| Reel-Fed Cable Ties for PAT1.5M System | | | | | | | | | | | |
|---|-----------|-----------------------------|-----------------|------------------|----|--------|-----|-------|-----|------------------------|-----|
| Part Number | Tie Style | Material | Color | Max. Bundle Dia. | | Length | | Width | | Min. Loop Tensile Str. | |
| | | | | In. | mm | In. | mm | In. | mm | Lbs. | N |
| BT1.5M-XMR | Barbed | Nylon 6.6 | Natural | 1.31 | 33 | 5.6 | 142 | .100 | 2.5 | 30 | 133 |
| BT1.5M-XMR0 | Barbed | Weather Resistant Nylon 6.6 | Black | 1.31 | 33 | 5.6 | 142 | .100 | 2.5 | 30 | 133 |
| BT1.5M-XMR30 | Barbed | Heat Stabilized Nylon 6.6 | Black | 1.31 | 33 | 5.6 | 142 | .100 | 2.5 | 30 | 133 |
| BT1.5M-XMR69* | Barbed | Flame Retardant Nylon 6.6 | Natural (Ivory) | 1.31 | 33 | 5.6 | 142 | .100 | 2.5 | 18 | 80 |

*Flammability rating of UL 94V-0
Note: UL Recognized, UL Listed, and CSA Certified except 69 material.

E1.
Labeling
Systems

E2.
Labels

E3.
Pre-Printed
& Write-On
Markers

E4.
Permanent
Identification

E5.
Lockout/
Tagout
& Safety
Solutions

F.
Index

UL US **CS** LISTED **SP** US **PLT-XMR Reel-Fed Cable Ties**

- Continuously molded cable ties (5,000 ties/reel) provide continuous feeding for high productivity and reduced downtime due to fewer reel changes
- All-nylon, one-piece locking ties with 18 lbs. minimum loop tensile strength in miniature cross section
- Available in a variety of colors and materials



| Part Number | Tie Style | Material | Color | Max. Bundle Dia. | | Length | | Width | | Min. Loop Tensile Str. | |
|---|-----------|-----------------------------|---------|------------------|----|--------|-----|-------|-----|------------------------|----|
| | | | | In. | mm | In. | mm | In. | mm | Lbs. | N |
| Reel-Fed Cable Ties for PAT1M System | | | | | | | | | | | |
| PLT1M-XMR | All-Nylon | Nylon 6.6 | Natural | .82 | 21 | 4.0 | 102 | .100 | 2.5 | 18 | 80 |
| PLT1M-XMR0 | All-Nylon | Weather Resistant Nylon 6.6 | Black | .82 | 21 | 4.0 | 102 | .100 | 2.5 | 18 | 80 |
| PLT1M-XMR00* | All-Nylon | Weather Resistant Nylon 6.6 | Black | .82 | 21 | 4.0 | 102 | .100 | 2.5 | 18 | 80 |
| PLT1M-XMR1 | All-Nylon | Nylon 6.6 | Brown | .82 | 21 | 4.0 | 102 | .100 | 2.5 | 18 | 80 |
| PLT1M-XMR2 | All-Nylon | Nylon 6.6 | Red | .82 | 21 | 4.0 | 102 | .100 | 2.5 | 18 | 80 |
| PLT1M-XMR3 | All-Nylon | Nylon 6.6 | Orange | .82 | 21 | 4.0 | 102 | .100 | 2.5 | 18 | 80 |
| PLT1M-XMR4Y | All-Nylon | Nylon 6.6 | Yellow | .82 | 21 | 4.0 | 102 | .100 | 2.5 | 18 | 80 |
| PLT1M-XMR5 | All-Nylon | Nylon 6.6 | Green | .82 | 21 | 4.0 | 102 | .100 | 2.5 | 18 | 80 |
| PLT1M-XMR6 | All-Nylon | Nylon 6.6 | Blue | .82 | 21 | 4.0 | 102 | .100 | 2.5 | 18 | 80 |
| PLT1M-XMR7 | All-Nylon | Nylon 6.6 | Purple | .82 | 21 | 4.0 | 102 | .100 | 2.5 | 18 | 80 |
| PLT1M-XMR8 | All-Nylon | Nylon 6.6 | Gray | .82 | 21 | 4.0 | 102 | .100 | 2.5 | 18 | 80 |
| PLT1M-XMR10 | All-Nylon | Nylon 6.6 | White | .82 | 21 | 4.0 | 102 | .100 | 2.5 | 18 | 80 |
| PLT1M-XMR30 | All-Nylon | Heat Stabilized Nylon 6.6 | Black | .82 | 21 | 4.0 | 102 | .100 | 2.5 | 18 | 80 |

| | | | | | | | | | | | |
|---|-----------|-----------------------------|---------|------|----|-----|-----|------|-----|----|----|
| Reel-Fed Cable Ties for PAT1.5M System | | | | | | | | | | | |
| PLT1.5M-XMR | All-Nylon | Nylon 6.6 | Natural | 1.31 | 33 | 5.6 | 142 | .100 | 2.5 | 18 | 80 |
| PLT1.5M-XMR0 | All-Nylon | Weather Resistant Nylon 6.6 | Black | 1.31 | 33 | 5.6 | 142 | .100 | 2.5 | 18 | 80 |
| PLT1.5M-XMR00* | All-Nylon | Weather Resistant Nylon 6.6 | Black | 1.31 | 33 | 5.6 | 142 | .100 | 2.5 | 18 | 80 |
| PLT1.5M-XMR30 | All-Nylon | Heat Stabilized Nylon 6.6 | Black | 1.31 | 33 | 5.6 | 142 | .100 | 2.5 | 18 | 80 |

*Military grade weather resistant material.

Note: PLT_XMR cable ties (natural, 00, and colors) are Class 2 Mil. Spec. per SAE-AS23190A and SAE-AS33671.

A. System Overview

B1. Cable Ties

B2. Cable Accessories

B3. Stainless Steel Ties

C1. Wiring Duct

C2. Surface Raceway

C3. Abrasion Protection

C4. Cable Management

D1. Terminals

D2. Power Connectors

D3. Grounding Connectors

E1. Labeling Systems

E2. Labels

E3. Pre-Printed & Write-On Markers

E4. Permanent Identification

E5. Lockout/Tagout & Safety Solutions

F. Index

A. System Overview

PLT-VMR Reel-Fed Cable Ties

- Continuously molded cable ties (2,500 ties/reel) provide continuous feeding for high productivity and reduced downtime due to fewer reel changes
- All-nylon, one-piece locking ties with 50 lbs. minimum loop tensile strength in standard cross section for larger bundles up to 2" diameter

B1. Cable Ties

B2. Cable Accessories

B3. Stainless Steel Ties



C1. Wiring Duct

C2. Surface Raceway

| Part Number | Tie Style | Material | Color | Max. Bundle Dia. | | Length | | Width | | Min. Loop Tensile Str. | |
|---|-----------|-----------------------------|---------|------------------|----|--------|-----|-------|-----|------------------------|-----|
| | | | | In. | mm | In. | mm | In. | mm | Lbs. | N |
| Reel-Fed Cable Ties for PAT2S System | | | | | | | | | | | |
| PLT2S-VMR | All-Nylon | Nylon 6.6 | Natural | 2.00 | 51 | 8.1 | 206 | .190 | 4.8 | 50 | 222 |
| PLT2S-VMR0 | All-Nylon | Weather Resistant Nylon 6.6 | Black | 2.00 | 51 | 8.1 | 206 | .190 | 4.8 | 50 | 222 |
| PLT2S-VMR30 | All-Nylon | Heat Stabilized Nylon 6.6 | Black | 2.00 | 51 | 8.1 | 206 | .190 | 4.8 | 50 | 222 |

Note: PLT_VMR Nylon 6.6 cable ties are Class 2 Mil. Spec. per SAE-AS23190A and SAE-AS33671.

D1. Terminals

D2. Power Connectors

Tie Harness Mount for Single Cable Tie – Nylon and Heat Stabilized Nylon 6.6

- Secured with only one cable tie
- Cable ties can be installed by hand or with *PANDUIT* automatic cable tie tools
- Wing design provides added stability
- Natural nylon material for indoor use
- Heat stabilized material for high temperature applications – indoor use

D3. Grounding Connectors

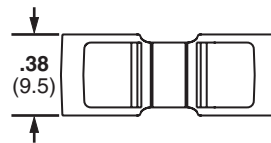
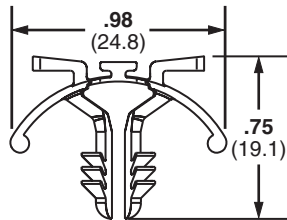

E1. Labeling Systems

E2. Labels

| Part Number | Used with Cable Ties* | Maximum Panel Thickness | | Panel Hole Diameter | | Color | Mounting Method | Std. Pkg. Qty. | Std. Ctn. Qty. |
|----------------------------------|-----------------------|-------------------------|-----|---------------------|-----|---------|-----------------|----------------|----------------|
| | | In. | mm | In. | mm | | | | |
| Nylon 6.6 | | | | | | | | | |
| THM1SC-C | M, I, S | .135 | 3.4 | .250 | 6.4 | Natural | Tree barb | 100 | 1000 |
| Heat Stabilized Nylon 6.6 | | | | | | | | | |
| THM1SC-C30 | M, I, S | .135 | 3.4 | .250 | 6.4 | Black | Tree barb | 100 | 1000 |

*Cable tie cross section sizes: M = Miniature, I = Intermediate, S = Standard.

F. Index

P Tie Harness Mounts – Nylon and Heat Stabilized Nylon 6.6

- Designed to be attached to the wire harness during assembly
- Cable ties can be installed by hand or with *PANDUIT* automatic cable tie tools on page B1.115
- Used with harness board standoff posts, see page B2.51
- Available with or without corrugated tubing location tab
- Natural nylon material for indoor use
- Heat stabilized nylon material (30) for high temperature applications – indoor use

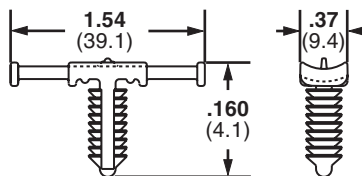

| Part Number | Used with Cable Ties* | Maximum Panel Thickness | | Panel Hole Diameter | | Material | Color | Mounting Method | Std. Pkg. Qty. | Std. Ctn. Qty. |
|--|-----------------------|-------------------------|-----|---------------------|-----------|---------------------------|---------|-----------------|----------------|----------------|
| | | In. | mm | In. | mm | | | | | |
| FOR CORRUGATED TUBING – A location tab on the mount shelf aligns with the corrugated tubing grooves to ensure proper mount location during assembly | | | | | | | | | | |
| THMSP20-C | M, I, S | .160 | 4.1 | .244 – .283 | 6.2 – 7.2 | Nylon 6.6 | Natural | Push barb | 100 | 1000 |
| THMSP20-C30 | M, I, S | .160 | 4.1 | .244 – .283 | 6.2 – 7.2 | Heat Stabilized Nylon 6.6 | Black | Push barb | 100 | 1000 |
| THMSP25-C | M, I, S | .230 | 5.8 | .244 – .283 | 6.2 – 7.2 | Nylon 6.6 | Natural | Push barb | 100 | 1000 |
| THMSP25-C30 | M, I, S | .230 | 5.8 | .244 – .283 | 6.2 – 7.2 | Heat Stabilized Nylon 6.6 | Black | Push barb | 100 | 1000 |
| FOR DISCRETE WIRING – No location tab | | | | | | | | | | |
| THMSP20F-C | M, I, S | .160 | 4.1 | .244 – .283 | 6.2 – 7.2 | Nylon 6.6 | Natural | Push barb | 100 | 1000 |
| THMSP20F-C30 | M, I, S | .160 | 4.1 | .244 – .283 | 6.2 – 7.2 | Heat Stabilized Nylon 6.6 | Black | Push barb | 100 | 1000 |
| THMSP25F-C | M, I, S | .230 | 5.8 | .244 – .283 | 6.2 – 7.2 | Nylon 6.6 | Natural | Push barb | 100 | 1000 |
| THMSP25F-C30 | M, I, S | .230 | 5.8 | .244 – .283 | 6.2 – 7.2 | Heat Stabilized Nylon 6.6 | Black | Push barb | 100 | 1000 |

*Cable tie cross section sizes: M = Miniature, I = Intermediate, S = Standard.

A.
System
Overview

B1.
Cable Ties

B2.
Cable
Accessories

B3.
Stainless
Steel Ties

C1.
Wiring
Duct

C2.
Surface
Raceway

C3.
Abrasion
Protection

C4.
Cable
Management

D1.
Terminals

D2.
Power
Connectors

D3.
Grounding
Connectors

E1.
Labeling
Systems

E2.
Labels

E3.
Pre-Printed
& Write-On
Markers

E4.
Permanent
Identification

E5.
Lockout/
Tagout
& Safety
Solutions

F.
Index

A.
System
Overview

B1.
Cable Ties

B2.
Cable
Accessories

B3.
Stainless
Steel Ties

C1.
Wiring
Duct

C2.
Surface
Raceway

C3.
Abrasion
Protection

C4.
Cable
Management

D1.
Terminals

D2.
Power
Connectors

D3.
Grounding
Connectors

E1.
Labeling
Systems

E2.
Labels

E3.
Pre-Printed
& Write-On
Markers

E4.
Permanent
Identification

E5.
Lockout/
Tagout/
& Safety
Solutions

F.
Index

NOTES

CABLE ACCESSORIES



PANDUIT provides a comprehensive offering of cable accessories. These accessories are engineered to speed installation and lower installed costs for routing and managing cable. *PANDUIT* cable accessories are designed and manufactured to meet applicable quality standards including International, UL, Military, ISO and Aerospace.



- Largest selection of mounts, clips, and clamps for cable management
- *PANDUIT* cable ties and accessories can be used in a variety of applications and environments, providing the optimal cable management solution
- Installation methods include adhesive backed, user applied adhesive, screws, rivets or push barb



PANDUIT mounts, clips, and clamps are manufactured in an environment committed to design innovation, high quality, and knowledgeable service to our customers. Adhesive backed mounts provide a strong adhesive bond for long-term reliability. Cable clips offer a one-piece solution to save time and reduce inventory. Harness board accessories speed the routing and forming of cable bundles in the fabrication of a harness. They hold bundles at a uniform height above the board and are ideal for use with *PANDUIT* manual and automatic cable tie tooling.

A.
System
Overview

B1.
Cable Ties

B2.
Cable
Accessories

B3.
Stainless
Steel Ties

C1.
Wiring
Duct

C2.
Surface
Raceway

C3.
Abrasion
Protection

C4.
Cable
Management

D1.
Terminals

D2.
Power
Connectors

D3.
Grounding
Connectors

E1.
Labeling
Systems

E2.
Labels

E3.
Pre-Printed
& Write-On
Markers

E4.
Permanent
Identification

E5.
Lockout/
Tagout/
& Safety
Solutions

F.
Index

A. System Overview

4-Way Adhesive Backed Cable Tie Mounts

B1. Cable Ties

- Allow cable tie entry from all four sides
- Available in multiple sizes to match application load requirements
- Produced 2-up or 4-up for fast and easy liner removal to speed installation

B2. Cable Accessories



B3. Stainless Steel Ties

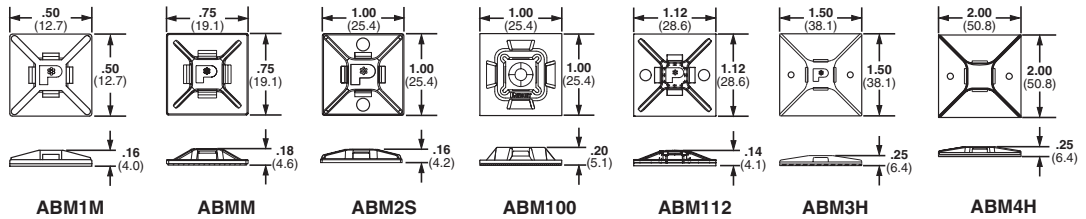

C1. Wiring Duct

C2. Surface Raceway

C3. Abrasion Protection

C4. Cable Management

D1. Terminals

D2. Power Connectors

D3. Grounding Connectors

E1. Labeling Systems

E2. Labels

E3. Pre-Printed & Write-On Markers

E4. Permanent Identification

E5. Lockout/Tagout & Safety Solutions

F. Index

| Part Number | Used with Cable Ties‡ | Material | Color | Environment | Mounting Method* | Max. Static Load | | Std. Pkg. Qty. | Std. Ctn. Qty. |
|-----------------------------------|-----------------------------|-----------------------------|--------------------|--------------------|------------------|------------------|-------|----------------|----------------|
| | | | | | | Lbs. | g | | |
| 4-Way Mounts with Adhesive | | | | | | | | | |
| ABM1M-A-C | M | Nylon 6.6 | White | Indoors | Rubber | .13 | 59.0 | 100 | 500 |
| ABM1M-AT-C | | Nylon 6.6 | White | Indoors/High Temp | Acrylic | .13 | 59.0 | 100 | 500 |
| ABMM-A-C | M, I | ABS | White | Indoors | Rubber | .30 | 136.0 | 100 | 500 |
| ABMM-AT-C | | ABS | White | Indoors/High Temp | Acrylic | .30 | 136.0 | 100 | 500 |
| ABMM-AT-C0 | | Weather Resistant ABS | Black | Outdoors/High Temp | Acrylic | .30 | 136.0 | 100 | 500 |
| ABM2S-A-C | | ABS | White | Indoors | Rubber | .50 | 227.0 | 100 | 500 |
| ABM2S-A-C14 | M, I, S | ABS | Gray | Indoors | Rubber | .50 | 227.0 | 100 | 500 |
| ABM2S-A-C15 | | ABS | Ivory | Indoors | Rubber | .50 | 227.0 | 100 | 500 |
| ABM2S-AT-C | | ABS | White | Indoors/High Temp | Acrylic | .50 | 227.0 | 100 | 500 |
| ABM2S-AT-C0 | | Weather Resistant ABS | Black | Outdoors/High Temp | Acrylic | .50 | 227.0 | 100 | 500 |
| ABM100-A-C | | Nylon 6.6 | White | Indoors | Rubber | .50 | 227.0 | 100 | 1000 |
| ABM100-A-C15 | | Nylon 6.6 | Ivory | Indoors | Rubber | .50 | 227.0 | 100 | 1000 |
| ABM100-AT-C | | Nylon 6.6 | White | Indoors/High Temp | Acrylic | .50 | 227.0 | 100 | 1000 |
| ABM100-AT-C0 | | Weather Resistant Nylon 6.6 | Black | Outdoors/High Temp | Acrylic | .50 | 227.0 | 100 | 1000 |
| ABM112-A-C | | Nylon 6.6 | White | Indoors | Rubber | .63 | 286.0 | 100 | 500 |
| ABM112-AT-C | | Nylon 6.6 | White | Indoors/High Temp | Acrylic | .63 | 286.0 | 100 | 1000 |
| ABM112-AT-C0 | Weather Resistant Nylon 6.6 | Black | Outdoors/High Temp | Acrylic | .63 | 286.0 | 100 | 1000 | |
| ABM3H-A-L | M, I, S, HS, LH, H, HLM | Nylon 6.6 | White | Indoors | Rubber | 1.12 | 513.0 | 50 | 500 |
| ABM3H-AT-L | | Nylon 6.6 | White | Indoors/High Temp | Acrylic | 1.12 | 513.0 | 50 | 500 |
| ABM4H-A-L | | Nylon 6.6 | White | Indoors | Rubber | 2.00 | 907.0 | 50 | 500 |
| ABM4H-AT-L | | Nylon 6.6 | White | Indoors/High Temp | Acrylic | 2.00 | 907.0 | 50 | 500 |

‡Cable tie cross section sizes: M = Miniature, I = Intermediate, S = Standard, HS = Heavy-Standard, LH = Light-Heavy, H = Heavy, and HLM = Miniature TAK-TY® Hook & Loop Ties.

*For proper selection of adhesives see page B2.52

4-Way Adhesive Backed Cable Tie Mounts (continued)

| Part Number | Used with Cable Ties‡ | Material | Color | Environment | Mounting Method* | Max. Static Load | | Std. Pkg. Qty. | Std. Ctn. Qty. | |
|--------------------------------------|-----------------------|---------------------------|-----------|-------------|--|--|---|----------------|----------------|------|
| | | | | | | Lbs. | g | | | |
| 4-Way Mounts without Adhesive | | | | | | | | | | |
| ABMM-D | M, I | ABS | White | Indoors | User Supplied Adhesive | — | — | 500 | 5000 | |
| ABM2S-S6-D | M, I, S | ABS | White | Indoors | User supplied adhesive and/or two #6 (M3) Screws | — | — | 500 | 5000 | |
| ABM100-S6-C | | Nylon 6.6 | White | Indoors | | — | — | 100 | 1000 | |
| ABM100-S6-C69 | | Flame Retardant Nylon 6.6 | Natural | Indoors | User Supplied Adhesive and/or #6 (M3) Screw | — | — | 100 | 1000 | |
| ABM112-S6-C | | Nylon 6.6 | White | Indoors | User Supplied Adhesive and/or Two #6 (M3) Screws | — | — | 100 | 1000 | |
| ABM112-S6-C69 | | Flame Retardant Nylon 6.6 | Natural | Indoors | | — | — | 100 | 500 | |
| ABM3H-S6-T | | M, I, S, HS, LH, H, HLM | Nylon 6.6 | White | Indoors | User Supplied Adhesive and/or Two #6 (M3) Screws | — | — | 200 | 2000 |
| ABM4H-S6-T | | | Nylon 6.6 | White | Indoors | | — | — | 200 | 1000 |

‡Cable tie cross section sizes: M = Miniature, I = Intermediate, S = Standard, HS = Heavy-Standard, LH = Light-Heavy, H = Heavy, and HLM = Miniature TAK-TY® Hook & Loop Ties.

*For proper selection of adhesives see page B2.52

A.
System
Overview

B1.
Cable Ties

B2.
Cable
Accessories

B3.
Stainless
Steel Ties

C1.
Wiring
Duct

C2.
Surface
Raceway

C3.
Abrasion
Protection

C4.
Cable
Management

D1.
Terminals

D2.
Power
Connectors

D3.
Grounding
Connectors

E1.
Labeling
Systems

E2.
Labels

E3.
Pre-Printed
& Write-On
Markers

E4.
Permanent
Identification

E5.
Lockout/
Tagout/
& Safety
Solutions

F.
Index

A.
System
Overview

ABMQ Multiple Bridge Mounts

B1.
Cable Ties

B2.
Cable
Accessories

B3.
Stainless
Steel Ties

C1.
Wiring
Duct

C2.
Surface
Raceway

C3.
Abrasion
Protection

C4.
Cable
Management

D1.
Terminals

D2.
Power
Connectors

D3.
Grounding
Connectors

E1.
Labeling
Systems

E2.
Labels

E3.
Pre-Printed
& Write-On
Markers

E4.
Permanent
Identification

E5.
Lockout/
Tagout/
& Safety
Solutions

F.
Index

- Multiple cable tie bridges on one mount speeds installation of cable bundles by reducing the number of mounts applied
- Dovetail connection system provides alignment and a joining method to expand routing capabilities
- V-groove allows for easy separation into two mounts with two bridges each for separate applications

- 4-way cable tie bridges allow cable bundles to be secured perpendicular to the mount for even spacing or inline to secure a bundle in multiple places
- Large adhesive surface area provides long-term reliability and keeps product in place despite heavy load or high stress

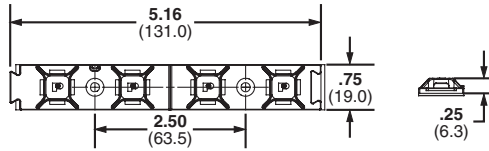

| Part Number | Used with Cable Ties‡ | Material | Color | Environment | Mounting Method | Max. Static Load | | Std. Pkg. Qty. | Std. Ctn. Qty. |
|-------------------------------------|-----------------------|-----------------------|-------|--------------------|--|------------------|-------|----------------|----------------|
| | | | | | | Lbs. | g | | |
| ABMQ Mounts with Adhesive | | | | | | | | | |
| ABMQS-A-Q | M, I, S | ABS | White | Indoors | Rubber | 1.85 | 838.0 | 25 | 250 |
| ABMQS-A-Q20 | | ABS | Black | Indoors | Rubber | | | 25 | 250 |
| ABMQS-AT-Q | | ABS | White | Indoors/High Temp | Acrylic | | | 25 | 250 |
| ABMQS-AT-Q0 | | Weather Resistant ABS | Black | Outdoors/High Temp | Acrylic | | | 25 | 250 |
| ABMQ Mounts without Adhesive | | | | | | | | | |
| ABMQS-S6-C0 | M, I, S | Weather Resistant ABS | Black | Outdoors/High Temp | User Supplied Adhesive and/or two #6 M3 Screws | — | — | 100 | 1000 |
| ABMQS-S6-C | | ABS | White | Indoors/High Temp | | | | 100 | 1000 |

‡Cable tie cross section sizes: M = Miniature, I = Intermediate, and S = Standard.

® SUPER-GRIP® Adhesive Back Mounts

- Low profile design keeps bundle close to mounting surface
- Small overall size allows use where space is limited

- For use with SUPER-GRIP® Cable Ties found on page B1.38

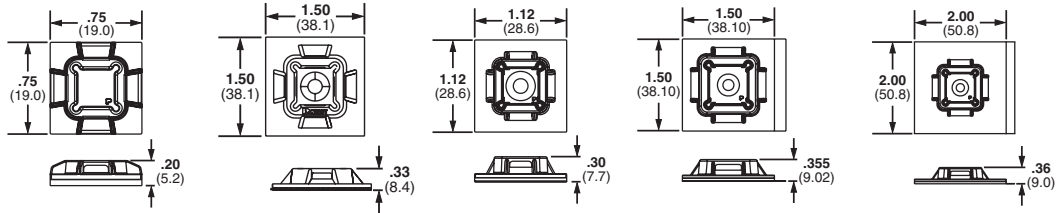

| Part Number | Used with Cable Ties‡ | Material | Color | Environment | Mounting Method* | Max. Static Load | | Std. Pkg. Qty. | Std. Ctn. Qty. |
|-------------------------------|--------------------------|-----------------------------|-------|--------------------|---|------------------|------|----------------|----------------|
| | | | | | | Lbs. | g | | |
| Adhesive Backed Mounts | | | | | | | | | |
| SGABM20-A-C | SGM, SGI | Nylon 6.6 | White | Indoor Use | Rubber | .28 | 127 | 100 | 500 |
| SGABM20-AT-C0 | | Weather Resistant Nylon 6.6 | Black | Outdoors/High Temp | Acrylic | .28 | 127 | 100 | 500 |
| SGABM25-A-C | SGM, SGI, SGS | Nylon 6.6 | White | Indoor Use | Rubber | .50 | 227 | 100 | 1000 |
| SGABM25-AT-C0 | | Weather Resistant Nylon 6.6 | Black | Outdoors/High Temp | Acrylic | .50 | 227 | 100 | 1000 |
| SGABM30-A-C | | Nylon 6.6 | White | Indoor Use | Rubber | .63 | 286 | 100 | 500 |
| SGABM30-AT-C0 | | Weather Resistant Nylon 6.6 | Black | Outdoors/High Temp | Acrylic | .63 | 286 | 100 | 500 |
| SGABM40-A-L | SGM, SGI, SGS, SGLH, SGH | Nylon 6.6 | White | Indoor Use | Rubber | 1.13 | 51.3 | 50 | 500 |
| SGABM40-AT-L0 | | Weather Resistant Nylon 6.6 | Black | Outdoors/High Temp | Acrylic | 1.13 | 51.3 | 50 | 500 |
| SGABM50-A-L | | Nylon 6.6 | White | Indoor Use | Rubber | 2.00 | 907 | 50 | 500 |
| SGABM50-AT-L0 | | Weather Resistant Nylon 6.6 | Black | Outdoors/High Temp | Acrylic | 2.00 | 907 | 50 | 500 |
| Adhesive Backed Mounts | | | | | | | | | |
| SGABM25-S6-C | SGM, SGI, SGS | Nylon 6.6 | White | Indoors | #6 (M3) Screw | — | — | 100 | 1000 |
| SGABM25-S6-C0 | | Weather Resistant Nylon 6.6 | Black | Outdoors | User Supplied Adhesive and/or #6 (M3) Screw | — | — | 100 | 1000 |

‡Cable tie cross section sizes: SGM = SUPER-GRIP® Miniature, SGI = SUPER-GRIP® Intermediate, SGS = SUPER-GRIP® Standard, SGLH = SUPER-GRIP® Light-Heavy, and SGH = SUPER-GRIP® Heavy.

*For proper selection of adhesive see page B2.52

A.
System
Overview

B1.
Cable Ties

B2.
Cable
Accessories

B3.
Stainless
Steel Ties

C1.
Wiring
Duct

C2.
Surface
Raceway

C3.
Abrasion
Protection

C4.
Cable
Management

D1.
Terminals

D2.
Power
Connectors

D3.
Grounding
Connectors

E1.
Labeling
Systems

E2.
Labels

E3.
Pre-Printed
& Write-On
Markers

E4.
Permanent
Identification

E5.
Lockout/
Tagout
& Safety
Solutions

F.
Index

A. System Overview

Combination Adhesive Mount/Cable Ties

B1. Cable Ties

- Adhesive mount and cable tie molded as one-piece helps reduce inventory costs
- Available with locking or releasable tie
- For indoor use only
- Material: Nylon 6.6

B2. Cable Accessories



B3. Stainless Steel Ties

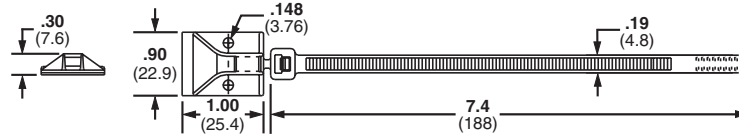

C1. Wiring Duct

C2. Surface Raceway

C3. Abrasion Protection

C4. Cable Management

D1. Terminals

D2. Power Connectors

D3. Grounding Connectors

E1. Labeling Systems

E2. Labels

E3. Pre-Printed & Write-On Markers

E4. Permanent Identification

E5. Lockout/Tagout & Safety Solutions

F. Index

| Part Number | Tool | Color | Adhesive Type | Max. Static Load | | Std. Pkg. Qty. | Std. Ctn. Qty. |
|-----------------------------|---|-------|---------------|------------------|-------|----------------|----------------|
| | | | | Lbs. | g | | |
| Locking Cable Tie | | | | | | | |
| PLA2S-A-Q | GTS, GTSL, GS2B, GS4H, PTS, PTH, PPTS, STS2, STH2 | White | Rubber | .45 | 204.0 | 25 | 250 |
| Releasable Cable Tie | | | | | | | |
| PRA2S-A-Q | Hand installed only | White | Rubber | .45 | 204.0 | 25 | 250 |

Snap-In Cable Tie Mounts – Mechanically Applied

- For use with *PANDUIT* Standard cross section cable ties including PLT1S, PLT1.5S, PLT2S, PRT1.5S and PRT2S
- Integral retaining notch holds cable tie head in place below bundle
- Eliminates protruding tie head and facilitates one hand tie threading
- Quickly route wire and cable where mounting holes cannot be drilled
- For indoor use only
- Material: ABS

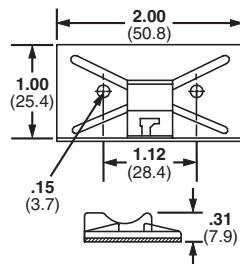

| Part Number | Used with Cable Ties‡ | Color | Mounting Method | Max. Static Load | | Std. Pkg. Qty. | Std. Ctn. Qty. |
|------------------------|-----------------------|-------|--|------------------|-------|----------------|----------------|
| | | | | Lbs. | g | | |
| Adhesive Backed | | | | | | | |
| SMS-A-C | S | White | Rubber | 1.0 | 454.0 | 100 | 500 |
| SMS-A-C14 | | Gray | Rubber | 1.0 | 454.0 | 100 | 500 |
| SMS-A-C15 | | Ivory | Rubber | 1.0 | 454.0 | 100 | 500 |
| Screw Mount | | | | | | | |
| SMS-S6-D | S | White | User Supplied Adhesive and/or Two #6 M3 Screws | — | — | 500 | 5000 |

‡Cable tie cross section size: S = Standard.

Epoxy Applied Mounts

- Provide a fast, strong, economical method to secure wire/cable to most surfaces
- Eliminate the need to drill holes

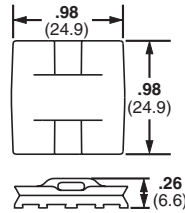

| Part Number | Used with Cable Ties‡ | Material | Color | Environment | Mounting Method | Max. Static Load | | Std. Pkg. Qty. | Std. Ctn. Qty. |
|-------------|-----------------------|-----------------------------|---------|-------------|-----------------|------------------|------|----------------|----------------|
| | | | | | | Lbs. | g | | |
| EMS-A-C | M, I, S | Nylon 6.6 | Natural | Indoors | EMA epoxy | 10.0 | 4540 | 100 | 1000 |
| EMS-A-C0 | | Weather Resistant Nylon 6.6 | Black | Outdoors | | | | | |

‡Cable tie cross section sizes: M = Miniature, I = Intermediate, and S = Standard.

Epoxy Applied Swivel Mount

- Swivels 360° to assure proper orientation with harness
- For indoor use only
- Four inspection holes to check adhesive coverage

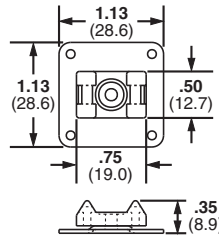

| Part Number | Used with Cable Ties‡ | Mounting Method | Max. Static Load | | Std. Pkg. Qty. | Std. Ctn. Qty. |
|-------------|-----------------------|-----------------|------------------|------|----------------|----------------|
| | | | Lbs. | g | | |
| ASMS-A-X | M, I, S, SGM, SGI | EMA epoxy | 10.0 | 4540 | 10 | 100 |

‡Cable tie cross section sizes: M = Miniature, I = Intermediate, S = Standard, SGM = SUPER-GRIP® Miniature, and SGI = SUPER-GRIP® Intermediate.

A.
System
Overview

B1.
Cable Ties

B2.
Cable
Accessories

B3.
Stainless
Steel Ties

C1.
Wiring
Duct

C2.
Surface
Raceway

C3.
Abrasion
Protection

C4.
Cable
Management

D1.
Terminals

D2.
Power
Connectors

D3.
Grounding
Connectors

E1.
Labeling
Systems

E2.
Labels

E3.
Pre-Printed
& Write-On
Markers

E4.
Permanent
Identification

E5.
Lockout/
Tagout/
& Safety
Solutions

F.
Index

A.
System
Overview

Epoxy Applied Cable Tie Mount Kits

B1.
Cable Ties

- EMA Epoxy supplied in convenient two-compartment mixer cup with a mixer stick for each cup
- Each cup contains adhesive for three EMS or ASMS mounts
- Epoxy hardens in approximately five minutes
- After full 24 hour cure time, bonding strength will exceed 50 lbs. on a clean, grease-free surface
- Not recommended for use on polyethylene and polypropylene surfaces

B2.
Cable
Accessories

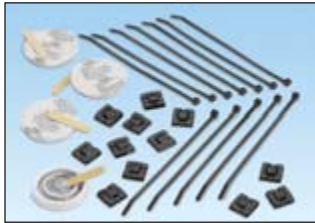

B3.
Stainless
Steel Ties

| Part Number | Used with Cable Ties‡ | Environment | Epoxy Cups | Mixer Sticks | EMS Mounts | Cable Ties | Std. Pkg. Qty. | Std. Ctn. Qty. |
|--|-----------------------|------------------|------------|--------------|------------|------------|----------------|----------------|
| Epoxy Adhesive Only | | | | | | | | |
| EMA-X | — | Indoors/Outdoors | 10 | 10 | — | — | 10 | — |
| Epoxy Mounting Kit with EMS Mounts | | | | | | | | |
| EMSK3-1-X0 | M, I, S | Indoors/Outdoors | 1 | 1 | 3 | — | 10 | — |
| Epoxy Mounting Kit with EMS Mounts and Cable Ties | | | | | | | | |
| EMSK3-1-3-0 | M, I, S | Indoors/Outdoors | 1 | 1 | 3 | 3 | 1 | 10 |
| EMSK12-4-12-X0 | | Indoors/Outdoors | 4 | 4 | 12 | 12 | 10 | 10 |

‡Cable tie cross section sizes: M = Miniature, I = Intermediate, and S = Standard.

C1.
Wiring
Duct

C2.
Surface
Raceway

C3.
Abrasion
Protection

C4.
Cable
Management

D1.
Terminals

D2.
Power
Connectors

D3.
Grounding
Connectors

E1.
Labeling
Systems

E2.
Labels

E3.
Pre-Printed
& Write-On
Markers

E4.
Permanent
Identification

E5.
Lockout/
Tagout/
& Safety
Solutions

F.
Index

Cable Tie Mounts

- Unique cradle design provides maximum stability for the cable bundle
- Low profile design keeps bundle close to mounting surface
- For indoor use only
- Material: Nylon 6.6

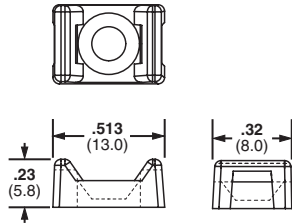

TM1

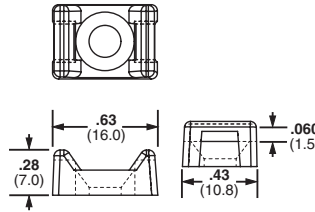

TM2

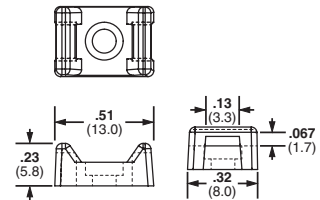

TM3



| Part Number | Used with Cable Ties* | Counterbore Diameter | | Mounting Method | Std. Pkg. Qty. | Std. Ctn. Qty. |
|-------------|-----------------------|----------------------|-----|-----------------|----------------|----------------|
| | | In. | mm | | | |
| TM1S4-M69 | M | .23 | 5.7 | #4 (M2.5) screw | 1000 | 5000 |
| TM1S6-M69 | | .28 | 7.0 | #6 (M3) screw | 1000 | 5000 |
| TM2S6-M69 | M, I, S | .29 | 7.1 | #6 (M3) screw | 1000 | 5000 |
| TM2S8-M69 | | .33 | 8.4 | #8 (M4) screw | 1000 | 5000 |
| TM3S8-C69 | M, I, S, LH | .32 | 8.1 | #8 (M4) screw | 100 | 500 |
| TM3S10-M69 | | .38 | 9.7 | #10 (M5) screw | 1000 | 5000 |

‡Cable tie cross section sizes: M = Miniature, I = Intermediate, S = Standard, and LH = Light-Heavy.

Additional tie mounts available in specified materials. All are available as standard PANDUIT parts.

| Heat Stabilized Nylon | Flame Retardant Nylon | Weather Resistant Nylon | Weather Resistant Polypropylene | TEFZEL [®] |
|-----------------------|-----------------------|-------------------------|---------------------------------|---------------------|
| TM1S4-M30 | TM1S4-M69 | TM1S6-M0 | TM2S8-C100 | TM2S8-C76 |
| TM1S6-M30 | TM1S6-M69 | TM2R6-M0 | TM3S8-C100 | TM3S8-C76 |
| TM2R6-M30 | TM2S6-M69 | TM2S6-M0 | TM3S8-M100 | TM3S10-C76 |
| TM2S6-M30 | TM2S8-M69 | TM2S8-M0 | | |
| TM2S8-M30 | TM3S8-C69 | TM3R6-M0 | | |
| TM3S8-M30 | TM3S8-M69 | TM3S10-M0 | | |
| TM3S10-M30 | TM3S10-M69 | TM3S25-M0 | | |
| TM3S25-M30 | | | | |

‡TEFZEL is a registered trademark of E.I. du Pont de Nemours and Company.

A.
System
Overview

B1.
Cable Ties

B2.
Cable
Accessories

B3.
Stainless
Steel Ties

C1.
Wiring
Duct

C2.
Surface
Raceway

C3.
Abrasion
Protection

C4.
Cable
Management

D1.
Terminals

D2.
Power
Connectors

D3.
Grounding
Connectors

E1.
Labeling
Systems

E2.
Labels

E3.
Pre-Printed
& Write-On
Markers

E4.
Permanent
Identification

E5.
Lockout/
Tagout
& Safety
Solutions

F.
Index

A. System Overview

TAK-TY® Hook & Loop Cable Tie Mounts

- For use with TAK-TY® Hook & Loop Cable Ties, see page B1.87
- Unique cradle design provides maximum stability for cable bundle
- For indoor use only
- Dimensions: 1.10L x 1.10W x .34H (27.9mm x 27.9mm x 8.6mm)

B1. Cable Ties

B2. Cable Accessories



B3. Stainless Steel Ties

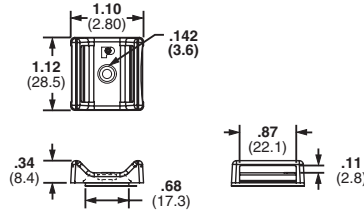

C1. Wiring Duct

C2. Surface Raceway

C3. Abrasion Protection

C4. Cable Management

| Part Number | Used with Cable Ties‡ | Material | Color | Max. Static Load | | Mounting Method* | Std. Pkg. Qty. | Std. Ctn. Qty. |
|--------------------|---------------------------|-----------|---------|------------------|-----|------------------|----------------|----------------|
| | | | | Lbs. | g | | | |
| ABMT-A-C | HLT | Nylon 6.6 | Natural | .38 | 174 | Rubber | 100 | 1000 |
| ABMT-A-C20 | | | Black | | | | 100 | 1000 |
| ABMT-S6-C | | | Natural | — | — | #6 (M3) Screw | 100 | 1000 |
| ABMT-S6-C20 | | Black | 100 | | | | 1000 | |
| ABMT-S6-C60 | | Black | 100 | | | | 1000 | |
| ABMT-S6-C69 | Flame Retardant Nylon 6.6 | Natural | 100 | 1000 | | | | |

‡Cable tie cross section sizes: HLT/HLS = TAK-TY® Hook & Loop Ties.
*For proper selection of adhesives see page B2.52

D1. Terminals

Extra-Heavy Cable Tie Mounts

- Unique cradle design provides maximum stability for cable bundle
- Route and support large diameter and heavy cable bundles

D2. Power Connectors

D3. Grounding Connectors



E1. Labeling Systems

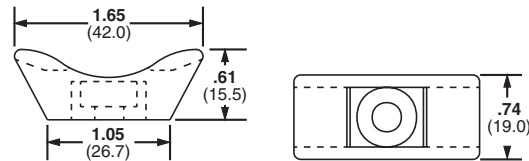

E2. Labels

E3. Pre-Printed & Write-On Markers

E4. Permanent Identification

E5. Lockout/Tagout & Safety Solutions

F. Index

| Part Number | Used with Cable Ties‡ | Material | Color | Environment | Mounting Method | Std. Pkg. Qty. | Std. Ctn. Qty. |
|----------------------|-----------------------------|---------------------------------|-------|-------------|-----------------|----------------|----------------|
| TMEH-S8-Q0 | M, I, S, HS, LH, H, EH, HLM | Weather Resistant Nylon 6.6 | Black | Outdoors | #8 (M4) Screw | 25 | 250 |
| TMEH-S10-Q0 | | | | | #10 (M5) Screw | 25 | 250 |
| TMEH-S25-Q0 | | | | | 1/4 (M6) Screw | 25 | 250 |
| TMEH-S10-C100 | | Weather Resistant Polypropylene | Green | Indoors | #10 (M5) Screw | 100 | 500 |
| TMEH-S10-C109 | | Polypropylene | | | #10 (M5) Screw | 100 | 500 |

‡Cable tie cross section sizes: M = Miniature, I = Intermediate, S = Standard, HS = Heavy-Standard, LH = Light-Heavy, H = Heavy, EH = Extra-Heavy and HLM = Miniature TAK-TY® Hook & Loop Ties.

TM Tie Mounts – Applied with User Supplied Adhesives

- Solid flat bottom surface provides maximum holding area
- For indoor use only
- Material: Nylon 6.6



| Part Number | Used with Cable Ties‡ | Color | Mounting Method | Std. Pkg. Qty. | Std. Ctn. Qty. |
|-------------|-----------------------|---------|------------------------|----------------|----------------|
| TM1A-C | M | Natural | User Supplied Adhesive | 100 | 1000 |
| TM2A-C | M, I, S | | | 100 | 500 |
| TM3A-C | M, I, S, HS, LH | | | 100 | 500 |

‡Cable tie cross section sizes: M = Miniature, I = Intermediate, S = Standard, HS = Heavy Standard and LH = Light-Heavy.

AM Low Profile Tie Mounts – User Supplied Adhesive Mounts

- Low profile design keeps bundle close to mounting surface
- For indoor use only
- Material: Nylon 6.6

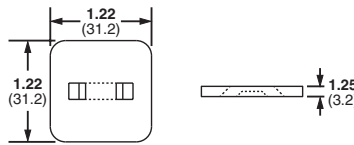

| Part Number | Used with Cable Ties‡ | Color | Mounting Method | Std. Pkg. Qty. | Std. Ctn. Qty. |
|-------------|-----------------------|---------|------------------------|----------------|----------------|
| AM2-C | M, I, S | Natural | User Supplied Adhesive | 100 | 500 |

‡Cable tie cross section sizes: M = Miniature, I = Intermediate, and S = Standard.

Swivel Mounts

- The two mounts are securely fastened together with a connecting rivet that allows both mounts to rotate
- Can join bundles of cable, tubing, or hoses that may need to move or are not parallel
- Separates bundles to avoid abrasion
- Material: Weather Resistant Nylon 6.6

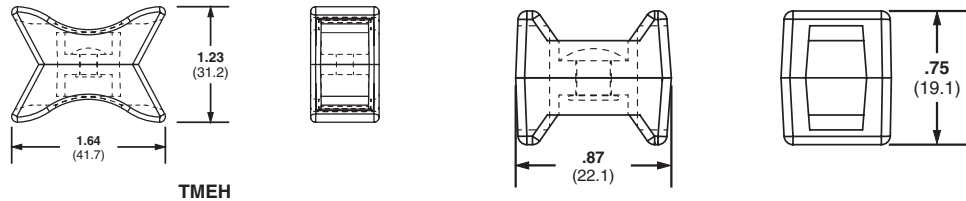

| Part Number | Used with Cable Ties‡ | Pull Apart Force | | Color | Environment | Std. Pkg. Qty. | Std. Ctn. Qty. |
|-------------|-----------------------------|------------------|---------|-------|------------------|----------------|----------------|
| | | Lbs. | g | | | | |
| TM3-X2-C0Y | M, I, S, HS, LH | 120 | 54,431 | Black | Indoors/Outdoors | 100 | 1000 |
| TMEH-X2-L0Y | M, I, S, HS, LH, H, EH, HLM | 250 | 113,398 | | | 50 | 500 |

‡Cable tie cross section sizes: M = Miniature, I = Intermediate, S = Standard, HS = Heavy-Standard, LH = Light-Heavy, H = Heavy, EH = Extra-Heavy and HLM = Miniature *TAK-TY*® Hook & Loop Ties.

A. System Overview

Stud Tie Mounts

B1. Cable Ties

- Easily applied to bolts or studs with a light hammer blow or turning of the mount
- Material: Impact Modified Weather Resistant Nylon 6.6
- Designed for use with cable ties to route and secure cable bundles, air, water and hydraulic lines

B2. Cable Accessories



B3. Stainless Steel Ties

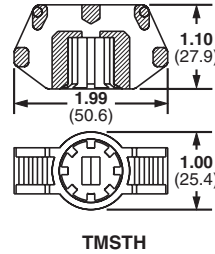
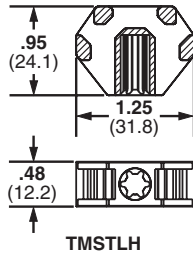

C1. Wiring Duct

C2. Surface Raceway

C3. Abrasion Protection

C4. Cable Management

| Part Number | Used with Cable Ties‡ | Color | Environment | Mounting Method | Std. Pkg. Qty. | Std. Ctn. Qty. |
|-------------|-----------------------|-------|-------------|-----------------------|----------------|----------------|
| TMSTLHS6-M0 | M, I, S, HS, LH | Black | Outdoors | 1/4" stud dia. (6mm) | 1000 | 5000 |
| TMSTLHS8-M0 | M, I, S, HS, LH | | | 5/16" stud dia. (8mm) | 1000 | 5000 |
| TMSTHS10-D0 | M, I, S, HS, LH, H | | | 3/8" stud dia. (10mm) | 500 | — |
| TMSTHS13-D0 | M, I, S, HS, LH, H | | | 1/2" stud dia. (13mm) | 500 | — |
| TMSTHS16-D0 | M, I, S, HS, LH, H | | | 5/8" stud dia. (16mm) | 500 | — |
| TMSTHS19-D0 | M, I, S, HS, LH, H | | | 3/4" stud dia. (19mm) | 500 | — |

‡Cable tie cross section sizes: M = Miniature, I = Intermediate, S = Standard, HS = Heavy Standard, LH = Light-Heavy and H = Heavy.

D1. Terminals

Tie Anchor Mounts – Screw Applied

- 4-way cable tie entry makes part orientation fast and easy
- Small overall size allows for use where space is limited

D2. Power Connectors

D3. Grounding Connectors

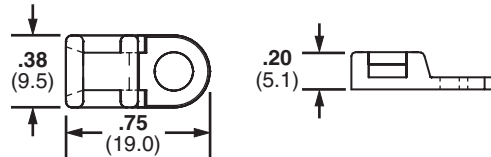

E1. Labeling Systems

E2. Labels

E3. Pre-Printed & Write-On Markers

E4. Permanent Identification

E5. Lockout/Tagout & Safety Solutions

F. Index

| Part Number | Used with Cable Ties‡ | Hole Diameter | | Material | Color | Environment | Mounting Method | Std. Pkg. Qty. | Std. Ctn. Qty. |
|-------------|-----------------------|---------------|-----|-----------------------------|-----------|-------------|-----------------|----------------|----------------|
| | | In. | mm | | | | | | |
| TA1S8-C | M, I, S | .17 | 4.3 | Nylon 6.6 | Natural | Indoors | #8 (M4) Screw | 100 | 500 |
| TA1S8-M0 | | .17 | 4.3 | Weather Resistant Nylon 6.6 | Black | Outdoors | #8 (M4) Screw | 1000 | 5000 |
| TA1S8-M30 | | .17 | 4.3 | Heat Stabilized Nylon 6.6 | Black | Indoors | #8 (M4) Screw | 1000 | 5000 |
| TA1S8-M69 | | .17 | 4.3 | Flame Retardant Nylon 6.6 | Natural | Indoors | #8 (M4) Screw | 1000 | 5000 |
| TA1S10-C | | .17 | 4.3 | Nylon 6.6 | Natural | Indoors | #10 (M5) Screw | 100 | 500 |
| TA1S10-M0 | | .20 | 5.1 | Weather Resistant Nylon 6.6 | Black | Outdoors | #10 (M5) Screw | 1000 | 5000 |
| SGTA1S8-C | | SGM, SGI, SGS | .17 | 4.3 | Nylon 6.6 | Natural | Indoors | #8 (M4) Screw | 100 |

‡Cable tie cross section sizes: M = Miniature, I = Intermediate, S = Standard, SGM = SUPER-GRIP® Miniature, SGI = SUPER-GRIP® Intermediate and SGS = SUPER-GRIP® Standard.

Tie Anchor Mounts

- Install perpendicular to the wire bundle
- Elongated slot permits cable bundle adjustment in application

- Low profile design keeps bundle close to mounting surface where overhead space is limited
- Material: Nylon 6.6

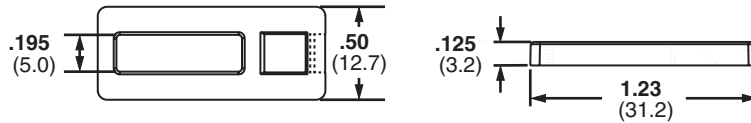
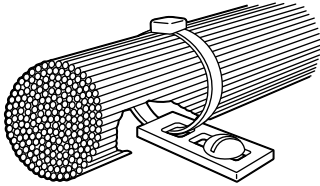

| Part Number | Used with Cable Ties‡ | Color | Environment | Mounting Method | Std. Pkg. Qty. | Std. Ctn. Qty. |
|-------------|-----------------------|---------|-------------|-----------------|----------------|----------------|
| TA2-C | M, I, S | Natural | Indoors | #10 (M5) Screw | 100 | 1000 |
| TA2-M | | | | | 1000 | 5000 |

‡Cable tie cross section sizes: M = Miniature, I = Intermediate, and S = Standard.

Low Profile Mounts – Screw Applied

- Low profile design keeps bundle close to mounting surface
- Small overall size
- Install with a screw or rivet for a strong, secure installation

- For indoor use only
- Material: Nylon 6.6

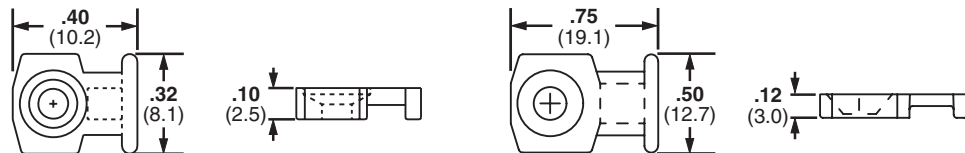

LPMM

| Part Number | Used with Cable Ties‡ | Color | Mounting Method | Std. Pkg. Qty. | Std. Ctn. Qty. |
|-------------|-----------------------|---------|---------------------------|----------------|----------------|
| LPMM-S2-C | M | Natural | #2 (M2) Countersunk Screw | 100 | 1000 |
| LPMM-S5-C | M | | #5 (M3) Countersunk Screw | 100 | 1000 |
| LPMS-S8-C | M, I, S | | #8 (M4) Countersunk Screw | 100 | 1000 |

‡Cable tie cross section sizes: M = Miniature, I = Intermediate, and S = Standard.

HYPER-V™ Cable Tie Mounts

- Tie mount has retaining tab within window to hold cable tie in position when pre-installed in the mount; low profile design keeps bundle close to mounting surface

- For use with *HYPER-V™* Cable Ties on page B1.62
- For outdoor use
- Material: Weather Resistant Nylon 6.6

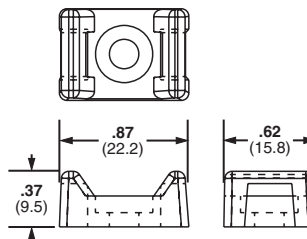

| Part Number | Used with Cable Ties‡ | Color | Mounting Method | Std. Pkg. Qty. | Std. Ctn. Qty. |
|-------------|-----------------------|-------|-----------------|----------------|----------------|
| HVTM3S10-C0 | HV | Black | #10 (6mm) Screw | 100 | 500 |

‡Cable tie cross section size: HV = *HYPER-V™* Cable tie.

A.
System
Overview

B1.
Cable Ties

B2.
Cable
Accessories

B3.
Stainless
Steel Ties

C1.
Wiring
Duct

C2.
Surface
Raceway

C3.
Abrasion
Protection

C4.
Cable
Management

D1.
Terminals

D2.
Power
Connectors

D3.
Grounding
Connectors

E1.
Labeling
Systems

E2.
Labels

E3.
Pre-Printed
& Write-On
Markers

E4.
Permanent
Identification

E5.
Lockout/
Tagout/
& Safety
Solutions

F.
Index

A. System Overview

SUPER-GRIP® Tie Mounts

- Unique cradle design provides maximum stability for the cable bundle
- Low profile design keeps bundle close to mounting surface

- SUPER-GRIP® Cable Ties on page B1.38
- For indoor use only

B1. Cable Ties

B2. Cable Accessories



B3. Stainless Steel Ties

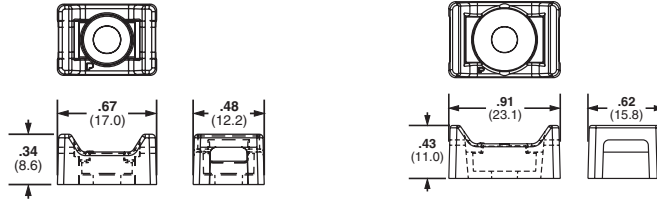

C1. Wiring Duct

C2. Surface Raceway

C3. Abrasion Protection

C4. Cable Management

| Part Number | Used with Cable Ties‡ | Material | Color | Mounting Method | Std. Pkg. Qty. | Std. Ctn. Qty. |
|-------------|-----------------------|-----------------------------|---------|-----------------|----------------|----------------|
| SGTM1S6-C | SGM | Nylon 6.6 | Natural | #6 (M3) Screw | 100 | 500 |
| SGTM1S6-C0 | SGM | Weather Resistant Nylon 6.6 | Black | #6 (M3) Screw | 100 | 500 |
| SGTM2S8-C | SGM, SGI, SGS | Nylon 6.6 | Natural | #8 (M4) Screw | 100 | 500 |
| SGTM2S8-C0 | SGM, SGI, SGS | Weather Resistant Nylon 6.6 | Black | #8 (M4) Screw | 100 | 500 |
| SGTM3S10-C | SGM, SGI, SGS, SGLH | Nylon 6.6 | Natural | #10 (M5) Screw | 100 | 500 |
| SGTM3S10-C0 | SGM, SGI, SGS, SGLH | Weather Resistant Nylon 6.6 | Black | #10 (M5) Screw | 100 | 500 |

‡Cable tie cross section sizes: SGM = SUPER-GRIP® Miniature, SGI = SUPER-GRIP® Intermediate, SGS = SUPER-GRIP® Standard and SGLH = SUPER-GRIP® Light-Heavy.

D1. Terminals

Low Profile Mounts – Push Rivet Applied

- Eliminate screws
- Secure wires to any pre-drilled panel
- Can be installed in any panel thickness

- Low profile design keeps bundle close to mounting surface
- For indoor use only
- Material: Nylon 6.6

D2. Power Connectors

D3. Grounding Connectors



E1. Labeling Systems

E2. Labels

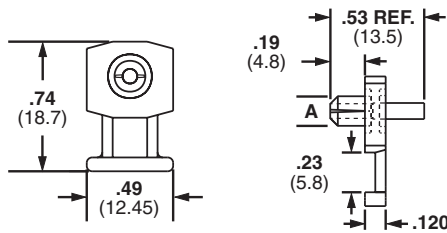

E3. Pre-Printed & Write-On Markers

E4. Permanent Identification

E5. Lockout/Tagout & Safety Solutions

F. Index

| Part Number | Used with Cable Ties‡ | Hole Diameter A | | Color | Mounting Method | Std. Pkg. Qty. | Std. Ctn. Qty. |
|--------------|-----------------------|-----------------|-----|--------|---------------------|----------------|----------------|
| | | In. | mm | | | | |
| KIMS-H366-C2 | M, I, S | .144 | 3.7 | Red | Integral Push Rivet | 100 | 1000 |
| KIMS-H430-C6 | | .169 | 4.3 | Blue | Integral Push Rivet | 100 | 1000 |
| KIMS-H500-C4 | | .196 | 5.0 | Yellow | Integral Push Rivet | 100 | 1000 |

‡Cable tie cross section sizes: M = Miniature, I = Intermediate, and S = Standard.

Cable Tie Plates

- Slotted mounting hole accommodates various fastener spacing
- Low profile design keeps bundle close to mounting surface
- For indoor use only
- Material: Nylon 6.6

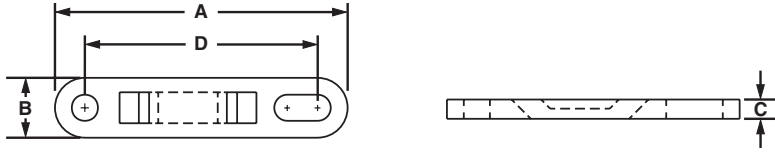
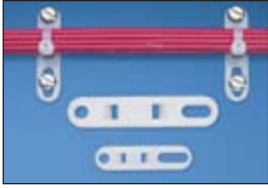

| Part Number | Used with Cable Ties‡ | Length A | | Width B | | Height C | | Hole Spacing D | | Color | Mounting Method | Std. Pkg. Qty. | Std. Ctn. Qty. |
|-------------|-----------------------|----------|------|---------|------|----------|-----|----------------|------|---------|-----------------|----------------|----------------|
| | | In. | mm | In. | mm | In. | mm | In. | mm | | | | |
| TP2-C | M, I, S | 1.98 | 50.3 | .50 | 12.7 | .13 | 3.2 | 1.60 | 40.6 | Natural | #10 (M5) Screw | 100 | 1000 |
| TP4H-C | M, I, S, HS, LH, H | 3.08 | 78.2 | .62 | 15.7 | .20 | 5.2 | 2.50 | 63.5 | Natural | 1/4 (M6) Screw | 100 | 1000 |

‡Cable tie cross section sizes: M = Miniature, I = Intermediate, S = Standard, HS = Heavy-Standard, LH = Light-Heavy and H = Heavy.

Multiple Tie Plates

- Used to secure closely spaced wire bundles
- Low profile design keeps bundle close to mounting surface
- For indoor use only
- Material: Nylon 6.6

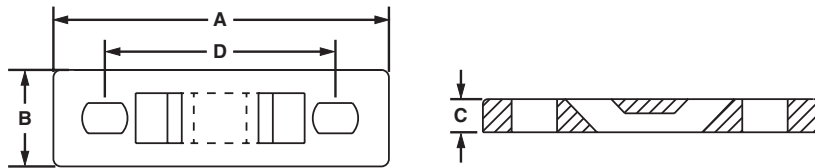

| Part Number | No. of Bundles | Used with Cable Ties‡ | Length A | | Width B | | Height C | | Hole Spacing D | | Mounting Method | Mil. Std. Part Number | Std. Pkg. Qty. | Std. Ctn. Qty. |
|-------------|----------------|-----------------------|----------|------|---------|------|----------|-----|----------------|------|-----------------|-----------------------|----------------|----------------|
| | | | In. | mm | In. | mm | In. | mm | In. | mm | | | | |
| MTP1S-E6-C | 1 | M, I, S | 1.75 | 44.5 | .50 | 12.7 | .13 | 3.2 | 1.25 | 31.8 | #6 (M3) Screw | MS3339-1-9 | 100 | 1000 |
| MTP1S-E10-C | | | 1.75 | 44.5 | .50 | 12.7 | .13 | 3.2 | 1.25 | 31.8 | #10 (M5) Screw | — | 100 | 1000 |
| MTP1H-E6-C | | M, I, S, HS, LH, H | 2.09 | 53.1 | .63 | 16.0 | .20 | 5.2 | 1.50 | 38.1 | #6 (M3) Screw | MS3339-6-9 | 100 | 1000 |
| MTP1H-E10-C | | | 2.09 | 53.1 | .63 | 16.0 | .20 | 5.2 | 1.50 | 38.1 | #10 (M5) Screw | — | 100 | 1000 |
| MTP2S-E6-C | 2 | M, I, S | 3.00 | 76.2 | .50 | 12.7 | .13 | 3.2 | 2.50 | 63.5 | #6 (M3) Screw | MS3339-2-9 | 100 | 1000 |
| MTP2S-E10-C | | | 3.00 | 76.2 | .50 | 12.7 | .13 | 3.2 | 2.50 | 63.5 | #10 (M5) Screw | — | 100 | 1000 |
| MTP2H-E6-C | | M, I, S, HS, LH, H | 3.59 | 91.2 | .63 | 16.0 | .20 | 5.2 | 3.00 | 76.2 | #6 (M3) Screw | MS3339-7-9 | 100 | 1000 |
| MTP2H-E10-C | | | 3.59 | 91.2 | .63 | 16.0 | .20 | 5.2 | 3.00 | 76.2 | #10 (M5) Screw | — | 100 | 1000 |

‡Cable tie cross section sizes: M = Miniature, I = Intermediate, S = Standard, HS = Heavy-Standard, LH = Light-Heavy and H = Heavy.

Table continues on page B2.16

A. System Overview

Multiple Tie Plates (continued)

B1. Cable Ties

B2. Cable Accessories

B3. Stainless Steel Ties

C1. Wiring Duct

C2. Surface Raceway

C3. Abrasion Protection

C4. Cable Management

D1. Terminals

D2. Power Connectors

D3. Grounding Connectors

E1. Labeling Systems

E2. Labels

E3. Pre-Printed & Write-On Markers

E4. Permanent Identification

E5. Lockout/Tagout & Safety Solutions

F. Index

| Part Number | No. of Bundles | Used with Cable Ties‡ | Length A | | Width B | | Height C | | Hole Spacing D | | Mounting Method | Mil. Std. Part Number | Std. Pkg. Qty. | Std. Ctn. Qty. | |
|-------------|----------------|-----------------------|----------|-------|---------|------|----------|-----|----------------|-------|-----------------|-----------------------|----------------|----------------|------|
| | | | In. | mm | In. | mm | In. | mm | In. | mm | | | | | |
| MTP3S-E6-C | 3 | M, I, S | 4.25 | 108.0 | .50 | 12.7 | .13 | 3.2 | 3.75 | 95.3 | #6 (M3) Screw | MS3339-3-9 | 100 | 1000 | |
| MTP3S-E10-C | | | 4.25 | 108.0 | .50 | 12.7 | .13 | 3.2 | 3.75 | 95.3 | #10 (M5) Screw | — | 100 | 1000 | |
| MTP3H-E6-C | | M, I, S, HS, LH, H | 5.09 | 129.3 | .63 | 16.0 | .20 | 5.2 | 4.50 | 114.3 | #6 (M3) Screw | MS3339-8-9 | 100 | 1000 | |
| MTP3H-E10-C | | | 5.09 | 129.3 | .63 | 16.0 | .20 | 5.2 | 4.50 | 114.3 | #10 (M5) Screw | — | 100 | 1000 | |
| MTP4S-E6-C | 4 | M, I, S | 5.50 | 139.7 | .50 | 12.7 | .13 | 3.2 | 5.00 | 127.0 | #6 (M3) Screw | MS3339-4-9 | 100 | 1000 | |
| MTP4S-E10-C | | | 5.50 | 139.7 | .50 | 12.7 | .13 | 3.2 | 5.00 | 127.0 | #10 (M5) Screw | — | 100 | 1000 | |
| MTP4H-E6-C | | M, I, S, HS, LH, H | 6.59 | 167.4 | .63 | 15.7 | .20 | 5.2 | 6.00 | 152.4 | #6 (M3) Screw | MS3339-9-9 | 100 | 1000 | |
| MTP4H-E10-C | | | 6.59 | 167.4 | .63 | 15.7 | .20 | 5.2 | 6.00 | 152.4 | #10 (M5) Screw | — | 100 | 1000 | |
| MTP5S-E6-C | 5 | M, I, S | 6.75 | 171.5 | .50 | 12.7 | .13 | 3.2 | 6.25 | 158.8 | #6 (M3) Screw | MS3339-5-9 | 100 | 1000 | |
| MTP5S-E10-C | | | 6.75 | 171.5 | .50 | 12.7 | .13 | 3.2 | 6.25 | 158.8 | #10 (M5) Screw | — | 100 | 1000 | |
| MTP5H-E6-C | | M, I, S, HS, LH, H | 8.09 | 205.5 | .63 | 16.0 | .20 | 5.2 | 7.50 | 190.5 | #6 (M3) Screw | MS3339-10-9 | 100 | 1000 | |
| MTP5H-E10-C | | | 8.09 | 205.5 | .63 | 16.0 | .20 | 5.2 | 7.50 | 190.5 | #10 (M5) Screw | — | 100 | 1000 | |
| MTP6H-E6-C | | | 6 | 9.59 | 243.6 | .63 | 16.0 | .20 | 5.2 | 9.00 | 228.6 | #6 (M3) Screw | MS3339-11-9 | 100 | 1000 |
| MTP6H-E10-C | | | | 9.59 | 243.6 | .63 | 16.0 | .20 | 5.2 | 9.00 | 228.6 | #10 (M5) Screw | — | 100 | 1000 |

Contour Multiple Tie Plates

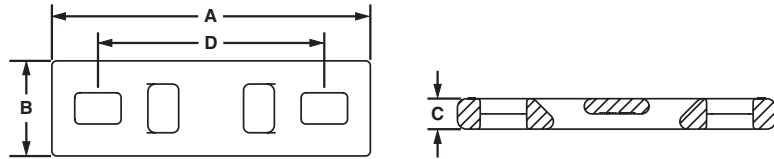

| Part Number | No. of Bundles | Used with Cable Ties‡ | Length A | | Width B | | Height C | | Hole Spacing D | | Mounting Method | Mil. Std. Part Number | Std. Pkg. Qty. | Std. Ctn. Qty. |
|----------------|----------------|-----------------------|----------|-------|---------|------|----------|-----|----------------|-------|-----------------|-----------------------|----------------|----------------|
| | | | In. | mm | In. | mm | In. | mm | In. | mm | | | | |
| MTPC1H-E10-C39 | 1 | M, I, S, HS, LH, H | 2.09 | 53.1 | .63 | 16.0 | .20 | 5.2 | 1.5 | 38.1 | #10 (M5) Screw | — | 100 | 1000 |
| MTPC2H-E10-C39 | 2 | | 3.59 | 91.2 | .63 | 16.0 | .20 | 5.2 | 3.0 | 6.2 | #10 (M5) Screw | — | 100 | 1000 |
| MTPC3H-E10-C39 | 3 | | 5.09 | 129.3 | .63 | 16.0 | .20 | 5.2 | 4.50 | 114.3 | #10 (M5) Screw | — | 100 | 1000 |
| MTPC4H-E10-C39 | 4 | | 6.59 | 167.4 | .63 | 15.7 | .20 | 5.2 | 6.00 | 152.4 | #10 (M5) Screw | — | 100 | 1000 |
| MTPC5H-E10-C39 | 5 | | 8.09 | 205.5 | .63 | 16.0 | .20 | 5.2 | 7.50 | 190.5 | #10 (M5) Screw | — | 100 | 1000 |
| MTPC6H-E10-C39 | 6 | | 9.59 | 243.6 | .63 | 16.0 | .20 | 5.2 | 9.00 | 228.6 | #10 (M5) Screw | — | 100 | 1000 |

‡Cable tie cross section sizes: M = Miniature, I = Intermediate, S = Standard, HS = Heavy-Standard, LH = Light-Heavy and H = Heavy.

Right Angle Mounts

- Hold cable bundles away from the sharp edges of bulkheads or cabinet holes
- For indoor use only
- Can also be used to mount cable bundles adjacent to any surface
- Material: Nylon 6.6

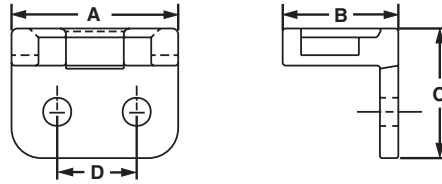

| Part Number | Used with Cable Ties‡ | Length A | | Width B | | Height C | | Hole Spacing D | | Color | Mil. Std. Part Number | Mounting Method | Std. Pkg. Qty. | Std. Ctn. Qty. |
|-------------|-----------------------|----------|------|---------|------|----------|------|----------------|------|---------|-----------------------|-------------------------------------|----------------|----------------|
| | | In. | mm | In. | mm | In. | mm | In. | mm | | | | | |
| RAMS-S3-M | M, I, S | .56 | 14.2 | .39 | 9.9 | .44 | 11.0 | .28 | 7.1 | Natural | MS3341-2-9 | #3 (M2.5) Screw or 3/32 (2.4) Rivet | 1000 | 5000 |
| RAMH-S6-D | M, I, S, HS, LH, H | 1.00 | 25.4 | .75 | 19.1 | 1.00 | 25.4 | .28 | 7.1 | | MS3341-1-9 | #6 (M3) Screw or 1/8 (3.2) Rivet | 500 | 5000 |
| RAMH-S10-D | M, I, S, HS, LH, H | 1.00 | 25.4 | .75 | 19.1 | 1.00 | 25.4 | .50 | 12.7 | | — | #10 (M5) Screw or 3/16 (4.7) Rivet | 500 | 5000 |

‡Cable tie cross section sizes: M = Miniature, I = Intermediate, S = Standard, HS = Heavy Standard, LH = Light-Heavy and H = Heavy.

Lightening Hole Mounts

- Secure cable bundles that run through bulkhead lightening holes
- For indoor use only
- Protect cable bundles from sharp edges
- Material: Nylon 6.6

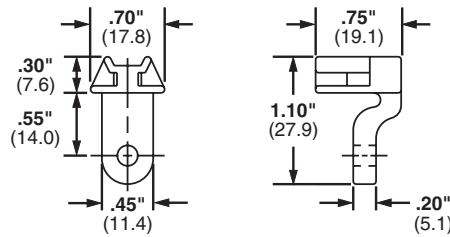

| Part Number | Used with Cable Ties‡ | Color | Mil. Std. Part Number | Mounting Method | Std. Pkg. Qty. | Std. Ctn. Qty. |
|-------------|-----------------------|---------|-----------------------|------------------------------------|----------------|----------------|
| LHMS-S5-D | M, I, S | Natural | — | #5 (M3) Screw or 1/8 (3.2) Rivet | 500 | 2500 |
| LHMS-S6-D | | | MS3340-1-9 | #6 (M3) Screw or 9/64 (3.5) Rivet | 500 | 2500 |
| LHMS-S10-D | | | — | #10 (M5) Screw or 3/16 (4.7) Rivet | 500 | 2500 |

‡Cable tie cross section sizes: M = Miniature, I = Intermediate, and S = Standard.

A. System Overview

B1. Cable Ties

B2. Cable Accessories

B3. Stainless Steel Ties

C1. Wiring Duct

C2. Surface Raceway

C3. Abrasion Protection

C4. Cable Management

D1. Terminals

D2. Power Connectors

D3. Grounding Connectors

E1. Labeling Systems

E2. Labels

E3. Pre-Printed & Write-On Markers

E4. Permanent Identification

E5. Lockout/Tagout & Safety Solutions

F. Index

A. System Overview

Metal Clip-On Mounts

- Clips on sheet metal edges for fast mounting of harness with cable ties
- Allows cable tie entry from all four sides for easy harness orientation
- For indoor use only
- Material: Zinc plated steel

B1. Cable Ties

B2. Cable Accessories

B3. Stainless Steel Ties

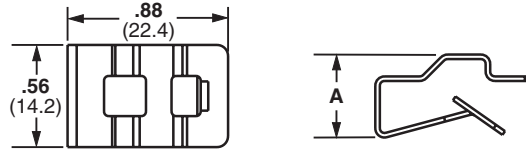

| Part Number | Used with Cable Ties‡ | Height A | | Max. Panel Thickness | | Mounting Method | Std. Pkg. Qty. | Std. Ctn. Qty. |
|-------------|-----------------------|----------|------|----------------------|-----|-----------------|----------------|----------------|
| | | In. | mm | In. | mm | | | |
| MCMS12-P-C | M, I, S | .31 | 8.0 | .13 | 3.2 | Clip-On | 100 | 500 |
| MCMS25-P-C | | .46 | 11.5 | .24 | 6.1 | | 100 | 500 |
| MCMS30-P-C | | .55 | 14.0 | .27 | 6.9 | | 100 | 500 |

‡Cable Tie Cross Section Sizes: M = Miniature, I = Intermediate, and S = Standard.

C1. Wiring Duct

C2. Surface Raceway

C3. Abrasion Protection

Metal Screw-On Mount

- Screw applied aluminum mounting base for a secure support in demanding applications

C4. Cable Management



D1. Terminals

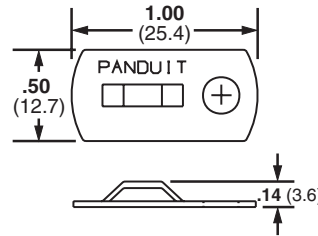

D2. Power Connectors

D3. Grounding Connectors

| Part Number | Used with Cable Ties‡ | Material | Environment | Mounting Method | Max. Static Load | | Std. Pkg. Qty. | Std. Ctn. Qty. |
|-------------|-----------------------|----------|------------------|-----------------|------------------|------|----------------|----------------|
| | | | | | Lbs. | g | | |
| MBMS-S10-CY | M, I, S | Aluminum | Indoors/Outdoors | #10 (M5) Screw | 10.00 | 4540 | 100 | 1000 |

‡Cable Tie Cross Section Sizes: M = Miniature, I = Intermediate, and S = Standard.

E1. Labeling Systems

Push Barb Cable Tie Mounts

- Wing provides added stability
- Requires no adhesive or additional mounting hardware
- Can be used where only one side of the panel is accessible

E2. Labels



E3. Pre-Printed & Write-On Markers

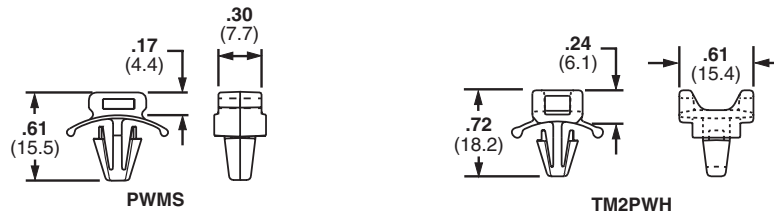

E4. Permanent Identification

E5. Lockout/Tagout & Safety Solutions

F. Index

| Part Number | Used with Cable Ties‡ | Max. Panel Thickness | | Panel Hole Diameter | | Material | Color | Environment | Mounting Method | Std. Pkg. Qty. | Std. Ctn. Qty. |
|-------------|-----------------------|----------------------|-----|---------------------|-----|-----------------------------|---------|-------------|-----------------|----------------|----------------|
| | | In. | mm | In. | mm | | | | | | |
| PWMS-H25-C | M, I, S | .11 | 2.7 | .25 | 6.5 | Nylon 6.6 | Natural | Indoors | Push Barb | 100 | 1000 |
| PWMS-H25-M0 | | .11 | 2.7 | .25 | 6.5 | Weather Resistant Nylon 6.6 | Black | Outdoors | Push Barb | 1000 | 5000 |
| TM2PWH25-C | | .10 | 2.3 | .25 | 6.5 | Nylon 6.6 | Natural | Indoors | Push Barb | 100 | 500 |

‡Cable tie cross section Sizes: M = Miniature, I = Intermediate, and S = Standard.

Push Mounts

- Require no adhesive or additional mounting hardware
- Can be used where only one side of the panel is accessible

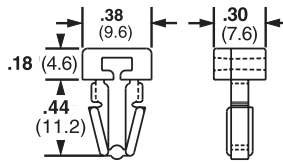

| Part Number | Used with Cable Ties‡ | Max. Panel Thickness | | Panel Hole Diameter | | Material | Color | Environment | Mounting Method | Std. Pkg. Qty. | Std. Ctn. Qty. |
|-------------|-----------------------|----------------------|-----|---------------------|-----|-----------------------------|---------|-------------|-----------------|----------------|----------------|
| | | In. | mm | In. | mm | | | | | | |
| PM2H25-C | M, I, S | .125 | 3.2 | .250 | 6.4 | Nylon 6.6 | Natural | Indoors | Push Barb | 100 | 500 |
| PM2H25-M0 | | .125 | 3.2 | .250 | 6.4 | Weather Resistant Nylon 6.6 | Black | Outdoors | | 1000 | 5000 |
| PM2H25-M30 | | .125 | 3.2 | .250 | 6.4 | Heat Stabilized Nylon 6.6 | Black | Indoors | | 1000 | 5000 |

‡Cable tie cross section sizes: M = Miniature, I = Intermediate, and S = Standard.

Push Button Mount

- Require no adhesive or additional mounting hardware
- Designed for use where both sides of the panel are accessible

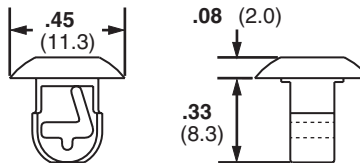

| Part Number | Used with Cable Ties‡ | Max. Panel Thickness | | Panel Hole Diameter | | Material | Color | Environment | Mounting Method | Std. Pkg. Qty. | Std. Ctn. Qty. |
|---------------|-----------------------|----------------------|-----|---------------------|-----|-----------------------------|---------|-------------|-----------------|----------------|----------------|
| | | In. | mm | In. | mm | | | | | | |
| PBMS-H25-C | M, I, S | .13 | 3.2 | .25 | 6.4 | Nylon 6.6 | Natural | Indoors | Push Barb | 100 | 1000 |
| PBMS-H25-C14 | | .13 | 3.2 | .25 | 6.4 | Nylon 6.6 | Gray | Indoors | | 100 | 1000 |
| PBMS-H25-M0 | | .13 | 3.2 | .25 | 6.4 | Weather Resistant Nylon 6.6 | Black | Outdoors | | 1000 | 5000 |
| PBMS-H25-M30 | | .13 | 3.2 | .25 | 6.4 | Heat Stabilized Nylon 6.6 | Black | Indoors | | 1000 | 5000 |
| PBMSL-H25-C30 | | .29 | 7.2 | .25 | 6.4 | Heat Stabilized Nylon 6.6 | Black | Indoors | | 100 | 1000 |
| PBMSL-H25-M30 | | .29 | 7.2 | .25 | 6.4 | Heat Stabilized Nylon 6.6 | Black | Indoors | | 1000 | 5000 |

‡Cable tie cross section sizes: M = Miniature, I = Intermediate, and S = Standard.

A. System Overview

B1. Cable Ties

B2. Cable Accessories

B3. Stainless Steel Ties

C1. Wiring Duct

C2. Surface Raceway

C3. Abrasion Protection

C4. Cable Management

D1. Terminals

D2. Power Connectors

D3. Grounding Connectors

E1. Labeling Systems

E2. Labels

E3. Pre-Printed & Write-On Markers

E4. Permanent Identification

E5. Lockout/Tagout & Safety Solutions

F. Index

A. System Overview

Masonry Push Mounts

- Used to secure wire, cable, or tubing to masonry surfaces
- Installed quickly into pre-drilled holes; design holds bundle securely
- Material: Impact Modified Weather Resistant Nylon 6.6

B1. Cable Ties

B2. Cable Accessories

B3. Stainless Steel Ties

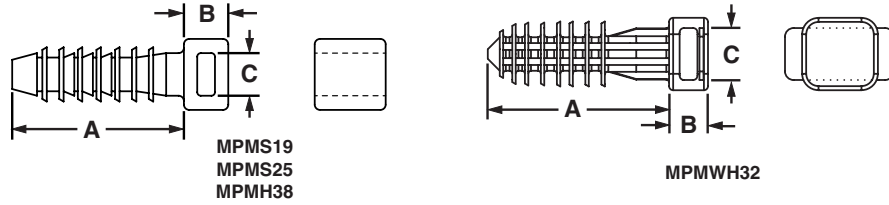

C1. Wiring Duct

C2. Surface Raceway

C3. Abrasion Protection

C4. Cable Management

| Part Number | Used with Cable Ties‡ | Grip Length A | | Height B | | Hole Diameter C | | Color | Environment | Mounting Method | Std. Pkg. Qty. | Std. Ctn. Qty. |
|-------------|-------------------------|-------------------------|------|----------|-----|-----------------|-----|-------|-------------|-----------------|----------------|----------------|
| | | In. | mm | In. | mm | In. | mm | | | | | |
| MPMS19-C0 | M, I, S | .97 | 24.6 | .25 | 6.4 | .19 | 5.0 | Black | Outdoors | Tree Barb | 100 | 500 |
| MPMS25-C0 | | .97 | 24.6 | .27 | 6.9 | .25 | 6.4 | | | | | |
| MPMH38-L0 | | M, I, S, HS, LH, H, HLM | 1.25 | 31.8 | .30 | 7.5 | .38 | | | | | |
| MPMWH32-L0 | M, I, S, HS, LH, H, HLM | 1.41 | 35.8 | .28 | 7.1 | .32 | 8.0 | | | | | |

‡Cable Tie Cross Section Sizes: M = Miniature, I = Intermediate, S = Standard, HS = Heavy-Standard, LH = Light-Heavy, H = Heavy and HLM = Miniature *TAK-TY*® Hook & Loop Ties.

D1. Terminals

D2. Power Connectors

D3. Grounding Connectors

E1. Labeling Systems

E2. Labels

E3. Pre-Printed & Write-On Markers

E4. Permanent Identification

E5. Lockout/Tagout & Safety Solutions

F. Index

NEW! **SUPER-GRIP® Masonry Push Mounts**

- Used to secure wire, cable, or tubing to masonry surfaces
- Installed quickly into pre-drilled holes; design holds bundle securely
- For use with *SUPER-GRIP*® Cable Ties found on page B1.38
- Material: Impact Modified Weather Resistant Nylon 6.6

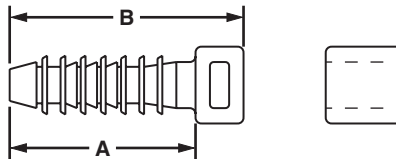

| Part Number | Used with Cable Ties‡ | Grip Length A | | Height B | | Hole Diameter | | Color | Environment | Mounting Method | Std. Pkg. Qty. | Std. Ctn. Qty. |
|--------------|--------------------------|---------------|------|----------|-----|---------------|-----|-------|----------------------|-----------------|----------------|----------------|
| | | In. | mm | In. | mm | In. | mm | | | | | |
| SGMPMS19-C0 | SGM, SGI, SGS | .97 | 24.6 | .25 | 6.4 | .19 | 5.0 | Black | Indoors/ Outdoors | Tree Barb | 100 | 500 |
| SGMPMS25-C0 | | .97 | 24.6 | .27 | 6.9 | .25 | 6.4 | | | | | |
| SGMPMH38-L0 | | 1.25 | 31.8 | .30 | 7.5 | .38 | 9.5 | | | | | |
| SGMPMWH32-L0 | SGM, SGI, SGS, SGLH, SGH | 1.41 | 35.8 | .28 | 7.1 | .32 | 8.0 | | | | | |

‡Cable tie cross section sizes: SGM = *SUPER-GRIP*® Miniature, SGI = *SUPER-GRIP*® Intermediate, SGS = *SUPER-GRIP*® Standard, SGLH = *SUPER-GRIP*® Light-Heavy, SGH = *SUPER-GRIP*® Heavy.



HYPER-V™ Masonry Cable Tie Mounts

- Used to secure wire, cable, or tubing to masonry surfaces
- Material: Impact Modified Weather Resistant Nylon 6.6
- For use with *HYPER-V™* Cable Ties found on page B1.62

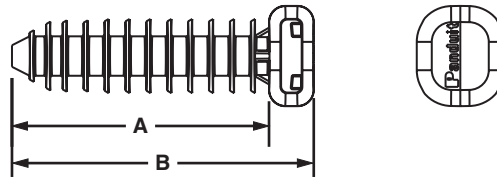

| Part Number | Used with Cable Ties‡ | Grip Length A | | Height B | | Hole Diameter | | Color | Environment | Mounting Method | Std. Pkg. Qty. | Std. Ctn. Qty. |
|-------------|-----------------------|---------------|------|----------|------|---------------|-----|-------|-------------|--|----------------|----------------|
| | | In. | mm | In. | mm | In. | mm | | | | | |
| HVMPM32-C0 | HV | 1.41 | 35.8 | 1.63 | 41.4 | .31 | 8.0 | Black | Outdoors | Tree barb for .31" (7.9mm) hole diameter | 100 | 500 |

‡Cable tie cross section size: HV = *HYPER-V™* Cable Ties.

Wood Push Mount

- Used to secure wire, cable, or tubing to wood surfaces
- Barbed design holds mount in place – rated for 60 lb. pullout

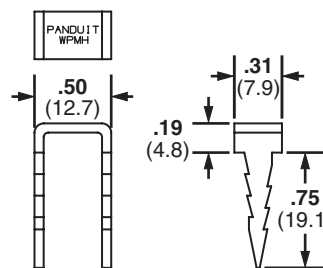

| Part Number | Used with Cable Ties‡ | Material | Environment | Mounting Method | Std. Pkg. Qty. |
|-------------|-------------------------|--------------|------------------|------------------|----------------|
| WPMH-C | M, I, S, HS, LH, H, HLM | Plated Steel | Indoors/Outdoors | Hammer into wood | 100 |

‡Cable tie cross section sizes: M = Miniature, I = Intermediate, S = Standard, HS = Heavy Standard, LH = Light-Heavy, H = Heavy and HLM = Miniature *TAK-TY®* Hook & Loop Ties.

- A. System Overview
- B1. Cable Ties
- B2. Cable Accessories
- B3. Stainless Steel Ties
- C1. Wiring Duct
- C2. Surface Raceway
- C3. Abrasion Protection
- C4. Cable Management
- D1. Terminals
- D2. Power Connectors
- D3. Grounding Connectors
- E1. Labeling Systems
- E2. Labels
- E3. Pre-Printed & Write-On Markers
- E4. Permanent Identification
- E5. Lockout/Tagout & Safety Solutions
- F. Index

A. System Overview



Push Mounts with Umbrella

B1. Cable Ties

- Unique alternating barb design
- Lock securely into position
- Umbrella tensioning

- Exclusive contoured anvil head
- Material: Heat Stabilized Nylon 6.6

B2. Cable Accessories

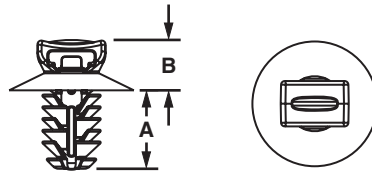

B3. Stainless Steel Ties

C1. Wiring Duct

C2. Surface Raceway

C3. Abrasion Protection

C4. Cable Management

| Part Number | Used with Cable Ties‡ | Head Diameter | | Panel to Top of Mount | | Overall Height | | Panel Hole Diameter Range | | Panel Thickness Range | | Std. Pkg. Qty. | Std. Ctn. Qty. |
|--------------------|-----------------------|---------------|------|-----------------------|-----|----------------|------|---------------------------|------------|-----------------------|------------|----------------|----------------|
| | | In. | mm | In. | mm | In. | mm | In. | mm | In. | mm | | |
| PUM-049-M30 | M, I, S | .67 | 17.0 | .26 | 6.6 | .54 | 13.8 | .18 – .19 | 4.6 – 4.9 | .03 – .19 | 0.7 – 3.0 | 1000 | 5000 |
| PUM-071-M30 | M, I, S | .67 | 17.0 | .26 | 6.5 | .67 | 16.9 | .25 – .28 | 6.3 – 7.1 | .03 – .28 | 0.8 – 7.0 | 1000 | 5000 |
| PUM-100-M30 | M, I, S | .64 | 16.0 | .26 | 6.5 | .67 | 16.9 | .35 – .40 | 9.0 – 10.0 | .03 – .28 | 0.8 – 7.0 | 1000 | 5000 |
| PUM-925-M30 | M, I, S, LH | .77 | 20.0 | .30 | 7.6 | 1.05 | 26.7 | .34 – .36 | 8.8 – 9.3 | .04 – .62 | 1.0 – 16.0 | 1000 | 5000 |

‡Use with PLT2S-M30 cable tie.

D1. Terminals



Push Mount Assemblies

D2. Power Connectors

- Cable tie/mount assemblies significantly reduce installation time compared to loose parts
- Fewer parts throughout the manufacturing/assembly process

- Heat Stabilized Nylon 6.6 standard on cable ties and mounts
- Maximum bundle diameter: 1.88 inches (4.8mm)

D3. Grounding Connectors

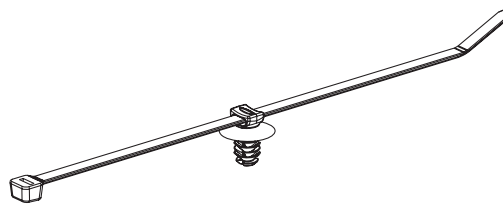

E1. Labeling Systems

E2. Labels

E3. Pre-Printed & Write-On Markers

E4. Permanent Identification

E5. Lockout/Tagout & Safety Solutions

F. Index

| Part Number‡ | Head Diameter | | Panel to Top of Mount | | Overall Height | | Panel Hole Diameter Range | | Panel Thickness Range | | Std. Pkg. Qty. | Std. Ctn. Qty. |
|-----------------------|---------------|------|-----------------------|-----|----------------|------|---------------------------|------------|-----------------------|------------|----------------|----------------|
| | In. | mm | In. | mm | In. | mm | In. | mm | In. | mm | | |
| PUM-049-2S-D30 | .67 | 17.0 | .26 | 6.6 | .54 | 13.8 | .18 – .19 | 4.6 – 4.9 | .03 – .19 | 0.7 – 3.0 | 500 | 5000 |
| PUM-071-2S-D30 | .67 | 17.0 | .26 | 6.5 | .67 | 16.9 | .25 – .28 | 6.3 – 7.1 | .03 – .28 | 0.8 – 7.0 | 500 | 5000 |
| PUM-100-2S-D30 | .64 | 16.0 | .26 | 6.5 | .67 | 16.9 | .35 – .40 | 9.0 – 10.0 | .03 – .28 | 0.8 – 7.0 | 500 | 5000 |
| PUM-925-2S-D30 | .77 | 20.0 | .30 | 7.6 | 1.05 | 26.7 | .34 – .36 | 8.8 – 9.3 | .04 – .62 | 1.0 – 16.0 | 500 | 5000 |

‡Push mount with PLT2S Cable Ties – 1.88"(4.8mm) – maximum bundle diameter

Control Panel Mounts

- Installed behind control panel switch
- Ideal for high strain areas where cable is routed from panel to panel door
- Compatible with most control panel switch designs
- Indoor use only

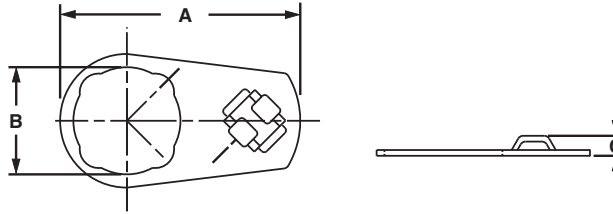

| Part Number | Used with Cable Ties‡ | Length A | | Width B | | Height C | | Material | Mounting Method | Std. Pkg. Qty. | Std. Ctn. Qty. |
|-------------|-----------------------|----------|------|---------|------|----------|-----|-------------------|----------------------|----------------|----------------|
| | | In. | mm | In. | mm | In. | mm | | | | |
| CPM87S-C | M, I, S | 2.01 | 51.1 | .89 | 22.6 | .17 | 4.3 | Zinc plated steel | Control panel switch | 100 | 1000 |
| CPM122S-C | M, I, S | 2.82 | 71.7 | 1.22 | 31.0 | .17 | 4.3 | Zinc plated steel | Control panel switch | 100 | 1000 |

‡Cable tie cross section sizes: M = Miniature, I = Intermediate, and S = Standard.

PAN-POST™ Standoff

- Supports cable bundles above or away from surface
- For indoor use only
- Material: Nylon 6.6

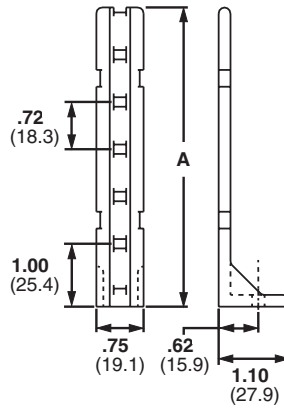

| Part Number | Used with Cable Ties‡ | Height A | | Color | Mounting Method | Std. Pkg. Qty. | Std. Ctn. Qty. |
|-------------|-----------------------|----------|-------|---------|------------------|----------------|----------------|
| | | In. | mm | | | | |
| PP1S-S10-X | M, I, S | 2.00 | 50.8 | Natural | #10 (M5) Screw | 10 | 100 |
| PP1S-S12-X | | 2.00 | 50.8 | | #12 (M5.5) Screw | 10 | 100 |
| PP2S-S10-X | | 4.60 | 116.8 | | #10 (M5) Screw | 10 | 100 |
| PP2S-S12-X | | 4.60 | 116.8 | | #12 (M5.5) Screw | 10 | 100 |

‡Cable tie cross section sizes: M = Miniature, I = Intermediate, and S = Standard.

A.
System
Overview

B1.
Cable Ties

B2.
Cable
Accessories

B3.
Stainless
Steel Ties

C1.
Wiring
Duct

C2.
Surface
Raceway

C3.
Abrasion
Protection

C4.
Cable
Management

D1.
Terminals

D2.
Power
Connectors

D3.
Grounding
Connectors

E1.
Labeling
Systems

E2.
Labels

E3.
Pre-Printed
& Write-On
Markers

E4.
Permanent
Identification

E5.
Lockout/
Tagout
& Safety
Solutions

F.
Index

A. System Overview

Flat PAN-POST™ Standoffs

- Standard EIA hole spacing allows product to be mounted with user supplied screws up to 1/4" diameter
- Organize cables in standard cabinets and racks
- Mounting method: 1/4" (M6) screw
- Use where space is limited
- For indoor use only

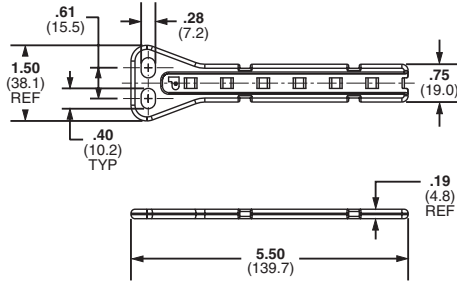

PPF2S

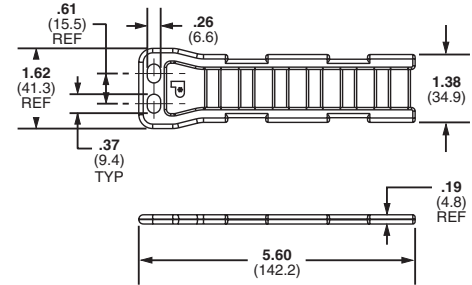

PPF2SV

B1. Cable Ties

B2. Cable Accessories

B3. Stainless Steel Ties

C1. Wiring Duct

C2. Surface Raceway

C3. Abrasion Protection

C4. Cable Management

| Part Number | Used with Cable Ties‡ | Material | Color | Mounting Method | Std. Pkg. Qty. | Std. Ctn. Qty. |
|----------------|------------------------------|---------------------------|---------|----------------------|----------------|----------------|
| PPF2S-S25-V | M, I, S | Nylon 6.6 | Natural | Two 1/4" (M6) screws | 5 | 100 |
| PPF2S-S25-V69 | | Flame Retardant Nylon 6.6 | | | | |
| PPF2SV-S25-V | M, I, S, HS, LH, H, HLM, HLS | Nylon 6.6 | | | | |
| PPF2SV-S25-V69 | | Flame Retardant Nylon 6.6 | | | | |

‡Cable Tie Cross Section Sizes: M = Miniature, I = Intermediate, S = Standard, HS = Heavy-Standard, LH = Light-Heavy, H = Heavy, HLM = Miniature T_{AK-TY}® Hook & Loop Ties and HLS = Standard T_{AK-TY}® Hook & Loop Ties .

D1. Terminals

Right Angle Bases

- Support cable above the mounting surface

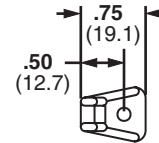
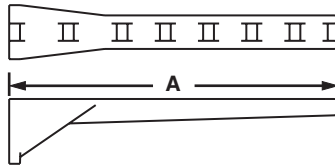

D2. Power Connectors

D3. Grounding Connectors

E1. Labeling Systems

| Part Number | Used with Cable Ties‡ | Max. Flat Cable Width | | Length A | | Material | Color | Environment | Mounting Method | Std. Pkg. Qty. | Std. Ctn. Qty. |
|----------------|-----------------------|-----------------------|------|----------|------|-----------|-------|-------------|-----------------|----------------|----------------|
| | | In. | mm | In. | mm | | | | | | |
| RAFCBI1-S6-C20 | I | 1.00 | 25.4 | 1.75 | 44.4 | Nylon 6.6 | Black | Indoors | #6 (M3) Screw | 100 | 1000 |
| RAFCBI2-S6-C20 | I | 2.00 | 50.8 | 2.78 | 70.6 | | | | | | |
| RAFCBI3-S6-C20 | I | 3.00 | 76.2 | 3.81 | 96.8 | | | | | | |

‡Cable tie cross section sizes: I = Intermediate.

E2. Labels

E3. Pre-Printed & Write-On Markers

E4. Permanent Identification

E5. Lockout/Tagout & Safety Solutions

F. Index

Flat Cable Mounting System – FCB Base and FCPI Plate

- Secures stacked cables, folds, and breakouts, as well as laminated and molded bus bars
- Use one base, one corresponding size plate (FCPI), and one intermediate cross section cable tie
- For indoor use only
- Material: Nylon 6.6

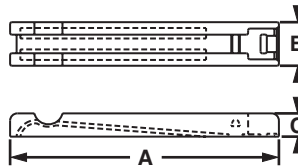

FCPI

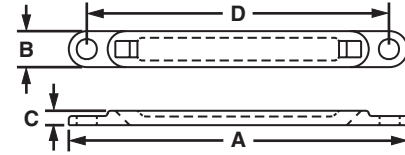

| Part Number | Max. Flat Cable Width | | Length A | | Width B | | Height C | | Hole Spacing D | | Color | Mounting Method | Std. Pkg. Qty. | Std. Ctn. Qty. |
|---------------|-----------------------|------|----------|-------|---------|-----|----------|-----|----------------|-------|-------|------------------------|----------------|----------------|
| | In. | mm | In. | mm | In. | mm | In. | mm | In. | mm | | | | |
| FCBI1-A-C20 | 1.04 | 26.4 | 2.50 | 63.5 | .38 | 9.5 | .15 | 3.8 | — | — | Black | User Supplied Adhesive | 100 | 1000 |
| FCBI2-A-C20 | 2.04 | 51.8 | 3.50 | 88.9 | .38 | 9.5 | .15 | 3.8 | — | — | | User Supplied Adhesive | 100 | 1000 |
| FCBI3-A-C20 | 3.32 | 7.72 | 4.52 | 114.8 | .38 | 9.5 | .15 | 3.8 | — | — | | User Supplied Adhesive | 100 | 1000 |
| FCBI1-S10-C20 | 1.04 | 26.4 | 2.50 | 63.5 | .38 | 9.5 | .15 | 3.8 | 2.08 | 52.8 | | #10 (M5) Screw | 100 | 1000 |
| FCBI2-S10-C20 | 2.04 | 51.8 | 3.50 | 88.9 | .38 | 9.5 | .15 | 3.8 | 3.10 | 78.7 | | #10 (M5) Screw | 100 | 1000 |
| FCBI3-S10-C20 | 3.32 | 77.2 | 4.52 | 114.8 | .38 | 9.5 | .15 | 3.8 | 4.12 | 104.6 | | #10 (M5) Screw | 100 | 1000 |
| FCPI1-C20* | 1.04 | 26.4 | 1.29 | 32.8 | .38 | 9.5 | .20 | 5.1 | — | — | | Cable Ties | 100 | 1000 |
| FCPI2-C20* | 2.04 | 51.8 | 2.31 | 58.7 | .38 | 9.5 | .20 | 5.1 | — | — | | Cable Ties | 100 | 1000 |
| FCPI3-C20* | 3.32 | 77.2 | 3.32 | 84.3 | .38 | 9.5 | .20 | 5.1 | — | — | | Cable Ties | 100 | 1000 |

*Recommend use with PLT21 cable ties.

A. System Overview

B1. Cable Ties

B2. Cable Accessories

B3. Stainless Steel Ties

C1. Wiring Duct

C2. Surface Raceway

C3. Abrasion Protection

C4. Cable Management

D1. Terminals

D2. Power Connectors

D3. Grounding Connectors

E1. Labeling Systems

E2. Labels

E3. Pre-Printed & Write-On Markers

E4. Permanent Identification

E5. Lockout/Tagout & Safety Solutions

F. Index

A. System Overview

Closed Connector Rings

- Connect multiple cable bundles

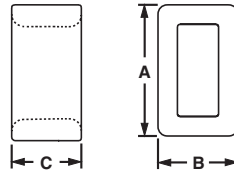

B1. Cable Ties

B2. Cable Accessories

B3. Stainless Steel Ties

C1. Wiring Duct

C2. Surface Raceway

| Part Number | Used with Cable Ties‡ | Length A | | Width B | | Height C | | Material | Color | Environment | Mounting Method | Std. Pkg. Qty. | Std. Ctn. Qty. |
|-------------|-----------------------|----------|------|---------|-----|----------|-----|-----------------------------|---------|------------------|-----------------|----------------|----------------|
| | | In. | mm | In. | mm | In. | mm | | | | | | |
| CR2-M | M, I, S | .33 | 8.4 | .20 | 5.1 | .20 | 5.0 | Nylon 6.6 | Natural | Indoors | Cable Ties | 1000 | 10000 |
| CR4H-M | M, I, S, HS, LH | .57 | 14.5 | .30 | 7.6 | .36 | 9.1 | | | Indoors | | | |
| CR4H-M0 | M, I, S, HS, LH | .57 | 14.5 | .30 | 7.6 | .36 | 9.1 | Weather Resistant Nylon 6.6 | Black | Indoors/Outdoors | | | |

‡Cable tie cross section sizes: M = Miniature, I = Intermediate, S = Standard, HS = Heavy-Standard and LH = Light-Heavy.

C3. Abrasion Protection

Open Connector Ring

- Designed to add on cable bundles without removing cable ties

C4. Cable Management

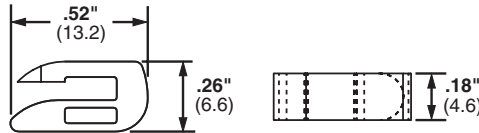

D1. Terminals

D2. Power Connectors

D3. Grounding Connectors

| Part Number | Used with Cable Ties‡ | Material | Color | Environment | Mounting Method | Std. Pkg. Qty. | Std. Ctn. Qty. |
|-------------|-----------------------|-----------|---------|-------------|-----------------|----------------|----------------|
| CROS-M | M, I, S | Nylon 6.6 | Natural | Indoors | Cable Ties | 1000 | 5000 |

‡Cable tie cross section sizes: M = Miniature, I = Intermediate, and S = Standard.

E1. Labeling Systems

Cable Spacers

- Used to separate and/or hang cords, cables, and tubing

E2. Labels

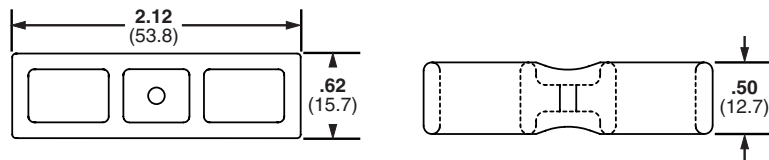

E3. Pre-Printed & Write-On Markers

E4. Permanent Identification

E5. Lockout/Tagout & Safety Solutions

| Part Number | Used with Cable Ties‡ | Material | Color | Environment | Mounting Method | Std. Pkg. Qty. | Std. Ctn. Qty. |
|-------------|-----------------------|-----------------------------|-------|------------------|-----------------|----------------|----------------|
| CSH-D20 | M, I, S, HS, LH, H | Nylon 6.6 | Black | Indoors | Cable Ties | 500 | 2500 |
| CSH-D0 | M, I, S, HS, LH, H | Weather Resistant Nylon 6.6 | Black | Indoors/Outdoors | Cable Ties | 500 | 2500 |

‡Cable tie cross section sizes: M = Miniature, I = Intermediate, S = Standard, HS = Heavy-Standard, LH = Light-Heavy and H = Heavy.

F. Index

Cable Spacer Cross

- Connects two bundles at 90°
- Separates bundles to prevent abrasion

- Dual cradle design stabilizes cable bundle

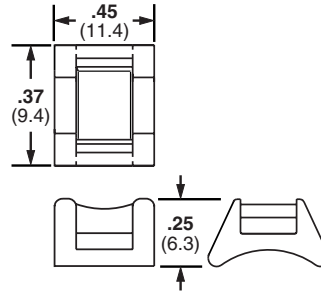

| Part Number | Used with Cable Ties‡ | Material | Color | Environment | Mounting Method | Std. Pkg. Qty. | Std. Ctn. Qty. |
|-------------|-----------------------|-----------|---------|-------------|-----------------|----------------|----------------|
| CSCS-M | M, I, S | Nylon 6.6 | Natural | Indoors | Cable Ties | 1000 | 10000 |

‡Cable tie cross section sizes: M = Miniature, I = Intermediate, and S = Standard.

Stackable Aerial Cable Spacer

- Greater resistance to damage caused by ultraviolet light – indoor or outdoor use
- Each spacer snaps into another to increase spacer heights by 1/2" increments

- Designed for use in parallel or perpendicular applications
- For use with *DURA-TY™* Cable Ties shown on page B1.53 or *PAN-STEEL®* Metal Locking Ties on page B3.7.

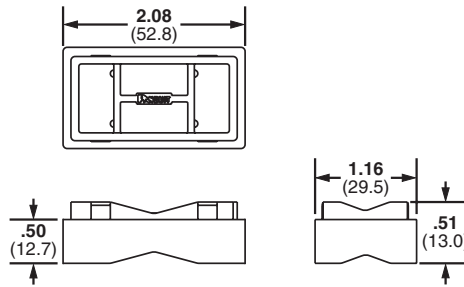

| Part Number | Used with Cable Ties‡ | Material | Color | Environment | Mounting Method | Std. Pkg. Qty. | Std. Ctn. Qty. |
|-------------|-----------------------|---------------------------------|-------|-------------|-----------------|----------------|----------------|
| SACS50-T100 | LH, H, EH | Weather Resistant Polypropylene | Black | Outdoors | Cable Ties | 200 | 2000 |

‡Cable tie cross sizes: LH = Light-Heavy, H = Heavy, and EH = Extra-Heavy.

A.
System
Overview

B1.
Cable Ties

B2.
Cable
Accessories

B3.
Stainless
Steel Ties

C1.
Wiring
Duct

C2.
Surface
Raceway

C3.
Abrasion
Protection

C4.
Cable
Management

D1.
Terminals

D2.
Power
Connectors

D3.
Grounding
Connectors

E1.
Labeling
Systems

E2.
Labels

E3.
Pre-Printed
& Write-On
Markers

E4.
Permanent
Identification

E5.
Lockout/
Tagout/
& Safety
Solutions

F.
Index

A. System Overview

Aerial Support Ties – Weather Resistant Polypropylene

B1. Cable Ties

- Designed to attach coax or telephone cable to the 1/4" (6.4mm) or 5/16" (7.9mm) support strand to form the expansion loop and keep equipment and cables clear of pole hardware
- One-piece construction with integral 1/2" (12.7mm) spacer reduces inventory costs of separate spacer and bands, and installs faster to lower installed cost
- Releasable and re-usable
- Hand install only

B2. Cable Accessories

B3. Stainless Steel Ties

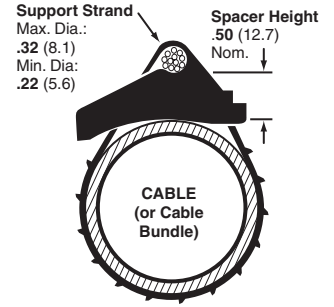
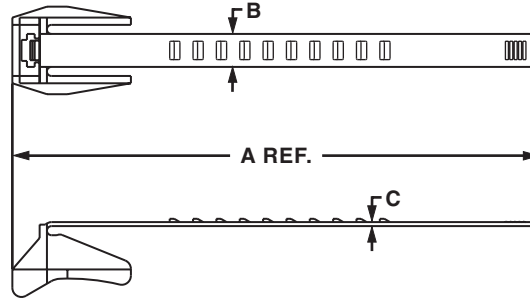

Assembled View

C1. Wiring Duct

C2. Surface Raceway

C3. Abrasion Protection

C4. Cable Management

| Part Number | Length A | | Width B | | Thickness C | | Max. Bundle Diameter | | Min. Loop Tensile Strength | | Std. Pkg. Qty. | Std. Ctn. Qty. |
|---------------------|----------|-----|---------|------|-------------|-----|----------------------|----|----------------------------|-----|----------------|----------------|
| | In. | mm | In. | mm | In. | mm | In. | mm | Lbs. | N | | |
| AST10-5-C100 | 5.6 | 142 | .448 | 11.4 | .055 | 1.4 | 1.00 | 25 | 75 | 334 | 100 | 1000 |
| AST15-5-C100 | 6.9 | 175 | .448 | 11.4 | .055 | 1.4 | 1.50 | 38 | 75 | 334 | 100 | 1000 |
| AST20-5-C100 | 8.4 | 214 | .448 | 11.4 | .055 | 1.4 | 2.00 | 51 | 75 | 334 | 100 | 1000 |
| AST25-5-C100 | 10.0 | 254 | .448 | 11.4 | .055 | 1.4 | 2.50 | 64 | 75 | 334 | 100 | 1000 |

D1. Terminals

Permanent Marking Pens

D2. Power Connectors

- Fast drying, permanent ink for identification on marker ties (pages B1.34, B1.52, and B1.71), marker plates (page B2.29), or cable marker straps (page B1.80)
- May be used with any label shown in the catalog when a printer is not available

D3. Grounding Connectors



PX-0
PX-2



PFX-0
PFX-2



PX-10

E1. Labeling Systems

E2. Labels

E3. Pre-Printed & Write-On Markers

E4. Permanent Identification

E5. Lockout/Tagout & Safety Solutions

F. Index

| Part Number | Color | Description | Std. Pkg. Qty. | Std. Ctn. Qty. |
|--------------|-------|--|----------------|----------------|
| PX-0 | Black | Permanent marking pen – regular tip. | 12 | 144 |
| PX-2 | Red | Permanent marking pen – regular tip. | 12 | 144 |
| PFX-0 | Black | Permanent marking pen – fine tip. | 12 | 144 |
| PFX-2 | Red | Permanent marking pen – fine tip. | 12 | 144 |
| PX-10 | White | Marking pen for black or other dark colored parts – regular tip. | 12 | 300 |

Marker Plates – Loose Piece

- Install as flags, tags, or wrap-around identification plates to clearly identify all wire harnesses
- Use with nylon marking pens for an easy and economic alternative to identify wire harnesses
- Available in black or white to match the wire harness
- Thickness: .02 inches (0.5mm)

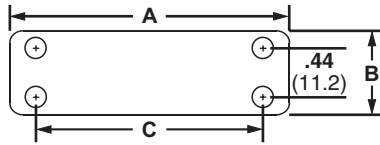

| Part Number | Used with Cable Ties‡ | Length A | | Width B | | Hole Spacing C | | Material | Color | Environment | Mounting Method | Std. Pkg. Qty. | Std. Ctn. Qty. |
|-------------------------------|-----------------------|----------|------|---------|------|----------------|------|-----------------------------|-------|------------------|-----------------|----------------|----------------|
| | | In. | mm | In. | mm | In. | mm | | | | | | |
| Loose Piece | | | | | | | | | | | | | |
| MP150-C | M, I, S | 1.50 | 38.1 | .75 | 19.0 | 1.03 | 26.2 | Nylon 6.6 | White | Indoors | Cable Ties | 100 | 500 |
| MP175-C | M, I, S | 1.75 | 44.4 | .75 | 19.0 | 1.28 | 32.5 | | | | | 100 | 500 |
| MP200-C | M, I, S | 2.00 | 50.8 | .75 | 19.0 | 1.53 | 38.9 | | | | | 100 | 500 |
| MP250-C | M, I, S | 2.50 | 63.5 | .75 | 19.0 | 2.03 | 51.6 | | | | | 100 | 500 |
| MP350-C | M, I, S | 3.50 | 88.9 | .75 | 19.0 | 3.03 | 77.7 | | | | | 100 | 1000 |
| MP250W175-C | M, I, S | 2.50 | 63.5 | 1.75 | 44.5 | 2.03 | 51.6 | | | | | 100 | 1000 |
| MP150-C0 | M, I, S | 1.50 | 38.1 | .75 | 19.0 | 1.03 | 26.2 | Weather Resistant Nylon 6.6 | Black | Indoors/Outdoors | Cable Ties | 100 | 500 |
| MP175-C0 | M, I, S | 1.75 | 44.4 | .75 | 19.0 | 1.28 | 32.5 | | | | | 100 | 500 |
| MP200-C0 | M, I, S | 2.00 | 50.8 | .75 | 19.0 | 1.53 | 38.9 | | | | | 100 | 500 |
| MP250-C0 | M, I, S | 2.50 | 63.5 | .75 | 19.0 | 2.03 | 51.6 | | | | | 100 | 500 |
| MP350-C0 | M, I, S | 3.50 | 88.9 | .75 | 19.0 | 3.03 | 77.7 | | | | | 100 | 1000 |
| Marker Plates on Rolls | | | | | | | | | | | | | |
| MP150-R | M, I, S | 1.50 | 38.1 | .75 | 19.0 | 1.03 | 26.2 | Nylon 6.6 | White | Indoors | Cable Ties | 1000 | 5000 |
| MP175-R | M, I, S | 1.75 | 44.4 | .75 | 19.0 | 1.28 | 32.5 | | | | | 1000 | 5000 |
| MP200-R | M, I, S | 2.00 | 50.8 | .75 | 19.0 | 1.53 | 38.9 | | | | | 1000 | 5000 |
| MP250-R | M, I, S | 2.50 | 63.5 | .75 | 19.0 | 2.03 | 51.6 | | | | | 1000 | 5000 |

‡Cable tie cross section sizes: M = Miniature, I = Intermediate, and S = Standard.

A. System Overview

Cable and Wire Mounting Devices (used without cable ties)

B1. Cable Ties

B2. Cable Accessories

B3. Stainless Steel Ties



Wiring accessories are an integral part of the *PANDUIT* comprehensive selection of wire management products.

These accessories are one piece solutions that help provide the lowest installed cost for controlling, mounting, and protecting wire and cable. Mounting methods include:

- Adhesive-backed
- Screw applied
- Rivet applied
- Push mounts

C1. Wiring Duct

C2. Surface Raceway

Adhesive Backed Mounting Devices

Faster Liner Removal Speeds Installation and Lowers Installed Cost

- The adhesive backed mounts are offered either as one or two mounts per liner
- The 2-up mounts are easily removed by bending the mounts away from the liner
- The individual mounts have a convenient tear tab for quick removal

C3. Abrasion Protection

C4. Cable Management

D1. Terminals

D2. Power Connectors

D3. Grounding Connectors

E1. Labeling Systems

E2. Labels

E3. Pre-Printed & Write-On Markers

E4. Permanent Identification

E5. Lockout/Tagout & Safety Solutions

F. Index

CLINCHER™ Adjustable Releasable Clamp

- Adjustable clamp designed to contain a range of cable bundle diameters
- Latch can be released to provide access to cable bundles
- For indoor use only
- Material: Polypropylene

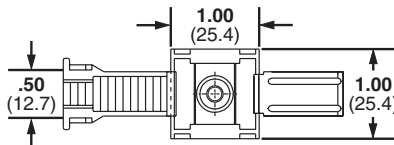

| Part Number | Bundle Diameter Range | | Color | Mounting Method | Max. Static Load | | Std. Pkg. Qty. | Std. Ctn. Qty. |
|----------------------|-----------------------|------------|-------|-----------------|------------------|-----|----------------|----------------|
| | In. | mm | | | Lbs. | g | | |
| ARC.68-A-Q | .19 – .69 | 4.8 – 17.5 | White | Rubber Adhesive | .50 | 227 | 25 | 250 |
| ARC.68-A-Q14 | .19 – .69 | 4.8 – 17.5 | Gray | Rubber Adhesive | .50 | 227 | 25 | 250 |
| ARC.68-S6-Q | .19 – .69 | 4.8 – 17.5 | White | #6 (M3) Screw | — | — | 25 | 250 |
| ARC.68-S6-Q14 | .19 – .69 | 4.8 – 17.5 | Gray | #6 (M3) Screw | — | — | 25 | 250 |

Adhesive Backed Cord Clips

- Cables are easily snapped into or out of the clips

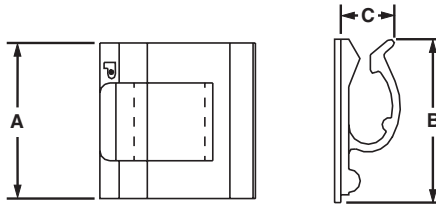

| Part Number | Max. Bundle Diameter | | Length A | | Width B | | Height C | | Material | Color | Adhesive Type | Max. Static Load | | Std. Pkg. Qty. | Std. Ctn. Qty. |
|-------------|----------------------|------|----------|------|---------|------|----------|------|-----------------------------|---------|---------------|------------------|-----|----------------|----------------|
| | In. | mm | In. | mm | In. | mm | In. | mm | | | | Lbs. | g | | |
| ACC19-A-C | .19 | 4.8 | .75 | 19.0 | .62 | 16.0 | .25 | 6.5 | Nylon 6.6 | Natural | Rubber | .20 | 91 | 100 | 500 |
| ACC19-AT-C | .19 | 4.8 | .75 | 19.0 | .62 | 16.0 | .26 | 6.6 | | Natural | Acrylic | .20 | 91 | 100 | 500 |
| ACC19-A-C20 | .19 | 4.8 | .75 | 19.0 | .62 | 16.0 | .27 | 6.7 | | Black | Rubber | .20 | 91 | 100 | 500 |
| ACC19-AT-C0 | .19 | 4.8 | .75 | 19.0 | .62 | 16.0 | .28 | 6.8 | Weather Resistant Nylon 6.6 | Black | Acrylic | .20 | 91 | 100 | 500 |
| ACC38-A-C | .38 | 9.6 | 1.00 | 25.4 | 1.00 | 25.4 | .27 | 6.9 | Nylon 6.6 | Natural | Rubber | .50 | 227 | 100 | 500 |
| ACC38-AT-C | .38 | 9.6 | 1.00 | 25.4 | 1.00 | 25.4 | .28 | 6.10 | | Natural | Acrylic | .50 | 227 | 100 | 500 |
| ACC38-A-C20 | .38 | 9.6 | 1.00 | 25.4 | 1.00 | 25.4 | .29 | 6.9 | | Black | Rubber | .50 | 227 | 100 | 500 |
| ACC38-AT-C0 | .38 | 9.6 | 1.00 | 25.4 | 1.00 | 25.4 | .30 | 6.12 | Weather Resistant Nylon 6.6 | Black | Acrylic | .50 | 227 | 100 | 500 |
| ACC62-A-C | .62 | 15.7 | 1.24 | 31.4 | 1.12 | 28.5 | .63 | 16.0 | Nylon 6.6 | Natural | Rubber | .70 | 318 | 100 | 500 |
| ACC62-AT-C | .62 | 15.7 | 1.24 | 31.4 | 1.12 | 28.5 | .63 | .63 | | Natural | Acrylic | .70 | 318 | 100 | 500 |
| ACC62-A-C20 | .62 | 15.7 | 1.24 | 31.4 | 1.12 | 28.5 | .63 | 16.0 | | Black | Rubber | .70 | 318 | 100 | 500 |
| ACC62-AT-C0 | .62 | 15.7 | 1.24 | 31.4 | 1.12 | 28.5 | .63 | 16.0 | Weather Resistant Nylon 6.6 | Black | Acrylic | .70 | 318 | 100 | 500 |

Push Mount Cord Clip

- Cables are easily snapped into or out of clips
- Winged design holds mount in place even in applications where vibration is present
- Design of wing provides added stability

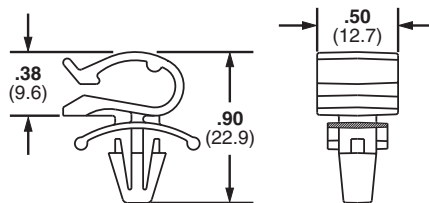

| Part Number | Max. Bundle Diameter | | Max. Panel Thickness | | Panel Hole Diameter | | Material | Color | Environment | Mounting Method | Std. Pkg. Qty. | Std. Ctn. Qty. |
|--------------|----------------------|-----|----------------------|-----|---------------------|-----|-----------------------------|---------|-------------|-----------------|----------------|----------------|
| | In. | mm | In. | mm | In. | mm | | | | | | |
| PMCC38H25-C | .38 | 9.6 | .105 | 2.7 | .250 | 6.4 | Nylon 6.6 | Natural | Indoors | Push Barb | 100 | 1000 |
| PMCC38H25-M0 | .38 | 9.6 | .105 | 2.7 | .250 | 6.4 | Weather Resistant Nylon 6.6 | Black | Outdoors | | 1000 | 5000 |

A. System Overview

B1. Cable Ties

B2. Cable Accessories

B3. Stainless Steel Ties

C1. Wiring Duct

C2. Surface Raceway

C3. Abrasion Protection

C4. Cable Management

D1. Terminals

D2. Power Connectors

D3. Grounding Connectors

E1. Labeling Systems

E2. Labels

E3. Pre-Printed & Write-On Markers

E4. Permanent Identification

E5. Lockout/Tagout & Safety Solutions

F. Index

A. System Overview

"J" Clips

B1. Cable Ties

- Low profile clips retain cords, cables, or tubing
- Flexible design allows for easy cord insertion, yet holds bundle tightly

- For indoor use only
- Material: PVC

B2. Cable Accessories

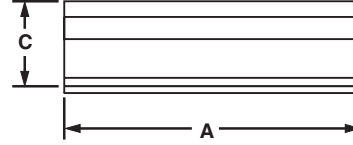
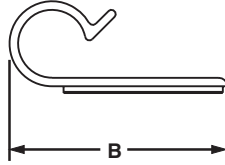
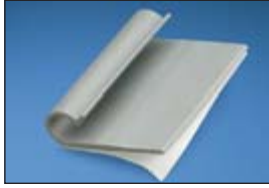

B3. Stainless Steel Ties

C1. Wiring Duct

C2. Surface Raceway

C3. Abrasion Protection

C4. Cable Management

| Part Number | Max. Bundle Diameter | | Length A | | Width B | | Height C | | Diameter | | Color | Adhesive Type | Max. Static Load | | Std. Pkg. Qty. | Std. Ctn. Qty. |
|-------------|----------------------|-----|----------|------|---------|------|----------|------|----------|-----|------------|---------------|------------------|-----|----------------|----------------|
| | In. | mm | In. | mm | In. | mm | In. | mm | In. | mm | | | Lbs. | g | | |
| AJC12-A-C | .12 | 3.0 | 1.00 | 25.4 | .86 | 21.8 | .19 | 4.8 | .13 | 3.3 | Light Gray | Rubber | .40 | 182 | 100 | 1000 |
| AJC19-A-C | .19 | 4.8 | 1.25 | 31.8 | .87 | 22.1 | .26 | 6.6 | .18 | 4.6 | | | .50 | 227 | 100 | 1000 |
| AJC25-A-C | .25 | 6.4 | 1.50 | 38.1 | .97 | 24.6 | .31 | 7.9 | .23 | 5.8 | | | .60 | 272 | 100 | 1000 |
| AJC31-A-C | .31 | 7.9 | 1.75 | 44.5 | 1.22 | 30.1 | .40 | 10.2 | .29 | 7.4 | | | .90 | 408 | 100 | 1000 |
| AJC38-A-C | .38 | 9.6 | 2.00 | 50.8 | 1.27 | 32.3 | .50 | 12.7 | .39 | 9.9 | | | 1.00 | 454 | 100 | 1000 |

C4. Cable Management

A1C Type Clips

D1. Terminals

- Hold cords, cables, and tubing
- Single rubber adhesive pad for confined areas

- For indoor use only
- Material: PVC

D2. Power Connectors

D3. Grounding Connectors

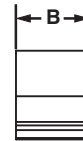
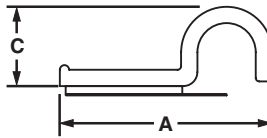
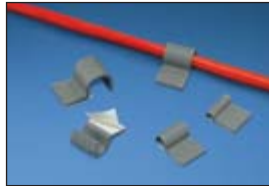

E1. Labeling Systems

E2. Labels

E3. Pre-Printed & Write-On Markers

E4. Permanent Identification

E5. Lockout/Tagout & Safety Solutions

F. Index

| Part Number | Max. Bundle Diameter | | Length A | | Width B | | Height C | | Color | Adhesive Type | Max. Static Load | | Std. Pkg. Qty. | Std. Ctn. Qty. |
|-------------|----------------------|------|----------|------|---------|------|----------|------|------------|---------------|------------------|-----|----------------|----------------|
| | In. | mm | In. | mm | In. | mm | In. | mm | | | Lbs. | g | | |
| A1C12-A-C8 | .12 | 3.0 | .77 | 19.6 | .63 | 16.0 | .23 | 5.8 | Light Gray | Rubber | .14 | 169 | 100 | 1000 |
| A1C25-A-C8 | .25 | 6.4 | .91 | 23.1 | .63 | 16.0 | .38 | 9.7 | | | .14 | 169 | 100 | 1000 |
| A1C38-A-C8 | .38 | 9.5 | 1.04 | 26.4 | .63 | 16.0 | .51 | 13.0 | | | .14 | 169 | 100 | 1000 |
| A1C50-A-C8 | .50 | 12.7 | 1.17 | 29.7 | .63 | 16.0 | .64 | 16.3 | | | .14 | 169 | 100 | 1000 |

A2C Type Clips

- Hold cords, cables, and tubing
- Two rubber adhesive pads for added strength

- For indoor use only
- Material: PVC

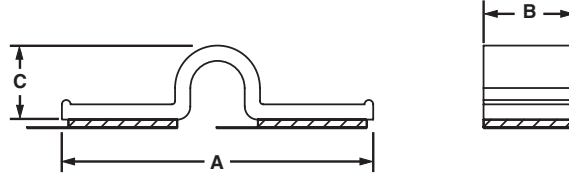

| Part Number | Max. Bundle Dia. | | Length A | | Width B | | Height C | | Color | Adhesive Type | Max. Static Load | | Std. Pkg. Qty. | Std. Ctn. Qty. |
|-------------|------------------|------|----------|------|---------|------|----------|------|------------|---------------|------------------|----|----------------|----------------|
| | In. | mm | In. | mm | In. | mm | In. | mm | | | Lbs. | g | | |
| A2C12-A-C8 | .12 | 3.0 | 1.30 | 33.0 | .63 | 16.0 | .23 | 5.8 | Light Gray | Rubber | .14 | 64 | 100 | 1000 |
| A2C25-A-C8 | .25 | 6.4 | 1.43 | 36.3 | .63 | 16.0 | .36 | 9.1 | | | .14 | 64 | 100 | 1000 |
| A2C38-A-C8 | .38 | 9.5 | 1.56 | 39.6 | .63 | 16.0 | .49 | 12.4 | | | .14 | 64 | 100 | 1000 |
| A2C50-A-C8 | .50 | 12.7 | 1.72 | 43.7 | .63 | 16.0 | .61 | 15.5 | | | .14 | 64 | 100 | 1000 |

Metal Adhesive Backed Cord Clips

- Can be opened and closed without damaging clip in order to remove or add cables quickly and easily

- Indoor use only

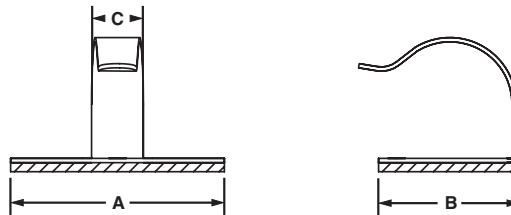

| Part Number | Max. Bundle Diameter | | Length A | | Width B | | Clip Width C | | Material | Adhesive Type | Max. Static Load | | Std. Pkg. Qty. | Std. Ctn. Qty. |
|-------------|----------------------|------|----------|------|---------|------|--------------|-----|-------------------|---------------|------------------|-----|----------------|----------------|
| | In. | mm | In. | mm | In. | mm | In. | mm | | | Lbs. | g | | |
| MACC25-A-C | .25 | 6.4 | .77 | 19.6 | .54 | 13.7 | .29 | 7.4 | Zinc Plated Steel | Rubber | .21 | 95 | 100 | 1000 |
| MACC62-A-C | .62 | 15.7 | 1.18 | 30.0 | .78 | 19.7 | .29 | 7.0 | | | .44 | 200 | 100 | 1000 |

A. System Overview

B1. Cable Ties

B2. Cable Accessories

B3. Stainless Steel Ties

C1. Wiring Duct

C2. Surface Raceway

C3. Abrasion Protection

C4. Cable Management

D1. Terminals

D2. Power Connectors

D3. Grounding Connectors

E1. Labeling Systems

E2. Labels

E3. Pre-Printed & Write-On Markers

E4. Permanent Identification

E5. Lockout/Tagout & Safety Solutions

F. Index

A. System Overview

Latching Wire Clips

- Route and secure cords and cables
- Convenient releasable latch
- Available in six sizes with releasable latch

- Push barb parts are for use with a max panel thickness of .11 inches (2.7mm) and a hole diameter of .22 inches (5.6mm)
- For indoor use only
- Material: Nylon 6.6

B1. Cable Ties

B2. Cable Accessories

B3. Stainless Steel Ties

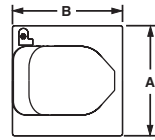
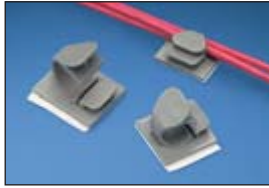

LWC**-A

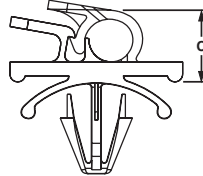
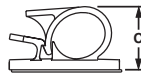

LWC**-H25

C1. Wiring Duct

C2. Surface Raceway

C3. Abrasion Protection

C4. Cable Management

D1. Terminals

D2. Power Connectors

D3. Grounding Connectors

E1. Labeling Systems

E2. Labels

E3. Pre-Printed & Write-On Markers

E4. Permanent Identification

E5. Lockout/Tagout & Safety Solutions

F. Index

| Part Number | Max. Bundle Diameter | | Length A | | Width B | | Height C | | Color | Mounting Method | Max. Static Load | | Std. Pkg. Qty. | Std. Ctn. Qty. |
|---------------------------------|----------------------|------|----------|------|---------|------|----------|------|---------|-----------------|------------------|------|----------------|----------------|
| | In. | mm | In. | mm | In. | mm | In. | mm | | | Lbs. | g | | |
| Adhesive Backed Products | | | | | | | | | | | | | | |
| LWC19-A-C | .19 | 4.8 | .85 | 21.6 | .61 | 15.5 | .39 | 9.9 | Natural | Rubber Adhesive | .25 | 113 | 100 | 1000 |
| LWC19-A-C14 | .19 | 4.8 | .85 | 21.6 | .61 | 15.5 | .39 | 9.9 | Gray | | .25 | 113 | 100 | 1000 |
| LWC19-A-C20 | .19 | 4.8 | .85 | 21.6 | .61 | 15.5 | .39 | 9.9 | Black | | .25 | 113 | 100 | 1000 |
| LWC25-A-C | .25 | 6.4 | .88 | 22.2 | 1.00 | 25.4 | .45 | 11.4 | Natural | | .45 | 204 | 100 | 1000 |
| LWC25-A-C14 | .25 | 6.4 | .88 | 22.2 | 1.00 | 25.4 | .45 | 11.4 | Gray | | .45 | 204 | 100 | 1000 |
| LWC25-A-C20 | .25 | 6.4 | .88 | 22.2 | 1.00 | 25.4 | .45 | 11.4 | Black | | .45 | 204 | 100 | 1000 |
| LWC38-A-C | .37 | 9.5 | 1.00 | 25.4 | 1.00 | 25.4 | .56 | 14.2 | Natural | | .50 | 227 | 100 | 1000 |
| LWC38-A-C14 | .37 | 9.5 | 1.00 | 25.4 | 1.00 | 25.4 | .56 | 14.2 | Gray | | .50 | 227 | 100 | 1000 |
| LWC38-A-C20 | .37 | 9.5 | 1.00 | 25.4 | 1.00 | 25.4 | .56 | 14.2 | Black | | .50 | 227 | 100 | 1000 |
| LWC50-A-L | .50 | 12.7 | 1.26 | 32.0 | 1.00 | 25.4 | .67 | 17.0 | Natural | | .63 | 284 | 50 | 500 |
| LWC50-A-L14 | .50 | 12.7 | 1.26 | 32.0 | 1.00 | 25.4 | .67 | 17.0 | Gray | | .63 | 284 | 50 | 500 |
| LWC50-A-L20 | .50 | 12.7 | 1.26 | 32.0 | 1.00 | 25.4 | .67 | 17.0 | Black | | .63 | 284 | 50 | 500 |
| LWC75-A-L | .75 | 19.1 | 1.48 | 37.6 | 1.24 | 31.5 | .90 | 22.9 | Natural | | .93 | 417 | 50 | 500 |
| LWC75-A-L14 | .75 | 19.1 | 1.48 | 37.6 | 1.24 | 31.5 | .90 | 22.9 | Gray | | .93 | 417 | 50 | 500 |
| LWC75-A-L20 | .75 | 19.1 | 1.48 | 37.6 | 1.24 | 31.5 | .90 | 22.9 | Black | | .93 | 417 | 50 | 500 |
| LWC100-A-L | 1.00 | 25.4 | 2.21 | 56.1 | 1.97 | 50.0 | 1.26 | 32.0 | Natural | | 2.25 | 1020 | 50 | 500 |
| LWC100-A-L14 | 1.00 | 25.4 | 2.21 | 56.1 | 1.97 | 50.0 | 1.26 | 32.0 | Gray | 2.25 | 1020 | 50 | 500 | |
| LWC100-A-L20 | 1.00 | 25.4 | 2.21 | 56.1 | 1.97 | 50.0 | 1.26 | 32.0 | Black | 2.25 | 1020 | 50 | 500 | |
| Push Mount Products | | | | | | | | | | | | | | |
| LWC19-H25-C | .19 | 4.8 | .85 | 21.6 | .51 | 12.8 | .41 | 10.4 | Natural | Push Barb | — | — | 100 | 1000 |
| LWC19-H25-C14 | .19 | 4.8 | .85 | 21.6 | .51 | 12.8 | .41 | 10.4 | Gray | | — | — | 100 | 1000 |
| LWC25-H25-C | .25 | 6.4 | .86 | 21.8 | .58 | 14.7 | .47 | 11.9 | Natural | | — | — | 100 | 1000 |
| LWC25-H25-C14 | .25 | 6.4 | .86 | 21.8 | .58 | 14.7 | .47 | 11.9 | Gray | | — | — | 100 | 1000 |
| LWC25-H25-C20 | .25 | 6.4 | .86 | 21.8 | .58 | 14.7 | .47 | 11.9 | Black | | — | — | 100 | 1000 |
| LWC38-H25-C | .37 | 9.5 | .94 | 23.9 | .58 | 14.7 | .57 | 14.5 | Natural | | — | — | 100 | 1000 |
| LWC38-H25-C14 | .37 | 9.5 | .94 | 23.9 | .58 | 14.7 | .57 | 14.5 | Gray | | — | — | 100 | 1000 |
| LWC38-H25-C20 | .37 | 9.5 | .94 | 23.9 | .58 | 14.7 | .57 | 14.5 | Black | | — | — | 100 | 1000 |
| LWC50-H25-L | .50 | 12.7 | 1.25 | 31.8 | .76 | 19.3 | .78 | 19.8 | Natural | | — | — | 50 | 500 |
| LWC50-H25-L14 | .50 | 12.7 | 1.25 | 31.8 | .76 | 19.3 | .78 | 19.8 | Gray | | — | — | 50 | 500 |
| LWC50-H25-L20 | .50 | 12.7 | 1.25 | 31.8 | .76 | 19.3 | .78 | 19.8 | Black | | — | — | 50 | 500 |
| LWC75-H25-L | .75 | 19.1 | 1.45 | 36.8 | .87 | 22.1 | .97 | 24.7 | Natural | | — | — | 50 | 500 |
| LWC75-H25-L14 | .75 | 19.1 | 1.45 | 36.8 | .87 | 22.1 | .97 | 24.7 | Gray | | — | — | 50 | 500 |
| LWC75-H25-L20 | .75 | 19.1 | 1.45 | 36.8 | .87 | 22.1 | .97 | 24.7 | Black | | — | — | 50 | 500 |
| LWC100-H25-L | 1.00 | 25.4 | 1.89 | 47.9 | 1.00 | 25.4 | 1.30 | 33.0 | Natural | | — | — | 50 | 500 |
| LWC100-H25-L14 | 1.00 | 25.4 | 1.89 | 47.9 | 1.00 | 25.4 | 1.30 | 33.0 | Gray | | — | — | 50 | 500 |
| LWC100-H25-L20 | 1.00 | 25.4 | 1.89 | 47.9 | 1.00 | 25.4 | 1.30 | 33.0 | Black | | — | — | 50 | 500 |

Bevel Entry Clips

- Beveled entry allows for easy insertion of cable bundle

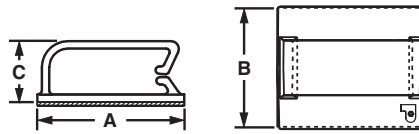

BEC

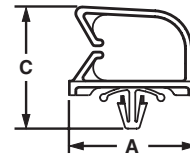

BECP

| Part Number | Max. Bundle Diameter | | Length A | | Width B | | Height C | | Material | Color | Environment | Mounting Method | Max. Static Load | | Std. Pkg. Qty. | Std. Ctn. Qty. |
|------------------------|----------------------|------|----------|------|---------|------|----------|------|-----------------------------|---------|-------------|------------------|------------------|-----|----------------|----------------|
| | In. | mm | In. | mm | In. | mm | In. | mm | | | | | Lbs. | g | | |
| Adhesive Backed | | | | | | | | | | | | | | | | |
| BEC38-A-L | .38 | 9.6 | 1.46 | 37.1 | 1.24 | 31.5 | .52 | 13.2 | Nylon 6.6 | Natural | Indoors | Rubber | .91 | 411 | 50 | 500 |
| BEC38-A-L20 | .38 | 9.6 | 1.46 | 37.1 | 1.24 | 31.5 | .52 | 13.2 | | Black | | Rubber | .91 | 411 | 50 | 500 |
| BEC38-AT-L0 | .38 | 9.6 | 1.46 | 37.1 | 1.24 | 31.5 | .52 | 13.2 | Weather Resistant Nylon 6.6 | Black | Outdoors | Acrylic | .91 | 411 | 50 | 500 |
| BEC62-A-L | .62 | 15.7 | 1.46 | 37.1 | 1.24 | 31.5 | .79 | 20.1 | Nylon 6.6 | Natural | Indoors | Rubber | .91 | 411 | 50 | 500 |
| BEC62-A-L20 | .62 | 15.7 | 1.46 | 37.1 | 1.24 | 31.5 | .79 | 20.1 | | Black | | Rubber | .91 | 411 | 50 | 500 |
| BEC62-AT-L0 | .62 | 15.7 | 1.46 | 37.1 | 1.24 | 31.5 | .79 | 20.1 | Weather Resistant Nylon 6.6 | Black | Outdoors | Acrylic | .91 | 411 | 50 | 500 |
| BEC75-A-L | .75 | 19.0 | 1.46 | 37.1 | 1.49 | 37.8 | .89 | 22.6 | Nylon 6.6 | Natural | Indoors | Rubber | 1.09 | 493 | 50 | 500 |
| BEC75-A-L20 | .75 | 19.0 | 1.46 | 37.1 | 1.49 | 37.8 | .89 | 22.6 | | Black | | Rubber | 1.09 | 493 | 50 | 500 |
| BEC75-AT-L0 | .75 | 19.0 | 1.46 | 37.1 | 1.49 | 37.8 | .89 | 22.6 | Weather Resistant Nylon 6.6 | Black | Outdoors | Acrylic Adhesive | 1.09 | 493 | 50 | 500 |
| Push Barb | | | | | | | | | | | | | | | | |
| BECP38H25-L | .38 | 9.6 | 1.46 | 37.1 | .73 | 18.5 | 1.00 | 25.4 | Nylon 6.6 | Natural | Indoors | Push Barb | — | — | 50 | 500 |
| BECP38H25-L20 | .38 | 9.6 | 1.46 | 37.1 | .73 | 18.5 | 1.00 | 25.4 | | Black | | | — | — | 50 | 500 |
| BECP75H25-L | .75 | 19.0 | 1.47 | 37.3 | .73 | 18.5 | 1.35 | 34.3 | | Natural | | | — | — | 50 | 500 |
| BECP75H25-L20 | .75 | 19.0 | 1.47 | 37.3 | .73 | 18.5 | 1.35 | 34.3 | | Black | | | — | — | 50 | 500 |

*For proper selection of adhesive see page B2.52.

A. System Overview

B1. Cable Ties

B2. Cable Accessories

B3. Stainless Steel Ties

C1. Wiring Duct

C2. Surface Raceway

C3. Abrasion Protection

C4. Cable Management

D1. Terminals

D2. Power Connectors

D3. Grounding Connectors

E1. Labeling Systems

E2. Labels

E3. Pre-Printed & Write-On Markers

E4. Permanent Identification

E5. Lockout/Tagout & Safety Solutions

F. Index

A. System Overview

Adhesive Backed Dual Cord Clip

- Holds two cables in high temperature applications

B1. Cable Ties

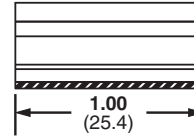
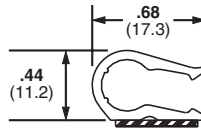

B2. Cable Accessories

B3. Stainless Steel Ties

| Part Number | Max. Bundle Diameter | | Material | Color | Environment | Adhesive Type | Max. Static Load | | Std. Pkg. Qty. | Std. Ctn. Qty. |
|---------------|----------------------|-----|----------|-------|-------------|---------------|------------------|-----|----------------|----------------|
| | In. | mm | | | | | Lbs. | g | | |
| ADCC31-AT-C10 | .33 | 9.0 | NORYL* | White | Indoors | Acrylic | .25 | 113 | 100 | 500 |

*NORYL Thermoplastic Resin is a registered trademark of General Electric Company.

C1. Wiring Duct

C2. Surface Raceway

Adhesive Backed Mount Cord Clip

- Holds a single cable
- Funnel entry speeds cable insertion
- Vertical cable entry for ease of installation

C3. Abrasion Protection

C4. Cable Management

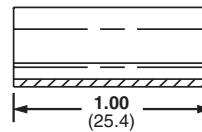
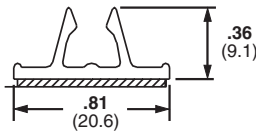

D1. Terminals

D2. Power Connectors

| Part Number | Max. Bundle Diameter | | Material | Color | Environment | Adhesive Type | Max. Static Load | | Std. Pkg. Qty. | Std. Ctn. Qty. |
|--------------|----------------------|-----------|----------|-------|-------------|---------------|------------------|-----|----------------|----------------|
| | In. | mm | | | | | Lbs. | g | | |
| AMC25-AT-C10 | .22 – .28 | 6.0 – 7.0 | PVC | White | Indoors | Acrylic | .40 | 182 | 100 | 1000 |

D3. Grounding Connectors

E1. Labeling Systems

Vertical Cord Clips

- Funnel entry design allows for easy insertion of cords and cables
- For indoor use only
- Vertical cable entry for ease of installation

E2. Labels

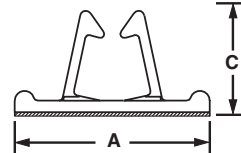
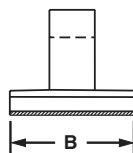
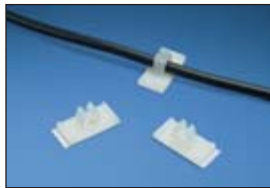

E3. Pre-Printed & Write-On Markers

E4. Permanent Identification

| Part Number | Max. Bundle Diameter | | Length A | | Width B | | Height C | | Material | Color | Adhesive Type | Max. Static Load | | Std. Pkg. Qty. | Std. Ctn. Qty. |
|-------------|----------------------|------|----------|------|---------|------|----------|------|-----------|---------|---------------|------------------|-----|----------------|----------------|
| | In. | mm | In. | mm | In. | mm | In. | mm | | | | Lbs. | g | | |
| VCC25-A-C | .25 | 6.4 | 1.00 | 25.4 | .50 | 12.7 | .44 | 11.2 | Nylon 6.6 | Natural | Rubber | .25 | 113 | 100 | 500 |
| VCC50-A-C | .50 | 12.7 | 1.56 | 39.7 | 1.00 | 25.4 | .81 | 20.6 | | | | Natural | .78 | 339 | 100 |

E5. Lockout/Tagout & Safety Solutions

F. Index

Adhesive Backed Latching Clips

- Latching cover withstands vibration

- For indoor use only

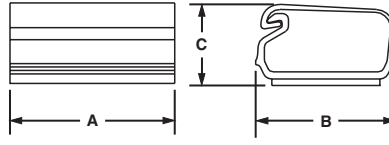

| Part Number | Max. Bundle Diameter | | Length A | | Width B | | Height C | | Material | Color | Adhesive Type | Max. Static Load | | Std. Pkg. Qty. | Std. Ctn. Qty. |
|-------------|----------------------|------|----------|------|---------|------|----------|------|----------|------------|---------------|------------------|-----|----------------|----------------|
| | In. | mm | In. | mm | In. | mm | In. | mm | | | | Lbs. | g | | |
| LC3-A-C8 | .20 | 5.0 | .75 | 19.1 | .75 | 19.0 | .47 | 11.9 | PVC | Light Gray | Rubber | .22 | 100 | 100 | 1000 |
| LC5-A-C8 | .36 | 9.1 | 1.01 | 25.7 | 1.01 | 25.7 | .61 | 15.5 | | | | .44 | 200 | 100 | 1000 |
| LC10-A-L8 | .93 | 23.6 | 1.51 | 38.4 | 1.51 | 38.4 | .84 | 21.3 | | | | .60 | 272 | 50 | 500 |

Cable Holder – Adhesive Backed

- Convenient releasable latch allows easy addition and removal of cables

- Low profile design provides a compact cable routing solution
- For indoor use only

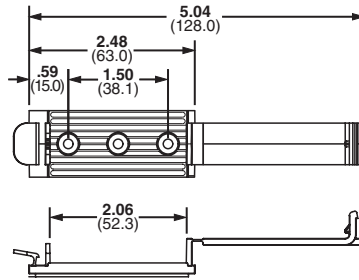

| Part Number | Cable Width | | Material | Color | Mounting Method | Max. Static Load | | Std. Pkg. Qty. | Std. Ctn. Qty. |
|--------------|-------------|------|-----------|-------|-----------------|------------------|-----|----------------|----------------|
| | In. | mm | | | | Lbs. | g | | |
| CH105-A-C14 | 2.06 | 52.3 | Nylon 6.6 | Gray | Rubber Adhesive | 1.28 | 581 | 100 | 1000 |
| CH105-S6-C14 | 2.06 | 52.3 | | | #6 (M3) screw | — | — | 100 | 1000 |

Low Profile Flat Cable Mounts

- Three sizes provide a cost effective flat cable containment for stack heights up to .105 inches (2.7mm)
- Features a matte, textured surface, for either hand written identification or application of computer labels

- Low profile design holds wires, cables, and tubing
- For indoor use only

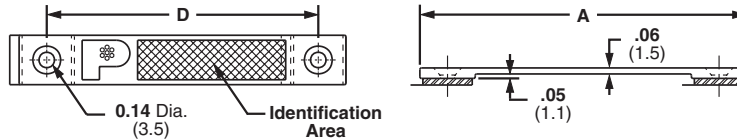
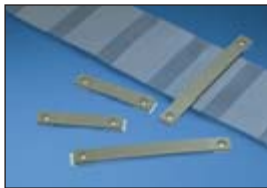

| Part Number | Cable Width | | Length A | | Hole Spacing D | | Material | Color | Adhesive Type | Std. Pkg. Qty. | Std. Ctn. Qty. |
|---------------|-------------|------|----------|-------|----------------|-------|-----------|-------|---------------|----------------|----------------|
| | In. | mm | In. | mm | In. | mm | | | | | |
| LPFCM14-A-C14 | 1.44 | 37.0 | 2.56 | 65.0 | 2.00 | 50.8 | Nylon 6.6 | Gray | Rubber | 100 | 500 |
| LPFCM22-A-C14 | 2.19 | 56.0 | 3.31 | 84.0 | 2.75 | 69.9 | | | | 100 | 500 |
| LPFCM34-A-C14 | 3.44 | 87.0 | 4.56 | 115.8 | 4.00 | 101.6 | | | | 100 | 500 |

A. System Overview

Latching Flat Cable Mounts

B1. Cable Ties

- Available in four sizes with a stack height of .17 inches (4.3mm) to accommodate different flat cable widths
- Low profile design holds wires, cables, and tubing
- Convenient releasable latch
- Large mounting base for high bonding strength
- For indoor use only
- Material: Nylon 6.6

B2. Cable Accessories

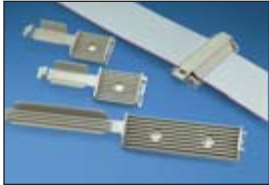

B3. Stainless Steel Ties

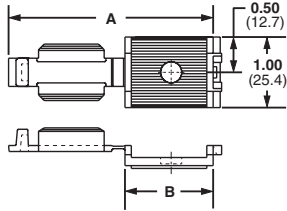

FCM1 and FCM1.2

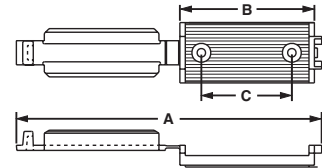

FCM2 and FCM3.25

C1. Wiring Duct

C2. Surface Raceway

C3. Abrasion Protection

C4. Cable Management

D1. Terminals

D2. Power Connectors

D3. Grounding Connectors

E1. Labeling Systems

E2. Labels

E3. Pre-Printed & Write-On Markers

E4. Permanent Identification

E5. Lockout/Tagout & Safety Solutions

F. Index

| Part Number | Cable Width | | Length A | | Width B | | Hole Spacing C | | Color | Mounting Method | Std. Pkg. Qty. | Std. Ctn. Qty. |
|------------------------|-------------|------|----------|-------|---------|------|----------------|------|-------|-----------------|----------------|----------------|
| | In. | mm | In. | mm | In. | mm | In. | mm | | | | |
| Adhesive Backed | | | | | | | | | | | | |
| FCM1-A-C14 | 1.05 | 26.7 | 2.90 | 73.7 | 1.05 | 26.7 | — | — | Gray | Rubber Adhesive | 100 | 500 |
| FCM1.2-A-C14 | 1.20 | 30.5 | 3.16 | 80.3 | 1.37 | 34.8 | — | — | | | 100 | 1000 |
| FCM2-A-C14 | 2.05 | 52.1 | 5.06 | 128.5 | 2.22 | 56.4 | 1.53 | 38.9 | | | 100 | 500 |
| FCM3.25-A-L14 | 3.38 | 85.9 | 7.30 | 185.4 | 3.38 | 85.9 | 1.50 | 38.1 | | | 50 | 500 |
| Screw Mounted | | | | | | | | | | | | |
| FCM1-S6-C14 | 1.05 | 26.7 | 2.90 | 73.7 | 1.00 | 25.4 | — | — | Gray | #6 (M3) Screw | 100 | 1000 |
| FCM1.2-S6-C14 | 1.20 | 30.5 | 3.16 | 80.3 | 1.37 | 34.8 | — | — | | | 100 | 1000 |
| FCM2-S6-C14 | 2.05 | 52.1 | 5.06 | 128.5 | 2.22 | 56.4 | 1.53 | 38.9 | | | 100 | 1000 |
| FCM3.25-S6-L14 | 3.38 | 85.9 | 7.30 | 185.4 | 3.38 | 85.9 | 1.50 | 38.1 | | | 50 | 500 |

Latching Flat Cable Holders

- Designed for flat cable up to a cable stack height of .25 inches (6.4mm) or discrete wire
- Low profile design holds wires, cables, and tubing
- Convenient releasable latch
- Large mounting base for high bonding strength
- For indoor use only

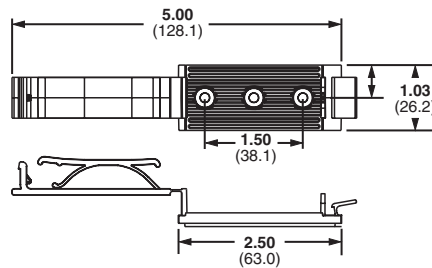

| Part Number | Length | | Cable Width | | Color | Mounting Method | Std. Pkg. Qty. | Std. Ctn. Qty. |
|-------------|--------|------|-------------|------|-------|-----------------|----------------|----------------|
| | In. | mm | In. | mm | | | | |
| FCH2-A-C14 | 2.48 | 63.0 | 2.00 | 50.8 | Gray | Rubber Adhesive | 100 | 500 |
| FCH2-S6-C14 | 2.48 | 63.0 | 2.00 | 50.8 | Gray | #6 (M3) Screw | 100 | 500 |

Flat Cable Clips

- Use with any width flat cable for a maximum stack height of .17 inches (4.3mm)
- Low profile design holds wires, cables, and tubing
- For indoor use only
- Material: PVC

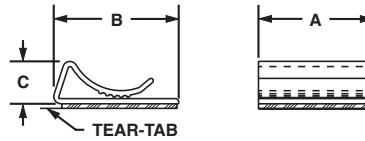
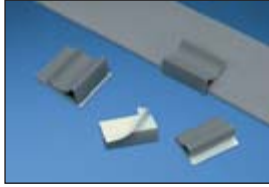

| Part Number | Cable Width | Length A | | Width B | | Height C | | Color | Mounting Method | Std. Pkg. Qty. | Std. Ctn. Qty. |
|-------------|----------------------|----------|------|---------|------|----------|-----|-------|-----------------|----------------|----------------|
| | | In. | mm | In. | mm | In. | mm | | | | |
| FCC5-A-C8 | Any width flat cable | 1.00 | 25.4 | .56 | 14.2 | .29 | 7.4 | Gray | Rubber | 100 | 1000 |
| FCC-A-C8 | | 1.00 | 25.4 | 1.09 | 27.7 | .38 | 9.7 | | | 100 | 1000 |

PAN-CLAMP™ Heavy Duty Fixed Diameter Clamps

- One-piece design significantly reduces installation time
- Integrated ribs prevent rotation of cable bundles and ensures secure grip on hoses
- Material: Impact modified Weather Resistant Nylon 6.6

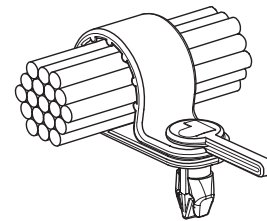
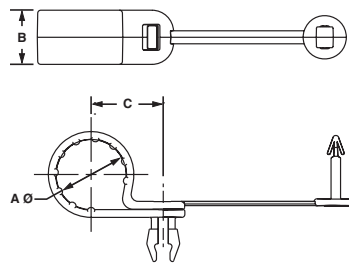

| Part Number | Max. Bundle Diameter A | | Width B | | Bundle Offset C | | Max. Panel Thickness | | Panel Hole Diameter | | Color | Std. Pkg. Qty. | Std. Ctn. Qty. |
|---------------|------------------------|------|---------|------|-----------------|------|----------------------|-----|---------------------|-----|-------|----------------|----------------|
| | In. | mm | In. | mm | In. | mm | In. | mm | In. | mm | | | |
| PC038-H25D-C0 | .38 | 9.5 | .62 | 15.7 | .64 | 16.3 | .13 | 3.2 | .28 | 7.1 | Black | 100 | 500 |
| PC050-H25D-C0 | .50 | 12.7 | .62 | 15.7 | .71 | 17.9 | .13 | 3.2 | .28 | 7.1 | | 100 | 500 |
| PC062-H25D-C0 | .63 | 15.8 | .62 | 15.7 | .77 | 19.5 | .13 | 3.2 | .28 | 7.1 | | 100 | 500 |
| PC075-H25D-C0 | .75 | 19.1 | .62 | 15.7 | .83 | 21.1 | .13 | 3.2 | .28 | 7.1 | | 100 | 1000 |
| PC087-H25D-C0 | .88 | 22.1 | .62 | 15.7 | .89 | 22.7 | .13 | 3.2 | .28 | 7.1 | | 100 | 1000 |
| PC100-H25D-C0 | 1.00 | 25.4 | .62 | 15.7 | .96 | 24.3 | .13 | 3.2 | .28 | 7.1 | | 100 | 1000 |
| PC112-H25D-C0 | 1.13 | 28.5 | .62 | 15.7 | 1.02 | 25.8 | .13 | 3.2 | .28 | 7.1 | | 100 | 1000 |
| PC125-H25D-C0 | 1.25 | 31.8 | .62 | 15.7 | 1.08 | 27.4 | .13 | 3.2 | .28 | 7.1 | | 100 | 1000 |

A.
System
Overview

Fixed Diameter Cable Clamps

- Durable Nylon 6.6 cable clamps

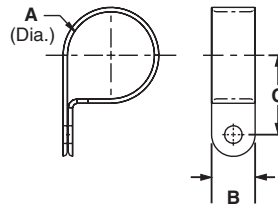

B1.
Cable Ties

B2.
Cable
Accessories

B3.
Stainless
Steel Ties

C1.
Wiring
Duct

C2.
Surface
Raceway

C3.
Abrasion
Protection

C4.
Cable
Management

D1.
Terminals

D2.
Power
Connectors

D3.
Grounding
Connectors

E1.
Labeling
Systems

E2.
Labels

E3.
Pre-Printed
& Write-On
Markers

E4.
Permanent
Identification

E5.
Lockout/
Tagout/
& Safety
Solutions

F.
Index

| Part Number | Max. Bundle Diameter A | | Width B | | Bundle Offset C | | Mounting Method | Std. Pkg. Qty | Std. Ctn. Qty. |
|--------------------|---------------------------|------|------------|------|--------------------|------|-----------------|---------------|----------------|
| | In. | mm | In. | mm | In. | mm | | | |
| CCS12-S8-C | .12 | 3.1 | .37 | 9.4 | .33 | 8.4 | #8 (M4) Screw | 100 | 500 |
| CCS19-S8-C | .19 | 4.8 | .37 | 9.4 | .43 | 10.9 | #8 (M4) Screw | 100 | 500 |
| CCS25-S8-C | .25 | 6.3 | .37 | 9.4 | .41 | 10.4 | #8 (M4) Screw | 100 | 500 |
| CCS25-S10-C | .25 | 6.3 | .37 | 9.4 | .41 | 10.4 | #10 (M5) Screw | 100 | 500 |
| CCS31-S8-C | .31 | 7.9 | .37 | 9.4 | .49 | 12.4 | #8 (M4) Screw | 100 | 500 |
| CCS38-S8-C | .38 | 9.5 | .37 | 9.4 | .59 | 15.0 | | 100 | 500 |
| CCS44-S8-C | .44 | 11.1 | .37 | 9.4 | .57 | 14.5 | | 100 | 500 |
| CCS50-S8-C | .50 | 12.7 | .37 | 9.4 | .60 | 15.2 | | 100 | 500 |
| CCH12-S10-C | .12 | 3.1 | .50 | 12.7 | .36 | 9.1 | #10 (M5) Screw | 100 | 500 |
| CCH19-S10-C | .19 | 4.8 | .50 | 12.7 | .42 | 10.7 | | 100 | 500 |
| CCH25-S10-C | .25 | 6.3 | .50 | 12.7 | .46 | 11.7 | | 100 | 500 |
| CCH31-S10-C | .31 | 7.9 | .50 | 12.7 | .50 | 12.7 | | 100 | 500 |
| CCH38-S10-C | .38 | 9.5 | .50 | 12.7 | .53 | 13.5 | | 100 | 500 |
| CCH44-S10-C | .44 | 11.1 | .50 | 12.7 | .56 | 14.2 | | 100 | 500 |
| CCH50-S10-C | .50 | 12.7 | .50 | 12.7 | .59 | 15.0 | | 100 | 500 |
| CCH56-S10-C | .56 | 14.2 | .50 | 12.7 | .61 | 15.5 | | 100 | 500 |
| CCH62-S10-C | .62 | 15.7 | .50 | 12.7 | .65 | 16.5 | | 100 | 500 |
| CCH69-S10-C | .69 | 17.5 | .50 | 12.7 | .75 | 19.1 | | 100 | 500 |
| CCH75-S10-C | .75 | 19.1 | .50 | 12.7 | .78 | 19.8 | | 100 | 500 |
| CCH81-S10-C | .81 | 20.6 | .50 | 12.7 | .81 | 20.6 | | 100 | 500 |
| CCH87-S10-C | .87 | 22.1 | .50 | 12.7 | .84 | 21.3 | | 100 | 500 |
| CCH100-S10-C | 1.00 | 25.4 | .50 | 12.7 | .91 | 23.1 | | 100 | 500 |
| CCH112-S10-C | 1.12 | 28.4 | .50 | 12.7 | .97 | 24.6 | 100 | 500 | |
| CCH119-S10-C | 1.19 | 30.2 | .50 | 12.7 | 1.00 | 25.4 | 100 | 500 | |
| CCH125-S10-C | 1.25 | 31.8 | .50 | 12.7 | 1.06 | 26.9 | 100 | 500 | |
| CCH138-S10-C | 1.37 | 34.8 | .50 | 12.7 | 1.12 | 28.4 | 100 | 500 | |
| CCH150-S10-C | 1.50 | 38.1 | .50 | 12.7 | 1.19 | 30.2 | 100 | 500 | |

All parts listed are also available in black weather resistant material (add suffix 0). Bulk package only.

Wire Retainers

- Wires slide into the clip and are held in place by tension
- Low profile design holds wires, cables, and tubing
- Funnel entry design allows for easy insertion of cords and cables

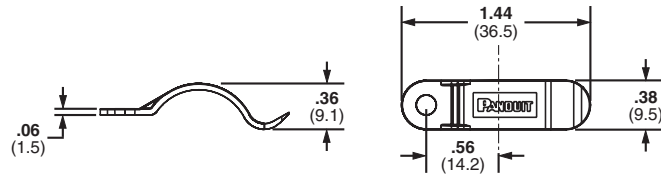

| Part Number | Max. Bundle Diameter | | Material | Color | Environment | Mounting Method | Std. Pkg. Qty. | Std. Ctn. Qty. |
|-------------|----------------------|-----|-----------------------------|---------|-------------|-----------------|----------------|----------------|
| | In. | mm | | | | | | |
| TWR-C | .38 | 9.5 | Nylon 6.6 | Natural | Indoors | #6 (M3) Screw | 100 | 500 |
| TWR-C0 | .38 | 9.5 | Weather Resistant Nylon 6.6 | Black | Outdoors | | 100 | 500 |

Tack Clips

- Clips secure cords, cables, and tubing
- Suitable for outdoor use
- Hardened steel nail securely mounts to wooden surfaces
- Material: Weather Resistant Polypropylene

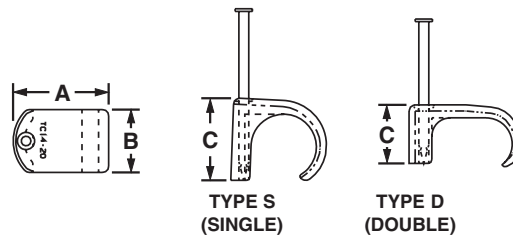

| Part Number | Type | Max. Bundle Diameter | | Length A | | Width B | | Height C | | Coaxial Cross RG# | Color | Std. Pkg. Qty. | Std. Ctn. Qty. |
|--------------|--------|----------------------|-----------|----------|------|---------|------|----------|------|-------------------|-------|----------------|----------------|
| | | In. | mm | In. | mm | In. | mm | In. | mm | | | | |
| TC3-5-C100 | Single | .13 | 3.3 | .29 | 7.4 | .23 | 5.8 | .20 | 5.1 | 187 | Black | 100 | 1000 |
| TC5-7-C100 | Single | .21 | 5.3 | .39 | 9.9 | .23 | 5.8 | .31 | 7.9 | 58 | | 100 | 1000 |
| TC7-10-C100 | Single | .27 | 6.9 | .49 | 12.5 | .35 | 8.9 | .38 | 9.7 | 59 | | 100 | 1000 |
| TC10-14-C100 | Single | .35 | 8.9 | .59 | 14.9 | .45 | 11.4 | .51 | 13 | 6A | | 100 | 1000 |
| TC14-20-C100 | Single | .52 | 13.2 | .79 | 20.6 | .54 | 13.7 | .67 | 17 | 8A, 9B, 11 | | 100 | 1000 |
| TC5X8-C100 | Double | .20 x .31 | 5.0 x 7.9 | .54 | 13.7 | .27 | 6.8 | .30 | 8.8 | — | | 100 | 1000 |
| TC6X10-C100 | Double | .23 x .38 | 6.0 x 9.7 | .62 | 15.7 | .34 | 8.6 | .34 | 8.6 | — | | 100 | 1000 |
| TC7X14-C100 | Double | .25 x .46 | 6.4 x 12 | .70 | 17.8 | .43 | 10.9 | .36 | 9.1 | — | | 100 | 1000 |
| TC9X18-C100 | Double | .37 x .65 | 9.4 x 17 | .89 | 22.6 | .52 | 13.2 | .50 | 12.7 | — | | 100 | 1000 |

A. System Overview

Siding Clips

- Low profile installs without drilling or nailing
- Attach coax cable to buildings having "Pittsburgh Interlok" type aluminum or steel siding
- Will not corrode or stain siding

B1. Cable Ties

B2. Cable Accessories

B3. Stainless Steel Ties

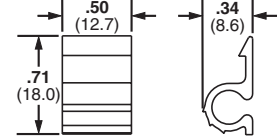
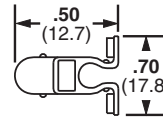
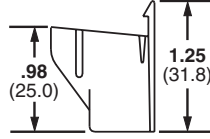
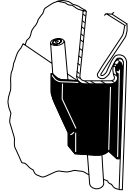
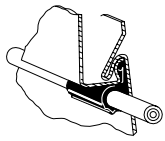

Horizontal Siding Clip

Vertical Siding Clip

VSC Vertical Clip

HSC Horizontal Clip

C1. Wiring Duct

C2. Surface Raceway

C3. Abrasion Protection

| Part Number | Max. Bundle Diameter | | Material | Color | Mounting Method | Std. Pkg. Qty. | Std. Ctn. Qty. |
|-------------|----------------------|-----|---------------------------------|-------|-----------------|----------------|----------------|
| | In. | mm | | | | | |
| HSC.25-L | .25 | 6.4 | Nylon 6.6 | White | Clip | 50 | 500 |
| HSC.25-L100 | .25 | 6.4 | Weather Resistant Polypropylene | Black | | 50 | 500 |
| VSC.25-L | .25 | 6.4 | Nylon 6.6 | White | | 50 | 500 |
| VSC.25-L100 | .25 | 6.4 | Weather Resistant Polypropylene | Black | | 50 | 500 |

C4. Cable Management

Wire Standoffs

- For retaining wires, cable, components or tubing away from panel or conductive chassis
- Design of wing provides added stability
- Material: Nylon 6.6
- Finger grip flanges can be easily locked or unlocked for revisions
- Indoor use only

D1. Terminals

D2. Power Connectors

D3. Grounding Connectors

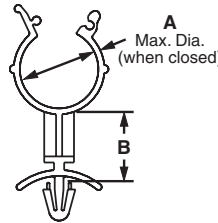

E1. Labeling Systems

E2. Labels

E3. Pre-Printed & Write-On Markers

E4. Permanent Identification

E5. Lockout/Tagout & Safety Solutions

F. Index

| Part Number | Max. Bundle Diameter A | | Standoff Height B | | Max. Panel Thickness | | Panel Hole Diameter | | Color | Mounting Method | Std. Pkg. Qty. | Std. Ctn. Qty. |
|-------------|------------------------|------|-------------------|------|----------------------|-----|---------------------|-----|---------|-----------------|----------------|----------------|
| | In. | mm | In. | mm | In. | mm | In. | mm | | | | |
| WS25-25-C | .25 | 6.4 | .25 | 6.4 | .08 | 2.0 | .19 | 4.7 | Natural | Push Barb | 100 | 500 |
| WS25-50-C | .25 | 6.4 | .50 | 12.7 | .08 | 2.0 | .19 | 4.7 | | | 100 | 500 |
| WS25-75-C | .25 | 6.4 | .75 | 19.1 | .08 | 2.0 | .19 | 4.7 | | | 100 | 500 |
| WS35-25-C | .35 | 8.9 | .25 | 6.4 | .08 | 2.0 | .19 | 4.7 | | | 100 | 500 |
| WS35-50-C | .35 | 8.9 | .50 | 12.7 | .08 | 2.0 | .19 | 4.7 | | | 100 | 500 |
| WS35-75-C | .35 | 8.9 | .75 | 19.1 | .08 | 2.0 | .19 | 4.7 | | | 100 | 500 |
| WS50-25-C | .47 | 11.9 | .25 | 6.4 | .08 | 2.0 | .19 | 4.7 | | | 100 | 500 |
| WS50-50-C | .47 | 11.9 | .50 | 12.7 | .08 | 2.0 | .19 | 4.7 | | | 100 | 500 |
| WS50-75-C | .47 | 11.9 | .75 | 19.1 | .08 | 2.0 | .19 | 4.7 | | | 100 | 500 |
| WS75-25-C | .78 | 19.8 | .25 | 6.4 | .08 | 2.0 | .19 | 4.7 | | | 100 | 500 |
| WS75-50-C | .78 | 19.8 | .50 | 12.7 | .08 | 2.0 | .19 | 4.7 | | | 100 | 500 |
| WS75-75-C | .78 | 19.8 | .75 | 19.1 | .08 | 2.0 | .19 | 4.7 | | | 100 | 500 |

Snap-In Clips

- Clip around bundle to hold securely in place
- Clips are placed on the bundle then attached to the panel

- Material: Nylon 6.6
- Indoor use only

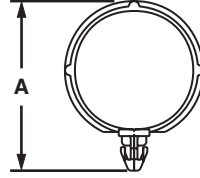

| Part Number | Max. Bundle Diameter | | Height A | | Max. Panel Thickness | | Panel Hole Diameter | | Color | Mounting Method | Std. Pkg. Qty. | Std. Ctn. Qty. |
|-------------|----------------------|------|----------|------|----------------------|-----|---------------------|-----|---------|-----------------|----------------|----------------|
| | In. | mm | In. | mm | In. | mm | In. | mm | | | | |
| SICH25-C | .25 | 6.4 | .40 | 20.9 | .10 | 2.5 | .25 | 6.4 | Natural | Push Barb | 100 | 500 |
| SICH38-C | .38 | 9.7 | .54 | 24.9 | .10 | 2.5 | .25 | 6.4 | | | 100 | 500 |
| SICH50-C | .50 | 12.7 | .67 | 28.2 | .10 | 2.5 | .25 | 6.4 | | | 100 | 500 |
| SICH75-C | .75 | 19.1 | .96 | 35.6 | .10 | 2.5 | .25 | 6.4 | | | 100 | 500 |
| SICH100-C | 1.00 | 25.4 | 1.21 | 41.9 | .10 | 2.5 | .25 | 6.4 | | | 100 | 500 |
| SICH150-C | 1.50 | 38.0 | 1.71 | 54.6 | .10 | 2.5 | .25 | 6.4 | | | 100 | 500 |

Wire Saddles

- Funnel entry design for fast insertion of wires and cables
- Available in vertical and horizontal loading configurations
- Design of wing provides added stability

- Material: Nylon 6.6
- Indoor use only



VWS Vertical

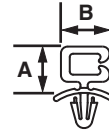

HWS Horizontal

| Part Number | Max. Bundle Capacity | | Height A | | Width B | | Max. Panel Thickness | | Panel Hole Diameter | | Color | Mounting Method | Std. Pkg. Qty. | Std. Ctn. Qty. |
|-------------|----------------------|-------------|----------|------|---------|------|----------------------|-----|---------------------|-----|---------|-----------------|----------------|----------------|
| | In. | mm | In. | mm | In. | mm | In. | mm | In. | mm | | | | |
| VWS4218-C | .18 x .42 | 5.0 x 11.0 | .58 | 14.7 | .60 | 15.2 | .08 | 2.0 | .19 | 4.7 | Natural | Push Barb | 100 | 500 |
| VWS4238-C | .40 x .42 | 10.2 x 11.0 | .78 | 19.8 | .60 | 15.2 | .08 | 2.0 | .19 | 4.7 | | | 100 | 500 |
| VWS4274-C | .74 x .42 | 19.0 x 11.0 | 1.14 | 29.0 | .60 | 15.2 | .08 | 2.0 | .19 | 4.7 | | | 100 | 500 |
| VWS42105-C | 1.05 x .42 | 27.0 x 11.0 | 1.45 | 36.8 | .60 | 15.2 | .08 | 2.0 | .19 | 4.7 | | | 100 | 1000 |
| HWS2819-C | .19 x .28 | 5.0 x 11.0 | .42 | 10.7 | .44 | 11.2 | .08 | 2.0 | .19 | 4.7 | | | 100 | 500 |

A. System Overview

Optical Fiber Network Saddle

B1. Cable Ties

- Use in pre-drilled .18 inch (4.0mm) holes in panels up to .09 inches (2.0mm) thick

- Smooth rounded edges eliminate potential for snagging and stress on cable

B2. Cable Accessories



B3. Stainless Steel Ties

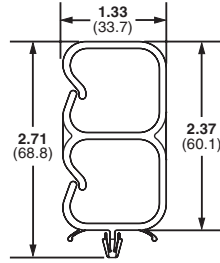

VWSDC

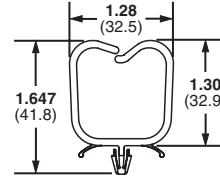

VWS106

| Part Number | Max. Bundle Diameter | | Material | Mounting Method | Color | Std. Pkg. Qty. | Std. Ctn. Qty. |
|-------------|----------------------|------|-----------|-----------------|---------|----------------|----------------|
| | In. | mm | | | | | |
| VWSDC-C* | 1.06 | 26.9 | Nylon 6.6 | Push Mount | Natural | 100 | 500 |
| VWS106-C | 1.06 | 26.9 | Nylon 6.6 | Push Mount | Natural | 100 | 500 |

*Accepts two bundles.

C1. Wiring Duct

C2. Surface Raceway

C3. Abrasion Protection

C4. Cable Management

D1. Terminals

Harness Clips

- Integral “spring” holds wire bundles tightly
- Available in vertical and horizontal loading configurations

- Design of wing provides added stability

D2. Power Connectors

D3. Grounding Connectors

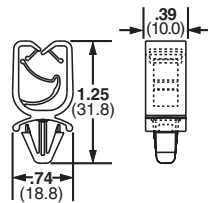

HCMP06B

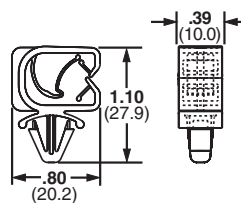

HCMP06C

E1. Labeling Systems

E2. Labels

E3. Pre-Printed & Write-On Markers

E4. Permanent Identification

E5. Lockout/Tagout & Safety Solutions

F. Index

| Part Number | Max. Bundle Diameter Range | | Max. Panel Thickness | | Panel Hole Diameter | | Material | Color | Mounting Method | Std. Pkg. Qty. | Std. Ctn. Qty. |
|---------------|----------------------------|------------|----------------------|-----|---------------------|-----|-----------|-------|-----------------|----------------|----------------|
| | In. | mm | In. | mm | In. | mm | | | | | |
| HCMP06B12-C20 | .24 – .47 | 5.9 – 12.5 | .118 | 3.0 | .25 | 6.4 | Nylon 6.6 | Black | Push Mount | 100 | 500 |
| HCMP06C12-C20 | .24 – .47 | 5.9 – 12.5 | .105 | 2.7 | .25 | 6.4 | | | | 100 | 500 |



Nylon Edge Clips

- Integral “spring” holds wire bundles tightly
- Available in vertical and horizontal loading configurations
- Design of wing provides added stability
- Indoor/Outdoor use

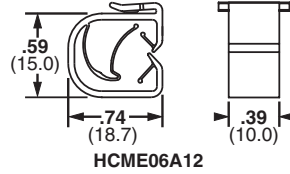

| Part Number | Max. Bundle Diameter Range | | Max. Panel Thickness | | Material | Color | Mounting Method | Std. Pkg. Qty. | Std. Ctn. Qty. |
|----------------|----------------------------|------------|----------------------|-----|---------------------------|-------|-----------------|----------------|----------------|
| | In. | mm | In. | mm | | | | | |
| HCME04Y09-C30* | .16 – .35 | 4.0 – 9.0 | .16 | 4.0 | Nylon 6.6 Heat Stabilized | Black | Clip-on | 100 | — |
| HCME06A12-C130 | .24 – .47 | 5.9 – 12.5 | .05 | 1.2 | Acetal Heat Stabilized | | | 100 | 500 |
| HCME06Y12-C30* | .16 – .35 | 4.0 – 9.0 | .16 | 4.0 | Nylon 6.6 Heat Stabilized | | | 100 | — |

*Bulk packaging size available.

Wire Bundle Strap

- Securely routes large cable bundles
- Rounded edges prevent damage to cable jackets

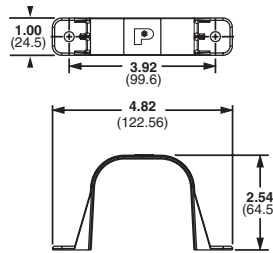

| Part Number | Bundle Retaining Area In. ² | Material | Color | Mounting Method | Std. Pkg. Qty. | Std. Ctn. Qty. |
|---------------|--|----------|-------|----------------------|----------------|----------------|
| WBS6-Q | 6.00 | ABS | White | (2) 1/4" (M6) Screws | 25 | 125 |

A. System Overview

B1. Cable Ties

B2. Cable Accessories

B3. Stainless Steel Ties

C1. Wiring Duct

C2. Surface Raceway

C3. Abrasion Protection

C4. Cable Management

D1. Terminals

D2. Power Connectors

D3. Grounding Connectors

E1. Labeling Systems

E2. Labels

E3. Pre-Printed & Write-On Markers

E4. Permanent Identification

E5. Lockout/Tagout & Safety Solutions

F. Index

A.
System
Overview

Circuit Board Posts

B1.
Cable Ties

- For board-to-board or board-to-chassis mounting
- Bell flange on bottom end provides greater stability
- Releasable and reusable

- Material: Nylon 6.6
- Color: Natural

B2.
Cable
Accessories



B3.
Stainless
Steel Ties

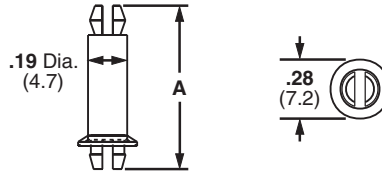

| Part Number | Standoff Height | | Height A | | Panel Hole Diameter | | Mounting Method | Std. Pkg. Qty. | Std. Ctn. Qty. |
|-----------------|-----------------|------|----------|------|---------------------|------|-----------------|----------------|----------------|
| | In. | mm | In. | mm | In. | mm | | | |
| CBP12-C | .12 | 3.0 | .40 | 10.2 | .156 | 3.96 | Push Bar | 100 | 500 |
| CBP25-C | .25 | 6.4 | .54 | 13.5 | .156 | 3.96 | | 100 | 500 |
| CBP31-C | .31 | 7.9 | .59 | 15.0 | .156 | 3.96 | | 100 | 500 |
| CBP37-C | .37 | 9.4 | .62 | 15.7 | .156 | 3.96 | | 100 | 500 |
| CBP50-C | .50 | 12.7 | .78 | 19.8 | .156 | 3.96 | | 100 | 500 |
| CBP62-C | .62 | 15.7 | .91 | 23.0 | .156 | 3.96 | | 100 | 500 |
| CBP75-C | .75 | 19.1 | 1.04 | 26.2 | .156 | 3.96 | | 100 | 500 |
| CBP87-C | .87 | 22.1 | 1.15 | 29.2 | .156 | 3.96 | | 100 | 500 |
| CBP100-C | 1.00 | 25.4 | 1.28 | 32.5 | .156 | 3.96 | | 100 | 500 |

C1.
Wiring
Duct

C2.
Surface
Raceway

C3.
Abrasion
Protection

C4.
Cable
Management

D1.
Terminals

Circuit Board Locking Supports

- For board-to-chassis support
- Snap-in design for fast assembly
- Design of wing provides added stability

- Releasable and reusable
- Material: Nylon 6.6

D2.
Power
Connectors

D3.
Grounding
Connectors

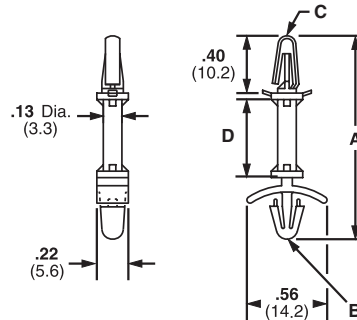

E1.
Labeling
Systems

E2.
Labels

E3.
Pre-Printed
& Write-On
Markers

E4.
Permanent
Identification

E5.
Lockout/
Tagout/
& Safety
Solutions

F.
Index

| Part Number | Height A | | Panel Hole Diameter B | | Chassis Panel Hole Diameter C | | Standoff Height D | | Color | Mounting Method | Std. Pkg. Qty. | Std. Ctn. Qty. |
|-----------------|----------|------|-----------------------|-----|-------------------------------|-----|-------------------|------|---------|-----------------|----------------|----------------|
| | In. | mm | In. | mm | In. | mm | In. | mm | | | | |
| CBLS18-C | .92 | 23.4 | .19 | 4.8 | .16 | 4.0 | .19 | 4.7 | Natural | Push Bar | 100 | 500 |
| CBLS25-C | .98 | 24.9 | .19 | 4.8 | .16 | 4.0 | .25 | 6.4 | | | 100 | 500 |
| CBLS37-C | 1.11 | 28.2 | .19 | 4.8 | .16 | 4.0 | .38 | 9.5 | | | 100 | 500 |
| CBLS50-C | 1.23 | 31.2 | .19 | 4.8 | .16 | 4.0 | .50 | 12.7 | | | 100 | 500 |
| CBLS62-C | 1.35 | 34.3 | .19 | 4.8 | .16 | 4.0 | .63 | 15.9 | | | 100 | 500 |
| CBLS75-C | 1.48 | 37.5 | .19 | 4.8 | .16 | 4.0 | .75 | 19.1 | | | 100 | 500 |

Harness Board Accessories

PANDUIT harness board accessories provide fast routing and forming of wires in harness fabrication. They hold the wires off the harness board at a uniform height for easy application of cable ties. The accessories are designed for use with various PANDUIT cable tie installation tools. To maintain the harness at a uniform height of approx. 1.33 inches (33.8mm) (at the center of the harness) above the board, use RER Elastic Retainers, BR.75-E6 or BR.5-E6, CPH.75-S8, TJF and SHH1-S8 or SHH3-S8 harness board accessories. This height is suitable for use with PAT1M Automatic Cable Tie Installation Tool.



Elastic Retainers

- Cable bundles are formed as individual wires are inserted
- Completed bundles can be easily removed
- The elastic band is replaceable
- For indoor use only

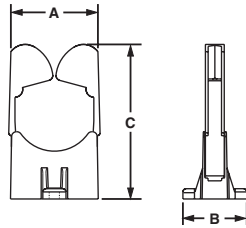

Replacement Elastic

| Part Number | Pkg. Qty. |
|-------------|-----------|
| RER.5E-X | 10 |
| RER.75E-X | 10 |
| RER1.25E-X | 10 |

For economy, the elastic band can be replaced in the RER Elastic Retainers without removing the RER base.

| Part Number | Max. Bundle Diameter | | Length A | | Width B | | Height C | | Material | Color | Mounting Method | Std. Pkg. Qty. | Std. Ctn. Qty. |
|--------------|----------------------|------|----------|------|---------|------|----------|------|-----------|-----------------------|--------------------|----------------|----------------|
| | In. | mm | In. | mm | In. | mm | In. | mm | | | | | |
| RER.5-S6-X | .50 | 12.7 | 1.18 | 30.0 | .84 | 21.3 | 1.89 | 48.0 | Nylon 6.6 | Black Base, White Arm | Two #6 (M3) Screws | 10 | 50 |
| RER.75-S6-X | .75 | 19.0 | 1.18 | 30.0 | 1.12 | 28.4 | 2.21 | 56.1 | | | | 10 | 50 |
| RER1.25-S6-X | 1.25 | 31.8 | 1.18 | 30.0 | 1.64 | 41.7 | 2.86 | 72.6 | | | | 10 | 50 |

Elastic Retainers – ER Type

- Cable bundles are formed as cable bundles are inserted
- Completed bundles can be easily removed
- For indoor use only

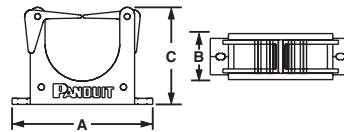

| Part Number | Max. Bundle Diameter | | Length A | | Width B | | Height C | | Material | Color | Mounting Method | Std. Pkg. Qty. | Std. Ctn. Qty. |
|-------------|----------------------|------|----------|------|---------|------|----------|------|-----------|-------|--------------------|----------------|----------------|
| | In. | mm | In. | mm | In. | mm | In. | mm | | | | | |
| ER.5-E4-X | .50 | 12.7 | 1.96 | 49.8 | .56 | 14.2 | 1.00 | 25.4 | Nylon 6.6 | Black | Two #6 (M3) Screws | 10 | 100 |
| ER1.25-E4-X | 1.25 | 31.8 | 2.90 | 73.7 | .95 | 24.1 | 2.00 | 50.8 | | | | 10 | 100 |

A. System Overview

B1. Cable Ties

B2. Cable Accessories

B3. Stainless Steel Ties

C1. Wiring Duct

C2. Surface Raceway

C3. Abrasion Protection

C4. Cable Management

D1. Terminals

D2. Power Connectors

D3. Grounding Connectors

E1. Labeling Systems

E2. Labels

E3. Pre-Printed & Write-On Markers

E4. Permanent Identification

E5. Lockout/Tagout & Safety Solutions

F. Index

Bundle Retainers

- Funnel entry allows fast cable insertion
- Completed bundles can be easily removed
- For indoor use only
- Color: Black

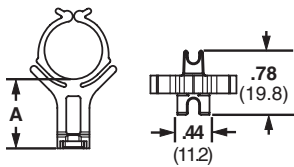

BR.5 and BR.75

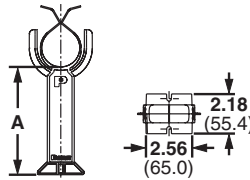

BR2

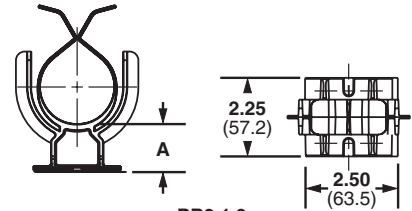

BR2-1.3

| Part Number | Max. Bundle Diameter | | Standoff Height A | | Material | Mounting Method | Std. Pkg. Qty. | Std. Ctn. Qty. |
|-------------|----------------------|------|-------------------|-------|----------------------------|--------------------|----------------|----------------|
| | In. | mm | In. | mm | | | | |
| BR.5-E6-C | .50 | 12.7 | 1.05 | 26.7 | Impact Resistant Nylon 6.6 | Two #6 (M3) Screws | 100 | 500 |
| BR.75-E6-C | .75 | 19.0 | .94 | 23.9 | | | 100 | 500 |
| BR2-1.3-X | 2.00 | 50.8 | 1.32 | 33.5 | | | 10 | 100 |
| BR2-1.3-A-X | 2.00 | 50.8 | 1.35 | 34.3 | Glass Filled Nylon 6.6 | Rubber Adhesive | 10 | 0 |
| BR2-1.5-X | 2.00 | 50.8 | 1.59 | 40.4 | | 10 | 100 | |
| BR2-4-X | 2.00 | 50.8 | 4.06 | 103.1 | | 10 | 100 | |
| BR2-6-X | 2.00 | 50.8 | 6.02 | 152.9 | | 10 | 100 | |

Corner Posts

- Designed to pre-form tight bundles at harness corners and breakouts
- Top arm rotates upward for easy removal of completed harness
- For indoor use only

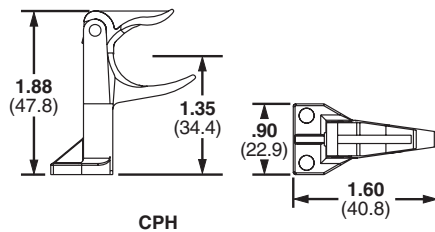

CPH

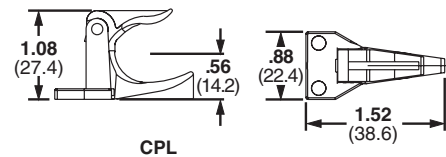

CPL

| Part Number | Max. Bundle Diameter | | Material | Color | Mounting Method | Std. Pkg. Qty. | Std. Ctn. Qty. |
|-------------|----------------------|------|-----------|-------|--------------------|----------------|----------------|
| | In. | mm | | | | | |
| CPH.75-S8-X | .75 | 19.0 | Nylon 6.6 | Black | Two #8 (M4) Screws | 10 | 100 |
| CPL.75-S8-X | | | | | | | |

T-Junction Fixture

- Forms cable junctions
- Fixture moves down for easy harness removal
- For indoor use only

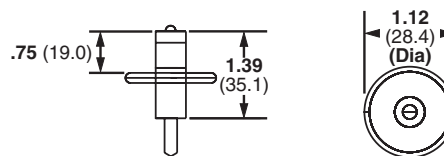

| Part Number | Max. Bundle Diameter | | Material | Color | Mounting Method | Std. Pkg. Qty. | Std. Ctn. Qty. |
|-------------|----------------------|------|-----------------------------------|-------|-----------------|----------------|----------------|
| | In. | mm | | | | | |
| TJF-X | 1.34 | 34.0 | Nylon 6.6 and Nickel Plated Steel | Black | Nail | 10 | 100 |

Wire End Holder

- Secures wire ends while harness is being fabricated
- Used with #28 thru #16 AWG wires

- For indoor use only

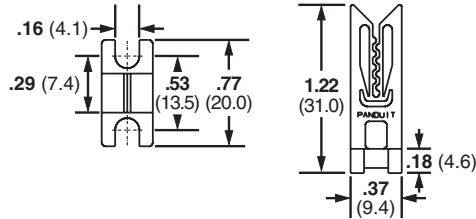

| Part Number | Material | Color | Mounting Method | Std. Pkg. Qty. | Std. Ctn. Qty. |
|-------------|----------|-------|--------------------|----------------|----------------|
| WEH-E8-C | Acetal | Black | Two #8 (M4) Screws | 100 | 1000 |

Harness Board Nails

- Speed routing of wires
- Uniform driving depth is insured by a collar stop

- Smooth finish on nails prevents abrasion to wire jackets
- For indoor use only

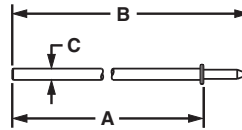

| Part Number | Length A | | Overall Length B | | Thickness C | | Material | Mounting Method | Std. Pkg. Qty. | Std. Ctn. Qty. |
|-------------|----------|-------|------------------|-------|-------------|-----|---------------------|-----------------------------|----------------|----------------|
| | In. | mm | In. | mm | In. | mm | | | | |
| HBN.75-T | .75 | 19.1 | 1.37 | 34.8 | .07 | 1.9 | Nickel Plated Steel | Hammered into harness board | 200 | 1000 |
| HBN1-T | 1.00 | 25.4 | 1.62 | 41.1 | .07 | 1.9 | | | 200 | 1000 |
| HBN1.5-T | 1.50 | 38.1 | 2.12 | 53.8 | .08 | 2.1 | | | 200 | 1000 |
| HBN2-T | 2.00 | 50.8 | 2.62 | 66.5 | .09 | 2.4 | | | 200 | 1000 |
| HBN2.5-T | 2.50 | 63.5 | 3.12 | 79.2 | .11 | 2.8 | | | 200 | 1000 |
| HBN3-T | 3.00 | 76.2 | 3.62 | 91.9 | .12 | 3.0 | | | 200 | 1000 |
| HBN4-T | 4.00 | 101.6 | 4.62 | 117.3 | .14 | 3.7 | | | 200 | 1000 |

A. System Overview

Fanning Strip System

- Holds wires in a specific orientation
- No sharp edges to damage wire insulation
- Will accept wires up to 18 AWG
- Fanning strip can remain as part of completed harness

B1. Cable Ties

B2. Cable Accessories

B3. Stainless Steel Ties

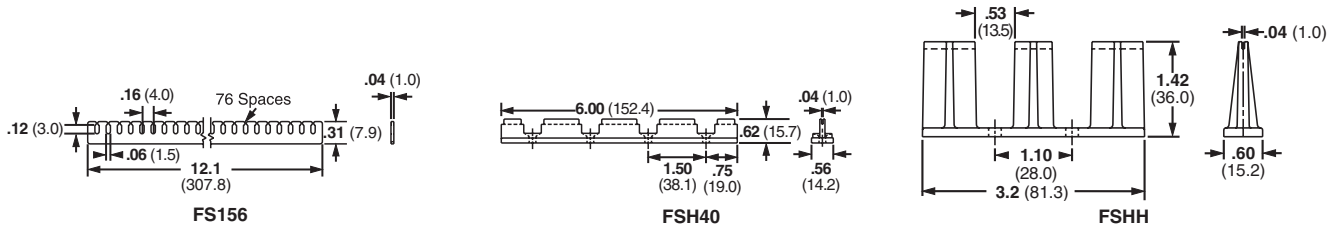

C1. Wiring Duct

C2. Surface Raceway



| Part Number | Material | Color | Mounting Method | Std. Pkg. Qty. | Std. Ctn. Qty. |
|-------------|-----------|---------|---------------------|----------------|----------------|
| FS156-C | Nylon 6.6 | Natural | — | 100 | 1000 |
| FSH40-X | ABS | Black | Four #8 (M4) Screws | 10 | 100 |
| FSHH-X | | | Two #8 (M4) Screws | 10 | 100 |

C3. Abrasion Protection

C4. Cable Management

Spring Wire Breakout System

- Harness board spring and spring holder holds wire ends secure while harness is being fabricated
- Wires simply pull out from spring when harness is removed
- Each SHH Spring Holder is supplied with one rigid wire piece to hold the spring laterally and two #8 (M4), 2 inch (50.8mm) hex head wood screws

D1. Terminals

D2. Power Connectors

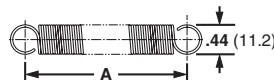

PBSC

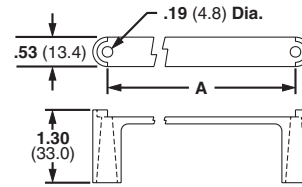

SHH

D3. Grounding Connectors

| Part Number | Hole Spacing A | | Material | Color | Mounting Method | Std. Pkg. Qty. | Std. Ctn. Qty. |
|-------------|----------------|-------|-----------|---------|--------------------|----------------|----------------|
| | In. | mm | | | | | |
| PBSC1-X | 1.00 | 25.4 | Steel | — | SHH1 Spring Holder | 10 | 100 |
| PBSC3-X | 3.00 | 76.2 | | | — | 10 | 100 |
| PBSC6-X | 6.00 | 152.4 | | | SHH3 Spring Holder | 10 | 100 |
| PBSC12-X | 12.00 | 304.8 | | | — | 10 | 100 |
| SHH1-S8-X | 1.85 | 47.0 | Nylon 6.6 | Natural | Two #8 (M4) Screws | 10 | 100 |
| SHH3-S8-X | 6.80 | 172.7 | | | #8 (M4) Screws | 10 | 100 |

E1. Labeling Systems

E2. Labels

E3. Pre-Printed & Write-On Markers

E4. Permanent Identification

E5. Lockout/Tagout & Safety Solutions

F. Index

Harness Board Standoff Posts and Adaptor

- Used to hold a push mount accessory or cable tie at a specific location on a harness board

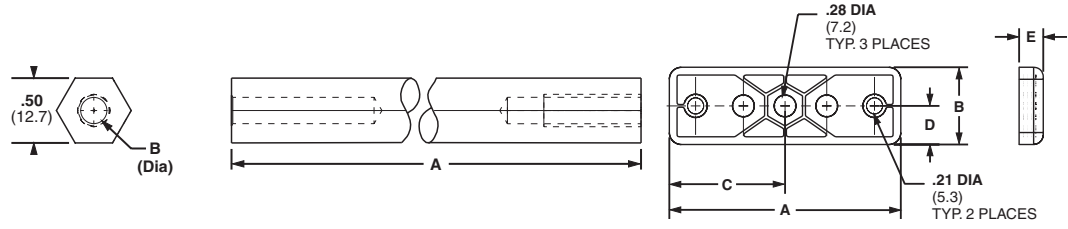

| Part Number | Height A | | Hole Diameter B | | Length C | | Width D | | For Use With | Material | Mounting Method | Std. Pkg. Qty. | Std. Ctn. Qty. |
|-------------|-------------|-------|-----------------------|-----|-------------|-------|------------|------|---|-----------|--------------------|----------------------|----------------------|
| | In. | mm | In. | mm | In. | m | In. | mm | | | | | |
| HB2SP19-X | 2.00 | 50.8 | .20 | 5.1 | 2.00 | 50.8 | — | — | PLWP, PRWP, WS, VWS, HWS, TPM | Aluminum | 1/4" Screw | 10 | 100 |
| HB2SP25-X | 4.00 | 101.6 | .30 | 7.5 | 4.00 | 101.6 | — | — | PLWP, PRWP, PLP, THMS, HCMP, PMCC | Aluminum | 1/4" Screw | 10 | 100 |
| HBUA-X | .31 | 7.9 | .28 | 7.1 | 3.00 | 76.2 | 1.00 | 25.4 | HB2SP19-X, HB2SP25-X | Nylon 6.6 | #10 (M5) Screw | 10 | 100 |

A.
System
Overview

B1.
Cable Ties

B2.
Cable
Accessories

B3.
Stainless
Steel Ties

C1.
Wiring
Duct

C2.
Surface
Raceway

C3.
Abrasion
Protection

C4.
Cable
Management

D1.
Terminals

D2.
Power
Connectors

D3.
Grounding
Connectors

E1.
Labeling
Systems

E2.
Labels

E3.
Pre-Printed
& Write-On
Markers

E4.
Permanent
Identification

E5.
Lockout/
Tagout
& Safety
Solutions

F.
Index

A. System Overview

Physical Properties and Colors of Cable Accessory Materials

| Design Criteria | Nylon 6.6 | | Weather Resistant Nylon 6.6 | Impact Modified Weather Resistant Nylon 6.6 | Heat Stabilized Nylon 6.6 | Flame Retardant Nylon 6.6 | | Glass Filled Flame Retardant Nylon 6.6 |
|---|------------------------|------------------------|-----------------------------|---|---------------------------|---------------------------|------------------------|--|
| | Natural | Black | Black | Black | Black | Black | Natural | Black |
| Color | Natural | Black | Black | Black | Black | Black | Natural | Black |
| Part Number Suffix | None | 20 | 0 | 0 | 30 | 60 | 69 | None |
| UL Flammability – UL 94 | V-2 | V-2 | V-2 | HB | V-2 | V-0 | V-0 | V-0 |
| Gamma Radiation Resistance | 1x10 ⁵ Rads | 1x10 ⁵ Rads | 1x10 ⁵ Rads | N/A | 1x10 ⁵ Rads | 1x10 ⁵ Rads | 1x10 ⁵ Rads | N/A |
| Water Absorption | 1.2% (24 hrs.) | 1.2% (24 hrs.) | 1.2% (24 hrs.) | 1.2% (24 hrs.) | 1.2% (24 hrs.) | 1.1% (24 hrs.) | 1.1% (24 hrs.) | 0.7% (24 hrs.) |
| UV Resistance | Poor | Fair | Good | Good | Fair | Poor | Poor | Poor |
| Maximum Continuous Use Temperature | 185°F (85°C) | 185°F (85°C) | 185°F (85°C) | 185°F (85°C) | 257°F (125°C) | 230°F (110°C) | 230°F (110°C) | 230°F (110°C) |
| Minimum Continuous Use Temperature | -40°F (-40°C) | -40°F (-40°C) | -40°F (-40°C) | -40°F (-40°C) | -40°F (-40°C) | -40°F (-40°C) | -40°F (-40°C) | -40°F (-40°C) |

B1. Cable Ties

B2. Cable Accessories

B3. Stainless Steel Ties

C1. Wiring Duct

C2. Surface Raceway

C3. Abrasion Protection

Physical Properties and Colors of Cable Accessory Materials (continued)

| Design Criteria | Heat Stabilized Nylon 6 | | TEFZEL [®] | General Purpose Polypropylene | Weather Resistant Polypropylene | General Purpose ABS | | Weather Resistant ABS | Flame Retardant Polycarbonate | Acetal | PVC |
|---|-------------------------|----------------|---------------------|-------------------------------|---------------------------------|---------------------|---------------|-----------------------|-------------------------------|----------------|---------------|
| | Black | Natural | Aqua | Black | Black | Black | Natural | Black | Black | Black | Gray, White |
| Color | Black | Natural | Aqua | Black | Black | Black | Natural | Black | Black | Black | Gray, White |
| Part Number Suffix | 630 | 639 | 76 | None/109 | 100 | None | 20 | 0 | None | None | 810 |
| UL Flammability – UL 94 | HB | HB | V-0 | HB | HB | HB | HB | HB | V-0 | HB | V-0 |
| Gamma Radiation Resistance | N/A | N/A | 2x10 Rads | 1x10 Rads | 1x10 Rads | N/A | N/A | N/A | N/A | N/A | N/A |
| Water Absorption (24 Hours) | 1.5% (24 hrs.) | 1.5% (24 hrs.) | <.3% (24 hrs.) | .1% (24 hrs.) | .1% (24 hrs.) | .3% (24 hrs.) | .3% (24 hrs.) | .3% (24 hrs.) | .15% (24 hrs.) | .43% (24 hrs.) | .3% (24 hrs.) |
| UV Resistance | Fair | Poor | Excellent | Poor | Good | Poor | Fair | Good | Good | Fair | Poor |
| Maximum Continuous Use Temperature | 250°F (121°C) | 250°F (121°C) | 302°F (150°C) | 221°F (105°C) | 221°F (105°C) | 185°F (85°C) | 185°F (85°C) | 185°F (85°C) | 257°F (125°C) | 194°F (90°C) | 122°F (50°C) |
| Minimum Continuous Use Temperature | -40°F (-40°C) | -40°F (-40°C) | -50°F (-46°C) | -40°F (-40°C) | -40°F (-40°C) | -40°F (-40°C) | -40°F (-40°C) | -40°F (-40°C) | -40°F (-40°C) | -40°F (-40°C) | -40°F (-40°C) |

C4. Cable Management

D1. Terminals

D2. Power Connectors

D3. Grounding Connectors

E1. Labeling Systems

[®]TEFZEL is a registered trademark of E.I. du Pont de Nemours and Company.

E2. Labels

Selection and Use of Adhesive Mounts

PANDUIT adhesive mounts provide a quick, economical, and dependable method of supporting, routing, and protecting wires or cables. Some are used with PANDUIT cable ties and others can be used without cable ties. Adhesive backed mounts adhere to a variety of surfaces. This alternative to mechanical fasteners offers the advantage of lower installed cost with safe, easy to use, quality products.



E3. Pre-Printed & Write-On Markers

E4. Permanent Identification

Applications

- To route wires in control panels and switchboards
- To support bundles of wires away from moving mechanical devices
- Routing and harnessing cables, both indoors and out, to prevent safety hazards
- To organize flat cables in many locations with low profile construction
- Ideal for supporting wire bundles where holes cannot be made in the substrate
- To separate groups of wires for identification



E5. Lockout/Tagout & Safety Solutions

F. Index

Selection and Use of Adhesive Mounts (continued)

General Mount Guidelines

PANDUIT pressure sensitive adhesive (foam tape) mounts are intended to secure wire bundles or other light objects to smooth surfaces. These mounts are not designed to support excessive loads and should not be used when the maximum expected load exceeds the rated capacity of the mount.

Choosing the Right Adhesive

PANDUIT offers two standard pressure sensitive foam tapes which are available on most adhesive backed wiring accessories products. The general purpose tape is produced with a rubber based adhesive and is identified by an “-A” in the part number. This tape develops its strength extremely fast and can be used in environments with temperatures ranging from -20°F (-40°C) to +120°F (49°C). It is recommended that rubber based adhesive mounts dwell 2 hours after installation, prior to loading. Rubber based adhesive tape is the best choice for most adhesive mount applications, including powder coated surfaces.

Acrylic based adhesive tape is also available and is identified by an “-AT” in the part number. This tape is for use in environments where continuous exposure to temperatures as high as 180°F (82°C) is possible. Acrylic based adhesive develops its maximum strength over a longer period of time than rubber based adhesive. It is recommended that acrylic adhesive mounts dwell 8 hours after installation, prior to loading. Acrylic based adhesive tape is a good choice for environments with prolonged exposure to UV rays or temperatures above 120°F (49°C).

PANDUIT also offers a 2-part epoxy for use in applications where excessive loading is required, or where the surface to which the mount must be applied is porous rather than smooth. PANDUIT EMA adhesive is a 2-part epoxy cement which is packaged in convenient mixer cups containing an equal amount of resin and hardener. Peel the protective covering off and pop the center of the cup in to form a mixing bowl. Each cup is supplied with a mixer stick and contains enough epoxy to properly apply three EMS mounts. The resin and hardener should be thoroughly mixed together until the epoxy is a consistent and uniform color. The mixer stick can then be used to apply the adhesive to the mount. The epoxy should be forced into the grooves on the bottom of the mount to obtain optimum bond performance. The mount should be applied to the surface with light pressure and a back-and-forth twisting motion. Hardening of the epoxy begins five minutes after mixing at room temperature.

Application Chart

Since PANDUIT manufactures adhesive backed mounts with a variety of adhesive types, this chart should be used as a guideline for choosing the best adhesive for often-encountered conditions. Each type of adhesive is rated good, fair or poor for some specific mounting surfaces and/or chemical environments.

| Surfaces | Rubber Based Foam Tape Mounts | Acrylic Based Foam Tape Mounts | Epoxy Applied Adhesive Mounts |
|--------------------------|-------------------------------|--------------------------------|-------------------------------|
| Plastics | Good | Good | Good |
| Wood | Good | Good | Good |
| Glass | Fair | Good | Good |
| Painted Surfaces | Good | Good | Fair |
| Powder Coating | Good | Fair | Good |
| Metal | Good ¹ | Good ¹ | Good |
| Paper | Good | Good | Fair |
| Concrete, Stone, Masonry | Not Recommended | Not Recommended | Good |
| Chemical Resistance | | | |
| Water | Good | Good | Poor |
| Oil | Poor | Fair ³ | Good |
| Gasoline | Poor | Fair ³ | Fair |
| Dilute Acids | Poor | Fair ³ | Fair |
| Dilute Alkalis | Good | Fair ³ | Fair |
| Organic Solvents | Poor | Fair ³ | Not Recommended |
| Outdoor Exposure | Not Recommended | Good | Good ² |

1. Not recommended for use on copper or brass.
2. Mounts manufactured from outdoor material only. For specific applications, individual testing prior to extensive use is suggested.
3. Depends on concentration, exposure time, and chemical composition.

Mount Spacing

To determine the number of mounts to use in a given application, the following formula can be used as a guideline:

$$\frac{\text{Cable or weight (Lbs./ft.)}}{\text{Static Load rating of Mount (Lbs./mt.)}} = \text{Spacing} \frac{\text{Mounts}}{\text{Ft.}}$$

A.
System
Overview

B1.
Cable
Ties

B2.
Cable
Accessories

B3.
Stainless
Steel Ties

C1.
Wiring
Duct

C2.
Surface
Raceway

C3.
Abrasion
Protection

C4.
Cable
Management

D1.
Terminals

D2.
Power
Connectors

D3.
Grounding
Connectors

E1.
Labeling
Systems

E2.
Labels

E3.
Pre-Printed
& Write-On
Markers

E4.
Permanent
Identification

E5.
Lockout/
Tagout
& Safety
Solutions

F.
Index

A. System Overview

Selection and Use of Adhesive Mounts (continued)

B1. Cable Ties

Surface Preparation

For best results, *PANDUIT* adhesive mounts should be applied to clean, dry, grease-free surfaces. We recommend that the surface be cleaned prior to mount installation. For rubber and acrylic based foam tape adhesives, a blend of isopropyl alcohol and water 50/50 may be used to clean most surfaces.

B2. Cable Accessories

For epoxy type adhesives, especially masonry surfaces, be sure to clean all loose particles away before mount installation. Some surface abrasion is recommended to achieve maximum strength. A light rubbing with medium grit emery cloth or sandpaper is best. Wash after abrading.

B3. Stainless Steel Ties

Proper Installation Techniques For Pressure Sensitive Adhesive Mounts

For proper installation of adhesive mounts with foam tape, simply remove the release liner and place the mount in the desired location. Avoid touching the adhesive prior to positioning the mount. Apply firm pressure to the mount for 5 seconds to insure proper adhesion.

C1. Wiring Duct

C2. Surface Raceway

C3. Abrasion Protection

C4. Cable Management

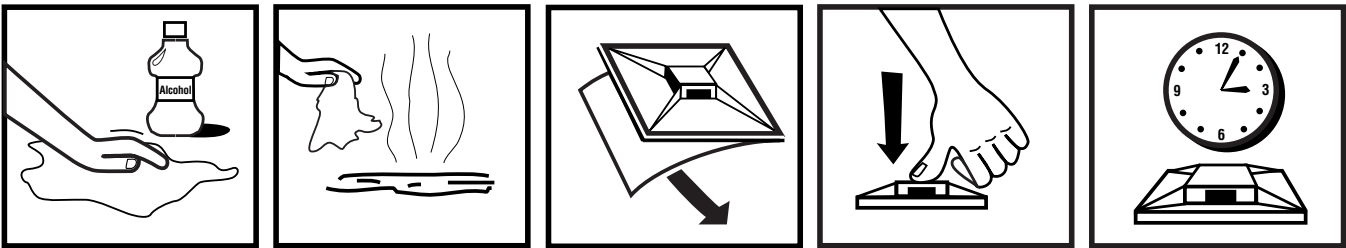

1) Clean surface with a clean cloth and isopropyl alcohol.

2) Allow surface to air dry.

3) Remove the release liner, being careful not to touch the adhesive.

4) Apply full thumb pressure for at least 5 seconds.

5) Allow mount to properly dwell.

D1. Terminals

Proper Storage Conditions

All *PANDUIT* adhesive products have an expiration date printed on the package label. Use the following storage guidelines:

D2. Power Connectors

1. For rubber and acrylic based foam tape adhesives, store in temperatures of 70°F (21°C) and 45% Relative Humidity (R.H.).

D3. Grounding Connectors

2. For epoxy type adhesives, store in temperatures of 40°F (4°C) to 75°F (25°C) and relative humidity not in excess of 45%. Storage in opened containers is not recommended. Using the guidelines above, the shelf life of foam tape is 3 years. Shelf life of epoxy is 1 year. Deviation from the recommended storage conditions may reduce the shelf life or adhesive strength. In any case, adhesive products should never be stored near heating vents or other heat sources, and storage in lower temperatures than those recommended may increase the shelf life.

E1. Labeling Systems

E2. Labels

Stock Rotation

Adhesive mount inventory should be rotated in order to insure the quality of the adhesive foam tape. Each package of *PANDUIT* adhesive backed mounts has a Quality Control Number and a best-if-used-by date on the package label. The best-if-used-by date provides the customer with an accurate way to control the rotation of inventory, and, as is the case with all *PANDUIT* products, the Quality Control Number provides complete traceability for all components that go into a specific production run of product.

E3. Pre-Printed & Write-On Markers

E4. Permanent Identification

E5. Lockout/Tagout & Safety Solutions

F. Index

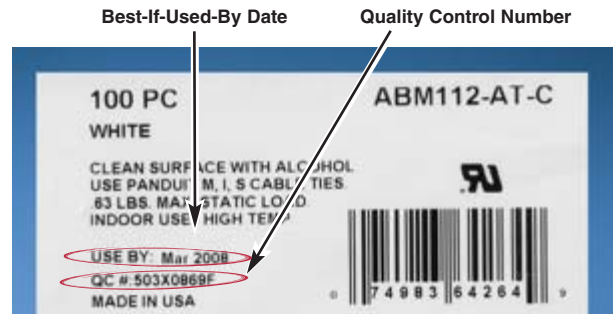

Mount Removal

There is no simple or easy method for removing *PANDUIT* adhesives. A thin wire or razor blade can be moved in between the surfaces when removing foam tape mounts; however, the adhesive residue will remain on the surface. Epoxy adhesives may be removed with a commercial paint stripping solution.

PAN-STEEL® SYSTEM

The *PAN-STEEL*® System provides a strong, durable method of bundling and mechanical fastening, for all indoor, outdoor, and underground (including direct burial) applications. The ties are designed for use in critical applications where strength, vibration, radiation, weathering, corrosion and temperature extremes are a factor.



- Patented locking head design assures locking in any position, with a high rated loop tensile strength for a durable solution that delivers an extra margin of safety
- 304 or 316 grade stainless steel provides a strong, long-lasting method of bundling and mechanical fastening in harsh environments
- Accessories available to protect, speed, and simplify the mounting of wires, cable, and tubing with *PANDUIT*® *PAN-STEEL*® Stainless Steel Cable Ties
- Complete line of manual and pneumatic installation tools available with controlled tension and automatic cut-off for lower installed cost
- Large selection of stainless steel marker plates, tags, and cable ties to deliver maximum design flexibility to match your specific application requirements; for details, refer to Permanent Identification Section E4

PANDUIT continues to develop stainless steel solutions for harsh environment applications by solving customer problems with innovative products and reliable tooling to achieve lowest installed cost.

A.
System
Overview

B1.
Cable Ties

B2.
Cable
Accessories

B3.
Stainless
Steel Ties

C1.
Wiring
Duct

C2.
Surface
Raceway

C3.
Abrasion
Protection

C4.
Cable
Management

D1.
Terminals

D2.
Power
Connectors

D3.
Grounding
Connectors

E1.
Labeling
Systems

E2.
Labels

E3.
Pre-Printed
& Write-On
Markers

E4.
Permanent
Identification

E5.
Lockout/
Tagout
& Safety
Solutions

F.
Index

A.
System
Overview

PAN-STEEL® Products Overview

B1.
Cable Ties

PAN-STEEL® Cable Ties

Pages B3.4 – B3.7, B3.11, B3.13

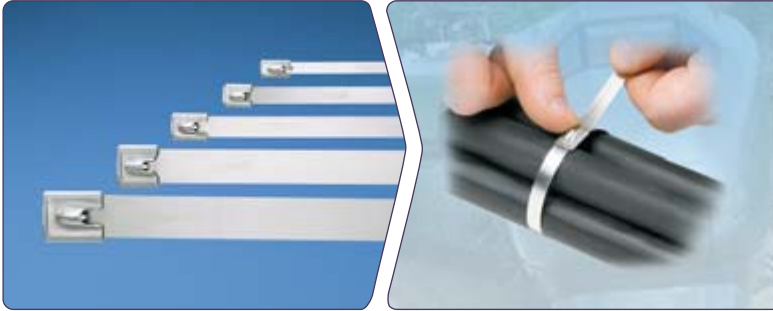

- Designed for use in indoor, outdoor, and underground applications
- Self-locking head design speeds installation
- Strong, durable method of cable bundling
- Rounded edges assure cable protection and worker safety

C1.
Wiring
Duct

C2.
Surface
Raceway

PAN-STEEL® Coated Cable Ties

Pages B3.8 – B3.9, B3.12 – B3.13

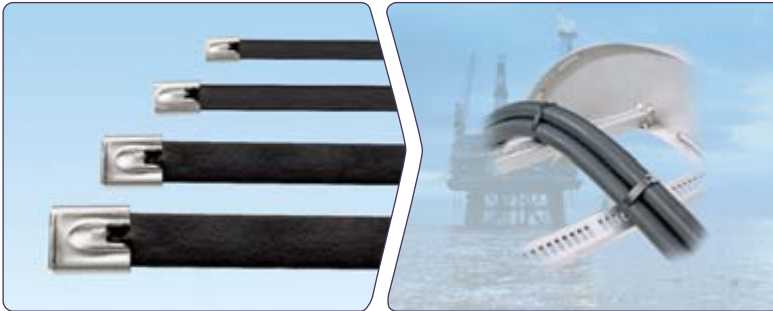

- Designed for use in indoor, outdoor, and underground applications
- Self-locking head design speeds installation
- Provides additional edge protection
- Prevents corrosion between dissimilar metals

C3.
Abrasion
Protection

C4.
Cable
Management

D1.
Terminals

D2.
Power
Connectors

PAN-ALUM™ Cable Ties

Page B3.10

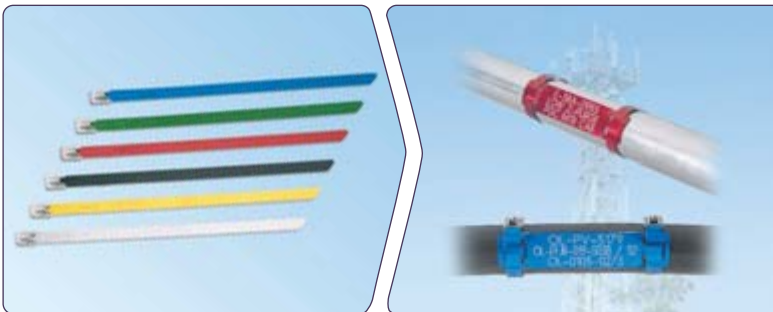

- Ideal for use in permanent identification and color-coding applications
- Five color options in addition to natural aluminum
- Lightweight construction for flexibility and ease of handling
- Used with aluminum marker plates for fast and easy installation

D3.
Grounding
Connectors

E1.
Labeling
Systems

E2.
Labels

E3.
Pre-Printed
& Write-On
Markers

PAN-STEEL® Retained Tension Ties

Pages B3.17 – B3.20



- Designed for use in Industrial, OEM, and Transportation Markets
- Provides tight bundling of armored cables, pipes, conduit and rigid materials
- Locks into place at any length along the tie body
- 360° seal design option eliminates gaps for a completely sealed installation

E4.
Permanent
Identification

E5.
Lockout/
Tagout
& Safety
Solutions

F.
Index

PAN-STEEL® Products Overview (continued)

Installation Tools

Pages B3.14 – B3.16, B3.20, B3.26



- Used in production, maintenance, and construction applications
- Full line of lightweight, ergonomic hand tools
- Highest reliability in the industry
- Flush cut-off of ties limits exposure to sharp edges

PAN-STEEL® Strapping

Pages B3.21 – B3.25



- Fold over design provides high retained tension
- Cut end is locked inside low profile buckle – no sharp edges
- Coil-in-box packaging option for job site versatility with minimum inventory
- Coated design option for additional edge protection

Accessories

Pages B3.26 – B3.29

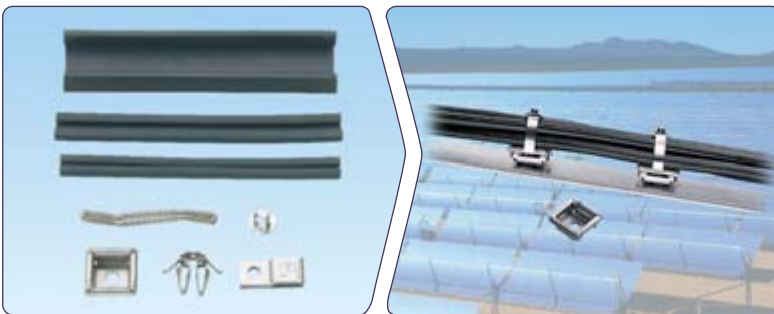

- Cushion sleeving provides full separation between ties and bundles
- Multiple mount options for range of applications and panel thicknesses
- Mounts secure ties to structure quickly and easily

Permanent Identification Products

Pages E4.1 – E4.6



- Withstand the test of time and provide legibility in harsh environments
- Factory Custom Marking Service creates custom embossed or laser etched metal plates, tags, and ties
- Portable marking tools for quick and easy on-site identification
- Large selection delivers maximum design flexibility

A.
System
Overview

B1.
Cable Ties

B2.
Cable
Accessories

B3.
Stainless
Steel Ties

C1.
Wiring
Duct

C2.
Surface
Raceway

C3.
Abrasion
Protection

C4.
Cable
Management

D1.
Terminals

D2.
Power
Connectors

D3.
Grounding
Connectors

E1.
Labeling
Systems

E2.
Labels

E3.
Pre-Printed
& Write-On
Markers

E4.
Permanent
Identification

E5.
Lockout/
Tagout/
& Safety
Solutions

F.
Index

A. System Overview

Features and Benefits – PAN-STEEL® Cable Ties

PANDUIT® PAN-STEEL® Stainless Steel Ties are engineered for safety, productivity, and durability by providing round edges and smooth surfaces, easy threading, high loop tensile strength and tight clamping.

B1. Cable Ties

B2. Cable Accessories

B3. Stainless Steel Ties

Self-Locking Head Construction*

Aggressive locking head
Quicker locking, tighter installation

Unique locking ramp
Assures locking in any position

Lead in design
Wider entrance for easier threading

Strengthening ribs
Stronger head increases lock strength

Innovative displacement lock
Assures superior locking strength

Extended retaining tab
Increases overall tie strength

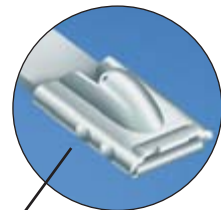
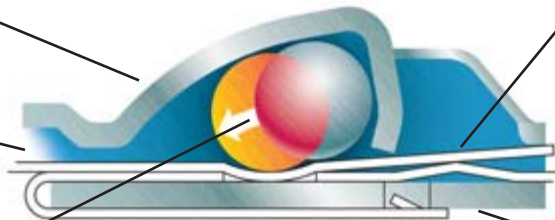

*Patents applied for

C1. Wiring Duct

C2. Surface Raceway

C3. Abrasion Protection

C4. Cable Management

Fully Rounded Edges

Self-Locking for Fast Installation

D1. Terminals



PANDUIT tie body

Other manufacturer's tie body

The PAN-STEEL® Stainless Steel Cable Tie features fully rounded edges to assure bundle protection and operator safety. PANDUIT not only removes the burr, but actually passes the material through a secondary process which removes the top and bottom corners of the material.



Self-locking design can be fastened by hand requiring no fold over or additional installation steps.

PAN-STEEL® Installation Tools for adjustable tension control and automatic cut-off for quick, consistent, and secure installation.

D2. Power Connectors

D3. Grounding Connectors

E1. Labeling Systems

E2. Labels

E3. Pre-Printed & Write-On Markers



Large selection of installation tools, the proper tool available to meet the requirements of every application. See pages B3.14 – B3.16.

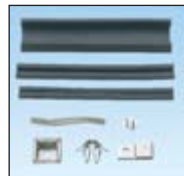

PAN-STEEL® System Accessories are used with PAN-STEEL® Stainless Steel Cable Ties to speed and simplify the mounting of wires, cables, and tubing. Installation methods include screw mounts and push mounts. See pages B3.26 – B3.29.



PAN-STEEL® Permanent Identification Solutions are designed for use with PANDUIT® PAN-STEEL® Stainless Cable Ties and PAN-ALUM™ Aluminum Cable Ties for quick and easy on-demand identification in harsh environments. See pages E4.1 – E4.6.

E4. Permanent Identification

E5. Lockout/Tagout & Safety Solutions

F. Index

Part Number System for PAN-STEEL® Cable Ties

| | | | | | |
|-------------------------------|------------------------------------|---|---|--|----------------------------|
| MLT | 6 | S | — | CP | |
| Type | Bundle Diameter Reference (In.) | Cross Section | | Standard Package Size | Material |
| MLT = Metal Locking Tie | | S = Standard LH = Light Heavy H = Heavy EH = Extra-Heavy EH-15 = Extra-Heavy-15 SH = Super-Heavy | | Q = 25 L* = 50 LP** = 50 CP = 100 | (blank) = 304 316 = 316 |
| | | | | *Standard Cross Section **Heavy Cross Section | |

PAN-STEEL® Self-Locking Cable Ties – MLT Series

- Self-locking head design speeds installation and locks into place at any length along the tie body
- Provides a strong, durable method of cable bundling
- Can be used in a wide range of indoor, outdoor, and underground (including direct burial) applications
- Smooth surfaces and rounded edges assures cable protection and worker safety
- Available in AISI 304 stainless steel for general-purpose applications
- Available in AISI 316 stainless steel for the most corrosive environments



| Part Number | Max. Bundle Diameter | | Length* | | Min. Loop Tensile Strength** | | Min. Bundle Diameter | | Width | | Thickness | | Recommended Installation Tool*** | Std. Pkg. Qty. | Std. Ctn. Qty. |
|-------------|----------------------|----|---------|----|------------------------------|---|----------------------|----|-------|----|-----------|----|----------------------------------|----------------|----------------|
| | In. | mm | In. | mm | Lbs. | N | In. | mm | In. | mm | In. | mm | | | |

AISI 304 Stainless Steel – For General Purpose

Standard Cross Section

| | | | | | | | | | | | | | | | |
|-------------------|------|-----|------|------|-----|-----|-----|------|-----|-----|------|-----|------------------------------|-----|-----|
| MLT1S-CP | 1.0 | 25 | 5.0 | 127 | 200 | 890 | .50 | 12.7 | .18 | 4.6 | .010 | .25 | GS4MT, HTMT, PPTMT, ST2MT | 100 | 500 |
| MLT2S-CP | 2.0 | 51 | 7.9 | 201 | 200 | 890 | .50 | 12.7 | .18 | 4.6 | .010 | .25 | | 100 | 500 |
| MLT2S-L | 2.0 | 51 | 7.9 | 201 | 200 | 890 | .50 | 12.7 | .18 | 4.6 | .010 | .25 | | 50 | 500 |
| MLT2.7S-CP | 2.7 | 69 | 10.2 | 259 | 200 | 890 | .50 | 12.7 | .18 | 4.6 | .010 | .25 | | 100 | 500 |
| MLT4S-CP | 4.0 | 102 | 14.3 | 362 | 200 | 890 | .50 | 12.7 | .18 | 4.6 | .010 | .25 | | 100 | 500 |
| MLT4S-L | 4.0 | 102 | 14.3 | 362 | 200 | 890 | .50 | 12.7 | .18 | 4.6 | .010 | .25 | | 50 | 500 |
| MLT6S-CP | 6.0 | 152 | 20.5 | 521 | 200 | 890 | .50 | 12.7 | .18 | 4.6 | .010 | .25 | | 100 | 500 |
| MLT8S-CP | 8.0 | 203 | 26.8 | 679 | 200 | 890 | .50 | 12.7 | .18 | 4.6 | .010 | .25 | | 100 | 500 |
| MLT10S-CP | 10.0 | 254 | 33.0 | 838 | 200 | 890 | .50 | 12.7 | .18 | 4.6 | .010 | .25 | | 100 | 500 |
| MLT12S-Q | 12.0 | 304 | 39.3 | 998 | 200 | 890 | .50 | 12.7 | .18 | 4.6 | .010 | .25 | | 25 | 125 |
| MLT14S-Q | 14.0 | 355 | 45.5 | 1156 | 200 | 890 | .50 | 12.7 | .18 | 4.6 | .010 | .25 | | 25 | 125 |
| MLT15S-Q | 15.0 | 380 | 49.2 | 1250 | 200 | 890 | .50 | 12.7 | .18 | 4.6 | .010 | .25 | | 25 | 125 |

*Other lengths available, contact PANDUIT Customer Service.

**Per SAE Standard AS23190/3 (formerly MIL). For additional details, refer to page B3.32.

***For information on installation tools, refer to pages B3.14 – B3.16.

Table continued on page B3.6

A. System Overview



PAN-STEEL® Self-Locking Cable Ties – MLT Series (continued)

B1. Cable Ties

B2. Cable Accessories

B3. Stainless Steel Ties

C1. Wiring Duct

C2. Surface Raceway

C3. Abrasion Protection

C4. Cable Management

D1. Terminals

D2. Power Connectors

D3. Grounding Connectors

E1. Labeling Systems

E2. Labels

E3. Pre-Printed & Write-On Markers

E4. Permanent Identification

E5. Lockout/Tagout & Safety Solutions

F. Index

| Part Number | Max. Bundle Diameter | | Length* | | Min. Loop Tensile Strength** | | Min. Bundle Diameter | | Width | | Thickness | | Recommended Installation Tool*** | Std. Pkg. Qty. | Std. Ctn. Qty. | |
|---|----------------------|-----|---------|------|------------------------------|------|----------------------|------|-------|------|-----------|-----|----------------------------------|----------------|----------------|-----|
| | In. | mm | In. | mm | Lbs. | N | In. | mm | In. | mm | In. | mm | | | | |
| Light-Heavy Cross Section | | | | | | | | | | | | | | | | |
| MLT2LH-LP | 2.0 | 51 | 7.9 | 201 | 250 | 1112 | .50 | 12.7 | .25 | 6.4 | .010 | .25 | GS4MT, HTMT, PPTMT, ST2MT | 50 | 250 | |
| MLT4LH-LP | 4.0 | 102 | 14.3 | 362 | 250 | 1112 | .50 | 12.7 | .25 | 6.4 | .010 | .25 | | 50 | 250 | |
| MLT6LH-LP | 6.0 | 152 | 20.5 | 521 | 250 | 1112 | .50 | 12.7 | .25 | 6.4 | .010 | .25 | | 50 | 250 | |
| MLT8LH-LP | 8.0 | 203 | 26.8 | 679 | 250 | 1112 | .50 | 12.7 | .25 | 6.4 | .010 | .25 | | 50 | 250 | |
| Heavy Cross Section | | | | | | | | | | | | | | | | |
| MLT2H-LP | 2.0 | 51 | 7.9 | 201 | 450 | 2000 | .50 | 12.7 | .31 | 7.9 | .010 | .25 | GS4MT, HTMT, PPTMT, ST2MT | 50 | 250 | |
| MLT2.7H-LP | 2.7 | 69 | 10.2 | 259 | 450 | 2000 | .50 | 12.7 | .31 | 7.9 | .010 | .25 | | 50 | 250 | |
| MLT4H-LP | 4.0 | 102 | 14.3 | 362 | 450 | 2000 | .50 | 12.7 | .31 | 7.9 | .010 | .25 | | 50 | 250 | |
| MLT6H-LP | 6.0 | 152 | 20.5 | 521 | 450 | 2000 | .50 | 12.7 | .31 | 7.9 | .010 | .25 | | 50 | 250 | |
| MLT8H-LP | 8.0 | 203 | 26.8 | 679 | 450 | 2000 | .50 | 12.7 | .31 | 7.9 | .010 | .25 | | 50 | 250 | |
| MLT10H-LP | 10.0 | 254 | 33.0 | 838 | 450 | 2000 | .50 | 12.7 | .31 | 7.9 | .010 | .25 | | 50 | 250 | |
| MLT12H-Q | 12.0 | 304 | 39.3 | 998 | 450 | 2000 | .50 | 12.7 | .31 | 7.9 | .010 | .25 | 25 | 125 | | |
| MLT14H-Q | 14.0 | 355 | 45.5 | 1156 | 450 | 2000 | .50 | 12.7 | .31 | 7.9 | .010 | .25 | 25 | 125 | | |
| Extra-Heavy Cross Section | | | | | | | | | | | | | | | | |
| MLT4EH-LP | 4.0 | 102 | 17.1 | 434 | 600 | 2670 | 1.0 | 25.4 | .50 | 12.7 | .010 | .25 | ST2MT, RT1HT, RT1HTN | 50 | 250 | |
| MLT6EH-LP | 6.0 | 152 | 23.4 | 594 | 600 | 2670 | 1.0 | 25.4 | .50 | 12.7 | .010 | .25 | | 50 | 250 | |
| MLT8EH-LP | 8.0 | 203 | 29.7 | 754 | 600 | 2670 | 1.0 | 25.4 | .50 | 12.7 | .010 | .25 | | 50 | 250 | |
| MLT10EH-LP | 10.0 | 254 | 35.9 | 912 | 600 | 2670 | 1.0 | 25.4 | .50 | 12.7 | .010 | .25 | | 50 | 250 | |
| MLT12EH-Q | 12.0 | 305 | 42.2 | 1072 | 600 | 2670 | 1.0 | 25.4 | .50 | 12.7 | .010 | .25 | | 25 | 125 | |
| MLT4EH15-LP | 4.0 | 102 | 17.1 | 434 | 700 | 3115 | 1.0 | 25.4 | .50 | 12.7 | .015 | .38 | | 50 | 250 | |
| MLT6EH15-LP | 6.0 | 152 | 23.4 | 594 | 700 | 3115 | 1.0 | 25.4 | .50 | 12.7 | .015 | .38 | | 50 | 250 | |
| MLT8EH15-LP | 8.0 | 203 | 29.7 | 754 | 700 | 3115 | 1.0 | 25.4 | .50 | 12.7 | .015 | .38 | | 50 | 250 | |
| MLT10EH15-LP | 10.0 | 254 | 35.9 | 912 | 700 | 3115 | 1.0 | 25.4 | .50 | 12.7 | .015 | .38 | | 50 | 250 | |
| MLT12EH15-Q | 12.0 | 305 | 42.2 | 1072 | 700 | 3115 | 1.0 | 25.4 | .50 | 12.7 | .015 | .38 | | 25 | 125 | |
| Super-Heavy Cross Section | | | | | | | | | | | | | | | | |
| MLT4SH-LP | 4.0 | 102 | 17.1 | 434 | 900 | 4005 | 1.0 | 25.4 | .63 | 15.9 | .015 | .38 | | RT1HT, RT1HTN | 50 | 250 |
| MLT6SH-LP | 6.0 | 152 | 23.4 | 594 | 900 | 4005 | 1.0 | 25.4 | .63 | 15.9 | .015 | .38 | 50 | | 250 | |
| MLT8SH-LP | 8.0 | 203 | 29.7 | 754 | 900 | 4005 | 1.0 | 25.4 | .63 | 15.9 | .015 | .38 | 50 | | 250 | |
| MLT10SH-LP | 10.0 | 254 | 35.9 | 912 | 900 | 4005 | 1.0 | 25.4 | .63 | 15.9 | .015 | .38 | 50 | | 250 | |
| MLT12SH-Q | 12.0 | 305 | 42.2 | 1072 | 900 | 4005 | 1.0 | 25.4 | .63 | 15.9 | .015 | .38 | 25 | | 125 | |
| AISI 316 Stainless Steel – For Superior Corrosion Resistance | | | | | | | | | | | | | | | | |
| Standard Cross Section | | | | | | | | | | | | | | | | |
| MLT1S-CP316 | 1.0 | 25 | 5.0 | 127 | 200 | 890 | .50 | 12.7 | .18 | 4.6 | .010 | .25 | GS4MT, HTMT, PPTMT, ST2MT | 100 | 500 | |
| MLT2S-CP316 | 2.0 | 51 | 7.9 | 201 | 200 | 890 | .50 | 12.7 | .18 | 4.6 | .010 | .25 | | 100 | 500 | |
| MLT2.7S-CP316 | 2.7 | 69 | 10.2 | 259 | 200 | 890 | .50 | 12.7 | .18 | 4.6 | .010 | .25 | | 100 | 500 | |
| MLT4S-CP316 | 4.0 | 102 | 14.3 | 362 | 200 | 890 | .50 | 12.7 | .18 | 4.6 | .010 | .25 | | 100 | 500 | |
| MLT6S-CP316 | 6.0 | 152 | 20.5 | 521 | 200 | 890 | .50 | 12.7 | .18 | 4.6 | .010 | .25 | | 100 | 500 | |
| MLT8S-CP316 | 8.0 | 203 | 26.8 | 679 | 200 | 890 | .50 | 12.7 | .18 | 4.6 | .010 | .25 | | 100 | 500 | |
| MLT10S-CP316 | 10.0 | 254 | 33.0 | 838 | 200 | 890 | .50 | 12.7 | .18 | 4.6 | .010 | .25 | 100 | 500 | | |
| Light-Heavy Cross Section | | | | | | | | | | | | | | | | |
| MLT2LH-LP316 | 2.0 | 51 | 7.9 | 201 | 250 | 1112 | .50 | 12.7 | .25 | 6.4 | .010 | .25 | GS4MT, HTMT, PPTMT, ST2MT | 50 | 250 | |
| MLT4LH-LP316 | 4.0 | 102 | 14.3 | 362 | 250 | 1112 | .50 | 12.7 | .25 | 6.4 | .010 | .25 | | 50 | 250 | |
| MLT6LH-LP316 | 6.0 | 152 | 20.5 | 521 | 250 | 1112 | .50 | 12.7 | .25 | 6.4 | .010 | .25 | | 50 | 250 | |
| MLT8LH-LP316 | 8.0 | 203 | 26.8 | 679 | 250 | 1112 | .50 | 12.7 | .25 | 6.4 | .010 | .25 | | 50 | 250 | |

*Other lengths available, contact PANDUIT Customer Service.

**Per SAE Standard AS23190/3 (formerly MIL). For additional details, refer to page B3.32.

***For information on installation tools, refer to pages B3.14 – B3.16.



PAN-STEEL® Self-Locking Cable Ties – MLT Series (continued)

| Part Number | Max. Bundle Diameter | | Length* | | Min. Loop Tensile Strength** | | Min. Bundle Diameter | | Width | | Thickness | | Recommended Installation Tool*** | Std. Pkg. Qty. | Std. Ctn. Qty. |
|----------------------------------|----------------------|-----|---------|-----|------------------------------|------|----------------------|------|-------|------|-----------|-----|----------------------------------|----------------|----------------|
| | In. | mm | In. | mm | Lbs. | N | In. | mm | In. | mm | In. | mm | | | |
| Heavy Cross Section | | | | | | | | | | | | | | | |
| MLT2H-LP316 | 2.0 | 51 | 7.9 | 201 | 450 | 2000 | .50 | 12.7 | .31 | 7.9 | .010 | .25 | GS4MT, HTMT, PPTMT, ST2MT | 50 | 250 |
| MLT2.7H-LP316 | 2.7 | 69 | 10.2 | 259 | 450 | 2000 | .50 | 12.7 | .31 | 7.9 | .010 | .25 | | 50 | 250 |
| MLT4H-LP316 | 4.0 | 102 | 14.3 | 362 | 450 | 2000 | .50 | 12.7 | .31 | 7.9 | .010 | .25 | | 50 | 250 |
| MLT6H-LP316 | 6.0 | 152 | 20.5 | 521 | 450 | 2000 | .50 | 12.7 | .31 | 7.9 | .010 | .25 | | 50 | 250 |
| MLT8H-LP316 | 8.0 | 203 | 26.8 | 679 | 450 | 2000 | .50 | 12.7 | .31 | 7.9 | .010 | .25 | | 50 | 250 |
| MLT10H-LP316 | 10.0 | 254 | 33.0 | 838 | 450 | 2000 | .50 | 12.7 | .31 | 7.9 | .010 | .25 | | 50 | 250 |
| Extra-Heavy Cross Section | | | | | | | | | | | | | | | |
| MLT4EH-LP316 | 4.0 | 102 | 17.1 | 434 | 600 | 2670 | 1.0 | 25.4 | .50 | 12.7 | .010 | .25 | ST2MT, RT1HT, RT1HTN | 50 | 250 |
| MLT6EH-LP316 | 6.0 | 152 | 23.4 | 594 | 600 | 2670 | 1.0 | 25.4 | .50 | 12.7 | .010 | .25 | | 50 | 250 |
| MLT8EH-LP316 | 8.0 | 203 | 29.7 | 754 | 600 | 2670 | 1.0 | 25.4 | .50 | 12.7 | .010 | .25 | | 50 | 250 |
| MLT4EH15-LP316 | 4.0 | 102 | 17.1 | 434 | 700 | 3115 | 1.0 | 25.4 | .50 | 12.7 | .015 | .38 | | 50 | 250 |
| MLT6EH15-LP316 | 6.0 | 152 | 23.4 | 594 | 700 | 3115 | 1.0 | 25.4 | .50 | 12.7 | .015 | .38 | | 50 | 250 |
| MLT8EH15-LP316 | 8.0 | 203 | 29.7 | 754 | 700 | 3115 | 1.0 | 25.4 | .50 | 12.7 | .015 | .38 | | 50 | 250 |
| Super-Heavy Cross Section | | | | | | | | | | | | | | | |
| MLT4SH-LP316 | 4.0 | 102 | 17.1 | 434 | 900 | 4005 | 1.0 | 25.4 | .63 | 16.0 | .015 | .38 | RT1HT, RT1HTN | 50 | 250 |
| MLT6SH-LP316 | 6.0 | 152 | 23.4 | 594 | 900 | 4005 | 1.0 | 25.4 | .63 | 16.0 | .015 | .38 | | 50 | 250 |
| MLT8SH-LP316 | 8.0 | 203 | 29.7 | 754 | 900 | 4005 | 1.0 | 25.4 | .63 | 16.0 | .015 | .38 | | 50 | 250 |

*Other lengths available, contact PANDUIT Customer Service.

**Per SAE Standard AS23190/3 (formerly MIL). For additional details, refer to page B3.32.

***For information on installation tools, refer to pages B3.14 – B3.16.

A.
System
Overview

B1.
Cable Ties

B2.
Cable
Accessories

B3.
Stainless
Steel Ties

C1.
Wiring
Duct

C2.
Surface
Raceway

C3.
Abrasion
Protection

C4.
Cable
Management

D1.
Terminals

D2.
Power
Connectors

D3.
Grounding
Connectors

E1.
Labeling
Systems

E2.
Labels

E3.
Pre-Printed
& Write-On
Markers

E4.
Permanent
Identification

E5.
Lockout/
Tagout/
& Safety
Solutions

F.
Index

A. System Overview

PAN-STEEL® Polyester Fully Coated Cable Ties – MLTFC Series

B1. Cable Ties

- Self-locking head design speeds installation and locks into place at any length along the tie body
- Polyester coating provides additional edge protection and prevents corrosion between dissimilar metals
- AISI 316 stainless steel for the most corrosive environments
- Available in standard, heavy, extra-heavy and super-heavy cross sections
- UV resistant, low smoke, halogen-free material
- Temperature tolerance -40°F (-40°C) to 302°F (150°C)

B2. Cable Accessories

B3. Stainless Steel Ties



C1. Wiring Duct

C2. Surface Raceway

C3. Abrasion Protection

C4. Cable Management

D1. Terminals

D2. Power Connectors

D3. Grounding Connectors

E1. Labeling Systems

E2. Labels

E3. Pre-Printed & Write-On Markers

E4. Permanent Identification

E5. Lockout/Tagout & Safety Solutions

F. Index

| Part Number | Max. Bundle Diameter | | Length* | | Min. Loop Tensile Strength** | | Min. Bundle Diameter | | Width | | Thickness^ | | Recommended Installation Tool*** | Std. Pkg. Qty. | Std. Ctn. Qty. |
|----------------------------------|----------------------|-----|---------|-----|------------------------------|------|----------------------|------|-------|------|------------|-----|----------------------------------|----------------|----------------|
| | In. | mm | In. | mm | Lbs. | N | In. | mm | In. | mm | In. | mm | | | |
| Standard Cross Section | | | | | | | | | | | | | | | |
| MLTFC2S-CP316 | 2.0 | 51 | 7.9 | 201 | 100 | 445 | .50 | 12.7 | .18 | 4.6 | .010 | .25 | GS4MT, HTMT, PPTMT, ST2MT | 100 | 500 |
| MLTFC4S-CP316 | 4.0 | 102 | 14.3 | 362 | 100 | 445 | .50 | 12.7 | .18 | 4.6 | .010 | .25 | | 100 | 500 |
| MLTFC6S-CP316 | 6.0 | 152 | 20.5 | 521 | 100 | 445 | .50 | 12.7 | .18 | 4.6 | .010 | .25 | | 100 | 500 |
| MLTFC8S-CP316 | 8.0 | 203 | 26.8 | 679 | 100 | 445 | .50 | 12.7 | .18 | 4.6 | .010 | .25 | | 100 | 500 |
| Heavy Cross Section | | | | | | | | | | | | | | | |
| MLTFC2H-LP316 | 2.0 | 51 | 7.9 | 201 | 250 | 1112 | .50 | 12.7 | .31 | 7.9 | .010 | .25 | GS4MT, HTMT, PPTMT, ST2MT | 50 | 250 |
| MLTFC4H-LP316 | 4.0 | 102 | 14.3 | 362 | 250 | 1112 | .50 | 12.7 | .31 | 7.9 | .010 | .25 | | 50 | 250 |
| MLTFC6H-LP316 | 6.0 | 152 | 20.5 | 521 | 250 | 1112 | .50 | 12.7 | .31 | 7.9 | .010 | .25 | | 50 | 250 |
| MLTFC8H-LP316 | 8.0 | 203 | 26.8 | 679 | 250 | 1112 | .50 | 12.7 | .31 | 7.9 | .010 | .25 | | 50 | 250 |
| Extra-Heavy Cross Section | | | | | | | | | | | | | | | |
| MLTFC4EH-LP316 | 4.0 | 102 | 17.1 | 434 | 300 | 1335 | 1.0 | 25.4 | .50 | 12.7 | .010 | .25 | ST2MT, RT1HT, RT1HTN | 50 | 250 |
| MLTFC6EH-LP316 | 6.0 | 152 | 23.4 | 594 | 300 | 1335 | 1.0 | 25.4 | .50 | 12.7 | .010 | .25 | | 50 | 250 |
| MLTFC8EH-LP316 | 8.0 | 203 | 29.7 | 754 | 300 | 1335 | 1.0 | 25.4 | .50 | 12.7 | .010 | .25 | | 50 | 250 |
| Super-Heavy Cross Section | | | | | | | | | | | | | | | |
| MLTFC4SH-LP316 | 4.0 | 102 | 17.1 | 434 | 450 | 2000 | 1.0 | 25.4 | .63 | 15.9 | .015 | .38 | RT1HT, RT1HTN | 50 | 250 |
| MLTFC6SH-LP316 | 6.0 | 152 | 23.4 | 594 | 450 | 2000 | 1.0 | 25.4 | .63 | 15.9 | .015 | .38 | | 50 | 250 |
| MLTFC8SH-LP316 | 8.0 | 203 | 29.7 | 754 | 450 | 2000 | 1.0 | 25.4 | .63 | 15.9 | .015 | .38 | | 50 | 250 |

*Other lengths available, contact PANDUIT Customer Service.

**Per SAE Standard AS23190/3 (formerly MIL). For additional details, refer to page B3.32.

***For information on installation tools, refer to pages B3.14 – B3.16.

^Base material less coating.

PAN-STEEL® Nylon 11 Selectively Coated Cable Ties – MLTC Series

- Self-locking head design speeds installation and locks into place at any length along the tie body
- Nylon 11 coating provides additional edge protection and prevents corrosion between dissimilar metals
- AISI 316 stainless steel for the most corrosive environments
- Available in heavy cross section
- UV resistant, low smoke, halogen-free material
- Temperature tolerance -40°F (-40°C) to 285°F (140°C)



| Part Number | Max. Bundle Diameter | | Length* | | Min. Loop Tensile Strength** | | Min. Bundle Diameter | | Width | | Thickness^ | | Recommended Installation Tool*** | Std. Pkg. Qty. | Std. Ctn. Qty. |
|--|----------------------|-----|---------|-----|------------------------------|------|----------------------|------|-------|-----|------------|-----|----------------------------------|----------------|----------------|
| | In. | mm | In. | mm | Lbs. | N | In. | mm | In. | mm | In. | mm | | | |
| AISI 316 Stainless Steel – For Nylon 11 Selectively Coated Cable Ties | | | | | | | | | | | | | | | |
| Heavy Cross Section | | | | | | | | | | | | | | | |
| MLTC2H-LP316 | 2.0 | 51 | 7.9 | 201 | 250 | 1112 | .50 | 12.7 | .31 | 7.9 | .010 | .25 | GS4MT, HTMT, PPTMT, ST2MT | 50 | 250 |
| MLTC4H-LP316 | 4.0 | 102 | 14.3 | 362 | 250 | 1112 | .50 | 12.7 | .31 | 7.9 | .010 | .25 | | 50 | 250 |
| MLTC6H-LP316 | 6.0 | 152 | 20.5 | 521 | 250 | 1112 | .50 | 12.7 | .31 | 7.9 | .010 | .25 | | 50 | 250 |
| MLTC8H-LP316 | 8.0 | 203 | 26.8 | 679 | 250 | 1112 | .50 | 12.7 | .31 | 7.9 | .010 | .25 | | 50 | 250 |
| MLTC10H-LP316 | 10.0 | 254 | 33.0 | 838 | 250 | 1112 | .50 | 12.7 | .31 | 7.9 | .010 | .25 | | 50 | 250 |

*Other lengths available, contact PANDUIT Customer Service.

**Per SAE Standard AS23190/3 (formerly MIL). For additional details, refer to page B3.32.

***For information on installation tools, refer to pages B3.14 – B3.16.

^Base material less coating.

A.
System
Overview

B1.
Cable Ties

B2.
Cable
Accessories

B3.
Stainless
Steel Ties

C1.
Wiring
Duct

C2.
Surface
Raceway

C3.
Abrasion
Protection

C4.
Cable
Management

D1.
Terminals

D2.
Power
Connectors

D3.
Grounding
Connectors

E1.
Labeling
Systems

E2.
Labels

E3.
Pre-Printed
& Write-On
Markers

E4.
Permanent
Identification

E5.
Lockout/
Tagout/
& Safety
Solutions

F.
Index

A. System Overview



PAN-ALUM™ Aluminum Cable Ties – MLT Series

B1. Cable Ties

- Self-locking head design speeds installation and locks into place at any length along the tie body
- Lightweight, aluminum construction for flexibility and ease of handling
- Five color options in addition to natural aluminum finish for color-coding applications
- Smooth surfaces and rounded edges assures cable protection and worker safety
- For use with PAN-ALUM™ Marker Plates on page E4.5, for fast installation at the lowest installed cost

B2. Cable Accessories

B3. Stainless Steel Ties



C1. Wiring Duct

C2. Surface Raceway

C3. Abrasion Protection

C4. Cable Management

D1. Terminals

D2. Power Connectors

D3. Grounding Connectors

E1. Labeling Systems

E2. Labels

E3. Pre-Printed & Write-On Markers

E4. Permanent Identification

E5. Lockout/Tagout & Safety Solutions

F. Index

| Part Number | Max. Bundle Diameter | | Length | | Color | Min. Loop Tensile Strength* | | Min. Bundle Diameter | | Width | | Thickness | | Recommended Installation Tool** | Std. Pkg. Qty. | Std. Ctn. Qty. |
|---------------------|----------------------|-----|--------|-----|----------|-----------------------------|-----|----------------------|------|-------|-----|-----------|-----|---------------------------------|----------------|----------------|
| | In. | mm | In. | mm | | Lbs. | N | In. | mm | In. | mm | In. | mm | | | |
| MLT1H-LPALBL | 1.0 | 25 | 5.5 | 140 | Black | 50 | 222 | .50 | 12.7 | .31 | 7.9 | .012 | .03 | ST2MT, HTMT | 50 | 250 |
| MLT2H-LPALBL | 2.0 | 51 | 7.9 | 201 | Black | 50 | 222 | .50 | 12.7 | .31 | 7.9 | .012 | .03 | | 50 | 250 |
| MLT4H-LPALBL | 4.0 | 102 | 14.3 | 362 | Black | 50 | 222 | .50 | 12.7 | .31 | 7.9 | .012 | .03 | | 50 | 250 |
| MLT1H-LPALRD | 1.0 | 25 | 5.5 | 140 | Red | 50 | 222 | .50 | 12.7 | .31 | 7.9 | .012 | .03 | | 50 | 250 |
| MLT2H-LPALRD | 2.0 | 51 | 7.9 | 201 | Red | 50 | 222 | .50 | 12.7 | .31 | 7.9 | .012 | .03 | | 50 | 250 |
| MLT4H-LPALRD | 4.0 | 102 | 14.3 | 362 | Red | 50 | 222 | .50 | 12.7 | .31 | 7.9 | .012 | .03 | | 50 | 250 |
| MLT1H-LPALYL | 1.0 | 25 | 5.5 | 140 | Yellow | 50 | 222 | .50 | 12.7 | .31 | 7.9 | .012 | .03 | | 50 | 250 |
| MLT2H-LPALYL | 2.0 | 51 | 7.9 | 201 | Yellow | 50 | 222 | .50 | 12.7 | .31 | 7.9 | .012 | .03 | | 50 | 250 |
| MLT4H-LPALYL | 4.0 | 102 | 14.3 | 362 | Yellow | 50 | 222 | .50 | 12.7 | .31 | 7.9 | .012 | .03 | | 50 | 250 |
| MLT1H-LPALGR | 1.0 | 25 | 5.5 | 140 | Green | 50 | 222 | .50 | 12.7 | .31 | 7.9 | .012 | .03 | | 50 | 250 |
| MLT2H-LPALGR | 2.0 | 51 | 7.9 | 201 | Green | 50 | 222 | .50 | 12.7 | .31 | 7.9 | .012 | .03 | | 50 | 250 |
| MLT4H-LPALGR | 4.0 | 102 | 14.3 | 362 | Green | 50 | 222 | .50 | 12.7 | .31 | 7.9 | .012 | .03 | | 50 | 250 |
| MLT1H-LPALBU | 1.0 | 25 | 5.5 | 140 | Blue | 50 | 222 | .50 | 12.7 | .31 | 7.9 | .012 | .03 | | 50 | 250 |
| MLT2H-LPALBU | 2.0 | 51 | 7.9 | 201 | Blue | 50 | 222 | .50 | 12.7 | .31 | 7.9 | .012 | .03 | | 50 | 250 |
| MLT4H-LPALBU | 4.0 | 102 | 14.3 | 362 | Blue | 50 | 222 | .50 | 12.7 | .31 | 7.9 | .012 | .03 | | 50 | 250 |
| MLT1H-LPAL | 1.0 | 25 | 5.5 | 140 | Aluminum | 50 | 222 | .50 | 12.7 | .31 | 7.9 | .012 | .03 | | 50 | 250 |
| MLT2H-LPAL | 2.0 | 51 | 7.9 | 201 | Aluminum | 50 | 222 | .50 | 12.7 | .31 | 7.9 | .012 | .03 | | 50 | 250 |
| MLT4H-LPAL | 4.0 | 102 | 14.3 | 362 | Aluminum | 50 | 222 | .50 | 12.7 | .31 | 7.9 | .012 | .03 | | 50 | 250 |

*Per SAE Standard AS23190/3 (formerly MIL). For additional details, refer to page B3.32.

**For information on installation tools, refer to page B3.15.

PAN-STEEL® Double Wrapped Cable Ties – MLTD Series

- Self-locking head design speeds installation and locks into place at any length along the tie body
- Cable tie body passes through the head two times for additional strength
- Available in heavy, extra-heavy, and super-heavy cross sections
- Available in AISI 304 stainless steel for general-purpose applications
- Available in AISI 316 stainless steel for the most corrosive environments
- Super-heavy double wrapped tested for short circuit applications up to 71.5 kA

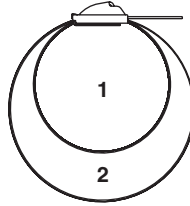

| Part Number | Max. Bundle Diameter | | Length* | | Min. Loop Tensile Strength** | | Min. Bundle Diameter | | Width | | Thickness | | Recommended Installation Tool*** | Std. Pkg. Qty. | Std. Ctn. Qty. |
|-------------|----------------------|----|---------|----|------------------------------|---|----------------------|----|-------|----|-----------|----|----------------------------------|----------------|----------------|
| | In. | mm | In. | mm | Lbs. | N | In. | mm | In. | mm | In. | mm | | | |

AISI 304 Stainless Steel – MLTD Double Wrapped Ties

Heavy Cross Section

| | | | | | | | | | | | | | | | |
|----------|-----|-----|------|------|-----|------|-----|------|-----|-----|------|-----|---------------------------|----|-----|
| MLT2DH-L | 2.0 | 51 | 18.5 | 470 | 600 | 2670 | 1.0 | 25.4 | .31 | 7.9 | .010 | .25 | GS4MT, HTMT, PPTMT, ST2MT | 50 | 250 |
| MLT4DH-L | 4.0 | 102 | 28.0 | 711 | 600 | 2670 | 1.0 | 25.4 | .31 | 7.9 | .010 | .25 | | 50 | 250 |
| MLT5DH-L | 5.0 | 127 | 34.0 | 863 | 600 | 2670 | 1.0 | 25.4 | .31 | 7.9 | .010 | .25 | | 50 | 250 |
| MLT6DH-Q | 6.0 | 152 | 40.0 | 1016 | 600 | 2670 | 1.0 | 25.4 | .31 | 7.9 | .010 | .25 | | 25 | 250 |

Extra-Heavy Cross Section

| | | | | | | | | | | | | | | | |
|-------------|-----|-----|------|------|------|------|-----|------|-----|------|------|-----|----------------------|----|-----|
| MLT4DEH-Q | 4.0 | 102 | 29.5 | 749 | 800 | 3560 | 1.0 | 25.4 | .50 | 12.7 | .010 | .25 | ST2MT, RT1HT, RT1HTN | 25 | 125 |
| MLT6DEH-Q | 6.0 | 152 | 41.5 | 1054 | 800 | 3560 | 1.0 | 25.4 | .50 | 12.7 | .010 | .25 | | 25 | 125 |
| MLT8DEH-Q | 8.0 | 203 | 53.5 | 1359 | 800 | 3560 | 1.0 | 25.4 | .50 | 12.7 | .010 | .25 | | 25 | 125 |
| MLT4DEH15-Q | 4.0 | 102 | 29.5 | 749 | 1000 | 4450 | 1.0 | 25.4 | .50 | 12.7 | .015 | .38 | | 25 | 125 |
| MLT6DEH15-Q | 6.0 | 152 | 41.5 | 1054 | 1000 | 4450 | 1.0 | 25.4 | .50 | 12.7 | .015 | .38 | | 25 | 125 |
| MLT8DEH15-Q | 8.0 | 203 | 53.5 | 1359 | 1000 | 4450 | 1.0 | 25.4 | .50 | 12.7 | .015 | .38 | | 25 | 125 |

Super-Heavy Cross Section

| | | | | | | | | | | | | | | | |
|-----------|-----|-----|------|------|------|------|-----|------|-----|------|------|-----|---------------|----|-----|
| MLT4DSH-Q | 4.0 | 102 | 29.5 | 749 | 1200 | 5340 | 1.0 | 25.4 | .63 | 15.9 | .015 | .38 | RT1HT, RT1HTN | 25 | 125 |
| MLT6DSH-Q | 6.0 | 152 | 41.5 | 1054 | 1200 | 5340 | 1.0 | 25.4 | .63 | 15.9 | .015 | .38 | | 25 | 125 |
| MLT8DSH-Q | 8.0 | 203 | 53.5 | 1359 | 1200 | 5340 | 1.0 | 25.4 | .63 | 15.9 | .015 | .38 | | 25 | 125 |

AISI 316 Stainless Steel – For MLTD Double Wrapped Ties

Extra-Heavy Cross Section

| | | | | | | | | | | | | | | | |
|----------------|-----|-----|------|------|------|------|-----|------|-----|------|------|-----|----------------------|----|-----|
| MLT4DEH-Q316 | 4.0 | 102 | 29.5 | 749 | 800 | 3560 | 1.0 | 25.4 | .50 | 12.7 | .010 | .25 | ST2MT, RT1HT, RT1HTN | 25 | 125 |
| MLT6DEH-Q316 | 6.0 | 152 | 41.5 | 1054 | 800 | 3560 | 1.0 | 25.4 | .50 | 12.7 | .010 | .25 | | 25 | 125 |
| MLT8DEH-Q316 | 8.0 | 203 | 53.5 | 1359 | 800 | 3560 | 1.0 | 25.4 | .50 | 12.7 | .010 | .25 | | 25 | 125 |
| MLT4DEH15-Q316 | 4.0 | 102 | 29.5 | 749 | 1000 | 4450 | 1.0 | 25.4 | .50 | 12.7 | .015 | .38 | | 25 | 125 |
| MLT6DEH15-Q316 | 6.0 | 152 | 41.5 | 1054 | 1000 | 4450 | 1.0 | 25.4 | .50 | 12.7 | .015 | .38 | | 25 | 125 |
| MLT8DEH15-Q316 | 8.0 | 203 | 53.5 | 1359 | 1000 | 4450 | 1.0 | 25.4 | .50 | 12.7 | .015 | .38 | | 25 | 125 |

Super-Heavy Cross Section

| | | | | | | | | | | | | | | | |
|--------------|-----|-----|------|------|------|------|-----|------|-----|------|------|-----|---------------|----|-----|
| MLT4DSH-Q316 | 4.0 | 102 | 29.5 | 749 | 1200 | 5340 | 1.0 | 25.4 | .63 | 15.9 | .015 | .38 | RT1HT, RT1HTN | 25 | 125 |
| MLT6DSH-Q316 | 6.0 | 152 | 41.5 | 1054 | 1200 | 5340 | 1.0 | 25.4 | .63 | 15.9 | .015 | .38 | | 25 | 125 |
| MLT8DSH-Q316 | 8.0 | 203 | 53.5 | 1359 | 1200 | 5340 | 1.0 | 25.4 | .63 | 15.9 | .015 | .38 | | 25 | 125 |

*Other lengths available, contact PANDUIT Customer Service.

**Per SAE Standard AS23190/3 (formerly MIL). For additional details, refer to page B3.32.

***For information on installation tools, refer to pages B3.14 – B3.16.

A.
System
Overview

B1.
Cable Ties

B2.
Cable
Accessories

B3.
Stainless
Steel Ties

C1.
Wiring
Duct

C2.
Surface
Raceway

C3.
Abrasion
Protection

C4.
Cable
Management

D1.
Terminals

D2.
Power
Connectors

D3.
Grounding
Connectors

E1.
Labeling
Systems

E2.
Labels

E3.
Pre-Printed
& Write-On
Markers

E4.
Permanent
Identification

E5.
Lockout/
Tagout
& Safety
Solutions

F.
Index

A. System Overview

PAN-STEEL® Custom Length Banding – MBS, MBH, MBEH and MBSH Series

B1. Cable Ties

B2. Cable Accessories

B3. Stainless Steel Ties

- For applications that require various bundle diameters
- Supplied in reels of 82.50 feet (25.0m), 200.00 feet (60.9m), 250.00 feet (76.2m) or 1000.00 feet (304.8m)
- Provides job site versatility with minimum inventory
- Packaging speeds removal of steel and includes bundle diameter cut-off guide
- Available in AISI 304 stainless steel for general-purpose applications
- Available in AISI 316 stainless steel for the most corrosive environments

Polyester coating (optional):

- Polyester coating provides additional edge protection and prevents corrosion between dissimilar metals
- UV resistant, low smoke, halogen-free material
- Temperature tolerance -40°F (-40°C) to 302°F (150°C)
- AISI 316 stainless steel for the most corrosive environments



C1. Wiring Duct

C2. Surface Raceway

C3. Abrasion Protection

C4. Cable Management

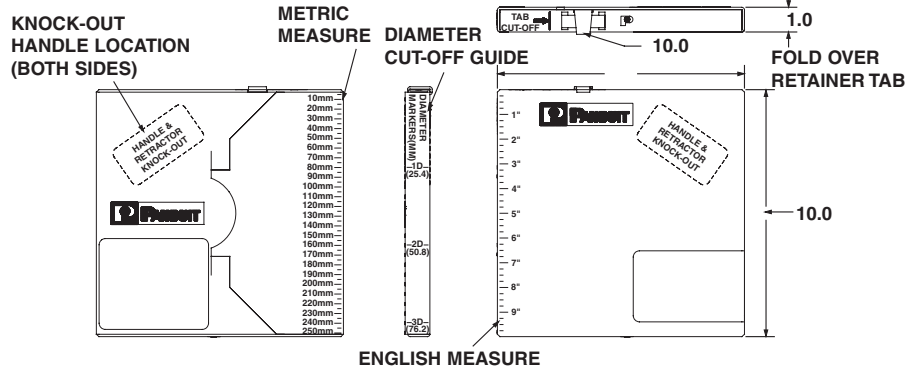

| Part Number | Max. Bundle Diameter | | Length* | | Min. Loop Tensile Strength** | | Min. Bundle Diameter | | Width | | Thickness^ | | Recommended Installation Tool*** | Recommended Banding Head | Std. Pkg. Qty.‡ |
|-------------|----------------------|----|---------|---|------------------------------|---|----------------------|----|-------|----|------------|----|----------------------------------|--------------------------|-----------------|
| | In. | mm | Ft. | M | Lbs. | N | In. | mm | In. | mm | In. | mm | | | |

AISI 304 Stainless Steel — For General Purpose Banding

Standard Cross Section

| | | | | | | | | | | | | | | | |
|----------------|-----|-----|------|-----|-----|-----|-----|------|-----|-----|------|-----|--------------|--------|---|
| MBS-TLR | Any | Any | 250 | 76 | 100 | 445 | .50 | 12.7 | .18 | 4.4 | .010 | .25 | GS4MT, HTMT, | MTHS-C | 1 |
| MBS-MR | Any | Any | 1000 | 305 | 100 | 445 | .50 | 12.7 | .18 | 4.4 | .010 | .25 | PPTMT, ST2MT | MTHS-C | 1 |

Heavy Cross Section

| | | | | | | | | | | | | | | | |
|----------------|-----|-----|------|-----|-----|------|-----|------|-----|-----|------|-----|--------------|--------|---|
| MBH-TLR | Any | Any | 250 | 76 | 250 | 1112 | .50 | 12.7 | .31 | 7.9 | .010 | .25 | GS4MT, HTMT, | MTHH-C | 1 |
| MBH-MR | Any | Any | 1000 | 305 | 250 | 1112 | .50 | 12.7 | .31 | 7.9 | .010 | .25 | PPTMT, ST2MT | MTHH-C | 1 |

Extra-Heavy Cross Section

| | | | | | | | | | | | | | | | |
|-----------------|-----|-----|-----|----|-----|------|-----|------|-----|------|------|-----|----------------------|---------|---|
| MBEH-TLR | Any | Any | 250 | 76 | 300 | 1335 | 1.0 | 25.4 | .50 | 12.7 | .010 | .25 | ST2MT, RT1HT, RT1HTN | MTHEH-C | 1 |
|-----------------|-----|-----|-----|----|-----|------|-----|------|-----|------|------|-----|----------------------|---------|---|

Super-Heavy Cross Section

| | | | | | | | | | | | | | | | |
|----------------|-----|-----|-----|----|-----|------|-----|------|-----|------|------|-----|---------------|---------|---|
| MBSH-TR | Any | Any | 200 | 61 | 450 | 2000 | 1.0 | 25.4 | .63 | 15.9 | .015 | .38 | RT1HT, RT1HTN | MTHSH-C | 1 |
|----------------|-----|-----|-----|----|-----|------|-----|------|-----|------|------|-----|---------------|---------|---|

AISI 316 Stainless Steel — For Superior Corrosion Resistance

Standard Cross Section

| | | | | | | | | | | | | | | | |
|-------------------|-----|-----|------|-----|-----|-----|-----|------|-----|-----|------|-----|--------------|-----------|---|
| MBS-TLR316 | Any | Any | 250 | 76 | 100 | 445 | .50 | 12.7 | .18 | 4.4 | .010 | .25 | GS4MT, HTMT, | MTHS-C316 | 1 |
| MBS-MR316 | Any | Any | 1000 | 305 | 100 | 445 | .50 | 12.7 | .18 | 4.4 | .010 | .25 | PPTMT, ST2MT | MTHS-C316 | 1 |

Heavy Cross Section

| | | | | | | | | | | | | | | | |
|-------------------|-----|-----|------|-----|-----|------|-----|------|-----|-----|------|-----|--------------|-----------|---|
| MBH-TLR316 | Any | Any | 250 | 76 | 250 | 1112 | .50 | 12.7 | .31 | 7.9 | .010 | .25 | GS4MT, HTMT, | MTHH-C316 | 1 |
| MBH-MR316 | Any | Any | 1000 | 305 | 250 | 1112 | .50 | 12.7 | .31 | 7.9 | .010 | .25 | PPTMT, ST2MT | MTHH-C316 | 1 |

Extra-Heavy Cross Section

| | | | | | | | | | | | | | | | |
|--------------------|-----|-----|-----|----|-----|------|-----|------|-----|------|------|-----|----------------------|------------|---|
| MBEH-TLR316 | Any | Any | 250 | 76 | 300 | 1335 | 1.0 | 25.4 | .50 | 12.7 | .010 | .25 | ST2MT, RT1HT, RT1HTN | MTHEH-C316 | 1 |
|--------------------|-----|-----|-----|----|-----|------|-----|------|-----|------|------|-----|----------------------|------------|---|

Super-Heavy Cross Section

| | | | | | | | | | | | | | | | |
|-------------------|-----|-----|-----|----|-----|------|-----|------|-----|------|------|-----|---------------|------------|---|
| MBSH-TR316 | Any | Any | 200 | 61 | 450 | 2000 | 1.0 | 25.4 | .63 | 15.9 | .015 | .38 | RT1HT, RT1HTN | MTHSH-C316 | 1 |
|-------------------|-----|-----|-----|----|-----|------|-----|------|-----|------|------|-----|---------------|------------|---|

Polyester Coated AISI 316 Stainless Steel

Heavy Cross Section

| | | | | | | | | | | | | | | | |
|-------------------|-----|-----|----|----|-----|------|-----|------|-----|-----|------|-----|---------------------------|------------|---|
| MBCH-QR316 | Any | Any | 82 | 25 | 250 | 1112 | .50 | 12.7 | .31 | 7.9 | .010 | .25 | GS4MT, HTMT, PPTMT, ST2MT | MTHCH-C316 | 1 |
|-------------------|-----|-----|----|----|-----|------|-----|------|-----|-----|------|-----|---------------------------|------------|---|

*Other lengths available, contact PANDUIT Customer Service.

**Per SAE Standard AS23190/3 (formerly MIL). For additional details, refer to page B3.32.

***For more information on installation tools, refer to pages B3.14 – B3.16.

^Base material less coating.

‡Order in number of reels required.

PAN-STEEL® Custom Length Banding – MBS, MBH, MBEH and MBSH Series (continued)

| Part Number | Max. Bundle Diameter | | Length* | | Min. Loop Tensile Strength** | | Min. Bundle Diameter | | Width | | Thickness^ | | Recommended Installation Tool*** | Recommended Banding Head | Std. Pkg. Qty.‡ |
|----------------------------------|----------------------|-----|---------|----|------------------------------|------|----------------------|------|-------|------|------------|-----|----------------------------------|--------------------------|-----------------|
| | In. | mm | Ft. | M | Lbs. | N | In. | mm | In. | mm | In. | mm | | | |
| Extra-Heavy Cross Section | | | | | | | | | | | | | | | |
| MBCEH-QR316 | Any | Any | 82 | 25 | 300 | 1335 | 1.0 | 25.4 | .50 | 12.7 | .010 | .25 | ST2MT, RT1HT, RT1HTN | MTHCEH-C316 | 1 |
| Super-Heavy Cross Section | | | | | | | | | | | | | | | |
| MBCSH-QR316 | Any | Any | 82 | 25 | 450 | 2000 | 1.0 | 25.4 | .63 | 15.9 | .015 | .38 | RT1HT, RT1HTN | MTHCSH-C316 | 1 |

*Other lengths available, contact PANDUIT Customer Service.

**Per SAE Standard AS23190/3 (formerly MIL). For additional details, refer to page B3.32.

***For more information on installation tools, refer to pages B3.14 – B3.16.

^Base material less coating.

‡Order in number of reels required.

To determine the proper amount of banding required, use the following formula:

Calculate S and H Cross Section Diameter inches (mm) x 3.14 + 3 inches (76mm)

Calculate EH and SH Cross Section Diameter inches (mm) x 3.14 + 4.5 inches (114mm)

PAN-STEEL® Custom Length Banding Heads – MTH Series

- Self-locking head design speeds installation and locks into place at any length along the tie body



| Part Number | Part Description | Std. Pkg. Qty. | Std. Ctn. Qty. |
|--|--|----------------|----------------|
| AISI 304 Stainless Steel | | | |
| MTHS-C | Loose piece banding head for standard cross section banding. | 100 | 1000 |
| MTHH-C | Loose piece banding head for heavy cross section banding. | 100 | 1000 |
| MTHEH-C | Loose piece banding head for extra-heavy cross section banding. | 100 | 1000 |
| MTHSH-C | Loose piece banding head for super-heavy cross section banding. | 100 | 1000 |
| AISI 316 Stainless Steel | | | |
| MTHS-C316 | Loose piece banding head for standard cross section banding. | 100 | 1000 |
| MTHH-C316 | Loose piece banding head for heavy cross section banding. | 100 | 1000 |
| MTHEH-C316 | Loose piece banding head for extra-heavy cross section banding. | 100 | 1000 |
| MTHSH-C316 | Loose piece banding head for super-heavy cross section banding. | 100 | 1000 |
| AISI 316 Coated Stainless Steel | | | |
| MTHCH-C316 | Loose piece coated banding head for heavy cross section banding. | 100 | 1000 |
| MTHCEH-C316 | Loose piece coated banding head for extra-heavy cross section banding. | 100 | 1000 |
| MTHCSH-C316 | Loose piece coated banding head for super-heavy cross section banding. | 100 | 1000 |

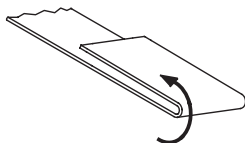

1) Take one end of the cut banding and bend back 1/2" (13mm).

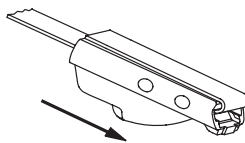

2) Take a self-locking head and slide it the entire length of the band until it reaches the bend.

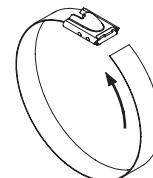

3) Bend tail flat against bottom of banding head to complete assembly.

A. System Overview

B1. Cable Ties

B2. Cable Accessories

B3. Stainless Steel Ties

C1. Wiring Duct

C2. Surface Raceway

C3. Abrasion Protection

C4. Cable Management

D1. Terminals

D2. Power Connectors

D3. Grounding Connectors

E1. Labeling Systems

E2. Labels

E3. Pre-Printed & Write-On Markers

E4. Permanent Identification

E5. Lockout/Tagout & Safety Solutions

F. Index

A.
System
Overview

GS4MT Hand Operated Installation Tool

B1.
Cable Ties

- Single handle operation for fast installation
- Cable tie side entry for immediate positioning of tie and tool
- Controlled tension, fully adjustable
- Easy removal of excess tie

- Qualified product listed per MIL Standard MS90387-3
- Automatically tensions and cuts off tie when predetermined tension is reached
- Installs standard .18 inch (4.6mm), light-heavy .25 inch (6.4mm) and heavy .31 inch (7.9mm) cross section ties

B2.
Cable
Accessories

B3.
Stainless
Steel Ties



GS4MT

| Part Number | Part Description | Std. Pkg. Qty. |
|----------------|---|----------------|
| GS4MT | Used with standard, light-heavy, and heavy cross section <i>PAN-STEEL</i> ® type MLT ties, type MLTC/MLTFC coated ties, and type MLTDH double wrapped ties. | 1 |
| K4M-BLD | Replacement cutter blade for GS4MT. | 1 |
| K4MTG | Replacement tension gripper for GS4MT. | 1 |
| CAMT | Cut-off accessory. Use this accessory with GS4MT tool to cut MBH or MBS continuous banding. Accessory drops in place for use. | 1 |

C1.
Wiring
Duct

C2.
Surface
Raceway

C3.
Abrasion
Protection

C4.
Cable
Management



Side Entry



CAMT

D1.
Terminals

D2.
Power
Connectors

Tool Tension Locking Kits

- For applications requiring a locking device on either the selector knob (one cross section size and tension only) or tension level adjustment (but allow cross section size changes)

D3.
Grounding
Connectors



| Part Number | Part Description | Std. Pkg. Qty. |
|--------------|--|----------------|
| TTLK3 | Tool tension locking kit for GS4MT and PPTMT installation tools. | 1 |

E1.
Labeling
Systems

E2.
Labels

To lock selector knob and tension level.

E3.
Pre-Printed
& Write-On
Markers



E4.
Permanent
Identification

E5.
Lockout/
Tagout/
& Safety
Solutions

To lock fine adjustment.

F.
Index

ST2MT Installation Tool

- Cable tie side entry for immediate positioning of tie and tool
- One hand operation – lightweight
- Easy removal of excess tie
- Tool tension is controlled by installer – twist action cut-off
- Rugged, lightweight, easy-to-operate pliers-type tool provides mechanical advantage



| Part Number | Part Description | Std. Pkg. Qty. |
|--------------|---|----------------|
| ST2MT | Used with standard, light-heavy, heavy and extra-heavy cross section <i>PAN-STEEL</i> ® type MLT ties, type MLTC/MLTFC coated ties, and type MLTDH double wrapped ties. | 1 |

RT1HT and RT1HTN Installation Tools

- Cable tie side entry for immediate positioning of tie and tool
- One or two hand tensioning with multi-position rear handle
- Adjustable tension control
- Lever actuated cut-off
- Easy removal of excess tie
- Ratchet style tool for high tension
- Narrow nose tool design option available for applications requiring installations in tight confined spaces



RT1HT



RT1HTN

| Part Number | Part Description | Std. Pkg. Qty. |
|---------------|---|----------------|
| RT1HT | Used with extra-heavy .50" (12.7mm) and super-heavy .63" (15.9mm) cross section <i>PAN-STEEL</i> ® type MLT and MLTFC ties. Width of tool nose 2.60" (66.0mm). | 1 |
| RT1HTN | Narrow nose installation tool for use with extra-heavy .50" (12.7mm) and super-heavy .63" (15.9mm) cross section <i>PAN-STEEL</i> ® type MLT and MLTFC ties. Width of tool nose 1.06" (27.0mm). | 1 |

HTMT Installation Tool

- Economical
- Coiled tie end remaining after tensioning assures a safe end
- Manual tension, no cut-off
- Installs ties parallel to the bundle



| Part Number | Part Description | Std. Pkg. Qty. |
|-------------|---|----------------|
| HTMT | Used with standard, light-heavy, and heavy cross section <i>PAN-STEEL</i> ® type MLT ties, type MLTC/MLTFC coated ties, and type MLTDH double wrapped ties. | 1 |

A.
System
Overview

B1.
Cable Ties

B2.
Cable
Accessories

B3.
Stainless
Steel Ties

C1.
Wiring
Duct

C2.
Surface
Raceway

C3.
Abrasion
Protection

C4.
Cable
Management

D1.
Terminals

D2.
Power
Connectors

D3.
Grounding
Connectors

E1.
Labeling
Systems

E2.
Labels

E3.
Pre-Printed
& Write-On
Markers

E4.
Permanent
Identification

E5.
Lockout/
Tagout
& Safety
Solutions

F.
Index

A. System Overview

PPTMT Pneumatic Installation Tool

B1. Cable Ties

- Power assisted tool for fast and effortless installation
- Cable tie side entry for immediate positioning of tie and tool
- Controlled tension, fully adjustable
- Automatic cut-off
- One hand operation – lightweight
- Easy removal of excess tie
- Operates 85 PSI (586 KPA Bar) non-lubricated air and requires no special maintenance

B2. Cable Accessories

B3. Stainless Steel Ties



PPTMT

| Part Number | Part Description | Std. Pkg. Qty. |
|----------------|--|----------------|
| PPTMT | Pneumatic hand tool used with <i>PAN-STEEL</i> type MLT ties, type MLTC/MLTFC coated ties, and type MLTDH double wrapped ties. Automatically tensions and cuts off tie when predetermined tension is reached, providing more reliable and consistent installations. Ideal for high production applications. Installs standard .18" (4.6mm), light-heavy .25" (6.4mm), and heavy .31" (7.9mm) cross section ties. | 1 |
| PPH10 | 10.0' (3m) hose assembly (regulator to tool); includes a .13" (3.3mm) NPT male connector (to regulator) and .13" (3.3mm) female quick disconnect (to tool). | 1 |
| PL289N1 | Filter/regulator .5 micron element, regulated range 3 – 100 psig, features .13" (3.3mm) NPT female output port (to hose PPH10) and .25" (6.4mm) male quick disconnect to source air line. | 1 |
| KPPTMTG | Replacement gripper kit for PPTMT. | 1 |
| KPPTMTB | Replacement blade kit for PPTMT. | 1 |

C1. Wiring Duct

C2. Surface Raceway

C3. Abrasion Protection

C4. Cable Management



Side Entry

D1. Terminals

D2. Power Connectors

D3. Grounding Connectors

E1. Labeling Systems

E2. Labels

E3. Pre-Printed & Write-On Markers

E4. Permanent Identification

E5. Lockout/Tagout & Safety Solutions

F. Index

Adjustment Features for PPTMT and GS4MT Tools*

Fast and Easy Selection



The cross section of the cable tie being installed is clearly indicated on the knob. To change, simply flip knob to proper cross section indicator.

Tension Indicator



Each cross section of cable ties can be installed with a variety of tensions to meet the application. The proper tensions (listed on *PANDUIT* cable tie packages) are clearly marked with this indicator.

To Change the Tension:



Turn clockwise to increase.



Turn counterclockwise to decrease.

*For information on GS4MT installation tool, refer to page B3.14.

Features and Benefits – PAN-STEEL® Retained Tension Ties – MRT/MRS Series

PANDUIT® PAN-STEEL® Retained Tension Ties are engineered for safety, productivity, and durability by providing round edges and smooth surfaces, easy threading, high loop tensile strength and tight clamping.

PANDUIT Retained Tension Tie Technology

Features of Retained Tension Ties (MRT and MRS Series)*

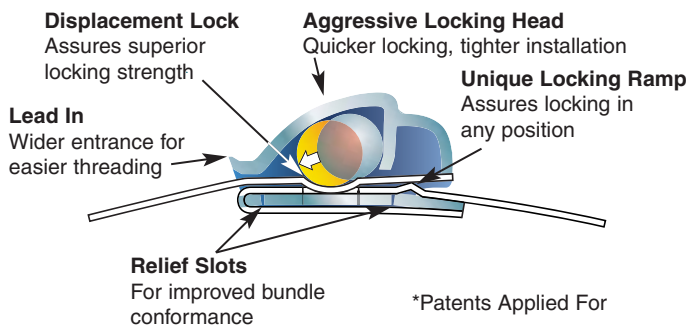

Additional Features of 360° Radial Seal Retained Tension Ties (MRS Series Only)*

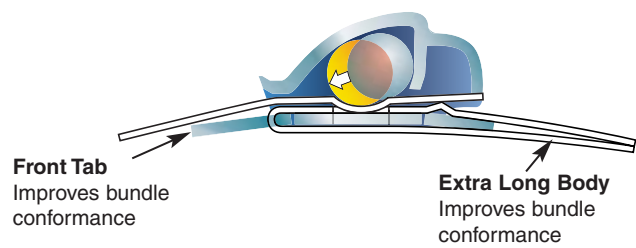

Retained Tension Performance Comparison**

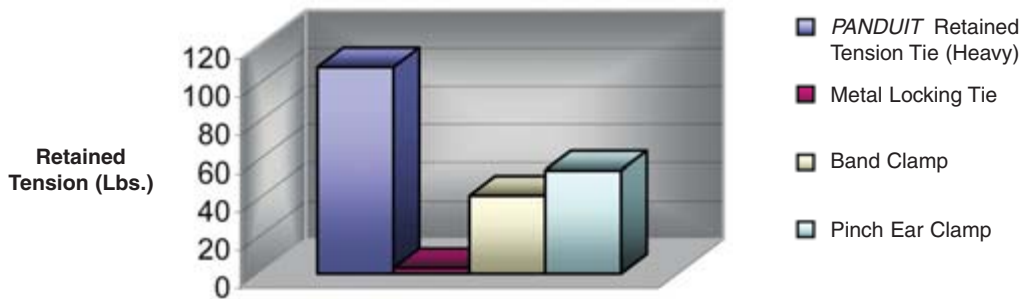

**Representative sample, actual results may vary.

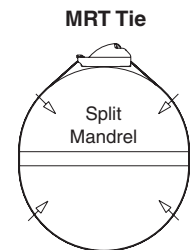

Retained Tension
Split mandrel test fixture measures retained tension of installed tie

A. System Overview

B1. Cable Ties

B2. Cable Accessories

B3. Stainless Steel Ties

C1. Wiring Duct

C2. Surface Raceway

C3. Abrasion Protection

C4. Cable Management

D1. Terminals

D2. Power Connectors

D3. Grounding Connectors

E1. Labeling Systems

E2. Labels

E3. Pre-Printed & Write-On Markers

E4. Permanent Identification

E5. Lockout/Tagout & Safety Solutions

F. Index

Part Number System for PAN-STEEL® Retained Tension Ties – MRT Series

MRT

Type

MRT = Metal Retained Tension Tie

6

Bundle Diameter Reference (In.)

S

Cross Section

S = Standard
LH = Light-Heavy
H = Heavy

—

C

Package Qty.

L = 50
C = 100

4

Material

4 = 304
6 = 316

NEW!

PAN-STEEL® Retained Tension Ties – MRT Series

- Provide tight bundling of armored cables, pipes, conduit and other rigid materials in harsh conditions for a reliable, easy to install fastening solution
- Self-locking cable tie design locks into place at any length along the tie body, unlike fixed diameter band clamps
- Smooth surfaces and rounded edges assures cable protection and worker safety
- Available in AISI 304 stainless steel for general-purpose applications
- Available in AISI 316 stainless steel for the most corrosive environments



| Part Number | Max. Bundle Diameter | | Length | | Min. Loop Tensile Strength | | Min. Bundle Diameter | | Width | | Thickness | | Tool* | Std. Pkg. Qty. | Std. Ctn. Qty. |
|---|----------------------|-----|--------|-----|----------------------------|------|----------------------|------|-------|-----|-----------|-----|--------|----------------|----------------|
| | In. | mm | In. | mm | Lbs. | N | In. | mm | In. | mm | In. | mm | | | |
| AISI 304 Stainless Steel – For General Purpose | | | | | | | | | | | | | | | |
| Standard Cross Section | | | | | | | | | | | | | | | |
| MRT1S-C4 | 1.0 | 25 | 8.1 | 205 | 180 | 800 | .75 | 19.1 | .18 | 4.4 | .010 | .25 | MTRTLS | 100 | 500 |
| MRT2S-C4 | 2.0 | 51 | 11.3 | 287 | 180 | 800 | .75 | 19.1 | .18 | 4.4 | .010 | .25 | | 100 | 500 |
| MRT4S-C4 | 4.0 | 102 | 17.6 | 447 | 180 | 800 | .75 | 19.1 | .18 | 4.4 | .010 | .25 | | 100 | 500 |
| MRT6S-C4 | 6.0 | 152 | 23.8 | 604 | 180 | 800 | .75 | 19.1 | .18 | 4.4 | .010 | .25 | | 100 | 500 |
| Light-Heavy Cross Section | | | | | | | | | | | | | | | |
| MRT1.5LH-L4 | 1.5 | 38 | 9.7 | 246 | 225 | 1000 | 1.00 | 25.4 | .25 | 6.4 | .010 | .25 | MTRTLS | 50 | 250 |
| MRT2LH-L4 | 2.0 | 51 | 11.3 | 287 | 225 | 1000 | 1.00 | 25.4 | .25 | 6.4 | .010 | .25 | | 50 | 250 |
| MRT4LH-L4 | 4.0 | 102 | 17.6 | 447 | 225 | 1000 | 1.00 | 25.4 | .25 | 6.4 | .010 | .25 | | 50 | 250 |
| MRT6LH-L4 | 6.0 | 152 | 23.8 | 604 | 225 | 1000 | 1.00 | 25.4 | .25 | 6.4 | .010 | .25 | | 50 | 250 |
| Heavy Cross Section | | | | | | | | | | | | | | | |
| MRT1.5H-L4 | 1.5 | 38 | 9.7 | 246 | 400 | 1780 | 1.00 | 25.4 | .31 | 7.9 | .010 | .25 | MTRTH | 50 | 250 |
| MRT2H-L4 | 2.0 | 51 | 11.3 | 287 | 400 | 1780 | 1.00 | 25.4 | .31 | 7.9 | .010 | .25 | | 50 | 250 |
| MRT4H-L4 | 4.0 | 102 | 17.6 | 447 | 400 | 1780 | 1.00 | 25.4 | .31 | 7.9 | .010 | .25 | | 50 | 250 |
| MRT6H-L4 | 6.0 | 152 | 23.8 | 604 | 400 | 1780 | 1.00 | 25.4 | .31 | 7.9 | .010 | .25 | | 50 | 250 |
| AISI 316 Stainless Steel – For Superior Corrosion Resistance | | | | | | | | | | | | | | | |
| Standard Cross Section | | | | | | | | | | | | | | | |
| MRT1S-C6 | 1.0 | 25 | 8.1 | 205 | 180 | 800 | .75 | 19.1 | .18 | 4.4 | .010 | .25 | MTRTLS | 100 | 500 |
| MRT2S-C6 | 2.0 | 51 | 11.3 | 287 | 180 | 800 | .75 | 19.1 | .18 | 4.4 | .010 | .25 | | 100 | 500 |
| MRT4S-C6 | 4.0 | 102 | 17.6 | 447 | 180 | 800 | .75 | 19.1 | .18 | 4.4 | .010 | .25 | | 100 | 500 |
| MRT6S-C6 | 6.0 | 152 | 23.8 | 604 | 180 | 800 | .75 | 19.1 | .18 | 4.4 | .010 | .25 | | 100 | 500 |
| Light-Heavy Cross Section | | | | | | | | | | | | | | | |
| MRT1.5LH-L6 | 1.5 | 38 | 9.7 | 246 | 225 | 1000 | 1.00 | 25.4 | .25 | 6.4 | .010 | .25 | MTRTLS | 50 | 250 |
| MRT2LH-L6 | 2.0 | 51 | 11.3 | 287 | 225 | 1000 | 1.00 | 25.4 | .25 | 6.4 | .010 | .25 | | 50 | 250 |
| MRT4LH-L6 | 4.0 | 102 | 17.6 | 447 | 225 | 1000 | 1.00 | 25.4 | .25 | 6.4 | .010 | .25 | | 50 | 250 |
| MRT6LH-L6 | 6.0 | 152 | 23.8 | 604 | 225 | 1000 | 1.00 | 25.4 | .25 | 6.4 | .010 | .25 | | 50 | 250 |
| Heavy Cross Section | | | | | | | | | | | | | | | |
| MRT1.5H-L6 | 1.5 | 38 | 9.7 | 246 | 400 | 1780 | 1.00 | 25.4 | .31 | 7.9 | .010 | .25 | MTRTH | 50 | 250 |
| MRT2H-L6 | 2.0 | 51 | 11.3 | 287 | 400 | 1780 | 1.00 | 25.4 | .31 | 7.9 | .010 | .25 | | 50 | 250 |
| MRT4H-L6 | 4.0 | 102 | 17.6 | 447 | 400 | 1780 | 1.00 | 25.4 | .31 | 7.9 | .010 | .25 | | 50 | 250 |
| MRT6H-L6 | 6.0 | 152 | 23.8 | 604 | 400 | 1780 | 1.00 | 25.4 | .31 | 7.9 | .010 | .25 | | 50 | 250 |

*Note: MRT ties for use with MTRT tools only.

Part Number System for PAN-STEEL® 360° Radial Seal Retained Tension Ties – MRS Series

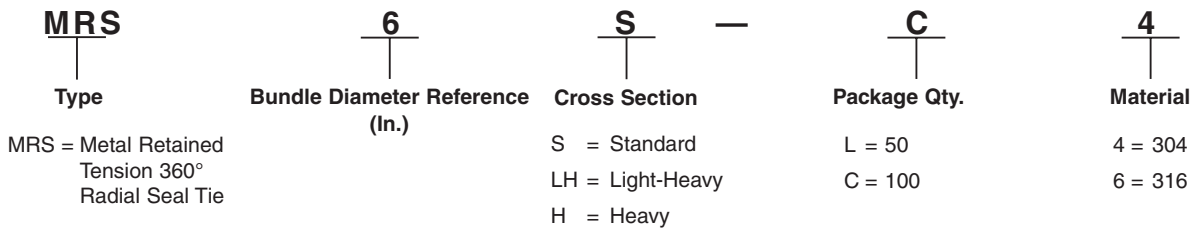

PAN-STEEL® 360° Radial Seal Retained Tension Ties – MRS Series



- 360° radial seal eliminates gaps under the head of the tie to provide a completely sealed installation
- Self-locking cable tie design locks into place at any length along the tie body, unlike fixed diameter band clamps
- Available in AISI 304 stainless steel for general-purpose applications
- Available in AISI 316 stainless steel for the most corrosive environments



| Part Number | Max. Bundle Diameter | | Length | | Min. Loop Tensile Strength | | Min. Bundle Diameter | | Width | | Thickness | | Tool* | Std. Pkg. Qty. | Std. Ctn. Qty. |
|---|----------------------|-----|--------|-----|----------------------------|------|----------------------|------|-------|-----|-----------|-----|--------|----------------|----------------|
| | In. | mm | In. | mm | Lbs. | N | In. | mm | In. | mm | In. | mm | | | |
| AISI 304 Stainless Steel – For General Purpose | | | | | | | | | | | | | | | |
| MRS1S-C4 | 1.0 | 25 | 8.1 | 205 | 180 | 800 | .75 | 19.1 | .18 | 4.4 | .010 | .25 | MTRTLS | 100 | 500 |
| MRS2S-C4 | 2.0 | 51 | 11.3 | 287 | 180 | 800 | .75 | 19.1 | .18 | 4.4 | .010 | .25 | | 100 | 500 |
| MRS4S-C4 | 4.0 | 102 | 17.6 | 447 | 180 | 800 | .75 | 19.1 | .18 | 4.4 | .010 | .25 | | 100 | 500 |
| MRS6S-C4 | 6.0 | 152 | 23.8 | 604 | 180 | 800 | .75 | 19.1 | .18 | 4.4 | .010 | .25 | | 100 | 500 |
| Light-Heavy Cross Section | | | | | | | | | | | | | | | |
| MRS1.5LH-L4 | 1.5 | 38 | 9.7 | 246 | 225 | 1000 | 1.00 | 25.4 | .25 | 6.4 | .010 | .25 | MTRTLS | 50 | 250 |
| MRS2LH-L4 | 2.0 | 51 | 11.3 | 287 | 225 | 1000 | 1.00 | 25.4 | .25 | 6.4 | .010 | .25 | | 50 | 250 |
| MRS4LH-L4 | 4.0 | 102 | 17.6 | 447 | 225 | 1000 | 1.00 | 25.4 | .25 | 6.4 | .010 | .25 | | 50 | 250 |
| MRS6LH-L4 | 6.0 | 152 | 23.8 | 604 | 225 | 1000 | 1.00 | 25.4 | .25 | 6.4 | .010 | .25 | | 50 | 250 |
| Heavy Cross Section | | | | | | | | | | | | | | | |
| MRS1.5H-L4 | 1.5 | 38 | 9.7 | 246 | 400 | 1780 | 1.00 | 25.4 | .31 | 7.9 | .010 | .25 | MTRTH | 50 | 250 |
| MRS2H-L4 | 2.0 | 51 | 11.3 | 287 | 400 | 1780 | 1.00 | 25.4 | .31 | 7.9 | .010 | .25 | | 50 | 250 |
| MRS4H-L4 | 4.0 | 102 | 17.6 | 447 | 400 | 1780 | 1.00 | 25.4 | .31 | 7.9 | .010 | .25 | | 50 | 250 |
| MRS6H-L4 | 6.0 | 152 | 23.8 | 604 | 400 | 1780 | 1.00 | 25.4 | .31 | 7.9 | .010 | .25 | | 50 | 250 |
| AISI 316 Stainless Steel – For Superior Corrosion Resistance | | | | | | | | | | | | | | | |
| Standard Cross Section | | | | | | | | | | | | | | | |
| MRS1S-C6 | 1.0 | 25 | 8.1 | 205 | 180 | 800 | .75 | 19.1 | .18 | 4.4 | .010 | .25 | MTRTLS | 100 | 500 |
| MRS2S-C6 | 2.0 | 51 | 11.3 | 287 | 180 | 800 | .75 | 19.1 | .18 | 4.4 | .010 | .25 | | 100 | 500 |
| MRS4S-C6 | 4.0 | 102 | 17.6 | 447 | 180 | 800 | .75 | 19.1 | .18 | 4.4 | .010 | .25 | | 100 | 500 |
| MRS6S-C6 | 6.0 | 152 | 23.8 | 604 | 180 | 800 | .75 | 19.1 | .18 | 4.4 | .010 | .25 | | 100 | 500 |
| Light-Heavy Cross Section | | | | | | | | | | | | | | | |
| MRS1.5LH-L6 | 1.5 | 38 | 9.7 | 246 | 225 | 1000 | 1.00 | 25.4 | .25 | 6.4 | .010 | .25 | MTRTLS | 50 | 250 |
| MRS2LH-L6 | 2.0 | 51 | 11.3 | 287 | 225 | 1000 | 1.00 | 25.4 | .25 | 6.4 | .010 | .25 | | 50 | 250 |
| MRS4LH-L6 | 4.0 | 102 | 17.6 | 447 | 225 | 1000 | 1.00 | 25.4 | .25 | 6.4 | .010 | .25 | | 50 | 250 |
| MRS6LH-L6 | 6.0 | 152 | 23.8 | 604 | 225 | 1000 | 1.00 | 25.4 | .25 | 6.4 | .010 | .25 | | 50 | 250 |
| Heavy Cross Section | | | | | | | | | | | | | | | |
| MRS1.5H-L6 | 1.5 | 38 | 9.7 | 246 | 400 | 1780 | 1.00 | 25.4 | .31 | 7.9 | .010 | .25 | MTRTH | 50 | 250 |
| MRS2H-L6 | 2.0 | 51 | 11.3 | 287 | 400 | 1780 | 1.00 | 25.4 | .31 | 7.9 | .010 | .25 | | 50 | 250 |
| MRS4H-L6 | 4.0 | 102 | 17.6 | 447 | 400 | 1780 | 1.00 | 25.4 | .31 | 7.9 | .010 | .25 | | 50 | 250 |
| MRS6H-L6 | 6.0 | 152 | 23.8 | 604 | 400 | 1780 | 1.00 | 25.4 | .31 | 7.9 | .010 | .25 | | 50 | 250 |

*Note: MRS ties for use with MTRT tools only.

A. System Overview

B1. Cable Ties

B2. Cable Accessories

B3. Stainless Steel Ties

C1. Wiring Duct

C2. Surface Raceway

C3. Abrasion Protection

C4. Cable Management

D1. Terminals

D2. Power Connectors

D3. Grounding Connectors

E1. Labeling Systems

E2. Labels

E3. Pre-Printed & Write-On Markers

E4. Permanent Identification

E5. Lockout/Tagout & Safety Solutions

F. Index



Retained Tension Installation Tools

- Adjustable detent mechanism provides user pre-set controlled tension for repeatable installations and maximum reliability
- Smooth cable tie cut-off eliminates burrs or sharp edges after installation to deliver added bundle protection and job site safety

- Tie tensioning mechanism provides improved durability compared to conventional gripper style tools
- Change over kits available to allow for installation of all tie cross sections with one tool

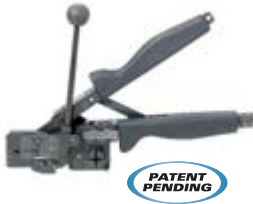

| Part Number | Part Description | Std. Pkg. Qty. |
|----------------|---|----------------|
| MTRTH | Retained tension installation tool for use with <i>PAN-STEEL</i> ® heavy cross section MRT and MRS style ties. | 1 |
| MTRTLS | Retained tension installation tool for use with <i>PAN-STEEL</i> ® light-heavy and standard cross section MRT and MRS style ties. | 1 |
| KMTRTH | Change over kits allow for installation of heavy cross section MRT and MRS style ties in MTRTLS tools. | 1 |
| KMTRTLS | Change over kits allow for installation of light-heavy and standard cross section MRT and MRS style ties in MTRTH tools. | 1 |

Note: For high volume applications, contact *PANDUIT* Customer Service.

MRT/MRS Installation Steps



1) Place retained tension tie around material, insert tail of tie through metal locking head. Pull tie tight by hand.



2) Insert tail of retained tension tie into nose of tool tensioning slot.



3) Squeeze tension handle until preset tension is reached.



4) Grasp tension handle lever and move forward, setting ball and cutting tie.



5) Remove tool, installation complete. Provides safe, flush cut-off.

Features and Benefits – PAN-STEEL® Strapping System

The PANDUIT® PAN-STEEL® Stainless Steel Strapping is the ultimate solution for strapping applications. The buckle design and tension controlled installation tool offer a quick and safe installation for all harsh environments. Available in three widths 3/8" (9.5mm), 1/2" (12.7mm) and 5/8" (15.9mm) in base 304 or 316 stainless steel with a temperature range of -112°F (-80°C) to 1000°F (538°C).

Unique Locking Method*

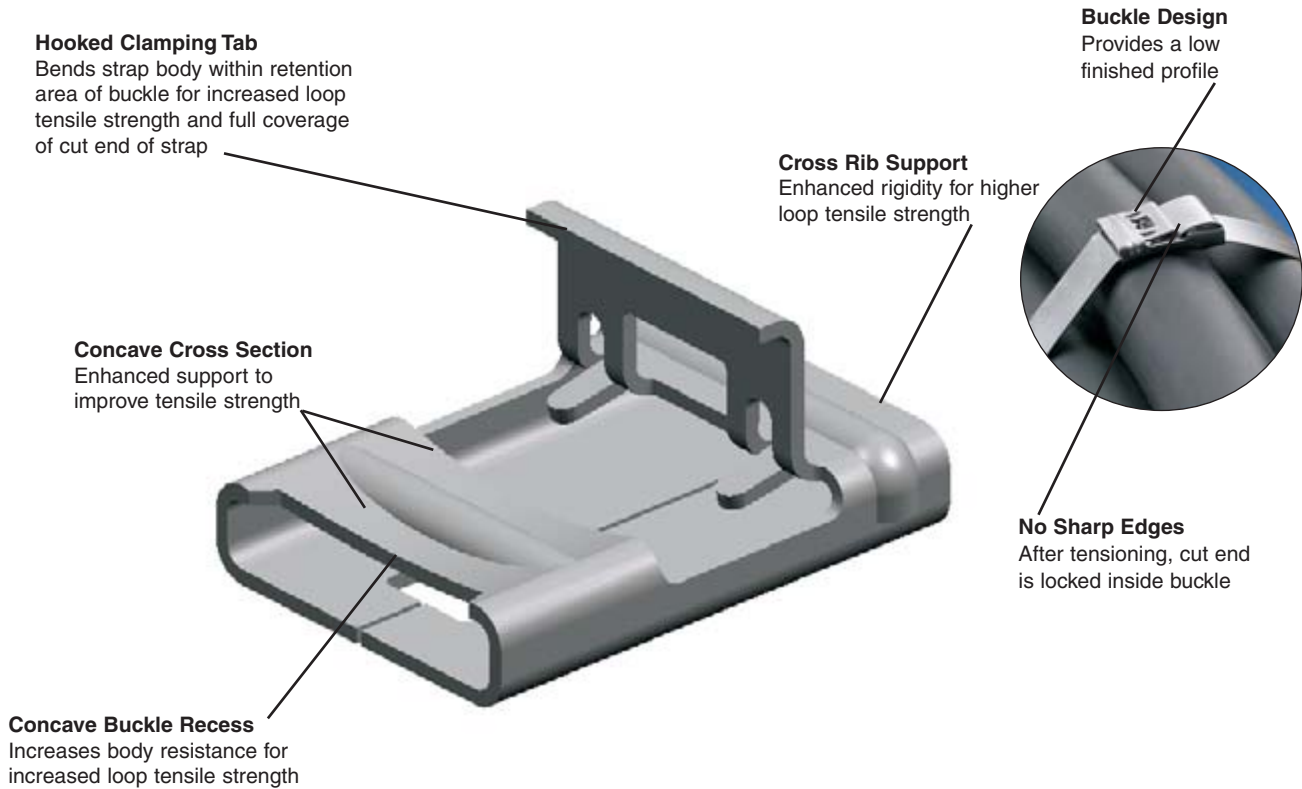

*Patents applied for



Hand operated installation tool used with all widths of PANDUIT® PAN-STEEL® Strapping. Tensions, cuts strapping, and secures the buckle tab. Easy to operate. See page B3.26.



Custom length strapping available for applications that require various bundle diameters, to provide job safety and versatility with minimum inventory. See page B3.25.

A.
System
Overview

B1.
Cable Ties

B2.
Cable
Accessories

B3.
Stainless
Steel Ties

C1.
Wiring
Duct

C2.
Surface
Raceway

C3.
Abrasion
Protection

C4.
Cable
Management

D1.
Terminals

D2.
Power
Connectors

D3.
Grounding
Connectors

E1.
Labeling
Systems

E2.
Labels

E3.
Pre-Printed
& Write-On
Markers

E4.
Permanent
Identification

E5.
Lockout/
Tagout
& Safety
Solutions

F.
Index

A. System Overview

The PANDUIT Method Reduces Installation Time

B1. Cable Ties

B2. Cable Accessories

B3. Stainless Steel Ties



1) Place strap around the material, insert tail of strap through buckle. Pull strapping tight and bend up to hold in place. Insert tail of strapping into tool nose section. Squeeze handle to tension.



2) Once proper tension is reached, maintain tension and raise tool 90° – 120° over buckle and pull down on cutter lever, cutting strap.



3) Remove tool, press cut end down and toward retaining tab.

C1. Wiring Duct

C2. Surface Raceway

C3. Abrasion Protection

C4. Cable Management



4) Using the closure lever on the handle of the tool, bend retaining tab down and over cut end. Provides finished, safe, low profile closure.

D1. Terminals

D2. Power Connectors

D3. Grounding Connectors

E1. Labeling Systems

Part Number System for Discrete Length Strapping

| | | | | | | | |
|--|-----------------------|----------|----------------------------------|-----------|-------------|-----------------------|--------------------------|
| MS | 4 | W | 38 | T | 15 | L | 4 |
| Type | Bundle Diameter (In.) | Width | Inches | Thickness | 15 = 0.015" | Standard Package Size | Material |
| MS = Metal Strap C = Coated Blank = Uncoated | | | 38 = 3/8 50 = 1/2 63 = 5/8 | | | L = 50 Pcs. | 4 = 304 SS 6 = 316 SS |

Part Number System for Coil Strapping

| | | | | | | |
|--|----------|----------------------------------|-----------|-------------|------------------------|--------------------------|
| MS | W | 50 | T | 15 | CR | 6 |
| Type | Width | Inches | Thickness | 15 = 0.015" | Standard Package Size | Material |
| MS = Metal Strap C = Coated Blank = Uncoated | | 38 = 3/8 50 = 1/2 63 = 5/8 | | | CR = 100' QR = 825' | 4 = 304 SS 6 = 316 SS |

Part Number System for Strapping Buckles

| | | | | | |
|------------------|------------|----------|----------------------------------|-----------------------|--------------------------|
| MS | B | W | 63 | C | 4 |
| Type | B = Buckle | Width | Inches | Standard Package Size | Material |
| MS = Metal Strap | | | 38 = 3/8 50 = 1/2 63 = 5/8 | C = 100 Pcs. | 4 = 304 SS 6 = 316 SS |

PAN-STEEL® Strapping – MS Series

- Fold over design provides high-retained tension in mechanical fastening and cable bundling applications
- After tensioning, cut end is locked inside low profile buckle – no sharp edges
- Can be used in a wide range of indoor, outdoor, and underground (including direct burial) applications
- Smooth surfaces and rounded edges assures cable protection and worker safety
- Available in AISI 304 stainless steel for general-purpose applications
- Available in AISI 316 stainless steel for the most corrosive environments



| Part Number | Max. Bundle Diameter | | Length* | | Min. Loop Tensile Strength** | | Min. Bundle Diameter | | Width | | Thickness | | Recommended Installation Tool*** | Std. Pkg. Qty. | Std. Ctn. Qty. | |
|---------------------------------|----------------------|-----|---------|-----|------------------------------|------|----------------------|------|-------|------|-----------|-----|----------------------------------|----------------|----------------|-----|
| | In. | mm | In. | mm | Lbs. | N | In. | mm | In. | mm | In. | mm | | | | |
| AISI 304 Stainless Steel | | | | | | | | | | | | | | | | |
| MS2W38T15-L4 | 2.0 | 51 | 11.8 | 300 | 500 | 2225 | 1.0 | 25.4 | .38 | 9.5 | .015 | .38 | BT1HT | 50 | 250 | |
| MS4W38T15-L4 | 4.0 | 102 | 18.0 | 457 | 500 | 2225 | 1.0 | 25.4 | .38 | 9.5 | .015 | .38 | | 50 | 250 | |
| MS6W38T15-L4 | 6.0 | 152 | 24.4 | 620 | 500 | 2225 | 1.0 | 25.4 | .38 | 9.5 | .015 | .38 | | 50 | 250 | |
| MS8W38T15-L4 | 8.0 | 203 | 30.7 | 780 | 500 | 2225 | 1.0 | 25.4 | .38 | 9.5 | .015 | .38 | | 50 | 250 | |
| MS10W38T15-L4 | 10.0 | 254 | 37.0 | 940 | 500 | 2225 | 1.0 | 25.4 | .38 | 9.5 | .015 | .38 | | 50 | 250 | |
| MS4W50T15-L4 | 4.0 | 102 | 18.0 | 457 | 700 | 3115 | 1.0 | 25.4 | .50 | 12.7 | .015 | .38 | | 50 | 250 | |
| MS6W50T15-L4 | 6.0 | 152 | 24.4 | 620 | 700 | 3115 | 1.0 | 25.4 | .50 | 12.7 | .015 | .38 | | 50 | 250 | |
| MS8W50T15-L4 | 8.0 | 203 | 30.7 | 780 | 700 | 3115 | 1.0 | 25.4 | .50 | 12.7 | .015 | .38 | | 50 | 250 | |
| MS10W50T15-L4 | 10.0 | 254 | 37.0 | 940 | 700 | 3115 | 1.0 | 25.4 | .50 | 12.7 | .015 | .38 | | 50 | 250 | |
| MS4W63T15-L4 | 4.0 | 102 | 18.0 | 457 | 800 | 3560 | 1.0 | 25.4 | .63 | 15.9 | .015 | .38 | | 50 | 250 | |
| MS6W63T15-L4 | 6.0 | 152 | 24.4 | 620 | 800 | 3560 | 1.0 | 25.4 | .63 | 15.9 | .015 | .38 | | 50 | 250 | |
| MS8W63T15-L4 | 8.0 | 203 | 30.7 | 780 | 800 | 3560 | 1.0 | 25.4 | .63 | 15.9 | .015 | .38 | | 50 | 250 | |
| MS10W63T15-L4 | 10.0 | 254 | 37.0 | 940 | 800 | 3560 | 1.0 | 25.4 | .63 | 15.9 | .015 | .38 | | 50 | 250 | |
| AISI 316 Stainless Steel | | | | | | | | | | | | | | | | |
| MS2W38T15-L6 | 2.0 | 51 | 11.8 | 300 | 500 | 2225 | 1.0 | 25.4 | .38 | 9.5 | .015 | .38 | | BT1HT | 50 | 250 |
| MS4W38T15-L6 | 4.0 | 102 | 18.0 | 457 | 500 | 2225 | 1.0 | 25.4 | .38 | 9.5 | .015 | .38 | 50 | | 250 | |
| MS6W38T15-L6 | 6.0 | 152 | 24.4 | 620 | 500 | 2225 | 1.0 | 25.4 | .38 | 9.5 | .015 | .38 | 50 | | 250 | |
| MS8W38T15-L6 | 8.0 | 203 | 30.7 | 780 | 500 | 2225 | 1.0 | 25.4 | .38 | 9.5 | .015 | .38 | 50 | | 250 | |
| MS10W38T15-L6 | 10.0 | 254 | 37.0 | 940 | 500 | 2225 | 1.0 | 25.4 | .38 | 9.5 | .015 | .38 | 50 | | 250 | |
| MS4W50T15-L6 | 4.0 | 102 | 18.0 | 457 | 700 | 3115 | 1.0 | 25.4 | .50 | 12.7 | .015 | .38 | 50 | | 250 | |
| MS6W50T15-L6 | 6.0 | 152 | 24.4 | 620 | 700 | 3115 | 1.0 | 25.4 | .50 | 12.7 | .015 | .38 | 50 | | 250 | |
| MS8W50T15-L6 | 8.0 | 203 | 30.7 | 780 | 700 | 3115 | 1.0 | 25.4 | .50 | 12.7 | .015 | .38 | 50 | | 250 | |
| MS10W50T15-L6 | 10.0 | 254 | 37.0 | 940 | 700 | 3115 | 1.0 | 25.4 | .50 | 12.7 | .015 | .38 | 50 | | 250 | |
| MS4W63T15-L6 | 4.0 | 102 | 18.0 | 457 | 800 | 3560 | 1.0 | 25.4 | .63 | 15.9 | .015 | .38 | 50 | | 250 | |
| MS6W63T15-L6 | 6.0 | 152 | 24.4 | 620 | 800 | 3560 | 1.0 | 25.4 | .63 | 15.9 | .015 | .38 | 50 | | 250 | |
| MS8W63T15-L6 | 8.0 | 203 | 30.7 | 780 | 800 | 3560 | 1.0 | 25.4 | .63 | 15.9 | .015 | .38 | 50 | | 250 | |
| MS10W63T15-L6 | 10.0 | 254 | 37.0 | 940 | 800 | 3560 | 1.0 | 25.4 | .63 | 15.9 | .015 | .38 | 50 | | 250 | |

*Other lengths available, contact PANDUIT Customer Service.

**Per SAE Standard AS23190/3 (formerly MIL). For additional details, refer to page B3.32.

***For information on installation tool, refer to page B3.26.

A.
System
Overview

B1.
Cable Ties

B2.
Cable
Accessories

B3.
Stainless
Steel Ties

C1.
Wiring
Duct

C2.
Surface
Raceway

C3.
Abrasion
Protection

C4.
Cable
Management

D1.
Terminals

D2.
Power
Connectors

D3.
Grounding
Connectors

E1.
Labeling
Systems

E2.
Labels

E3.
Pre-Printed
& Write-On
Markers

E4.
Permanent
Identification

E5.
Lockout/
Tagout/
& Safety
Solutions

F.
Index

A.
System
Overview

PAN-STEEL® Nylon 11 Coated Strapping – MSC Series

B1.
Cable Ties

- Fold over design provides high-retained tension in mechanical fastening and cable bundling applications
- After tensioning, cut end is locked inside low profile buckle – no sharp edges
- AISI 316 stainless steel for the most corrosive environments
- Available in .38 inch (9.5mm), .50 inch (12.7mm), .63 inch (15.9mm) cross sections
- UV resistant, low smoke, halogen-free material
- Temperature tolerance -40°F (-40°C) to 285°F (140°C)

B2.
Cable
Accessories

B3.
Stainless
Steel Ties



C1.
Wiring
Duct

C2.
Surface
Raceway

C3.
Abrasion
Protection

C4.
Cable
Management

D1.
Terminals

D2.
Power
Connectors

D3.
Grounding
Connectors

E1.
Labeling
Systems

E2.
Labels

E3.
Pre-Printed
& Write-On
Markers

E4.
Permanent
Identification

E5.
Lockout/
Tagout/
& Safety
Solutions

F.
Index

| Part Number | Max. Bundle Diameter | | Length* | | Min. Loop Tensile Strength** | | Min. Bundle Diameter | | Width | | Thickness^ | | Recommended Installation Tool*** | Std. Pkg. Qty. | Std. Ctn. Qty. |
|-----------------------|----------------------|-----|---------|-----|------------------------------|------|----------------------|------|-------|------|------------|-----|----------------------------------|----------------|----------------|
| | In. | mm | In. | mm | Lbs. | N | In. | mm | In. | mm | In. | mm | | | |
| MSC2W38T15-L6 | 2.0 | 51 | 11.8 | 300 | 300 | 1335 | 1.0 | 25.4 | .38 | 9.5 | .015 | .38 | BT1HT | 50 | 250 |
| MSC4W38T15-L6 | 4.0 | 102 | 18.0 | 457 | 300 | 1335 | 1.0 | 25.4 | .38 | 9.5 | .015 | .38 | | 50 | 250 |
| MSC6W38T15-L6 | 6.0 | 152 | 24.4 | 620 | 300 | 1335 | 1.0 | 25.4 | .38 | 9.5 | .015 | .38 | | 50 | 250 |
| MSC8W38T15-L6 | 8.0 | 203 | 30.7 | 780 | 300 | 1335 | 1.0 | 25.4 | .38 | 9.5 | .015 | .38 | | 50 | 250 |
| MSC10W38T15-L6 | 10.0 | 254 | 37.0 | 940 | 300 | 1335 | 1.0 | 25.4 | .38 | 9.5 | .015 | .38 | | 50 | 250 |
| MSC4W50T15-L6 | 4.0 | 102 | 18.0 | 457 | 500 | 2225 | 1.0 | 25.4 | .50 | 12.7 | .015 | .38 | | 50 | 250 |
| MSC6W50T15-L6 | 6.0 | 152 | 24.4 | 620 | 500 | 2225 | 1.0 | 25.4 | .50 | 12.7 | .015 | .38 | | 50 | 250 |
| MSC8W50T15-L6 | 8.0 | 203 | 30.7 | 780 | 500 | 2225 | 1.0 | 25.4 | .50 | 12.7 | .015 | .38 | | 50 | 250 |
| MSC10W50T15-L6 | 10.0 | 254 | 37.0 | 940 | 500 | 2225 | 1.0 | 25.4 | .50 | 12.7 | .015 | .38 | | 50 | 250 |
| MSC4W63T15-L6 | 4.0 | 102 | 18.0 | 457 | 800 | 3560 | 1.0 | 25.4 | .63 | 15.9 | .015 | .38 | | 50 | 250 |
| MSC6W63T15-L6 | 6.0 | 152 | 24.4 | 620 | 800 | 3560 | 1.0 | 25.4 | .63 | 15.9 | .015 | .38 | | 50 | 250 |
| MSC8W63T15-L6 | 8.0 | 203 | 30.7 | 780 | 800 | 3560 | 1.0 | 25.4 | .63 | 15.9 | .015 | .38 | | 50 | 250 |
| MSC10W63T15-L6 | 10.0 | 254 | 37.0 | 940 | 800 | 3560 | 1.0 | 25.4 | .63 | 15.9 | .015 | .38 | | 50 | 250 |

*Other lengths available, contact PANDUIT Customer Service.

**Per SAE Standard AS23190/3 (formerly MIL). For additional details, refer to page B3.32.

***For information on installation tools, refer to page B3.26.

^Base material less coating.

PAN-STEEL® Custom Length Strapping

- Fold over design provides high retained tension in mechanical fastening and cable bundling applications
- After tensioning, cut end is locked inside low profile buckle – no sharp edges
- For applications that require various bundle diameters
- Supplied in reels of 82.5 feet (25m) (coated) or 100 feet (30.5m) (uncoated)

- Provides job site versatility with minimum inventory
- Packaging speeds removal of steel and includes bundle diameter cut-off guide
- Available in AISI 304 stainless steel for general-purpose applications
- Available in AISI 316 stainless steel for the most corrosive environments



Nylon 11 coating (optional):

- Nylon 11 coating provides additional edge protection and prevents corrosion between dissimilar metals
- UV resistant, low smoke, halogen-free material
- Temperature tolerance -40°F (-40°C) to 285°F (140°C)
- AISI 316 stainless steel for the most corrosive environments

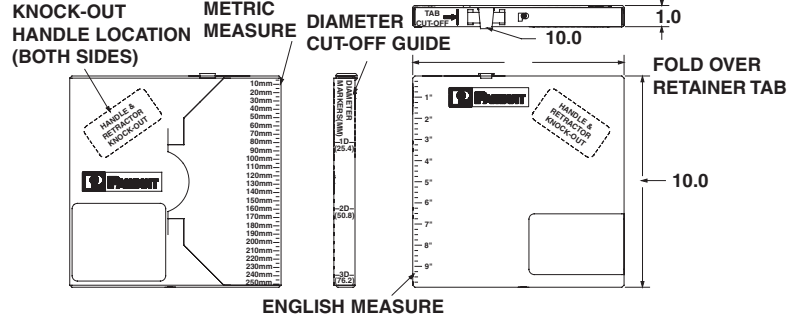

| Part Number | Length* | | Min. Loop Tensile Strength** | | Width | | Thickness^ | | Used with Buckle | Recommended Installation Tool*** | Std. Pkg. Qty.‡ |
|---|---------|------|------------------------------|------|-------|------|------------|-----|------------------|----------------------------------|-----------------|
| | Ft. | M | Lbs. | N | In. | mm | In. | mm | | | |
| 304 Stainless Steel | | | | | | | | | | | |
| MSW38T15-CR4 | 100 | 30.5 | 500 | 2225 | .38 | 9.5 | .015 | .38 | MSBW38-C4 | BT1HT | 1 |
| MSW50T15-CR4 | 100 | 30.5 | 700 | 3115 | .50 | 12.7 | .015 | .38 | MSBW50-C4 | | 1 |
| MSW63T15-CR4 | 100 | 30.5 | 800 | 3560 | .63 | 15.9 | .015 | .38 | MSBW63-C4 | | 1 |
| 316 Stainless Steel | | | | | | | | | | | |
| MSW38T15-CR6 | 100 | 30.5 | 500 | 2225 | .38 | 9.5 | .015 | .38 | MSBW38-C6 | BT1HT | 1 |
| MSW50T15-CR6 | 100 | 30.5 | 700 | 3115 | .50 | 12.7 | .015 | .38 | MSBW50-C6 | | 1 |
| MSW63T15-CR6 | 100 | 30.5 | 800 | 3560 | .63 | 15.9 | .015 | .38 | MSBW63-C6 | | 1 |
| Nylon Coated Custom Length Strapping | | | | | | | | | | | |
| MSCNW38T15-QR6 | 82.5 | 25 | 300 | 1335 | .38 | 9.5 | .015 | .38 | MSBW38-C6 | BT1HT | 1 |
| MSCNW50T15-QR6 | 82.5 | 25 | 700 | 3115 | .50 | 12.7 | .015 | .38 | MSBW50-C6 | | 1 |
| MSCNW63T15-QR6 | 82.5 | 25 | 800 | 3560 | .63 | 15.9 | .015 | .38 | MSBW63-C6 | | 1 |

*Other lengths available, contact PANDUIT Customer Service.
 **Per SAE Standard AS23190/3 (formerly MIL). For additional details, refer to page B3.32.
 ***For information on installation tools, refer to page B3.26.
 ^Base metal less coating.
 ‡Order in number of reels required.

To determine the proper amount of strapping required, use the following formula:

Calculate Diameter inches (mm) x 3.14 + 6 inches (152.4 mm)

PAN-STEEL® Buckles for Custom Length Strapping

- Buckle design provides a low finished profile
- After tensioning cut end is locked inside buckle – no sharp edges

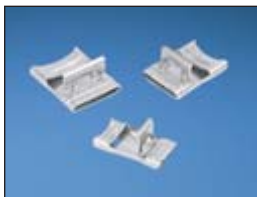

| Part Number | Material | Width | | Part Description | Std. Pkg. Qty. | Std. Ctn. Qty. |
|---------------------------------|----------|-------|------|---|----------------|----------------|
| | | In. | mm | | | |
| AISI 304 Stainless Steel | | | | | | |
| MSBW38-C4 | 304 | .38 | 9.5 | Individual low profile buckles used with custom length strapping. | 100 | 1000 |
| MSBW50-C4 | 304 | .50 | 12.7 | | 100 | 1000 |
| MSBW63-C4 | 304 | .63 | 15.9 | | 100 | 1000 |
| AISI 316 Stainless Steel | | | | | | |
| MSBW38-C6 | 316 | .38 | 9.5 | Individual low profile buckles used with custom length strapping. | 100 | 1000 |
| MSBW50-C6 | 316 | .50 | 12.7 | | 100 | 1000 |
| MSBW63-C6 | 316 | .63 | 15.9 | | 100 | 1000 |

A.
System
Overview

BT1HT Hand Operated Installation Tool for Strapping

B1.
Cable Ties

- Strap side entry
- One or two hand tensioning with multi-position rear handle
- Adjustable tension control

- Lever actuated cut-off
- Easy removal of excess strap
- Installs all three sizes: .38 inch (9.5mm), .50 inch (12.7mm), and .63 inch (15.9mm)



B2.
Cable
Accessories

B3.
Stainless
Steel Ties

| Part Number | Part Description | Std. Pkg. Qty. |
|--------------|---|----------------|
| BT1HT | Used for all widths of <i>PANDUIT® PAN-STEEL®</i> Strapping. Tensions, cuts strapping, and secures the buckle tab. Ratchet-type tool provides mechanical advantage for tensioning. Easy to operate. | 1 |

C1.
Wiring
Duct

C2.
Surface
Raceway

C3.
Abrasion
Protection

PCS Cushion Sleeve

C4.
Cable
Management

- Black neoprene sleeving used with *PAN-STEEL®* Stainless Steel Ties, custom length banding, and MS strap
- Used on applications requiring improved gripping on non-resilient objects
- Can be used indoors or outdoors (excellent ultraviolet resistance, good resistance to petroleum, and many chemicals)

- Isolation between dissimilar metals allows the ties and straps to be used with aluminum cable tray
- Provides full separation between the ties and the bundle
- Operating temperature range -40°F (-40°C) to 200°F (93°C)

D1.
Terminals

D2.
Power
Connectors



D3.
Grounding
Connectors

| Part Number | Used with <i>PAN-STEEL®</i> Ties/Strapping | Width | | Length | | Std. Pkg. Qty‡ |
|--------------------|--|-------|------|--------|------|----------------|
| | | In. | mm | Ft. | m | |
| PCSS-B-CR | MLT/S | .33 | 8.4 | 100 | 30.5 | 1 |
| PCSH-B-CR | MLT/LH/H | .47 | 11.9 | 100 | 30.5 | 1 |
| PCSSH-B-CR* | MLT/EH/SH and MS Straps | .91 | 23.1 | 100 | 30.5 | 1 |

*Meets MIL-R-6855

‡Order in number of reels required.

Bulk Pkg. -CR = 100' (30.5m) reel.

E1.
Labeling
Systems



E2.
Labels

E3.
Pre-Printed
& Write-On
Markers

E4.
Permanent
Identification

E5.
Lockout/
Tagout
& Safety
Solutions

F.
Index

Stainless Steel Tie Mounts

- Low profile
- One hole mounting

- For use with standard, light-heavy, and heavy cross section *PAN-STEEL*® Ties as well as .38 inch (9.5mm) wide strapping
- 304 Stainless Steel

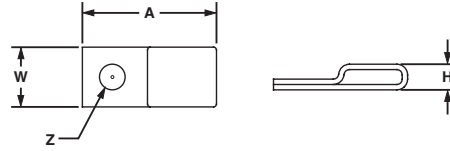

| Part Number | Used with <i>PAN-STEEL</i> ® Ties/Strapping | Mounting Method* | Length A | | Width W | | Height H | | Hole Diameter Z | | Std. Pkg. Qty. | Std. Ctn. Qty. |
|------------------|---|------------------|----------|------|---------|------|----------|-----|-----------------|-----|----------------|----------------|
| | | | In. | mm | In. | mm | In. | mm | In. | mm | | |
| MTM1H-C | MLTS/LH/H, MLTC/H, MLTFC/S/LH/H or MSW38 | #8 (4mm) screw | .90 | 22.6 | .40 | 10.2 | .17 | 4.4 | .17 | 4.4 | 100 | 1000 |
| MTM1H10-C | | #10 (5mm) screw | .90 | 22.6 | .40 | 10.2 | .17 | 4.4 | .21 | 5.4 | 100 | 1000 |
| MTM1H25-C | | 1/4" (6mm) screw | .90 | 22.6 | .40 | 10.2 | .17 | 4.4 | .28 | 7.1 | 100 | 1000 |

*Stainless steel screws are recommended for fastening to avoid corrosion problems associated with dissimilar metals.

Stainless Steel Push Mount

- No tapping required
- Used where only one side of the panel is accessible
- Nothing to assemble

- For use with standard, light-heavy, and heavy cross section *PAN-STEEL*® Ties
- 304 Stainless Steel



PATENT PENDING

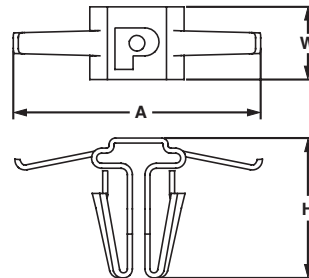

| Part Number | Used with <i>PAN-STEEL</i> ® Ties/Strapping | Mounting Method | Length A | | Width W | | Height H | | Panel Thickness | | Std. Pkg. Qty. | Std. Ctn. Qty. |
|-------------------|---|--|----------|------|---------|-----|----------|------|-----------------|----------|----------------|----------------|
| | | | In. | mm | In. | mm | In. | mm | In. | mm | | |
| MPWM-H56-Q | MLTS/LH/H, MLTC/H or MLTFC/S/LH/H | Inserted into pre-drilled hole 5/16" (8mm) | .98 | 24.7 | .29 | 7.3 | .56 | 14.2 | .03 – .09 | .8 – 2.4 | 25 | 250 |

A. System Overview

B1. Cable Ties

B2. Cable Accessories

B3. Stainless Steel Ties

C1. Wiring Duct

C2. Surface Raceway

C3. Abrasion Protection

C4. Cable Management

D1. Terminals

D2. Power Connectors

D3. Grounding Connectors

E1. Labeling Systems

E2. Labels

E3. Pre-Printed & Write-On Markers

E4. Permanent Identification

E5. Lockout/Tagout & Safety Solutions

F. Index

A. System Overview

Stainless Steel Push Button Mount

B1. Cable Ties

- Low profile
- No tapping required
- Designed for use only where both sides of the panel are accessible

- For use with standard cross section *PAN-STEEL*® Ties
- 304 Stainless Steel

B2. Cable Accessories

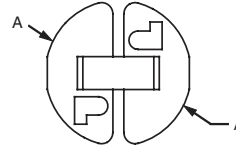
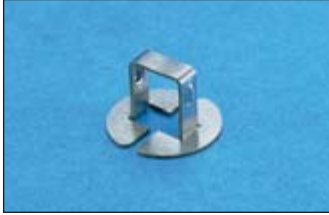

B3. Stainless Steel Ties

C1. Wiring Duct

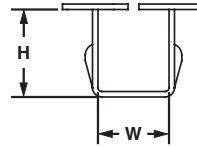

C2. Surface Raceway

C3. Abrasion Protection

| Part Number | Used with <i>PAN-STEEL</i> ® Ties/Strapping | Mounting Method | Diameter A | | Width W | | Height H | | Panel Thickness | | Std. Pkg. Qty. | Std. Ctn. Qty. |
|------------------|---|---|------------|------|---------|-----|----------|-----|-----------------|----------|----------------|----------------|
| | | | In. | mm | In. | mm | In. | mm | In. | mm | | |
| MBM-H25-Q | MLT/S or MLTFC/S | Inserted into pre-drilled hole .25" (6.4mm) | .40 | 10.0 | .20 | 5.0 | .26 | 6.5 | .03 – .12 | .8 – 3.0 | 25 | 250 |

C4. Cable Management

D1. Terminals

Stainless Steel 2-Way Tie Mount

D2. Power Connectors

- Allows stainless steel cable ties to be inserted from either of two sides
- Low profile
- Single hole center mounting for maximum holding and stability
- Maximum screw head height .09 inches (2.3mm)

- For use with standard, light-heavy, and heavy cross section *PAN-STEEL*® Ties
- 304 Stainless Steel

D3. Grounding Connectors

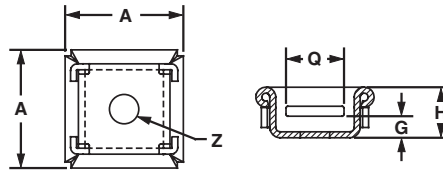

E1. Labeling Systems

E2. Labels

E3. Pre-Printed & Write-On Markers

| Part Number | Used with <i>PAN-STEEL</i> ® Ties/Strapping | Mounting Method* | Length A | | Height H | | Screw Head Height G | | Slot Width Q | | Hole Diameter Z | | Std. Pkg. Qty. | Std. Ctn. Qty. |
|----------------|---|------------------|----------|------|----------|-----|---------------------|-----|--------------|-----|-----------------|-----|----------------|----------------|
| | | | In. | mm | In. | mm | In. | mm | In. | mm | In. | mm | | |
| MTM2H-Q | MLTS/LH/H, MLTC/H or MLTFC/S/LH/H | #8 (4mm) screw | .71 | 18.0 | .30 | 8.0 | .09 | 2.3 | .35 | 9.0 | .17 | 4.5 | 25 | 250 |

E4. Permanent Identification

E5. Lockout/Tagout & Safety Solutions

F. Index

*Stainless steel screws are recommended for fastening to avoid corrosion problems associated with dissimilar metals.

Stainless Steel Bulkhead Mount

- Zero profile
- Mounts directly to surface
- Used where only one side of the panel is accessible

- Permanent, secure application
- Used with standard, light-heavy, and heavy cross section *PAN-STEEL®* Ties
- 304 Stainless Steel

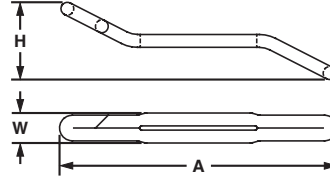

| Part Number | Used with <i>PAN-STEEL®</i> Ties/Strapping | Mounting Method | Length A | | Width W | | Height H | | Max. Panel Thickness | | Std. Pkg. Qty. | Std. Ctn. Qty. |
|-------------|--|--|----------|------|---------|-----|----------|------|----------------------|------|----------------|----------------|
| | | | In. | mm | In. | mm | In. | mm | In. | mm | | |
| MTMBH-Q | MLTS/LH/H/EH/SH, MLTC/H, or MLTFC/S/LH/H/EH/SH | Pre-drill hole size standard and light-heavy cross section MLT-S/LH .38" (9.5mm) – .50" (12.7mm). Heavy cross section MLT-H .50" (12.7mm) – .63" (15.9mm). | 1.92 | 48.5 | .21 | 5.3 | .54 | 13.7 | .50 | 12.7 | 25 | 250 |

To Install Bulkhead Mount:

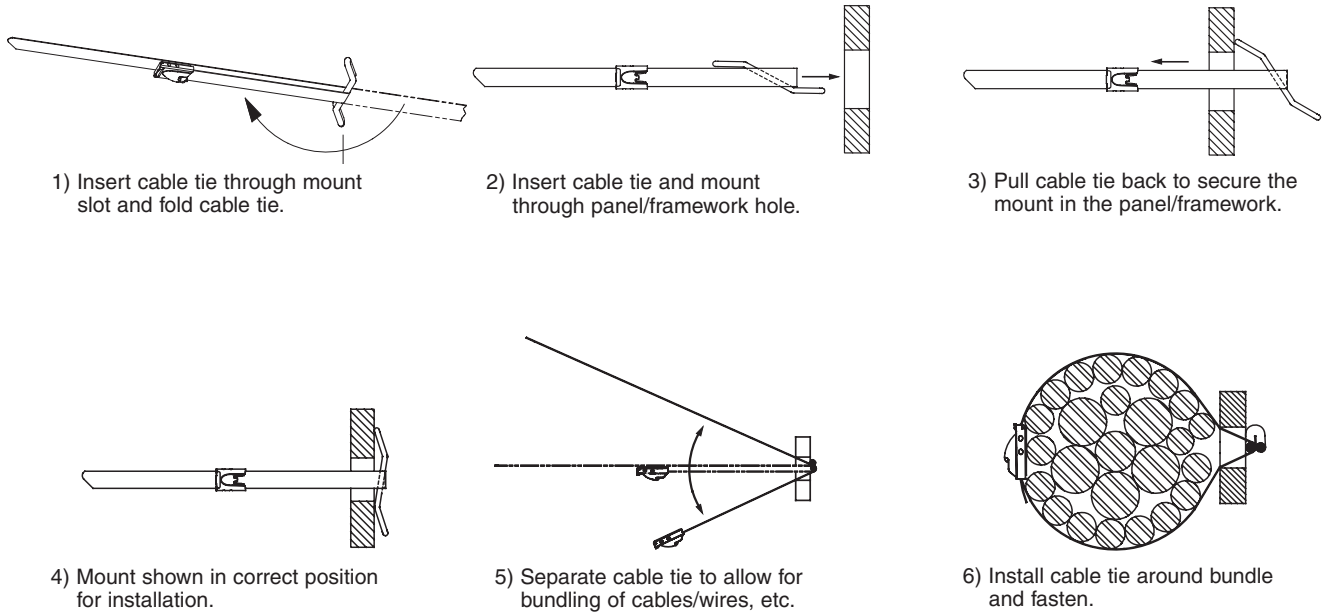

1) Insert cable tie through mount slot and fold cable tie.

2) Insert cable tie and mount through panel/framework hole.

3) Pull cable tie back to secure the mount in the panel/framework.

4) Mount shown in correct position for installation.

5) Separate cable tie to allow for bundling of cables/wires, etc.

6) Install cable tie around bundle and fasten.

A.
System
Overview

B1.
Cable Ties

B2.
Cable
Accessories

B3.
Stainless
Steel Ties

C1.
Wiring
Duct

C2.
Surface
Raceway

C3.
Abrasion
Protection

C4.
Cable
Management

D1.
Terminals

D2.
Power
Connectors

D3.
Grounding
Connectors

E1.
Labeling
Systems

E2.
Labels

E3.
Pre-Printed
& Write-On
Markers

E4.
Permanent
Identification

E5.
Lockout/
Tagout/
& Safety
Solutions

F.
Index

A. System Overview

Stainless Steel Technical Information Physical Characteristics of Stainless Steel and Aluminum

B1. Cable Ties

B2. Cable Accessories

B3. Stainless Steel Ties

| | PAN-STEEL® Stainless Steel Marker Plates, Tags, and Cable Ties | PAN-ALUM™ Aluminum Marker Plates and Cable Ties |
|--------------------------------------|---|--|
| Material: | 304 and 316 Grade Stainless Steel | Aluminum – Natural and Anodized |
| Maximum temperature rating: | 538°C (1000°F) | 100°C (212°F) |
| Minimum temperature rating: | -80°C (-112°F) | -80°C (-112°F) |
| RoHS: | Compliant | Compliant |
| Flammability: | Non-flammable | Non-flammable |
| Ultraviolet light resistance: | Excellent | Good |



PANDUIT Stainless Steel Cable Tie and Strapping Approvals

C1. Wiring Duct

C2. Surface Raceway

C3. Abrasion Protection

C4. Cable Management

D1. Terminals

D2. Power Connectors

D3. Grounding Connectors

E1. Labeling Systems

E2. Labels

E3. Pre-Printed & Write-On Markers

E4. Permanent Identification

E5. Lockout/Tagout & Safety Solutions

F. Index

| Logo (Symbol) | Agency | Spec /Approval | Requirement | Applicable Products |
|---------------|---------------------------------|--|--|--|
| | Underwriters Laboratories, Inc. | Listing E56854 | Dimensional, tensile, temp., cycling, humidity | MLT-S, MLT-LH, MLT-H, MLTEH15, MLTSH, MLTDEH and MLTDSH in 304, and 316. MSW38T15, MSW50T15, MSW63T15, MSBW38, MSBW50, MSBW63 in both 304 and 316 material. MSCW38T15, MSCW50T15, MSCW63T15, MSCNW38T15, MLTFCS, SH, MLTCH, MSCNW50T15, and MSW63T15 in 316 material |
| | Conformite European | Low Voltage Directive 73/23/EEC (amended 93/68/EEC) MLT cable ties and MS straps also meet the requirements from EN50146 | CE Marking is required for products sold within the European Union. CE Marking Directives specify the minimum performance of these products. Applying the CE mark signifies compliance with essential requirements of specific directives. | All MLT, MRT, MRS ties and MS straps |
| | Amer. Bureau of Shipping | Cert. #03-HS373867-PDA, 04-HS476898-PDA, 05-HS118592C/1-PDA, 06-HS152579-PDA, 05-HS118592A/2-PDA | Mechanical | All MLT ties and MS straps |
| | Bureau Veritas | Cert. #04048/D2 BV | Material specification, dimensional, visual | All uncoated MLT ties in 304 and 316 material |
| | Det Norske Veritas | Cert. # E-6540 E-6539 | Salt mist test, tensile test, accelerated aging, vibration tests | All uncoated MLTS, MLTH, MLTE15, MLTDEH15, MLTSH, and MS strap coated and uncoated 316 material |
| | Germanischer Lloyd | Cert. # 32666-83HH 51796-89HH | Mechanical | All uncoated stainless steel MLT ties and all MS straps |
| | Lloyd's Register of Shipping | Cert. # 89/60123 | Material specification, tensile test, vibration tests | All uncoated stainless steel MLT ties and all MS straps |
| | RINA | Cert. # ELE71502CS | Material specification | All uncoated stainless steel MLT ties and all MS straps |
| | SAE Int'l formerly US MIL | AS23190 formerly MS23109E | Dimensional, visual, vibration, temp. cycling, immersion | MLT-S and MLT-H ties in 304 and 306 material |
| | US Coast Guard | File No.16703/46 | Mechanical | MLT-H series cable ties |
| | US Military | MIL-T-81306A/ MS90387-3 | Mechanical | GS4MT installation tools |

Chemical Resistance at 70°F (21°C) Temperature

| Chemical | % | 304 & 316 Stainless Steel* | Chemical | % | 304 & 316 Stainless Steel* | Chemical | % | 304 & 316 Stainless Steel* | Chemical | % | 304 & 316 Stainless Steel* |
|-----------------------|---------|----------------------------|---------------------|---------|----------------------------|------------------------|---------|----------------------------|--------------------|---------|----------------------------|
| Arsenic Acid | 40 | E | Cider | | E | Methyl Alcohol | 100 | E | Sodium Bisulfate | 10 | E |
| Acetone | 100 | E | Di-chloroethane | 100 | E | Methyl Chloride | 100 | E | Sodium Borate | All | E |
| Aluminum Hydroxide | AQ C.S. | E | Diethyl Ether | 100 | E | Methyl Ethyl Ketone | 100 | E | Sodium Carbonate | 5 | E |
| Ammonium Carbonate | 5 | E | Ethyl Alcohol | 100 | E | Naphtha | 100 | E | Sodium Chlorate | 25 | E |
| Ammonium Hydroxide | 10 | E | Ethyl Chloride | 100 | E | Nitric Acid | 30-70 | E | Sodium Chloride | 2 | E |
| Ammonium Nitrate | | E | Ethyl Glycol | 100 | E | Nitrous Acid | 5 | E | Sodium Fluoride | 5 | F |
| Ammonium Sulfate | 10 | S | Ferric Hydroxide | All | E | Oleic Acid | 100 | E | Sodium Hydroxide | 10 | E |
| Barium Carbonate | All | E | Ferric Nitrate | 10 | E | Oxalic Acid | 10 | E | Sodium Hyposulfite | AQ C.S. | E |
| Barium Chloride | 5 | E | Ferrous Sulfate | 10 | E | Paraffin | 100 | E | Sodium Nitrate | 5 | E |
| Barium Sulfate | 10 | E | Fuel Oil | 100 | E | Petroleum Ether | 100 | E | Sodium Nitrite | AQ C.S. | E |
| Barium Sulfide | 10 | E | Furfural | 100 | E | Phenol | 90 | E | Sodium Perchlorate | 10 | E |
| Benzene | 100 | E | Gallic Acid | AQ C.S. | E | Phosphoric Acid | 10 | E | Sodium Phosphate | 5 | E |
| Benzoic Acid | 100 | E | Gasoline | 100 | E | Picric Acid | 1 | S | Sodium Sulfate | 5 | E |
| Butyric Acid | 50 | E | Glycerine | 100 | E | Potassium Bromide | AQ C.S. | S | Sodium Thiosulfate | 5 | S |
| Calcium Carbonate | AQ C.S. | E | Hydrocyanic Acid | All | E | Potassium Carbonate 1% | | E | Stearic Acid | 100 | E |
| Calcium Chlorate | 10 | E | Hydrogen Peroxide | 30 | E | Potassium Chlorate | AQ C.S. | E | Sulfur | 100 | E |
| Calcium Hydroxide | 20 | E | Hydrogen Sulfide | Dry | E | Potassium Dichromate | 40 | E | Sulfur Dioxide | All | E |
| Calcium Hydrochlorite | 2 | F | Idoform | 100 | E | Potassium Ferrocyanide | 25 | E | Sulfuric Acid | 100 | E |
| Calcium Sulfate | 2 | E | Isopropyl Alcohol | 100 | E | Potassium hydroxide | 5 | E | Sulfuric Acid | 5 | F |
| Carbon Tetrachloride | | | Jet Fuel | 100 | E | Potassium Iodide | All | E | Tannic Acid | 10 | E |
| Chlorine (Wet) | | F | Lactic Acid | 100 | E | Potassium Nitrate | 50 | E | Tartaric Acid | 50 | E |
| Chlorine (Dry) | | F | Lanolin | 10 | E | Potassium Permanganate | 5 | E | Tetrahydrofuran | 100 | E |
| Chloroacetic Acid | 30 | F | Lead Acetate | 5 | E | Potassium Sulfate | 5 | E | Toluene | 100 | F |
| Chloroform | 100 | E | Magnesium Carbonate | All | E | Potassium Sulfide | AQ C.S. | E | Xylene | 100 | E |
| Chromic Acid | 5 | E | Magnesium Chloride | 10 | F | Propyl Alcohol | 100 | E | Zinc Chloride | 70 | E |
| Citric Acid | 50 | E | Magnesium Nitrate | All | E | Silver Nitrate | 10 | E | Zinc Nitrate | AQ C.S. | E |
| Copper Cyanide | 10 | E | Malic Acid | AQ C.S. | E | Sodium Acetate | 60 | E | Zinc Sulfate | AQ C.S. | E |
| Copper Nitrate | 50 | E | Mercury | 100 | E | Sodium Bicarbonate | All | E | | | |

* E = Excellent S = Satisfactory F = Fair AQ C.S. = Aqueous Cold Saturated All = All % Concentrations

A.
System
Overview

B1.
Cable Ties

B2.
Cable
Accessories

B3.
Stainless
Steel Ties

C1.
Wiring
Duct

C2.
Surface
Raceway

C3.
Abrasion
Protection

C4.
Cable
Management

D1.
Terminals

D2.
Power
Connectors

D3.
Grounding
Connectors

E1.
Labeling
Systems

E2.
Labels

E3.
Pre-Printed
& Write-On
Markers

E4.
Permanent
Identification

E5.
Lockout/
Tagout
& Safety
Solutions

F.
Index

A.
System
Overview

Rigorous Tests and Physical Properties of Stainless Steel

B1.
Cable Ties

STRENGTH: *PANDUIT® PAN-STEEL®* Stainless Steel Ties and Straps are tested per the SAE Standard AS23190 formerly U.S. Military Specification MIL-S-23190, minimum loop tensile test. This test consists of applying a tie to a split mandrel and then measuring the force required to separate the (two) halves until the tie fails. These minimum loop tensile strengths are given for the various products on pages B3.5 through B3.25.



B2.
Cable
Accessories

TEMPERATURE EXTREMES: *PANDUIT® PAN-STEEL®* Stainless Steel Ties and Straps are 100% stainless steel in the alloy provided (locking head, locking ball, and body all provided from the same grade of material ordered).

Various temperature tests have been successfully completed. One such test is the U.S. Military Temperature Cycling Test per Thermal Shock Method 107, Test Condition B of MIL-STD-202. This test exposes the parts from low temperature 85°F (-65°C) to high temperature 275°F (135°C) to low temperature -85°F (-65°C). After exposure, the parts must be free of cracks, distortions, breaks, release of locking device; and meet the minimum loop tensile requirements.

B3.
Stainless
Steel Ties

SHOCK AND VIBRATION: *PANDUIT® PAN-STEEL®* Standard and Heavy Cross Section ties have passed the U.S. Military random vibration Test Method 214. Test Condition II, Letter J of MIL-STD-202. This test consists of applying parts to a bundle and then vibrating them with random vibration for 8 hours in each of two mutually perpendicular directions. The parts are then subjected to further temperature testing and finally have to pass the minimum loop tensile strength test.

PANDUIT® PAN-STEEL® Extra Heavy, Super Heavy, MSW50 Strapping and MSW63 Strapping have passed the U.S. Military Shock and Vibration Testing per MIL-STD-167 and MIL-S-901D. The ties were subjected to vibrations in all three planes from 4 – 50 Hz and Shock testing in all three planes utilizing a hammer shock machine.

C1.
Wiring
Duct

C2.
Surface
Raceway

SALT SPRAY: *PANDUIT® PAN-STEEL®* Stainless Steel Ties and Straps have been subjected to salt spray tests without signs of corrosion or reduction in performance.

OUTDOOR EXPOSURE: *PANDUIT® PAN-STEEL®* Stainless Steel Ties and Straps have been exposed outdoors at New Lenox, Illinois USA since 1985. At the printing of this catalog, there has been no sign of corrosion or loss of performance.

C3.
Abrasion
Protection

C4.
Cable
Management

FLUID IMMERSION: *PANDUIT® PAN-STEEL®* Stainless Steel Ties were immersed in: 1-Hydraulic Fluid, 2-Turbine Fuel, 3-Lubricating Oil, and 4-Isopropyl Alcohol for four hours at temperatures of 122°F (50°C). Per SAE Standard AS23190, the parts were then subjected to and passed the minimum loop tensile test.

RADIATION: Installed cable ties of various materials have been exposed to different amounts of radiation to determine the maximum acceptable limit. These tests were conducted by *PANDUIT* to determine the acceptability for use in various areas of nuclear power plants (accumulated over 40 year life). Radiation resistance is 2x10⁸ rads.

D1.
Terminals

D2.
Power
Connectors

D3.
Grounding
Connectors

E1.
Labeling
Systems

E2.
Labels

E3.
Pre-Printed
& Write-On
Markers

E4.
Permanent
Identification

E5.
Lockout/
Tagout
& Safety
Solutions

F.
Index

Military Cross Reference (AS23190)

| Current Military Standard Part Number | <i>PANDUIT</i> Part Number |
|---------------------------------------|----------------------------|
| M23190/3-1 | MLT2S-CP |
| M23190/3-1 | MLT2S-CP316 |
| M23190/3-2 | MLT4S-CP |
| M23190/3-2 | MLT4S-CP316 |
| M23190/3-3 | MLT6S-CP |
| M23190/3-3 | MLT6S-CP316 |
| M23190/3-4 | MLT8S-CP |
| M23190/3-4 | MLT8S-CP316 |
| M23190/3-5 | MLT2H-LP |
| M23190/3-5 | MLT2H-LP316 |
| M23190/3-6 | MLT4H-LP |
| M23190/3-6 | MLT4H-LP316 |
| M23190/3-7 | MLT6H-LP |
| M23190/3-7 | MLT6H-LP316 |
| M23190/3-8 | MLT8H-LP |
| M23190/3-8 | MLT8H-LP316 |
| M23190/3-9 | MLT10H-LP |
| M23190/3-9 | MLT10H-LP316 |

WIRING DUCT

From the smallest wall mounted panels to the largest integrated turnkey systems *PANDUIT® PANDUCT®* Wiring Duct is the premium wire management solution for routing and concealing wiring in electrical control panels. *PANDUCT®* Wiring Duct provide solutions for the original equipment manufacturing, transportation, contract manufacturing, maintenance and repair and communications markets. All *PANDUCT®* Wiring Duct are UL Recognized and CSA Certified and most carry the CE mark.

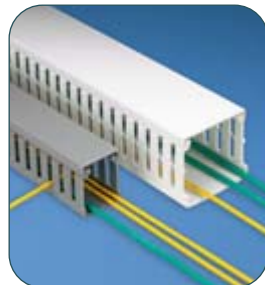
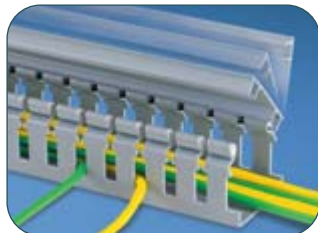

Some of the features and benefits found in *PANDUCT®* Wiring Duct include:

- Smooth corners and edges that will not abrade wiring or irritate hands
- Integrated nonskid liners and unique cover designs insure the duct cover will not slide once installed or during vibration
- Specially formulated lead-free PVC material meets the NFPA79: 2007 flame retardancy requirements and carries a UL 94V-0 flammability rating
- Scorelines for easy removal of duct fingers and sidewalls
- Accessories and tools that increase productivity and lower the installed cost

PANDUIT continues to develop new *PANDUCT®* Wiring Duct solutions to satisfy the challenges facing our customers worldwide. The new type HN hinged cover wiring duct features narrow slots for excellent high-density wire management. Plus the exclusive hinged cover provides convenient channel access resulting in up to 20% faster wiring changes for reduced labor costs. Maximize the utilization of enclosure space with *PANELMAX™* Corner Wiring Duct, which fits into the corner of enclosures and provides up to five square feet of additional subpanel space for mounting control components or up to 20% savings in enclosure footprint area.

A.
System
Overview

B1.
Cable Ties

B2.
Cable
Accessories

B3.
Stainless
Steel Ties

C1.
Wiring
Duct

C2.
Surface
Raceway

C3.
Abrasion
Protection

C4.
Cable
Management

D1.
Terminals

D2.
Power
Connectors

D3.
Grounding
Connectors

E1.
Labeling
Systems

E2.
Labels

E3.
Pre-Printed
& Write-On
Markers

E4.
Permanent
Identification

E5.
Lockout/
Tagout
& Safety
Solutions

F.
Index

A. System Overview

B1. Cable Ties

B2. Cable Accessories

B3. Stainless Steel Ties

C1. Wiring Duct

C2. Surface Raceway

C3. Abrasion Protection

C4. Cable Management

D1. Terminals

D2. Power Connectors

D3. Grounding Connectors

E1. Labeling Systems

E2. Labels

E3. Pre-Printed & Write-On Markers

E4. Permanent Identification

E5. Lockout/Tagout & Safety Solutions

F. Index

Wiring Duct for Control Panel Applications

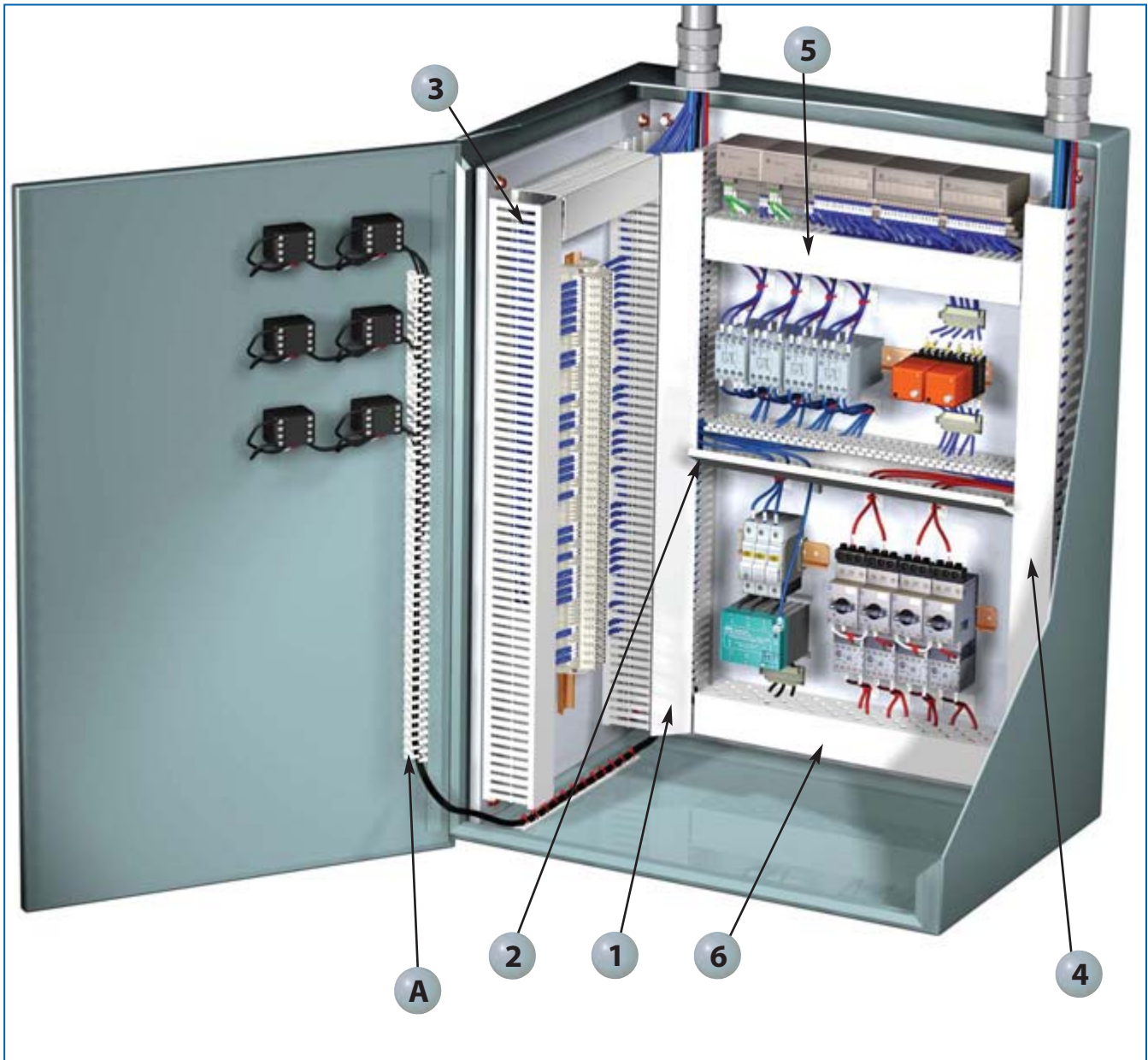

A For information on FL Wiring Duct and other *PANDUIT®* Accessories see pages C1.25 – C1.32

1 *PANDUCT® PANELMAX™* Corner Wiring Duct
(pages C1.4 – C1.5)



2 *PANDUCT®* Type H Wide Slot and
HN Narrow Slot Hinged Cover Wiring Duct
(pages C1.6 – C1.7)

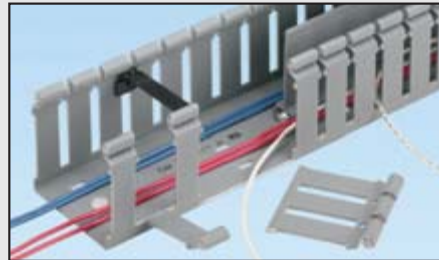

3 *PANDUCT®* Type F Narrow Slot Wiring Duct
(pages C1.10 – C1.11)

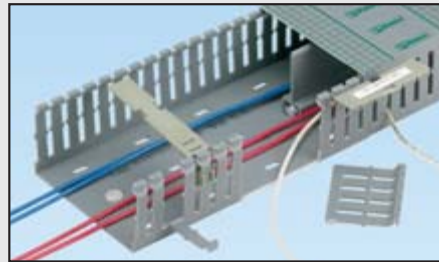

4 *PANDUCT®* Type G Wide Slot Wiring Duct
(pages C1.8 – C1.9)

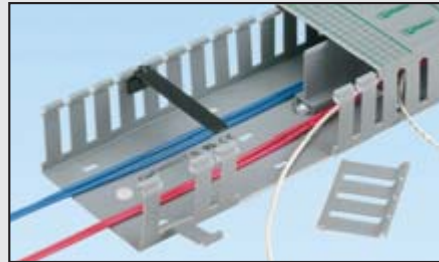

5 *PANDUCT®* Type MC Metric Wiring Duct
(pages C1.14 – C1.15)

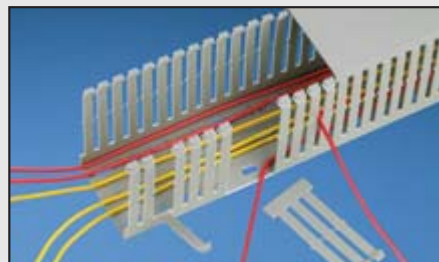

6 *PANDUCT®* Type D Flush Cover Round Hole
Wiring Duct (pages C1.12 – C1.13)

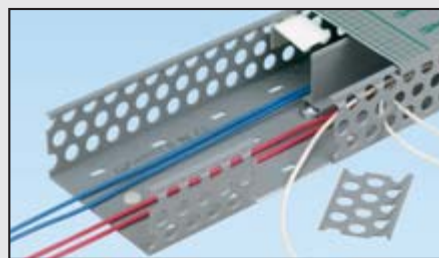

A.
System
Overview

B1.
Cable Ties

B2.
Cable
Accessories

B3.
Stainless
Steel Ties

C1.
Wiring
Duct

C2.
Surface
Raceway

C3.
Abrasion
Protection

C4.
Cable
Management

D1.
Terminals

D2.
Power
Connectors

D3.
Grounding
Connectors

E1.
Labeling
Systems

E2.
Labels

E3.
Pre-Printed
& Write-On
Markers

E4.
Permanent
Identification

E5.
Lockout/
Tagout
& Safety
Solutions

F.
Index

A. System Overview

Features and Benefits – PANDUCT® PANELMAX™ Corner Wiring Duct

B1. Cable Ties

B2. Cable Accessories

B3. Stainless Steel Ties

C1. Wiring Duct

C2. Surface Raceway

C3. Abrasion Protection

C4. Cable Management

D1. Terminals

D2. Power Connectors

D3. Grounding Connectors

E1. Labeling Systems

E2. Labels

E3. Pre-Printed & Write-On Markers

E4. Permanent Identification

E5. Lockout/Tagout & Safety Solutions

F. Index

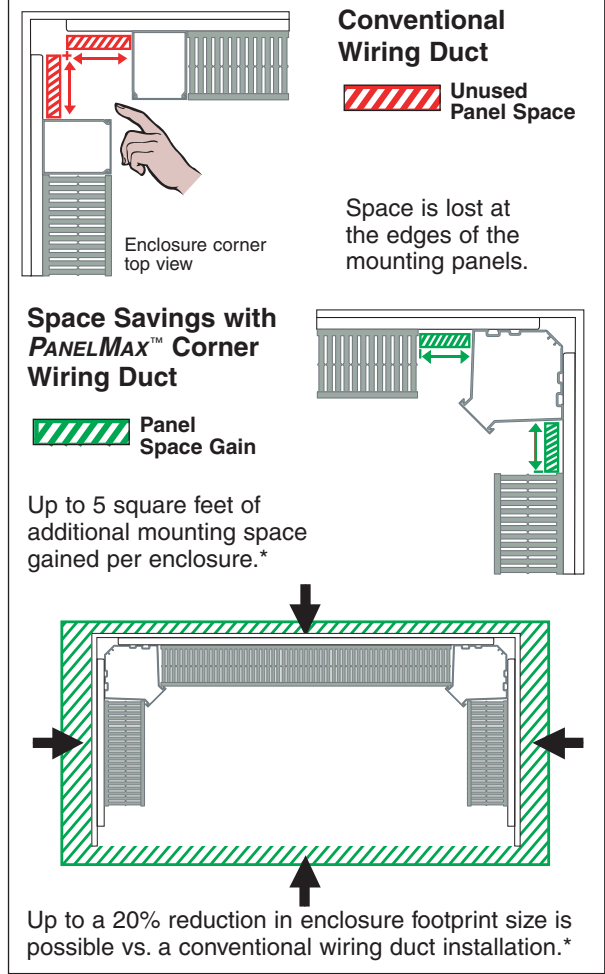
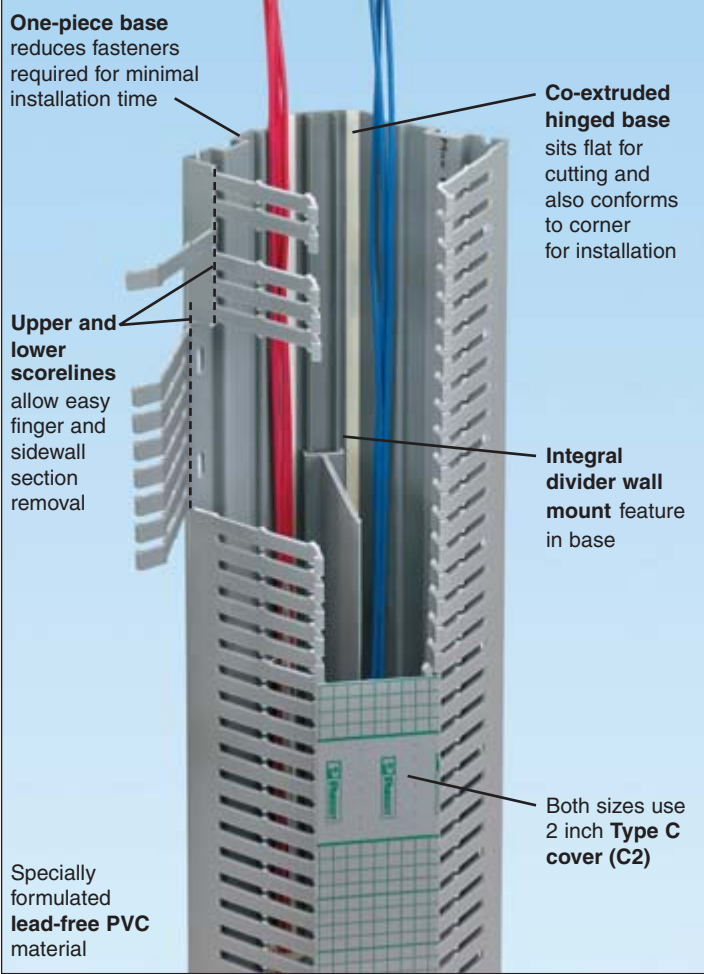

PANDUCT® Nylon Rivets
Fast, lowest cost mounting method.
See page C1.34.



PANDUCT® Installation Tools
Wide selection of hand tools for cutting and installing wiring duct.
See page C1.34.

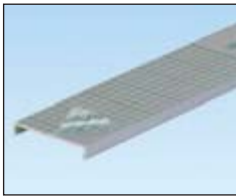

PANDUCT® Type C Cover with Protective Film
Reduces scrap and labor costs by protecting the surface during storage, handling, and installation.
See page C1.5.



PANDUCT® Divider Wall
Creates separate wiring channels within the wiring duct base. Available in solid or slotted wall styles.
See page C1.26.

*Actual subpanel space savings will vary depending on wiring duct size, component layout, and enclosure size and type. Footprint savings is based on commercially available enclosures and may not be achievable in some applications.

UL® CE PANELMAX™ Corner Wiring Duct



- Fits in the unused space in the vertical corner of enclosures, gaining subpanel space or saving enclosure footprint area
- One-piece base requires less time to install than multi-piece solutions
- Optional quick mount clips engage anywhere along the product base further reducing assembly costs

- PANDUIT divider wall snaps directly to the integrated mounting feature in the channel to create two separate channels
- Compatible with PANDUIT 3 inch and 4 inch height wiring duct; both product sizes uses standard 2 inch wiring duct cover
- Base and cover length is 6 feet



| Base Part Number | Duct Size W x H (In.) | Slot Width | | Cover Part Number | Std. Pkg. Qty. | Base Ctn. Qty. | Cover Ctn. Qty. |
|------------------|-----------------------|------------|-----|-------------------|----------------|----------------|-----------------|
| | | In. | mm | | | | |
| CWD3LG6 | 4.40 x 3.57 | .20 | 5.0 | C2LG6 | 6 | 24 | 120 |
| CWD4LG6 | 5.33 x 4.58 | .20 | 5.0 | C2LG6 | 6 | 24 | 120 |
| CWD3WH6 | 4.40 x 3.57 | .20 | 5.0 | C2WH6 | 6 | 24 | 120 |
| CWD4WH6 | 5.33 x 4.58 | .20 | 5.0 | C2WH6 | 6 | 24 | 120 |

Part number shown in LG (Light Gray) color, also available in WH (White) color. Product available in 6' lengths.

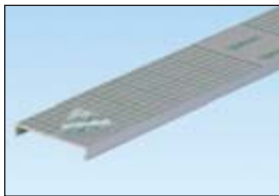
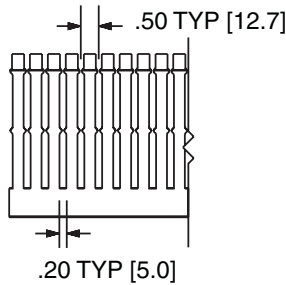
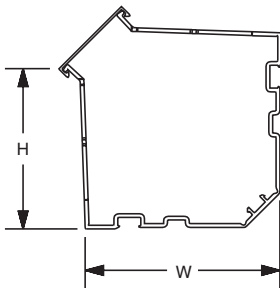

To order cover with protective film add "-F" to part number. 6" inch cover not available with protective film.



CDLB



CDCLP

| Part Number | Part Description | Fastener Size | Std. Pkg. Qty. | Std. Ctn. Qty. |
|--------------------------|--|------------------------------|----------------|----------------|
| Quick Mount Clips | | | | |
| CDLB3 | L-bracket with quick mounting clip for installing CWD3 to back panel only. | #10-32 x 1/4 (user supplied) | 16 | — |
| CDLB4 | L-bracket with quick mounting clip for installing CWD4 to back panel only. | #10-32 x 1/4 (user supplied) | 16 | — |
| CDCLP3 | Quick mounting clip for installing CWD3 corner wiring duct. | #10-32 x 1/4 (user supplied) | 16 | — |
| CDCLP4 | Quick mounting clip for installing CWD4 corner wiring duct. | #10-32 x 1/4 (user supplied) | 16 | — |

A. System Overview

B1. Cable Ties

B2. Cable Accessories

B3. Stainless Steel Ties

C1. Wiring Duct

C2. Surface Raceway

C3. Abrasion Protection

C4. Cable Management

D1. Terminals

D2. Power Connectors

D3. Grounding Connectors

E1. Labeling Systems

E2. Labels

E3. Pre-Printed & Write-On Markers

E4. Permanent Identification

E5. Lockout/Tagout & Safety Solutions

F. Index

A. System Overview

Features and Benefits – PANDUCT® Type H and HN Hinged Cover Wiring Duct

Available in eight sizes from 1.5" x 2" up to 4" x 4" in light gray, black, and white colors.

B1. Cable Ties

B2. Cable Accessories

B3. Stainless Steel Ties

C1. Wiring Duct

C2. Surface Raceway

C3. Abrasion Protection

C4. Cable Management

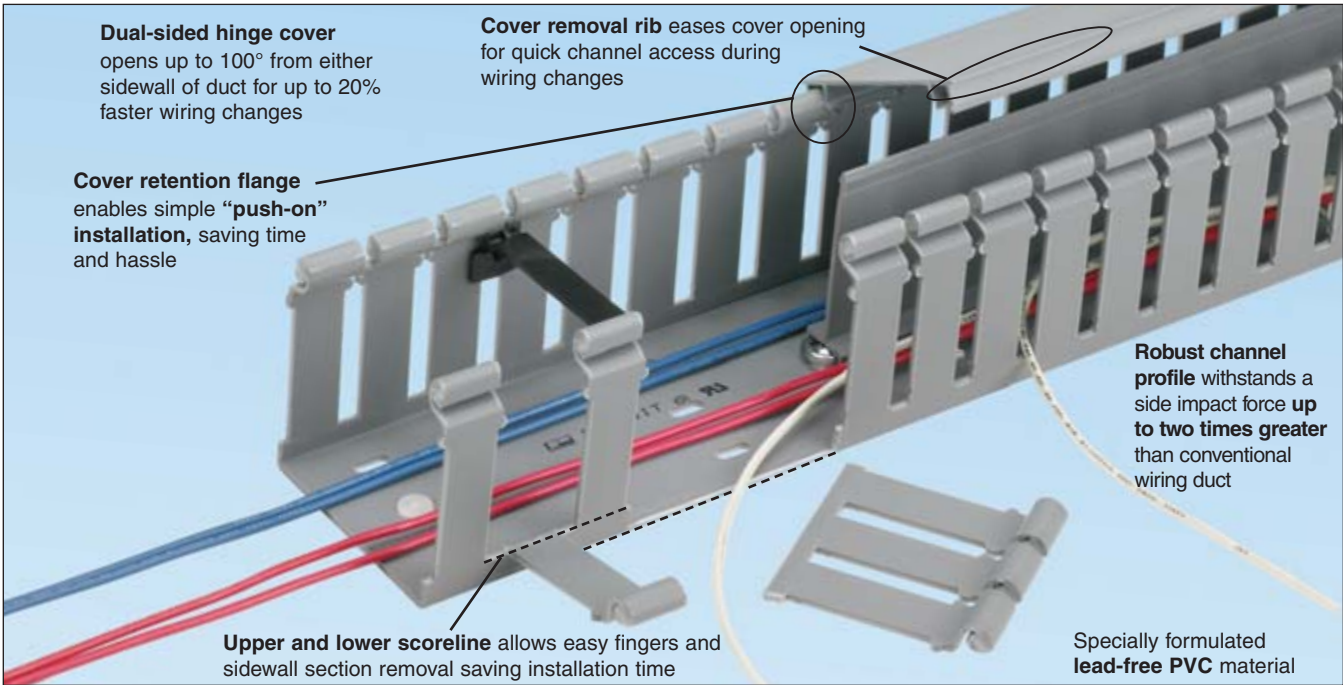

D1. Terminals

Labor Savings

- By avoiding the time and hassle in removing and replacing covers, simple wiring changes can be made up to **20% faster** compared to conventional wiring duct installations*

D2. Power Connectors

Avoid Cover Replacement Costs

- Covers represent 20% of the cost of the wiring duct purchase
- Misplaced covers are a common occurrence after years of use
- Not needing to remove covers during maintenance ensures **better aesthetics and safety** and **avoids the cost to replace lost covers**

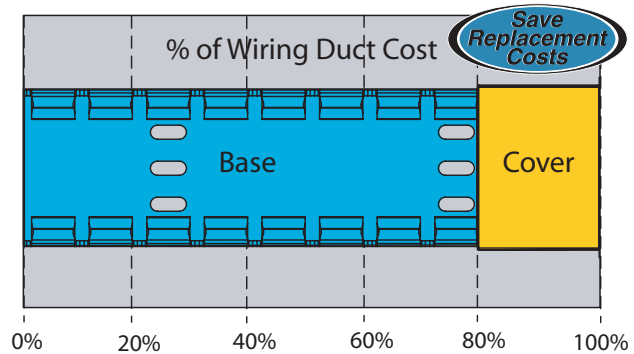

D3. Grounding Connectors

E1. Labeling Systems

E2. Labels

E3. Pre-Printed & Write-On Markers

E4. Permanent Identification

E5. Lockout/Tagout & Safety Solutions

F. Index



PANDUCT® Wire Retainers
Contain wiring when duct cover is opened. Wire retainers snap easily between duct fingers. See page C1.28.



PANDUCT® Divider Wall
Create separate wiring channels within the wiring duct base. Available in solid or slotted wall styles. See page C1.26.



PANDUCT® Installation Tools
Wide selection of hand tools for cutting and installing wiring duct. See page C1.34.



PANDUCT® Nylon Rivets
Fast, lowest cost mounting method. See page C1.34.

*Based on mock panel installations of type H hinged cover wiring duct and other commonly available wiring ducts adding a single component with four wires.



UL **PANDUCT® Type HN Hinged Cover Narrow Slot Wiring Duct**

- Narrow slot/finger design provides excellent wire management with smaller wire diameters and high-density components such as terminal blocks, input/output devices, and other hardware
- Material: Lead-free PVC
- UL Recognized continuous use temperature: 122°F (50°C)
- UL 94 flammability rating of V-0
- Conforms with NFPA 79-2007 section 13.3.1 requirement for flame retardant material
- Provided with mounting holes
- Base and cover length is 6 feet

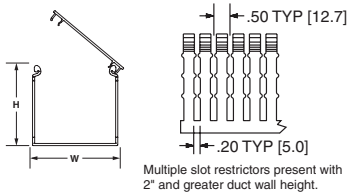

| Base Part Number | Duct Size W x H* | | Slot Width | | Cover Part Number | Std. Pkg. Qty | Base Ctn. Qty. | Cover Ctn. Qty. |
|------------------|------------------|---------------|------------|-----|-------------------|---------------|----------------|-----------------|
| | In. | mm | In. | mm | | | | |
| HN1.5X2LG6 | 1.75 x 1.98 | 44.5 x 50.3 | .20 | 5.0 | HC1.5LG6 | 6 | 120 | 120 |
| HN1.5X3LG6 | 1.75 x 3.06 | 44.5 x 77.7 | .20 | 5.0 | HC1.5LG6 | 6 | 120 | 120 |
| HN2X2LG6 | 2.17 x 1.98 | 55.1 x 50.3 | .20 | 5.0 | HC2LG6 | 6 | 120 | 120 |
| HN2X3LG6 | 2.17 x 3.06 | 55.1 x 77.7 | .20 | 5.0 | HC2LG6 | 6 | 60 | 120 |
| HN2X4LG6 | 2.17 x 4.10 | 55.1 x 104.1 | .20 | 5.0 | HC2LG6 | 6 | 60 | 120 |
| HN3X3LG6 | 3.25 x 3.06 | 82.6 x 77.7 | .20 | 5.0 | HC3LG6 | 6 | 60 | 120 |
| HN3X4LG6 | 3.25 x 4.10 | 82.6 x 104.1 | .20 | 5.0 | HC3LG6 | 6 | 60 | 120 |
| HN4X4LG6 | 4.25 x 4.10 | 108.0 x 104.1 | .20 | 5.0 | HC4LG6 | 6 | 60 | 60 |

Part Number shown for LG (Light Gray). Available in WH (White).
Base and cover sold separately.
**"H" dimension includes duct and cover.

UL **PANDUCT® Type H Hinged Cover Wide Slot Wiring Duct**

- Wide slot/finger design provides excellent wire management in general purpose applications and is compatible a wide range of wire sizes and component types
- Material: Lead-free PVC
- Rated for continuous use temperature: 122°F (50°C)
- UL 94 flammability rating of V-0
- Conforms with NFPA 79-2007 section 13.3.1 requirement for flame retardant material
- Provided with standard mounting holes
- Base and cover length is 6 feet

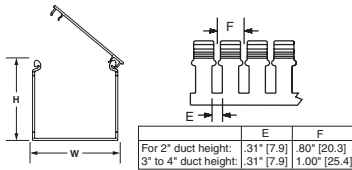
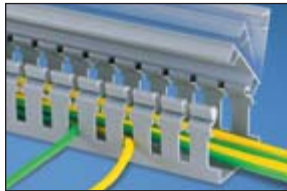

| Base Part Number | Duct Size W x H* | | Slot Width | | Cover Part Number | Std. Pkg. Qty | Base Ctn. Qty. | Cover Ctn. Qty. |
|------------------|------------------|---------------|------------|-----|-------------------|---------------|----------------|-----------------|
| | In. | mm | In. | mm | | | | |
| H1.5X2LG6 | 1.75 x 1.98 | 44.5 x 50.3 | .31 | 7.9 | HC1.5LG6 | 6 | 120 | 120 |
| H1.5X3LG6 | 1.75 x 3.06 | 44.5 x 77.7 | .31 | 7.9 | HC1.5LG6 | 6 | 120 | 120 |
| H2X2LG6 | 2.17 x 1.98 | 55.1 x 50.3 | .31 | 7.9 | HC2LG6 | 6 | 120 | 120 |
| H2X3LG6 | 2.17 x 3.06 | 55.1 x 77.7 | .31 | 7.9 | HC2LG6 | 6 | 60 | 120 |
| H2X4LG6 | 2.17 x 4.10 | 55.1 x 104.1 | .31 | 7.9 | HC2LG6 | 6 | 60 | 120 |
| H3X3LG6 | 3.25 x 3.06 | 82.6 x 77.7 | .31 | 7.9 | HC3LG6 | 6 | 60 | 120 |
| H3X4LG6 | 3.25 x 4.10 | 82.6 x 104.1 | .31 | 7.9 | HC3LG6 | 6 | 60 | 120 |
| H4X4LG6 | 4.25 x 4.10 | 108.0 x 104.1 | .31 | 7.9 | HC4LG6 | 6 | 60 | 60 |

Part Number shown for LG (Light Gray). Available in BL (Black) and WH (White).
Base and cover sold separately.
**"H" dimension includes duct and cover.

UL **PANDUCT® Type HS Hinged Cover Solid Wall Raceway**

- Solid wall raceway conceals and protects wiring in continuous runs such as in low-voltage cord management applications between control panel stations in conveyor systems
- Material: Lead-free PVC
- UL recognized continuous use temperature: 122°F (50°C)
- UL 94 flammability rating of V-0
- Supplied without mounting holes
- Base and cover length is 6 feet

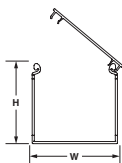
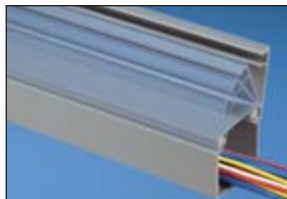

| Base Part Number | Duct Size (W x H)* | | Cover Part Number | Std. Pkg. Qty. | Base Ctn. Qty. | Cover Ctn. Qty. |
|------------------|--------------------|---------------|-------------------|----------------|----------------|-----------------|
| | In. | mm | | | | |
| HS1.5X2LG6NM | 1.75 x 1.98 | 44.5 x 50.3 | HC1.5LG6 | 6 | 120 | 120 |
| HS1.5X3LG6NM | 1.75 x 3.06 | 44.5 x 77.7 | HC1.5LG6 | 6 | 60 | 120 |
| HS2X2LG6NM | 2.17 x 1.98 | 55.1 x 50.3 | HC2LG6 | 6 | 120 | 120 |
| HS2X3LG6NM | 2.17 x 3.06 | 55.1 x 77.7 | HC2LG6 | 6 | 60 | 120 |
| HS2X4LG6NM | 2.17 x 4.10 | 55.1 x 104.1 | HC2LG6 | 6 | 60 | 120 |
| HS3X3LG6NM | 3.25 x 3.06 | 82.6 x 77.7 | HC3LG6 | 6 | 60 | 120 |
| HS3X4LG6NM | 3.25 x 4.10 | 82.6 x 104.1 | HC3LG6 | 6 | 60 | 120 |
| HS4X4LG6NM | 4.25 x 4.10 | 108.0 x 104.1 | HC4LG6 | 6 | 60 | 60 |

Part Number shown for LG (Light Gray). For BL (Black) and WH (White) colors see color selection guide, page C1.48.
Base and cover sold separately.
**"H" dimension includes duct and cover.

A. System Overview

B1. Cable Ties

B2. Cable Accessories

B3. Stainless Steel Ties

C1. Wiring Duct

C2. Surface Raceway

C3. Abrasion Protection

C4. Cable Management

D1. Terminals

D2. Power Connectors

D3. Grounding Connectors

E1. Labeling Systems

E2. Labels

E3. Pre-Printed & Write-On Markers

E4. Permanent Identification

E5. Lockout/Tagout & Safety Solutions

F. Index

A. System Overview

Features and Benefits – PANDUCT® Type G Wide Slot Wiring Duct

Available in 36 sizes from .5" x .5" up to 6" x 4" in a variety of colors.

B1. Cable Ties

B2. Cable Accessories

B3. Stainless Steel Ties

C1. Wiring Duct

C2. Surface Raceway

C3. Abrasion Protection

C4. Cable Management

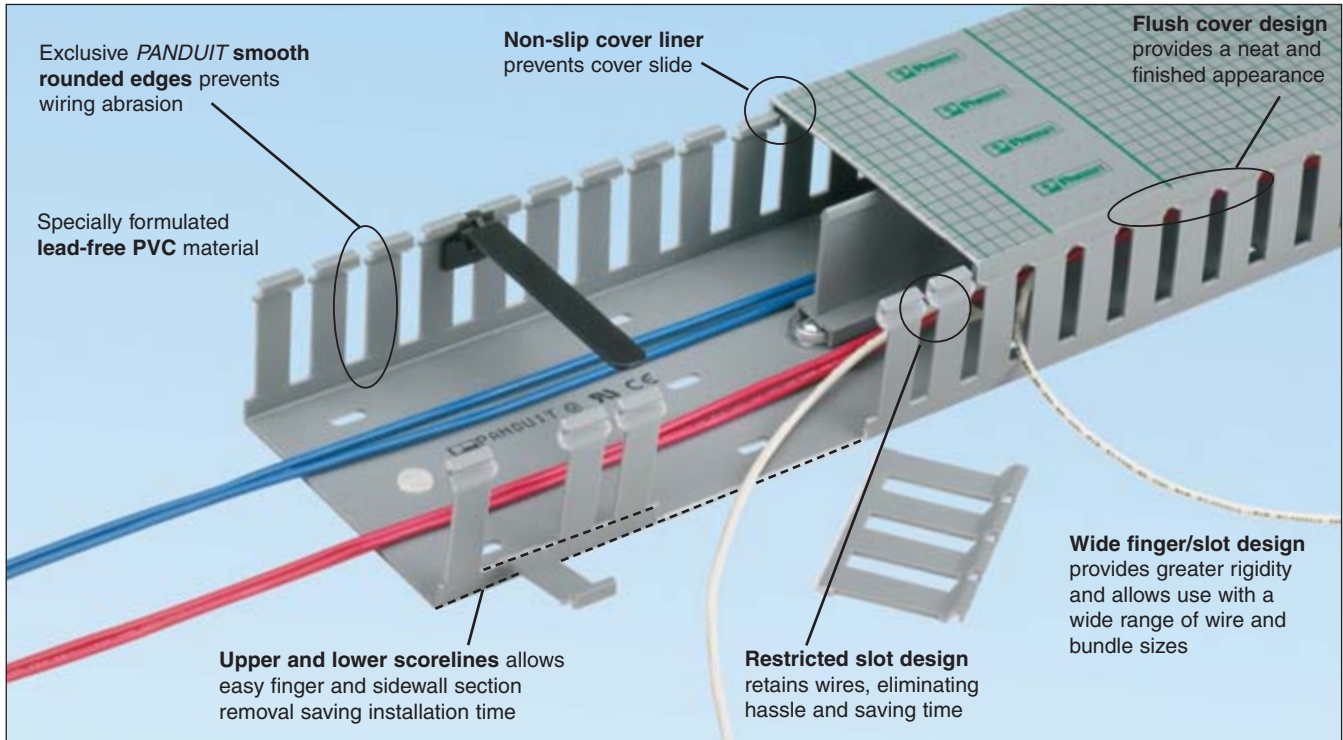

D1. Terminals

D2. Power Connectors

D3. Grounding Connectors



PANDUCT® Wire Retainers
Contain wiring when duct cover is opened. Wire retainers snap easily between duct fingers.
See page C1.28.



PANDUCT® Divider Wall
Create separate wiring channels within the wiring duct base. Available in solid or slotted wall styles.
See page C1.26.

E1. Labeling Systems

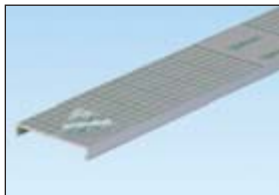

PANDUCT® Type C Cover with Protective Film
Reduces scrap and labor costs by protecting the surface during storage, handling, and installation.
See page C1.9.



PANDUCT® Nylon Rivets
Fast, lowest cost mounting method.
See page C1.34.

E4. Permanent Identification



PANDUCT® Installation Tools
Wide selection of hand tools for cutting and installing wiring duct.
See page C1.34.

E5. Lockout/Tagout & Safety Solutions

F. Index

PANDUCT® Type G Wide Slot Wiring Duct

- Wide slot/finger design provides greater sidewall rigidity and can be used with a wide range of wire bundle sizes
- Material: Lead-free PVC
- UL recognized continuous use temperature: 122°F (50°C)
- UL 94 flammability rating of V-0
- Conforms with NFPA 79-2007 section 13.3.1 requirement for flame retardant material
- Provided with mounting holes
- Base and cover length is 6 feet

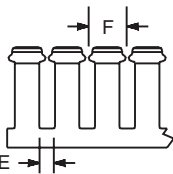
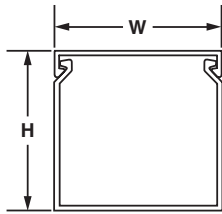
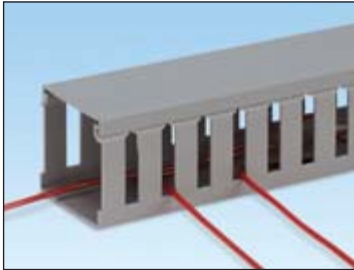

| | E | F |
|-------------------------|------------|--------------|
| For .5" duct height: | .37" [9.4] | .80" [20.3] |
| .75" to 2" duct height: | .31" [7.9] | .80" [20.3] |
| 3" to 4" duct height: | .31" [7.9] | 1.00" [25.4] |
| 5" duct height: | .38" [9.4] | 1.33" [33.8] |



To order cover with protective film add "-F" to part number. 6" cover not available with film.

| Base Part Number | Duct Size (W x H)* | | Slot Width | | Cover Part Number | Std. Pkg. Qty. | Base Ctn. Qty. | Cover Ctn. Qty. |
|------------------|--------------------|---------------|------------|-----|-------------------|----------------|----------------|-----------------|
| | In. | mm | In. | mm | | | | |
| G.5X.5LG6 | .69 x .60 | 17.5 x 15.2 | .38 | 9.7 | C.5LG6 | 6 | 120 | 120 |
| G.5X1LG6 | .69 x 1.06 | 17.5 x 26.9 | .31 | 7.9 | C.5LG6 | 6 | 120 | 120 |
| G.5X2LG6 | .69 x 2.03 | 17.5 x 51.6 | .31 | 7.9 | C.5LG6 | 6 | 120 | 120 |
| G.5X4LG6 | .69 x 4.10 | 17.5 x 104.1 | .31 | 7.9 | C.5LG6 | 6 | 60 | 120 |
| G.75X.75LG6 | .93 x .82 | 23.6 x 20.8 | .31 | 7.9 | C.75LG6 | 6 | 120 | 120 |
| G.75X1LG6 | .93 x 1.06 | 23.6 x 26.9 | .31 | 7.9 | C.75LG6 | 6 | 120 | 120 |
| G.75X1.5LG6 | .93 x 1.57 | 23.6 x 39.9 | .31 | 7.9 | C.75LG6 | 6 | 120 | 120 |
| G.75X2LG6 | .93 x 2.03 | 23.6 x 51.7 | .31 | 7.9 | C.75LG6 | 6 | 120 | 120 |
| G1X1LG6 | 1.26 x 1.12 | 32.0 x 28.4 | .31 | 7.9 | C1LG6 | 6 | 120 | 120 |
| G1X1.5LG6 | 1.26 x 1.62 | 32.0 x 41.1 | .31 | 7.9 | C1LG6 | 6 | 120 | 120 |
| G1X2LG6 | 1.26 x 2.12 | 32.0 x 53.8 | .31 | 7.9 | C1LG6 | 6 | 120 | 120 |
| G1X3LG6 | 1.26 x 3.12 | 32.0 x 79.2 | .31 | 7.9 | C1LG6 | 6 | 120 | 120 |
| G1X4LG6 | 1.26 x 4.10 | 32.0 x 104.1 | .31 | 7.9 | C1LG6 | 6 | 60 | 120 |
| G1.5X1LG6 | 1.75 x 1.12 | 44.5 x 28.4 | .31 | 7.9 | C1.5LG6 | 6 | 120 | 120 |
| G1.5X1.5LG6 | 1.75 x 1.62 | 44.5 x 41.1 | .31 | 7.9 | C1.5LG6 | 6 | 120 | 120 |
| G1.5X2LG6 | 1.75 x 2.12 | 44.5 x 53.8 | .31 | 7.9 | C1.5LG6 | 6 | 120 | 120 |
| G1.5X3LG6 | 1.75 x 3.12 | 44.5 x 79.2 | .31 | 7.9 | C1.5LG6 | 6 | 120 | 120 |
| G1.5X4LG6 | 1.75 x 4.10 | 44.5 x 104.1 | .31 | 7.9 | C1.5LG6 | 6 | 60 | 120 |
| G2X1LG6 | 2.25 x 1.12 | 57.2 x 28.4 | .31 | 7.9 | C2LG6 | 6 | 120 | 120 |
| G2X1.5LG6 | 2.25 x 1.62 | 57.2 x 41.1 | .31 | 7.9 | C2LG6 | 6 | 120 | 120 |
| G2X2LG6 | 2.25 x 2.12 | 57.2 x 53.8 | .31 | 7.9 | C2LG6 | 6 | 120 | 120 |
| G2X3LG6 | 2.25 x 3.12 | 57.2 x 79.2 | .31 | 7.9 | C2LG6 | 6 | 60 | 120 |
| G2X4LG6 | 2.25 x 4.10 | 57.2 x 104.1 | .31 | 7.9 | C2LG6 | 6 | 60 | 120 |
| G2X5LG6 | 2.25 x 5.10 | 57.2 x 129.5 | .38 | 9.7 | C2LG6 | 6 | 60 | 120 |
| G2.5X3LG6 | 2.75 x 3.12 | 69.9 x 79.2 | .31 | 7.9 | C2.5LG6 | 6 | 120 | 120 |
| G3X1LG6 | 3.25 x 1.12 | 82.6 x 28.4 | .31 | 7.9 | C3LG6 | 6 | 120 | 120 |
| G3X2LG6 | 3.25 x 2.12 | 82.6 x 53.8 | .31 | 7.9 | C3LG6 | 6 | 120 | 120 |
| G3X3LG6 | 3.25 x 3.12 | 82.6 x 79.2 | .31 | 7.9 | C3LG6 | 6 | 60 | 120 |
| G3X4LG6 | 3.25 x 4.10 | 82.6 x 104.1 | .31 | 7.9 | C3LG6 | 6 | 60 | 120 |
| G3X5LG6 | 3.25 x 5.10 | 82.6 x 129.5 | .38 | 9.7 | C3LG6 | 6 | 60 | 120 |
| G4X1.5LG6 | 4.25 x 1.62 | 108.0 x 41.1 | .31 | 7.9 | C4LG6 | 6 | 120 | 120 |
| G4X2LG6 | 4.25 x 2.12 | 108.0 x 53.8 | .31 | 7.9 | C4LG6 | 6 | 60 | 120 |
| G4X3LG6 | 4.25 x 3.12 | 108.0 x 79.2 | .31 | 7.9 | C4LG6 | 6 | 60 | 120 |
| G4X4LG6 | 4.25 x 4.10 | 108.0 x 104.1 | .31 | 7.9 | C4LG6 | 6 | 60 | 120 |
| G4X5LG6 | 4.25 x 5.10 | 108.0 x 129.5 | .38 | 9.7 | C4LG6 | 6 | 60 | 120 |
| G6X4LG6 | 6.25 x 4.15 | 158.8 x 105.4 | .31 | 7.9 | C6LG6 | 6 | 60 | 120 |

Part number shown for LG (Light Gray). For other color availability see color selection guide, page C1.48.

Base and cover sold separately.

*"H" dimension includes duct and cover.

A.
System
Overview

B1.
Cable Ties

B2.
Cable
Accessories

B3.
Stainless
Steel Ties

C1.
Wiring
Duct

C2.
Surface
Raceway

C3.
Abrasion
Protection

C4.
Cable
Management

D1.
Terminals

D2.
Power
Connectors

D3.
Grounding
Connectors

E1.
Labeling
Systems

E2.
Labels

E3.
Pre-Printed
& Write-On
Markers

E4.
Permanent
Identification

E5.
Lockout/
Tagout
& Safety
Solutions

F.
Index

A. System Overview

Features and Benefits – PANDUCT® Type F Narrow Slot Wiring Duct

B1. Cable Ties

Available in 30 sizes from .5" x .5" up to 4" x 5" in a variety of colors.

B2. Cable Accessories

B3. Stainless Steel Ties

C1. Wiring Duct

C2. Surface Raceway

C3. Abrasion Protection

C4. Cable Management

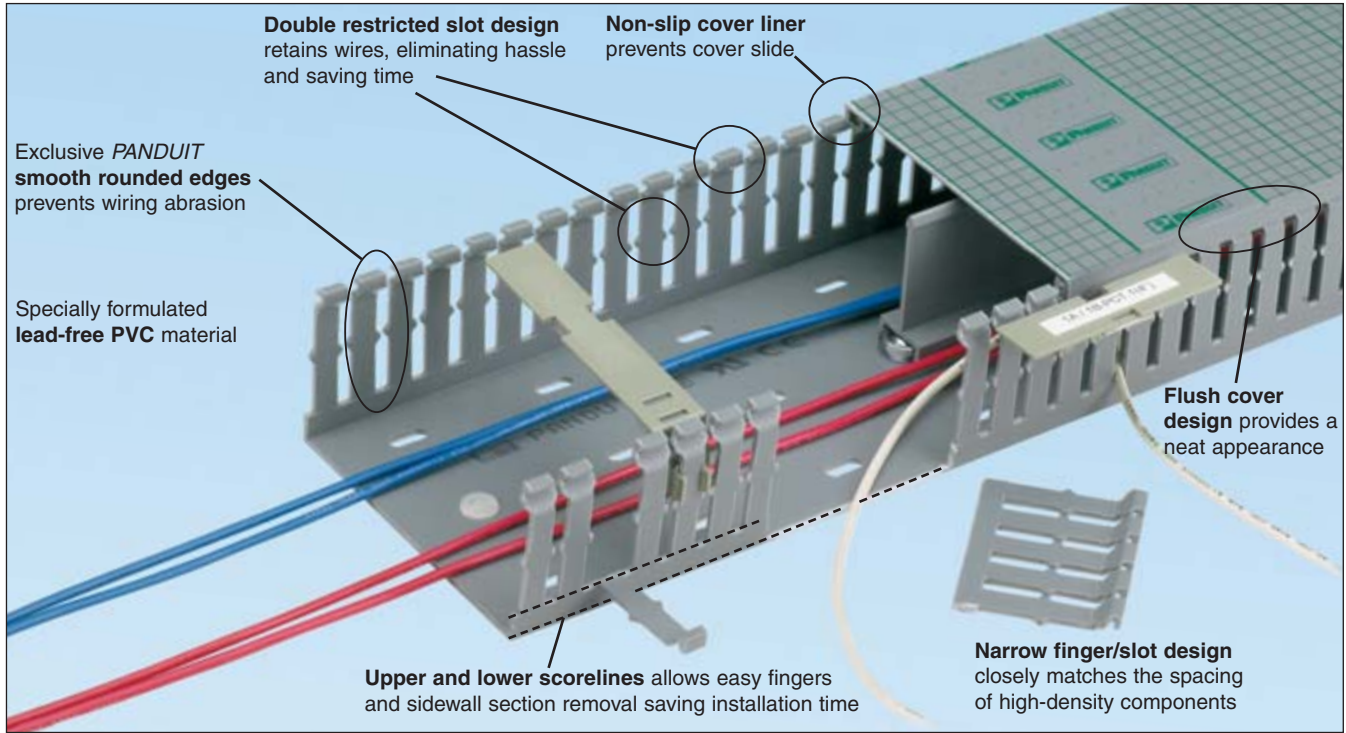

D1. Terminals

D2. Power Connectors

D3. Grounding Connectors

E1. Labeling Systems

E2. Labels

E3. Pre-Printed & Write-On Markers

E4. Permanent Identification

E5. Lockout/Tagout & Safety Solutions

F. Index



PANDUCT® Wire Retainers for Type F Wiring Duct

Contain wiring when duct cover is opened. Wire retainers snap easily between duct fingers. See page C1.28.



PANDUCT® Divider Wall

Create separate wiring channels within the wiring duct base. Available in solid or slotted wall styles. See page C1.26.

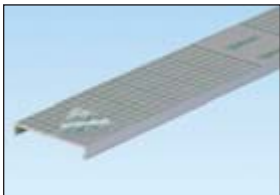

PANDUCT® Type C Cover with Protective Film

Reduces scrap and labor costs by protecting the surface during storage, handling, and installation. See page C1.11.



PANDUCT® Nylon Rivets

Fast, lowest cost mounting method. See page C1.34.



PANDUCT® Installation Tools

Wide selection of hand tools for cutting and installing wiring duct. See page C1.34.

PANDUCT® Type F Narrow Slot Wiring Duct

- Narrow slot/finger design provides more slots to fit the spacing of high-density terminal blocks and other hardware
- Material: Lead-free PVC
- UL recognized continuous use temperature: 122°F (50°C)
- UL 94 flammability rating of V-0
- Conforms with NFPA 79-2007 section 13.3.1 requirement for flame retardant material
- Provided with mounting holes
- Base and cover length is 6 feet

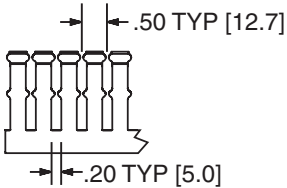
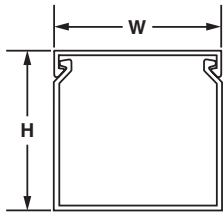
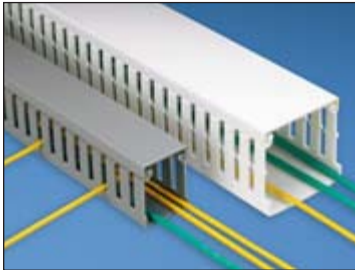

Multiple slot restrictors present with 2" and greater duct wall height.

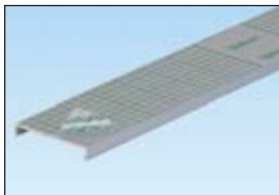

To order cover with protective film add "-F" to part number. 6" cover not available with film.

| Base Part Number | Duct Size (W x H)* | | Slot Width | | Cover Part Number | Std. Pkg. Qty. | Base Ctn. Qty. | Cover Ctn. Qty. |
|------------------|--------------------|---------------|------------|-----|-------------------|----------------|----------------|-----------------|
| | In. | mm | In. | mm | | | | |
| F.5X.5LG6 | .69 x .60 | 17.5 x 15.2 | .20 | 5.0 | C.5LG6 | 6 | 120 | 120 |
| F.5X1LG6 | .69 x 1.06 | 17.5 x 26.9 | .20 | 5.0 | C.5LG6 | 6 | 120 | 120 |
| F.75X.75LG6 | .93 x .82 | 23.6 x 20.9 | .20 | 5.0 | C.75LG6 | 6 | 120 | 120 |
| F.75X1.5LG6 | .93 x 1.57 | 23.6 x 39.9 | .20 | 5.0 | C.75LG6 | 6 | 120 | 120 |
| F1X1LG6 | 1.26 x 1.13 | 32.0 x 28.7 | .20 | 5.0 | C1LG6 | 6 | 120 | 120 |
| F1X1.5LG6 | 1.26 x 1.62 | 32.0 x 41.1 | .20 | 5.0 | C1LG6 | 6 | 120 | 120 |
| F1X2LG6 | 1.26 x 2.12 | 32.0 x 53.8 | .20 | 5.0 | C1LG6 | 6 | 120 | 120 |
| F1X3LG6 | 1.26 x 3.12 | 32.0 x 79.2 | .20 | 5.0 | C1LG6 | 6 | 120 | 120 |
| F1X4LG6 | 1.26 x 4.10 | 32.0 x 104.1 | .20 | 5.0 | C1LG6 | 6 | 60 | 120 |
| F1.5X1LG6 | 1.75 x 1.12 | 44.5 x 28.4 | .20 | 5.0 | C1.5LG6 | 6 | 120 | 120 |
| F1.5X1.5LG6 | 1.75 x 1.62 | 44.5 x 41.1 | .20 | 5.0 | C1.5LG6 | 6 | 120 | 120 |
| F1.5X2LG6 | 1.75 x 2.12 | 44.5 x 53.8 | .20 | 5.0 | C1.5LG6 | 6 | 120 | 120 |
| F1.5X3LG6 | 1.75 x 3.12 | 44.5 x 79.2 | .20 | 5.0 | C1.5LG6 | 6 | 120 | 120 |
| F1.5X4LG6 | 1.75 x 4.10 | 44.5 x 104.1 | .20 | 5.0 | C1.5LG6 | 6 | 60 | 120 |
| F2X1LG6 | 2.25 x 1.12 | 57.2 x 28.4 | .20 | 5.0 | C2LG6 | 6 | 120 | 120 |
| F2X1.5LG6 | 2.25 x 1.62 | 57.2 x 41.1 | .20 | 5.0 | C2LG6 | 6 | 120 | 120 |
| F2X2LG6 | 2.25 x 2.12 | 57.2 x 53.8 | .20 | 5.0 | C2LG6 | 6 | 120 | 120 |
| F2X3LG6 | 2.25 x 3.12 | 57.2 x 79.2 | .20 | 5.0 | C2LG6 | 6 | 60 | 120 |
| F2X4LG6 | 2.25 x 4.10 | 57.2 x 104.1 | .20 | 5.0 | C2LG6 | 6 | 60 | 120 |
| F2X5LG6 | 2.25 x 5.10 | 57.2 x 129.5 | .20 | 5.0 | C2LG6 | 6 | 60 | 120 |
| F2.5X3LG6 | 2.75 x 3.12 | 69.9 x 79.2 | .20 | 5.0 | C2.5LG6 | 6 | 120 | 120 |
| F3X1LG6 | 3.25 x 1.12 | 82.6 x 28.4 | .20 | 5.0 | C3LG6 | 6 | 120 | 120 |
| F3X2LG6 | 3.25 x 2.12 | 82.6 x 53.8 | .20 | 5.0 | C3LG6 | 6 | 120 | 120 |
| F3X3LG6 | 3.25 x 3.12 | 82.6 x 79.2 | .20 | 5.0 | C3LG6 | 6 | 60 | 120 |
| F3X4LG6 | 3.25 x 4.10 | 82.6 x 104.1 | .20 | 5.0 | C3LG6 | 6 | 60 | 120 |
| F3X5LG6 | 3.25 x 5.10 | 82.6 x 129.5 | .20 | 5.0 | C3LG6 | 6 | 60 | 120 |
| F4X2LG6 | 4.25 x 2.12 | 108.0 x 53.8 | .20 | 5.0 | C4LG6 | 6 | 60 | 120 |
| F4X3LG6 | 4.25 x 3.12 | 108.0 x 79.2 | .20 | 5.0 | C4LG6 | 6 | 60 | 120 |
| F4X4LG6 | 4.25 x 4.10 | 108.0 x 104.1 | .20 | 5.0 | C4LG6 | 6 | 60 | 120 |
| F4X5LG6 | 4.25 x 5.10 | 108.0 x 129.5 | .20 | 5.0 | C4LG6 | 6 | 60 | 120 |

Part number shown for LG (Light Gray). For other color availability see color selection guide, page C1.48. Base and cover sold separately.

*"H" dimension includes duct and cover.

A. System Overview

B1. Cable Ties

B2. Cable Accessories

B3. Stainless Steel Ties

C1. Wiring Duct

C2. Surface Raceway

C3. Abrasion Protection

C4. Cable Management

D1. Terminals

D2. Power Connectors

D3. Grounding Connectors

E1. Labeling Systems

E2. Labels

E3. Pre-Printed & Write-On Markers

E4. Permanent Identification

E5. Lockout/Tagout & Safety Solutions

F. Index

A. System Overview

Features and Benefits – *PANDUCT*® Flush Cover Type D Round Hole Wiring Duct

Available in sixteen sizes from 1" x 2" up to 4" x 4" in a variety of colors.

B1. Cable Ties

B2. Cable Accessories

B3. Stainless Steel Ties

C1. Wiring Duct

C2. Surface Raceway

C3. Abrasion Protection

C4. Cable Management

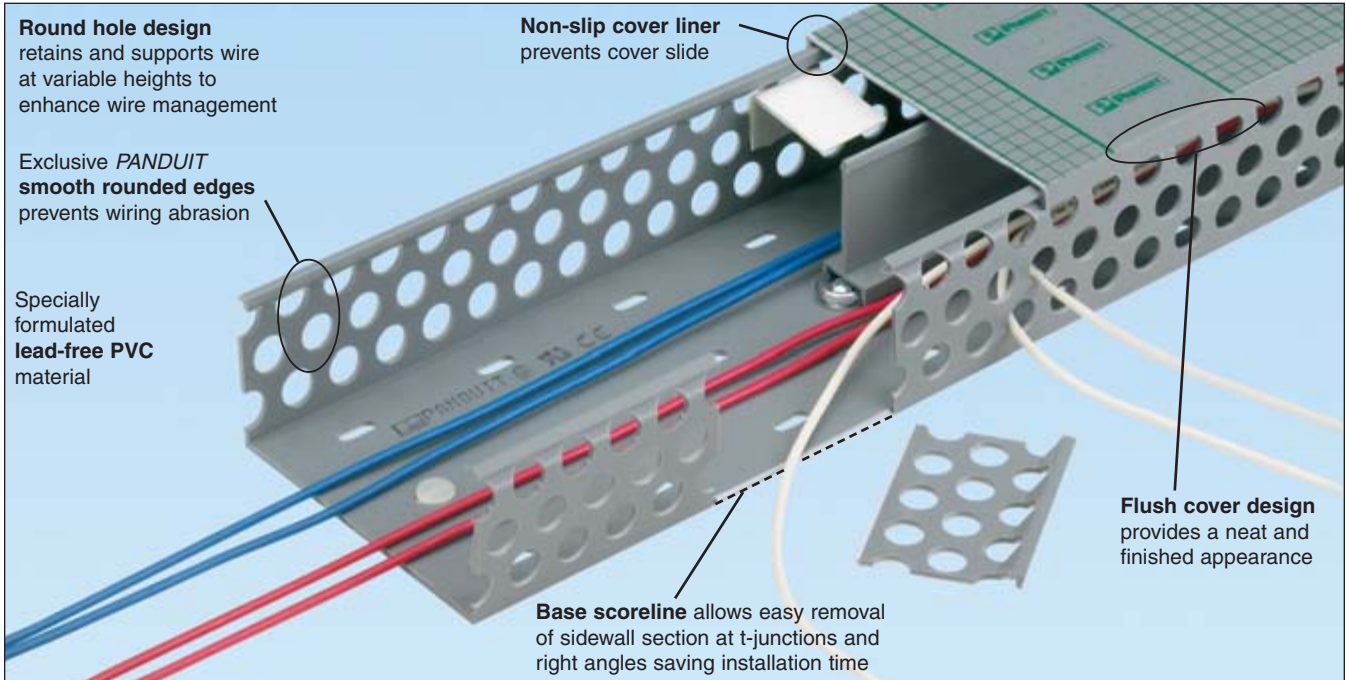

D1. Terminals

D2. Power Connectors

D3. Grounding Connectors

E1. Labeling Systems

E2. Labels

E3. Pre-Printed & Write-On Markers

E4. Permanent Identification

E5. Lockout/Tagout & Safety Solutions

F. Index

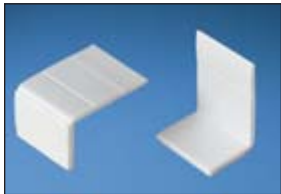

PANDUCT® Wire Retainers for Type D Wiring Duct
Contain wiring when duct cover is opened. Wire retainers mount onto walls with pressure sensitive adhesive. See page C1.28.



PANDUCT® Divider Wall
Create separate wiring channels within the wiring duct base. Available in solid or slotted wall styles. See page C1.26.

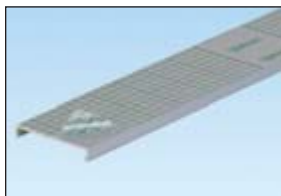

PANDUCT® Type C Cover with Protective Film
Reduces scrap and labor costs by protecting the surface during storage, handling, and installation. See page C1.13.



PANDUCT® Nylon Rivets
Fast, lowest cost mounting method. See page C1.34.



PANDUCT® Installation Tools
Wide selection of hand tools for cutting and installing wiring duct. See page C1.34.

PANDUCT® Flush Cover Type D Round Hole Wiring Duct

- Round hole design has multiple rows of holes to retain and support wire at variable heights and positions
- Material: Lead-free PVC
- UL recognized continuous use temperature: 122°F (50°C)
- UL 94 flammability rating of V-0
- Conforms with NFPA 79-2007 section 13.3.1 requirement for flame retardant material
- Provided with mounting holes
- Base and cover length is 6 feet

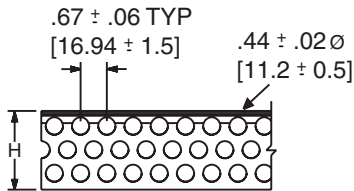
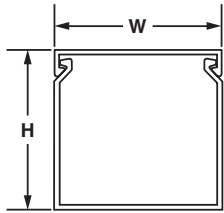
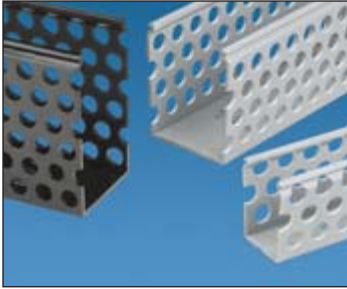

For 2" duct height = 3 rows of holes
 3" duct height = 4 rows of holes
 4" duct height = 6 rows of holes

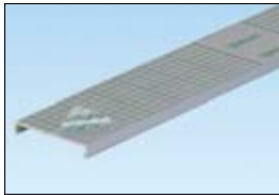

To order cover with protective film add "-F" to part number. 6" cover not available with film.

| Base Part Number | Duct Size (W x H)* | | Cover Part Number | Std. Pkg. Qty. | Base Ctn. Qty. | Cover Ctn. Qty. |
|------------------|--------------------|---------------|-------------------|----------------|----------------|-----------------|
| | In. | mm | | | | |
| D1X2LG6 | 1.26 x 2.12 | 32.0 x 53.8 | C1LG6 | 6 | 120 | 120 |
| D1X3LG6 | 1.26 x 3.12 | 32.0 x 79.2 | C1LG6 | 6 | 120 | 120 |
| D1X4LG6 | 1.26 x 4.10 | 32.0 x 104.1 | C1LG6 | 6 | 120 | 120 |
| D1.5X2LG6 | 1.75 x 2.12 | 44.5 x 53.8 | C1.5LG6 | 6 | 120 | 120 |
| D1.5X3LG6 | 1.75 x 3.12 | 44.5 x 79.2 | C1.5LG6 | 6 | 120 | 120 |
| D1.5X4LG6 | 1.75 x 4.10 | 44.5 x 104.1 | C1.5LG6 | 6 | 60 | 120 |
| D2X2LG6 | 2.25 x 2.12 | 57.2 x 53.8 | C2LG6 | 6 | 120 | 120 |
| D2X3LG6 | 2.25 x 3.12 | 57.2 x 79.2 | C2LG6 | 6 | 60 | 120 |
| D2X4LG6 | 2.25 x 4.10 | 57.2 x 104.1 | C2LG6 | 6 | 60 | 120 |
| D2.5X3LG6 | 2.75 x 3.12 | 69.9 x 79.2 | C2.5LG6 | 6 | 120 | 120 |
| D3X2LG6 | 3.25 x 2.12 | 82.6 x 53.8 | C3LG6 | 6 | 120 | 120 |
| D3X3LG6 | 3.25 x 3.12 | 82.6 x 79.2 | C3LG6 | 6 | 60 | 120 |
| D3X4LG6 | 3.25 x 4.10 | 82.6 x 104.1 | C3LG6 | 6 | 60 | 120 |
| D4X2LG6 | 4.25 x 2.12 | 108.0 x 53.8 | C4LG6 | 6 | 60 | 120 |
| D4X3LG6 | 4.25 x 3.12 | 108.0 x 79.2 | C4LG6 | 6 | 60 | 120 |
| D4X4LG6 | 4.25 x 4.10 | 108.0 x 104.1 | C4LG6 | 6 | 60 | 120 |

Part number shown for LG (Light Gray). For other color availability see color selection guide, page C1.48.
 Base and cover sold separately.
 **"H" dimension includes duct and cover.

A. System Overview

B1. Cable Ties

B2. Cable Accessories

B3. Stainless Steel Ties

C1. Wiring Duct

C2. Surface Raceway

C3. Abrasion Protection

C4. Cable Management

D1. Terminals

D2. Power Connectors

D3. Grounding Connectors

E1. Labeling Systems

E2. Labels

E3. Pre-Printed & Write-On Markers

E4. Permanent Identification

E5. Lockout/Tagout & Safety Solutions

F. Index

A. System Overview

Features and Benefits – PANDUCT® Type MC Metric Narrow Slot Wiring Duct

Available in 22 sizes from 25mm x 25mm up to 100mm x 100mm in international gray and white colors.

B1. Cable Ties

B2. Cable Accessories

B3. Stainless Steel Ties

C1. Wiring Duct

C2. Surface Raceway

C3. Abrasion Protection

C4. Cable Management

D1. Terminals

D2. Power Connectors

D3. Grounding Connectors

E1. Labeling Systems

E2. Labels

E3. Pre-Printed & Write-On Markers

E4. Permanent Identification

E5. Lockout/Tagout & Safety Solutions

F. Index

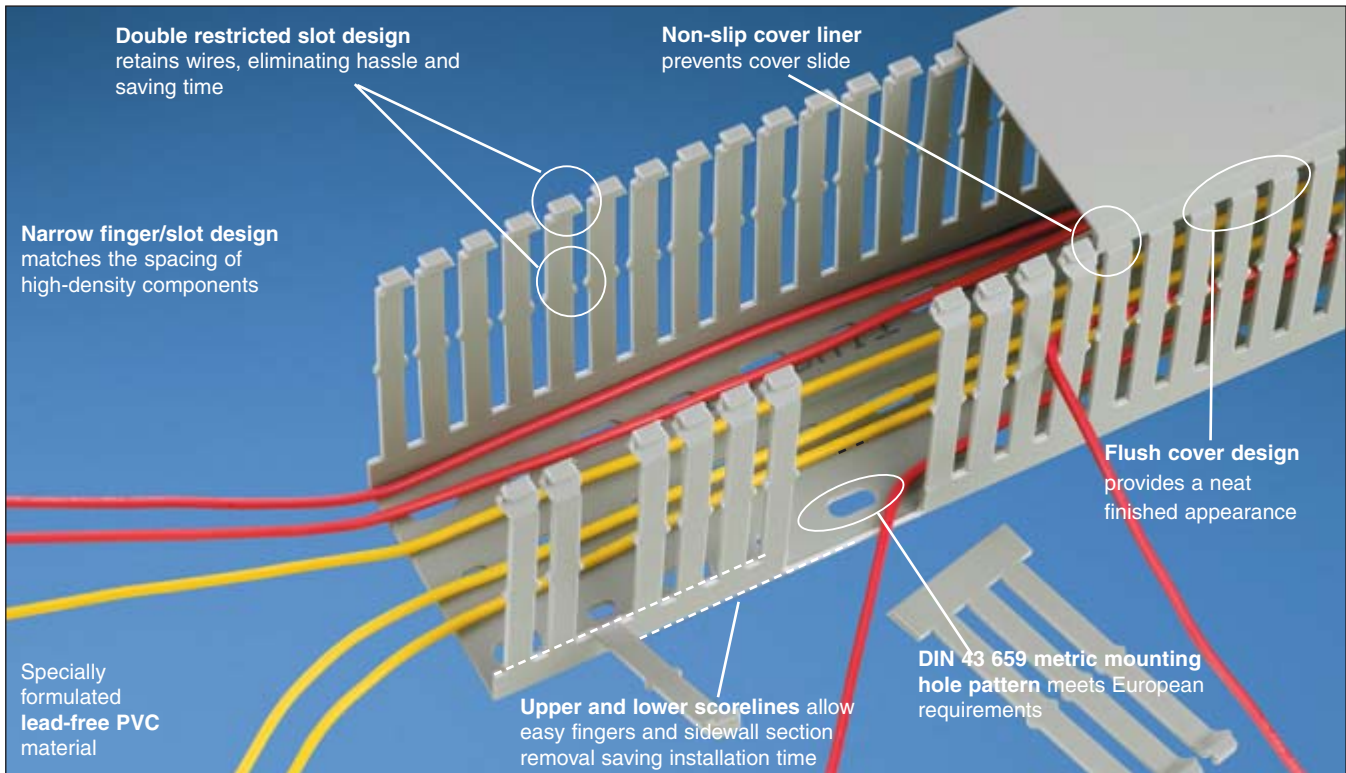

PANDUCT® Wire Retainers for Type MC Wiring Duct
Contain wiring when duct cover is opened. Wire retainers snap easily between duct fingers. See page C1.28.



PANDUCT® Divider Wall
Create separate wiring channels within the wiring duct base. Available in solid or slotted wall styles. See page C1.26.



PANDUCT® Installation Tools
Wide selection of hand tools for cutting and installing wiring duct. See page C1.34.



PANDUCT® Nylon Rivets
Fast, lowest cost mounting method. See page C1.34.

PANDUCT® Type MC Metric Narrow Slot Wiring Duct

- CE compliant and metric sizing for control panels intended for European applications
- Material: Lead-free PVC
- UL recognized continuous use temperature: 122°F (50°C)
- UL 94 flammability rating of V-0
- Conforms with NFPA 79-2007 section 13.3.1 requirement for flame retardant material
- Provided with DIN 43 659 mounting holes
- Duct and cover packaged together in 2m lengths

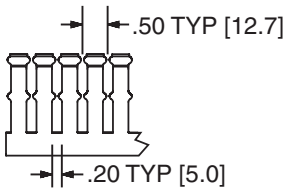
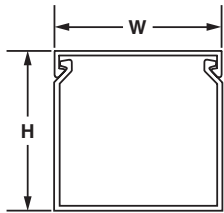
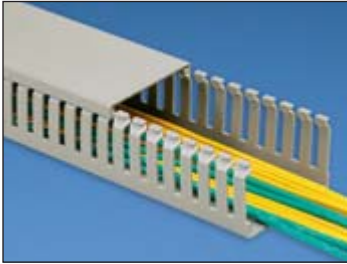

Multiple slot restrictors present with 62mm and greater duct wall height.

| Base and Cover Part Number | Duct Size (W x H)* | | Slot Width | | Replacement Cover Part Number | Base and Cover Pkg. Qty. (m) | Replacement Cover Std. Pkg. Qty. |
|----------------------------|--------------------|-------------|------------|-----|-------------------------------|------------------------------|----------------------------------|
| | mm | In. | In. | mm | | | |
| MC25X25IG2 | 24.6 x 23.6 | .97 x .93 | .20 | 5.0 | C25IG2 | 20 | 20 |
| MC25X37IG2 | 24.6 x 35.8 | .97 x 1.41 | .20 | 5.0 | C25IG2 | 20 | 20 |
| MC25X50IG2 | 24.6 x 47.8 | .97 x 1.88 | .20 | 5.0 | C25IG2 | 20 | 20 |
| MC25X62IG2 | 24.6 x 59.7 | .97 x 2.35 | .20 | 5.0 | C25IG2 | 20 | 20 |
| MC25X75IG2 | 24.6 x 72.4 | .97 x 2.85 | .20 | 5.0 | C25IG2 | 20 | 20 |
| MC37X37IG2 | 37.1 x 35.8 | 1.46 x 1.41 | .20 | 5.0 | C37IG2 | 20 | 20 |
| MC37X50IG2 | 37.1 x 47.8 | 1.46 x 1.88 | .20 | 5.0 | C37IG2 | 20 | 20 |
| MC37X62IG2 | 37.1 x 59.7 | 1.46 x 2.35 | .20 | 5.0 | C37IG2 | 20 | 20 |
| MC37X75IG2 | 37.1 x 72.4 | 1.46 x 2.85 | .20 | 5.0 | C37IG2 | 20 | 20 |
| MC50X50IG2 | 49.5 x 47.8 | 1.95 x 1.89 | .20 | 5.0 | C50IG2 | 20 | 20 |
| MC50X75IG2 | 49.5 x 72.4 | 1.95 x 2.85 | .20 | 5.0 | C50IG2 | 10 | 20 |
| MC50X100IG2 | 49.5 x 97.8 | 1.95 x 3.85 | .20 | 5.0 | C50IG2 | 10 | 20 |
| MC62X37IG2 | 62.0 x 35.8 | 2.44 x 1.41 | .20 | 5.0 | C62IG2 | 20 | 20 |
| MC62X62IG2 | 62.0 x 59.7 | 2.44 x 2.35 | .20 | 5.0 | C62IG2 | 20 | 20 |
| MC75X50IG2 | 74.7 x 48.0 | 2.94 x 1.89 | .20 | 5.0 | C75IG2 | 20 | 20 |
| MC75X62IG2 | 74.7 x 59.7 | 2.94 x 2.35 | .20 | 5.0 | C75IG2 | 20 | 20 |
| MC75X75IG2 | 74.7 x 72.4 | 2.94 x 2.85 | .20 | 5.0 | C75IG2 | 10 | 20 |
| MC75X100IG2 | 74.7 x 97.8 | 2.94 x 3.85 | .20 | 5.0 | C75IG2 | 10 | 20 |
| MC100X50IG2 | 99.6 x 48.0 | 3.92 x 1.89 | .20 | 5.0 | C100IG2 | 10 | 20 |
| MC100X62IG2 | 99.6 x 59.7 | 3.92 x 2.35 | .20 | 5.0 | C100IG2 | 10 | 20 |
| MC100X75IG2 | 99.6 x 72.4 | 3.92 x 2.85 | .20 | 5.0 | C100IG2 | 10 | 20 |
| MC100X100IG2 | 99.6 x 97.8 | 3.92 x 3.85 | .20 | 5.0 | C100IG2 | 10 | 20 |

Available in IG (International Gray) and WH (White) colors.

Base and cover sold together.

*"H" dimension includes duct and cover.

A.
System
Overview

B1.
Cable Ties

B2.
Cable
Accessories

B3.
Stainless
Steel Ties

C1.
Wiring
Duct

C2.
Surface
Raceway

C3.
Abrasion
Protection

C4.
Cable
Management

D1.
Terminals

D2.
Power
Connectors

D3.
Grounding
Connectors

E1.
Labeling
Systems

E2.
Labels

E3.
Pre-Printed
& Write-On
Markers

E4.
Permanent
Identification

E5.
Lockout/
Tagout
& Safety
Solutions

F.
Index

A. System Overview

Features and Benefits – *PANDUCT*® Type FS Solid Wall Raceway

Available in 27 sizes from .5" x .5" up to 6" x 4" in a variety of colors.

B1. Cable Ties

B2. Cable Accessories

B3. Stainless Steel Ties

C1. Wiring Duct

C2. Surface Raceway

C3. Abrasion Protection

C4. Cable Management

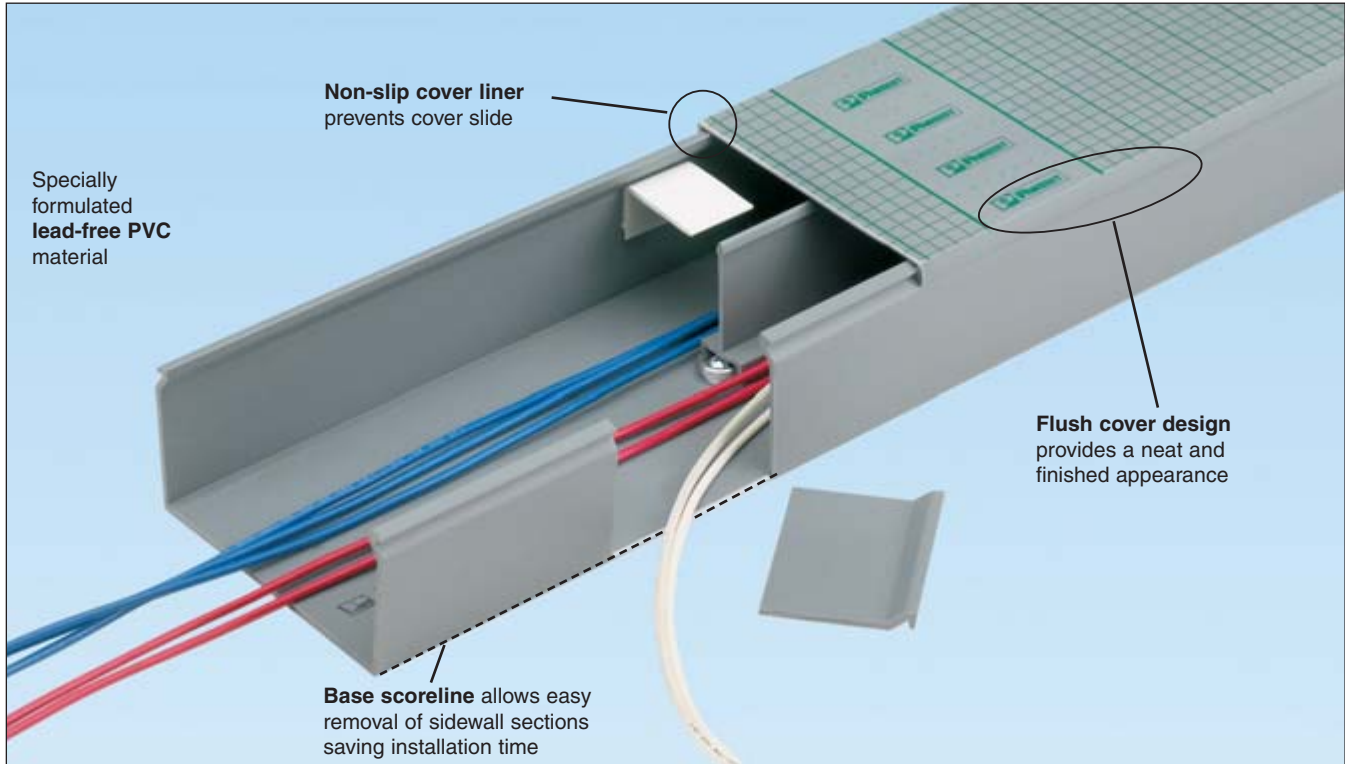

D1. Terminals

D2. Power Connectors

D3. Grounding Connectors

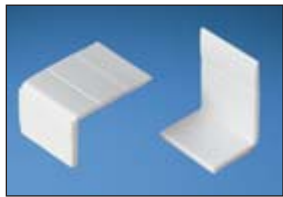

***PANDUCT*® Wire Retainers for Type FS Solid Wall Raceway**
Contain wiring when duct cover is opened. Wire retainers mounts onto walls with pressure sensitive adhesive. See page C1.28.



***PANDUCT*® Divider Wall**
Create separate wiring channels within the wiring duct base. Available in solid or slotted wall styles. See page C1.26.

E1. Labeling Systems

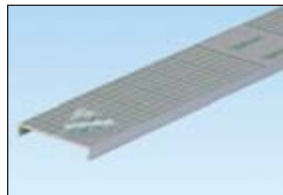

***PANDUCT*® Type C Cover with Protective Film**
Reduces scrap and labor costs by protecting the surface during storage, handling, and installation. See page C1.17.



***PANDUCT*® Nylon Rivets**
Fast, lowest cost mounting method. See page C1.34.

E3. Pre-Printed & Write-On Markers

E4. Permanent Identification



***PANDUCT*® Installation Tools**
Wide selection of hand tools for cutting and installing wiring duct. See page C1.34.

E5. Lockout/Tagout & Safety Solutions

F. Index

PANDUCT® Type FS Solid Wall Raceway

- Solid wall design fully encloses cables providing maximum protection and aesthetics
- Material: Lead-free PVC

- UL recognized continuous use temperature: 122°F (50°C)
- UL 94 flammability rating of V-0
- Base and cover length is 6 feet

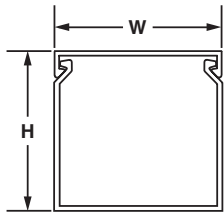

| Base Part Number | Duct Size (W x H)* | | Cover Part Number | Std. Pkg. Qty. | Base Ctn. Qty. | Cover Ctn. Qty. |
|------------------|--------------------|---------------|-------------------|----------------|----------------|-----------------|
| | In. | mm | | | | |
| > FS.5X.5LG6NM | .69 x .60 | 17.5 x 15.2 | C.5LG6 | 6 | 120 | 120 |
| > FS.5X1LG6NM | .69 x 1.06 | 17.5 x 26.9 | C.5LG6 | 6 | 120 | 120 |
| > FS.75X.75LG6NM | .93 x .82 | 23.6 x 20.8 | C.75LG6 | 6 | 120 | 120 |
| > FS1X1LG6NM | 1.26 x 1.12 | 32.0 x 28.4 | C1LG6 | 6 | 120 | 120 |
| > FS1X1.5LG6NM | 1.26 x 1.62 | 32.0 x 41.1 | C1LG6 | 6 | 120 | 120 |
| > FS1X2LG6NM | 1.26 x 2.12 | 32.0 x 53.8 | C1LG6 | 6 | 120 | 120 |
| > FS1X3LG6NM | 1.26 x 3.12 | 32.0 x 79.2 | C1LG6 | 6 | 120 | 120 |
| > FS1X4LG6NM | 1.26 x 4.10 | 32.0 x 104.1 | C1LG6 | 6 | 60 | 120 |
| > FS1.5X1LG6NM | 1.75 x 1.12 | 44.5 x 28.4 | C1.5LG6 | 6 | 120 | 120 |
| > FS1.5X1.5LG6NM | 1.75 x 1.62 | 44.5 x 41.1 | C1.5LG6 | 6 | 120 | 120 |
| > FS1.5X2LG6NM | 1.75 x 2.12 | 44.5 x 53.8 | C1.5LG6 | 6 | 120 | 120 |
| > FS1.5X3LG6NM | 1.75 x 3.12 | 44.5 x 79.2 | C1.5LG6 | 6 | 120 | 120 |
| > FS2X1LG6NM | 2.25 x 1.12 | 57.2 x 28.4 | C2LG6 | 6 | 120 | 120 |
| > FS2X1.5LG6NM | 2.25 x 1.62 | 57.2 x 41.1 | C2LG6 | 6 | 120 | 120 |
| > FS2X2LG6NM | 2.25 x 2.12 | 57.2 x 53.8 | C2LG6 | 6 | 120 | 120 |
| > FS2X3LG6NM | 2.25 x 3.12 | 57.2 x 79.2 | C2LG6 | 6 | 60 | 120 |
| > FS2X4LG6NM | 2.25 x 4.10 | 57.2 x 104.1 | C2LG6 | 6 | 60 | 120 |
| > FS3X1LG6NM | 3.25 x 1.12 | 82.6 x 28.4 | C3LG6 | 6 | 120 | 120 |
| > FS3X2LG6NM | 3.25 x 2.12 | 82.6 x 53.8 | C3LG6 | 6 | 120 | 120 |
| > FS3X3LG6NM | 3.25 x 3.12 | 82.6 x 79.2 | C3LG6 | 6 | 60 | 120 |
| > FS3X4LG6NM | 3.25 x 4.10 | 82.6 x 104.1 | C3LG6 | 6 | 60 | 120 |
| > FS3X5LG6NM | 3.25 x 5.10 | 82.6 x 129.5 | C3LG6 | 6 | 60 | 120 |
| > FS4X2LG6NM | 4.25 x 2.12 | 108.0 x 53.8 | C4LG6 | 6 | 60 | 120 |
| > FS4X3LG6NM | 4.25 x 3.12 | 108.0 x 79.2 | C4LG6 | 6 | 60 | 120 |
| > FS4X4LG6NM | 4.25 x 4.10 | 108.0 x 104.1 | C4LG6 | 6 | 60 | 120 |
| > FS4X5LG6NM | 4.25 x 5.10 | 108.0 x 129.5 | C4LG6 | 6 | 60 | 120 |
| > FS6X4LG6NM | 6.25 x 4.15 | 158.8 x 105.4 | C6LG6 | 6 | 60 | 120 |

>Indicates parts available with mounting holes. Remove NM from part number.

Part Number shown for LG (Light Gray). For other color availability see Color Selection Guide, page C1.48.

Base and cover sold separately.

*"H" dimension includes duct and cover.

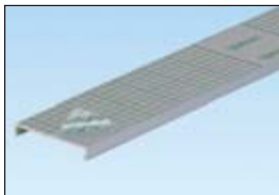

To order cover with protective film add "-F" to part number. 6" cover not available with film.

A.
System
Overview

B1.
Cable Ties

B2.
Cable
Accessories

B3.
Stainless
Steel Ties

C1.
Wiring
Duct

C2.
Surface
Raceway

C3.
Abrasion
Protection

C4.
Cable
Management

D1.
Terminals

D2.
Power
Connectors

D3.
Grounding
Connectors

E1.
Labeling
Systems

E2.
Labels

E3.
Pre-Printed
& Write-On
Markers

E4.
Permanent
Identification

E5.
Lockout/
Tagout/
& Safety
Solutions

F.
Index

A.
System
Overview

Wiring Duct for Special Environments

B1.
Cable Ties

Type NNC Halogen-Free Metric Wiring Duct

B2.
Cable
Accessories

B3.
Stainless
Steel Ties

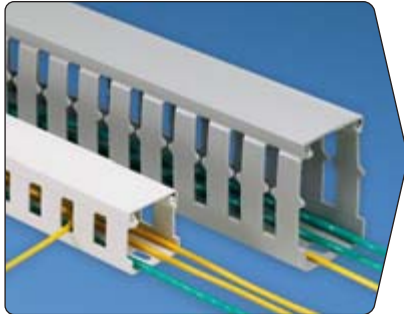

- Halogen-free material is nontoxic, lead-free, environmentally safe and will not release toxic or corrosive gases that could endanger public safety or damage sensitive electronic equipment
- UL 94V-0

C1.
Wiring
Duct

C2.
Surface
Raceway

Type NE NORYL* Halogen-Free Wiring Duct

C3.
Abrasion
Protection

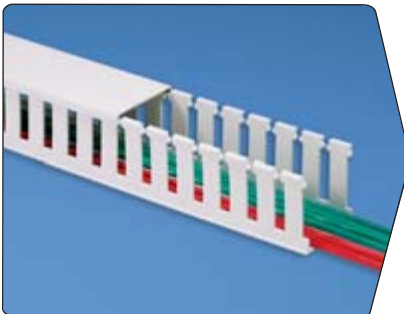

- Halogen-free material is non-toxic, lead-free, environmentally safe and will not release toxic or corrosive gases that could endanger public safety or damage sensitive electronic equipment
- UL 94V-1

C4.
Cable
Management

D1.
Terminals

D2.
Power
Connectors

Type TMC Low Smoke/Low Toxicity Wiring Duct

D3.
Grounding
Connectors

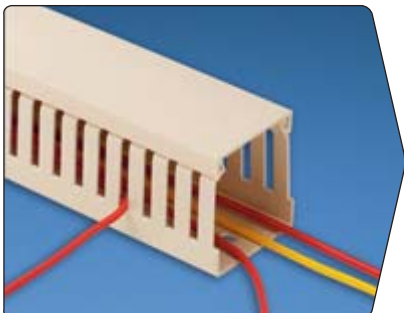

- Low smoke/low toxicity material emits a low level of toxic fumes and low smoke emissions when burned
- Performs to global mass transit rail standards:
 - U.S. Federal Rail Administration Guidelines and NFPA 130 requirements
 - French AFNOR NFF 16 101, 16 102 (I1, F1 classification at 2.1mm thickness)
 - German DIN 5510-2 (S4, SR2, ST2 classification)
 - UNIFER Italian Railway Flammability standard EN UNI11925-2
- UL 94V-0

E1.
Labeling
Systems

E2.
Labels

E3.
Pre-Printed
& Write-On
Markers

E4.
Permanent
Identification

E5.
Lockout/
Tagout/
& Safety
Solutions

F.
Index



The material is self-extinguishing and has excellent flame retardancy UL 94V-0.



The material does not release dense smoke when burned per ASTM E662 test method.



The material does not emit a high volume of toxic gases when burned per Boeing and Airbus test methods.

*NORYL is a registered trademark of General Electric Company.

Environment/Material Specifications **Typical Applications** **pages C1.20 – C1.21**



Semiconductor Manufacturing
Ship Building
Nuclear Power Plants
Oil Platforms

Environment/Material Specifications **Typical Applications** **page C1.24**



Semiconductor Manufacturing
Ship Building
Nuclear Power Plants
Oil Platforms

Environment/Material Specifications **Typical Applications** **pages C1.22 – C1.23**



Passenger Rail Cars; Rail Stations
Other Transportation Vehicles



The material contains no fluorine, bromide, or chlorine and will not emit any corrosive or toxic gases when burned per IEC 60754-2 test method.



Material is rated for a continuous use temperature above 75°C (167°F).

A.
System
Overview

B1.
Cable Ties

B2.
Cable
Accessories

B3.
Stainless
Steel Ties

C1.
Wiring
Duct

C2.
Surface
Raceway

C3.
Abrasion
Protection

C4.
Cable
Management

D1.
Terminals

D2.
Power
Connectors

D3.
Grounding
Connectors

E1.
Labeling
Systems

E2.
Labels

E3.
Pre-Printed
& Write-On
Markers

E4.
Permanent
Identification

E5.
Lockout/
Tagout
& Safety
Solutions

F.
Index

A. System Overview

Features and Benefits – PANDUCT® Type NNC Halogen-Free Metric Wiring Duct

Available in fourteen sizes from 25mm x 25mm up to 100mm x 100mm in light gray and white.

B1. Cable Ties

B2. Cable Accessories

B3. Stainless Steel Ties

C1. Wiring Duct

C2. Surface Raceway

C3. Abrasion Protection

C4. Cable Management

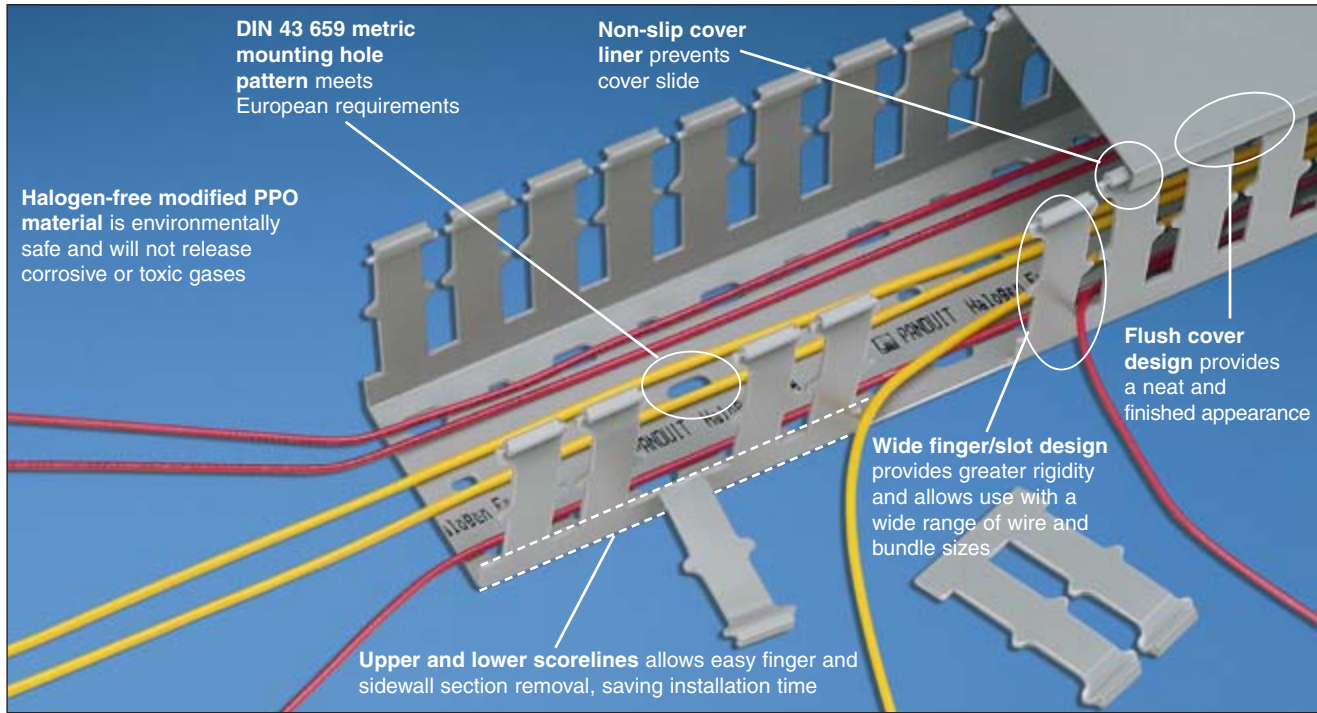

D1. Terminals

D2. Power Connectors

D3. Grounding Connectors

E1. Labeling Systems

E2. Labels

E3. Pre-Printed & Write-On Markers

E4. Permanent Identification

E5. Lockout/Tagout & Safety Solutions

F. Index



PANDUCT® Type NNC Halogen-Free Solid Divider Wall
Create separate wiring channels within the wiring duct base.
See page C1.21.



PANDUCT® Nylon Rivets
Fast, lowest cost mounting method.
See page C1.34.



PANDUCT® Installation Tools
Wide selection of hand tools for cutting and installing wiring duct.
See page C1.34.

PANDUCT® Type NNC Halogen-Free Metric Wiring Duct

- Material: Halogen-free modified PPO material as verified with IEC 60754-2 test method (test on gases evolved during combustion of electric cables)
- UL recognized continuous use temperature: 203°F (95°C)
- UL 94 flammability rating of V-0
- Conforms with NFPA 79-2007 section 13.3.1 requirement for flame retardant material
- Provided with DIN 43 659 mounting holes
- Metric sizing and finger progression
- Duct and cover packaged together in 2m lengths

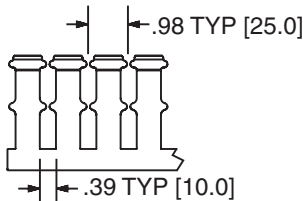
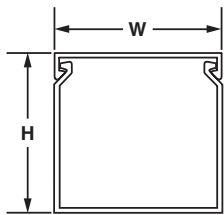
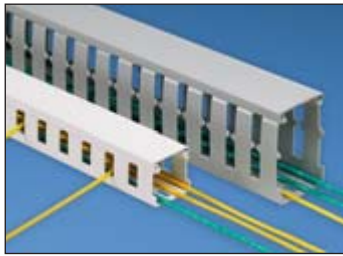

Multiple slot restrictors present with 75mm and greater duct wall height.

| Base and Cover Part Number | Duct Size (W x H)* | | Slot Width | | Replacement Cover Part Number | Base and Cover Ctn. Qty. (m) | Replacement Cover Ctn. Qty. (m) |
|----------------------------|--------------------|-------------|------------|------|-------------------------------|------------------------------|---------------------------------|
| | mm | In. | In. | mm | | | |
| NNC25X25LG2 | 24.6 x 23.6 | .97 x .93 | .39 | 10.0 | NC25LG2 | 20 | 20 |
| NNC25X37LG2 | 24.6 x 35.8 | .97 x 1.41 | .39 | 10.0 | NC25LG2 | 20 | 20 |
| NNC25X50LG2 | 24.6 x 47.8 | .97 x 1.88 | .39 | 10.0 | NC25LG2 | 20 | 20 |
| NNC25X75LG2 | 24.6 x 72.4 | .97 x 2.85 | .39 | 10.0 | NC25LG2 | 20 | 20 |
| NNC37X37LG2 | 37.1 x 35.8 | 1.46 x 1.41 | .39 | 10.0 | NC37LG2 | 20 | 20 |
| NNC37X50LG2 | 37.1 x 47.8 | 1.46 x 1.88 | .39 | 10.0 | NC37LG2 | 20 | 20 |
| NNC37X75LG2 | 37.1 x 72.4 | 1.46 x 2.85 | .39 | 10.0 | NC37LG2 | 20 | 20 |
| NNC50X50LG2 | 49.5 x 47.8 | 1.95 x 1.88 | .39 | 10.0 | NC50LG2 | 20 | 20 |
| NNC50X75LG2 | 49.5 x 72.4 | 1.95 x 2.85 | .39 | 10.0 | NC50LG2 | 10 | 20 |
| NNC50X100LG2 | 49.5 x 97.8 | 1.95 x 3.85 | .39 | 10.0 | NC50LG2 | 10 | 20 |
| NNC75X75LG2 | 74.7 x 72.4 | 2.94 x 2.85 | .39 | 10.0 | NC75LG2 | 10 | 20 |
| NNC100X50LG2 | 99.6 x 47.8 | 3.92 x 1.88 | .39 | 10.0 | NC100LG2 | 10 | 20 |
| NNC100X75LG2 | 99.6 x 72.4 | 3.92 x 2.85 | .39 | 10.0 | NC100LG2 | 10 | 20 |
| NNC100X100LG2 | 99.6 x 97.8 | 3.92 x 3.85 | .39 | 10.0 | NC100LG2 | 10 | 20 |

Available in LG (Light Gray) and WH (White).

Do not allow cutting, tapping, or cleaning fluids that contain hydrocarbons to come in contact with type NNC wiring duct as it will cause stress cracking. See page C1.47 for a list of chemicals to avoid.

*"H" dimension includes duct and cover.

PANDUCT® Type NNC Divider Wall

- NNC solid divider wall can be mounted inside NNC and NE wiring duct to create multiple channels
- Material: Halogen-free modified PPO
- Simply install the divider wall base when mounting the duct and snap the divider wall onto mounting base, DB-C



| Part Number | Length (m) | For Nominal Duct Height (mm) | Std. Pkg. Qty. | Std. Ctn. Qty. (m) |
|-------------|------------|------------------------------|----------------|--------------------|
| NNC50DWH2 | 2 | 50 | 2 | 40 |
| NNC75DWH2 | 2 | 75 | 2 | 40 |

Available in WH (White) color only.

Note: Must be used with mounting base, DB-C (see page C1.26) which is sold separately. Install mounting bases to the duct channel, locate within 2" of each divider wall end and at least 12" along the length.

A. System Overview

B1. Cable Ties

B2. Cable Accessories

B3. Stainless Steel Ties

C1. Wiring Duct

C2. Surface Raceway

C3. Abrasion Protection

C4. Cable Management

D1. Terminals

D2. Power Connectors

D3. Grounding Connectors

E1. Labeling Systems

E2. Labels

E3. Pre-Printed & Write-On Markers

E4. Permanent Identification

E5. Lockout/Tagout & Safety Solutions

F. Index

A. System Overview

Features and Benefits – PANDUCT® Type TMC Low Smoke/Low Toxicity Wiring Duct

Available in seven sizes from 25mm x 37mm up to 100mm x 75mm in Beige color.

B1. Cable Ties

B2. Cable Accessories

B3. Stainless Steel Ties

C1. Wiring Duct

C2. Surface Raceway

C3. Abrasion Protection

C4. Cable Management

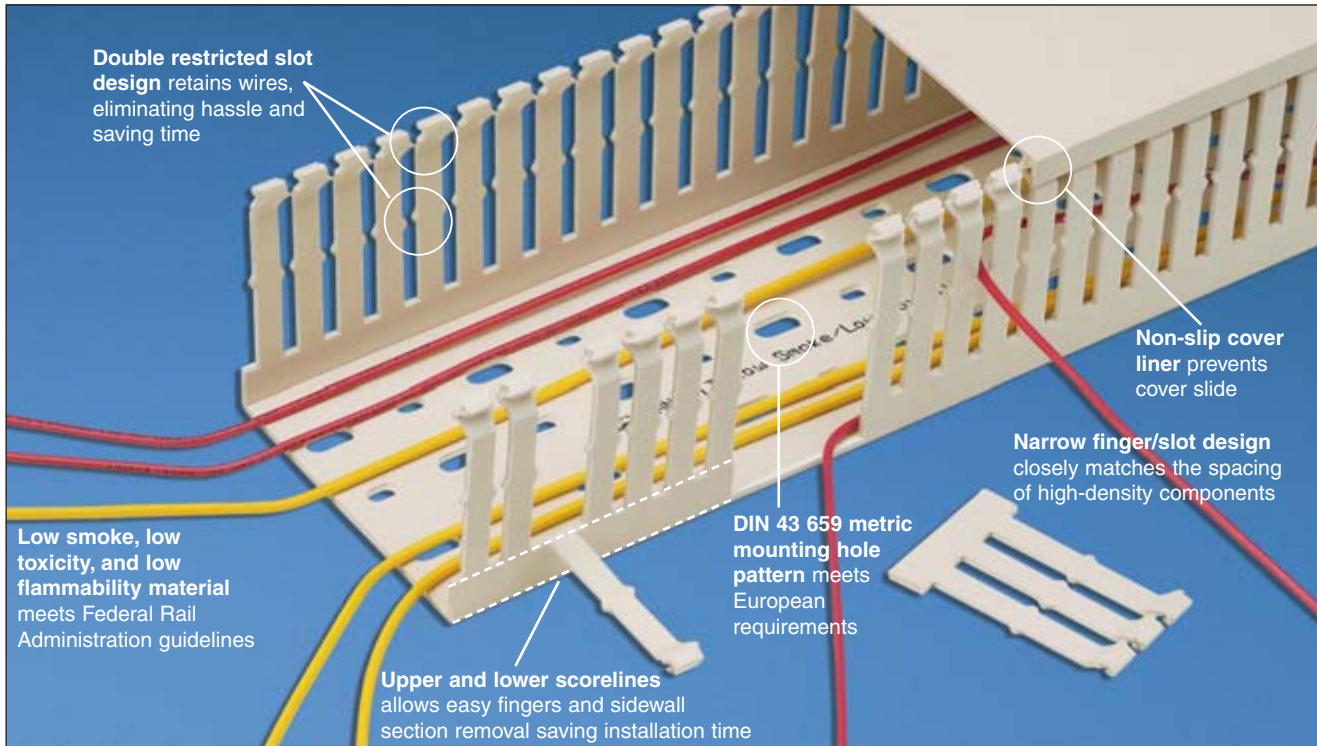

D1. Terminals

D2. Power Connectors

D3. Grounding Connectors



PANDUCT® Wire Retainers for Type TMC Wiring Duct

Contain wiring when duct cover is opened. Wire retainers snap easily between duct fingers. See page C1.28.



PANDUCT® Type TMC Low Smoke/Low Toxicity Solid Divider Wall

Create separate wiring channels within the wiring duct base. See page C1.23.

E1. Labeling Systems



PANDUCT® Installation Tools

Wide selection of hand tools for cutting and installing wiring duct. See page C1.34.



PANDUCT® Nylon Rivets

Fast, lowest cost mounting method. See page C1.34.

E2. Labels

E3. Pre-Printed & Write-On Markers

E4. Permanent Identification

E5. Lockout/Tagout & Safety Solutions

F. Index

PANDUIT® Type TMC Low Smoke/Low Toxicity Wiring Duct

- Material: low smoke, low toxicity, and low flammability thermoplastic
- UL recognized continuous use temperature: 176°F (80°C)
- UL 94 flammability rating of V-0
- Conforms with NFPA 79-2007 section 13.3.1 requirement for flame retardant material
- Provided with DIN 43 659 mounting holes
- Metric sizing and finger progression
- Duct and cover packaged together in 2m lengths

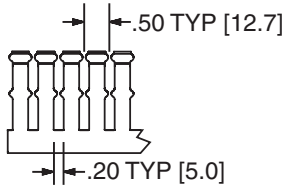
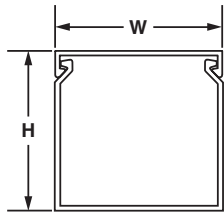
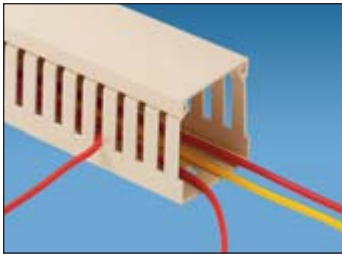

Multiple slot restrictors present with 75mm and greater duct wall height.

| Base and Cover Part Number | Duct Size W x H* | | Slot Width | | Replacement Cover Part Number | Base and Cover Ctn. Qty. (m) | Replacement Cover Ctn. Qty. (m) |
|----------------------------|------------------|-------------|------------|-----|-------------------------------|------------------------------|---------------------------------|
| | In. | mm | In. | mm | | | |
| TMC25X37BR2 | .97 x 1.41 | 24.6 x 35.8 | .20 | 5.0 | TC25BR2 | 20 | 20 |
| TMC37X37BR2 | 1.46 x 1.41 | 37.1 x 35.8 | .20 | 5.0 | TC37BR2 | 20 | 20 |
| TMC50X50BR2 | 1.95 x 1.89 | 49.5 x 48.0 | .20 | 5.0 | TC50BR2 | 20 | 20 |
| TMC75X50BR2 | 2.94 x 1.89 | 74.7 x 48.0 | .20 | 5.0 | TC75BR2 | 20 | 20 |
| TMC75X75BR2 | 2.94 x 2.88 | 74.7 x 73.2 | .20 | 5.0 | TC75BR2 | 10 | 20 |
| TMC100X50BR2 | 3.92 x 1.89 | 99.6 x 48.0 | .20 | 5.0 | TC100BR2 | 10 | 20 |
| TMC100X75BR2 | 3.92 x 2.88 | 99.6 x 73.2 | .20 | 5.0 | TC100BR2 | 10 | 20 |

Available in BR (Natural Beige) color only.
*“H” dimension includes duct and cover.

PANDUIT® Type TMC Low Smoke/Low Toxicity Solid Divider Wall

- Wiring duct divider wall can be mounted inside any type of PANDUIT PVC wiring duct to create multiple channels
- Simply install the divider wall base when mounting the duct and snap the divider wall onto the mounting base
- All versions snap onto DB-C mounting base
- Divider wall heights 2 inches and greater have a scoreline feature allowing sections to be removed leaving a smooth edge
- Meets UL 508/508A insulation material requirement for barrier between conductors
- UL 94 flammability rating of V-0
- Material: Lead-free PVC



| Part Number | For Nominal Duct Height (mm) | Length (m) | Std. Pkg. Qty. | Std. Ctn. Qty. |
|-------------|------------------------------|------------|----------------|----------------|
| TMC50DW2 | 50 | 2 | 2 | 20 |
| TMC75DW2 | 75 | 2 | 2 | 20 |

Note: Must be used with mounting base, DB-C (see page C1.26) which is sold separately. Install mounting bases to the duct channel, locate within 2" of each divider wall end and at least every 12" along the length.

A. System Overview

B1. Cable Ties

B2. Cable Accessories

B3. Stainless Steel Ties

C1. Wiring Duct

C2. Surface Raceway

C3. Abrasion Protection

C4. Cable Management

D1. Terminals

D2. Power Connectors

D3. Grounding Connectors

E1. Labeling Systems

E2. Labels

E3. Pre-Printed & Write-On Markers

E4. Permanent Identification

E5. Lockout/Tagout & Safety Solutions

F. Index

A. System Overview

PANDUCT® Type NE NORYL** Halogen-Free Wiring Duct

B1. Cable Ties

- Material: Halogen-free NORYL**
- UL recognized continuous use temperature: 203°F (95°C)
- UL 94 flammability rating of V-1
- Provided with mounting holes
- Base and cover length is 6 feet

B2. Cable Accessories



B3. Stainless Steel Ties

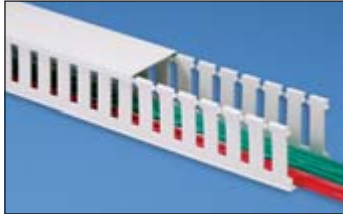

C1. Wiring Duct

C2. Surface Raceway

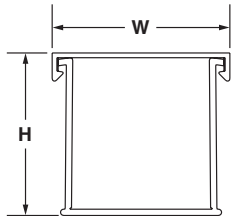

C3. Abrasion Protection

C4. Cable Management

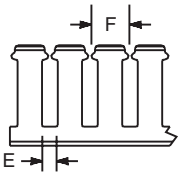

| | E | F |
|-----------------------|------------|--------------|
| For .5" duct height: | .37" [9.4] | .80" [20.3] |
| 1" to 2" duct height: | .31" [7.9] | .80" [20.3] |
| 3" to 4" duct height: | .31" [7.9] | 1.00" [25.4] |
| 5" duct height: | .38" [9.4] | 1.33" [33.8] |

D1. Terminals

D2. Power Connectors

D3. Grounding Connectors

E1. Labeling Systems

E2. Labels

E3. Pre-Printed & Write-On Markers

E4. Permanent Identification

E5. Lockout/Tagout & Safety Solutions

F. Index

| Base Part Number | Duct Size W x H* | | Slot Width | | Cover Part Number | Std. Pkg. Qty. | Base Ctn. Qty. | Cover Ctn. Qty. |
|------------------|------------------|---------------|------------|-----|-------------------|----------------|----------------|-----------------|
| | In. | mm | In. | mm | | | | |
| NE.5X.5WH6 | .63 x .56 | 16.0 x 14.2 | .38 | 9.7 | NC.5WH6 | 6 | 120 | 120 |
| NE.5X1WH6 | .63 x 1.06 | 16.0 x 26.9 | .31 | 7.9 | NC.5WH6 | 6 | 120 | 120 |
| NE1X1WH6 | 1.14 x 1.06 | 29.0 x 26.9 | .31 | 7.9 | NC1WH6 | 6 | 120 | 120 |
| NE1X1.5WH6 | 1.14 x 1.62 | 29.0 x 41.1 | .31 | 7.9 | NC1WH6 | 6 | 120 | 120 |
| NE1X2WH6 | 1.14 x 2.06 | 29.0 x 52.3 | .31 | 7.9 | NC1WH6 | 6 | 120 | 120 |
| NE1X3WH6 | 1.14 x 3.06 | 29.0 x 77.7 | .31 | 7.9 | NC1WH6 | 6 | 120 | 120 |
| NE1X4WH6 | 1.14 x 4.06 | 29.0 x 103.1 | .31 | 7.9 | NC1WH6 | 6 | 60 | 120 |
| NE1.5X1.5WH6 | 1.64 x 1.62 | 41.7 x 41.1 | .31 | 7.9 | NC1.5WH6 | 6 | 120 | 120 |
| NE1.5X2WH6 | 1.64 x 2.06 | 41.7 x 52.3 | .31 | 7.9 | NC1.5WH6 | 6 | 120 | 120 |
| NE1.5X3WH6 | 1.64 x 3.06 | 41.7 x 77.7 | .31 | 7.9 | NC1.5WH6 | 6 | 120 | 120 |
| NE1.5X4WH6 | 1.64 x 4.06 | 41.7 x 103.1 | .31 | 7.9 | NC1.5WH6 | 6 | 60 | 120 |
| NE2X1WH6 | 2.14 x 1.06 | 54.4 x 26.9 | .31 | 7.9 | NC2WH6 | 6 | 120 | 120 |
| NE2X2WH6 | 2.14 x 2.06 | 54.4 x 52.3 | .31 | 7.9 | NC2WH6 | 6 | 120 | 120 |
| NE2X3WH6 | 2.14 x 3.06 | 54.4 x 77.7 | .31 | 7.9 | NC2WH6 | 6 | 60 | 120 |
| NE2X4WH6 | 2.14 x 4.06 | 54.4 x 103.1 | .31 | 7.9 | NC2WH6 | 6 | 60 | 120 |
| NE3X1WH6 | 3.14 x 1.06 | 79.8 x 26.9 | .31 | 7.9 | NC3WH6 | 6 | 120 | 120 |
| NE3X2WH6 | 3.14 x 2.06 | 79.8 x 52.3 | .31 | 7.9 | NC3WH6 | 6 | 120 | 120 |
| NE3X3WH6 | 3.14 x 3.06 | 79.8 x 77.7 | .31 | 7.9 | NC3WH6 | 6 | 60 | 120 |
| NE3X4WH6 | 3.14 x 4.06 | 79.8 x 103.1 | .31 | 7.9 | NC3WH6 | 6 | 60 | 120 |
| NE3X5WH6 | 3.14 x 5.06 | 79.8 x 128.5 | .38 | 9.7 | NC3WH6 | 6 | 60 | 120 |
| NE4X2WH6 | 4.14 x 2.06 | 105.2 x 52.3 | .31 | 7.9 | NC4WH6 | 6 | 60 | 120 |
| NE4X3WH6 | 4.14 x 3.06 | 105.2 x 77.7 | .31 | 7.9 | NC4WH6 | 6 | 60 | 120 |
| NE4X4WH6 | 4.14 x 4.06 | 105.2 x 103.1 | .31 | 7.9 | NC4WH6 | 6 | 60 | 120 |
| NE4X5WH6 | 4.14 x 5.06 | 105.2 x 128.5 | .38 | 9.7 | NC4WH6 | 6 | 60 | 120 |

Available in WH (White) only.

Do not allow cutting, tapping, or cleaning fluids that contain hydrocarbons to come in contact with type NE wiring duct as it will cause stress cracking. See page C1.47 for list of chemicals to avoid.

Base and cover sold separately.

**H" dimension includes duct and cover.

**NORYL is a registered trademark of General Electric Company.

WIRING DUCT TOOLS AND ACCESSORIES

PANDUIT® offers a selection of PANDUCT® Tools and Accessories to aid cutting, modifying, and installing wiring duct.



Some of the features and benefits found in PANDUCT® Tools and Accessories include:

- Wide selection of hand tools for cutting and installing wiring duct
- Snap-in wire retainers to retain cabling when the cover is removed or during cable installation
- Divider walls that mount within the duct enabling multiple channels to be created within a duct channel
- Corner strips hold corners rigid at t-junctions in control panel applications
- Joining strips to connect two sections of duct and hold the walls rigid
- Mounting clips provide an alternative method to mount the duct and allow the duct to be more easily removed

A.
System
Overview

B1.
Cable Ties

B2.
Cable
Accessories

B3.
Stainless
Steel Ties

C1.
Wiring
Duct

C2.
Surface
Raceway

C3.
Abrasion
Protection

C4.
Cable
Management

D1.
Terminals

D2.
Power
Connectors

D3.
Grounding
Connectors

E1.
Labeling
Systems

E2.
Labels

E3.
Pre-Printed
& Write-On
Markers

E4.
Permanent
Identification

E5.
Lockout/
Tagout/
& Safety
Solutions

F.
Index

A. System Overview

PANDUCT® Type FL Flexible Wiring Duct

B1. Cable Ties

- Material: Flexible Polypropylene
- UL 94 flammability rating of V-2
- UL Recognized continuous use temperature: 149°F (65°C)
- Factory applied adhesive tape provided for easy mounting

B2. Cable Accessories



B3. Stainless Steel Ties

| Part Number | Duct Size (W x H)* | | Length | | Std. Pkg. Qty. |
|--------------------|--------------------|-------------|--------|-----|----------------|
| | In. | mm | In. | mm | |
| FL12X12LG-A | .49 x .49 | 12.5 x 12.5 | 19.7 | 500 | 112 |
| FL25X25LG-A | .98 x .98 | 25.0 x 25.0 | 19.7 | 500 | 70 |
| FL50X50LG-A | 1.97 x 1.97 | 50.0 x 50.0 | 19.7 | 500 | 32 |

Available in LG (RAL 7040 Light Gray) color only. Unit of measure is pieces.
**"H" dimension includes duct and cover.

C1. Wiring Duct

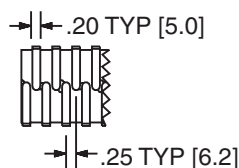
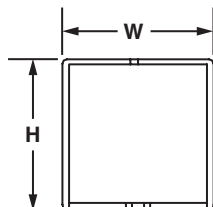

C2. Surface Raceway

PANDUCT® Divider Wall

C3. Abrasion Protection

- Wiring duct divider wall can be mounted inside any type of **PANDUIT** PVC wiring duct to create multiple channels
- Divider wall heights 2 inches and greater have a scoreline feature allowing sections to be removed leaving a smooth edge
- Simply install the divider wall base when mounting the duct and snap the divider wall onto the mounting base
- Meets UL 508/508A insulation material requirement for barrier between conductors
- All versions snap onto DB-C mounting base
- UL 94 flammability rating of V-0
- Material: Lead-free PVC

C4. Cable Management

D1. Terminals



DB-C

| Part Number | Used with Anchors | Std. Pkg. Qty. | Std. Ctn. Qty. |
|--|---------------------------------------|----------------|----------------|
| PANDUCT® Divider Wall Mounting Base | | | |
| DB-C | PANDUIT NR1 or #8 or #10 screw | 100 | 1000 |

D2. Power Connectors

D3. Grounding Connectors



D*H6 and D*H2

| Part Number | For Nominal Duct Height | | Length | | Color | Std. Pkg. Qty. | Std. Ctn. Qty. |
|------------------------------------|-------------------------|-----|--------|---|------------|----------------|----------------|
| | In. | mm | Ft. | m | | | |
| PANDUCT® Solid Divider Wall | | | | | | | |
| D1H6 | 1.00 | 25 | 6 | — | Light Gray | 6 | 120 |
| D1.5H6 | 1.50 | 37 | 6 | — | Light Gray | 6 | 120 |
| D2H6 | 2.00 | 50 | 6 | — | Light Gray | 6 | 120 |
| D3H6 | 3.00 | 75 | 6 | — | Light Gray | 6 | 120 |
| D4H6 | 4.00 | 100 | 6 | — | Light Gray | 6 | 120 |
| D2HWH6 | 2.00 | 50 | 6 | — | White | 6 | 120 |
| D3HWH6 | 3.00 | 75 | 6 | — | White | 6 | 120 |
| D4HWH6 | 4.00 | 100 | 6 | — | White | 6 | 120 |

E1. Labeling Systems

E2. Labels

E3. Pre-Printed & Write-On Markers



SD*H6

| Part Number | In. | mm | — | 2 | Color | Std. Pkg. Qty. | Std. Ctn. Qty. |
|---|------|-----|---|---|--------------------|----------------|----------------|
| PANDUCT® Metric Solid Divider Wall | | | | | | | |
| D50H2 | 2.00 | 50 | — | 2 | International Gray | 2 | 40 |
| D75H2 | 3.00 | 75 | — | 2 | International Gray | 2 | 40 |
| D100H2 | 4.00 | 100 | — | 2 | International Gray | 2 | 40 |

E4. Permanent Identification

E5. Lockout/Tagout & Safety Solutions

| Part Number | In. | mm | 6 | — | Color | Std. Pkg. Qty. | Std. Ctn. Qty. |
|--------------------------------------|------|-----|---|---|------------|----------------|----------------|
| PANDUCT® Slotted Divider Wall | | | | | | | |
| SD2H6 | 2.00 | 50 | 6 | — | Light Gray | 6 | 120 |
| SD3H6 | 3.00 | 75 | 6 | — | Light Gray | 6 | 120 |
| SD4H6 | 4.00 | 100 | 6 | — | Light Gray | 6 | 120 |
| SD2HWH6 | 2.00 | 50 | 6 | — | White | 6 | 120 |
| SD3HWH6 | 3.00 | 75 | 6 | — | White | 6 | 120 |
| SD4HWH6 | 4.00 | 100 | 6 | — | White | 6 | 120 |

Note: Must be used with mounting base, DB-C (see page C1.26) which is sold separately. Install mounting bases to the duct channel, locate within 2" of each divider wall end and at least every 12" along the length.

F. Index

PANDUCT® Type NNC Divider Wall

- NNC solid divider wall can be mounted inside NNC and NE wiring duct to create multiple channels
- Material: Halogen-free modified PPO
- Simply install the divider wall base when mounting the duct and snap the divider wall onto mounting base, DB-C



| Part Number | For Nominal Duct Height | | Std. Pkg. Qty. | Std. Ctn. Qty. |
|-------------|-------------------------|----|----------------|----------------|
| | In. | mm | | |
| NNC50DWH2 | 2.00 | 50 | 2 | 40 |
| NNC75DWH2 | 3.00 | 75 | 2 | 40 |

Available in WH (White) color only.

Note: Must be used with mounting base, DB-C (see page C1.26) which is sold separately. Install mounting bases to the duct channel, locate within 2" of each divider wall end and at least 12" along the length.

PANDUCT® Type TMC Low Smoke/Low Toxicity Solid Divider Wall

- Wiring duct divider wall can be mounted inside any type of PANDUIT PVC wiring duct to create multiple channels
- Simply install the divider wall base when mounting the duct and snap the divider wall onto the mounting base
- All versions snap onto DB-C mounting base
- Divider wall heights 2 inches and greater have a scoreline feature allowing sections to be removed leaving a smooth edge
- Meets UL508/508A insulation material requirement for barrier between conductors
- UL 94 flammability rating of V-0
- Material: Lead-free PVC



| Part Number | For Nominal Duct Height | | Std. Pkg. Qty. | Std. Ctn. Qty. |
|-------------|-------------------------|----|----------------|----------------|
| | In. | mm | | |
| TMC50DW2 | 2 | 50 | 2 | 20 |
| TMC75DW2 | 3 | 75 | 2 | 20 |

Note: Must be used with mounting base, DB-C (see page C1.26) which is sold separately. Install mounting bases to the duct channel, locate within 2" of each divider wall end and at least every 12" along the length.

A.
System
Overview

B1.
Cable Ties

B2.
Cable
Accessories

B3.
Stainless
Steel Ties

C1.
Wiring
Duct

C2.
Surface
Raceway

C3.
Abrasion
Protection

C4.
Cable
Management

D1.
Terminals

D2.
Power
Connectors

D3.
Grounding
Connectors

E1.
Labeling
Systems

E2.
Labels

E3.
Pre-Printed
& Write-On
Markers

E4.
Permanent
Identification

E5.
Lockout/
Tagout/
& Safety
Solutions

F.
Index

A.
System
Overview

PANDUCT® Type G and H Wiring Duct Wire Retainers

B1.
Cable Ties

- Insert between fingers of type G and H to contain wiring when cover is removed
- Adjustable height
- Material: ABS

B2.
Cable
Accessories



B3.
Stainless
Steel Ties

| Part Number | For Duct Width In. (mm) | For Duct Height In. (mm) | Std. Pkg. Qty. | Std. Ctn. Qty. |
|---------------|---------------------------------|-----------------------------|----------------------|----------------------|
| WR2-C | 2.00 (50.8) | 2.00 – 4.00 (50.8 – 101.6) | 100 | 1000 |
| WR2H-C | 2.00(50.5) | 2.00 – 4.00 (50.8 – 101.6) | 100 | 1000 |
| WR3-C | 3.00 (76.2) | 2.00 – 4.00 (50.8 – 101.6) | 100 | 1000 |
| WR4-C | 4.00 (101.6) | 2.00 – 4.00 (50.8 – 101.6) | 100 | 1000 |
| WR5-C | Use with: 3 x 5, 4 x 5 or 6 x 4 | | 100 | 1000 |

*For 2" width type H hinged cover wiring duct use part number WR2H-C.

C1.
Wiring
Duct

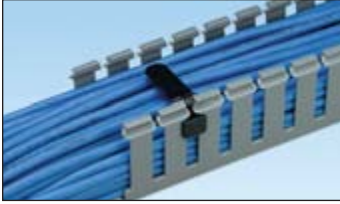

C2.
Surface
Raceway

C3.
Abrasion
Protection

PANDUCT® Solid Wall Raceway Type FS and Type D Wiring Duct Wire Retainer

C4.
Cable
Management

- Mounts onto walls of type FS raceway or type D duct with pressure sensitive adhesive
- Full length is used with 2 inch wide duct; for small widths, break off segments at scorelines
- One size fits three different duct widths
- Material: Lead-free PVC

D1.
Terminals

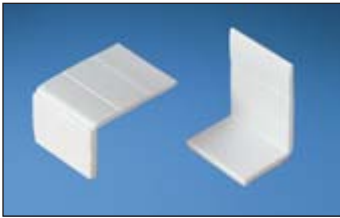

D2.
Power
Connectors

| Part Number | For Duct Width In. (mm) | Std. Pkg. Qty. | Std. Ctn. Qty. |
|------------------|---|----------------------|----------------------|
| WRS-A-C10 | 1.00 (25.4) 1.50 (38.1) 2.00 (50.8) | 100 | 1000 |

Full length is used with 2" wide duct. For smaller widths, break off segments at scorelines.

D3.
Grounding
Connectors



E1.
Labeling
Systems

E2.
Labels

E3.
Pre-Printed
& Write-On
Markers

E4.
Permanent
Identification

E5.
Lockout/
Tagout/
& Safety
Solutions

F.
Index

PANDUCT® Type F, HN, MC and TMC Duct Wire Retainers/Labeling Device

- Used to contain wiring when cover is removed and can also be used as a labeling device
- FWR-C works with all type F and HN duct sizes
- FMWR-C works with all type MC and TMC sizes
- Material: Lead-free PVC



| Part Number | Material | For Duct Width | | Std. Pkg. Qty. | Std. Ctn. Qty. |
|-------------|-----------|----------------|-------------|----------------|----------------|
| | | In. | mm | | |
| FWR-C | Rigid PVC | 1.50 – 4.00 | 37.0 – 76.2 | 100 | 1000 |
| FMWR-C | Rigid PVC | 1.46 – 3.94 | 37 – 100 | 100 | 1000 |



Labeling Inside Duct –
Snaps onto duct fingers. Full length for use with 4" wide duct. For smaller widths, break off segments at scorelines.



Labeling Outside Duct –
Break off the last segment from wire retainer below (1.5" mark) and snap onto the back of the remaining segment. Install label and mount between fingers facing outward.

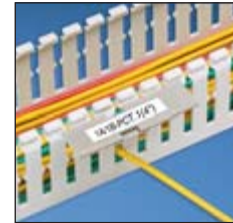

PANDUCT® Duct Corner Strips with 1 Inch Bend Radius Control

- Create a strong rigid corner at wiring duct junctions
- Provide bend radius protection for cabling as required in NFPA 79-2007 section 13.1.5.9 and TIA/EIA-568-B and 569-A
- Available in five pre-cut sizes and 6-foot lengths that can be cut-to-size to meet any size requirement
- Easy to install two-piece design
- Compatible with all styles of PANDUIT wiring duct
- UL 94 flammability rating of V-0
- Material: Lead-free PVC



| Part Number | Part Description | For Duct Height | | Color | Std. Pkg. Qty. | Std. Ctn. Qty. |
|-------------|------------------|-----------------|----|-------|----------------|----------------|
| | | In. | mm | | | |

6' Lengths for use with all Types of PVC Wiring Duct

| | | | | | | |
|---------|--|--------------------------------|--------------------------------|------------|---|-----|
| CSC1LG6 | Cut-to-size 6' corner strip with a 1" bend radius. | All sizes (Cut to duct height) | All sizes (Cut to duct height) | Light Gray | 6 | 120 |
| CSC1WH6 | | | | White | 6 | 120 |

Pre-Cut Pieces for use with all Types of PVC Wiring Duct

| | | | | | | |
|-------------|--|------|-------|------------|----|-----|
| CSPC1LG-Q | 1" bend radius corner strip pre-cut for 1" wall height. | 1.00 | 25.4 | Light Gray | 25 | 250 |
| CSPC1.5LG-Q | 1" bend radius corner strip pre-cut for 1.5" wall height (2.0" type H duct). | 1.50 | 38.1 | Light Gray | 25 | 250 |
| CSPC2LG-Q | 1" bend radius corner strip pre-cut for 2" wall height. | 2.00 | 50.8 | Light Gray | 25 | 250 |
| CSPC3LG-Q | 1" bend radius corner strip pre-cut for 3" wall height. | 3.00 | 76.2 | Light Gray | 25 | 250 |
| CSPC4LG-Q | 1" bend radius corner strip pre-cut for 4" wall height (4.0" type H duct). | 4.00 | 101.6 | Light Gray | 25 | 250 |

CSPC available in Light Gray color only.

Order number of feet required, in multiples of 6' or Standard Package Quantity for pieces offered in 6' lengths.

A.
System
Overview

B1.
Cable Ties

B2.
Cable
Accessories

B3.
Stainless
Steel Ties

C1.
Wiring
Duct

C2.
Surface
Raceway

C3.
Abrasion
Protection

C4.
Cable
Management

D1.
Terminals

D2.
Power
Connectors

D3.
Grounding
Connectors

E1.
Labeling
Systems

E2.
Labels

E3.
Pre-Printed
& Write-On
Markers

E4.
Permanent
Identification

E5.
Lockout/
Tagout/
& Safety
Solutions

F.
Index

A.
System
Overview

PANDUCT® Duct Corner Strips

B1.
Cable Ties

- Slide onto duct at corner or t-junctions for smooth, round corners
- Available in five pre-cut sizes and 6-foot lengths that can be cut to meet any size requirement
- Easy to install one-piece design
- Compatible with all styles of *PANDUIT* wiring duct
- UL 94 flammability rating of V-0
- Material: Lead-free PVC

B2.
Cable
Accessories



CS1LG6

B3.
Stainless
Steel Ties

C1.
Wiring
Duct

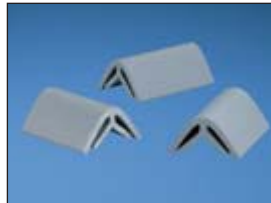

CSP*LG-Q

C2.
Surface
Raceway

C3.
Abrasion
Protection

C4.
Cable
Management

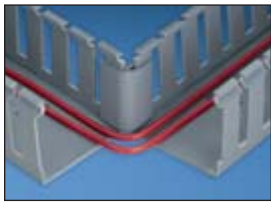

DJS1**6

D1.
Terminals

PANDUCT® Duct Joining Strips

D2.
Power
Connectors

- Slide onto duct to join sections together
- Available in 6-foot lengths that can be cut to meet any size requirement
- Easy to install one-piece design
- Compatible with all styles of *PANDUIT* wiring duct
- UL 94 flammability rating of V-0
- Material: Lead-free PVC

D3.
Grounding
Connectors



E1.
Labeling
Systems

E2.
Labels

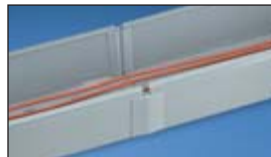

E3.
Pre-Printed
& Write-On
Markers

E4.
Permanent
Identification

E5.
Lockout/
Tagout/
& Safety
Solutions

F.
Index

| Part Number | Part Description | For Nominal Duct Height | | Color | Std. Pkg. Qty. | Std. Ctn. Qty. |
|---|--|-------------------------|-------------|------------|----------------|----------------|
| | | In. | mm | | | |
| 6' Lengths for use with all Types of PVC Wiring Duct | | | | | | |
| CS1LG6 | 6' length is cut by user to fit duct height. | Cut-to-size | Cut-to-size | Light Gray | 6 | 120 |
| CS1WH6 | 6' length is cut by user to fit duct height. | Cut-to-size | Cut-to-size | White | 6 | 120 |

Pre-Cut Pieces for use with all Types of PVC Wiring Duct*

| Part Number | Pre-cut pieces. | For Duct Height | | Color | Std. Pkg. Qty. | Std. Ctn. Qty. |
|-------------|-----------------|-----------------|-------|------------|----------------|----------------|
| | | In. | mm | | | |
| CSP1LG-Q | | 1.00 | 25.4 | Light Gray | 25 | 250 |
| CSP1.5LG-Q | | 1.50 | 38.1 | | 25 | 250 |
| CSP2LG-Q | | 2.00 | 50.8 | | 25 | 250 |
| CSP3LG-Q | | 3.00 | 76.2 | | 25 | 250 |
| CSP4LG-Q | | 4.00 | 101.6 | | 25 | 250 |

*Available in LG (Light Gray) only.

| Part Number | Part Description | For Duct Height | | Color | Std. Pkg. Qty. | Std. Ctn. Qty. |
|---|--|-----------------|-------------|------------|----------------|----------------|
| | | In. | mm | | | |
| 6' Lengths for use with all Types of PVC Wiring Duct | | | | | | |
| DJS1LG6 | 6' length is cut by user to fit duct height. | Cut-to-size | Cut-to-size | Light Gray | 6 | 120 |
| DJS1WH6 | | | | White | | |

To cut product to proper length subtract 1/2" from the duct wall height (example: for G2X2LG6, cut DJS1**6 to 1 1/2" length).

PANDUCT® Snap-Clip Mounting Brackets

- Duct easily snaps into bracket
- No mounting holes required in duct
- Ensures no metal is inside the duct
- Snap-clip spacing is not critical
- Simplifies fabrication drawings and panel layout
- Material: Spring steel



| Part Number | Screw Required | For Duct Width | | Std. Pkg. Qty. | Std. Ctn. Qty. |
|--|-----------------------------|----------------|-------|----------------|----------------|
| | | In. | mm | | |
| Snap-Clip Mounting Brackets for use with Types G, F, FS and D Wiring Duct | | | | | |
| S1F-C | #8-32 x 1/4 (Provided) | 1.00 | 25.4 | 100 | 1000 |
| S1.5F-C | #8-32 x 1/4 (Provided) | 1.50 | 38.1 | 100 | 1000 |
| S2F-C | #8-32 x 1/4 (Provided) | 2.00 | 50.8 | 100 | 1000 |
| S3F-C | #8-32 x 1/4 (Provided) | 3.00 | 76.2 | 100 | 1000 |
| S4F-C | #8-32 x 1/4 (Provided) | 4.00 | 101.6 | 100 | 1000 |
| Snap-Clip Mounting Brackets for use with Types MC, NNC, and TMC Wiring Duct | | | | | |
| SNS25F-C | #8-32 x 1/4 (User Supplied) | 1.00 | 25 | 100 | 1000 |
| SNS37F-C | #8-32 x 1/4 (User Supplied) | 1.50 | 37 | 100 | 1000 |
| SNS50F-C | #8-32 x 1/4 (User Supplied) | 2.00 | 50 | 100 | 1000 |
| SNS62F-C | #8-32 x 1/4 (User Supplied) | 2.50 | 62 | 100 | 1000 |
| SNS75F-C | #8-32 x 1/4 (User Supplied) | 3.00 | 75 | 100 | 1000 |

PANDUCT® Snap-Clip Mounting Bracket – Type NE Wiring Duct

- Duct easily snaps into bracket
- Ensures no metal is inside the duct
- Snap-clip spacing is not critical
- Simplifies fabrication drawings and panel layout
- Material: Spring steel



| Part Number | Screw Required | For Duct Width | | Std. Pkg. Qty. | Std. Ctn. Qty. |
|-------------|-----------------------------|----------------|------|----------------|----------------|
| | | In. | mm | | |
| SNS.5-C | #6-32 x 1/4 (User Supplied) | .50 | 12.7 | 100 | 1000 |
| SNS.75-C | #6-32 x 1/4 (User Supplied) | .75 | 19.1 | 100 | 1000 |
| SNS1-C | #8-32 x 1/4 (User Supplied) | 1.00 | 25.4 | 100 | 1000 |
| SNS1.5-C | #8-32 x 1/4 (User Supplied) | 1.50 | 38.1 | 100 | 1000 |
| SNS2-C | #8-32 x 1/4 (User Supplied) | 2.00 | 50.8 | 100 | 1000 |
| SNS3-C | #8-32 x 1/4 (User Supplied) | 3.00 | 76.2 | 100 | 1000 |

A.
System
Overview

B1.
Cable Ties

B2.
Cable
Accessories

B3.
Stainless
Steel Ties

C1.
Wiring
Duct

C2.
Surface
Raceway

C3.
Abrasion
Protection

C4.
Cable
Management

D1.
Terminals

D2.
Power
Connectors

D3.
Grounding
Connectors

E1.
Labeling
Systems

E2.
Labels

E3.
Pre-Printed
& Write-On
Markers

E4.
Permanent
Identification

E5.
Lockout/
Tagout/
& Safety
Solutions

F.
Index

A.
System
Overview

Adhesive Tape for Wiring Duct

- Recommended installation temperature is 70°F (21°C)
- Optimum recommended dwell time for acrylic adhesive is 8 hours
- UL Recognized service temperature is 32°F (0°C) to 140°F (60°C)
- Recommended tape load is 1/2 lb. per square inch of tape area

B1.
Cable Ties

B2.
Cable
Accessories



B3.
Stainless
Steel Ties

C1.
Wiring
Duct

C2.
Surface
Raceway

C3.
Abrasion
Protection

C4.
Cable
Management

D1.
Terminals

D2.
Power
Connectors

D3.
Grounding
Connectors

E1.
Labeling
Systems

E2.
Labels

E3.
Pre-Printed
& Write-On
Markers

E4.
Permanent
Identification

E5.
Lockout/
Tagout/
& Safety
Solutions

F.
Index

| Duct Size W x H | Tape Part Number | Roll Length | | Std. Pkg. Qty. | Std. Ctn. Qty. |
|----------------------|------------------------|----------------|------|----------------------|----------------------|
| | | Yds. | m | | |
| .5 x .5 thru 1.5 x 4 | P32W2A2-50-7 | 7.0 | 6.4 | 1 | 100 |
| | P32W2A2-50-72 | 72.0 | 65.5 | 1 | 9 |
| 2 x 1 thru 3 x 3 | P32W2A2-50-7 | 7.0 | 6.4 | 1 | 100 |
| | P32W2A2-50-72 | 72.0 | 65.5 | 1 | 9 |
| 3 x 4 thru 3 x 5 | P32W2A2-75-7 | 7.0 | 6.4 | 1 | 60 |
| | P32W2A2-75-72 | 72.0 | 65.5 | 1 | 7 |
| 4 x 1.5 thru 4 x 3 | P32W2A2-50-7 | 7.0 | 6.4 | 1 | 100 |
| | P32W2A2-75-72 | 72.0 | 65.5 | 1 | 9 |
| 4 x 4 thru 6 x 4 | P32W2A2-75-7 | 7.0 | 6.4 | 1 | 60 |
| | P32W2A2-75-72 | 72.0 | 65.5 | 1 | 7 |

Specifications for Factory Applied Tape

| Duct Size (W x H) | Rows of Tape | Tape | | | |
|----------------------|-----------------|-------|------|-----------|----|
| | | Width | | Thickness | |
| | | In. | mm | In. | mm |
| .5x.5 through .75x2 | 1 | .50 | 12.7 | .03 | .8 |
| 1x1 through 1.5x4 | 1 | .75 | 19.1 | .03 | .8 |
| 2x1 through 3x3 | 2 | .50 | 12.7 | .03 | .8 |
| 3x4 through 3x5 | 2 | .75 | 19.1 | .03 | .8 |
| 4x1.5 through 4x3 | 2 | .50 | 12.7 | .03 | .8 |
| 4x4 through 6x4 | 2 | .75 | 19.1 | .03 | .8 |

Adhesive Tape Guide

Selection of wiring duct part numbers available with factory applied adhesive tape.



| G Duct Light Gray | G Duct White | G Duct Black | F Duct Light Gray | NE Duct White |
|-------------------|---------------|--------------|-------------------|---------------|
| G.5X.5LG6-A | G.5X.5WH6-A | — | F.5X.5LG6-A | — |
| G.5X1LG6-A | G.5X1WH6-A | — | F.5X1LG6-A | — |
| G.75X.75LG6-A | — | — | F.75X.75LG6-A | — |
| G.75X1LG6-A | G.75X1WH6-A | — | — | — |
| G.75X1.5LG6-A | G.75X1.5WH6-A | — | F.75X1.5LG6-A | — |
| G.75X2LG6-A | G.75X2WH6-A | — | — | — |
| G1X1LG6-A | G1X1WH6-A | — | F1X1LG6-A | — |
| G1X1.5LG6-A | G1X1.5WH6-A | — | F1X1.5LG6-A | — |
| G1X2LG6-A | G1X2WH6-A | — | F1X2LG6-A | NE1X2WH6-A |
| G1X3LG6-A | G1X3WH6-A | G1X3BL6-A | F1X3LG6-A | — |
| G1X4LG6-A | G1X4WH6-A | — | F1X4LG6-A | — |
| G1.5X1LG6-A | G1.5X1WH6-A | — | F1.5X1LG6-A | — |
| G1.5X1.5LG6-A | G1.5X1.5WH-A | — | F1.5X1.5LG6-A | — |
| G1.5X2LG6-A | G1.5X2WH6-A | — | F1.5X2LG6-A | NE1.5X2WH6-A |
| G1.5X3LG6-A | G1.5X3WH6-A | — | F1.5X3LG6-A | — |
| G1.5X4LG6-A | G1.5X4WH6-A | — | F1.5X4LG6-A | — |
| G2X1LG6-A | G2X1WH6-A | — | F2X1LG6-A | — |
| G2X1.5LG6-A | G2X1.5WH6-A | — | F2X1.5LG6-A | — |
| G2X2LG6-A | G2X2WH6-A | G2X2BL6-A | F2X2LG6-A | NE2X2WH6-A |
| G2X3LG6-A | G2X3WH6-A | — | F2X3LG6-A | — |
| G2X4LG6-A | G2X4WH6-A | G2X4BL6-A | F2X4LG6-A | — |
| G2X5LG6-A | G2X5WH6-A | — | F2X5LG6-A | — |
| G2.5X3LG6-A | G2.5X3WH6-A | — | — | — |
| G3X1LG6-A | G3X1WH6-A | — | F3X1LG6-A | — |
| G3X2LG6-A | G3X2WH6-A | — | F3X2LG6-A | — |
| G3X3LG6-A | G3X3WH6-A | G3X3BL6-A | F3X3LG6-A | — |
| G3X4LG6-A | G3X4WH6-A | — | F3X4LG6-A | — |
| G3X5LG6-A | G3X5WH6-A | — | F3X5LG6-A | — |
| G4X1.5LG6-A | G4X1.5WH6-A | — | — | — |
| G4X2LG6-A | G4X2WH6-A | — | F4X2LG6-A | NE4X2WH6-A |
| G4X3LG6-A | G4X3WH6-A | — | F4X3LG6-A | NE4X3WH6-A |
| G4X4LG6-A | G4X4WH6-A | G4X4BL6-A | F4X4LG6-A | NE4X4WH6-A |
| G4X5LG6-A | G4X5WH6-A | — | F4X5LG6-A | — |

All three sizes of flexible duct come provided with adhesive: FL12X12LG-A, FL25X25LG-A, FL50X50LG-A.

A.
System
Overview

B1.
Cable Ties

B2.
Cable
Accessories

B3.
Stainless
Steel Ties

C1.
Wiring
Duct

C2.
Surface
Raceway

C3.
Abrasion
Protection

C4.
Cable
Management

D1.
Terminals

D2.
Power
Connectors

D3.
Grounding
Connectors

E1.
Labeling
Systems

E2.
Labels

E3.
Pre-Printed
& Write-On
Markers

E4.
Permanent
Identification

E5.
Lockout/
Tagout/
& Safety
Solutions

F.
Index

A. System Overview

PANDUCT® Installation Tools

B1. Cable Ties

- PBDCT and DCT easily cut *PANDUCT*® Wiring Duct and Cover
- DNT-100 notches duct sidewalls to bottom scoreline for tees and corner junctions
- TNR installs or removes *PANDUIT* Nylon Rivets, NR1-C and NR1-M, quickly and easily
- DFCT easily removes duct fingers in tight places

B2. Cable Accessories



PBDCT



| Part Number | Part Description | Std. Pkg. Qty |
|--------------------------|---|---------------|
| Duct Cutting Tool | | |
| PBDCT | <i>PANDUIT</i> bench-mount duct cutting tool. Cuts slotted wiring ducts and wiring duct covers with up to 6" width and up to 5" height. Full 78.74" (2m) measuring scale. Includes safety guarding. | 1 |
| DCT | Hand-held duct cutting tool. | 1 |

B3. Stainless Steel Ties

C1. Wiring Duct



DCT



DFCT

Replacement Blade Kit (Includes blade and nylon insert)

| | | |
|---------|--|---|
| DCT-BLD | Replacement blade kit with blade and nylon insert. | 1 |
|---------|--|---|

C2. Surface Raceway

Replacement Nylon Insert

| | | |
|--------|---------------------------|---|
| DCT-RI | Replacement nylon insert. | 5 |
|--------|---------------------------|---|

C3. Abrasion Protection



DNT-100



TNR

Duct Finger Cutting Tool (For use with all wide slotted duct types)

| | | |
|------|-------------------------------------|---|
| DFCT | Hand-held duct finger cutting tool. | 1 |
|------|-------------------------------------|---|

C4. Cable Management

Duct Notching Tool (For use with all slotted duct types)

| | | |
|---------|-----------------------------------|---|
| DNT-100 | Hand-held sidewall notching tool. | 1 |
|---------|-----------------------------------|---|

D1. Terminals



NR1

Nylon Rivet Installation Tool

| | | |
|-----|--|---|
| TNR | Hand-held nylon rivet installation tool. | 1 |
|-----|--|---|

D2. Power Connectors

Nylon Rivets

| | | |
|-------|---|------|
| NR1-C | Nylon rivet for use with TNR rivet tool. Mean pull-off force: PVC 90 lbs., Noryl Duct (Type NE) 70 lbs. Mean shear force: PVC 139 lbs., Noryl Duct (Type NE) 126 lbs. | 100 |
| NR1-M | Nylon rivet for use with TNR rivet tool. Mean pull-off force: PVC 90 lbs., Noryl Duct (Type NE) 70 lbs. Mean shear force: PVC 139 lbs., Noryl Duct (Type NE) 126 lbs. | 1000 |

Always use approved safety goggles when using any tools.

D3. Grounding Connectors

| Total Thickness of Panel and Duct | | Panel Hole Dia. Needed | | ANSI Standard Drill Bit |
|-----------------------------------|-----------|------------------------|-----|-------------------------|
| In. | mm | In. | mm | |
| .158 – .187 | 4.0 – 4.7 | .187 | 4.7 | #15 |
| .188 – .218 | 4.8 – 5.5 | .193 | 4.9 | #11 |
| .219 – .250 | 5.6 – 6.4 | .203 | 5.2 | #7 |
| .251 – .281 | 6.5 – 7.1 | .213 | 5.4 | #4 |

E1. Labeling Systems

E2. Labels

E3. Pre-Printed & Write-On Markers

E4. Permanent Identification

E5. Lockout/Tagout & Safety Solutions

F. Index

PANDUCT® PANELMAX™ Corner Wiring Duct Dimensions

Dimensions are shown for reference only. Contact PANDUIT customer service at 800-777-3300 for specific dimensional needs.

| Size | Dimensions – Inches (mm) | | | | | | | | |
|-------------|--------------------------|----------------|----------------|-----------------|-----------------|-----------------|--------------|-----------------|-----------------|
| | A | C | D | G | H | K | T | W | Z |
| CWD3 | 4.98 (126.6) | 2.25 (57.2) | 2.83 (71.8) | 3.10 (79.1) | 3.57 (90.7) | 3.95 (100.4) | .10 (2.4) | 4.40 (111.8) | 5.16 (131.0) |
| CWD4 | 5.94 (150.9) | 2.25 (57.2) | 3.84 (97.5) | 4.10 (104.1) | 4.58 (115.7) | 4.89 (124.3) | .11 (2.7) | 5.33 (135.3) | 6.54 (166.0) |

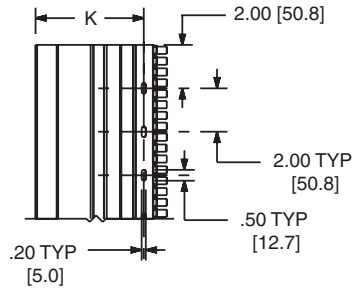
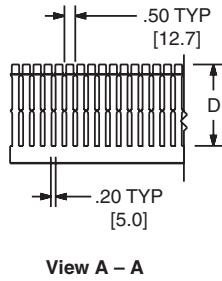
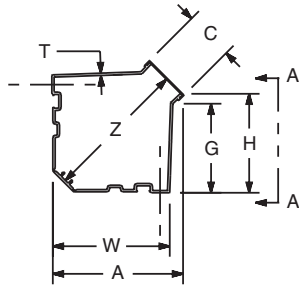

A.
System
Overview

B1.
Cable Ties

B2.
Cable
Accessories

B3.
Stainless
Steel Ties

C1.
Wiring
Duct

C2.
Surface
Raceway

C3.
Abrasion
Protection

C4.
Cable
Management

D1.
Terminals

D2.
Power
Connectors

D3.
Grounding
Connectors

E1.
Labeling
Systems

E2.
Labels

E3.
Pre-Printed
& Write-On
Markers

E4.
Permanent
Identification

E5.
Lockout/
Tagout
& Safety
Solutions

F.
Index

A. System Overview

PANDUCT® Type G and D Wiring Duct Dimensions

Dimensions are shown for reference only. Contact PANDUIT customer service at 800-777-3300 for specific dimensional needs.

B1. Cable Ties

B2. Cable Accessories

B3. Stainless Steel Ties

C1. Wiring Duct

C2. Surface Raceway

C3. Abrasion Protection

C4. Cable Management

D1. Terminals

D2. Power Connectors

D3. Grounding Connectors

E1. Labeling Systems

E2. Labels

E3. Pre-Printed & Write-On Markers

E4. Permanent Identification

E5. Lockout/Tagout & Safety Solutions

F. Index

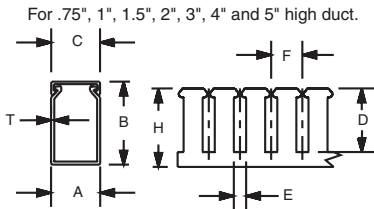
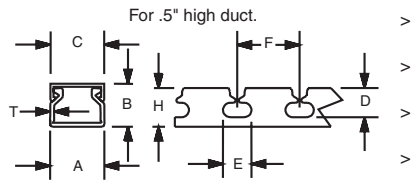

Note: 'A' dimension is measured at base.
Note: 'K' dimension shown in mounting hole dimensions below.

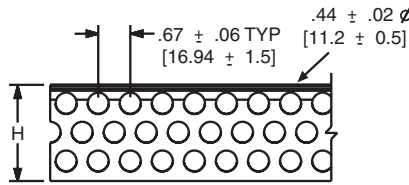

For 2" duct height = 3 rows of holes
3" duct height = 4 rows of holes
4" duct height = 6 rows of holes

Mounting Hole Dimensions
For .5", .75", 1", and 1.5" wide duct.

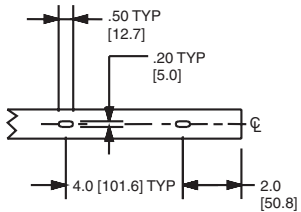

For 2.0", 2.5", 3", 4" and 6" wide duct.

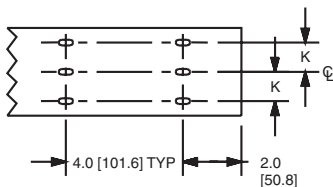

| Duct Size (W x H) | Dimensions – Inches (mm) | | | | | | | | | |
|----------------------------|--------------------------|-----------------|-----------------|-----------------|--------------|----------------|-----------------|----------------|--------------|--|
| | A | B | C | D | E | F | H | K | T | |
| .5 x .5 (12.7) (12.7) | .69 (17.5) | .60 (15.2) | .69 (17.5) | .38 (9.5) | .37 (9.3) | .80 (20.3) | .50 (12.7) | | .05 (1.3) | |
| .5 x 1 (12.7) (25.4) | .69 (17.5) | 1.06 (26.9) | .69 (17.5) | .75 (19.1) | .31 (7.9) | .80 (20.3) | 1.00 (25.4) | | .05 (1.3) | |
| .5 x 2 (12.7) (50.8) | .69 (17.5) | 2.03 (51.6) | .69 (17.5) | 1.63 (41.3) | .31 (7.9) | .80 (20.3) | 2.00 (50.8) | | .08 (2.0) | |
| .5 x 4 (12.7) (101.6) | .69 (17.5) | 4.10 (104.1) | .69 (17.5) | 2.25 (57.2) | .31 (7.9) | 1.00 (25.4) | 4.00 (101.6) | | .10 (2.4) | |
| .75 x .75 (19.1) (19.1) | .93 (23.6) | .82 (20.8) | .94 (23.9) | .56 (14.3) | .31 (7.9) | .80 (20.3) | 0.75 (19.1) | | .06 (1.4) | |
| .75 x 1 (19.1) (25.4) | .93 (23.6) | 1.06 (26.9) | .94 (23.9) | .75 (19.1) | .31 (7.9) | .80 (20.3) | 1.00 (25.4) | | .06 (1.4) | |
| .75 x 1.5 (19.1) (38.1) | .93 (23.6) | 1.57 (39.9) | .94 (23.9) | 1.20 (30.5) | .31 (7.9) | .80 (20.3) | 1.50 (38.1) | | .07 (1.8) | |
| .75 x 2 (19.1) (50.8) | .93 (23.6) | 2.03 (51.6) | .94 (23.9) | 1.63 (41.3) | .31 (7.9) | .80 (20.3) | 2.00 (50.8) | | .08 (2.0) | |
| 1 x 1 (25.4) (25.4) | 1.26 (32.0) | 1.12 (28.4) | 1.25 (31.8) | .75 (19.1) | .31 (7.9) | .80 (20.3) | 1.00 (25.4) | | .06 (1.4) | |
| 1 x 1.5 (25.4) (38.1) | 1.26 (32.0) | 1.62 (41.1) | 1.25 (31.8) | 1.20 (30.5) | .31 (7.9) | .80 (20.3) | 1.50 (38.1) | | .07 (1.8) | |
| 1 x 2 (25.4) (50.8) | 1.26 (32.0) | 2.12 (53.8) | 1.25 (31.8) | 1.63 (41.3) | .31 (7.9) | .80 (20.3) | 2.00 (50.8) | | .08 (2.0) | |
| 1 x 3 (25.4) (76.2) | 1.26 (32.0) | 3.12 (79.2) | 1.25 (31.8) | 2.63 (66.7) | .31 (7.9) | 1.00 (25.4) | 3.00 (76.2) | | .10 (2.4) | |
| 1 x 4 (25.4) (101.6) | 1.26 (32.0) | 4.10 (104.1) | 1.25 (31.8) | 3.63 (92.1) | .31 (7.9) | 1.00 (25.4) | 4.00 (101.6) | | .11 (2.7) | |
| 1.5 x 1 (38.1) (25.4) | 1.75 (44.5) | 1.12 (28.4) | 1.75 (44.5) | .75 (19.1) | .31 (7.9) | .80 (20.3) | 1.00 (25.4) | | .06 (1.5) | |
| 1.5 x 1.5 (38.1) (38.1) | 1.75 (44.5) | 1.62 (41.1) | 1.75 (44.5) | 1.20 (30.5) | .31 (7.9) | .80 (20.3) | 1.50 (38.1) | | .07 (1.8) | |
| 1.5 x 2 (38.1) (50.8) | 1.75 (44.5) | 2.12 (53.8) | 1.75 (44.5) | 1.63 (41.3) | .31 (7.9) | .80 (20.3) | 2.00 (50.8) | | .08 (2.0) | |
| 1.5 x 3 (38.1) (76.2) | 1.75 (44.5) | 3.12 (79.2) | 1.75 (44.5) | 2.63 (66.7) | .31 (7.9) | 1.00 (25.4) | 3.00 (76.2) | | .10 (2.4) | |
| 1.5 x 4 (38.1) (101.6) | 1.75 (44.5) | 4.10 (104.1) | 1.75 (44.5) | 3.63 (92.1) | .31 (7.9) | 1.00 (25.4) | 4.00 (101.6) | | .11 (2.7) | |
| 2 x 1 (50.8) (25.4) | 2.25 (57.2) | 1.12 (28.4) | 2.25 (57.2) | .75 (19.1) | .31 (7.9) | .80 (20.3) | 1.00 (25.4) | .50 (12.7) | .06 (1.5) | |
| 2 x 1.5 (50.8) (38.1) | 2.25 (57.2) | 1.62 (41.1) | 2.25 (57.2) | 1.20 (30.5) | .31 (7.9) | .80 (20.3) | 1.50 (38.1) | .50 (12.7) | .07 (1.8) | |
| 2 x 2 (50.8) (50.8) | 2.25 (57.2) | 2.12 (53.8) | 2.25 (57.2) | 1.63 (41.3) | .31 (7.9) | .80 (20.3) | 2.00 (50.8) | .50 (12.7) | .08 (2.0) | |
| 2 x 3 (50.8) (76.2) | 2.25 (57.2) | 3.12 (79.2) | 2.25 (57.2) | 2.63 (66.7) | .31 (7.9) | 1.00 (25.4) | 3.00 (76.2) | .50 (12.7) | .10 (2.4) | |
| 2 x 4 (50.8) (101.6) | 2.25 (57.2) | 4.10 (104.1) | 2.25 (57.2) | 3.63 (92.1) | .31 (7.9) | 1.00 (25.4) | 4.00 (101.6) | .50 (12.7) | .11 (2.7) | |
| 2 x 5 (50.8) (127.0) | 2.25 (57.2) | 5.10 (129.5) | 2.25 (57.2) | 4.63 (117.5) | .38 (9.5) | 1.33 (33.9) | 5.00 (127.0) | .50 (12.7) | .12 (2.9) | |
| 2.5 x 3 (63.5) (76.2) | 2.75 (69.9) | 3.12 (79.2) | 2.75 (69.9) | 2.63 (66.7) | .31 (7.9) | 1.00 (25.4) | 3.00 (76.2) | .73 (18.4) | .10 (2.5) | |
| 3 x 1 (76.2) (25.4) | 3.25 (82.6) | 1.12 (28.4) | 3.25 (82.6) | .75 (19.1) | .31 (7.9) | .80 (20.3) | 1.00 (25.4) | 1.00 (25.4) | .07 (1.8) | |
| 3 x 2 (76.2) (50.8) | 3.25 (82.6) | 2.12 (53.8) | 3.25 (82.6) | 1.63 (41.3) | .31 (7.9) | .80 (20.3) | 2.00 (50.8) | 1.00 (25.4) | .08 (2.0) | |
| 3 x 3 (76.2) (76.2) | 3.25 (82.6) | 3.12 (79.2) | 3.25 (82.6) | 2.63 (66.7) | .31 (7.9) | 1.00 (25.4) | 3.00 (76.2) | 1.00 (25.4) | .10 (2.4) | |
| 3 x 4 (76.2) (101.6) | 3.25 (82.6) | 4.10 (104.1) | 3.25 (82.6) | 3.63 (92.1) | .31 (7.9) | 1.00 (25.4) | 4.00 (101.6) | 1.00 (25.4) | .11 (2.7) | |
| 3 x 5 (76.2) (127.0) | 3.25 (82.6) | 5.10 (129.5) | 3.25 (82.6) | 4.63 (117.5) | .38 (9.5) | 1.33 (33.9) | 5.00 (127.0) | 1.00 (25.4) | .12 (2.9) | |
| 4 x 1.5 (101.6) (38.1) | 4.25 (108.0) | 1.62 (41.1) | 4.25 (108.0) | 1.20 (30.5) | .31 (7.9) | .80 (20.3) | 1.50 (38.1) | 1.50 (38.1) | .07 (1.8) | |
| 4 x 2 (101.6) (50.8) | 4.25 (108.0) | 2.12 (53.8) | 4.25 (108.0) | 1.63 (41.3) | .31 (7.9) | 0.80 (20.3) | 2.00 (50.8) | 1.50 (38.1) | .08 (2.0) | |
| 4 x 3 (101.6) (76.2) | 4.25 (108.0) | 3.12 (79.2) | 4.25 (108.0) | 2.63 (66.7) | .31 (7.9) | 1.00 (25.4) | 3.00 (76.2) | 1.50 (38.1) | .10 (2.5) | |
| 4 x 4 (101.6) (101.6) | 4.25 (108.0) | 4.10 (104.1) | 4.25 (108.0) | 3.63 (92.1) | .31 (7.9) | 1.00 (25.4) | 4.00 (101.6) | 1.50 (38.1) | .11 (2.7) | |
| 4 x 5 (101.6) (127.0) | 4.25 (108.0) | 5.10 (129.5) | 4.25 (108.0) | 4.63 (117.5) | .38 (9.5) | 1.33 (33.9) | 5.00 (127.0) | 1.50 (38.1) | .12 (2.9) | |
| 6 x 4 (152.4) (101.6) | 6.25 (158.8) | 4.15 (105.4) | 6.25 (158.8) | 3.63 (92.1) | .31 (7.9) | 1.00 (25.4) | 4.00 (101.6) | 2.50 (63.5) | .11 (2.8) | |

ON CENTERLINE

> Available for type G wiring duct only.
See page C1.9 and C1.13 for wiring duct color and size availability.

PANDUCT® Type F Wiring Duct and FS Raceway Dimensions

Dimensions are shown for reference only. Contact PANDUIT customer service at 800-777-3300 for specific dimensional needs.

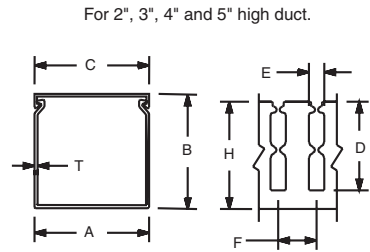
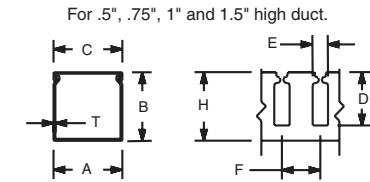

Note: 'A' dimension is measured at base.
Note: 'K' dimension shown in mounting hole dimensions below.

Mounting Hole Dimensions
For .5", .75", 1" and 1.5" wide duct.

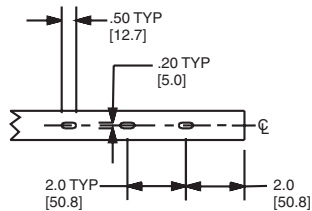

For 2.0", 2.5", 3", 4" and 6" wide duct.

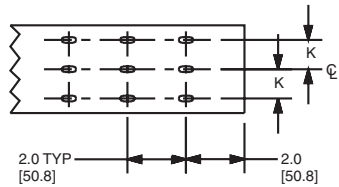

Note: For type FS raceway, no mounting holes is the standard condition; if mounting holes are required, delete NM from the part number.

| Duct Size (W x H) | Dimensions – Inches (mm) | | | | | | | | |
|----------------------------|--------------------------|-----------------|-----------------|-----------------|--------------|---------------|-----------------|---------------|--------------|
| | A | B | C | D | E | F | H | K | T |
| .5 x .5 (12.7) (12.7) | .69 (17.5) | .60 (15.2) | .69 (17.5) | .38 (9.5) | .20 (5.0) | .50 (12.7) | .50 (12.7) | ON CENTERLINE | .05 (1.3) |
| .5 x 1 (12.7) (25.4) | .69 (17.5) | 1.06 (26.9) | .69 (17.5) | .75 (19.1) | .20 (5.0) | .50 (12.7) | 1.00 (25.4) | | .05 (1.3) |
| .75 x .75 (19.1) (19.1) | .93 (23.6) | .82 (20.8) | .94 (23.9) | .56 (14.3) | .20 (5.0) | .50 (12.7) | .75 (19.1) | | .06 (1.4) |
| .75 x 1.5 (19.1) (38.1) | .93 (23.6) | 1.57 (39.9) | .94 (23.9) | 1.20 (30.5) | .20 (5.0) | .50 (12.7) | 1.50 (38.1) | | .07 (1.8) |
| 1 x 1 (25.4) (25.4) | 1.26 (32.0) | 1.12 (28.4) | 1.25 (31.8) | .75 (19.1) | .20 (5.0) | .50 (12.7) | 1.00 (25.4) | | .06 (1.4) |
| 1 x 1.5 (25.4) (38.1) | 1.26 (32.0) | 1.62 (41.1) | 1.25 (31.8) | 1.20 (30.5) | .20 (5.0) | .50 (12.7) | 1.50 (38.1) | | .07 (1.8) |
| 1 x 2 (25.4) (50.8) | 1.26 (32.0) | 2.12 (53.8) | 1.25 (31.8) | 1.63 (41.3) | .20 (5.0) | .50 (12.7) | 2.00 (50.8) | | .08 (2.0) |
| 1 x 3 (25.4) (76.2) | 1.26 (32.0) | 3.12 (79.2) | 1.25 (31.8) | 2.63 (66.7) | .20 (5.0) | .50 (12.7) | 3.00 (76.2) | | .10 (2.4) |
| 1 x 4 (25.4) (101.6) | 1.26 (32.0) | 4.10 (104.1) | 1.25 (31.8) | 3.63 (92.1) | .20 (5.0) | .50 (12.7) | 4.00 (101.6) | | .11 (2.7) |
| 1.5 x 1 (38.1) (25.4) | 1.75 (44.5) | 1.12 (28.4) | 1.75 (44.5) | .75 (19.1) | .20 (5.0) | .50 (12.7) | 1.00 (25.4) | | .06 (1.5) |
| 1.5 x 1.5 (38.1) (38.1) | 1.75 (44.5) | 1.62 (41.1) | 1.75 (44.5) | 1.20 (30.5) | .20 (5.0) | .50 (12.7) | 1.50 (38.1) | | .07 (1.8) |
| 1.5 x 2 (38.1) (50.8) | 1.75 (44.5) | 2.12 (53.8) | 1.75 (44.5) | 1.63 (41.3) | .20 (5.0) | .50 (12.7) | 2.00 (50.8) | | .08 (2.0) |
| 1.5 x 3 (38.1) (76.2) | 1.75 (44.5) | 3.12 (79.2) | 1.75 (44.5) | 2.63 (66.7) | .20 (5.0) | .50 (12.7) | 3.00 (76.2) | | .10 (2.4) |
| 1.5 x 4 (38.1) (101.6) | 1.75 (44.5) | 4.10 (104.1) | 1.75 (44.5) | 3.63 (92.1) | .20 (5.0) | .50 (12.7) | 4.00 (101.6) | | .11 (2.7) |
| 2 x 1 (50.8) (25.4) | 2.25 (57.2) | 1.12 (28.4) | 2.25 (57.2) | .75 (19.1) | .20 (5.0) | .50 (12.7) | 1.00 (25.4) | | .06 (1.5) |
| 2 x 1.5 (50.8) (38.1) | 2.25 (57.2) | 1.62 (41.1) | 2.25 (57.2) | 1.20 (30.5) | .20 (5.0) | .50 (12.7) | 1.50 (38.1) | | .07 (1.8) |
| 2 x 2 (50.8) (50.8) | 2.25 (57.2) | 2.12 (53.8) | 2.25 (57.2) | 1.63 (41.3) | .20 (5.0) | .50 (12.7) | 2.00 (50.8) | | .08 (2.0) |
| 2 x 3 (50.8) (76.2) | 2.25 (57.2) | 3.12 (79.2) | 2.25 (57.2) | 2.63 (66.7) | .20 (5.0) | .50 (12.7) | 3.00 (76.2) | | .10 (2.4) |
| 2 x 4 (50.8) (101.6) | 2.25 (57.2) | 4.10 (104.1) | 2.25 (57.2) | 3.63 (92.1) | .20 (5.0) | .50 (12.7) | 4.00 (101.6) | | .11 (2.7) |
| 2 x 5 (50.8) (127.0) | 2.25 (57.2) | 5.10 (129.5) | 2.25 (57.2) | 4.63 (117.5) | .20 (5.0) | .50 (12.7) | 5.00 (127.0) | | .12 (2.9) |
| 3 x 1 (76.2) (25.4) | 3.25 (82.6) | 1.12 (28.4) | 3.25 (82.6) | .75 (19.1) | .20 (5.0) | .50 (12.7) | 1.00 (25.4) | | .07 (1.7) |
| 3 x 2 (76.2) (50.8) | 3.25 (82.6) | 2.12 (53.8) | 3.25 (82.6) | 1.63 (41.3) | .20 (5.0) | .50 (12.7) | 2.00 (50.8) | | .08 (2.0) |
| 3 x 3 (76.2) (76.2) | 3.25 (82.6) | 3.12 (79.2) | 3.25 (82.6) | 2.63 (66.7) | .20 (5.0) | .50 (12.7) | 3.00 (76.2) | | .10 (2.4) |
| 3 x 4 (76.2) (101.6) | 3.25 (82.6) | 4.10 (104.1) | 3.25 (82.6) | 3.63 (92.1) | .20 (5.0) | .50 (12.7) | 4.00 (101.6) | | .11 (2.7) |
| 3 x 5 (76.2) (127.0) | 3.25 (82.6) | 5.10 (129.5) | 3.25 (82.6) | 4.63 (117.5) | .20 (5.0) | .50 (12.7) | 5.00 (127.0) | .12 (2.9) | |
| 4 x 1.5 (101.6) (38.1) | 4.25 (108.0) | 1.62 (41.1) | 4.25 (108.0) | N/A | N/A | N/A | 1.50 (38.1) | .07 (1.8) | |
| 4 x 2 (101.6) (50.8) | 4.25 (108.0) | 2.12 (53.8) | 4.25 (108.0) | 1.63 (41.3) | .20 (5.0) | .50 (12.7) | 2.00 (50.8) | .08 (2.0) | |
| 4 x 3 (101.6) (76.2) | 4.25 (108.0) | 3.12 (79.2) | 4.25 (108.0) | 2.63 (66.7) | .20 (5.0) | .50 (12.7) | 3.00 (76.2) | .10 (2.4) | |
| 4 x 4 (101.6) (101.6) | 4.25 (108.0) | 4.10 (104.1) | 4.25 (108.0) | 3.63 (92.1) | .20 (5.0) | .50 (12.7) | 4.00 (101.6) | .11 (2.7) | |
| 4 x 5 (101.6) (127.0) | 4.25 (108.0) | 5.10 (129.5) | 4.25 (108.0) | 4.63 (117.5) | .20 (5.0) | .50 (12.7) | 5.00 (127.0) | .12 (2.9) | |
| 6 x 4 (152.4) (101.6) | 6.25 (158.8) | 4.15 (105.4) | 6.25 (158.8) | N/A | N/A | N/A | 4.00 (101.6) | .11 (2.8) | |

> Available for type FS raceway only.
See page C1.48 for wiring duct color and size availability.

A.
System Overview

B1.
Cable Ties

B2.
Cable Accessories

B3.
Stainless Steel Ties

C1.
Wiring Duct

C2.
Surface Raceway

C3.
Abrasion Protection

C4.
Cable Management

D1.
Terminals

D2.
Power Connectors

D3.
Grounding Connectors

E1.
Labeling Systems

E2.
Labels

E3.
Pre-Printed & Write-On Markers

E4.
Permanent Identification

E5.
Lockout/Tagout & Safety Solutions

F.
Index

A. System Overview

PANDUCT® Type MC and TMC Wiring Duct Dimensions

Dimensions are shown for reference only. Contact PANDUIT customer service at 800-777-3300 for specific dimensional needs.

B1. Cable Ties

B2. Cable Accessories

B3. Stainless Steel Ties

C1. Wiring Duct

C2. Surface Raceway

C3. Abrasion Protection

C4. Cable Management

D1. Terminals

D2. Power Connectors

D3. Grounding Connectors

E1. Labeling Systems

E2. Labels

E3. Pre-Printed & Write-On Markers

E4. Permanent Identification

E5. Lockout/Tagout & Safety Solutions

F. Index

For 25mm, 37.5mm, and 50mm high duct.

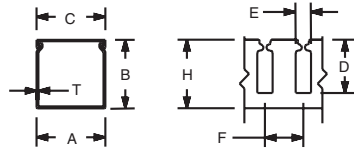

For 62.5mm, 75mm, and 100mm high duct.

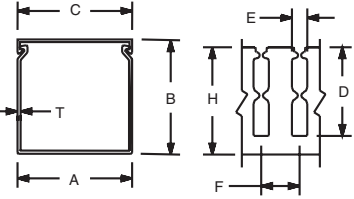

Note: 'A' dimension is measured at base.
Note: 'K' dimension shown in mounting hole dimensions below.

Mounting Hole Dimensions
For 25mm, 37.5mm, and 50mm width duct.

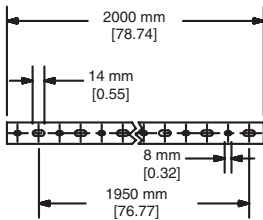

For 75mm and 100mm width duct.

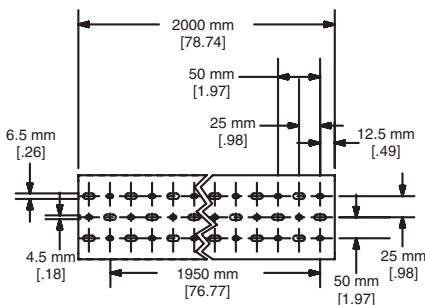

| Duct Size (W x H) | Dimensions – mm (Inches) | | | | | | | |
|--------------------------------|--------------------------|----------------|----------------|----------------|--------------|---------------|----------------|--------------|
| | A | B | C | D | E | F | H | T |
| 25 x 25 (.98) x (.98) | 24.6 (.97) | 23.6 (.93) | 24.6 (.97) | 13.6 (.54) | 5.0 (.20) | 12.5 (.49) | 20.5 (.81) | 1.4 (.06) |
| 25 x 37.5 (.98) x (1.48) | 24.6 (.97) | 35.8 (1.41) | 24.6 (.97) | 24.7 (.97) | 5.0 (.20) | 12.5 (.49) | 33.0 (1.30) | 1.4 (.06) |
| 25 x 50 (.98) x (1.97) | 24.6 (.97) | 47.8 (1.88) | 24.6 (.97) | 34.8 (1.37) | 5.0 (.20) | 12.5 (.49) | 45.5 (1.79) | 1.5 (.06) |
| 25 x 62.5 (.98) x (2.46) | 24.6 (.97) | 59.7 (2.35) | 24.6 (.97) | 45.8 (1.80) | 5.0 (.20) | 12.5 (.49) | 58.0 (2.28) | 1.5 (.06) |
| 25 x 75 (.98) x (2.95) | 24.6 (.97) | 73.2 (2.88) | 24.6 (.97) | 57.6 (2.27) | 5.0 (.20) | 12.5 (.49) | 70.5 (2.78) | 1.7 (.07) |
| 37.5 x 37.5 (1.48) x (1.48) | 37.1 (1.46) | 35.8 (1.41) | 37.1 (1.46) | 24.7 (.97) | 5.0 (.20) | 12.5 (.49) | 33.0 (1.30) | 1.5 (.06) |
| 37.5 x 50 (1.48) x (1.97) | 37.1 (1.46) | 47.8 (1.88) | 37.1 (1.46) | 34.8 (1.37) | 5.0 (.20) | 12.5 (.49) | 45.5 (1.79) | 1.7 (.07) |
| 37.5 x 62.5 (1.48) x (2.46) | 37.1 (1.46) | 59.7 (2.35) | 37.1 (1.46) | 45.8 (1.80) | 5.0 (.20) | 12.5 (.49) | 58.0 (2.28) | 1.7 (.07) |
| 37.5 x 75 (1.48) x (2.95) | 37.1 (1.46) | 72.4 (2.85) | 37.1 (1.46) | 57.6 (2.27) | 5.0 (.20) | 12.5 (.49) | 70.5 (2.78) | 1.8 (.07) |
| 50 x 50 (1.97) x (1.97) | 49.5 (1.95) | 48.0 (1.89) | 49.6 (1.95) | 34.8 (1.37) | 5.0 (.20) | 12.5 (.49) | 45.5 (1.79) | 1.7 (.07) |
| 50 x 75 (1.97) x (2.95) | 49.5 (1.95) | 72.4 (2.85) | 49.6 (1.95) | 57.6 (2.27) | 5.0 (.20) | 12.5 (.49) | 70.5 (2.78) | 1.9 (.08) |
| 50 x 100 (1.97) x (3.94) | 49.5 (1.95) | 97.8 (3.85) | 49.6 (1.95) | 81.0 (3.19) | 5.0 (.20) | 12.5 (.49) | 95.5 (3.76) | 2.2 (.09) |
| 62.5 x 37.5 (2.46) x (1.48) | 62.0 (2.44) | 35.8 (1.41) | 62.1 (2.44) | 24.7 (.97) | 5.0 (.20) | 12.5 (.49) | 33.0 (1.30) | 1.7 (.07) |
| 62.5 x 62.5 (2.46) x (2.46) | 62.0 (2.44) | 59.7 (2.35) | 62.1 (2.44) | 45.8 (1.80) | 5.0 (.20) | 12.5 (.49) | 58.0 (2.28) | 1.8 (.07) |
| 75 x 50 (2.95) x (1.97) | 74.7 (2.94) | 48.0 (1.89) | 74.6 (2.94) | 34.8 (1.37) | 5.0 (.20) | 12.5 (.49) | 45.5 (1.79) | 2.0 (.08) |
| 75 x 62.5 (2.95) x (2.46) | 74.7 (2.94) | 59.7 (2.35) | 74.6 (2.94) | 45.8 (1.80) | 5.0 (.20) | 12.5 (.49) | 58.0 (2.28) | 2.0 (.08) |
| 75 x 75 (2.95) x (2.95) | 74.7 (2.94) | 73.2 (2.88) | 74.6 (2.94) | 57.6 (2.27) | 5.0 (.20) | 12.5 (.49) | 70.5 (2.78) | 2.2 (.09) |
| 75 x 100 (2.95) x (3.94) | 74.7 (2.94) | 97.8 (3.85) | 74.6 (2.94) | 81.0 (3.19) | 5.0 (.20) | 12.5 (.49) | 95.5 (3.76) | 2.3 (.09) |
| 100 x 50 (3.94) x (1.97) | 99.6 (3.92) | 48.0 (1.89) | 99.6 (3.92) | 34.8 (1.37) | 5.0 (.20) | 12.5 (.49) | 45.5 (1.79) | 2.0 (.08) |
| 100 x 62.5 (3.94) x (2.46) | 99.6 (3.92) | 59.7 (2.35) | 99.6 (3.92) | 45.8 (1.80) | 5.0 (.20) | 12.5 (.49) | 58.0 (2.28) | 2.0 (.08) |
| 100 x 75 (3.94) x (2.95) | 99.6 (3.92) | 73.2 (2.88) | 99.6 (3.92) | 57.6 (2.27) | 5.0 (.20) | 12.5 (.49) | 70.5 (2.78) | 2.5 (.10) |
| 100 x 100 (3.94) x (3.94) | 99.6 (3.92) | 97.8 (3.85) | 99.6 (3.92) | 81.0 (3.19) | 5.0 (.20) | 12.5 (.49) | 99.5 (3.76) | 2.5 (.10) |

> Available for type MC wiring duct only.

PANDUCT® Type NNC Wiring Duct Dimensions

Dimensions are shown for reference only. Contact PANDUIT customer service at 800-777-3300 for specific dimensional needs.

For 25mm, 37.5mm, and 50mm high duct.

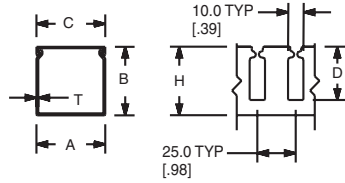

For 75mm and 100mm high duct.

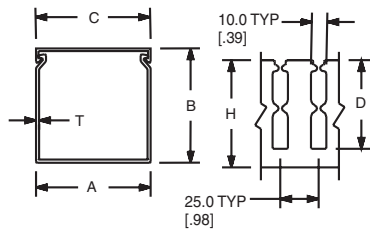

Mounting Hole Dimensions

For 25mm, 37.5mm, and 50mm width duct.

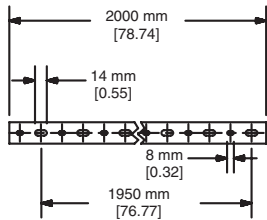

For 75mm and 100mm width duct.

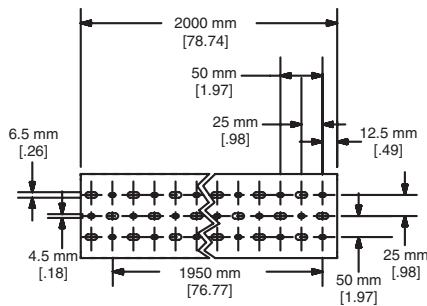

| Duct Size (W x H) | Dimensions – mm (Inches) | | | | | |
|--------------------------------|--------------------------|----------------|----------------|----------------|----------------|--------------|
| | A | B | C | D | H | T |
| 25 x 25 (.98) x (.98) | 24.6 (.97) | 23.6 (.93) | 24.6 (.97) | 13.6 (.54) | 20.3 (.80) | 1.5 (.06) |
| 25 x 37 (.98) x (1.48) | 24.6 (.97) | 35.8 (1.41) | 24.6 (.97) | 24.6 (.97) | 33.0 (1.30) | 1.8 (.07) |
| 25 x 50 (.98) x (1.97) | 24.6 (.97) | 47.8 (1.88) | 24.6 (.97) | 34.8 (1.37) | 45.5 (1.79) | 2.0 (.08) |
| 25 x 75 (.98) x (2.95) | 24.6 (.97) | 72.4 (2.85) | 24.6 (.97) | 57.6 (2.27) | 70.6 (2.78) | 2.0 (.08) |
| 37.5 x 37.5 (1.48) x (1.48) | 37.1 (1.46) | 35.8 (1.41) | 37.1 (1.46) | 24.7 (.97) | 33.0 (1.30) | 1.8 (.07) |
| 37.5 x 50 (1.48) x (1.97) | 37.1 (1.46) | 47.8 (1.88) | 37.1 (1.46) | 34.8 (1.37) | 45.5 (1.79) | 2.0 (.08) |
| 37.5 x 75 (1.48) x (2.95) | 37.1 (1.46) | 72.4 (2.85) | 37.1 (1.46) | 57.6 (2.27) | 70.6 (2.78) | 2.0 (.08) |
| 50 x 50 (1.97) x (1.97) | 49.5 (1.95) | 47.8 (1.88) | 49.5 (1.95) | 34.8 (1.37) | 45.5 (1.79) | 2.0 (.08) |
| 50 x 75 (1.97) x (2.95) | 49.5 (1.95) | 72.4 (2.85) | 49.5 (1.95) | 57.6 (2.27) | 70.6 (2.78) | 2.0 (.08) |
| 50 x 100 (1.97) x (3.94) | 49.5 (1.95) | 97.8 (3.85) | 49.5 (1.95) | 81.0 (3.19) | 95.5 (3.76) | 2.3 (.09) |
| 75 x 75 (2.95) x (2.95) | 74.7 (2.94) | 72.4 (2.85) | 74.7 (2.94) | 57.6 (2.27) | 70.6 (2.78) | 2.0 (.08) |
| 100 x 50 (3.94) x (1.97) | 99.6 (3.92) | 47.8 (1.88) | 99.6 (3.92) | 34.8 (1.37) | 45.5 (1.79) | 2.0 (.08) |
| 100 x 75 (3.94) x (2.95) | 99.6 (3.92) | 72.4 (2.85) | 99.6 (3.92) | 57.6 (2.27) | 70.6 (2.78) | 2.0 (.08) |
| 100 x 100 (3.92) x (3.85) | 99.6 (3.92) | 97.8 (3.85) | 99.6 (3.92) | 81.0 (3.19) | 95.5 (3.76) | 2.3 (.09) |

A.
System
Overview

B1.
Cable Ties

B2.
Cable
Accessories

B3.
Stainless
Steel Ties

C1.
Wiring
Duct

C2.
Surface
Raceway

C3.
Abrasion
Protection

C4.
Cable
Management

D1.
Terminals

D2.
Power
Connectors

D3.
Grounding
Connectors

E1.
Labeling
Systems

E2.
Labels

E3.
Pre-Printed
& Write-On
Markers

E4.
Permanent
Identification

E5.
Lockout/
Tagout/
& Safety
Solutions

F.
Index

A. System Overview

PANDUCT® Type NE Wiring Duct Dimensions

Dimensions are shown for reference only. Contact PANDUIT customer service at 800-777-3300 for specific dimensional needs.

B1. Cable Ties

B2. Cable Accessories

B3. Stainless Steel Ties

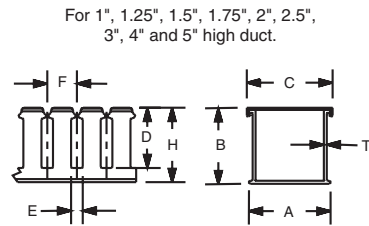
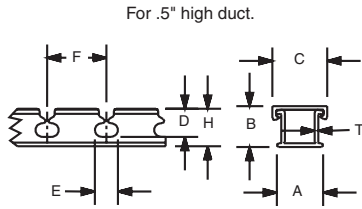

C1. Wiring Duct

C2. Surface Raceway

C3. Abrasion Protection

C4. Cable Management

Mounting Hole Dimensions
For .5", .75", 1" and 1.5" wide duct.

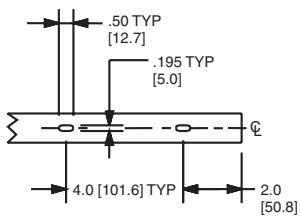

D1. Terminals

D2. Power Connectors

D3. Grounding Connectors

For 2.0", 2.5", 3" and 4" wide duct.

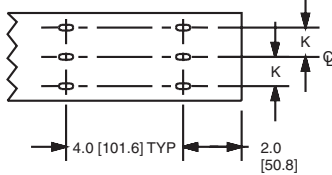

E1. Labeling Systems

E2. Labels

E3. Pre-Printed & Write-On Markers

E4. Permanent Identification

E5. Lockout/ Tagout & Safety Solutions

F. Index

| Duct Size (W x H) | Dimensions – Inches (mm) | | | | | | | | |
|----------------------------|--------------------------|-----------------|-----------------|-----------------|--------------|----------------|-----------------|---------------|--------------|
| | A | B | C | D | E | F | H | K | T |
| .5 x .5 (12.7) (12.7) | .63 (16.0) | .56 (14.2) | .69 (17.5) | .38 (9.7) | .37 (9.4) | .80 (20.3) | .50 (12.7) | ON CENTERLINE | .05 (1.3) |
| .5 x 1 (12.7) (25.4) | .63 (16.0) | 1.06 (26.9) | .69 (17.5) | .75 (19.1) | .31 (7.9) | .80 (20.3) | 1.00 (25.4) | | .06 (1.5) |
| 1 x 1 (25.4) (25.4) | 1.14 (29.0) | 1.06 (26.9) | 1.25 (31.8) | .75 (19.1) | .31 (7.9) | .80 (20.3) | 1.00 (25.4) | | .06 (1.5) |
| 1 x 1.5 (25.4) (38.1) | 1.14 (29.0) | 1.62 (41.1) | 1.25 (31.8) | 1.20 (30.5) | .31 (7.9) | .80 (20.3) | 1.50 (38.1) | | .07 (1.8) |
| 1 x 2 (25.4) (50.8) | 1.14 (29.0) | 2.06 (52.3) | 1.25 (31.8) | 1.63 (41.4) | .31 (7.9) | .80 (20.3) | 2.00 (50.8) | | .07 (1.8) |
| 1 x 3 (25.4) (76.2) | 1.14 (29.0) | 3.06 (77.7) | 1.25 (31.8) | 2.63 (66.8) | .31 (7.9) | 1.00 (25.4) | 3.00 (76.2) | | .07 (1.8) |
| 1 x 4 (25.4) (101.6) | 1.14 (29.0) | 4.06 (103.1) | 1.25 (31.8) | 3.63 (92.2) | .31 (7.9) | 1.00 (25.4) | 4.00 (101.6) | | .08 (2.0) |
| 1.5 x 1.5 (38.1) (38.1) | 1.64 (41.7) | 1.62 (41.1) | 1.75 (44.5) | 1.20 (30.5) | .31 (7.9) | .80 (20.3) | 1.50 (38.1) | | .07 (1.8) |
| 1.5 x 2 (38.1) (50.8) | 1.64 (41.7) | 2.06 (52.3) | 1.75 (44.5) | 1.63 (41.4) | .31 (7.9) | .80 (20.3) | 2.00 (50.8) | | .07 (1.8) |
| 1.5 x 3 (38.1) (76.2) | 1.64 (41.7) | 3.06 (77.7) | 1.75 (44.5) | 2.63 (66.8) | .31 (7.9) | 1.00 (25.4) | 3.00 (76.2) | | .07 (1.8) |
| 1.5 x 4 (38.1) (101.6) | 1.64 (41.7) | 4.06 (103.1) | 1.75 (44.5) | 3.63 (92.2) | .31 (7.9) | 1.00 (25.4) | 4.00 (101.6) | | .08 (2.0) |
| 2 x 1 (50.8) (25.4) | 2.14 (54.4) | 1.06 (26.9) | 2.25 (57.2) | .75 (19.1) | .31 (7.9) | .80 (20.3) | 1.00 (25.4) | | .06 (1.5) |
| 2 x 2 (50.8) (50.8) | 2.14 (54.4) | 2.06 (52.3) | 2.25 (57.2) | 1.63 (41.4) | .31 (7.9) | .80 (20.3) | 2.00 (50.8) | | .07 (1.8) |
| 2 x 3 (50.8) (76.2) | 2.14 (54.4) | 3.06 (77.7) | 2.25 (57.2) | 2.63 (66.8) | .31 (7.9) | 1.00 (25.4) | 3.00 (76.2) | | .07 (1.8) |
| 2 x 4 (50.8) (101.6) | 2.14 (54.4) | 4.06 (103.1) | 2.25 (57.2) | 3.63 (92.2) | .31 (7.9) | 1.00 (25.4) | 4.00 (101.6) | | .08 (2.0) |
| 3 x 1 (76.2) (25.4) | 3.14 (79.8) | 1.06 (26.9) | 3.25 (82.6) | .75 (19.1) | .31 (7.9) | .80 (20.3) | 1.00 (25.4) | | .06 (1.5) |
| 3 x 2 (76.2) (50.8) | 3.14 (79.8) | 2.06 (52.3) | 3.25 (82.6) | 1.63 (41.4) | .31 (7.9) | .80 (20.3) | 2.00 (50.8) | | .07 (1.7) |
| 3 x 3 (76.2) (76.2) | 3.14 (79.8) | 3.06 (77.7) | 3.25 (82.6) | 2.63 (66.8) | .31 (7.9) | 1.00 (25.4) | 3.00 (76.2) | | .07 (1.8) |
| 3 x 4 (76.2) (101.6) | 3.14 (79.8) | 4.06 (103.1) | 3.25 (82.6) | 3.63 (92.2) | .31 (7.9) | 1.00 (25.4) | 4.00 (101.6) | | .08 (2.0) |
| 3 x 5 (76.2) (127.0) | 3.14 (79.8) | 5.06 (128.5) | 3.25 (82.6) | 4.63 (117.6) | .38 (9.7) | 1.33 (33.8) | 5.00 (127.0) | | .09 (2.3) |
| 4 x 2 (101.6) (50.8) | 4.14 (105.2) | 2.06 (52.3) | 4.25 (108.0) | 1.63 (41.4) | .31 (7.9) | .80 (20.3) | 2.00 (50.8) | .07 (1.8) | |
| 4 x 3 (101.6) (76.2) | 4.14 (105.2) | 3.06 (77.7) | 4.25 (108.0) | 2.63 (66.8) | .31 (7.9) | 1.00 (25.4) | 3.00 (76.2) | .07 (1.8) | |
| 4 x 4 (101.6) (101.6) | 4.14 (105.2) | 4.06 (103.1) | 4.25 (108.0) | 3.63 (92.2) | .31 (7.9) | 1.00 (25.4) | 4.00 (101.6) | .08 (2.0) | |
| 4 x 5 (101.6) (127.0) | 4.14 (105.2) | 5.06 (128.5) | 4.25 (108.0) | 4.63 (117.6) | .38 (9.7) | 1.33 (33.8) | 5.00 (127.0) | .09 (2.3) | |

PANDUCT® Type H and HS Wiring Duct Dimensions

Dimensions are shown for reference only. Contact PANDUIT customer service at 800-777-3300 for specific dimensional needs.

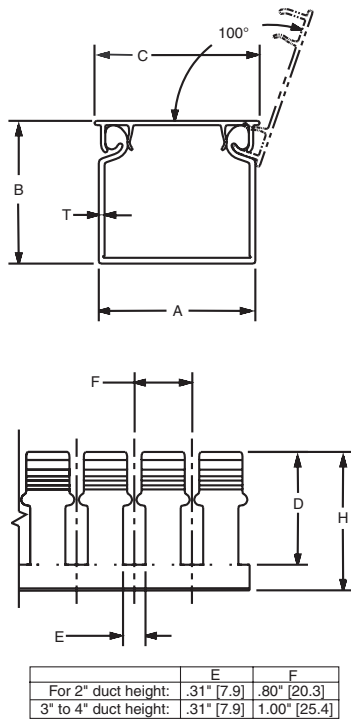

| Duct Size (W x H) | Dimensions – Inches (mm) | | | | | | | | |
|----------------------------|--------------------------|----------------|-----------------|----------------|--------------|----------------|-----------------|----------------|--------------|
| | A | B | C | D | E | F | H | K | T |
| 1.5 x 2 (38.1) x (50.8) | 1.75 (44.5) | 1.98 (50.3) | 1.88 (47.8) | 1.63 (41.4) | .31 (7.9) | .80 (20.3) | 1.92 (48.8) | On CL | .08 (2.0) |
| 1.5 x 3 (38.1) x (76.2) | 1.75 (44.5) | 3.06 (77.7) | 1.88 (47.8) | 2.63 (66.8) | .31 (7.9) | 1.00 (25.4) | 3.00 (76.2) | On CL | .10 (2.5) |
| 2 x 2 (50.8) x (50.8) | 2.17 (55.1) | 1.98 (50.3) | 2.29 (58.2) | 1.57 (39.9) | .31 (7.9) | .80 (20.3) | 1.92 (48.8) | .50 (12.7) | .08 (2.0) |
| 2 x 3 (50.8) x (76.2) | 2.17 (55.1) | 3.06 (77.7) | 2.29 (58.2) | 2.63 (66.8) | .31 (7.9) | 1.00 (25.4) | 3.00 (76.2) | .50 (12.7) | .10 (2.5) |
| 2 x 4 (50.8) x (101.6) | 2.17 (55.1) | 4.1 (104.1) | 4.38 (111.3) | 3.63 (92.2) | .31 (7.9) | 1.00 (25.4) | 4.00 (101.6) | .50 (12.7) | .10 (2.7) |
| 3 x 3 (76.2) x (76.2) | 3.25 (82.6) | 3.06 (77.7) | 3.38 (85.9) | 2.63 (66.8) | .31 (7.9) | 1.00 (25.4) | 3.00 (76.2) | 1.00 (25.4) | .10 (2.5) |
| 3 x 4 (76.2) x (101.6) | 3.25 (82.6) | 4.1 (104.1) | 3.38 (85.9) | 3.63 (92.2) | .31 (7.9) | 1.00 (25.4) | 4.00 (101.6) | 1.00 (25.4) | .11 (2.8) |
| 4 x 4 (101.6) x (101.6) | 4.25 (108.0) | 4.1 (104.1) | 4.38 (111.3) | 3.63 (92.2) | .31 (7.9) | 1.00 (25.4) | 4.00 (101.6) | 1.50 (38.1) | .11 (2.8) |

For 2", 3", and 4" wide duct.

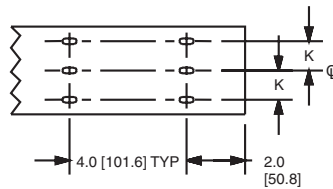

PANDUCT® Type HN Wiring Duct Dimensions

Dimensions are shown for reference only. Contact PANDUIT customer service at 800-777-3300 for specific dimensional needs.

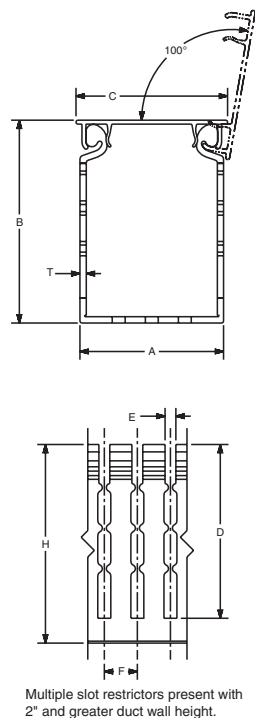

| Duct Size (W x H) | Dimensions – Inches (mm) | | | | | | | | |
|----------------------------|--------------------------|----------------|-----------------|----------------|--------------|---------------|-----------------|----------------|--------------|
| | A | B | C | D | E | F | H | K | T |
| 1.5 x 2 (38.1) x (50.8) | 1.75 (44.5) | 1.98 (50.3) | 1.88 (47.8) | 1.63 (41.4) | .20 (5.0) | .50 (12.7) | 1.92 (48.8) | On CL | .08 (2.0) |
| 1.5 x 3 (38.1) x (76.2) | 1.75 (44.5) | 3.06 (77.7) | 1.88 (47.8) | 2.63 (66.8) | .20 (5.0) | .50 (12.7) | 3.00 (76.2) | On CL | .10 (2.5) |
| 2 x 2 (50.8) x (50.8) | 2.17 (55.1) | 1.98 (50.3) | 2.29 (58.2) | 1.57 (39.9) | .20 (5.0) | .50 (12.7) | 1.92 (48.8) | .50 (12.7) | .08 (2.0) |
| 2 x 3 (50.8) x (76.2) | 2.17 (55.1) | 3.06 (77.7) | 2.29 (58.2) | 2.63 (66.8) | .20 (5.0) | .50 (12.7) | 3.00 (76.2) | .50 (12.7) | .10 (2.5) |
| 2 x 4 (50.8) x (101.6) | 2.17 (55.1) | 4.1 (104.1) | 4.38 (111.3) | 3.63 (92.2) | .20 (5.0) | .50 (12.7) | 4.00 (101.6) | .50 (12.7) | .10 (2.7) |
| 3 x 3 (76.2) x (76.2) | 3.25 (82.6) | 3.06 (77.7) | 3.38 (85.9) | 2.63 (66.8) | .20 (5.0) | .50 (12.7) | 3.00 (76.2) | 1.00 (25.4) | .10 (2.5) |
| 3 x 4 (76.2) x (101.6) | 3.25 (82.6) | 4.1 (104.1) | 3.38 (85.9) | 3.63 (92.2) | .20 (5.0) | .50 (12.7) | 4.00 (101.6) | 1.00 (25.4) | .11 (2.8) |
| 4 x 4 (101.6) x (101.6) | 4.25 (108.0) | 4.1 (104.1) | 4.38 (111.3) | 3.63 (92.2) | .20 (5.0) | .50 (12.7) | 4.00 (101.6) | 1.50 (38.1) | .11 (2.8) |

For 2", 3", and 4" wide duct.

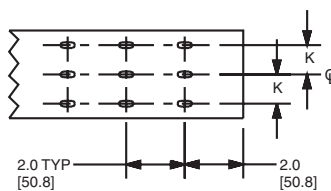

Multiple slot restrictors present with 2" and greater duct wall height.

A. System Overview

PANDUCT® Type FL Wiring Duct Dimensions

Dimensions are shown for reference only.
Dimensions are in mm (in.). Contact PANDUIT customer service at 800-777-3300 for specific dimensional needs.

B1. Cable Ties

B2. Cable Accessories

B3. Stainless Steel Ties

C1. Wiring Duct

C2. Surface Raceway

C3. Abrasion Protection

C4. Cable Management

D1. Terminals

D2. Power Connectors

D3. Grounding Connectors

E1. Labeling Systems

E2. Labels

E3. Pre-Printed & Write-On Markers

E4. Permanent Identification

E5. Lockout/Tagout & Safety Solutions

F. Index

Mounting Hole Dimensions For FL12X12LG-A

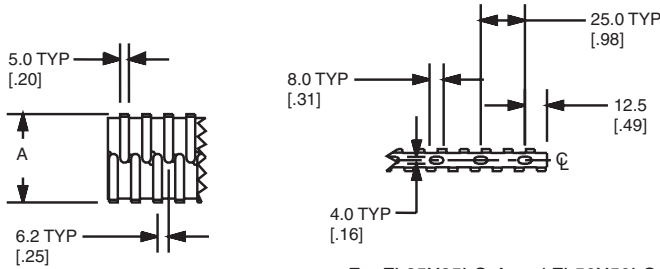

For FL25X25LG-A and FL50X50LG-A

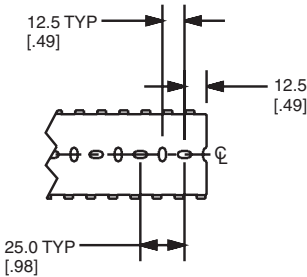

| Nominal Duct Size (W x H) mm | Dimensions – mm (In.) | |
|------------------------------------|--------------------------|---------------|
| | A | B |
| 12 x 12 (.49) x (.49) | 12.4 (.49) | 12.4 (.49) |
| 25 x 25 (.98) x (.98) | 24.9 (.98) | 24.9 (.98) |
| 50 x 50 (1.97) x (1.97) | 50 (1.97) | 50 (1.97) |

Note: Type FL wiring duct has factory applied adhesive. For 50 x 50 two strips of tape are used; otherwise, only one strip is centered on the part.

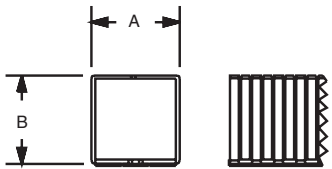

Note: 'B' dimension is without adhesive.

PANDUCT® PANELMAX™ Corner Wiring Duct – Wirefill Capacity

| Nominal Duct Size (W x H) In. | Area In. ² | Electrical | | | | | | | | | | | | | | | Communication | | | | |
|-------------------------------------|--------------------------|------------|------|--------|------|--------|------|--------|------|--------|------|--------|------|--------|------|--------|---------------|--------|-------------|------|-----|
| | | 8 AWG | | 10 AWG | | 12 AWG | | 14 AWG | | 16 AWG | | 18 AWG | | 22 AWG | | 23 AWG | 23/24 AWG | 24 AWG | Fiber Cable | | |
| | | .216 | .164 | .130 | .141 | .152 | .111 | .124 | .133 | .096 | .111 | .118 | .084 | .100 | .106 | .085 | .330 | .250 | .190 | .118 | |
| CWD3 | 4.4 x 3.6 | 17.580 | 188 | 326 | 520 | 442 | 380 | 713 | 571 | 496 | 953 | 713 | 631 | 1245 | 879 | 782 | 1216 | 80 | 140 | 243 | 630 |
| CWD4 | 5.4 x 4.6 | 26.920 | 288 | 500 | 796 | 677 | 582 | 1092 | 875 | 760 | 1460 | 1092 | 966 | 1907 | 1346 | 1197 | 1862 | 123 | 215 | 372 | 964 |

Table shows maximum wirefill based on 50% of duct internal cross sectional area. Formula = area/2.00 x D².

PANDUCT® Type H, HN and HS Wiring Duct – Wirefill Capacity

| Nominal Duct Size (W x H) In. | Nominal Area In. ² | Electrical | | | | | | | | | | | | | | | Communication | | | |
|-------------------------------------|----------------------------------|------------|------|--------|------|--------|------|--------|------|--------|------|--------|------|--------|------|--------|---------------|--------|-------------|------|
| | | 8 AWG | | 10 AWG | | 12 AWG | | 14 AWG | | 16 AWG | | 18 AWG | | 22 AWG | | 23 AWG | 23/24 AWG | 24 AWG | Fiber Cable | |
| | | .216 | .164 | .130 | .141 | .152 | .111 | .124 | .133 | .096 | .111 | .118 | .084 | .100 | .106 | .085 | .330 | .250 | .190 | .118 |
| 1.50 x 2.00 | 3.000 | 34 | 60 | 95 | 81 | 70 | 131 | 105 | 91 | 175 | 131 | 116 | 229 | 162 | 144 | 224 | 14 | 25 | 44 | 116 |
| 1.50 x 3.00 | 4.500 | 52 | 90 | 143 | 122 | 105 | 197 | 158 | 137 | 263 | 197 | 174 | 344 | 243 | 216 | 336 | 22 | 38 | 67 | 174 |
| 2.00 x 2.00 | 4.000 | 46 | 80 | 127 | 108 | 93 | 175 | 140 | 122 | 234 | 175 | 155 | 306 | 216 | 192 | 299 | 19 | 34 | 59 | 154 |
| 2.00 x 3.00 | 6.000 | 69 | 120 | 191 | 163 | 140 | 263 | 210 | 183 | 351 | 263 | 232 | 459 | 324 | 288 | 448 | 29 | 51 | 89 | 232 |
| 2.00 x 4.00 | 8.000 | 92 | 160 | 255 | 217 | 187 | 350 | 281 | 244 | 469 | 350 | 310 | 612 | 432 | 384 | 598 | 39 | 69 | 119 | 309 |
| 3.00 x 3.00 | 9.000 | 104 | 180 | 287 | 244 | 210 | 394 | 316 | 275 | 527 | 394 | 349 | 689 | 486 | 432 | 673 | 44 | 77 | 134 | 348 |
| 3.00 x 4.00 | 12.000 | 139 | 241 | 383 | 326 | 280 | 526 | 421 | 366 | 703 | 526 | 465 | 919 | 648 | 577 | 897 | 59 | 103 | 179 | 464 |
| 4.00 x 4.00 | 16.000 | 185 | 321 | 511 | 435 | 374 | 701 | 562 | 488 | 938 | 701 | 621 | 1225 | 864 | 769 | 1197 | 79 | 138 | 239 | 619 |

Table shows maximum wirefill based on 50% of duct internal cross sectional area. Formula = nominal area/1.85 x D². See page C1.48 for wiring duct color and size availability. AWG dimensions represent typical outer cable diameter in inches.

PANDUCT® Type D, G, F and FS Wiring Duct – Wirefill Capacity

| Nominal Duct Size (W x H) In. | Nominal Area In. ² | Electrical | | | | | | | | | | | | | | | Communication | | | | | |
|-------------------------------|-------------------------------|------------|------|--------|------|--------|------|------|--------|------|------|--------|------|------|--------|------|---------------|--------|---------|-----------|--------|-------------|
| | | 8 AWG | | 10 AWG | | 12 AWG | | | 14 AWG | | | 16 AWG | | | 18 AWG | | | 22 AWG | 23 AWG | 23/24 AWG | 24 AWG | Fiber Cable |
| | | .216 | .164 | .13 | .141 | .152 | .111 | .124 | .133 | .096 | .111 | .118 | .084 | .100 | .106 | .085 | .330 | .25 | .190 | .118 | | |
| | | THHN | THHN | THHN | MTW | MTW | THHN | MTW | MTW | TFFN | MTW | MTW | TFFN | MTW | MTW | MTW | Cat. 6A | Cat. 6 | Cat. 5e | 3.0 mm | | |
| 0.50 x 0.50 | 0.250 | 3 | 5 | 8 | 7 | 6 | 11 | 9 | 8 | 15 | 11 | 10 | 20 | 14 | 12 | 19 | 1 | 2 | 3 | 10 | | |
| 0.50 x 1.00 | 0.500 | 6 | 10 | 16 | 14 | 12 | 23 | 18 | 16 | 31 | 23 | 20 | 40 | 28 | 25 | 39 | 2 | 4 | 7 | 20 | | |
| 0.50 x 2.00 | 1.000 | 12 | 21 | 33 | 28 | 24 | 46 | 37 | 32 | 62 | 46 | 41 | 80 | 57 | 50 | 79 | 5 | 9 | 15 | 40 | | |
| 0.50 x 4.00 | 2.000 | 24 | 42 | 67 | 57 | 49 | 92 | 74 | 64 | 124 | 92 | 82 | 161 | 114 | 101 | 158 | 10 | 18 | 31 | 81 | | |
| 0.75 x 0.75 | 0.563 | 6 | 11 | 19 | 16 | 13 | 26 | 20 | 18 | 34 | 26 | 23 | 45 | 32 | 28 | 44 | 2 | 5 | 8 | 23 | | |
| 0.75 x 1.00 | 0.750 | 9 | 15 | 25 | 21 | 18 | 34 | 27 | 24 | 46 | 34 | 30 | 60 | 42 | 38 | 59 | 3 | 6 | 11 | 30 | | |
| 0.75 x 1.50 | 1.125 | 13 | 23 | 38 | 32 | 27 | 52 | 41 | 36 | 69 | 52 | 46 | 91 | 64 | 57 | 88 | 5 | 10 | 17 | 46 | | |
| 0.75 x 2.00 | 1.500 | 18 | 31 | 50 | 43 | 37 | 69 | 55 | 48 | 93 | 69 | 61 | 121 | 85 | 76 | 118 | 7 | 13 | 23 | 61 | | |
| 1.00 x 1.00 | 1.000 | 12 | 21 | 33 | 28 | 24 | 46 | 37 | 32 | 62 | 46 | 41 | 80 | 57 | 50 | 79 | 5 | 9 | 15 | 40 | | |
| 1.00 x 1.50 | 1.500 | 18 | 31 | 50 | 43 | 37 | 69 | 55 | 48 | 93 | 69 | 61 | 121 | 85 | 76 | 118 | 7 | 13 | 23 | 61 | | |
| 1.00 x 2.00 | 2.000 | 24 | 42 | 67 | 57 | 49 | 92 | 74 | 64 | 124 | 92 | 82 | 161 | 114 | 101 | 158 | 10 | 18 | 31 | 81 | | |
| 1.00 x 3.00 | 3.000 | 36 | 63 | 101 | 86 | 74 | 139 | 111 | 96 | 186 | 139 | 123 | 242 | 171 | 152 | 237 | 15 | 27 | 47 | 122 | | |
| 1.00 x 4.00 | 4.000 | 48 | 84 | 135 | 114 | 98 | 185 | 148 | 129 | 248 | 185 | 164 | 323 | 228 | 203 | 316 | 20 | 36 | 63 | 163 | | |
| 1.50 x 1.00 | 1.500 | 18 | 31 | 50 | 43 | 37 | 69 | 55 | 48 | 93 | 69 | 61 | 121 | 85 | 76 | 118 | 7 | 13 | 23 | 61 | | |
| 1.50 x 1.50 | 2.250 | 27 | 47 | 76 | 64 | 55 | 104 | 83 | 72 | 139 | 104 | 92 | 182 | 128 | 114 | 177 | 11 | 20 | 35 | 92 | | |
| 1.50 x 2.00 | 3.000 | 36 | 63 | 101 | 86 | 74 | 139 | 111 | 96 | 186 | 139 | 123 | 242 | 171 | 152 | 237 | 15 | 27 | 47 | 122 | | |
| 1.50 x 3.00 | 4.500 | 55 | 95 | 152 | 129 | 111 | 208 | 167 | 145 | 279 | 208 | 184 | 364 | 257 | 228 | 355 | 23 | 41 | 71 | 184 | | |
| 1.50 x 4.00 | 6.000 | 73 | 127 | 202 | 172 | 148 | 278 | 222 | 193 | 372 | 278 | 246 | 485 | 342 | 305 | 474 | 31 | 54 | 94 | 245 | | |
| 2.00 x 1.00 | 2.000 | 24 | 42 | 67 | 57 | 49 | 92 | 74 | 64 | 124 | 92 | 82 | 161 | 114 | 101 | 158 | 10 | 18 | 31 | 81 | | |
| 2.00 x 1.50 | 3.000 | 36 | 63 | 101 | 86 | 74 | 139 | 111 | 96 | 186 | 139 | 123 | 242 | 171 | 152 | 237 | 15 | 27 | 47 | 122 | | |
| 2.00 x 2.00 | 4.000 | 48 | 84 | 135 | 114 | 98 | 185 | 148 | 129 | 248 | 185 | 164 | 323 | 228 | 203 | 316 | 20 | 36 | 63 | 163 | | |
| 2.00 x 3.00 | 6.000 | 73 | 127 | 202 | 172 | 148 | 278 | 222 | 193 | 372 | 278 | 246 | 485 | 342 | 305 | 474 | 31 | 54 | 94 | 245 | | |
| 2.00 x 4.00 | 8.000 | 97 | 169 | 270 | 229 | 197 | 371 | 297 | 258 | 496 | 371 | 328 | 647 | 457 | 406 | 632 | 41 | 73 | 126 | 327 | | |
| 2.00 x 5.00 | 10.000 | 122 | 212 | 338 | 287 | 247 | 463 | 371 | 323 | 620 | 463 | 410 | 809 | 571 | 508 | 790 | 52 | 91 | 158 | 409 | | |
| 2.50 x 3.00 | 7.500 | 91 | 159 | 253 | 215 | 185 | 347 | 278 | 242 | 465 | 347 | 307 | 607 | 428 | 381 | 593 | 39 | 68 | 118 | 307 | | |
| 3.00 x 1.00 | 3.000 | 36 | 63 | 101 | 86 | 74 | 139 | 111 | 96 | 186 | 139 | 123 | 242 | 171 | 152 | 237 | 15 | 27 | 47 | 122 | | |
| 3.00 x 2.00 | 6.000 | 73 | 127 | 202 | 172 | 148 | 278 | 222 | 193 | 372 | 278 | 246 | 485 | 342 | 305 | 474 | 31 | 54 | 94 | 245 | | |
| 3.00 x 3.00 | 9.000 | 110 | 191 | 304 | 258 | 222 | 417 | 334 | 290 | 558 | 417 | 369 | 728 | 514 | 457 | 711 | 47 | 82 | 142 | 368 | | |
| 3.00 x 4.00 | 12.000 | 146 | 254 | 405 | 344 | 296 | 556 | 445 | 387 | 744 | 556 | 492 | 971 | 685 | 610 | 949 | 62 | 109 | 189 | 491 | | |
| 3.00 x 5.00 | 15.000 | 183 | 318 | 507 | 431 | 370 | 695 | 557 | 484 | 930 | 695 | 615 | 1214 | 857 | 762 | 1186 | 78 | 137 | 237 | 614 | | |
| 4.00 x 1.50 | 6.000 | 73 | 127 | 202 | 172 | 148 | 278 | 222 | 193 | 372 | 278 | 246 | 485 | 342 | 305 | 474 | 31 | 54 | 94 | 245 | | |
| 4.00 x 2.00 | 8.000 | 97 | 169 | 270 | 229 | 197 | 371 | 297 | 258 | 496 | 371 | 328 | 647 | 457 | 406 | 632 | 41 | 73 | 126 | 327 | | |
| 4.00 x 3.00 | 12.000 | 146 | 254 | 405 | 344 | 296 | 556 | 445 | 387 | 744 | 556 | 492 | 971 | 685 | 610 | 949 | 62 | 109 | 189 | 491 | | |
| 4.00 x 4.00 | 16.000 | 195 | 339 | 540 | 459 | 395 | 742 | 594 | 516 | 992 | 742 | 656 | 1295 | 914 | 813 | 1265 | 83 | 146 | 253 | 655 | | |
| 4.00 x 5.00 | 20.000 | 244 | 424 | 676 | 574 | 494 | 927 | 743 | 646 | 1240 | 927 | 820 | 1619 | 1142 | 1017 | 1581 | 104 | 182 | 316 | 819 | | |
| 6.00 x 4.00 | 24.000 | 293 | 509 | 811 | 689 | 593 | 1113 | 891 | 775 | 1488 | 1113 | 984 | 1943 | 1371 | 1220 | 1898 | 125 | 219 | 379 | 983 | | |

Table shows maximum wirefill based on 50% of duct internal cross sectional area. Formula = nominal area/1.75 x D². See page C1.48 for wiring duct color and size availability. Not all sizes available for each duct type. AWG dimensions represent typical outer cable diameter in inches.

A. System Overview

B1. Cable Ties

B2. Cable Accessories

B3. Stainless Steel Ties

C1. Wiring Duct

C2. Surface Raceway

C3. Abrasion Protection

C4. Cable Management

D1. Terminals

D2. Power Connectors

D3. Grounding Connectors

E1. Labeling Systems

E2. Labels

E3. Pre-Printed & Write-On Markers

E4. Permanent Identification

E5. Lockout/Tagout & Safety Solutions

F. Index

A. System Overview

PANDUCT® Type MC, NNC and TMC Wiring Duct – Wirefill Capacity

| Nominal Duct Size (W x H) mm | Nominal Area mm ² | Electrical | | | | | | | | | | | | | | | Communication | | | | | | |
|------------------------------|------------------------------|------------|------|--------|-----|-----|--------|-----|-----|--------|-----|-----|--------|-----|-----|--------|---------------|--------|---------|--------|-----------|--------|-------------|
| | | 8 AWG | | 10 AWG | | | 12 AWG | | | 14 AWG | | | 16 AWG | | | 18 AWG | | | 22 AWG | 23 AWG | 23/24 AWG | 24 AWG | Fiber Cable |
| | | 5.5 | 4.2 | 3.3 | 3.6 | 3.9 | 2.8 | 3.1 | 3.4 | 2.4 | 2.8 | 3 | 2.1 | 2.5 | 2.7 | 2.2 | 8.4 | 6.4 | 4.8 | 3 | | | |
| | | THHN | THHN | THHN | MTW | MTW | THHN | MTW | MTW | TFFN | MTW | MTW | TFFN | MTW | MTW | MTW | Cat. 6A | Cat. 6 | Cat. 5e | 3.0 mm | | | |
| 25 x 25 | 625 | 11 | 20 | 32 | 27 | 23 | 44 | 36 | 31 | 60 | 44 | 39 | 78 | 55 | 49 | 76 | 5 | 8 | 15 | 39 | | | |
| 25 x 37 | 925 | 17 | 30 | 48 | 41 | 35 | 66 | 53 | 46 | 88 | 66 | 58 | 116 | 81 | 72 | 113 | 7 | 13 | 22 | 58 | | | |
| 25 x 50 | 1250 | 23 | 41 | 65 | 55 | 47 | 89 | 72 | 62 | 120 | 89 | 79 | 156 | 110 | 98 | 153 | 10 | 17 | 30 | 79 | | | |
| 25 x 62 | 1550 | 29 | 51 | 81 | 69 | 59 | 111 | 89 | 77 | 148 | 111 | 98 | 194 | 137 | 122 | 190 | 12 | 21 | 38 | 98 | | | |
| 25 x 75 | 1875 | 35 | 61 | 98 | 83 | 71 | 134 | 108 | 93 | 180 | 134 | 119 | 235 | 166 | 147 | 229 | 15 | 26 | 46 | 119 | | | |
| 37 x 37 | 1369 | 25 | 45 | 71 | 60 | 52 | 98 | 78 | 68 | 131 | 98 | 87 | 171 | 121 | 107 | 167 | 11 | 19 | 33 | 86 | | | |
| 37 x 50 | 1850 | 35 | 60 | 96 | 82 | 70 | 132 | 106 | 92 | 177 | 132 | 117 | 232 | 163 | 145 | 226 | 15 | 26 | 45 | 117 | | | |
| 37 x 62 | 2294 | 43 | 75 | 120 | 102 | 87 | 164 | 132 | 114 | 220 | 164 | 145 | 287 | 203 | 180 | 281 | 18 | 32 | 56 | 145 | | | |
| 37 x 75 | 2775 | 52 | 91 | 145 | 123 | 106 | 199 | 159 | 138 | 266 | 199 | 176 | 348 | 245 | 218 | 340 | 22 | 39 | 68 | 176 | | | |
| 50 x 50 | 2500 | 47 | 82 | 131 | 111 | 95 | 179 | 144 | 125 | 240 | 179 | 159 | 313 | 221 | 197 | 306 | 20 | 35 | 61 | 158 | | | |
| 50 x 75 | 3750 | 71 | 123 | 196 | 167 | 143 | 269 | 216 | 187 | 360 | 269 | 238 | 470 | 332 | 295 | 459 | 30 | 53 | 92 | 238 | | | |
| 50 x 100 | 5000 | 94 | 164 | 262 | 222 | 191 | 359 | 288 | 250 | 480 | 359 | 318 | 627 | 442 | 394 | 612 | 40 | 70 | 122 | 317 | | | |
| 62 x 37 | 2294 | 43 | 75 | 120 | 102 | 87 | 164 | 132 | 114 | 220 | 164 | 145 | 287 | 203 | 180 | 281 | 18 | 32 | 56 | 145 | | | |
| 62 x 62 | 3844 | 72 | 126 | 201 | 171 | 147 | 276 | 221 | 192 | 369 | 276 | 244 | 482 | 340 | 303 | 471 | 31 | 54 | 94 | 244 | | | |
| 75 x 50 | 3750 | 71 | 123 | 196 | 167 | 143 | 269 | 216 | 187 | 360 | 269 | 238 | 470 | 332 | 295 | 459 | 30 | 53 | 92 | 238 | | | |
| 75 x 62 | 4650 | 88 | 153 | 243 | 207 | 178 | 334 | 267 | 232 | 446 | 334 | 295 | 583 | 411 | 366 | 570 | 37 | 65 | 114 | 295 | | | |
| 75 x 75 | 5625 | 106 | 185 | 294 | 250 | 215 | 404 | 324 | 281 | 540 | 404 | 357 | 706 | 498 | 443 | 689 | 45 | 79 | 138 | 357 | | | |
| 75 x 100 | 7500 | 142 | 246 | 393 | 334 | 287 | 539 | 432 | 375 | 720 | 539 | 477 | 941 | 664 | 591 | 919 | 60 | 106 | 184 | 476 | | | |
| 100 x 50 | 5000 | 94 | 164 | 262 | 222 | 191 | 359 | 288 | 250 | 480 | 359 | 318 | 627 | 442 | 394 | 612 | 40 | 70 | 122 | 317 | | | |
| 100 x 62 | 6200 | 117 | 204 | 324 | 276 | 237 | 445 | 357 | 310 | 595 | 445 | 394 | 778 | 549 | 488 | 760 | 50 | 87 | 152 | 393 | | | |
| 100 x 75 | 7500 | 142 | 246 | 393 | 334 | 287 | 539 | 432 | 375 | 720 | 539 | 477 | 941 | 664 | 591 | 919 | 60 | 106 | 184 | 476 | | | |
| 100 x 100 | 10000 | 189 | 329 | 524 | 445 | 383 | 718 | 576 | 500 | 961 | 718 | 636 | 1255 | 885 | 788 | 1225 | 81 | 141 | 245 | 634 | | | |

Table shows maximum wirefill based on 50% of duct internal cross sectional area. Formula = nominal area/1.75 x D². See page C1.48 for wiring duct color and size availability. Not all sizes available for each duct type. AWG dimensions represent typical outer cable diameter in millimeters.

D1. Terminals

D2. Power Connectors

D3. Grounding Connectors

E1. Labeling Systems

E2. Labels

E3. Pre-Printed & Write-On Markers

E4. Permanent Identification

E5. Lockout/Tagout & Safety Solutions

F. Index

PANDUCT® Type NE Wiring Duct – Wirefill Capacity

| Nominal Duct Size (W x H) In. | Nominal Area In. ² | Electrical | | | | | | | | | | | | | | | Communication | | | | | |
|-------------------------------|-------------------------------|------------|------|--------|------|--------|------|------|--------|------|------|--------|------|------|--------|------|---------------|--------|---------|-----------|--------|-------------|
| | | 8 AWG | | 10 AWG | | 12 AWG | | | 14 AWG | | | 16 AWG | | | 18 AWG | | | 22 AWG | 23 AWG | 23/24 AWG | 24 AWG | Fiber Cable |
| | | .216 | .164 | .130 | .141 | .152 | .111 | .124 | .133 | .096 | .111 | .118 | .084 | .100 | .106 | .085 | .330 | .25 | .190 | .118 | | |
| | | THHN | THHN | THHN | MTW | MTW | THHN | MTW | MTW | TFFN | MTW | MTW | TFFN | MTW | MTW | MTW | Cat. 6A | Cat. 6 | Cat. 5e | 3.0 mm | | |
| 0.50 x 0.50 | 0.250 | 2 | 4 | 7 | 6 | 5 | 10 | 8 | 7 | 13 | 10 | 8 | 17 | 12 | 11 | 17 | 1 | 2 | 3 | 8 | | |
| 0.50 x 1.00 | 0.500 | 5 | 9 | 14 | 12 | 10 | 20 | 16 | 14 | 27 | 20 | 17 | 35 | 25 | 22 | 34 | 2 | 4 | 6 | 17 | | |
| 1.00 x 1.00 | 1.000 | 10 | 18 | 29 | 25 | 21 | 40 | 32 | 28 | 54 | 40 | 35 | 70 | 50 | 44 | 69 | 4 | 8 | 13 | 35 | | |
| 1.00 x 1.50 | 1.500 | 16 | 27 | 44 | 37 | 32 | 60 | 48 | 42 | 81 | 60 | 53 | 106 | 75 | 66 | 103 | 6 | 12 | 20 | 53 | | |
| 1.00 x 2.00 | 2.000 | 21 | 37 | 59 | 50 | 43 | 81 | 65 | 56 | 108 | 81 | 71 | 141 | 100 | 88 | 138 | 9 | 16 | 27 | 71 | | |
| 1.00 x 3.00 | 3.000 | 32 | 55 | 88 | 75 | 64 | 121 | 97 | 84 | 162 | 121 | 107 | 212 | 150 | 133 | 207 | 13 | 24 | 41 | 107 | | |
| 1.00 x 4.00 | 4.000 | 42 | 74 | 118 | 100 | 86 | 162 | 130 | 113 | 217 | 162 | 143 | 283 | 200 | 177 | 276 | 18 | 32 | 55 | 143 | | |
| 1.50 x 1.50 | 2.250 | 24 | 41 | 66 | 56 | 48 | 91 | 73 | 63 | 122 | 91 | 80 | 159 | 112 | 100 | 155 | 10 | 18 | 31 | 80 | | |
| 1.50 x 2.00 | 3.000 | 32 | 55 | 88 | 75 | 64 | 121 | 97 | 84 | 162 | 121 | 107 | 212 | 150 | 133 | 207 | 13 | 24 | 41 | 107 | | |
| 1.50 x 3.00 | 4.500 | 48 | 83 | 133 | 113 | 97 | 182 | 146 | 127 | 244 | 182 | 161 | 318 | 225 | 200 | 311 | 20 | 36 | 62 | 161 | | |
| 1.50 x 4.00 | 6.000 | 64 | 111 | 177 | 150 | 129 | 243 | 195 | 169 | 325 | 243 | 215 | 425 | 300 | 266 | 415 | 27 | 48 | 83 | 215 | | |
| 2.00 x 1.00 | 2.000 | 21 | 37 | 59 | 50 | 43 | 81 | 65 | 56 | 108 | 81 | 71 | 141 | 100 | 88 | 138 | 9 | 16 | 27 | 71 | | |
| 2.00 x 2.00 | 4.000 | 42 | 74 | 118 | 100 | 86 | 162 | 130 | 113 | 217 | 162 | 143 | 283 | 200 | 177 | 276 | 18 | 32 | 55 | 143 | | |
| 2.00 x 3.00 | 6.000 | 64 | 111 | 177 | 150 | 129 | 243 | 195 | 169 | 325 | 243 | 215 | 425 | 300 | 266 | 415 | 27 | 48 | 83 | 215 | | |
| 2.00 x 4.00 | 8.000 | 85 | 148 | 236 | 201 | 173 | 324 | 260 | 226 | 434 | 324 | 287 | 566 | 400 | 355 | 553 | 36 | 64 | 110 | 286 | | |
| 3.00 x 1.00 | 3.000 | 32 | 55 | 88 | 75 | 64 | 121 | 97 | 84 | 162 | 121 | 107 | 212 | 150 | 133 | 205 | 13 | 24 | 41 | 107 | | |
| 3.00 x 2.00 | 6.000 | 64 | 111 | 177 | 150 | 129 | 243 | 195 | 169 | 325 | 243 | 215 | 425 | 300 | 266 | 415 | 27 | 48 | 83 | 215 | | |
| 3.00 x 3.00 | 9.000 | 96 | 167 | 266 | 226 | 194 | 365 | 292 | 254 | 488 | 365 | 323 | 637 | 450 | 400 | 622 | 41 | 72 | 124 | 322 | | |
| 3.00 x 4.00 | 12.000 | 128 | 223 | 355 | 301 | 259 | 486 | 390 | 339 | 651 | 486 | 430 | 850 | 600 | 533 | 830 | 55 | 96 | 166 | 430 | | |
| 3.00 x 5.00 | 15.000 | 160 | 278 | 443 | 377 | 324 | 608 | 487 | 423 | 813 | 608 | 538 | 1062 | 750 | 667 | 1038 | 68 | 120 | 207 | 537 | | |
| 4.00 x 2.00 | 8.000 | 85 | 148 | 236 | 201 | 173 | 324 | 260 | 226 | 434 | 324 | 287 | 566 | 400 | 355 | 553 | 36 | 64 | 110 | 286 | | |
| 4.00 x 3.00 | 12.000 | 128 | 223 | 355 | 301 | 259 | 486 | 390 | 339 | 651 | 486 | 430 | 850 | 600 | 533 | 830 | 55 | 96 | 166 | 430 | | |
| 4.00 x 4.00 | 16.000 | 171 | 297 | 473 | 402 | 346 | 649 | 520 | 452 | 868 | 649 | 574 | 1133 | 800 | 711 | 1107 | 73 | 128 | 221 | 573 | | |
| 4.00 x 5.00 | 20.000 | 214 | 371 | 591 | 502 | 432 | 811 | 650 | 565 | 1085 | 811 | 718 | 1417 | 1000 | 889 | 1384 | 91 | 160 | 277 | 716 | | |

Table shows maximum wirefill based on 50% of duct internal cross sectional area. Formula = nominal area/2.00 x D². AWG dimensions represent typical outer cable diameter in inches.

PANDUCT® Type FL Wiring Duct – Wirefill Capacity

| Nominal Duct Size (W x H) mm | Nominal Area mm ² | Electrical | | | | | | | | | | | | | | | Communication | | | | | |
|------------------------------|------------------------------|------------|------|--------|-----|--------|------|-----|--------|------|-----|--------|------|-----|--------|-----|---------------|--------|---------|-----------|--------|-------------|
| | | 8 AWG | | 10 AWG | | 12 AWG | | | 14 AWG | | | 16 AWG | | | 18 AWG | | | 22 AWG | 23 AWG | 23/24 AWG | 24 AWG | Fiber Cable |
| | | 5.5 | 4.2 | 3.3 | 3.6 | 3.9 | 2.8 | 3.1 | 3.4 | 2.4 | 2.8 | 3.0 | 2.1 | 2.5 | 2.7 | 2.2 | 8.4 | 6.4 | 4.8 | 3.0 | | |
| | | THHN | THHN | THHN | MTW | MTW | THHN | MTW | MTW | TFFN | MTW | MTW | TFFN | MTW | MTW | MTW | Cat. 6A | Cat. 6 | Cat. 5e | 3.0 mm | | |
| 12 x 12 | 144 | 1 | 3 | 5 | 4 | 3 | 7 | 5 | 5 | 9 | 7 | 6 | 12 | 8 | 7 | 12 | 0 | 1 | 2 | 6 | | |
| 25 x 25 | 625 | 8 | 14 | 22 | 19 | 16 | 31 | 25 | 21 | 42 | 31 | 27 | 54 | 38 | 34 | 53 | 3 | 6 | 10 | 27 | | |
| 50 x 50 | 2500 | 33 | 57 | 91 | 77 | 67 | 125 | 100 | 87 | 168 | 125 | 111 | 219 | 155 | 137 | 214 | 14 | 24 | 42 | 111 | | |

Table shows maximum wirefill based on 50% of duct internal cross sectional area. Formula = nominal area/2.50 x D². AWG dimensions represent typical outer cable diameter in millimeters.

A. System Overview

B1. Cable Ties

B2. Cable Accessories

B3. Stainless Steel Ties

C1. Wiring Duct

C2. Surface Raceway

C3. Abrasion Protection

C4. Cable Management

D1. Terminals

D2. Power Connectors

D3. Grounding Connectors

E1. Labeling Systems

E2. Labels

E3. Pre-Printed & Write-On Markers

E4. Permanent Identification

E5. Lockout/Tagout & Safety Solutions

F. Index

A. System Overview

Wirefill Formula

B1. Cable Ties

General Formula

PANDUIT Wiring Duct wirefills are calculated using the following general formula:

$$50\% \text{ Wirefill} = 50\% \text{ of } \left(\frac{\text{Usable Duct Area}}{\text{Wire Area}} \right)$$

B2. Cable Accessories

B3. Stainless Steel Ties

Why use a 50% Wirefill?

As specified in NFPA79-2007 section 13.5.2, *Percentage Fills of Raceways (Ducts)*, a 50% wirefill is given as the maximum wirefill capacity in all PANDUIT Wiring Ducts. This helps ensure general safe wiring practices are followed. In actual practice, a 50% wirefill is the maximum amount of wiring the duct can hold given the additional airspace created between cables by non-uniform cable shapes, cable interlacing, and cable packing factors.

C1. Wiring Duct

C2. Surface Raceway

What is the Usable Duct Area?

The usable area we define as the calculation of internal area that can be occupied by wires or cables.

Calculation of Internal Area

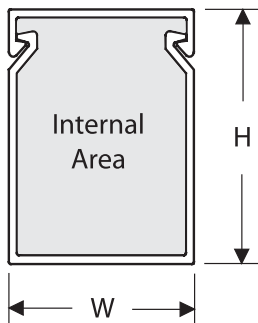

Since we use the outer channel dimensions in our calculation we make an adjustment in our formula for the thickness of material and for design elements that extend inside the channel.

Air Space Allotment

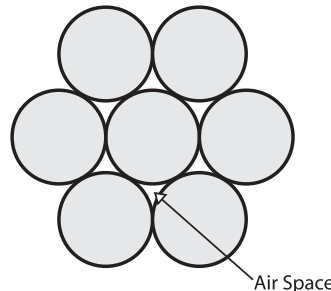

In our wirefill formula an adjustment is made to the channel internal area to account for “unused” air space that will be present between cables when placed in the channel. Our formula assumes a uniform close packed or high-density cable arrangement (see diagram) (Note 1).

D1. Terminals

D2. Power Connectors

Considering these factors the usable duct area is equal to an average of 90% of the nominal area, or $(W \times H) \times .90$.

D3. Grounding Connectors

Wire Area

The wire area formula is converted to allow calculation using the cable diameter:

$$\begin{aligned} A_{\text{WIRE}} &= \pi r^2 \\ A_{\text{WIRE}} &= (\pi/4) \times D^2 \\ A_{\text{WIRE}} &= .785 \times D^2 \end{aligned}$$

E1. Labeling Systems

E2. Labels

Formula Derivation

Inserting the elements from above into the general formula results in the following:

$$50\% \text{ Wirefill} = .50 \left(\frac{(W \times H) \times .90}{.785 \times D^2} \right)$$

Simplifying this formula results in the formula used for wirefill calculation (Note 2):

$$50\% \text{ Wirefill} = \left(\frac{W \times H}{1.75 \times D^2} \right)$$

E3. Pre-Printed & Write-On Markers

E4. Permanent Identification

E5. Lockout/Tagout & Safety Solutions

Note: When calculating wirefill capacity using the above formula, variables W, H and D must be expressed in same units (i.e. mm or inches).

¹ This calculation does not account for additional airspace created between cables by non-uniform cable shapes, cable interlacing, and cable packing factors.
² The resulting formula is used for all PANDUIT flush cover ducts, this excludes type NE duct which has a different profile design that results in a divisor of $2.0 \times D^2$ (rather than $1.75 \times D^2$ as shown here) and type H and HS wiring duct with a profile design that results in a divisor of $1.85 \times D^2$ and corner wiring duct which uses calculated internal area and a divisor of $2.0 \times D^2$.

PANDUCT® Wiring Duct and Raceway – Material Specifications

| Properties | Units | Test Method | Lead-Free PVC | Halogen-Free Modified PPO (NNC) | NORYL* (NE) | Polypropylene (FL) | Low Smoke/ Low Toxicity (TMC) |
|--------------------------------------|----------------------------------|-------------|---------------|---------------------------------|-------------|--------------------|-------------------------------|
| General | | | | | | | |
| Specific gravity | g/cc | ASTM D 792 | 1.45 | 1.09 | 1.08 | .95 | 1.56 |
| Heat deflection temperature @264 psi | °F | ASTM D 648 | 156 | 215 | 212 | 117 | 222 |
| Thermal expansion | 10 – 5 in./in./°F | ASTM D 696 | 3.7 | 3.8 | 3.8 | N/A | 3.8 |
| Thermal conductivity | (BTU-in./hr-ft. ²)°F | ASTM C 177 | 1.3 | 1.3 | 1.1 | N/A | N/A |
| Burning Characteristics | | | | | | | |
| Flammability class | — | UL 94 | V-0 | V-0 | V-1 | V-2 | V-0 |
| Smoke density @ 4 minutes | — | ASTM E 662 | 538 | 513 | 782 | N/A | 92 |
| Limited oxygen index (LOI) | — | ASTM D 2863 | 35 | 30 | 30 | 25 | 58 |
| Peak heat release rate | kW/m2 | ASTM E 1354 | N/A | N/A | N/A | N/A | 49.3 |
| Hardness | | | | | | | |
| Durometer hardness | “D” | ASTM D 2240 | 78 | N/A | 85 | N/A | N/A |
| Rockwell hardness | “R” | ASTM D 785 | 111 | 116 | 115 | N/A | 118 |
| Tensile | | | | | | | |
| Yield strength | psi | ASTM D 638 | 6,200 | 7,700 | 6,900 | 3,770 | 6,600 |
| Modulus | psi | ASTM D 638 | 390,000 | 350,000 | 380,000 | 172,000 | 316,000 |
| Flexural | | | | | | | |
| Yield strength | psi | ASTM D 790 | 8,700 | 11,500 | 11,400 | 4,350 | 11,900 |
| Modulus | psi | ASTM D 790 | 325,000 | 340,000 | 365,000 | 181,250 | 317,000 |
| Impact strength | | | | | | | |
| Notched Izod (.125”) | | ASTM D 256 | | | | | |
| 23°C (73°F) | ft.-lb./in. | | 4.0 | 5.0 | 5.0 | 1.8 | 3.0 |
| 0°C (32°F) | ft.-lb./in. | | 1.6 | 2.0 | N/A | N/A | N/A |
| Electrical Properties | | | | | | | |
| Power factor: | | ASTM D 150 | | | | | |
| 60 Hz @30°C (86°F) | — | | 2.90 | N/A | N/A | N/A | N/A |
| 1 MHz @30°C (86°F) | — | | 4.00 | N/A | N/A | N/A | N/A |
| Dielectric constant: | | ASTM D 150 | | | | | |
| 60 Hz @30°C (86°F) | — | | 3.90 | N/A | 2.65 | N/A | N/A |
| 1 MHz @30°C (86°F) | — | | 3.30 | N/A | N/A | N/A | N/A |
| Dielectric strength: | | ASTM D 149 | | | | | |
| Unconditioned | volts/mil | | 690 | N/A | 400 | N/A | N/A |
| Conditioned | volts/mil | | 700 | N/A | N/A | N/A | N/A |

Note: To the best of our knowledge the above information is accurate.
 PANDUIT assumes no liability for the accuracy or completeness of this information.

Rigid Polyvinyl Chloride (PVC)

A general purpose material for use in indoor applications. PVC has a UL flammability rating of V-0 and is UL 94 Recognized for continuous use temperatures up to 122°F (50°C). PVC is an economical wiring duct material.

Halogen-Free (Modified PPO)

A special purpose material for use in halogen-free or high temperature applications. Modified PPO has a UL 94 flammability rating of V-0 and is UL Recognized for continuous use temperatures up to 203°F (95°C), and is 20% lighter than PVC.

NORYL* Halogen-Free

A special purpose material for use in halogen-free or high temperature applications. NORYL* has a UL 94 flammability rating of V-1 and is UL Recognized for continuous use temperatures up to 203°F (95°C), and is 20% lighter than PVC.

Polypropylene

A flexible material with a UL 94 flammability rating of V-2 and that is UL Recognized for continuous use temperatures up to 149°F (65°C).

Low Smoke/ Low Toxicity

A special purpose material for use where low smoke, low toxicity and low flammability characteristics are critical. Ideally suited for transportation industry regulations. Low smoke/ low toxicity has a UL 94 flammability rating of V-0 and is UL Recognized for continuous use temperatures up to 176°F (80°C).

*NORYL is a registered trademark of General Electric Company.

A. System Overview

B1. Cable Ties

B2. Cable Accessories

B3. Stainless Steel Ties

C1. Wiring Duct

C2. Surface Raceway

C3. Abrasion Protection

C4. Cable Management

D1. Terminals

D2. Power Connectors

D3. Grounding Connectors

E1. Labeling Systems

E2. Labels

E3. Pre-Printed & Write-On Markers

E4. Permanent Identification

E5. Lockout/ Tagout & Safety Solutions

F. Index

A. System Overview **PANDUCT® Wiring Duct and Raceway – Color and Size Selection**

B1. Cable Ties

B2. Cable Accessories

B3. Stainless Steel Ties

C1. Wiring Duct

C2. Surface Raceway

C3. Abrasion Protection

C4. Cable Management

D1. Terminals

D2. Power Connectors

D3. Grounding Connectors

E1. Labeling Systems

E2. Labels

E3. Pre-Printed & Write-On Markers

E4. Permanent Identification

E5. Lockout/Tagout & Safety Solutions

F. Index

| Duct Size W x H | LG Light Gray | | | | | | | | WH White | | | | | | | | BL Black | | | | IB Intrinsic Blue* | | BR Beige | | IG Int'l. Gray | | | | | | |
|--------------------|------------------|----|---|---|----|---|---|----|-------------|-----|----|---|---|----|---|----|-------------|----|----|-----|-----------------------|---|-------------|---|-------------------|----|---|---|-----|----|--|
| | In. | mm | G | F | FS | D | H | HN | HS | NNC | FL | G | F | FS | D | NE | H | HN | HS | NNC | MC | G | FS | D | H | HS | G | F | TMC | MC | |
| .5 x .5 | 12 x 12 | | | | | | | | | | | | | | | | | | | | | | | | | | | | | | |
| .5 x 1 | | | | | | | | | | | | | | | | | | | | | | | | | | | | | | | |
| .5 x 2 | | | | | | | | | | | | | | | | | | | | | | | | | | | | | | | |
| .5 x 4 | | | | | | | | | | | | | | | | | | | | | | | | | | | | | | | |
| .75 x .75 | | | | | | | | | | | | | | | | | | | | | | | | | | | | | | | |
| .75 x 1 | | | | | | | | | | | | | | | | | | | | | | | | | | | | | | | |
| .75 x 1.5 | | | | | | | | | | | | | | | | | | | | | | | | | | | | | | | |
| .75 x 2 | | | | | | | | | | | | | | | | | | | | | | | | | | | | | | | |
| 1 x 1 | 25 x 25 | | | | | | | | | | | | | | | | | | | | | | | | | | | | | | |
| 1 x 1.5 | 25 x 37 | | | | | | | | | | | | | | | | | | | | | | | | | | | | | | |
| 1 x 2 | 25 x 50 | | | | | | | | | | | | | | | | | | | | | | | | | | | | | | |
| 1 x 2.5 | 25 x 62 | | | | | | | | | | | | | | | | | | | | | | | | | | | | | | |
| 1 x 3 | 25 x 75 | | | | | | | | | | | | | | | | | | | | | | | | | | | | | | |
| 1 x 4 | 25 x 100 | | | | | | | | | | | | | | | | | | | | | | | | | | | | | | |
| 1.5 x 1 | | | | | | | | | | | | | | | | | | | | | | | | | | | | | | | |
| 1.5 x 1.5 | 37 x 37 | | | | | | | | | | | | | | | | | | | | | | | | | | | | | | |
| 1.5 x 2 | 37 x 50 | | | | | | | | | | | | | | | | | | | | | | | | | | | | | | |
| 1.5 x 2.5 | 37 x 62 | | | | | | | | | | | | | | | | | | | | | | | | | | | | | | |
| 1.5 x 3 | 37 x 75 | | | | | | | | | | | | | | | | | | | | | | | | | | | | | | |
| 1.5 x 4 | | | | | | | | | | | | | | | | | | | | | | | | | | | | | | | |
| 2 x 1 | | | | | | | | | | | | | | | | | | | | | | | | | | | | | | | |
| 2 x 1.5 | | | | | | | | | | | | | | | | | | | | | | | | | | | | | | | |
| 2 x 2 | 50 x 50 | | | | | | | | | | | | | | | | | | | | | | | | | | | | | | |
| 2 x 3 | 50 x 75 | | | | | | | | | | | | | | | | | | | | | | | | | | | | | | |
| 2 x 4 | 50 x 100 | | | | | | | | | | | | | | | | | | | | | | | | | | | | | | |
| 2 x 5 | | | | | | | | | | | | | | | | | | | | | | | | | | | | | | | |
| 2.5 x 1.5 | 62 x 37 | | | | | | | | | | | | | | | | | | | | | | | | | | | | | | |
| 2.5 x 2.5 | 62 x 62 | | | | | | | | | | | | | | | | | | | | | | | | | | | | | | |
| 2.5 x 3 | | | | | | | | | | | | | | | | | | | | | | | | | | | | | | | |
| 3 x 1 | | | | | | | | | | | | | | | | | | | | | | | | | | | | | | | |
| 3 x 2 | 75 x 50 | | | | | | | | | | | | | | | | | | | | | | | | | | | | | | |
| 3 x 2.5 | 75 x 62 | | | | | | | | | | | | | | | | | | | | | | | | | | | | | | |
| 3 x 3 | 75 x 75 | | | | | | | | | | | | | | | | | | | | | | | | | | | | | | |
| 3 x 4 | 75 x 100 | | | | | | | | | | | | | | | | | | | | | | | | | | | | | | |
| 3 x 5 | | | | | | | | | | | | | | | | | | | | | | | | | | | | | | | |
| 4 x 1.5 | | | | | | | | | | | | | | | | | | | | | | | | | | | | | | | |
| 4 x 2 | 100 x 50 | | | | | | | | | | | | | | | | | | | | | | | | | | | | | | |
| 4 x 2.5 | 100 x 62 | | | | | | | | | | | | | | | | | | | | | | | | | | | | | | |
| 4 x 3 | 100 x 75 | | | | | | | | | | | | | | | | | | | | | | | | | | | | | | |
| 4 x 4 | 100 x 100 | | | | | | | | | | | | | | | | | | | | | | | | | | | | | | |
| 4 x 5 | | | | | | | | | | | | | | | | | | | | | | | | | | | | | | | |
| 6 x 4 | | | | | | | | | | | | | | | | | | | | | | | | | | | | | | | |

*Intrinsic Blue Color – IB

Intrinsic blue wiring duct is made from the same lead-free PVC material as our standard PVC duct. Intrinsic blue is an internationally recognized standard blue color that identifies the wiring duct as “incapable of releasing sufficient electrical or thermal energy under normal or abnormal conditions to cause ignition of a specific hazardous atmospheric mixture in its most easily ignited concentrations.”

*ISA-RD12.6 (Instrument Society of America)

Installation Tips:

Application of Latex Paint on PANDUCT® Wiring Duct



The following is recommended to properly prepare the surface of the wiring duct/raceway and covers for the best adhesion of latex paint:

1. Clean surface with mild soap and water solution or mineral spirits with a clean lint free towel. Allow to dry.
2. Using a sanding pad (such as synthetic stripping pad or medium/fine steel wool), slightly roughen the surface to be painted.
3. Apply a coat of all-purpose 100% acrylic primer and allow to dry.
4. Apply the desired topcoat of latex paint and allow to dry.
5. Install the wiring duct/raceway and covers.

Cutting Wiring Duct and Cover

For small quantities, use the DCT duct cutting tool on page C1.34. For larger quantities use a miter cutting saw blade for clean burr-free cuts. Recommended blade: *Carbide 80T or 100T; .90" thickness, .125 kerf.*

Recommended Precaution when Using Type NNC and NE Wiring Duct

Cleaning solvents and cutting fluids that contain any of the following chemical agents should not come in contact with type NNC or type NE wiring duct. These chemicals are known to cause stress cracking in the halogen-free PPO material.

- Hydrocarbons
- Phenols
- Ketones
- Amines
- Ethers
- Organic, inorganic and oxidizing acids
- Petrol

Note: PANDUIT assumes no liability for the accuracy or completeness of this list.

Part Number System for Wiring Duct

| | | | | | | |
|---------------------------------|----------------------|----------|-----------------------|----------------------------|---------------|---|
| G | .5 | X | .5 | LG | 6 | -A |
| | | | | | | |
| Type | Nominal Width | | Nominal Height | Color | Length | |
| | In. or mm | | In. or mm | | Ft. or m | |
| G = Wide Slot Flush Design | | | | LG = Light Gray | | -A = Adhesive Backed = Without Adhesive (leave blank) |
| F = Narrow Slot Flush Design | | | | WH = White | | NM = No Mounting Holes |
| FL = Flexible Duct | | | | BL = Black | | |
| FS = Solid Wall Flush Design | | | | IB = Intrinsic Blue | | |
| H = Wide Slot Hinged Design | | | | BR = Beige | | |
| HN = Narrow Slot Hinged Design | | | | IG = International Gray | | |
| HS = Solid Wall Hinged Design | | | | | | |
| D = Round Hole Flush Design | | | | | | |
| NNC = Halogen-Free Design | | | | | | |
| NE = NORYL* Wide Slot Design | | | | | | |
| MC = Metric Narrow Slot Design | | | | | | |
| TMC = Low Smoke Metric Design | | | | | | |
| CWD = Corner Wiring Duct | | | | | | |





*NORYL is a registered trademark of General Electric Company.

PANDUIT Wiring Duct Approvals and Compliances



| Logo (Symbol) | Agency | Spec/Approval | Requirement | Applicable Products |
|---------------|--|---------------------------------------|---|---|
| | Underwriters Laboratories, Inc. | File No. E147128 | UL Standard 1565 "Positioning Devices." CSA Standard C22.2 No.18.5-02 "Positioning Devices." | Wiring duct types: H, HS, and HN |
| | Underwriters Laboratories, Inc. | File No. E147128 | UL Standard 1565 "Positioning Devices." | All types of wiring duct |
| | Canadian Standards Association | File No. 016446, 210335 | CSA Standard C22.2 No.18.5-02 "Positioning Devices." | All types of wiring duct |
| | Conformite European | 2006/95/EEC | ENC50085 cable trunking system and cable ducting systems for electrical installations <ul style="list-style-type: none"> • CDS (cable ducting system) for impact 2 J • Minimum storage and transport temperature -5°C • Minimum installation and application temperature -5°C • Maximum application temperature 60°C • Non-flame propagating • Without electrical continuity • Cover removable without a tool | Wiring duct types: H, HS, G, F, D, MC, FS, NNC, TMC and NE |
| Logo (Symbol) | Agency | Complies with: | Requirement | Applicable Products |
| | DIN (Deutsches Institut für Normung), German Institute for Standardization | DIN 43 659 | This European standard specifies dimensions for slotted trunkings that will be used in electrical switchgear assemblies and that conform to the corresponding requirements in DIN VDE 060 Part 506. The dimensions specified with the standard include: <ul style="list-style-type: none"> • The channel mounting hole pattern, slot dimensions, pitch and location • The distance from the first to last like size mounting hole • Minimum overall product length | Wiring duct types: MC, TMC and NNC |
| | National Fire Protection Agency | NFPA 79-2007, section 13.3.1 | "Nonmetallic ducts shall be permitted (inside enclosures) only when they are made with a flame retardant material." Flame-retardant material is defined in the standard by the IEC 60332-1 test method. | Wiring duct types: H, G, F, D, MC, NNC, TMC and CWD |
| | | NFPA 79-2007, section 13.5.2 | PANDUIT wiring duct publishes a maximum percentage wirefill for common wire types equal to 50% of the interior cross-sectional area of the duct. | Wiring duct types: H, G, F, FS, D, MC, NNC and TMC |
| | | NFPA 79-2007, section 13.1.5.9 | PANDUIT bend radius control accessories can be mounted at right angle and tee junctions created using wiring duct in order to maintain cable bend radius control. | Duct corner strip with 1" bend radius control |
| | | NFPA 130, 2007 edition, section 8.4.1 | Performance criteria for the Flammability and Smoke Emission Characteristics of Materials used in Fixed Guideway Vehicles and Passenger Rail Cars. | Type TMC wiring duct |

PANDUIT Wiring Duct Approvals and Compliances (continued)

| Logo (Symbol) | Agency | Spec/Approval | Requirement | Applicable Products |
|---|---|--------------------|---|--|
| | Underwriters Laboratories, Inc. | UL 508, section 15 | An insulating barrier (divider wall) shall be manufactured from an insulating material exhibiting minimum properties including High Current Arc Resistance to ignition (HAI), Hot Wire Ignition (HWI), Comparative Tracking Index (CTI), electrical Relative Thermal Index (RTI) and flame class. | PVC divider wall |
|  | Elevated temperature | PANDUIT logo | Material is rated for a continuous use temperature above 167°F (75°C). | Wiring duct types: NE, NNC, and NNC |
|  | Halogen-free IEC 60754-2 | PANDUIT logo | Material contains no fluorine, bromide, or chlorine and will not emit any corrosive or toxic gases when burned, confirmed using IEC 60754-2 test method. | Wiring duct types: NE and NNC |
|  | Low flammability UL 94V-0 | PANDUIT logo | Per UL standard, material is self-extinguishing and has excellent fire resistance. | Wiring duct types: NNC, TMC, and all PVC wiring duct |
|  | Low smoke ASTM E 662 | PANDUIT logo | Per ASTM test method and NFPA 130 standard, material exceeds the requirements for low smoke generating material. | Wiring duct type: TMC |
|  | Low toxicity Boeing and Airbus BSS-7239, ATS 1000.1 | PANDUIT logo | Per the Boeing and Airbus test standards, material exceeds the requirements for low levels of toxic gas release. | Wiring duct types: NNC and TMC |

A.
System
Overview

B1.
Cable Ties

B2.
Cable
Accessories

B3.
Stainless
Steel Ties

C1.
Wiring
Duct

C2.
Surface
Raceway

C3.
Abrasion
Protection

C4.
Cable
Management

D1.
Terminals

D2.
Power
Connectors

D3.
Grounding
Connectors

E1.
Labeling
Systems

E2.
Labels

E3.
Pre-Printed
& Write-On
Markers

E4.
Permanent
Identification

E5.
Lockout/
Tagout/
& Safety
Solutions

F.
Index

A.
System
Overview

B1.
Cable Ties

B2.
Cable
Accessories

B3.
Stainless
Steel Ties

C1.
Wiring
Duct

C2.
Surface
Raceway

C3.
Abrasion
Protection

C4.
Cable
Management

D1.
Terminals

D2.
Power
Connectors

D3.
Grounding
Connectors

E1.
Labeling
Systems

E2.
Labels

E3.
Pre-Printed
& Write-On
Markers

E4.
Permanent
Identification

E5.
Lockout/
Tagout/
& Safety
Solutions

F.
Index

NOTES

FIBER-DUCT™ ROUTING SYSTEM

PANDUIT provides leading solutions for cable routing. These routing products are compatible with our cable management solutions increasing your ability to maintain an orderly and clean work environment, implement quick and easy moves, adds, and changes and maintain the integrity of your fiber and copper cabling plant in order to maximize long-term performance.



- Two system sizes available: 2x2 and 4x4
- Minimum 2 inch (50.8mm) bend radius fittings protect against signal loss due to excessive cable bends
- Snap-on non-slip covers
- Compatible with PANDUIT® FIBERRUNNER® 12x4, 6x4, 4x4 and 2x2 Routing Systems

The 2x2 and 4x4 FIBER-DUCT™ Routing Systems are comprised of channel, fittings, and brackets designed to segregate, route, and protect fiber optic and copper cabling to and between racks within the telecommunications room.

A.
System
Overview

B1.
Cable Ties

B2.
Cable
Accessories

B3.
Stainless
Steel Ties

C1.
Wiring
Duct

C2.
Surface
Raceway

C3.
Abrasion
Protection

C4.
Cable
Management

D1.
Terminals

D2.
Power
Connectors

D3.
Grounding
Connectors

E1.
Labeling
Systems

E2.
Labels

E3.
Pre-Printed
& Write-On
Markers

E4.
Permanent
Identification

E5.
Lockout/
Tagout/
& Safety
Solutions

F.
Index

A. System Overview

2x2 and 4x4 FIBER-DUCT™ Routing Systems Roadmap

B1. Cable Ties

B2. Cable Accessories

B3. Stainless Steel Ties

C1. Wiring Duct

C2. Surface Raceway

C3. Abrasion Protection

C4. Cable Management

D1. Terminals

D2. Power Connectors

D3. Grounding Connectors

E1. Labeling Systems

E2. Labels

E3. Pre-Printed & Write-On Markers

E4. Permanent Identification

E5. Lockout/Tagout & Safety Solutions

F. Index

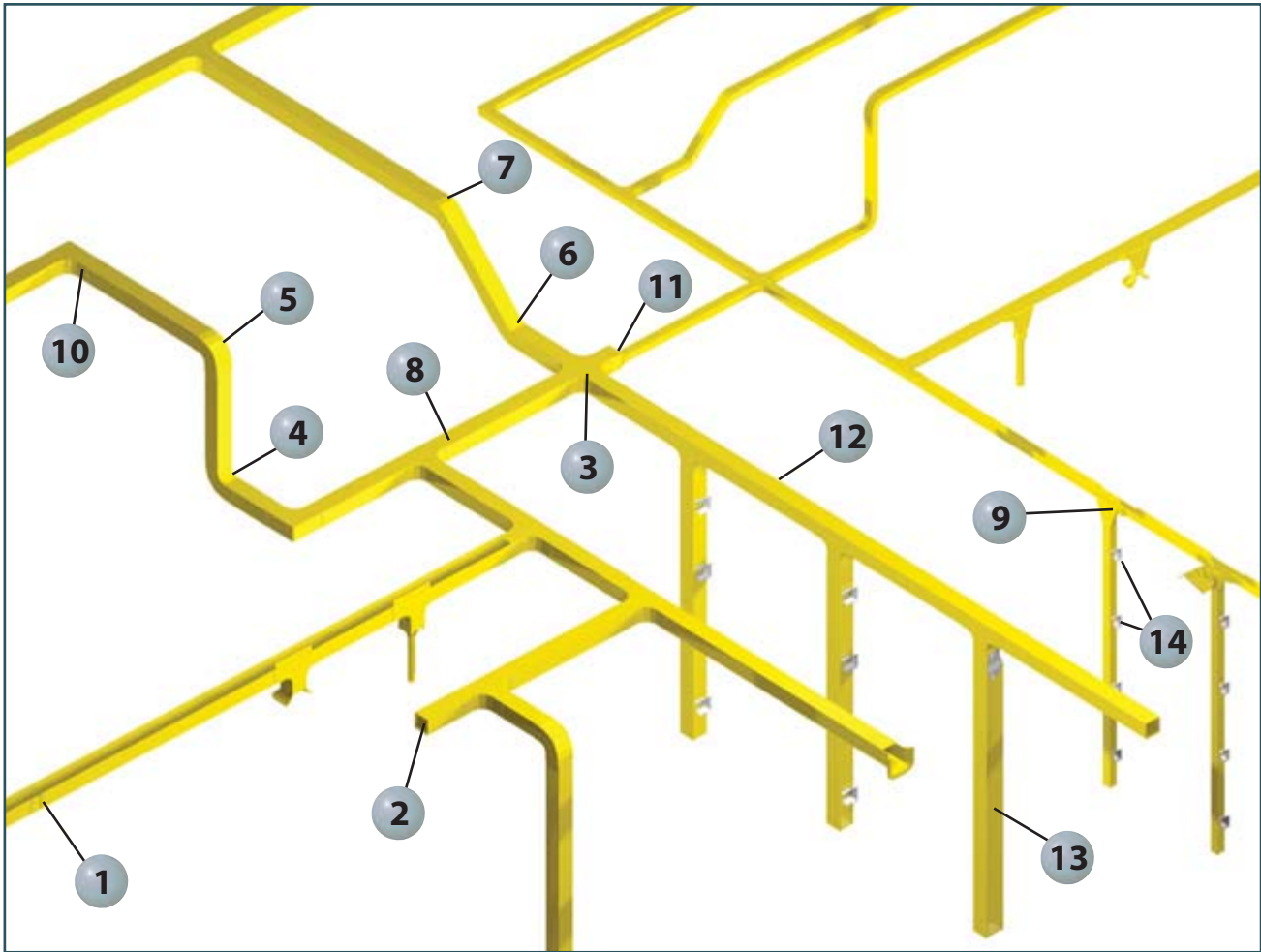

FIBER-DUCT™ Mounting Brackets

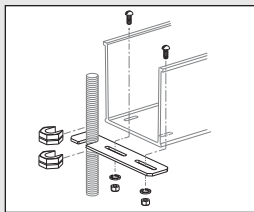

FTRBE12 – Existing Threaded Rod Bracket
(page C1.60)

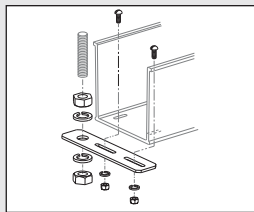

FTRBN12 – New Threaded Rod Bracket
(page C1.60)

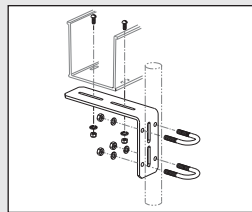

FUSB – Underfloor Pedestal Bracket
(page C1.60)

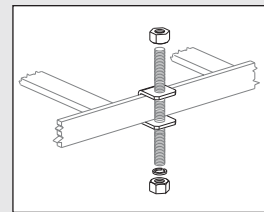

FLB12X15 – Bracket for Attaching Threaded Rod to Ladder Rack
(page C1.60)

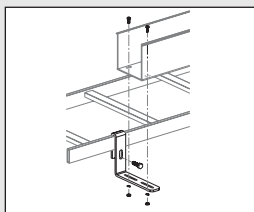

FLRB – Ladder Rack Bracket
(page C1.60)

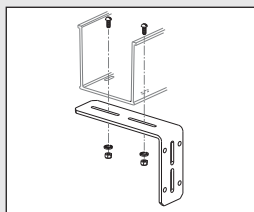

FLB – “L” Wall Mount Bracket
(page C1.60)

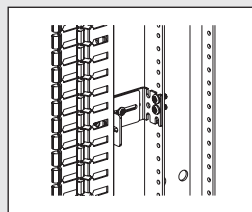

FZBA1.5X4 – Adjustable “Z” Bracket
(page C1.60)

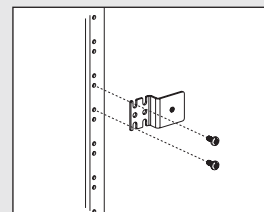

FZBLP – Low Profile “Z” Bracket
(page C1.60)

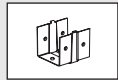

1 FCF2X2** and FCF4X4** – Coupler Fitting (see page C1.56)



2 FEC2X2** and FEC4X4** – End Cap Fitting (see page C1.57)

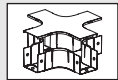

3 FFWC2X2** and FFWC4X4** – 4-Way Cross Fitting (see page C1.57)

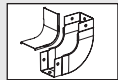

4 FIVRA2X2** and FIVRA4X4** – Inside Vertical Right Angle (see page C1.57)

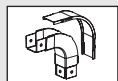

5 FOVRA2X2** and FOVRA4X4** – Outside Vertical Right Angle (see page C1.57)



6 FIV452X2** and FIV454X4** – Inside Vertical 45° Angle (see page C1.57)

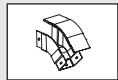

7 FOV452X2** and FOV454X4** – Outside Vertical 45° Angle (see page C1.57)

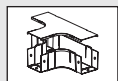

8 FT2X2** and FT4X4** – Horizontal Tee Fitting (see page C1.57)

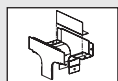

9 FVT4X4** – 4x4 Vertical Tee (see page C1.58)

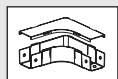

10 FRA2X2** – FRA4X4** – Right Angle Fitting (see page C1.56)

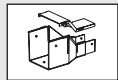

11 FRF42** – 4x4 to 2x2 FIBER-DUCT™ Reducer Fitting (see page C1.57)



12 S2X2**6NM and S4X4**6NM FIBER-DUCT™ Channel (see page C1.56)



13 E2X2**6 and E4X4**6 FIBER-DUCT™ Slotted Channel (see page C1.56)

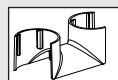

14 TRC2BL and TRC4BL – Bend Radius Control Trumpet (see page C1.59)

**Available colors include: YL (Yellow), OR (Orange), and BL (Black).

A.
System
Overview

B1.
Cable Ties

B2.
Cable
Accessories

B3.
Stainless
Steel Ties

C1.
Wiring
Duct

C2.
Surface
Raceway

C3.
Abrasion
Protection

C4.
Cable
Management

D1.
Terminals

D2.
Power
Connectors

D3.
Grounding
Connectors

E1.
Labeling
Systems

E2.
Labels

E3.
Pre-Printed
& Write-On
Markers

E4.
Permanent
Identification

E5.
Lockout/
Tagout
& Safety
Solutions

F.
Index

A. System Overview



2x2 and 4x4 FIBER-DUCT™ Routing Systems

B1. Cable Ties

- Channel, covers, fittings and other non-metallic system components made from V-0 flame class rated material
- Snap-on non-slip covers
- Compatible with PANDUIT® FIBERRUNNER® 2x2, 4x4, 6x4 and 12x4 Routing Systems

B2. Cable Accessories



S2X2
S4X4

B3. Stainless Steel Ties

C1. Wiring Duct



E2X2
E4X4

C2. Surface Raceway

C3. Abrasion Protection

C4. Cable Management

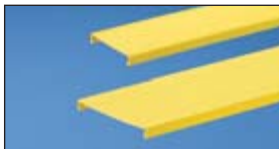

C2
C4

D1. Terminals

D2. Power Connectors

D3. Grounding Connectors

E1. Labeling Systems

E2. Labels

E3. Pre-Printed & Write-On Markers

E4. Permanent Identification

E5. Lockout/Tagout & Safety Solutions

F. Index

| Part Number | Part Description | System Size | Std. Pkg. Qty. | Std. Ctn. Qty. |
|----------------------------|---|-------------|----------------|----------------|
| FIBER-DUCT™ Channel | | | | |
| S2X2YL6NM | Used to carry the cables throughout the FIBER-DUCT™ Routing System. Accepts cover C2YL6. Cover sold separately. | 2x2 | 6 | 120 |
| S4X4YL6NM | Used to carry the cables throughout the FIBER-DUCT™ Routing System. Accepts cover C4YL6. Cover sold separately. | 4x4 | 6 | 60 |

| Part Number | Part Description | System Size | Std. Pkg. Qty. | Std. Ctn. Qty. |
|------------------------------------|--|-------------|----------------|----------------|
| FIBER-DUCT™ Slotted Channel | | | | |
| E2X2YL6 | Used to carry the cables vertically to the front or the back of equipment racks throughout the system. Accepts cover C2YL6. Extra supports required when used in horizontal applications. Cover sold separately. | 2x2 | 6 | 120 |
| E4X4YL6 | Used to carry the cables vertically to the front or the back of equipment racks throughout the system. Accepts cover C4YL6. Extra supports required when used in horizontal applications. Cover sold separately. | 4x4 | 6 | 60 |

| Part Number | Part Description | System Size | Std. Pkg. Qty. | Std. Ctn. Qty. |
|--------------------------|--|-------------|----------------|----------------|
| FIBER-DUCT™ Cover | | | | |
| C2YL6 | Cover for FIBER-DUCT™ Channel and FIBER-DUCT™ Slotted Channel. Non-slip cover design incorporates integral high friction lining to inhibit cover movement. | 2x2 | 6 | 120 |
| C4YL6 | Cover for FIBER-DUCT™ Channel and FIBER-DUCT™ Slotted Channel. Non-slip cover design incorporates integral high friction lining to inhibit cover movement. | 4x4 | 6 | 120 |

Note: Available with mounting holes. To order, delete NM from the part number. For fastest installation use NR2WH-L or NR4BL-L snap rivets. For other colors replace YL (Yellow) with OR (Orange) or BL (Black). Order number of feet required, in multiples of standard 6' length increments.

FIBER-DUCT™ System Fittings



FCF2X2
FCF4X4

FRA2X2
FRA4X4

| Part Number | Part Description | System Size | Std. Pkg. Qty. | Std. Ctn. Qty. |
|---------------------------------------|---|-------------|----------------|----------------|
| Coupler Fitting | | | | |
| FCF2X2YL | Used to join two sections of duct together. FIBER-DUCT™ Coupler is not required at each fitting connection. | 2x2 | 1 | 5 |
| FCF4X4YL | | 4x4 | 1 | 5 |
| Horizontal Right Angle Fitting | | | | |
| FRA2X2YL | Attaches to channel to create a 90° horizontal turn from a straight horizontal run. Cover included. | 2x2 | 1 | 5 |
| FRA4X4YL | | 4x4 | 1 | 5 |

For other colors replace suffix YL (Yellow) with OR (Orange) or BL (Black). Fittings include 5/16" assembly holes for fast mechanical fastening.

FIBER-DUCT™ System Fittings (continued)



FT2X2
FT4X4



FFWC2X2
FFWC4X4



FEC2X2
FEC4X4



FIV452X2
FIV454X4



FOV452X2
FOV454X4



FIVRA2X2
FIVRA4X4



FOVRA2X2
FOVRA4X4



FRF42

| Part Number | Part Description | System Size | Std. Pkg. Qty. | Std. Ctn. Qty. |
|---|--|-------------|----------------|----------------|
| Horizontal Tee Fitting | | | | |
| FT2X2YL | Attaches to channel to create a 90° horizontal branch from a straight horizontal run. Cover included. | 2x2 | 1 | 5 |
| FT4X4YL | | 4x4 | 1 | 5 |
| 4-Way Cross Fitting | | | | |
| FFWC2X2YL | Attaches to channel to create a horizontal four way cross intersection. Cover included. | 2x2 | 1 | 5 |
| FFWC4X4YL | | 4x4 | 1 | 5 |
| End Cap Fitting | | | | |
| FEC2X2YL | Used for closing off open ends of the channel. No coupler required. Push-on installation. | 2x2 | 1 | 5 |
| FEC4X4YL | | 4x4 | 1 | 5 |
| Inside Vertical 45° Angle Fitting | | | | |
| FIV452X2YL | Attaches to channel to create a 45° upward angle from a straight horizontal run. Used with outside vertical 45° angle fitting FOV452X2YL or FOV454X4YL to change level of straight horizontal runs. Cover included. | 2x2 | 1 | 5 |
| FIV454X4YL | | 4x4 | 1 | 5 |
| Outside Vertical 45° Angle Fitting | | | | |
| FOV452X2YL | Attaches to channel to create a 45° downward angle from a straight horizontal run. Used with inside vertical 45° angle fitting FIV452X2YL or FIV454X4YL to change level of straight horizontal runs. Cover included. | 2x2 | 1 | 5 |
| FOV454X4YL | | 4x4 | 1 | 5 |
| Inside Vertical Right Angle Fitting | | | | |
| FIVRA2X2YL | Attaches to channel to create a 90° upward angle from a straight horizontal run. Used with outside vertical 90° angle fitting FOVRA2X2YL or FOVRA4X4YL to change level of straight horizontal runs. Cover included. | 2x2 | 1 | 5 |
| FIVRA4X4YL | | 4x4 | 1 | 5 |
| Outside Vertical Right Angle Fitting | | | | |
| FOVRA2X2YL | Attaches to channel to create a 90° downward angle from a straight horizontal run. Used with inside vertical 90° angle fitting FIVRA2X2YL or FIVRA4X4YL to change level of straight horizontal runs. Cover included. | 2x2 | 1 | 5 |
| FOVRA4X4YL | | 4x4 | 1 | 5 |
| 4x4 to 2x2 FIBER-DUCT™ Reducer Fitting | | | | |
| FRF42YL | Joins any 4x4 FIBER-DUCT™ Fitting to the 2x2 FIBER-DUCT™ Channel, S2X2YL6 or E2X2YL6. Includes cover. | 2x2 4x4 | 1 | 5 |

For other colors replace suffix YL (Yellow) with OR (Orange) or BL (Black).
Fittings include 5/16" assembly holes for fast mechanical fastening.

A.
System
Overview

B1.
Cable Ties

B2.
Cable
Accessories

B3.
Stainless
Steel Ties

C1.
Wiring
Duct

C2.
Surface
Raceway

C3.
Abrasion
Protection

C4.
Cable
Management

D1.
Terminals

D2.
Power
Connectors

D3.
Grounding
Connectors

E1.
Labeling
Systems

E2.
Labels

E3.
Pre-Printed
& Write-On
Markers

E4.
Permanent
Identification

E5.
Lockout/
Tagout
& Safety
Solutions

F.
Index

A. System Overview

FIBER-DUCT™ Spillouts

B1. Cable Ties



FVTHD2X2

B2. Cable Accessories



FTR2X2

B3. Stainless Steel Ties



FIDT2X2

C1. Wiring Duct

C2. Surface Raceway



FVT4X4

C3. Abrasion Protection

C4. Cable Management



FTR4X4

D1. Terminals

D2. Power Connectors



FIDT4X4BL

D3. Grounding Connectors

E1. Labeling Systems

E2. Labels

E3. Pre-Printed & Write-On Markers

E4. Permanent Identification

E5. Lockout/Tagout & Safety Solutions

F. Index

| Part Number | Part Description | System Size | Std. Pkg. Qty. | Std. Ctn. Qty. |
|---|---|-------------|----------------|----------------|
| 2x2 Vertical Tee | | | | |
| FVTHD2X2YL | Attaches to 2x2 channel to create a 90° vertical drop from a horizontal run. Hinged door included. Accepts channel cover in conjunction with channel. Use <i>QUIKLOCK™</i> Coupler FBC2X2YL with HS2X2YL6 or H2X2YL6 channels. Use snap rivets NR2WH-L or bolts F14PN-L with S2X2YL6 or E2X2YL6 channels. Also accepts FIDT2X2YL. | 2x2 | 1 | 5 |
| 3-Sided BRC Trumpet Spillout for 2x2 Exit | | | | |
| FTR2X2YL | Used to limit the bend radius of the cable to 2" (50.8mm) when exiting from a <i>FIBERRUNNER®</i> Spill-Over FRSPYL or from 2x2 <i>FIBER-DUCT™</i> Channel. | 2x2 | 1 | 5 |
| 1-Port Spillout to 1.5" (38mm) Inside Diameter Corrugated Tubing | | | | |
| FIDT2X2YL | Used to route cable into one piece of 1.5" (38mm) diameter split corrugated tubing. Used with <i>FIBERRUNNER®</i> Spill-Over FRSPYL, 2x2 <i>FIBER-DUCT™</i> Fittings, and the 2x2 <i>FIBERRUNNER®</i> Hinged Channel. Securely holds split corrugated tubing to ensure system integrity and easy access to add or remove cables. | 2x2 | 1 | 5 |
| 4x4 Vertical Tee | | | | |
| FVT4X4YL | Attaches to channel to create a 90° vertical drop from a horizontal run. Accepts FIDT4X4BL, FTR4X4YL, S4X4YL6 or E4X4YL6 directly. | 4x4 | 1 | 5 |
| 3-Sided Vertical Tee Trumpet Spillout | | | | |
| FTR4X4YL | Used to limit the bend radius of the cable to 2" (50.8mm) when exiting from a 4x4 or 6x4 <i>FIBERRUNNER®</i> Vertical Tee and 4x4 <i>FIBER-DUCT™</i> Fittings. | 4x4 | 1 | 5 |
| 2-Port Spillout to 1.5" (38mm) Inside Diameter Corrugated Tubing | | | | |
| FIDT4X4BL | Used to route cable into one or two pieces of 1.5" (38mm) diameter split corrugated tubing. Used with FRVT6X4YL, FRVT4X4YL, or FVT4X4YL. Securely holds corrugated split tubing to ensure system integrity and easy access to add or remove cables. Black color only. | 4x4 | 1 | 5 |

For other colors replace suffix YL (Yellow) with OR (Orange) or BL (Black).

FIBER-DUCT™ Bend Radius Control Trumpets

- Provide method to transition cabling into rack system
- Maintain 1 inch (25.4mm) bend radius control



TRC2BL



TRC4BL

| Part Number | Part Description | System Size | Std. Pkg. Qty. | Std. Ctn. Qty. |
|-------------|--|-------------|----------------|----------------|
| TRC2BL | Bend radius control trumpet for exiting at the sidewall of 2" wall heights of type E FIBER-DUCT™ Channels. | 2x2 | 1 | 10 |
| TRC4BL | Bend radius control trumpet for exiting at the sidewall of 4" wall heights of type E FIBER-DUCT™ Channels. | 4x4 | 1 | 10 |

FIBER-DUCT™ Accessories

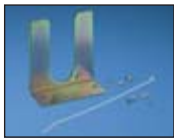

FITF4X4B



NR2WH-L
NR4BL-L



F14PWN-L



F14PN-L

| Part Number | Part Description | System Size | Std. Pkg. Qty. | Std. Ctn. Qty. |
|---|--|-------------|----------------|----------------|
| Inner Duct Transition Fitting – 4x4 Size | | | | |
| FITF4X4B | Provides transition from 4x4 FIBER-DUCT™ Routing System to two pieces of 1 1/4" (31.8mm) inner duct. | 4x4 | 1 | 10 |
| Snap Rivets | | | | |
| NR2WH-L | Snap rivet fastens channel and fittings together for added strength and rigidity. Snap rivet mounts flush to surfaces. | 2x2 | 50 | 500 |
| NR4BL-L | | 4x4 | 50 | 500 |
| Plastic Bolts and Nuts | | | | |
| F14PWN-L | 1/4" plastic bolts and wing nuts fastens channel and fittings together for added strength and rigidity. | 2x2 4x4 | 50 | 500 |
| Plastic Bolts and Nuts | | | | |
| F14PN-L | 1/4" plastic bolts and hex nuts fastens channel and fittings together for added strength and rigidity. | 2x2 4x4 | 50 | 500 |

A.
System
Overview

B1.
Cable Ties

B2.
Cable
Accessories

B3.
Stainless
Steel Ties

C1.
Wiring
Duct

C2.
Surface
Raceway

C3.
Abrasion
Protection

C4.
Cable
Management

D1.
Terminals

D2.
Power
Connectors

D3.
Grounding
Connectors

E1.
Labeling
Systems

E2.
Labels

E3.
Pre-Printed
& Write-On
Markers

E4.
Permanent
Identification

E5.
Lockout/
Tagout
& Safety
Solutions

F.
Index

A. System Overview

FIBER-DUCT™ Mounting Brackets

B1. Cable Ties

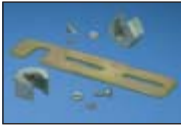

**FTRBE12, FTRBE58
FTRBE12M**

B2. Cable Accessories

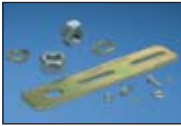

**FTRBN12, FTRBN58
FTRBN12M**

B3. Stainless Steel Ties

C1. Wiring Duct



FUSB

C2. Surface Raceway

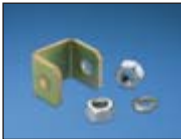

**FLB12X15
FLB58X15
FLB12X20
FLB58X20**

C3. Abrasion Protection

C4. Cable Management

D1. Terminals

D2. Power Connectors



FLRB

D3. Grounding Connectors

E1. Labeling Systems

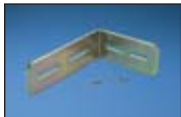

FLB

E2. Labels



FZBA1.5X4

E3. Pre-Printed & Write-On Markers

E4. Permanent Identification



FZBLP

E5. Lockout/Tagout & Safety Solutions

F. Index

| Part Number | Part Description | For Threaded Rod Size | Std. Pkg. Qty. | Std. Ctn. Qty. |
|---|--|-----------------------|----------------|----------------|
| Existing Threaded Rod Bracket for FIBER-DUCT™ System | | | | |
| FTRBE12 | Used for supporting the 2x2 and 4x4 FIBER-DUCT™ Systems from existing threaded rod installations. | 1/2" | 1 | 10 |
| FTRBE58 | Bracket is secured to threaded rod with two split nuts. Contains hardware for attaching to threaded rods and hardware for mounting channel to bracket. | 5/8" | 1 | 10 |
| FTRBE12M | | 12mm | 1 | 10 |
| New Threaded Rod Bracket for FIBER-DUCT™ System | | | | |
| FTRBN12 | Used for supporting the 2x2 and 4x4 FIBER-DUCT™ Systems from new threaded rod installations. | 1/2" | 1 | 10 |
| FTRBN58 | Bracket is secured to threaded rod with two nuts. Contains hardware for attaching to threaded rods and hardware for mounting channel to bracket. | 5/8" | 1 | 10 |
| FTRBN12M | | 12mm | 1 | 10 |
| Underfloor Pedestal Bracket for FIBER-DUCT™ System | | | | |
| FUSB | Used to support the 2x2 and 4x4 FIBER-DUCT™ Systems by attaching to underfloor pedestal (not included). Use on pedestals up to 1" in diameter. Bracket contains hardware to attach to pedestal and hardware for mounting channel to bracket. | — | 1 | 10 |
| Bracket for Attaching Threaded Rod to 1 1/2" Ladder Rack | | | | |
| FLB12X15 | Bracket attaches to 3/8" (9.5mm) wide x 1 1/2" (38.1mm) ladder rack rail. Bracket accepts threaded rod (not included). Contains bracket and hardware for attaching bracket to ladder rack. | 1/2" | 1 | 10 |
| FLB58X15 | | 5/8" | 1 | 10 |
| Bracket for Attaching Threaded Rod to 2" Ladder Rack | | | | |
| FLB12X20 | Bracket attaches to 3/8" (9.5mm) wide x 2" (50.8mm) ladder rack rail. Bracket accepts threaded rod (not included). Contains bracket and hardware for attaching bracket to ladder rack. | 1/2" | 1 | 10 |
| FLB58X20 | | 5/8" | 1 | 10 |
| Ladder Rack Bracket for FIBER-DUCT™ System | | | | |
| FLRB | Used to support the 2x2 and 4x4 FIBER-DUCT™ Systems attaching directly to any 3/8" (9.5mm) x 1 1/2" (38.1mm) or 3/8" (9.5mm) x 2" (50.8mm) ladder rack rail. No threaded rod required. Contains hardware for mounting channel to bracket. | — | 1 | 10 |
| "L" Wall Mount Bracket for FIBER-DUCT™ System | | | | |
| FLB | Used to support 2x2 and 4x4 FIBER-DUCT™ Systems by attaching to a wall or the front or back of an equipment rack. Contains hardware for mounting channel to bracket. | — | 1 | 10 |
| Adjustable "Z" Bracket | | | | |
| FZBA1.5X4 | Bracket used to offset FIBER-DUCT™ System from mounting surface, adjustable from 1.5" (38mm) to 4" (101mm). Typically used on the front of an equipment rack. | — | 1 | 10 |
| Low Profile "Z" Bracket | | | | |
| FZBLP | Bracket used to offset 2x2 or 4x4 FIBER-DUCT™ System and hinged duct from the front face of an equipment rack. Bracket provides a secure mounting surface .67" (17mm) from the front of an equipment rack. | — | 1 | 10 |

FIBER-DUCT™ Mounting Brackets (continued)



FEIAB58



F2PCLB12
F2PCLB58



FRAFC58

| Part Number | Part Description | For Threaded Rod Size | Std. Pkg. Qty. | Std. Ctn. Qty. |
|--|--|-----------------------|----------------|----------------|
| EIA/TIA Threaded Rod Mounting Bracket | | | | |
| FEIAB58 | Bracket consists of two identical components that clamp onto the crossmembers of standard EIA/TIA racks and are secured with standard hex nuts and split lockwashers (included) tightened onto a length of 5/8" diameter threaded rod (not included). The threaded rod is positioned in the center of the brackets providing a vertical threaded rod stud to mount <i>FIBERRUNNER</i> ® and <i>FIBER-DUCT</i> ™ Threaded Rod Mounting Brackets onto. | 5/8" | 1 | 10 |
| Two-Piece Ladder Rack Bracket for Attaching Threaded Rod to 1 1/2" – 2" Ladder Rack | | | | |
| F2PCLB12 | Two-piece bracket attaches to 3/8" (9.5mm) wide x 1 1/2" (38.1mm) or 3/8" (9.5mm) wide x 2" (50.8mm) ladder rack rail. Bracket halves slide into position and clamp together on the ladder rack rail, which allows for a one-handed assembly of the threaded rod (not included). Contains bracket and hardware for attaching bracket to ladder rack. | 1/2" | 1 | 10 |
| F2PCLB58 | | 5/8" | 1 | 10 |
| Two-Piece Framing Clip for Attaching 5/8" Threaded Rod to 2" x 9/16" C-Channel Auxiliary Framing Bars | | | | |
| FRAFC58 | Two-piece framing clip attaches to auxiliary framing bars. Framing clip halves slide into position and interlock on the auxiliary framing bars, allowing easier assembly of the threaded rod to bars. Contains two-piece framing clip and hardware for attaching framing clip to auxiliary framing bars. (5/8" threaded rod not included.) | 5/8" | 1 | 10 |

A.
System
Overview

B1.
Cable Ties

B2.
Cable
Accessories

B3.
Stainless
Steel Ties

C1.
Wiring
Duct

C2.
Surface
Raceway

C3.
Abrasion
Protection

C4.
Cable
Management

D1.
Terminals

D2.
Power
Connectors

D3.
Grounding
Connectors

E1.
Labeling
Systems

E2.
Labels

E3.
Pre-Printed
& Write-On
Markers

E4.
Permanent
Identification

E5.
Lockout/
Tagout
& Safety
Solutions

F.
Index

A. System Overview



2x2 and 4x4 FIBER-DUCT™ Routing Systems

B1. Cable Ties

Cable Fills for 2x2 and 4x4 FIBER-DUCT™ Cable Routing Systems

The maximum amounts may vary according to the cable fill installation methods, straightness of cables, etc.

B2. Cable Accessories

B3. Stainless Steel Ties

C1. Wiring Duct

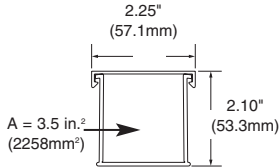

C2. Surface Raceway

C3. Abrasion Protection

C4. Cable Management

| 2x2 FIBER-DUCT™ Cable Routing System | | | | | | | |
|--------------------------------------|--------------------|----------------------|----------------------|----------------------|---|---|----------------------------------|
| Fill/Pile Up | Internal Area in.² | Diameter 1.6mm .063" | Diameter 2.0mm .079" | Diameter 3.0mm .118" | Fiber Optic Flat Ribbon Interconnect Cable 5.20mm .205" | Category 6A 23 AWG* Diameter 8.38mm .330" | Category 6 Diameter 6.35mm .250" |
| 40% Fill | | | | | | | |
| 2" Pile Up | 3.5 | 449 | 288 | 128 | 42 | 16 | 29 |
| 50% Fill | | | | | | | |
| 2" Pile Up | 3.5 | 562 | 359 | 160 | 53 | 20 | 36 |
| 60% Fill | | | | | | | |
| 2" Pile Up | 3.5 | 674 | 431 | 192 | 64 | 25 | 43 |

Channel cutting instructions: For optimum results, use a miter box and saw. For larger quantities use a plastic cutting saw blade for clean, burr-free cuts. Recommend: Carbide 80T and 100T; .090" thickness, .125" kerf.

*AWG dimensions represent typical outer cable diameter.

D1. Terminals

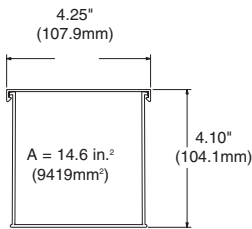

D2. Power Connectors

D3. Grounding Connectors

E1. Labeling Systems

E2. Labels

E3. Pre-Printed & Write-On Markers

E4. Permanent Identification

E5. Lockout/Tagout & Safety Solutions

F. Index

| 4x4 FIBER-DUCT™ Cable Routing System | | | | | | | |
|--------------------------------------|--------------------|----------------------|----------------------|----------------------|---|---|----------------------------------|
| Fill/Pile Up | Internal Area in.² | Diameter 1.6mm .063" | Diameter 2.0mm .079" | Diameter 3.0mm .118" | Fiber Optic Flat Ribbon Interconnect Cable 5.20mm .205" | Category 6A 23 AWG* Diameter 8.38mm .330" | Category 6 Diameter 6.35mm .250" |
| 40% Fill | | | | | | | |
| 2" Pile Up | 7.60 | 976 | 624 | 277 | 92 | 36 | 62 |
| 3" Pile Up | 11.30 | 1450 | 928 | 413 | 137 | 53 | 92 |
| 4" Pile Up | 14.60 | 1874 | 1199 | 533 | 177 | 68 | 119 |
| 50% Fill | | | | | | | |
| 2" Pile Up | 7.60 | 1219 | 780 | 347 | 115 | 44 | 77 |
| 3" Pile Up | 11.30 | 1813 | 1160 | 516 | 171 | 66 | 115 |
| 4" Pile Up | 14.60 | 2343 | 1499 | 666 | 221 | 85 | 149 |
| 60% Fill | | | | | | | |
| 2" Pile Up | 7.60 | 1463 | 936 | 416 | 138 | 53 | 93 |
| 3" Pile Up | 11.30 | 2176 | 1392 | 619 | 205 | 79 | 138 |
| 4" Pile Up | 14.60 | 2811 | 1799 | 800 | 265 | 102 | 178 |

Channel cutting instructions: For optimum results, use a miter box and saw. For larger quantities use a plastic cutting saw blade for clean, burr-free cuts. Recommend: Carbide 80T and 100T; .090" thickness, .125" kerf.

*AWG dimensions represent typical outer cable diameter.

PAN-WAY® METAL RACEWAY

PAN-WAY® Metal Raceway is a series of single and multi-channel solutions for routing, protecting, concealing and terminating power wire and high performance copper, voice, video or fiber optic cable. PANDUIT metal raceway is designed with labor saving features to increase productivity and lower installed costs, while incorporating benefits of increased safety and cable protection. PAN-WAY® Metal Raceway is an innovative routing solution that offers superior benefits over competitive systems:

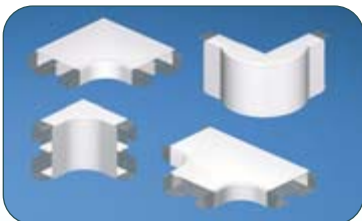

PAN-WAY® Metal Raceway systems include a complete assortment of fittings, junction boxes, faceplates and accessories. They are available in white and almond color to match any decor and most popular electrical outlets. Systems are optimized for use with PANDUIT® MINI-COM® Modules for complete connectivity possibilities.

PMR5 and PMR7 Single Channel Metal Raceway

- Raceway system features a patent pending bonding design that provides full continuity of the ground path between fittings and channel, for increased electrical safety
- System components incorporate an innovative snap-mount assembly method for fast installations, resulting in measurable contractor labor savings
- Fittings and mounts can be attached using various types and sizes of fasteners, eliminating the requirements of using only flat head style screws
- One-piece channel construction eliminates the problem of channel separation, associated with competitive two-piece designs, saving installation time

PMR40 Multi-Channel Metal Raceway

- Raceway accepts standard double gang faceplates for increased termination options and reduced number of components
- System includes optional faceplates and fittings to support high performance Category 6A copper and fiber optic cabling terminations
- Full capacity 2 inch bend radius fittings provide necessary cable protection without restricting channel capacity

A.
System
Overview

B1.
Cable Ties

B2.
Cable
Accessories

B3.
Stainless
Steel Ties

C1.
Wiring
Duct

C2.
Surface
Raceway

C3.
Abrasion
Protection

C4.
Cable
Management

D1.
Terminals

D2.
Power
Connectors

D3.
Grounding
Connectors

E1.
Labeling
Systems

E2.
Labels

E3.
Pre-Printed
& Write-On
Markers

E4.
Permanent
Identification

E5.
Lockout/
Tagout
& Safety
Solutions

F.
Index

A.
System
Overview

PMR40 Raceway Roadmap

B1.
Cable Ties

B2.
Cable
Accessories

B3.
Stainless
Steel Ties

C1.
Wiring
Duct

C2.
Surface
Raceway

C3.
Abrasion
Protection

C4.
Cable
Management

D1.
Terminals

D2.
Power
Connectors

D3.
Grounding
Connectors

E1.
Labeling
Systems

E2.
Labels

E3.
Pre-Printed
& Write-On
Markers

E4.
Permanent
Identification

E5.
Lockout/
Tagout/
& Safety
Solutions

F.
Index

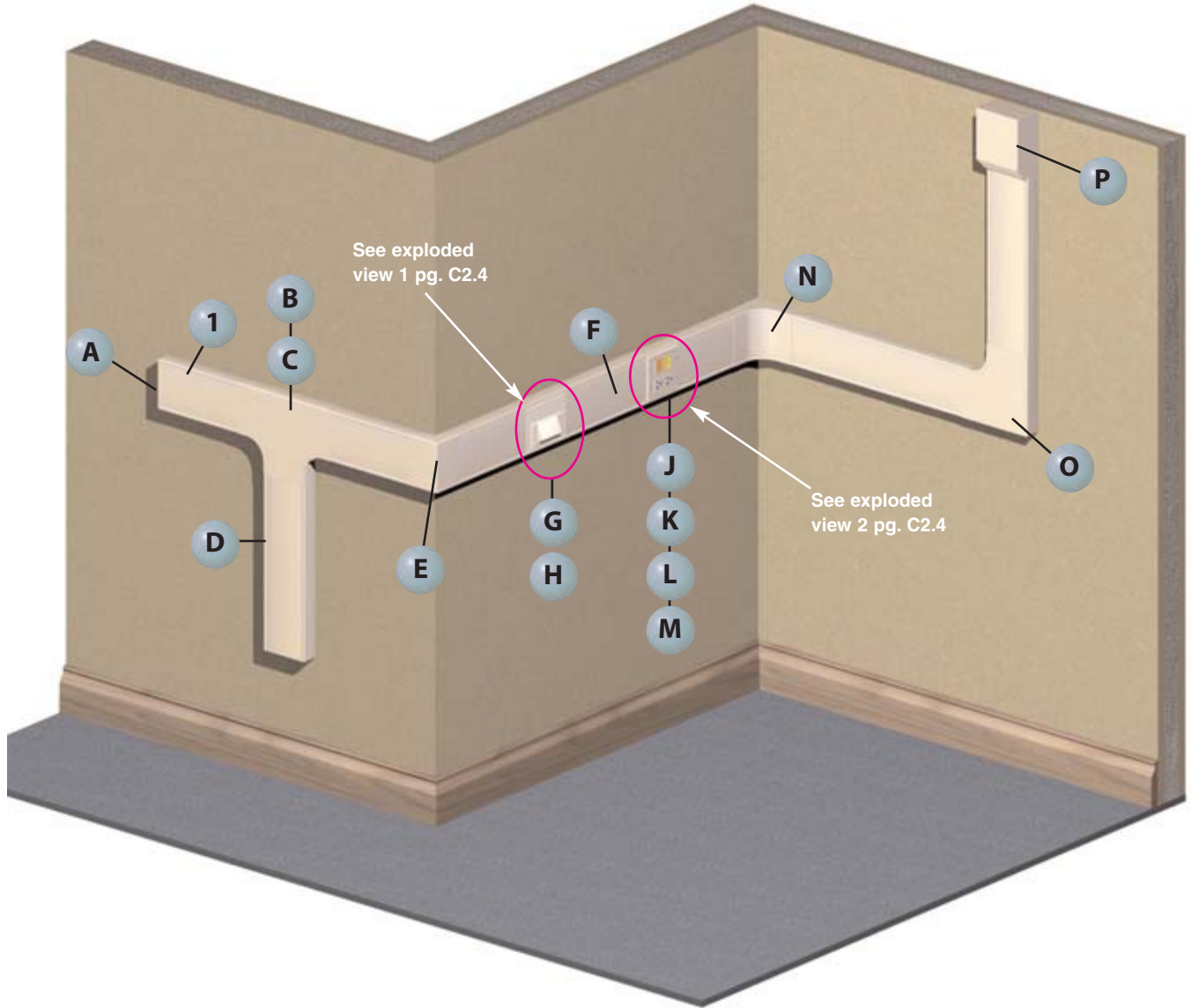

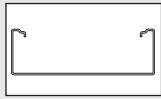

1 PMR40** – PMR40 Metal Raceway (page C2.5)

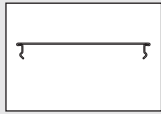

1 PMR40C** – PMR40 Cover (page C2.5)

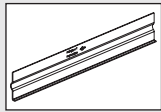

1 PMR40DW* – PMR40 Divider Wall (page C2.5)

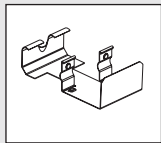

1 PMR40CD-X – PMR40 Divider Clip (page C2.5)

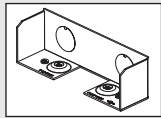

A PMR40EC** – End Cap (page C2.6)

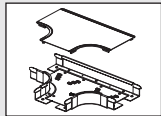

B PMR40T** – Tee Fitting (page C2.6)

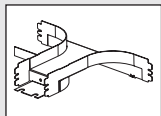

C PMR40TD50 – Tee Divider Insert (page C2.6)

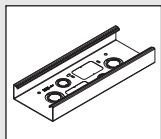

D PMR40BF** – Backfeed Fitting (page C2.6)

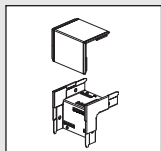

E PMR40SOC** – Outside Corner (no bend radius) (page C2.6)

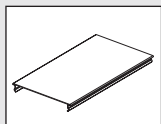

F PMR40C**7.5 – Pre-Cut Cover for mounting devices on 12" centers (page C2.5)

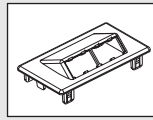

G PMR40FH4** – Horizontal Sloped Communication Faceplate (page C2.6)

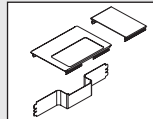

H PMR40DP50** – PMR40 50/50 Data Plate (page C2.6)

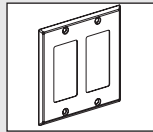

J MP2GR** – Double Gang Rectangular Faceplate (page C2.17)

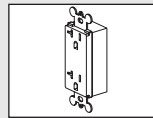

K ERU20** – 20 V Specification Grade Rectangular Outlet (page C2.60)

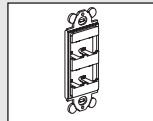

L CFG4 – MINI-COM® Frame

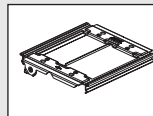

M PMR40DB50 – Device Bracket (page C2.6)

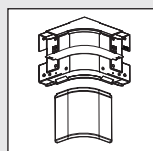

N PMR40IC** – Inside Corner (page C2.6)

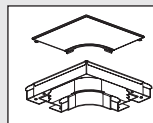

O PMR40RA** – Right Angle (page C2.5)

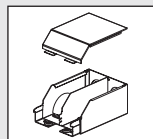

P PMR40EE** – Entrance End (page C2.6)

A. System Overview

B1. Cable Ties

B2. Cable Accessories

B3. Stainless Steel Ties

C1. Wiring Duct

C2. Surface Raceway

C3. Abrasion Protection

C4. Cable Management

D1. Terminals

D2. Power Connectors

D3. Grounding Connectors

E1. Labeling Systems

E2. Labels

E3. Pre-Printed & Write-On Markers

E4. Permanent Identification

E5. Lockout/Tagout & Safety Solutions

F. Index

A.
System
Overview

PMR40 Configurations

B1.
Cable Ties

Exploded View 1

| | Components Required | See page |
|----|---|----------|
| A. | PMR40FH4 = Horizontal sloped communication faceplate. | C2.6 |
| B. | PMR40DP50** = PMR40 50/50 data plate and offset divider wall. | C2.6 |
| C. | MINI-COM® Modules. | — |

B2.
Cable
Accessories

B3.
Stainless
Steel Ties

C1.
Wiring
Duct

C2.
Surface
Raceway

C3.
Abrasion
Protection

C4.
Cable
Management

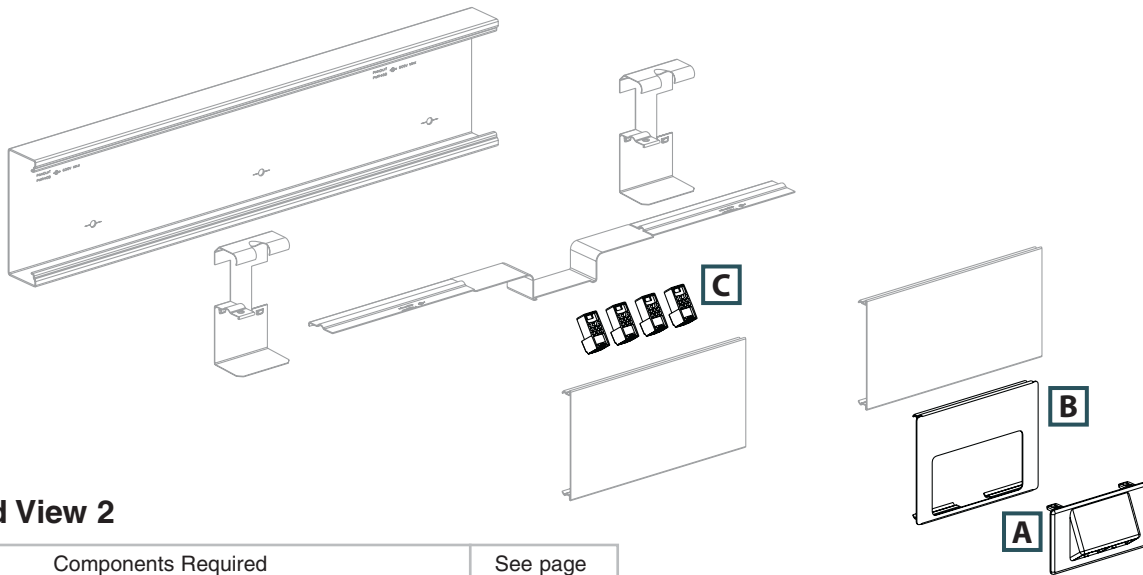

D1.
Terminals

Exploded View 2

| | Components Required | See page |
|----|--|----------|
| A. | MP2GR** = Double gang rectangular faceplate. | C2.17 |
| B. | ERU20** = 20 V specification grade rectangular outlet. | C2.60 |
| C. | CFG4 = MINI-COM® Frame. | — |
| D. | MINI-COM® Modules. | — |
| E. | PMR40DB50-X = Device bracket. | C2.6 |

D2.
Power
Connectors

D3.
Grounding
Connectors

E1.
Labeling
Systems

E2.
Labels

E3.
Pre-Printed
& Write-On
Markers

E4.
Permanent
Identification

E5.
Lockout/
Tagout/
& Safety
Solutions

F.
Index

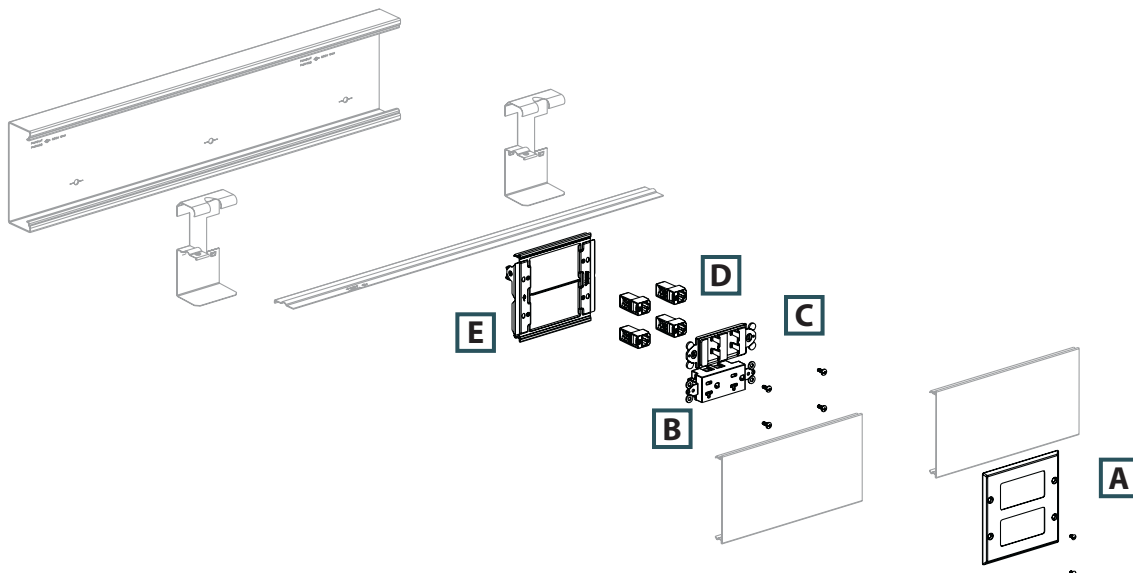

cUL^{us} PAN-WAY® PMR40 Metal Raceway System

- c-UL-us listed and rated to 600 V; meets UL 5 and CSA22.2 No. 62-93 safety standards
- Raceway accepts standard double gang faceplates for increased termination options and reduced number of components
- System includes optional faceplates and fittings to support high performance Category 6A copper and fiber optic cabling terminations

- Full capacity 2 inch bend radius fittings provide necessary cable protection without restricting channel capacity
- Supplied with pre-punched mounting holes

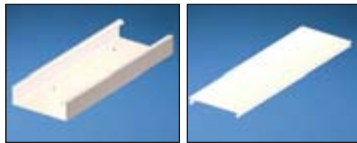
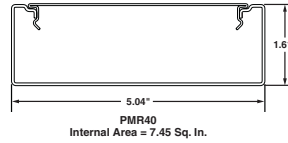

PMR40B

PMR40C



PMR40C***

PMR40C***

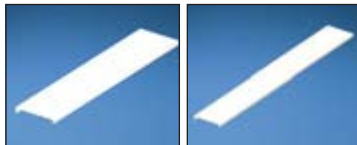

PMR40C***

PMR40C***



PMR40DW5

PMR40DC

| Part Number | Part Description | Raceway Size | Color‡ | Length (Ft.) | Std. Pkg. Qty. |
|---|--|----------------------------------|--------|--------------|----------------|
| PMR40 Metal Raceway Base | | | | | |
| PMR40BWH10 | PMR40 raceway base available in 10' lengths. Supplied with pre-punched mounting holes. | 5.04" x 1.61" (128.0mm x 40.9mm) | White | 10 | 10 |
| PMR40 Metal Raceway Cover | | | | | |
| PMR40CWH5 | PMR40 raceway cover available in 5' lengths. | — | White | 5 | 5 |
| PMR40 Metal Raceway Pre-Cut Covers | | | | | |
| PMR40CWH7.75 | 7.75" pre-cut cover. To be used with PMR40 raceway for mounting devices on 12" centers. | — | White | — | 1 |
| PMR40CWH13.75 | 13.75" pre-cut cover. To be used with PMR40 raceway for mounting devices on 18" centers. | — | White | — | 1 |
| PMR40CWH19.75 | 19.75" pre-cut cover. To be used with PMR40 raceway for mounting devices on 24" centers. | — | White | — | 1 |
| PMR40CWH31.75 | 31.75" pre-cut cover. To be used with PMR40 raceway for mounting devices on 36" centers. | — | White | — | 1 |
| PMR40 Metal Raceway Divider Wall | | | | | |
| PMR40DW5 | PMR40 divider wall snaps into PMR40DC-X to create separate channels. Must use wire retainers to ensure channel separation per UL/CSA. Available in 5' lengths. | — | Gray | 5 | 5 |
| Divider Wall Clip | | | | | |
| PMR40DC-X | Divider wall clip. Required for supporting PMR40DW. 30" spacing recommended between clips. | — | Gray | — | 10 |

‡For other colors replace WH (White) with AL (Almond). Order number of feet required in multiples of standard carton quantity. Order raceway base and cover separately.

cUL^{us} PAN-WAY® PMR40 Metal Raceway Fittings

- PMR40 fittings are designed to exceed the TIA/EIA-568-B and 569-B required minimum bend radius for high performance copper and fiber optic cabling systems

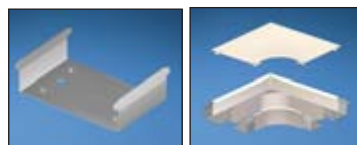

PMR40BC

PMR40RA



PMR40SIC

| Part Number | Part Description | Color‡ | Std. Pkg. Qty. | Std. Ctn. Qty. |
|-------------|--|--------|----------------|----------------|
| PMR40BC | Base coupler. Used to join sections of PMR40 raceway base. | Gray | 10 | 100 |
| PMR40RAWH | Right angle fitting. Used to join sections of PMR40 raceway at right angles. | White | 1 | 10 |
| PMR40SIC | Inside corner fitting without bend radius control. Used to join sections of PMR40 raceway at inside corners. | White | 1 | 10 |

‡For other colors replace WH (White) with AL (Almond).

Table continues on page C2.6

A. System Overview

B1. Cable Ties

B2. Cable Accessories

B3. Stainless Steel Ties

C1. Wiring Duct

C2. Surface Raceway

C3. Abrasion Protection

C4. Cable Management

D1. Terminals

D2. Power Connectors

D3. Grounding Connectors

E1. Labeling Systems

E2. Labels

E3. Pre-Printed & Write-On Markers

E4. Permanent Identification

E5. Lockout/Tagout & Safety Solutions

F. Index



PAN-WAY® PMR40 Metal Raceway Fittings (continued)

A. System Overview

B1. Cable Ties

B2. Cable Accessories

B3. Stainless Steel Ties

C1. Wiring Duct

C2. Surface Raceway

C3. Abrasion Protection

C4. Cable Management

D1. Terminals

D2. Power Connectors

D3. Grounding Connectors

E1. Labeling Systems

E2. Labels

E3. Pre-Printed & Write-On Markers

E4. Permanent Identification

E5. Lockout/Tagout & Safety Solutions

F. Index



PMR40IC

PMR40I45E



PMR40SOC

PMR40OC

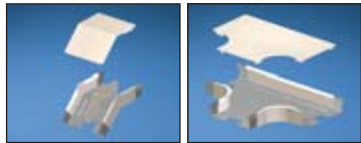

PMR40E45E

PMR40T



PMR40TD50

PMR40EC



PMR40EE

PMR40TR



PMR40BF

PMR40PC



PMR40ICC

PMR40WR

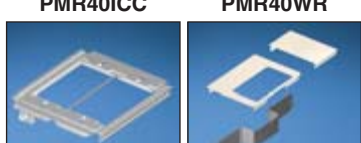

PMR40DB50

PMR40DP50



PMR40FH2

PMR40FH4



PMR40KH2

PMR40KH4

| Part Number | Part Description | Color† | Std. Pkg. Qty. | Std. Ctn. Qty. |
|--------------------|--|--------|----------------|----------------|
| PMR40ICWH | Inside corner fitting. Used to join sections of PMR40 raceway at inside corners. | White | 1 | 10 |
| PMR40I45EWH | Internal 45° elbow fitting. Used to join sections of PMR40 raceway at 45° inside corners. | White | 1 | 10 |
| PMR40SOCWH | Outside corner fitting without bend radius control. Used to join sections of PMR40 raceway at outside corners. | White | 1 | 10 |
| PMR40OCWH | Outside corner fitting. Used to join sections of PMR40 raceway at outside corners. | White | 1 | 10 |
| PMR40E45EWH | External 45° elbow fitting. Used to join sections of PMR40 raceway at 45° outside corners. | White | 1 | 10 |
| PMR40TWH | Tee fitting. Used to join sections of PMR40 raceway at tee intersections. | White | 1 | 10 |
| PMR40TD50 | Tee divider insert for a 50/50 data/power split. Maintains a 50/50 channel separation for power and data applications. | Gray | 1 | 10 |
| PMR40ECWH | End cap fitting. Used to terminate or allow entry into PMR40 raceway. Breakouts for 1/2" conduit. | White | 1 | 10 |
| PMR40EEWH | Entrance end fitting. Breakouts for 3/4", 1", and 1 1/4" conduit which allows entry from ceiling or wall. | White | 1 | 10 |
| PMR40TRWH | WIREMOLD* to PMR40 transition fitting. In-line transition fitting from Wiremold* 4000 series to PMR40 raceway. | White | 1 | 10 |
| PMR40BFWH | Backfeed fitting. Allows cable entry through the back of the PMR40 raceway. Two round breakouts for 1/2", 3/4", and 1" conduit, two round breakouts for 3/4", 1", and 1 1/4" conduit and two 1 11/16" x 2 9/16" rectangular breakouts. | White | 1 | 10 |
| PMR40PCWH | Panel connector. To connect PMR40 raceway with surface type panel boxes. | White | 1 | 10 |
| PMR40ICC | Internal corner coupling. | White | 1 | 10 |
| PMR40WR-X | Wire retainer. Used to hold wires in place during installation. | Gray | 10 | 100 |
| PMR40DB50 | Device mounting bracket 50/50 split. Used to mount NEMA standard single gang electrical outlets and communication devices with either screw-on or snap-on single gang faceplates. | Gray | 1 | 10 |
| PMR40DP50WH | PMR40 data plate for mounting data faceplates PMR40FH2, PMR40FH4, PMR40KH2 or PMR40KH4 when a 50/50 split channel is used in the PMR40 base. Includes data plate, 2.50" pre-cut cover, and offset divider wall. | White | 1 | 10 |
| PMR40FH2WH | Snap-on horizontal sloped communication faceplate. Accepts two PANDUIT® MINI-COM® Modules (not included). No additional mounting hardware required. | White | 1 | 10 |
| PMR40FH4WH | Snap-on horizontal sloped communication faceplate. Accepts four PANDUIT® MINI-COM® Modules (not included). No additional mounting hardware required. | White | 1 | 10 |
| PMR40KH2WH | Snap-on horizontal sloped communication faceplate. Accepts two Keystone modules (not included). No additional mounting hardware required. | White | 1 | 10 |
| PMR40KH4WH | Snap-on horizontal sloped communication faceplate. Accepts four Keystone modules (not included). No additional mounting hardware required. | White | 1 | 10 |

†For other colors replace WH (White) with AL (Almond).

*WIREMOLD is a registered trademark of the Wiremold Co.

Cable Fill Capacities for PMR40 Metal Raceway

This information is to be used as a guide in selecting the proper size raceway. The maximum amounts may vary according to the cable installation methods, straightness of cables, etc.



A = 7.45 in.²

Cable fill #1: Open channel without devices



A = 6.18 in.²

Cable fill #2: Undivided, wire retainer only

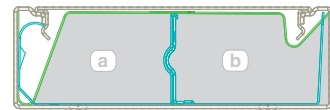

A = 2.64 in.²

B = 3.04 in.²

Cable fill #3: Divided with wire retainer

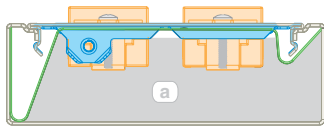

A = 4.64 in.²

Cable fill #4: Undivided with duplex receptacle on two sides

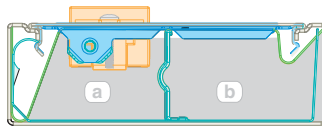

A = 1.87 in.²

B = 2.84 in.²

Cable fill #5: Divided with duplex receptacle on (A) side

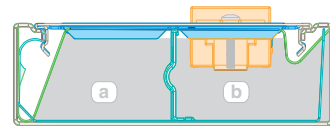

A = 2.49 in.²

B = 2.21 in.²

Cable fill #6: Divided with duplex receptacle on (B) side

SPEC = 40% cable fill – Recommended by TIA/EIA-569-B for design.

MAX for 60% cable fill – Recommended by TIA/EIA-569-B for unplanned additions.

MAX for 40% power cable fill – Based on available internal area.

| Raceway Type and Configuration | Fill Area (in. ²) | Electrical Cables | | | Data Grade Cables | | Data Grade Cables | | Audio/Video | |
|--|-------------------------------|-------------------|---------|---------|-------------------|---------|-------------------|---------|--------------|---------|
| | | 14 AWG | 12 AWG | 10 AWG | 24 AWG/UTP CM | | 24 AWG/UTP CM | | RG6 | |
| | | THHN/T90 | | | Category 6 | | Category 6A | | Dia. = 0.275 | |
| | | 0.111 | 0.130 | 0.164 | Dia. = 0.250 | | Dia. = 0.330 | | Dia. = 0.275 | |
| | | FILL | | | FILL | | FILL | | FILL | |
| | | MAX 40% | MAX 40% | MAX 40% | SPEC 40% | MAX 60% | SPEC 40% | MAX 60% | SPEC 40% | MAX 60% |
| 1. PMR40 – Undivided (base and cover) | 7.45 | 307 | 224 | 140 | 60 | 91 | 34 | 52 | 50 | 75 |
| 2. PMR40 – Undivided, wire retainer only | 6.18 | 255 | 186 | 117 | 50 | 75 | 28 | 43 | 41 | 62 |
| 3a. PMR40 – Divided, with wire retainer | 2.64 | 109 | 79 | 50 | 21 | 32 | 12 | 18 | 17 | 26 |
| | 3b. | 3.04 | 125 | 91 | 57 | 24 | 37 | 14 | 21 | 20 |
| 4. PMR40 – Undivided with duplex receptacle two sides | 4.64 | 191 | 139 | 87 | — | — | — | — | — | — |
| 5a. PMR40 – Divided with duplex receptacle on (A) side | 1.87 | 78 | 57 | 36 | — | — | — | — | — | — |
| | 5b. | 2.84 | — | — | — | 23 | 34 | 13 | 19 | 19 |
| 6a. PMR40 – Divided with duplex receptacle on (B) side | 2.49 | — | — | — | 20 | 30 | 11 | 17 | 16 | 25 |
| | 6b. | 2.21 | 91 | 66 | 41 | — | — | — | — | — |

AWG dimensions represent typical outer cable diameter in inches.

A.
System
Overview

PMR5/7 Raceway Roadmap

B1.
Cable Ties

B2.
Cable
Accessories

B3.
Stainless
Steel Ties

C1.
Wiring
Duct

C2.
Surface
Raceway

C3.
Abrasion
Protection

C4.
Cable
Management

D1.
Terminals

D2.
Power
Connectors

D3.
Grounding
Connectors

E1.
Labeling
Systems

E2.
Labels

E3.
Pre-Printed
& Write-On
Markers

E4.
Permanent
Identification

E5.
Lockout/
Tagout/
& Safety
Solutions

F.
Index

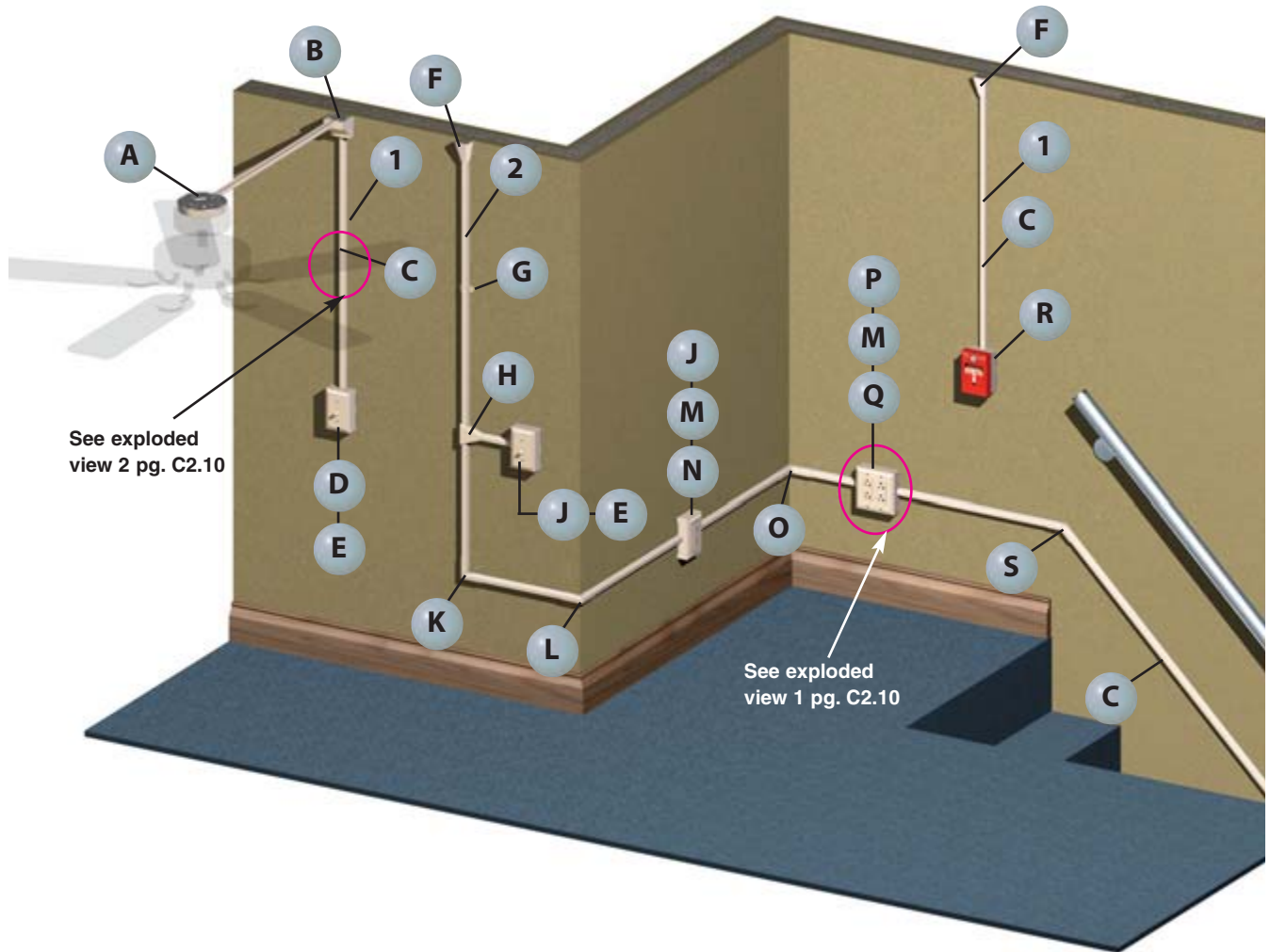

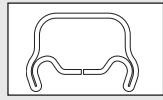

1 PMR5** – PMR5 Metal Raceway (page C2.11)

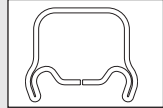

2 PMR7** – PMR7 Metal Raceway (page C2.11)



A PMR5738A** – Round Fan/Fixture Box (page C2.16)

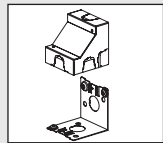

B PMR57CB** – Corner Box (page C2.12)

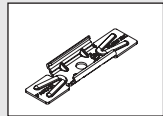

C PMR57SC-X – Supporting Clip (page C2.11)

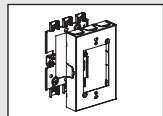

D PMR5751** – Single Gang Extension Box (page C2.15)

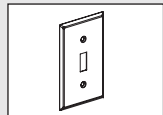

E MP1TS** – Single Gang Toggle Switch Faceplate (page C2.17)

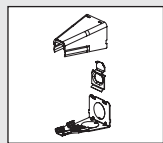

F PMR57EE – Entrance End Fitting (page C2.12)

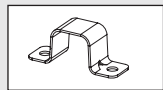

G PMR7MS** – Mounting Strap (page C2.11)

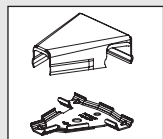

H PMR57T** – Tee Fitting (page C2.12)

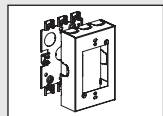

J PMR5747** – Single Gang Shallow Outlet Box (page C2.15)

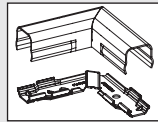

K PMR7RA** – Right Angle Fitting (page C2.12)

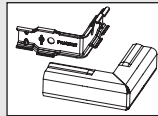

L PMR7OC** – Outside Corner Fitting (page C2.12)

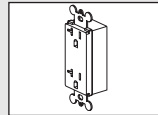

M ERU20** – 20 V Specification Grade Rectangular Outlet (page C2.60)

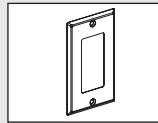

N MP1GR** – Single Gang Rectangular Faceplate (page C2.17)

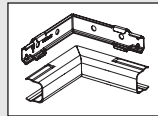

O PMR7IC** – Inside Corner Fitting (page C2.12)

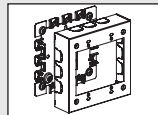

P PMR5747-2** – Double Gang Shallow Outlet Box (page C2.16)

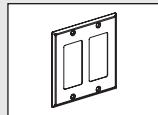

Q MP2GR** – Double Gang Rectangular Faceplate (page C2.17)

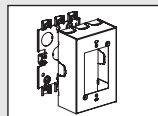

R PMR5748** – Single Gang Outlet Box (page C2.15)

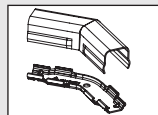

S PMR7DA** – Diagonal 45° Angle Fitting (page C2.12)

A. System Overview

B1. Cable Ties

B2. Cable Accessories

B3. Stainless Steel Ties

C1. Wiring Duct

C2. Surface Raceway

C3. Abrasion Protection

C4. Cable Management

D1. Terminals

D2. Power Connectors

D3. Grounding Connectors

E1. Labeling Systems

E2. Labels

E3. Pre-Printed & Write-On Markers

E4. Permanent Identification

E5. Lockout/Tagout & Safety Solutions

F. Index

A.
System
Overview

PMR5/PMR7 Configurations

B1.
Cable Ties

Exploded View 1

B2.
Cable
Accessories

| | Components Required | See page |
|----|--|----------|
| A. | MP2GR = Double gang rectangular faceplate. | C2.17 |
| B. | ERU20 = 20 A Specification rectangular outlet. | C2.60 |
| C. | PMR5747-2 = Double gang deep outlet box. | C2.16 |

B3.
Stainless
Steel Ties

C1.
Wiring
Duct

C2.
Surface
Raceway

C3.
Abrasion
Protection

C4.
Cable
Management

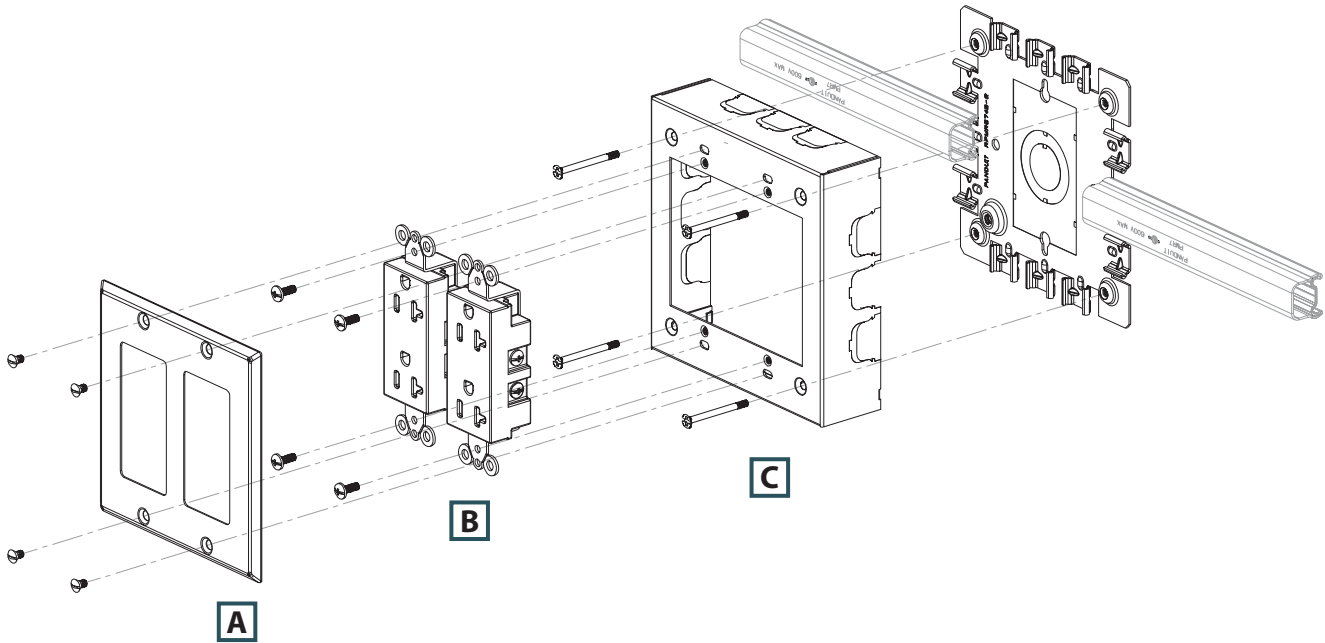

D1.
Terminals

D2.
Power
Connectors

Exploded View 2

D3.
Grounding
Connectors

| | Components Required | See page |
|----|-------------------------------|----------|
| A. | PMR57SC-X = Supporting clip. | C2.11 |
| B. | PMR7*** = PMR7 metal raceway. | C2.11 |

E1.
Labeling
Systems

E2.
Labels

E3.
Pre-Printed
& Write-On
Markers

E4.
Permanent
Identification

E5.
Lockout/
Tagout/
& Safety
Solutions

F.
Index

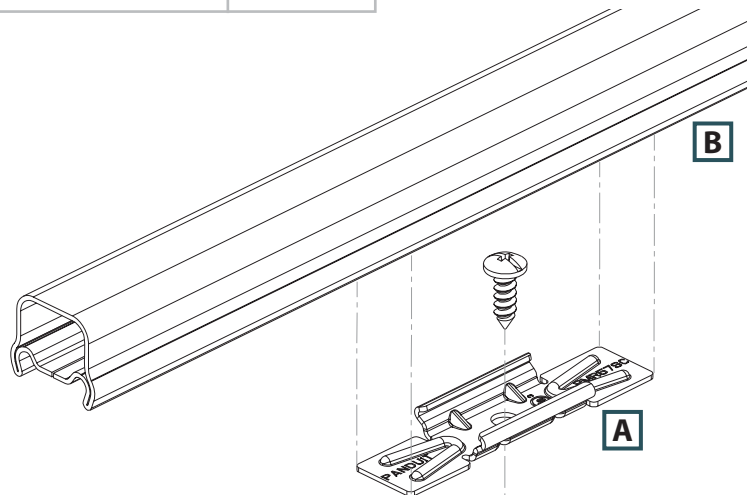

c-UL^{us} PAN-WAY® PMR5/PMR7 Metal Raceway System



- c-UL-us listed and rated to 600 V; meets UL 5 and CSA22.2 No. 62-93 safety standards
- Raceway system features a patent pending bonding design that provides full continuity of the ground path between fittings and channel, for increased electrical safety
- System components incorporate a unique snap mount assembly method for faster installation

- Fittings and mounts can be attached using various types and sizes of fasteners, eliminating the requirements of using only flat head style screws
- One-piece channel construction eliminates the problem of channel separation, associated with competitive two-piece designs, saving installation time

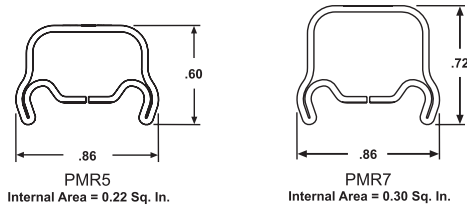

PMR5

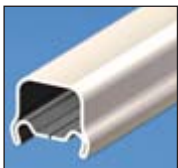

PMR7



PMR57SC

PMR57JC

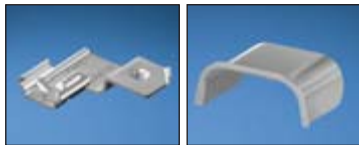

PMR57GC

PMR5WPB
PMR7WPB



PMR5MS
PMR7MS

| Part Number | Part Description | Raceway Size | Color‡ | Length (Ft.) | Std. Pkg. Qty. | Std. Ctn. Qty. |
|---------------------------|---|----------------------------------|--------|--------------|----------------|----------------|
| PMR5 Metal Raceway | | | | | | |
| PMR5WH5 | One-piece single channel metal surface raceway. Available in 5' lengths. | .86" x .60" (21.8mm x 15.2mm) | White | 5 | 5 | 50 |
| PMR5WH10 | One-piece single channel metal surface raceway. Available in 10' lengths. | .86" x .60" (21.8mm x 15.2mm) | White | 10 | 10 | 100 |
| PMR7 Metal Raceway | | | | | | |
| PMR7WH5 | One-piece single channel metal surface raceway. Available in 5' lengths. | .86" x .72" (21.8mm x 18.3mm) | White | 5 | 5 | 50 |
| PMR7WH10 | One-piece single channel metal surface raceway. Available in 10' lengths. | .86" x .72" (21.8mm x 18.3mm) | White | 10 | 10 | 100 |
| Supporting Clip | | | | | | |
| PMR57SC-X | Supporting clip used to support lengths of PMR5 or PMR7 raceway at any desired point. | — | Gray | — | 10 | 100 |
| Joint Coupling | | | | | | |
| PMR57JC-X | Joint coupling used to join two lengths of PMR5 or PMR7 raceway. | — | Gray | — | 10 | 100 |
| Ground Clip | | | | | | |
| PMR57GC-X | Ground clip used to provide additional grounding of raceway or to ground remote installations. For use with PMR5 or PMR7 raceway. | — | Gray | — | 10 | 100 |
| Metal Bushing | | | | | | |
| PMR5WPB-X | Bushing used to protect wires from abrasion. For use with PMR5 raceway. | — | Gray | — | 10 | 100 |
| PMR7WPB-X | Bushing used to protect wires from abrasion. For use with PMR7 raceway. | — | Gray | — | 10 | 100 |
| Mounting Strap | | | | | | |
| PMR5MSWH-X | Mounting strap for use with PMR5 raceway. | — | White | — | 10 | 100 |
| PMR7MSWH-X | Mounting strap for use with PMR7 raceway. | — | White | — | 10 | 100 |

‡For other colors replace WH (White) with AL (Almond).

A.
System
Overview

B1.
Cable Ties

B2.
Cable
Accessories

B3.
Stainless
Steel Ties

C1.
Wiring
Duct

C2.
Surface
Raceway

C3.
Abrasion
Protection

C4.
Cable
Management

D1.
Terminals

D2.
Power
Connectors

D3.
Grounding
Connectors

E1.
Labeling
Systems

E2.
Labels

E3.
Pre-Printed
& Write-On
Markers

E4.
Permanent
Identification

E5.
Lockout/
Tagout
& Safety
Solutions

F.
Index



PAN-WAY® PMR5/PMR7 Metal Raceway Fittings

A. System Overview

B1. Cable Ties

B2. Cable Accessories

B3. Stainless Steel Ties

C1. Wiring Duct

C2. Surface Raceway

C3. Abrasion Protection

C4. Cable Management

D1. Terminals

D2. Power Connectors

D3. Grounding Connectors

E1. Labeling Systems

E2. Labels

E3. Pre-Printed & Write-On Markers

E4. Permanent Identification

E5. Lockout/Tagout & Safety Solutions

F. Index

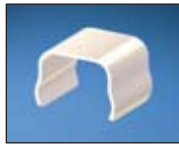

PMR5CC
PMR7CC



PMR5RA
PMR7RA



PMR5DA
PMR7DA



PMR5IC
PMR7IC

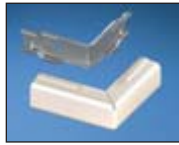

PMR5OC
PMR7OC



PMR57LTE



PMR57RTE

PMR57T



PMR57EE

PMR57AOC



PMR57CB

PMR57TR
PMR7TR



PMR57EBC

PMR57ECC



PMR57JBC50
PMR57JBC75



PMR57CC50
PMR57CC75

| Part Number | Part Description | Color‡ | Std. Pkg. Qty. | Std. Ctn. Qty. |
|---------------------|---|--------|----------------|----------------|
| PMR5CCWH-X | Coupler fitting for use with PMR5 raceway. | White | 10 | 100 |
| PMR7CCWH-X | Coupler fitting for use with PMR7 raceway. | White | 10 | 100 |
| PMR5RAWH | Right angle fitting for use with PMR5 raceway. | White | 1 | 10 |
| PMR7RAWH | Right angle fitting for use with PMR7 raceway. | White | 1 | 10 |
| PMR5DAWH | Diagonal 45° angle fitting for use with PMR5 raceway. | White | 1 | 10 |
| PMR7DAWH | Diagonal 45° angle fitting for use with PMR7 raceway. | White | 1 | 10 |
| PMR5ICWH | Inside corner fitting for use with PMR5 raceway. | White | 1 | 10 |
| PMR7ICWH | Inside corner fitting for use with PMR7 raceway. | White | 1 | 10 |
| PMR5OCWH | Outside corner fitting for use with PMR5 raceway. | White | 1 | 10 |
| PMR7OCWH | Outside corner fitting for use with PMR7 raceway. | White | 1 | 10 |
| PMR57LTEWH | Left twisted elbow for 90° twist with 90° turn. For double turn at right angles from one surface to another, such as a flat run on a sidewall to a flat run on a ceiling. For use with PMR5 and PMR7 raceway. | White | 1 | 10 |
| PMR57RTEWH | Right twisted elbow for 90° twist with 90° turn. For double turn at right angles from one surface to another, such as a flat run on a sidewall to a flat run on a ceiling. For use with PMR5 and PMR7 raceway. | White | 1 | 10 |
| PMR57TWH | Tee fitting for use with PMR5 or PMR7 raceway. | White | 1 | 10 |
| PMR57EEWH | Entrance end fitting. 1/2" conduit breakouts allows entry of PMR5 or PMR7 raceway from a box, the ceiling, or a wall. Spring steel bushing included for use when connecting to a box. | White | 1 | 10 |
| PMR57AOCWH | Adjustable offset allows PMR5 or PMR7 to be mounted flush to wall when connected to surface type panel boxes. Adjustable between 5/8" and 1 3/8" from surface to center of conduit. 1/2" chase nipple and locknut included. | White | 1 | 10 |
| PMR57CBWH | Corner box for connecting PMR5 or PMR7 raceway. Each leg has 1/2" conduit breakouts and room for splicing. | White | 1 | 10 |
| PMR57TRWH | WIREMOLD* to PMR5 transition fitting. In-line transition fitting from Wiremold* 500 series to PMR5 raceway. | White | 1 | 10 |
| PMR77TRWH | WIREMOLD* to PMR7 Transition fitting. In-line transition fitting from WIREMOLD* 700 series to PMR7 raceway. | White | 1 | 10 |
| PMR57EBCWH | Elbow box connector used to connect PMR5 or PMR7 raceway to boxes at a right angle. Breakouts for 1/2" conduit. | White | 1 | 10 |
| PMR57ECCWH | Elbow conduit connector used to connect PMR5 or PMR7 raceway to conduit at a right angle. Breakouts for 1/2" conduit. | White | 1 | 10 |
| PMR57JBC50-X | Junction box connector used to connect PMR5 or PMR7 raceway to boxes with 1/2" conduit breakout. | White | 10 | 100 |
| PMR57JBC75-X | Junction box connector used to connect PMR5 or PMR7 raceway to boxes with 3/4" conduit breakout. | White | 10 | 100 |
| PMR57CC50-X | Conduit connector used to connect PMR5 or PMR7 raceway to 1/2" conduit. | White | 10 | 100 |
| PMR57CC75-X | Conduit connector used to connect PMR5 or PMR7 raceway to 3/4" conduit. | White | 10 | 100 |

‡For other colors replace WH (White) with AL (Almond).

*WIREMOLD is a registered trademark of the Wiremold Co.

cUL^{us} PMR5 and PMR7 Raceway Accessories



PMR57MRT

PMRTUP**

| Part Number | Part Description | Color | Std. Pkg. Qty. | Std. Ctn. Qty. |
|-----------------|--|-------|----------------|----------------|
| PMR57MRT | Metal raceway tool. To aid in the installation and removal of PMR5 and PMR7 metal raceway base sections. | Black | 1 | 10 |
| PMRTUPAL | Touch-up paint pen. Used to repair areas of metal raceway where paint has been removed or damaged. | — | 1 | 10 |
| PMRTUPWH | Touch-up paint pen. Used to repair areas of metal raceway where paint has been removed or damaged. | — | 1 | 10 |

A. System Overview

B1. Cable Ties

B2. Cable Accessories

B3. Stainless Steel Ties

C1. Wiring Duct

C2. Surface Raceway

C3. Abrasion Protection

C4. Cable Management

D1. Terminals

D2. Power Connectors

D3. Grounding Connectors

E1. Labeling Systems

E2. Labels

E3. Pre-Printed & Write-On Markers

E4. Permanent Identification

E5. Lockout/Tagout & Safety Solutions

F. Index

A. System Overview

Cable Fill Capacities for PMR5/PMR7 Metal Raceway

B1. Cable Ties

This information is to be used as a guide in selecting the proper size raceway. The maximum amounts may vary according to the cable installation methods, straightness of cables, etc.

B2. Cable Accessories

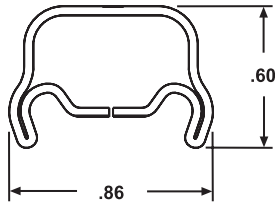

PMR5

$$A = .22 \text{ in.}^2$$

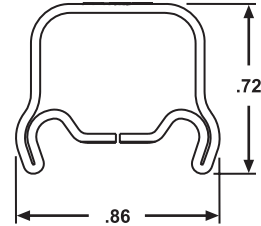

PMR7

$$A = .30 \text{ in.}^2$$

B3. Stainless Steel Ties

C1. Wiring Duct

C2. Surface Raceway

C3. Abrasion Protection

C4. Cable Management

SPEC = 40% cable fill – The recommended design in cable capacity, leaves room for future moves, adds, and changes.

MAX for Data = 60% cable fill – The maximum cable quantity based on cable interweaving and packing factors.

D1. Terminals

D2. Power Connectors

D3. Grounding Connectors

| Raceway Type and Configuration | Fill Area (In. ²) | Electrical Cables | | | Data Grade Cables | | Data Grade Cables | | Audio/Video | | Fiber Optic Cable | |
|--------------------------------|-------------------------------|-------------------|--------|--------|-------------------|-----|-------------------|-----|--------------|-----|-------------------|-----|
| | | 14 AWG | 12 AWG | 10 AWG | 24 AWG/UTP CM | | 24 AWG/UTP CM | | RG6 | | 2 Strand | |
| | | THHN/T90 | | | Category 6 | | Category 6A | | Dia. = 0.275 | | Dia. = 0.175 | |
| | | 0.111 | 0.130 | 0.164 | Dia. = 0.250 | | Dia. = 0.330 | | FILL | | FILL | |
| | | FILL | | | FILL | | FILL | | FILL | | FILL | |
| MAX | MAX | MAX | SPEC | MAX | SPEC | MAX | SPEC | MAX | SPEC | MAX | SPEC | MAX |
| 40% | 40% | 40% | 40% | 60% | 40% | 60% | 40% | 60% | 40% | 60% | 40% | 60% |
| PMR5 | 0.22 | 9 | 6 | 4 | 1 | 2 | 1 | 1 | 1 | 2 | 3 | 5 |
| PMR7 | 0.30 | 12 | 8 | 5 | 2 | 3 | 1 | 2 | 2 | 3 | 4 | 7 |

AWG dimensions represent typical outer cable diameter in inches.

E1. Labeling Systems

E2. Labels

E3. Pre-Printed & Write-On Markers

E4. Permanent Identification

E5. Lockout/Tagout & Safety Solutions

F. Index

UL **PAN-WAY® Metal Raceway Boxes**

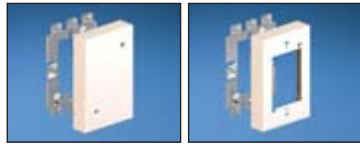

PMR5760

PMR5751

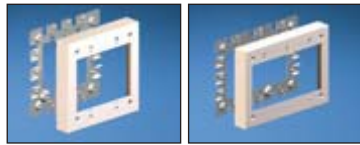

PMR5751-2

PMR5751-3

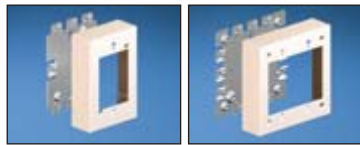

PMR5747

PMR5747-2

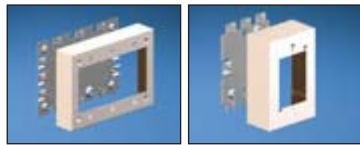

PMR5747-3

PMR5748

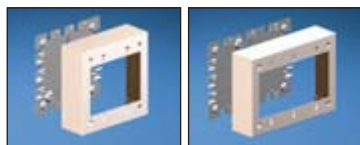

PMR5748-2

PMR5748-3

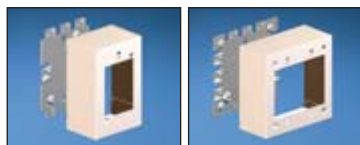

PMR5744S

PMR5744S-2

| Part Number | Part Description | Color‡ | Std. Pkg. Qty. | Std. Ctn. Qty. |
|--------------|--|--------|----------------|----------------|
| PMR5760WH | Single gang blank extension box. For use with <i>PAN-WAY</i> ® PMR5 or PMR7 Raceway. 4.92"L x 3.17"W x .94"H (125.0mm x 80.5mm x 23.8mm) | White | 1 | 10 |
| PMR5751WH | Single gang extension box. Box accepts <i>PAN-WAY</i> ® Faceplates or any NEMA standard single gang faceplate. For use with <i>PAN-WAY</i> ® PMR5 or PMR7 Raceway. 4.92"L x 3.17"W x .94"H (125.0mm x 80.5mm x 23.8mm) | White | 1 | 10 |
| PMR5751-2WH | Double gang extension box. Box accepts <i>PAN-WAY</i> ® Faceplates or any standard double gang faceplate. For use with <i>PAN-WAY</i> ® PMR5 or PMR7 Raceway. 4.92"L x 4.92"W x .94"H (125.0mm x 125.0mm x 23.8mm) | White | 1 | 10 |
| PMR5751-3WH | Three gang extension box. Box accepts <i>PAN-WAY</i> ® Faceplates or any standard three gang faceplate. For use with <i>PAN-WAY</i> ® PMR5 or PMR7 Raceway. 4.92"L x 6.72"W x .94"H (125.0mm x 170.7mm x 23.8mm) | White | 1 | 10 |
| PMR5747WH | Single gang shallow outlet box. Box accepts <i>PAN-WAY</i> ® Faceplates or any NEMA standard single gang faceplate. For use with <i>PAN-WAY</i> ® PMR5 or PMR7 Raceway. Breakouts for 1/2" conduit. 4.92"L x 3.17"W x 1.38"H (125.0mm x 80.5mm x 34.9mm) | White | 1 | 10 |
| PMR5747-2WH | Double gang shallow outlet box. Box accepts <i>PAN-WAY</i> ® Faceplates or any standard double gang faceplate. For use with <i>PAN-WAY</i> ® PMR5 or PMR7 Raceway. Breakouts for 1/2" and 1" conduit. 4.92"L x 4.92"W x 1.38"H (125.0mm x 125.0mm x 34.9mm) | White | 1 | 10 |
| PMR5747-3WH | Three gang shallow outlet box. Box accepts <i>PAN-WAY</i> ® Faceplates or any standard three gang faceplate. For use with <i>PAN-WAY</i> ® PMR5 or PMR7 Raceway. Breakouts for 1/2" conduit. 4.92"L x 6.72"W x 1.38"H (125.0mm x 170.7mm x 34.9mm) | White | 1 | 10 |
| PMR5748WH | Single gang outlet box. Box accepts <i>PAN-WAY</i> ® Faceplates or any NEMA standard single gang faceplate. For use with <i>PAN-WAY</i> ® PMR5 or PMR7 Raceway. Breakouts for 1/2" conduit. 4.92"L x 3.17"W x 1.75"H (125.0mm x 80.5mm x 44.5mm) | White | 1 | 10 |
| PMR5748-2WH | Double gang outlet box. Box accepts <i>PAN-WAY</i> ® Faceplates or any standard double gang faceplate. For use with <i>PAN-WAY</i> ® PMR5 or PMR7 Raceway. Breakouts for 1/2" and 1" conduit. 4.92"L x 4.92"W x 1.75"H (125.0mm x 125.0mm x 44.5mm) | White | 1 | 10 |
| PMR5748-3WH | Three gang outlet box. Box accepts <i>PAN-WAY</i> ® Faceplates or any standard three gang faceplate. For use with <i>PAN-WAY</i> ® PMR5 or PMR7 Raceway. Breakouts for 1/2" conduit. 4.92"L x 6.72"W x 1.75"H (125.0mm x 170.7mm x 44.5mm) | White | 1 | 10 |
| PMR5744SWH | Single gang intermediate outlet box. Box accepts <i>PAN-WAY</i> ® Faceplates or any NEMA standard single gang faceplate. For use with <i>PAN-WAY</i> ® PMR5 or PMR7 Raceway. Breakouts for 1/2" conduit. 4.92"L x 3.17"W x 2.25"H (125.0mm x 80.5mm x 57.2mm) | White | 1 | 10 |
| PMR5744S-2WH | Double gang intermediate outlet box. Box accepts <i>PAN-WAY</i> ® Faceplates or any standard double gang faceplate. For use with <i>PAN-WAY</i> ® PMR5 or PMR7 Raceway. Breakouts for 1/2" and 1" conduit. 4.92"L x 4.92"W x 2.25"H (125.0mm x 125.0mm x 57.2mm) | White | 1 | 10 |

‡For other colors replace WH (White) with AL (Almond).

A. System Overview

B1. Cable Ties

B2. Cable Accessories

B3. Stainless Steel Ties

C1. Wiring Duct

C2. Surface Raceway

C3. Abrasion Protection

C4. Cable Management

D1. Terminals

D2. Power Connectors

D3. Grounding Connectors

E1. Labeling Systems

E2. Labels

E3. Pre-Printed & Write-On Markers

E4. Permanent Identification

E5. Lockout/Tagout & Safety Solutions

F. Index

Table continues on page C2.16



PAN-WAY® Metal Raceway Boxes (continued)

- A. System Overview
- B1. Cable Ties
- B2. Cable Accessories
- B3. Stainless Steel Ties
- C1. Wiring Duct
- C2. Surface Raceway
- C3. Abrasion Protection
- C4. Cable Management
- D1. Terminals
- D2. Power Connectors
- D3. Grounding Connectors
- E1. Labeling Systems
- E2. Labels
- E3. Pre-Printed & Write-On Markers
- E4. Permanent Identification
- E5. Lockout/Tagout & Safety Solutions
- F. Index

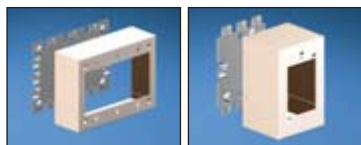

PMR5744S-3

PMR5744

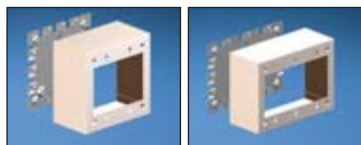

PMR5744-2

PMR5744-3



PMR5738

PMR5738A



PMR5739

PMR5737



PMR5737A

PMR5739A

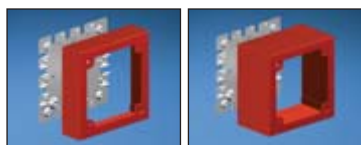

PMR5752

PMR5753

| Part Number | Part Description | Color‡ | Std. Pkg. Qty. | Std. Ctn. Qty. |
|--------------|--|--------|----------------|----------------|
| PMR5744S-3WH | Three gang intermediate outlet box. Box accepts PAN-WAY® Faceplates or any standard three gang faceplate. For use with PAN-WAY® PMR5 or PMR7 Raceway. Breakouts for 1/2" conduit. 4.92"L x 6.72"W x 2.25"H (125.0mm x 170.7mm x 57.2mm) | White | 1 | 10 |
| PMR5744WH | Single gang deep outlet box. Box accepts PAN-WAY® Faceplates or any NEMA standard single gang faceplate. For use with PAN-WAY® PMR5 or PMR7 Raceway. Breakouts for 1/2" conduit. 4.92"L x 3.17"W x 2.75"H (125.0mm x 80.5mm x 69.9mm) | White | 1 | 10 |
| PMR5744-2WH | Double gang deep outlet box. Box accepts PAN-WAY® Faceplates or any standard double gang faceplate. For use with PAN-WAY® PMR5 or PMR7 Raceway. Breakouts for 1/2" and 1" conduit. 4.92"L x 4.92"W x 2.75"H (125.0mm x 80.5mm x 69.9mm) | White | 1 | 10 |
| PMR5744-3WH | Three gang deep outlet box. Box accepts PAN-WAY® Faceplates or any standard three gang faceplate. For use with PAN-WAY® PMR5 or PMR7 Raceway. Breakouts for 1/2" conduit. 4.92"L x 6.72"W x 2.75"H (125.0mm x 170.7mm x 69.9mm) | White | 1 | 10 |
| PMR5738WH | Round fixture box with solid base is c-UL-us rated to accept devices up to 50 lbs. For use with PAN-WAY® PMR5 or PMR7 Raceway. Base has four 1/2" conduit breakouts. Dia. = 4.77"D x 1.00"H (121.2mm x 25.4mm) | White | 1 | 10 |
| PMR5738AWH | Round fan or fixture box with solid base is c-UL-us rated to accept devices up to 50 lbs. For use with PAN-WAY® PMR5 or PMR7 Raceway. Base has four 1/2" conduit breakouts. Dia. = 5.53"D x 1.00"H (140.5mm x 25.4mm) | White | 1 | 10 |
| PMR5739WH | Round fixture box with solid base is c-UL-us rated to accept devices up to 50 lbs. For use with PAN-WAY® PMR5 or PMR7 Raceway. Base has four 1/2" conduit breakouts. Dia. = 6.37"D x 1.00"H (161.8mm x 25.4mm) | White | 1 | 10 |
| PMR5737WH | Round extension box with open base is c-UL-us rated to accept devices up to 50 lbs. For use with PAN-WAY® PMR5 or PMR7 Raceway. Dia. = 4.76"D x 1.00"H (121.0mm x 25.4mm) | White | 1 | 10 |
| PMR5737AWH | Round extension box with open base is c-UL-us rated to accept devices up to 50 lbs. For use with PAN-WAY® PMR5 or PMR7 Raceway. Dia. = 5.53"D x 1.00"H (140.5mm x 25.4mm) | White | 1 | 10 |
| PMR5739AWH | Round extension box with open base is c-UL-us rated to accept devices up to 50 lbs. For use with PAN-WAY® PMR5 or PMR7 Raceway. Dia. = 6.37"D x 1.00"H (161.8mm x 25.4mm) | White | 1 | 10 |
| PMR5752RD | Alarm device box. Box accepts alarm devices and safety signals designed to fit 4" square back boxes. For use with PAN-WAY® PMR5 or PMR7 Raceway. Breakouts for 1/2" and 1" conduit. 4.92"L x 4.92"W x 1.42"H (125.0mm x 125.0mm x 36.1mm) Available in red only. | Red | 1 | 10 |
| PMR5753RD | Deep alarm device box. Box accepts alarm devices and safety signals designed to fit 4" square back boxes. For use with PAN-WAY® PMR5 or PMR7 Raceway. Breakouts for 1/2" and 1" conduit. 4.92"L x 4.92"W x 2.80"H (125.0mm x 125.0mm x 71.0mm) Available in red only. | Red | 1 | 10 |

‡For other colors replace WH (White) with AL (Almond).



PAN-WAY® Metal Raceway Faceplates

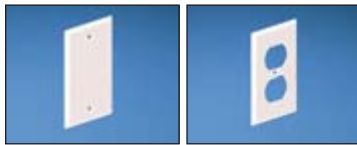

MP1GB

MP1G106

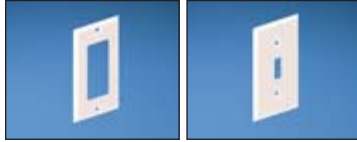

MP1GR

MP1TS



MP2GB

MP2G106



MP2GR

MP2TS



MP2G106B

MP2G106TS



MP2GRB

MP2GRTS



MP2G106R

MP3G106



MP3GR

MP3TS



MP3G1062TS

| Part Number | Part Description | Color‡ | Std. Pkg. Qty. | Std. Ctn. Qty. |
|--------------|--|--------|----------------|----------------|
| MP1GBWH | Metal single gang blank faceplate. | White | 1 | 10 |
| MP1G106WH | Metal single gang 106 duplex faceplate. Covers one NEMA standard 106 duplex electrical outlet or one standard 106 communication module frame. | White | 1 | 10 |
| MP1GRWH | Metal single gang rectangular faceplate. Covers one NEMA standard rectangular electrical outlet or one standard rectangular communication module frame | White | 1 | 10 |
| MP1TSWH | Metal single gang toggle switch faceplate. Covers one NEMA standard toggle switch. | White | 1 | 10 |
| MP2GBWH | Metal double gang blank faceplate. | White | 1 | 10 |
| MP2G106WH | Metal double gang 106 duplex faceplate. Covers two NEMA standard 106 duplex electrical outlets or two standard 106 communication module frames. | White | 1 | 10 |
| MP2GRWH | Metal double gang rectangular faceplate. Covers two NEMA standard rectangular electrical outlets or two standard rectangular communication module frames. | White | 1 | 10 |
| MP2TSWH | Metal double gang toggle switch faceplate. Covers two NEMA standard toggle switch. | White | 1 | 10 |
| MP2G106BWH | Metal double gang 106 duplex/blank faceplate. Covers one NEMA standard 106 duplex electrical outlet or standard 106 communication module frame with opposite side blank. | White | 1 | 10 |
| MP2G106TSWH | Metal double gang 106 duplex/toggle switch faceplate. Covers one NEMA standard 106 duplex outlet or standard 106 communication module frame and one NEMA standard toggle switch. | White | 1 | 10 |
| MP2GRBWH | Metal double gang rectangular/blank faceplate. Covers one NEMA standard rectangular electrical outlet or standard rectangular communication module frame with opposite side blank. | White | 1 | 10 |
| MP2GRTSWH | Metal double gang rectangular/toggle switch faceplate. Covers one NEMA standard rectangular electrical outlet or standard rectangular communication module frame and one NEMA standard toggle switch. | White | 1 | 10 |
| MP2G106RWH | Metal double gang 106 duplex/rectangular faceplate. Covers one NEMA standard 106 duplex outlet or standard 106 communication module frame and one NEMA standard rectangular outlet or standard rectangular communication module frame. | White | 1 | 10 |
| MP3G106WH | Metal three gang 106 duplex faceplate. Covers three NEMA standard 106 duplex electrical outlets or three standard 106 communication module frames. | White | 1 | 10 |
| MP3GRWH | Metal three gang rectangular faceplate. Covers three NEMA standard rectangular electrical outlets or three standard rectangular communication module frames. | White | 1 | 10 |
| MP3TSWH | Metal three gang toggle switch faceplate. Covers three NEMA standard toggle switches. | White | 1 | 10 |
| MP3G1062TSWH | Metal three gang 106 duplex/two toggle switch faceplate. Covers one NEMA standard 106 duplex electrical outlet or one standard 106 communication module frame and two NEMA standard toggle switches. | White | 1 | 10 |

‡For other colors replace WH (White) with AL (Almond).

A. System Overview

B1. Cable Ties

B2. Cable Accessories

B3. Stainless Steel Ties

C1. Wiring Duct

C2. Surface Raceway

C3. Abrasion Protection

C4. Cable Management

D1. Terminals

D2. Power Connectors

D3. Grounding Connectors

E1. Labeling Systems

E2. Labels

E3. Pre-Printed & Write-On Markers

E4. Permanent Identification

E5. Lockout/Tagout & Safety Solutions

F. Index

A. System Overview

B1. Cable Ties

B2. Cable Accessories

B3. Stainless Steel Ties

PAN-WAY® Non-Metallic Surface Raceway

PAN-WAY® Non-Metallic Surface Raceways provide maximum flexibility for routing, protecting, concealing and terminating high performance copper, voice, video, fiber optic and power cabling. PANDUIT surface raceways are designed with attention to function and aesthetics to blend with any décor. PANDUIT surface raceway systems include transition fittings that facilitate seamless integration of one PANDUIT surface raceway system to another. PANDUIT Surface Raceway Systems work with all PANDUIT® MINI-COM® Modules for complete connectivity possibilities.



- Aesthetically pleasing
- Lightweight
- Tamper resistant
- Bend radius control
- Resists dents and conceals scratches and chips
- Ease of modifications and additions
- Lowest installed cost

C1. Wiring Duct

C2. Surface Raceway

C3. Abrasion Protection

C4. Cable Management

D1. Terminals

D2. Power Connectors

D3. Grounding Connectors

E1. Labeling Systems

PANDUIT surface raceway provides a variety of choices when selecting data and electrical terminations. All PANDUIT surface raceways include a full complement of fittings that are designed to maintain the proper bend radius control required for high performance copper and fiber optic cabling systems. All of the raceways accept either NEMA 70mm standard screw-on faceplates or superior PAN-WAY® Snap-On Faceplates. PANDUIT surface raceway systems work with all PANDUIT® MINI-COM® Modules, for complete connectivity possibilities.

E2. Labels

E3. Pre-Printed & Write-On Markers

E4. Permanent Identification

E5. Lockout/Tagout & Safety Solutions

F. Index

PAN-WAY® TG-70 Non-Metallic Surface Raceway

PAN-WAY® TG-70 Non-Metallic Surface Raceway is a multi-channel raceway, which provides a solution for routing copper, fiber optic, and/or power cabling when maximum cable capacity is required.



- Large raceway channel provides maximum capacity
- Fittings maintain 40mm (1.6 inch) bend radius control
- Multi-channel two-piece design
- Aesthetically pleasing
- Lightweight
- Tamper resistant



The TG-70 raceway system consists of raceway base and cover, fittings, termination hardware and accessories. PAN-WAY® TG-70 Raceway can mount NEMA standard screw-on faceplates or superior PAN-WAY® Snap-On Faceplates directly to the channel. Fittings for TG-70 are available to transition to PAN-WAY® T-45 and LD raceway.

A.
System
Overview

B1.
Cable Ties

B2.
Cable
Accessories

B3.
Stainless
Steel Ties

C1.
Wiring
Duct

C2.
Surface
Raceway

C3.
Abrasion
Protection

C4.
Cable
Management

D1.
Terminals

D2.
Power
Connectors

D3.
Grounding
Connectors

E1.
Labeling
Systems

E2.
Labels

E3.
Pre-Printed
& Write-On
Markers

E4.
Permanent
Identification

E5.
Lockout/
Tagout
& Safety
Solutions

F.
Index

A.
System
Overview

TG-70 Raceway Roadmap

B1.
Cable Ties

B2.
Cable
Accessories

B3.
Stainless
Steel Ties

C1.
Wiring
Duct

C2.
Surface
Raceway

C3.
Abrasion
Protection

C4.
Cable
Management

D1.
Terminals

D2.
Power
Connectors

D3.
Grounding
Connectors

E1.
Labeling
Systems

E2.
Labels

E3.
Pre-Printed
& Write-On
Markers

E4.
Permanent
Identification

E5.
Lockout/
Tagout/
& Safety
Solutions

F.
Index

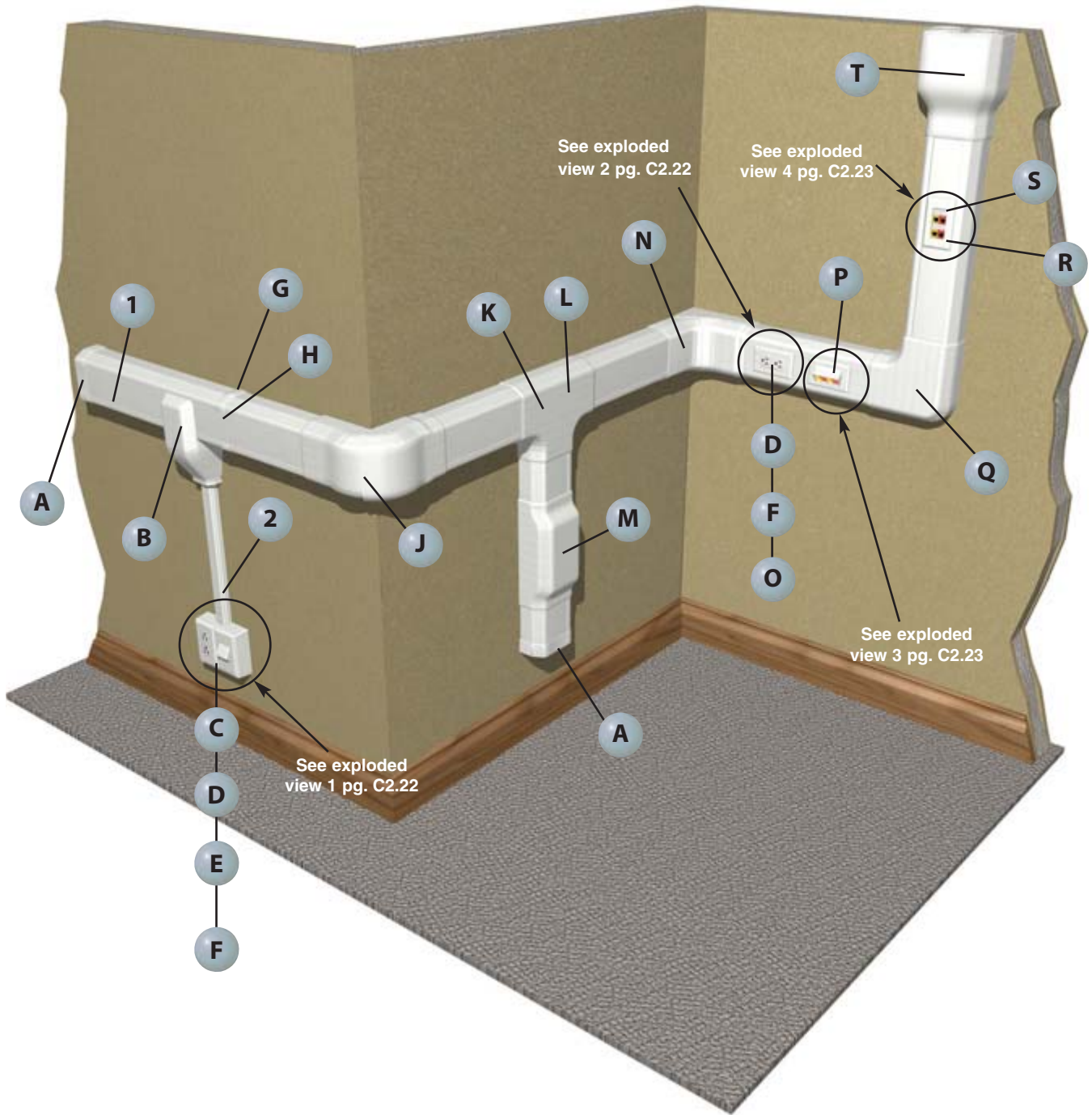

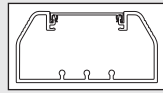

1 TG-70** – TG-70 Raceway Base and Cover (page C2.24)

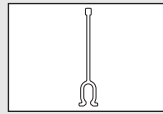

1 TGDW – TG-70 Raceway Divider Wall (page C2.24)

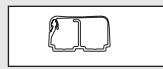

2 LD2P10** – Raceway (page C2.75)

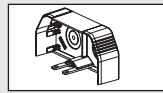

A TGEC** – TG-70 End Cap (page C2.25)

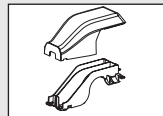

B TGTR** – TG-70 Transition Fitting (page C2.25)

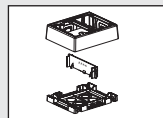

C JBP2FS** – *FAST-SNAP*™ Double Gang Power Rated Surface Mount Box (page C2.52)

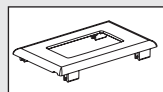

D T70PG** – Single Gang Rectangular Electrical/Communication Snap-On Faceplate (page C2.53)



E T70FV2** – Vertical Sloped Communication Snap-On Faceplate (page C2.52)

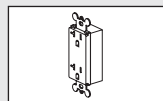

F ERU20** – 20 A Rectangular Electrical Outlet (page C2.60)

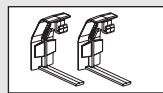

G TG70BC** – TG-70 Base Couplers (page C2.25)

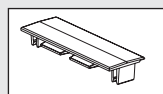

H T70CC** – T-70 Cover Couplers (page C2.25)

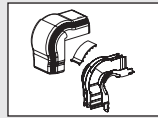

J TGOC** — TG-70 Outside Corner Fitting (page C2.25)

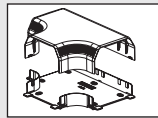

K TGT** — TG-70 Tee Fitting (page C2.25)

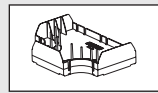

L TGTD — TG Tee Divider (page C2.25)

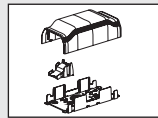

M TGBF** — TG-70 Backfeed Fitting (page C2.25)

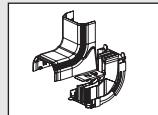

N TGIC** — TG-70 Inside Corner Fitting (page C2.25)

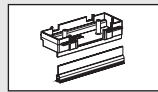

O TG70HB3-X – TG-70 Hanging Box with Divider Wall (page C2.26)

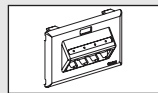

P UIT70FH4** – *ULTIMATE ID*® Sloped Horizontal Snap-On Faceplate

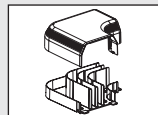

Q TGRA** – TG-70 Right Angle Fitting (page C2.25)

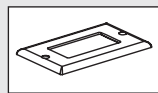

R CPG** – Single Gang Rectangular Power and Communication Faceplate (page C2.59)

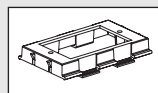

S T70DB-X – T-70 Device Bracket (page C2.26)

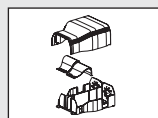

T TGEE** – TG-70 Entrance End Fitting (page C2.25)

A. System Overview

B1. Cable Ties

B2. Cable Accessories

B3. Stainless Steel Ties

C1. Wiring Duct

C2. Surface Raceway

C3. Abrasion Protection

C4. Cable Management

D1. Terminals

D2. Power Connectors

D3. Grounding Connectors

E1. Labeling Systems

E2. Labels

E3. Pre-Printed & Write-On Markers

E4. Permanent Identification

E5. Lockout/Tagout & Safety Solutions

F. Index

A.
System
Overview

TG-70 Configurations

B1.
Cable Ties

Exploded View 1

| | Components Required | See page |
|----|---|----------|
| A. | T70FV2 = Vertical sloped communication snap-on faceplate. | C2.52 |
| B. | PANDUIT® MINI-COM® Modules. | — |
| C. | T70PG = Single gang rectangular electrical/communication snap-on faceplate. | C2.53 |
| D. | ERU20 = 20 A rectangular electrical outlet (screws included). | C2.60 |
| E. | JBP2FS = FAST-SNAP™ Double Gang Power Rated Surface Mount Outlet Box. | C2.52 |

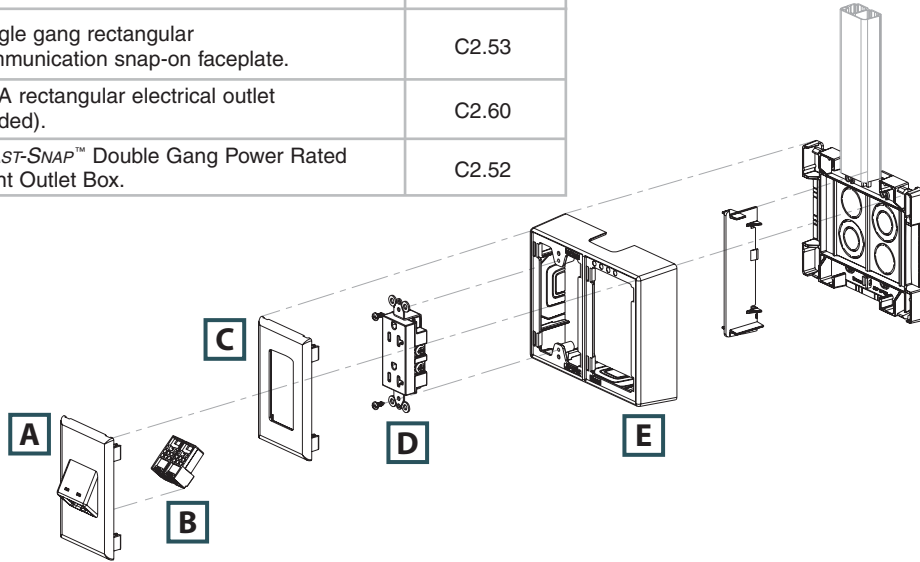

D1.
Terminals

Exploded View 2

| | Components Required | See page |
|----|---|----------|
| A. | T70PG = Single gang rectangular electrical/communication snap-on faceplate. | C2.53 |
| B. | ERU20 = 20 A rectangular electrical outlet (screws included). | C2.60 |
| C. | TG70HB3 = TG-70 3-sided hanging box. | C2.26 |

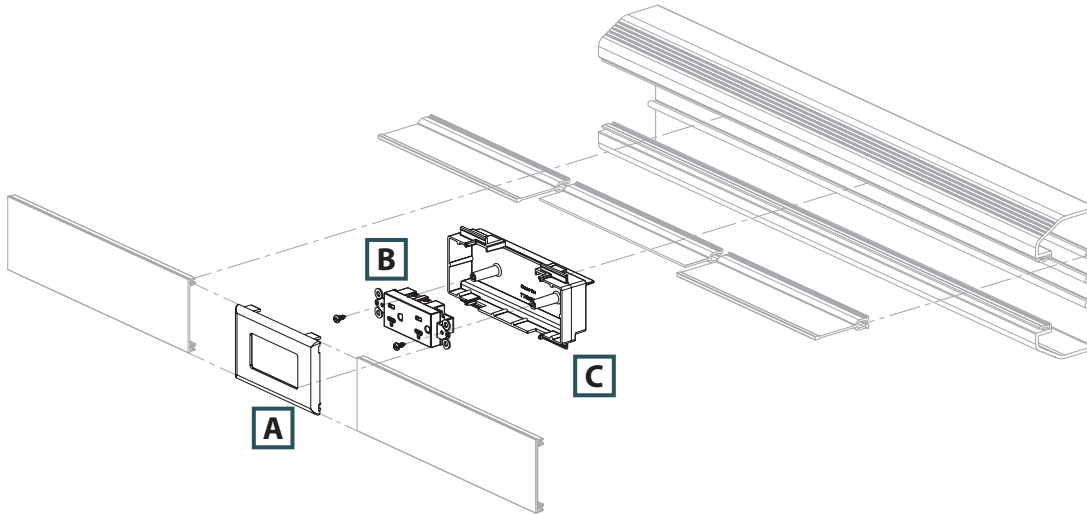

E1.
Labeling
Systems

E2.
Labels

E3.
Pre-Printed
& Write-On
Markers

E4.
Permanent
Identification

E5.
Lockout/
Tagout/
& Safety
Solutions

F.
Index

TG-70 Configurations (continued)

Exploded View 3

| | Components Required | See page |
|----|---|----------|
| A. | UIT70FH4 = <i>ULTIMATE ID</i> ® Sloped Horizontal Snap-On Faceplate – 4-port. | — |
| B. | <i>MINI-COM</i> ® Modules. | — |

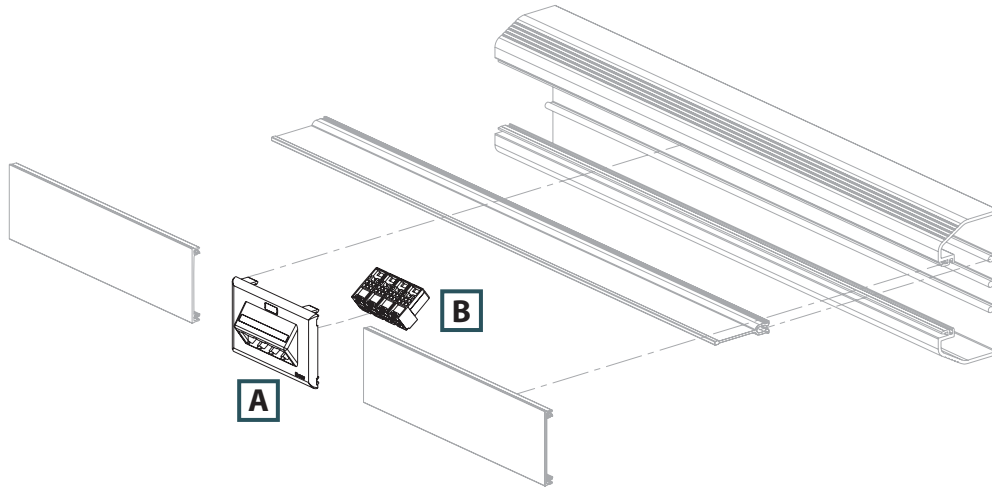

Exploded View 4

| | Components Required | See page |
|----|---|----------|
| A. | CPG = Single gang rectangular screw-on faceplate (screws included). | C2.59 |
| B. | CFG4 = <i>MINI-COM</i> ® Module Frame – 4-port. | — |
| C. | <i>MINI-COM</i> ® Modules. | — |
| D. | T70DB-X = T70 device bracket. | C2.26 |

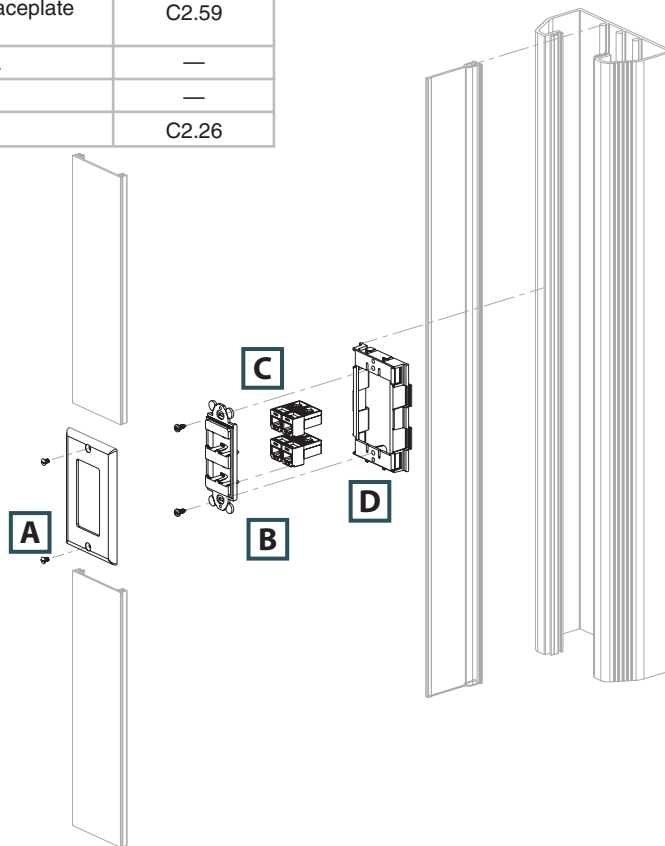

A.
System
Overview

B1.
Cable Ties

B2.
Cable
Accessories

B3.
Stainless
Steel Ties

C1.
Wiring
Duct

C2.
Surface
Raceway

C3.
Abrasion
Protection

C4.
Cable
Management

D1.
Terminals

D2.
Power
Connectors

D3.
Grounding
Connectors

E1.
Labeling
Systems

E2.
Labels

E3.
Pre-Printed
& Write-On
Markers

E4.
Permanent
Identification

E5.
Lockout/
Tagout/
& Safety
Solutions

F.
Index

A.
System
Overview

UL **SF** **PAN-WAY® TG-70 Surface Raceway System**
SA LISTED

B1.
Cable Ties

- UL and CSA rated 600 V; meets UL 5A and CSA C22.2 No. 62.1-03 standards; FT4 rated
- Large cable capacity with aesthetically pleasing design
- Tamper resistant

- Compatible with NEMA standard faceplates or *PAN-WAY®* Classic Series Snap-On Faceplates
- Transitions to *PANDUIT* T-45 and LD profile raceway
- Supplied with pre-punched mounting holes

B2.
Cable
Accessories

B3.
Stainless
Steel Ties

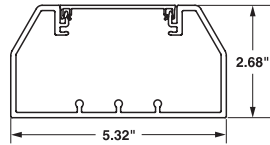

TG-70
Internal Area = 10.85 Sq. In.

C1.
Wiring
Duct



TG70

| Part Number | Part Description | Raceway Size | Color‡ | Length (Ft.) | Std. Ctn. Qty. |
|---|---|-------------------------------------|-----------|--------------|----------------|
| TG-70 Raceway Base and Cover — PACKAGED TOGETHER | | | | | |
| TG70IW8 | TG-70 raceway base in 8' and 10' lengths. Supplied with pre-punched mounting holes. | 5.32" x 2.68" (135.0mm x 68.0mm) | Off White | 8 | 32 |
| TG70IW10 | | | | 10 | 40 |

C2.
Surface
Raceway

C3.
Abrasion
Protection



T70C

| T-70/TG-70/Twin-70 Raceway Cover | | | | | |
|---|--|---|-----------|----|-----|
| T70CIW8 | T-70, TG-70, or Twin-70 raceway cover in 8' and 10' lengths. | — | Off White | 8 | 96 |
| T70CIW10 | | | | 10 | 120 |

C4.
Cable
Management



TGDW

| TG Raceway Divider Wall | | | | | |
|--------------------------------|---|---|------|----|----|
| TGDW8 | TG raceway divider wall. Snaps onto rails in TG raceway base to create separate channels. Must use wire retainers to ensure channel separation per UL/CSA. Available in 8' and 10' lengths. | — | Gray | 8 | 64 |
| TGDW10 | | | | 10 | 80 |

‡For other colors replace IW (Off White) with EI (Electric Ivory).
Order number of feet required in multiples of standard carton quantity.

D1.
Terminals

D2.
Power
Connectors

D3.
Grounding
Connectors

E1.
Labeling
Systems

E2.
Labels

E3.
Pre-Printed
& Write-On
Markers

E4.
Permanent
Identification

E5.
Lockout/
Tagout
& Safety
Solutions

F.
Index

UL **SP** **PAN-WAY® TG-70 Raceway Fittings**

• TG-70 fittings are designed to exceed the TIA/EIA-568-B and 569-B required minimum bend radius for high performance copper and fiber optic cabling systems



| Part Number | Part Description | Color‡ | Std. Pkg. Qty. | Std. Ctn. Qty. |
|-------------------|--|-----------|----------------|----------------|
| T70CCIW-X | Cover coupler fitting. Used to join sections of cover together. | Off White | 10 | 100 |
| TG70BCIW-X | Base coupler fitting. Each piece includes two base coupler halves for joining sections of TG-70 base together. | Off White | 10 | — |
| TGRAIW | Right angle fitting. Used to join sections of TG raceway at 90° flat junctions. | Off White | 1 | 10 |
| TGICIW | Inside corner fitting. Used to join sections of TG raceway at inside corners. Fittings adjust from 85° to 135° to adapt to non-square corners. | Off White | 1 | — |
| TGSICIW | Inside corner fitting – non-adjustable. Used to join sections of TG raceway at inside corners. | Off White | 1 | 10 |
| TGOCIW | Outside corner fitting. Used to join sections of TG raceway at outside corners. Fittings adjust from 85° to 135° to adapt to non-square corners. | Off White | 1 | — |
| TGSOCIW | Outside corner fitting – non-adjustable. Used to join sections of TG raceway at inside corners. | Off White | 1 | 10 |
| TGTIW | Tee fitting. Used to join sections of TG raceway at tee intersections. | Off White | 1 | 5 |
| TGTD | Tee divider insert. Mounts inside TGT tee fitting to maintain channel separation in TG raceway at tee intersections. | Gray | 1 | 5 |
| TGECIW | End cap. Used to terminate or allow entry to TG raceway. Two knockouts each for .50" (12.7mm) and 1" (25.4mm) conduit. | Off White | 1 | 10 |
| TGEEIW | Entrance end fitting. Accepts large conduit, (up to 2") in line <i>or</i> at a right angle. Maintains a 40mm bend radius with a removable insert and channel separation. | Off White | 1 | 10 |
| TGTRIW | Transition fitting from TG to T-45. Provides a tee transition from TG raceway to T-45 and LD series size 5 and 10. Use with RF5X3 reducer fitting to transition to LD series size 3. | Off White | 1 | 10 |
| TGBFIW | Backfeed fitting. Features breakouts to enter through the bottom of the fitting and maintains bend radius control with a removable, bend radius insert and channel separation. | Off White | 1 | 10 |
| TGBFI | Backfeed fitting insert. Removable and maintains bend radius control. | Off White | 1 | 10 |

‡For other colors replace IW (Off White) with EI (Electric Ivory).

A. System Overview

B1. Cable Ties

B2. Cable Accessories

B3. Stainless Steel Ties

C1. Wiring Duct

C2. Surface Raceway

C3. Abrasion Protection

C4. Cable Management

D1. Terminals

D2. Power Connectors

D3. Grounding Connectors

E1. Labeling Systems

E2. Labels

E3. Pre-Printed & Write-On Markers

E4. Permanent Identification

E5. Lockout/Tagout & Safety Solutions

F. Index

A. System Overview



PAN-WAY® TG-70 Raceway Accessories

B1. Cable Ties

- TG-70 accessories consist of device mounting brackets, standard faceplate brackets for data, wire retainers and fiber spool brackets; the three-sided hanging box is used to mount NEMA standard single gang outlet and communications devices

B2. Cable Accessories

B3. Stainless Steel Ties

C1. Wiring Duct

C2. Surface Raceway

C3. Abrasion Protection

C4. Cable Management

D1. Terminals

D2. Power Connectors

D3. Grounding Connectors

E1. Labeling Systems

E2. Labels

E3. Pre-Printed & Write-On Markers

E4. Permanent Identification

E5. Lockout/Tagout & Safety Solutions

F. Index

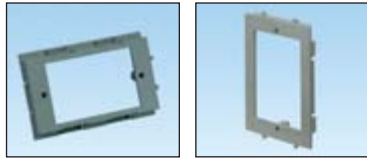

T70DB-X

T70SDB-X

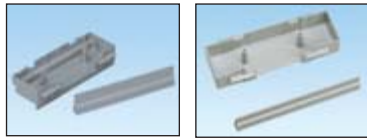

TG70HB3-X

TG70HB3GFCI-X



TG70WR-X

TGFSB

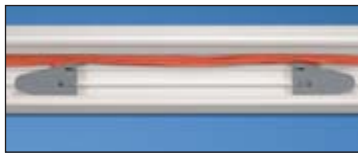

TGFSB installed in TG-70 raceway

| Part Number | Part Description | Color | Std. Pkg. Qty. | Std. Ctn. Qty. |
|----------------------|---|-------|----------------|----------------|
| T70DB-X | Device mounting bracket. Used to mount NEMA standard single gang electrical outlets and communication devices with either screw-on or snap-on single gang faceplates. Can be used with T-70, Twin-70, and TG-70 raceway. | Gray | 10 | — |
| T70SDB-X | Standard faceplate bracket. Used to mount NEMA standard 70mm single gang screw-on faceplates. Can be used with T-70, Twin-70, TG-70 raceway and PAN-POLE™ Communication Pole. | Gray | 10 | — |
| TG70HB3-X | 3-sided hanging box. Mounts standard electrical outlets or communication devices with either NEMA standard single gang screw-on or PANDUIT snap-on faceplates. When used with TGDW divider wall, box separates and fully encloses device to provide cabling separation. | Gray | 10 | — |
| TG70HB3GFCI-X | GFCI 3-sided hanging box. Accepts single gang U.S. GFCI (ground fault circuit interrupter) standard electrical devices. Provides increased internal area for connections and excess wire. | Gray | 10 | — |
| TG70WR-X | Wire retainer. Holds wires in place during installation. | Gray | 10 | 100 |
| TGFSB | Fiber spool bracket. Each piece consists of two halves that snap into base of TG raceway. Provides method to contain one meter or more of fiber slack and acts as a strain relief while maintaining a minimum 32mm bend radius. Bracket separation can be adjusted to fit the length of slack required. | Gray | 1 | 10 |

Cable Fill Capacities for TG-70 Raceway

This information is to be used as a guide in selecting the proper size raceway. The maximum amounts may vary according to the cable installation methods, straightness of cables, etc.

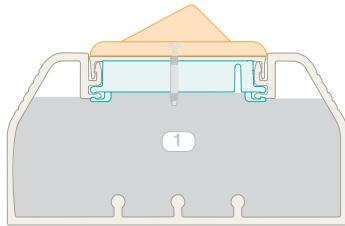

A = 10.09 in.²

Cable fill #1: With data only using screw-on faceplates and devices.

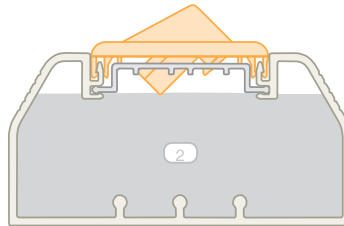

A = 10.68 in.²

Cable fill #2: With data only using snap-on faceplates and wire retainer.

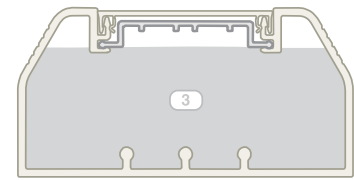

A = 10.85 in.²

Cable fill #3: With wire retainer.

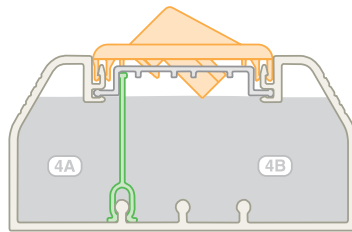

A = 3.16 in.²

A = 7.20 in.²

Cable fill #4: Divided (see 5A and 5B for power and data applications).

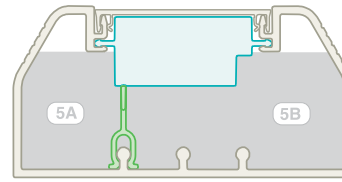

A = 3.08 in.²

A = 5.58 in.²

Cable fill #5: With Power and data using snap-on faceplates and 3-sided power box.

| Raceway Type and Configuration | Fill Area (in. ²) | Electrical Cables | | | Data Grade Cables | | Data Grade Cables | | Audio/Video | | Fiber Optic Cable | |
|--|-------------------------------|-------------------|--------|--------|-------------------|-------|-------------------|-------|--------------|-------|-------------------|-------|
| | | 14 AWG | 12 AWG | 10 AWG | 24 AWG/UTP CM | | 24 AWG/UTP CM | | RG6 | | 2 Strand | |
| | | THHN/T90 | | | Cat. 6 | | Cat. 6A | | | | | |
| | | 0.111 | 0.130 | 0.164 | DIA. = 0.250 | | DIA. = 0.330 | | DIA. = 0.275 | | DIA. = 0.175 | |
| | | FILL | | | FILL | | FILL | | FILL | | FILL | |
| | | MAX | MAX | MAX | SPEC | MAX | SPEC | MAX | SPEC | MAX | SPEC | MAX |
| (UL Temp Rise Test) | | | (40%) | (60%) | (40%) | (60%) | (40%) | (60%) | (40%) | (60%) | (40%) | (60%) |
| 1. TG70: Data only using screw-on faceplates and devices. | 10.09 | — | — | — | 82 | 123 | 47 | 70 | 67 | 101 | 167 | 251 |
| 2. TG70: Data only using snap-on faceplates and wire retainer. | 10.68 | — | — | — | 87 | 130 | 49 | 74 | 71 | 107 | 177 | 266 |
| 3. TG70: Wire retainer without devices. | 10.85 | 40 | 40 | 38 | 88 | 132 | 50 | 76 | 73 | 109 | 180 | 270 |
| 4A. TG70: Divided power and data (A). | 3.16 | 28 | 28 | 26 | — | — | — | — | — | — | — | — |
| 4B. TG70: Divided power and data (B). | 7.2 | — | — | — | 58 | 88 | 33 | 50 | 48 | 72 | 119 | 179 |
| 5A. TG70: Power and data using snap-on faceplates and 3-sided power box (A). | 3.08 | 28 | 28 | 26 | — | — | — | — | — | — | — | — |
| 5B. TG70: Power and data using snap-on faceplates and 3-sided power box (B). | 5.58 | — | — | — | 45 | 68 | 26 | 39 | 37 | 56 | 92 | 139 |

AWG dimensions represent typical outer cable diameter in inches.

A.
System
Overview

B1.
Cable Ties

B2.
Cable
Accessories

B3.
Stainless
Steel Ties

C1.
Wiring
Duct

C2.
Surface
Raceway

C3.
Abrasion
Protection

C4.
Cable
Management

D1.
Terminals

D2.
Power
Connectors

D3.
Grounding
Connectors

E1.
Labeling
Systems

E2.
Labels

E3.
Pre-Printed
& Write-On
Markers

E4.
Permanent
Identification

E5.
Lockout/
Tagout/
& Safety
Solutions

F.
Index

NOTES

PAN-WAY® T-70 AND TWIN-70 NON-METALLIC SURFACE RACEWAY

PAN-WAY® T-70 and Twin-70 Non-Metallic Surface Raceways are multi-channel raceways which provide solutions for routing copper, fiber optic, and/or power cabling along fixed perimeter walls. T-70 features the *WORKSTATION OUTLET CENTER™* Offset Box which provides an offset solution to maximize channel capacity and outlet density. Twin-70 offers two totally independent channels maintained throughout the system for independent access to power, copper, and fiber optic cabling.

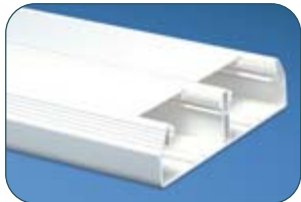

- Aesthetically pleasing
- Lightweight
- Tamper resistant
- Fittings maintain 1 inch bend radius control
- T-70 utilizes a single channel with snap-in divider wall to provide multi-channel capability
- Twin-70 utilizes two independent channels and covers to provide multi-channel capability

The T-70 and Twin-70 raceway systems consist of raceway base and cover, fittings, termination hardware and accessories. PAN-WAY® T-70 and Twin-70 Raceway can mount NEMA standard screw-on faceplates or superior PAN-WAY® Snap-On Faceplates directly to the channel. Fittings for T-70 and Twin-70 are available to transition to T-70, Twin-70, T-45 and LD raceways.

A.
System
Overview

B1.
Cable Ties

B2.
Cable
Accessories

B3.
Stainless
Steel Ties

C1.
Wiring
Duct

C2.
Surface
Raceway

C3.
Abrasion
Protection

C4.
Cable
Management

D1.
Terminals

D2.
Power
Connectors

D3.
Grounding
Connectors

E1.
Labeling
Systems

E2.
Labels

E3.
Pre-Printed
& Write-On
Markers

E4.
Permanent
Identification

E5.
Lockout/
Tagout
& Safety
Solutions

F.
Index

A.
System
Overview

T-70 Raceway Roadmap

B1.
Cable Ties

B2.
Cable
Accessories

B3.
Stainless
Steel Ties

C1.
Wiring
Duct

C2.
Surface
Raceway

C3.
Abrasion
Protection

C4.
Cable
Management

D1.
Terminals

D2.
Power
Connectors

D3.
Grounding
Connectors

E1.
Labeling
Systems

E2.
Labels

E3.
Pre-Printed
& Write-On
Markers

E4.
Permanent
Identification

E5.
Lockout/
Tagout/
& Safety
Solutions

F.
Index

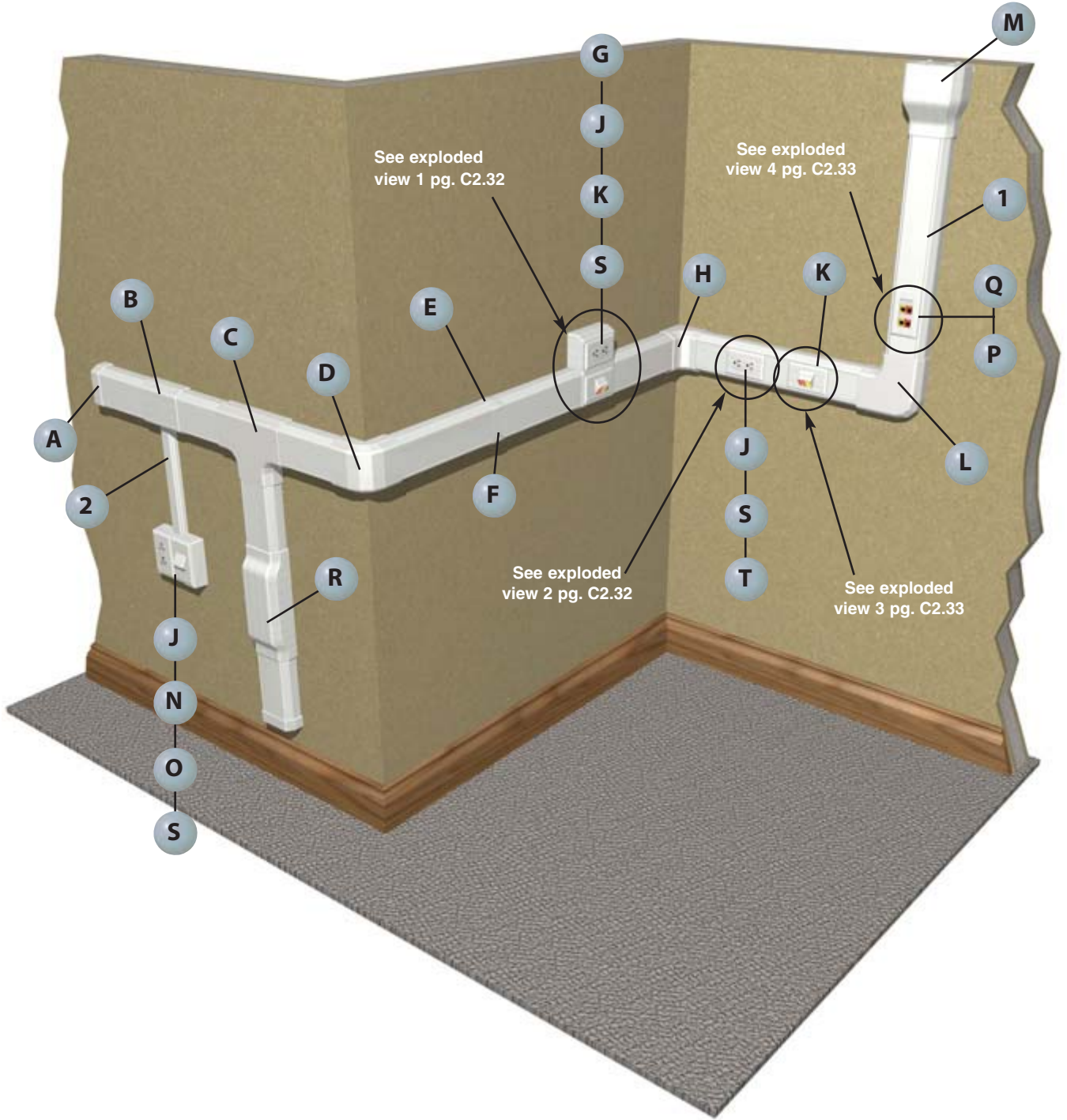

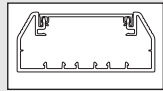

1 T70B** , T70C** – T-70 Base and Cover (page C2.36)

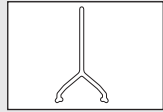

1 T70DW – T-70 Divider Wall (page C2.36)

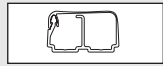

2 LD2P10** – LD2P10 Raceway (page C2.75)

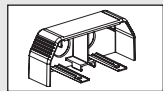

A T70EC** – T-70 End Cap Fitting (page C2.37)

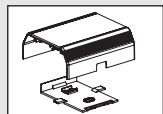

B T70TR** – T-70 Transition Fitting (page C2.37)

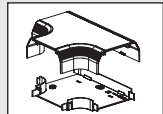

C T70T** – T-70 Tee Fitting
T70TD – T-70 Tee Divider (page C2.37)

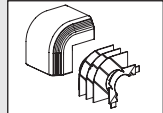
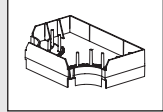

D T70OC** – T-70 Outside Corner Fitting (page C2.37)

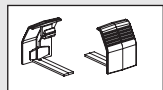

E T70BC** – T-70 Base Coupler Fitting (page C2.36)

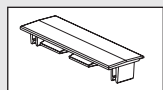

F T70CC** – T-70 Cover Coupler Fitting (page C2.36)

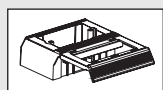

G T70WC2** – T-70 *WORKSTATION OUTLET CENTER™* Offset Box for Snap-On Faceplates (page C2.37)

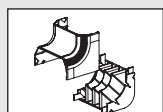

H T70IC** – T-70 Inside Corner Fitting (page C2.37)

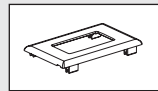

J T70PG** – Single Gang Rectangular Electrical/Communication Snap-On Faceplate (page C2.53)

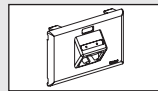

K UIT70FH2** – *ULTIMATE ID®* Sloped Horizontal Snap-On Faceplate

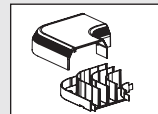

L T70RA** – T-70 Right Angle Fitting (page C2.36)

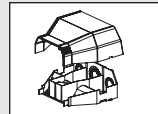

M T70EE** – T-70 Entrance End Fitting (page C2.37)

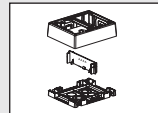

N JBP2FS** – *FAST-SNAP™* Double Gang Power Rated Surface Mount Outlet Box (page C2.52)



O T70FV2** – Vertical Sloped Communication Snap-On Faceplate (page C2.52)

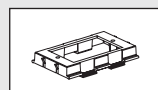

P T70DB-X – T-70 Device Bracket (page C2.40)

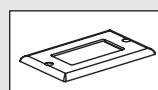

Q CPG** – Single Gang Rectangular Screw-On Faceplate (page C2.59)

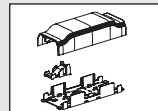

R T70BF** – T-70 Backfeed Fitting (page C2.37)

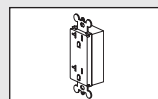

S ERU20** – 20 A Rectangular Electrical Outlet (page C2.60)

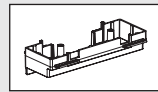

T T70HB3-X – 3-Sided Hanging Box (page C2.40)

A. System Overview

B1. Cable Ties

B2. Cable Accessories

B3. Stainless Steel Ties

C1. Wiring Duct

C2. Surface Raceway

C3. Abrasion Protection

C4. Cable Management

D1. Terminals

D2. Power Connectors

D3. Grounding Connectors

E1. Labeling Systems

E2. Labels

E3. Pre-Printed & Write-On Markers

E4. Permanent Identification

E5. Lockout/Tagout & Safety Solutions

F. Index

A.
System
Overview

T-70 Configurations

B1.
Cable Ties

Exploded View 1

B2.
Cable
Accessories

B3.
Stainless
Steel Ties

C1.
Wiring
Duct

C2.
Surface
Raceway

C3.
Abrasion
Protection

C4.
Cable
Management

D1.
Terminals

D2.
Power
Connectors

D3.
Grounding
Connectors

E1.
Labeling
Systems

E2.
Labels

E3.
Pre-Printed
& Write-On
Markers

E4.
Permanent
Identification

E5.
Lockout/
Tagout/
& Safety
Solutions

F.
Index

| | Components Required | See page |
|----|--|----------|
| A. | T70WC2 = T-70 <i>WORKSTATION OUTLET CENTER™</i> Offset Box for snap-on faceplates. | C2.37 |
| B. | ERU20 = 20 A rectangular electrical outlet (screws included). | C2.60 |
| C. | MINI-COM® Modules. | — |
| D. | T70PG = Single gang rectangular electrical/communication snap-on faceplate. | C2.53 |
| E. | UIT70FH2 = <i>ULTIMATE ID®</i> Sloped Horizontal Snap-On Faceplate – 2-port. | — |

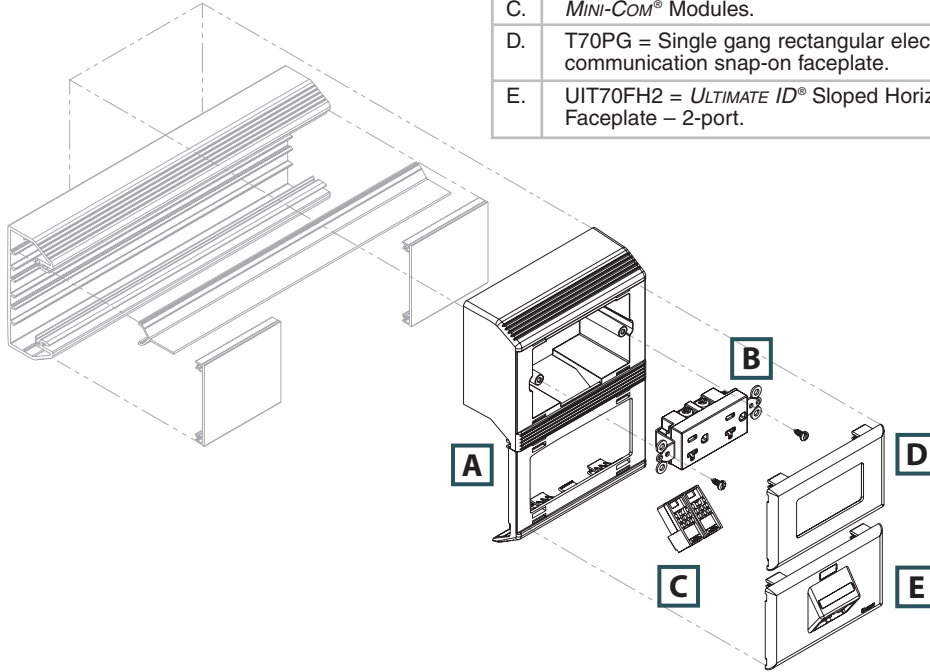

Exploded View 2

| | Components Required | See page |
|----|---|----------|
| A. | T70PG = Single gang rectangular electrical/communication snap-on faceplate. | C2.53 |
| B. | ERU20 = 20 A rectangular electrical outlet (screws included). | C2.60 |
| C. | T70HB3-X = 3-Sided hanging box. | C2.40 |

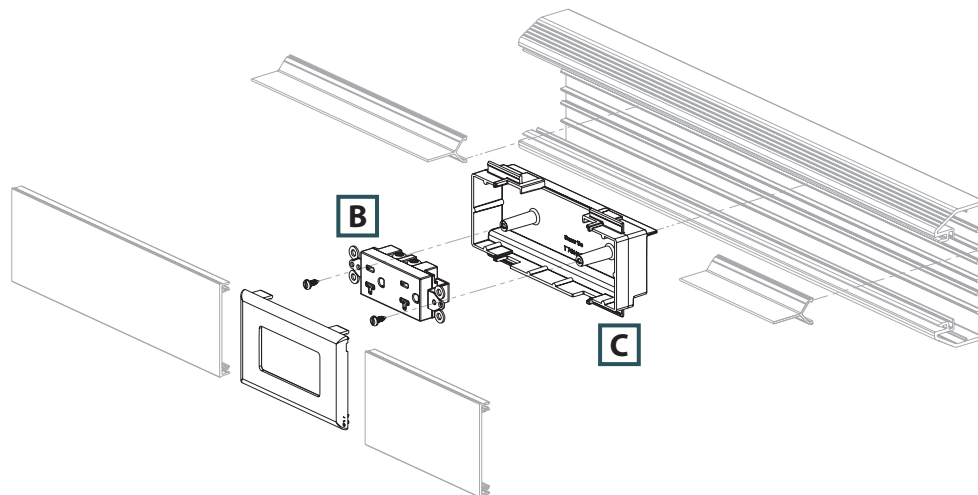

T-70 Configurations (continued)

Exploded View 3

| | Components Required | See page |
|----|---|----------|
| A. | UIT70FH2 = <i>ULTIMATE ID</i> ® Sloped Horizontal Snap-On Faceplate – 2-port. | — |
| B. | <i>MINI-COM</i> ® Modules. | — |

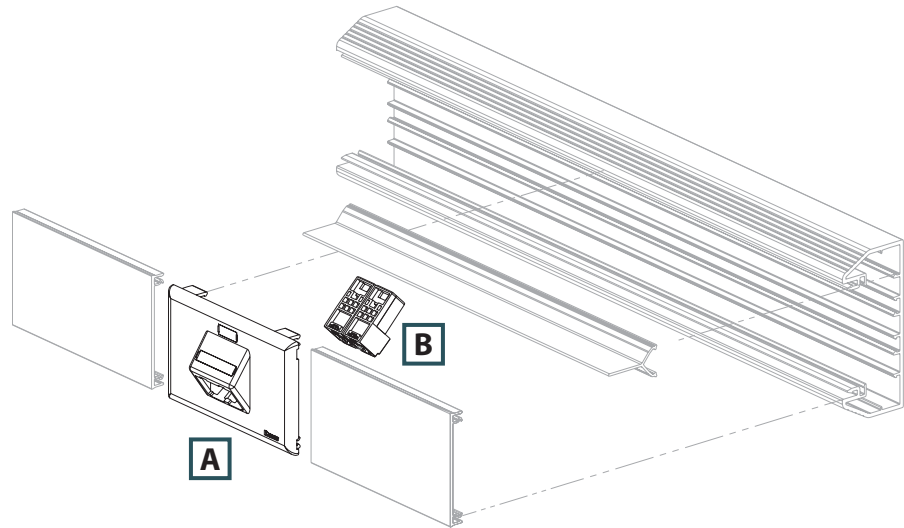

Exploded View 4

| | Components Required | See page |
|----|--|----------|
| A. | CPG = Single gang rectangular screw-on faceplates (screws included). | C2.59 |
| B. | CFP4 = <i>MINI-COM</i> ® Module Frame – 4-port. | — |
| C. | <i>MINI-COM</i> ® Modules. | — |
| D. | T70DB-X = T-70 device bracket. | C2.40 |

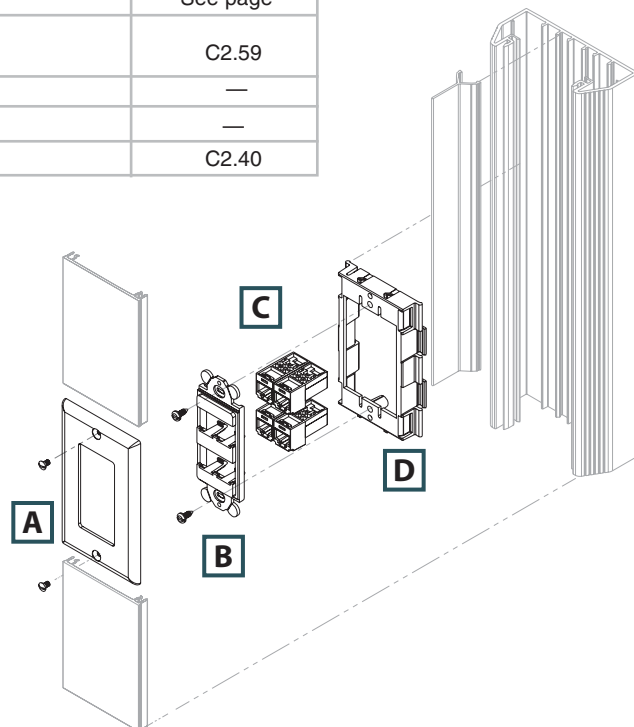

A.
System
Overview

B1.
Cable Ties

B2.
Cable
Accessories

B3.
Stainless
Steel Ties

C1.
Wiring
Duct

C2.
Surface
Raceway

C3.
Abrasion
Protection

C4.
Cable
Management

D1.
Terminals

D2.
Power
Connectors

D3.
Grounding
Connectors

E1.
Labeling
Systems

E2.
Labels

E3.
Pre-Printed
& Write-On
Markers

E4.
Permanent
Identification

E5.
Lockout/
Tagout/
& Safety
Solutions

F.
Index

A.
System
Overview

Twin-70 Raceway Roadmap

B1.
Cable Ties

B2.
Cable
Accessories

B3.
Stainless
Steel Ties

C1.
Wiring
Duct

C2.
Surface
Raceway

C3.
Abrasion
Protection

C4.
Cable
Management

D1.
Terminals

D2.
Power
Connectors

D3.
Grounding
Connectors

E1.
Labeling
Systems

E2.
Labels

E3.
Pre-Printed
& Write-On
Markers

E4.
Permanent
Identification

E5.
Lockout/
Tagout/
& Safety
Solutions

F.
Index

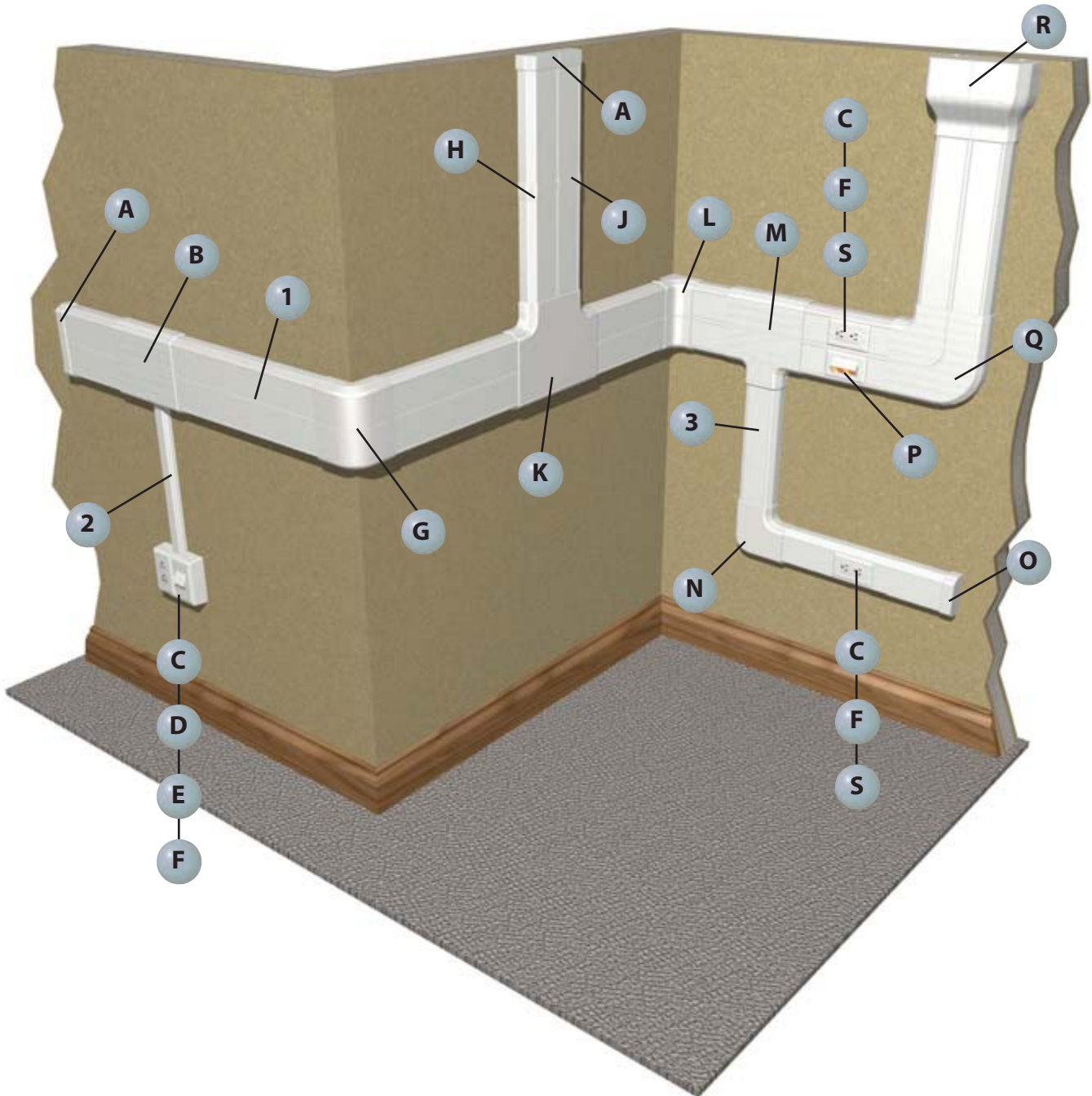

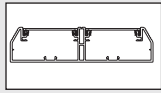

1 T702B**, T70C** – T702 Raceway Base and Cover (page C2.38)

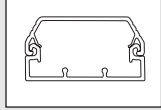

2 T45B**, T45C** – T-45 Raceway Base and Cover (page C2.48)

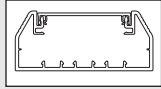

3 T70B**, T70C** – T-70 Raceway Base and Cover (page C2.36)

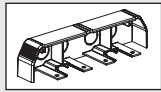

A T702EC** – Twin-70 End Cap Fitting (page C2.39)

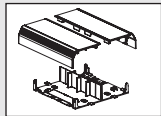

B T702TRL** – Twin-70 Transition Fitting (page C2.39)

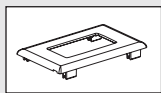

C T70PG** – Single Gang Rectangular Electrical/Communication Snap-On Faceplate (page C2.53)



D T70FV2** – Vertical Sloped Communication Snap-On Faceplate (page C2.52)

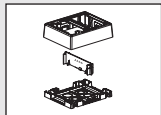

E JBP2FS** – FAST-SNAP™ Double Gang Power Rated Surface Mount Outlet Box (page C2.52)

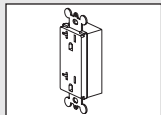

F ERU20** – 20 A Rectangular Electrical Outlet (page C2.60)

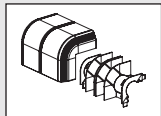

G T702OC** – Twin-70 Outside Corner Fitting (page C2.39)

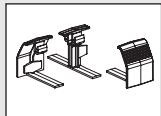

H T702BC** – Twin-70 Base Coupler Fitting (page C2.39)

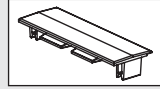

J T70CC** – T-70 Cover Coupler Fitting (page C2.39)

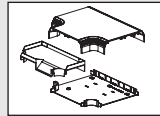

K T702T** – Twin-70 Tee Fitting (page C2.39)

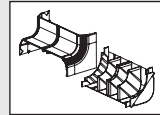

L T702IC** – Twin-70 Inside Corner Fitting (page C2.39)

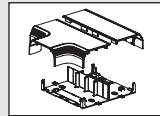

M T702TR** – Twin-70 Transition Fitting (page C2.39)

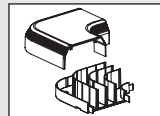

N T70RA** – T-70 Right Angle Fitting (page C2.39)

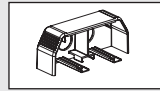

O T70EC** – T-70 End Cap Fitting (page C2.37)

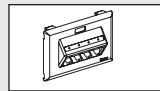

P UIT70FH4** – ULTIMATE ID® Sloped Horizontal Snap-On Faceplate

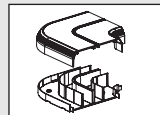

Q T702RA** – Twin-70 Right Angle Fitting (page C2.39)

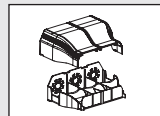

R T702EE** – Twin-70 Entrance End Fitting (page C2.39)

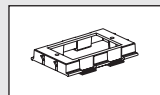

S T70DB-X** – T-70 Device Mounting Bracket (page C2.40)

A. System Overview

B1. Cable Ties

B2. Cable Accessories

B3. Stainless Steel Ties

C1. Wiring Duct

C2. Surface Raceway

C3. Abrasion Protection

C4. Cable Management

D1. Terminals

D2. Power Connectors

D3. Grounding Connectors

E1. Labeling Systems

E2. Labels

E3. Pre-Printed & Write-On Markers

E4. Permanent Identification

E5. Lockout/Tagout & Safety Solutions

F. Index

A. System Overview



PAN-WAY® T-70 Surface Raceway System

B1. Cable Ties

- UL and CSA rated 600 V; meets UL 5A and CSA C22.2 No. 62.1-03 standards; FT4 rated
- Large cable capacity with aesthetically pleasing design
- Tamper resistant

- Compatible with NEMA standard 70mm faceplates or PAN-WAY® Classic Series Snap-On Faceplates
- Transitions to PANDUIT T-45 and LD profile raceway
- Supplied with pre-punched mounting holes

B2. Cable Accessories

B3. Stainless Steel Ties

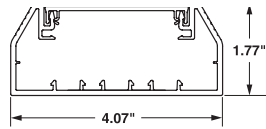

T-70
Internal Area = 5.15 Sq. In.



T70B



T70C

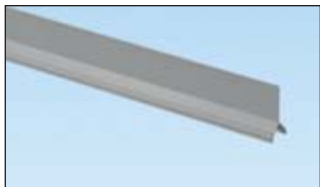

T70DW

| Part Number | Part Description | Raceway Size | Color‡ | Length (Ft.) | Std. Ctn. Qty. |
|-------------|------------------|--------------|--------|--------------|----------------|
|-------------|------------------|--------------|--------|--------------|----------------|

T-70 Raceway Base

| | | | | | |
|-----------------|--|-------------------------------------|-----------|----|----|
| T70BIW8 | T-70 raceway base in 8' and 10' lengths. Supplied with pre-punched mounting holes. | 4.07" x 1.77" (103.3mm x 45.0mm) | Off White | 8 | 48 |
| T70BIW10 | | | | 10 | 60 |

T-70/TG-70/Twin-70 Raceway Cover

| | | | | | |
|-----------------|--|---|-----------|----|-----|
| T70CIW8 | T-70, TG-70, or Twin-70 raceway cover in 8' and 10' lengths. | — | Off White | 8 | 96 |
| T70CIW10 | | | | 10 | 120 |

T-70/Twin-70 Raceway Divider Wall

| | | | | | |
|----------------|---|---|------|----|-----|
| T70DW8 | T-70/Twin-70 raceway divider wall. Snaps onto rails in T-70/Twin-70 raceway base to create separate channels. Must use wire retainers to ensure channel separation per UL/CSA. Available in 8' and 10' lengths. | — | Gray | 8 | 96 |
| T70DW10 | | | | 10 | 120 |

‡For other colors replace IW (Off White) with EI (Electric Ivory), WH (White), or IG (International Gray in 8' lengths ONLY). Order raceway base and cover separately.
Order number of feet required in multiples of standard carton quantity.

D1. Terminals

D2. Power Connectors

D3. Grounding Connectors



PAN-WAY® T-70 Raceway Fittings

E1. Labeling Systems

- T-70 fittings are designed to maintain the TIA/EIA-568-B and 569-B required minimum bend radius for high performance copper and fiber optic cabling systems

E2. Labels



T70CC



T70BC

E3. Pre-Printed & Write-On Markers

E4. Permanent Identification



T70RA

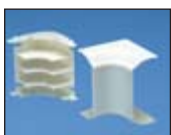

T70IC

E5. Lockout/Tagout & Safety Solutions

F. Index

| Part Number | Part Description | Color‡ | Std. Pkg. Qty. | Std. Ctn. Qty. |
|------------------|---|-----------|----------------|----------------|
| T70CCIW-X | Cover coupler fitting. Used to join sections of cover together. | Off White | 10 | 100 |
| T70BCIW-X | Base coupler fitting. Used to join sections of T-70 raceway base together. | Off White | 10 | 0 |
| T70RAIW | Right angle fitting. Used to join sections of T-70 raceway at right angles. | Off White | 1 | 10 |
| T70ICIW | Inside corner fitting. Used to join sections of T-70 raceway at inside corners. | Off White | 1 | 10 |

‡For other colors replace IW (Off White) with EI (Electric Ivory), IG (International Gray), or WH (White).

 **PAN-WAY® T-70 Raceway Fittings (continued)**



T70OC

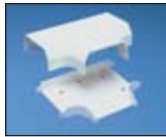

T70T



T70TD



T70EC



T70EE



**T70TR
T70TRC**



T70TRI



T70WM40TR



T70BF



T70BFI



T70WC



T70WC2

| Part Number | Part Description | Color‡ | Std. Pkg. Qty. | Std. Ctn. Qty. |
|--------------------|---|-----------|----------------|----------------|
| T70OCIW | Outside corner fitting. Used to join sections of T-70 raceway at outside corners. | Off White | 1 | 10 |
| T70TIW | Tee fitting. Used to join sections of T-70 raceway at tee intersections. | Off White | 1 | 10 |
| T70TD | T-70 tee fitting divider. Separates power and data within tee fitting. Replaces T70TDB, T70TDC, and T70TDT. | Gray | 1 | 10 |
| T70ECIW | End cap fitting. Used to terminate or allow entry to T-70 raceway with conduit breakouts of 1/2". | Off White | 1 | 10 |
| T70EEIW | Entrance end fitting. Conduit breakouts of 1/2", 3/4", 1" and 1 1/4" which allows entry from ceiling or wall. | Off White | 1 | 10 |
| T70TRIW | Transition fitting. Used to transition to any LD profile or T-45 raceway while maintaining channel separation. Fitting includes bend radius insert. | Off White | 1 | 10 |
| T70TRCIW | Transition fitting cover. Used to transition to any LD profile or T-45 raceway. | Off White | 1 | 10 |
| T70TRI | Divided insert for T-70 to LD2P10. Maintains channel separation within T70TR fitting. | Gray | 1 | 10 |
| T70WM40TRIW | WIREMOLD* 4000 to T-70 transition fitting. In-line transition fitting from WIREMOLD* 4000 to T-70 raceway. | Off White | 1 | 10 |
| T70BFIW | Backfeed fitting. Allows cable entry through the back of the T-70 raceway | Off White | 1 | 10 |
| T70BFI | Backfeed fitting insert. Bend radius insert to be used with T70BF. | Gray | 1 | 10 |
| T70WC1W | WORKSTATION OUTLET CENTER™ Offset Box for screw-on faceplates. Two-piece box and bracket accept any NEMA standard screw-on faceplate. | Off White | 1 | 10 |
| T70WC2IW | WORKSTATION OUTLET CENTER™ Offset Box for PAN-WAY® Snap-On Faceplates. Two-piece box and bracket accept any standard electrical outlet. Accepts any PAN-WAY® Snap-On Electrical/Communication Faceplates. | Off White | 1 | 10 |

‡For other colors replace IW (Off White) with EI (Electric Ivory), IG (International Gray), or WH (White).
*WIREMOLD is a registered trademark of the Wiremold Co.

A.
System
Overview

B1.
Cable Ties

B2.
Cable
Accessories

B3.
Stainless
Steel Ties

C1.
Wiring
Duct

C2.
Surface
Raceway

C3.
Abrasion
Protection

C4.
Cable
Management

D1.
Terminals

D2.
Power
Connectors

D3.
Grounding
Connectors

E1.
Labeling
Systems

E2.
Labels

E3.
Pre-Printed
& Write-On
Markers

E4.
Permanent
Identification

E5.
Lockout/
Tagout
& Safety
Solutions

F.
Index

A. System Overview



PAN-WAY® Twin-70 Surface Raceway System

B1. Cable Ties

- UL and CSA rated 600 V; meets UL 5A and CSA C22.2 No. 62.1-03 standards; FT4 rated
- Separate channels allow independent access to power and communication cabling throughout the entire system
- Transitions to PANDUIT T-70, T-45, and LD profile raceway

- Compatible with NEMA standard 70mm faceplates or PAN-WAY® Classic Series Snap-On Faceplates
- Tamper resistant
- Supplied with pre-punched mounting holes

B2. Cable Accessories

B3. Stainless Steel Ties

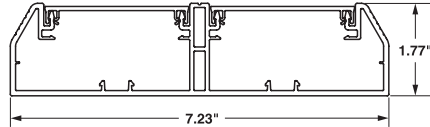

TWIN-70
Left Internal Area = 4.59 Sq. In.
Right Internal Area = 4.59 Sq. In.

C1. Wiring Duct



T702B

C2. Surface Raceway

C3. Abrasion Protection



T70C

C4. Cable Management

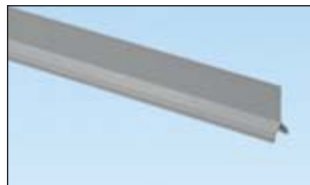

T70DW

D1. Terminals

D2. Power Connectors

D3. Grounding Connectors

E1. Labeling Systems

E2. Labels

E3. Pre-Printed & Write-On Markers

E4. Permanent Identification

E5. Lockout/Tagout & Safety Solutions

F. Index

| Part Number | Part Description | Raceway Size | Color‡ | Length (Ft.) | Std. Ctn. Qty. |
|--|---|-------------------------------------|-----------|--------------|----------------|
| Twin-70 Raceway Base | | | | | |
| T702BIW8 | Twin-70 raceway base in 8' and 10' lengths. Supplied with pre-punched mounting holes. | 7.23" x 1.77" (184.0mm x 45.0mm) | Off White | 8 | 24 |
| T702BIW10 | | | | 10 | 30 |
| T-70/TG-70/Twin-70 Raceway Cover | | | | | |
| T70CIW8 | T-70, TG-70, or Twin-70 raceway cover in 8' and 10' lengths. | — | Off White | 8 | 96 |
| T70CIW10 | | | | 10 | 120 |
| T-70/Twin-70 Raceway Divider Wall | | | | | |
| T70DW8 | T-70/Twin-70 raceway divider wall. Snaps onto rails in T-70/Twin-70 raceway base to create separate channels. Must use wire retainers to ensure channel separation per UL/CSA. Available in 8' and 10' lengths. | — | Gray | 8 | 96 |
| T70DW10 | | | | 10 | 120 |

‡For other colors replace IW (Off White) with EI (Electric Ivory) or WH (White).
2' of cover needed for every 1' of Twin-70 base.
 Order number of feet required in multiples of standard carton quantity.



PAN-WAY® Twin-70 Raceway Fittings

- Twin-70 fittings are designed to maintain the TIA/EIA-568-B and 569-B required minimum bend radius for high performance copper and fiber optic cabling systems

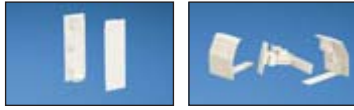

T70CC

T702BC



T702RA

T702IC



T702OC

T702T



T702EC

T702EE



T702TR

T702TRL



T702TRI

| Part Number | Part Description | Color‡ | Std. Pkg. Qty. | Std. Ctn. Qty. |
|-------------------|---|-----------|----------------|----------------|
| T70CCIW-X | Cover coupler fitting. Used to join sections of cover together. | Off White | 10 | 100 |
| T702BCIW-X | Base coupler fitting. Used for joining sections of Twin-70 base together. | Off White | 10 | — |
| T702RAIW | Right angle fitting. Used to join sections of Twin-70 raceway at 90° flat junctions. | Off White | 1 | 10 |
| T702ICIW | Inside corner fitting. Used to join sections of Twin-70 raceway at inside corners. | Off White | 1 | 10 |
| T702OCIW | Outside corner fitting. Used to join sections of Twin-70 raceway at outside corners. | Off White | 1 | 10 |
| T702TIW | Tee fitting. Used to join sections of Twin-70 raceway at tee intersections. | Off White | 1 | 5 |
| T702ECIW | End cap fitting. Conduit breakouts of 1/2" for entry into raceway channel. | Off White | 1 | 10 |
| T702EEIW | Entrance end fitting. Conduit breakouts of 1/2", 3/4", 1", 1 1/4" and 1 1/2" for entry from ceiling or wall. | Off White | 1 | 5 |
| T702TRIW | Transition fitting. Used to transition to T-70 raceway. | Off White | 1 | 5 |
| T702TRLIW | Transition fitting. Used to transition to any LD profile or T-45 raceway. | Off White | 1 | 5 |
| T702TRI | Transition divider insert for Twin-70 to T-70 or Twin-70 to LD profile. Maintains channel separation within T702TR or T702TRL fittings. | Gray | 1 | 10 |

‡For other colors replace IW (Off White) with EI (Electric Ivory) or WH (White). T702TRI available in Gray only.

A.
System
Overview

B1.
Cable Ties

B2.
Cable
Accessories

B3.
Stainless
Steel Ties

C1.
Wiring
Duct

C2.
Surface
Raceway

C3.
Abrasion
Protection

C4.
Cable
Management

D1.
Terminals

D2.
Power
Connectors

D3.
Grounding
Connectors

E1.
Labeling
Systems

E2.
Labels

E3.
Pre-Printed
& Write-On
Markers

E4.
Permanent
Identification

E5.
Lockout/
Tagout
& Safety
Solutions

F.
Index

A. System Overview



PAN-WAY® T-70 and Twin-70 Raceway Accessories

B1. Cable Ties

- T-70 and Twin-70 raceway accessories consist of device mounting brackets, snap-on device brackets, hanging boxes and 3-sided hanging boxes used to mount NEMA standard single gang electrical outlets and or communication devices

B2. Cable Accessories



T70DB-X



T70SDB-X

B3. Stainless Steel Ties



T70HB-X



T70HB3-X

C1. Wiring Duct

C2. Surface Raceway

C3. Abrasion Protection



T70HB3GFCI-X



T70WR-X

C4. Cable Management



T70S-X

D1. Terminals

D2. Power Connectors

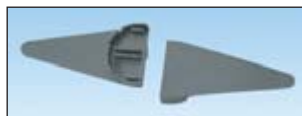

T70FSB

D3. Grounding Connectors

E1. Labeling Systems

E2. Labels

E3. Pre-Printed & Write-On Markers

E4. Permanent Identification

E5. Lockout/Tagout & Safety Solutions

F. Index

| Part Number | Part Description | Color | Std. Pkg. Qty. | Std. Ctn. Qty. |
|---------------------|--|-------|----------------|----------------|
| T70DB-X | Device mounting bracket. Used to mount NEMA standard single gang electrical outlets and communication devices with either screw-on or snap-on single gang faceplates. Can be used with T-70, Twin-70, and TG-70 raceway. | Gray | 10 | — |
| T70SDB-X | Standard faceplate bracket. Used to mount NEMA standard 70mm single gang screw-on faceplates. Can be used with T-70, Twin-70, TG-70 raceway and PAN-POLE™ Communication Pole. | Gray | 10 | — |
| T70HB-X | Hanging box. Used to mount NEMA standard single gang electrical outlets and devices with either screw-on or snap-on single gang faceplates when there are communications cables in the raceway. For use in T-70 and Twin-70 raceway only. | Gray | 10 | — |
| T70HB3-X | 3-sided hanging box. Used to mount NEMA standard single gang electrical outlets and devices with either screw-on or snap-on single gang faceplates when there are communications cables in the raceway. Box is low profile for increased channel capacity and does not require breakout removal. For use with T-70 and Twin-70 raceway only. | Gray | 10 | — |
| T70HB3GFCI-X | T70 GFCI 3-sided hanging box. Accepts single gang U.S. GFCI (ground fault circuit interrupter) standard electrical devices. Provides increased internal area for connections and excess wire. | Gray | 10 | — |
| T70WR-X | Wire retainer. Holds wires in place during installation. | Gray | 10 | 100 |
| T70S-X | Spacer plate. Used to mount the CBX4 surface mount box onto the T70DB-X or T70HB-X/T70HB3-X. | — | 10 | — |
| T70FSB | Fiber spool bracket. Each piece consists of two halves that snap into base of T-70 or Twin-70 raceway. Provides method to contain one meter or more of fiber slack and acts as a strain relief while maintaining a minimum 30mm bend radius. Bracket separation can be adjusted to fit the length of slack required. | Gray | 1 | 10 |



Use the T70FSB with T-70 or Twin-70 raceway to contain 1m or more of fiber slack while maintaining a 30mm cable bend radius. Brackets are adjustable for slack length.



Use T70S-X spacer plate for mounting the CBX4 surface mount box on T-70 or T702.

Cable Fill Capacities for T-70 Raceway

This information is to be used as a guide in selecting the proper size raceway. The maximum amounts may vary according to the cable installation methods, straightness of cables, etc.

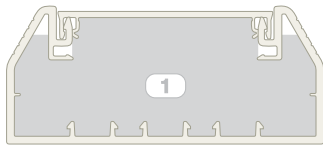

A = 5.15 in.²

Cable fill #1: Raceway with no devices.

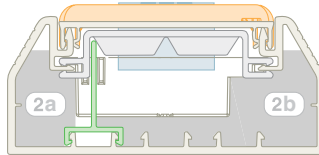

A = .86 in.² A = 1.72 in.²

Cable fill #2: Power and data using 3-sided hanging box and device bracket.

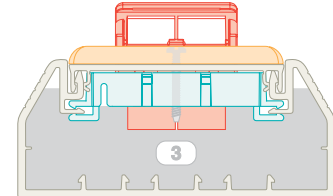

A = 3.67 in.²

Cable fill #3: Data only using vertical sloped screw-on communication faceplates.

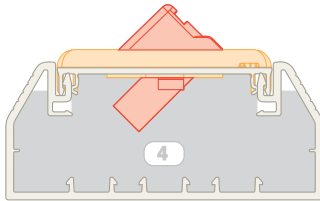

A = 4.71 in.²

Cable fill #4: Data only using horizontal sloped snap-on communication faceplates.

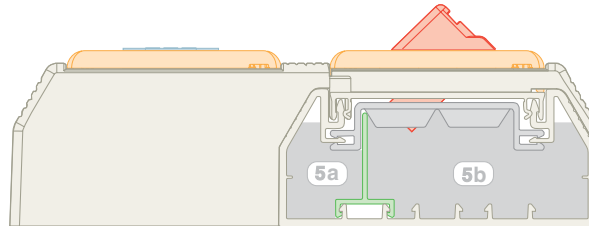

A = .91 in.² A = 3.12 in.²

Cable fill #5: Power and data using the *WORKSTATION OUTLET CENTER™* Offset Box.

SPEC = 40% cable fill – The recommended design in cable capacity, leaves room for future moves, adds, and changes.

MAX for Data = 60% cable fill – The maximum cable quantity based on cable interweaving and packing factors.

MAX for Power cable fill – The maximum of electrical cables based on UL temperature rise test.

| Raceway Type and Configuration | Fill Area (In. ²) | Electrical Cables | | | Data Grade Cables | | Data Grade Cables | | Audio/Video | | Fiber Optic Cable | |
|--|-------------------------------|-------------------|--------|--------|-------------------|-------|-------------------|-------|--------------|-------|-------------------|-------|
| | | 14 AWG | 12 AWG | 10 AWG | 24 AWG/UTP CM | | 24 AWG/UTP CM | | RG6 | | 2 Strand | |
| | | THHN/T90 | | | Cat 6. (4-pr.) | | Augmented Cat. 6 | | DIA. = 0.275 | | DIA. = 0.175 | |
| | | 0.111 | 0.130 | 0.164 | DIA. = 0.250 | | DIA. = 0.330 | | DIA. = 0.275 | | DIA. = 0.175 | |
| | | FILL | | | FILL | | FILL | | FILL | | FILL | |
| MAX | MAX | MAX | SPEC | MAX | SPEC | MAX | SPEC | MAX | SPEC | MAX | MAX | |
| (UL Temp Rise Test) | | | (40%) | (60%) | (40%) | (60%) | (40%) | (60%) | (40%) | (60%) | (40%) | (60%) |
| 1. T-70: No devices. | 5.15 | 24 | 20 | 15 | 41 | 62 | 24 | 36 | 34 | 52 | 85 | 128 |
| 2a. T-70: Power and data using the 3-sided hanging box and device bracket. | 0.86 | 14 | 11 | 7 | — | — | — | — | — | — | — | — |
| 2b. | 1.72 | — | — | — | 14 | 21 | 8 | 12 | 11 | 17 | 28 | 42 |
| 3. T-70: Data only (screw-on faceplates). | 3.67 | — | — | — | 29 | 44 | 17 | 25 | 24 | 37 | 61 | 91 |
| 4. T-70: Data only (snap-on faceplates). | 4.71 | — | — | — | 38 | 57 | 22 | 33 | 31 | 47 | 78 | 117 |
| 5a. T-70: Power and data using the <i>WORKSTATION OUTLET CENTER™</i> Offset Box. | 0.91 | 14 | 11 | 7 | — | — | — | — | — | — | — | — |
| 5b. | 3.12 | — | — | — | 25 | 38 | 14 | 21 | 21 | 31 | 51 | 77 |

AWG dimensions represent typical outer cable diameter in inches.

A. System Overview

Cable Fill Capacities for Twin-70 Raceway

B1. Cable Ties

This information is to be used as a guide in selecting the proper size raceway. The maximum amounts may vary according to the cable installation methods, straightness of cables, etc.

B2. Cable Accessories

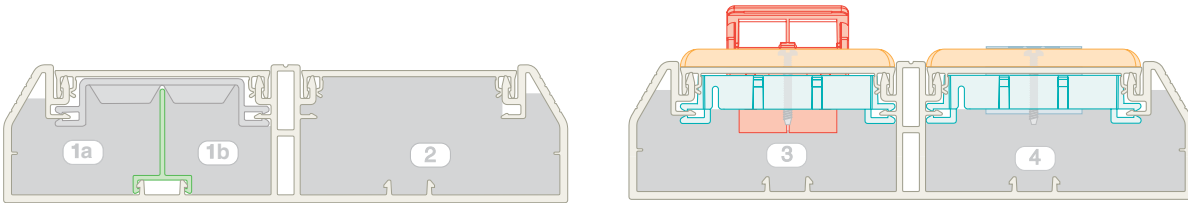

A = 2.05 in.²

A = 1.43 in.²

A = 4.59 in.²

A = 3.11 in.²

A = 3.32 in.²

Cable fill #1: Power and data with no devices.

Cable fill #2: One Twin-70 channel with no devices.

Cable fill #3: Data only using vertical sloped screw-on communication faceplates.

Cable fill #4: Power using device bracket and NEMA standard 70mm screw-on faceplates.

B3. Stainless Steel Ties

C1. Wiring Duct

C2. Surface Raceway

C3. Abrasion Protection

C4. Cable Management

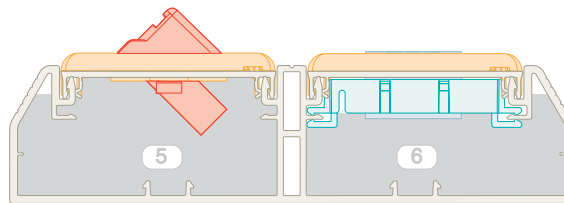

A = 4.14 in.²

A = 2.33 in.²

Cable fill #5: Data only using horizontal sloped snap-on communication faceplates.

Cable fill #6: 20 A TVSS rectangular outlet using device bracket and snap-on electrical/communication faceplate.

D1. Terminals

D2. Power Connectors

D3. Grounding Connectors

E1. Labeling Systems

E2. Labels

E3. Pre-Printed & Write-On Markers

E4. Permanent Identification

E5. Lockout/Tagout & Safety Solutions

F. Index

SPEC = 40% cable fill – The recommended design in cable capacity, leaves room for future moves, adds, and changes.

MAX for Data = 60% cable fill – The maximum cable quantity based on cable interweaving and packing factors.

MAX for Power cable fill – The maximum of electrical cables based on UL temperature rise test.

| | Raceway Type and Configuration | Fill Area (In. ²) | Electrical Cables | | | Data Grade Cables | | Data Grade Cables | | Audio/Video | | Fiber Optic Cable | |
|-----|---|-------------------------------|-------------------|--------|--------|-------------------|-----|-------------------|-----|--------------|-----|-------------------|-----|
| | | | 14 AWG | 12 AWG | 10 AWG | 24 AWG/UTP CM | | 24 AWG/UTP CM | | RG6 | | 2 Strand | |
| | | | THHN/T90 | | | Cat 6. (4-pr.) | | Augmented Cat. 6 | | | | | |
| | | | 0.111 | 0.130 | 0.164 | DIA. = 0.250 | | DIA. = 0.330 | | DIA. = 0.275 | | DIA. = 0.175 | |
| | | | FILL | | | FILL | | FILL | | FILL | | FILL | |
| | | | MAX | MAX | MAX | SPEC | MAX | SPEC | MAX | SPEC | MAX | SPEC | MAX |
| 1a. | Twin-70: Power and data, no terminations. | 2.05 | — | — | 16 | 25 | 9 | 14 | 13 | 20 | 34 | 51 | |
| 1b. | | 1.43 | 16 | 16 | 15 | — | — | — | — | — | — | — | |
| 2. | Twin-70: One channel no devices (data). | 4.59 | — | — | — | 37 | 56 | 21 | 32 | 30 | 46 | 76 | 114 |
| 3. | Twin-70: Data only (screw-on faceplate). | 3.11 | — | — | — | 25 | 38 | 14 | 21 | 20 | 31 | 51 | 77 |
| 4. | Twin-70: Power only (screw-on faceplate). | 3.32 | 15 | 13 | 13 | — | — | — | — | — | — | — | — |
| 5. | Twin-70: Data only (snap-on faceplate). | 4.14 | — | — | — | 33 | 50 | 19 | 29 | 27 | 41 | 68 | 103 |
| 6. | Twin-70: TVSS power (snap-on faceplate). | 2.33 | 16 | 16 | 14 | — | — | — | — | — | — | — | — |

AWG dimensions represent typical outer cable diameter in inches.

PAN-WAY® T-45 Non-Metallic Surface Raceway

PAN-WAY® T-45 Non-Metallic Surface Raceway is a multi-channel raceway which provides a solution for routing copper, fiber optic, and/or power cabling along fixed perimeter walls. T-45 surface raceway terminates using the T-45 hinged data and power brackets, T-45 offset box, and select PAN-WAY® Surface Mount Outlet Boxes.



- Multi-directional cover hinge allows cable installation from either side
- Hinged data and power brackets provide easy access for terminating outlets
- Aesthetically pleasing
- Lightweight
- Tamper resistant
- Fittings maintain 1 inch bend radius control

PAN-WAY® T-45 Surface Raceway accepts NEMA standard screw-on faceplates for superior PAN-WAY® Snap-On Faceplates when terminating with the T-45 offset box and surface mount outlet boxes. Fittings for T-45 are available to transition to PAN-WAY® LD Series Raceway.

A.
System
Overview

B1.
Cable Ties

B2.
Cable
Accessories

B3.
Stainless
Steel Ties

C1.
Wiring
Duct

C2.
Surface
Raceway

C3.
Abrasion
Protection

C4.
Cable
Management

D1.
Terminals

D2.
Power
Connectors

D3.
Grounding
Connectors

E1.
Labeling
Systems

E2.
Labels

E3.
Pre-Printed
& Write-On
Markers

E4.
Permanent
Identification

E5.
Lockout/
Tagout
& Safety
Solutions

F.
Index

A.
System
Overview

T-45 Raceway Roadmap

B1.
Cable Ties

B2.
Cable
Accessories

B3.
Stainless
Steel Ties

C1.
Wiring
Duct

C2.
Surface
Raceway

C3.
Abrasion
Protection

C4.
Cable
Management

D1.
Terminals

D2.
Power
Connectors

D3.
Grounding
Connectors

E1.
Labeling
Systems

E2.
Labels

E3.
Pre-Printed
& Write-On
Markers

E4.
Permanent
Identification

E5.
Lockout/
Tagout/
& Safety
Solutions

F.
Index

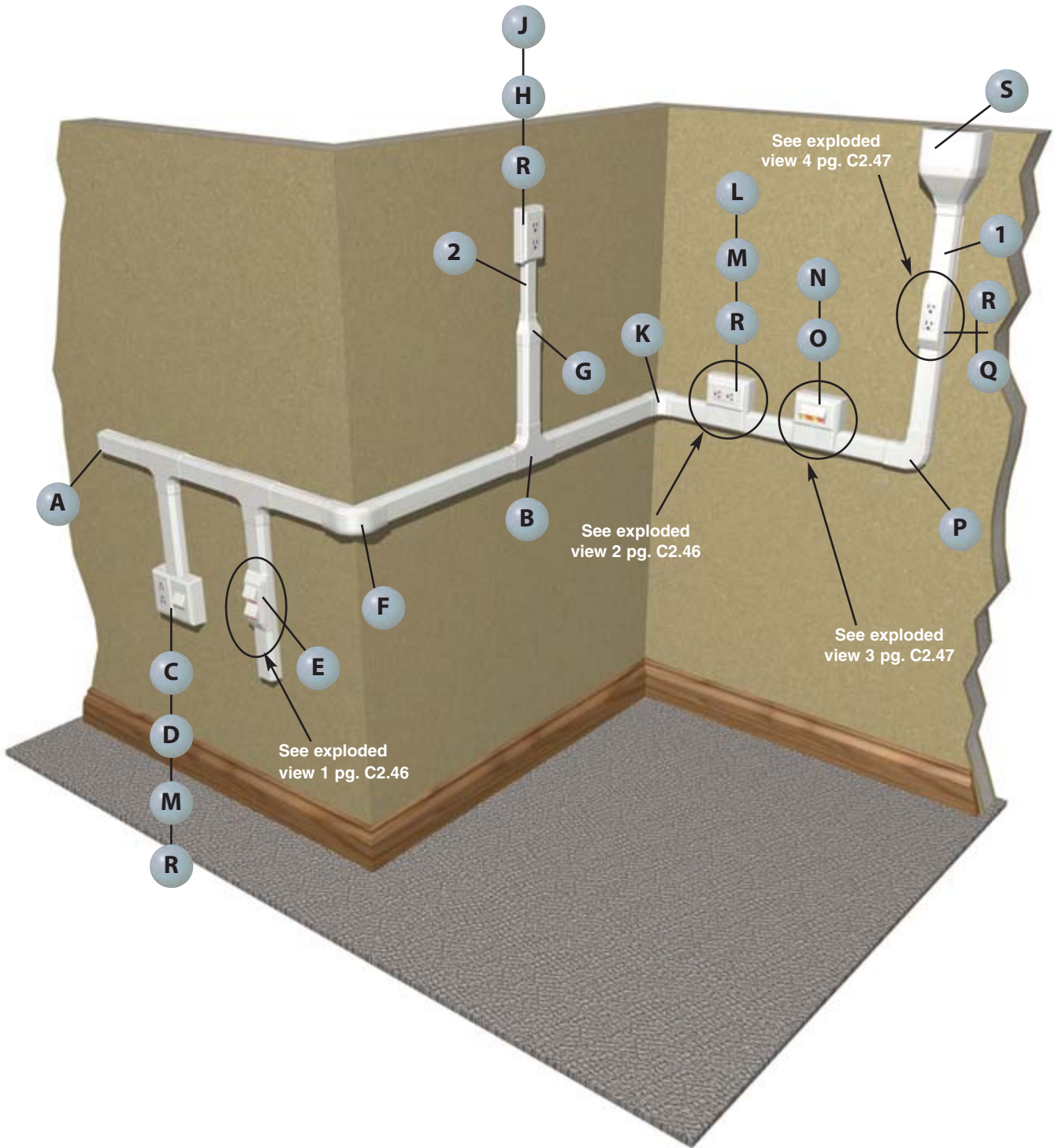

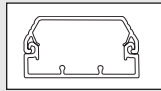

1 T45B** , T45C** – T-45 Raceway (page C2.48)

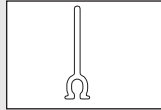

1 T45DW** – T-45 Divider Wall (page C2.48)

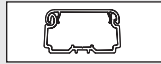

2 LDPH10** – LDPH Raceway (page C2.77)



A T45EC** – T-45 End Cap Fitting (page C2.49)



B T45T** and T45TD – T-45 Tee Fitting and Divider (page C2.49)

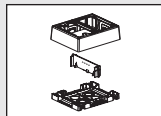

C JBP2FS** – *FAST-SNAP™* Double Gang Power Rated Surface Mount Outlet Box (page C2.52)

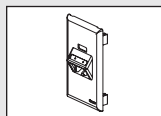

D UIT70FV2** – *ULTIMATE ID®* Sloped Vertical Snap-On Faceplate

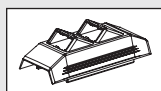

E T45HDB** – T-45 Snap-On Hinged Data Bracket (page C2.49)

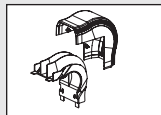

F T45OC** – T-45 Outside Corner Fitting (page C2.49)

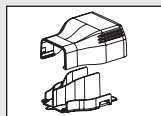

G T45RLD** – T-45 Reducer Fitting (page C2.49)

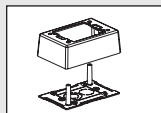

H JBP1** – Power Rated Single Gang Two-Piece Box (page C2.58)

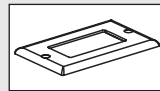

J CPG** – Single Gang Rectangular Electrical/Communication Screw-On Faceplate (page C2.59)

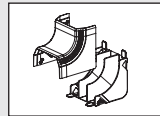

K T45IC** – T-45 Inside Corner Fitting (page C2.49)

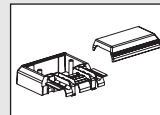

L T45WC** – T-45 Offset Box for Screw-On Faceplates/Receptacles (page C2.49)

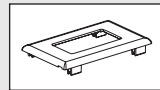

M T70PG** – Single Gang Rectangular Electrical/Communication Snap-On Faceplate (page C2.53)

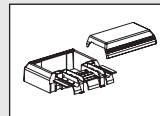

N T45WC2** – T-45 Offset Box for Snap-On Faceplates (page C2.49)

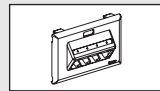

O UIT70FH4** – *ULTIMATE ID®* Sloped Horizontal Snap-On Faceplate

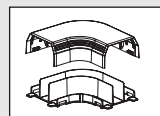

P T45RA** – T-45 Right Angle Fitting (page C2.49)

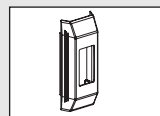

Q T45HEGB** – T-45 Electrical Bracket (page C2.49)

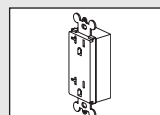

R ERU20** – 20 A Rectangular Electrical Outlet (page C2.60)

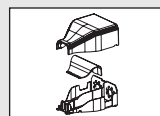

S T45EE** – T-45 Entrance End Fitting (page C2.49)

A. System Overview

B1. Cable Ties

B2. Cable Accessories

B3. Stainless Steel Ties

C1. Wiring Duct

C2. Surface Raceway

C3. Abrasion Protection

C4. Cable Management

D1. Terminals

D2. Power Connectors

D3. Grounding Connectors

E1. Labeling Systems

E2. Labels

E3. Pre-Printed & Write-On Markers

E4. Permanent Identification

E5. Lockout/Tagout & Safety Solutions

F. Index

A.
System
Overview

T-45 Configurations

B1.
Cable Ties

Exploded View 1

| | Components Required | See page |
|----|--|----------|
| A. | T45HDB = T-45 snap-on hinged data bracket. | C2.51 |
| B. | MINI-COM® Modules. | — |

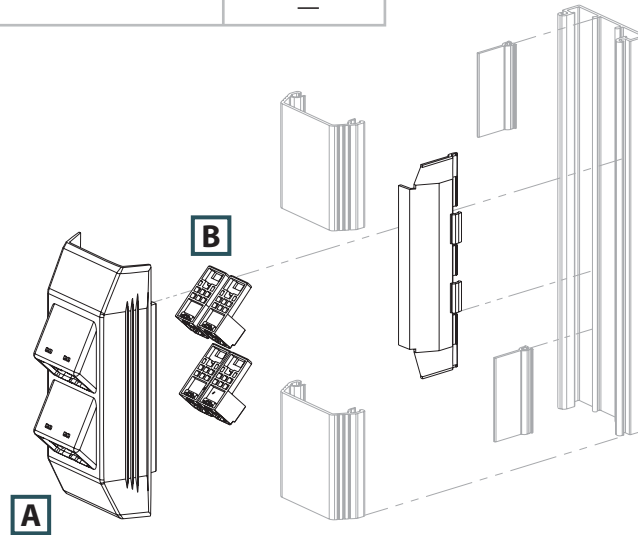

B3.
Stainless
Steel Ties

C1.
Wiring
Duct

C2.
Surface
Raceway

C3.
Abrasion
Protection

C4.
Cable
Management

Exploded View 2

| | Components Required | See page |
|----|---|----------|
| A. | T70PG = Single gang rectangular electrical/communication snap-on faceplate. | C2.55 |
| B. | ERU20 = 20 A rectangular electrical outlet (screws included). | C2.62 |
| C. | T45WC = T-45 offset box for screw-on faceplates/receptacles. | C2.51 |

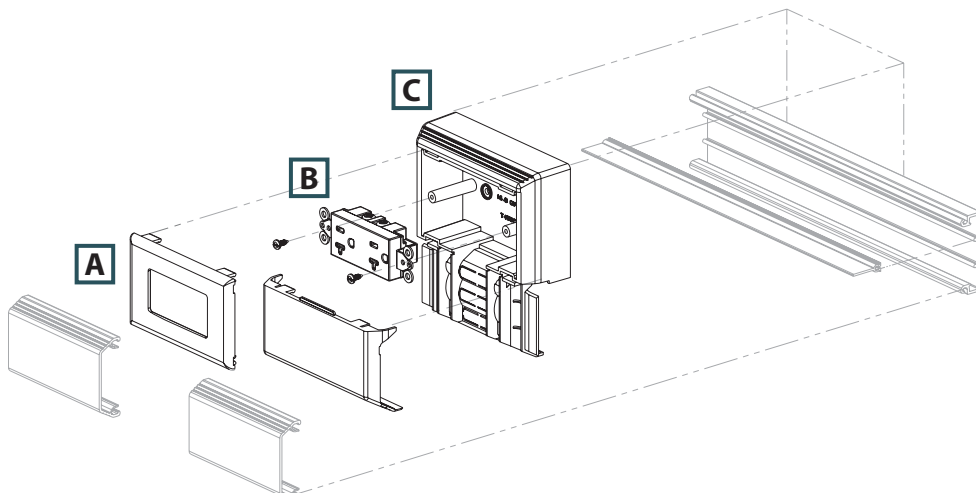

E1.
Labeling
Systems

E2.
Labels

E3.
Pre-Printed
& Write-On
Markers

E4.
Permanent
Identification

E5.
Lockout/
Tagout/
& Safety
Solutions

F.
Index

T-45 Configurations (continued)

Exploded View 3

| | Components Required | See page |
|----|--|----------|
| A. | UIT70FH4 = <i>ULTIMATE ID</i> ® Sloped Horizontal Faceplates – 4-Port. | — |
| B. | <i>MINI-COM</i> ® Modules. | — |
| C. | T45WC2 = T-45 offset box for snap-on faceplates. | C2.49 |

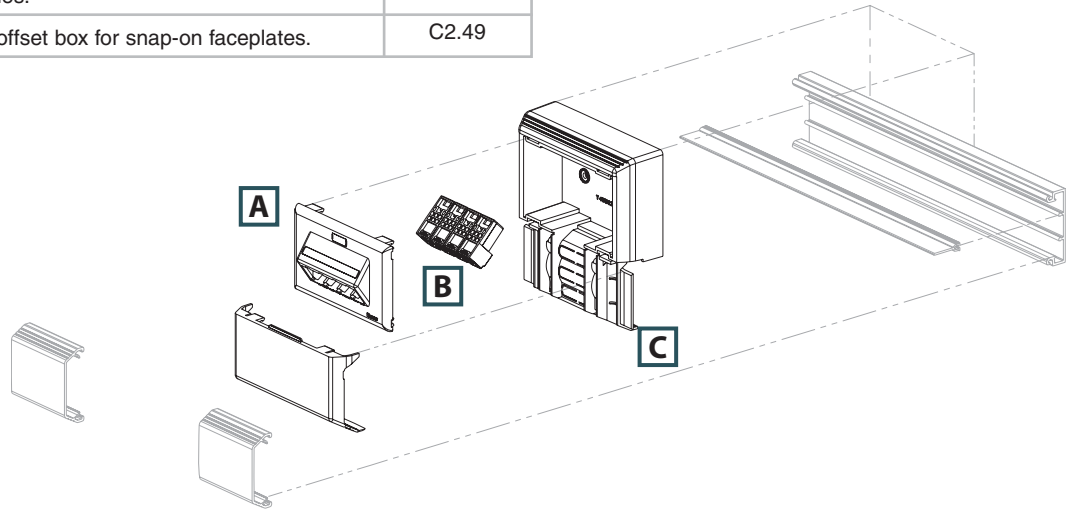

Exploded View 4

| | Components Required | See page |
|----|---|----------|
| A. | T45HEGB = T-45 electrical bracket for rectangular outlet. | C2.59 |
| B. | ERU20 = 20 A rectangular electrical outlet (screws included). | C2.60 |

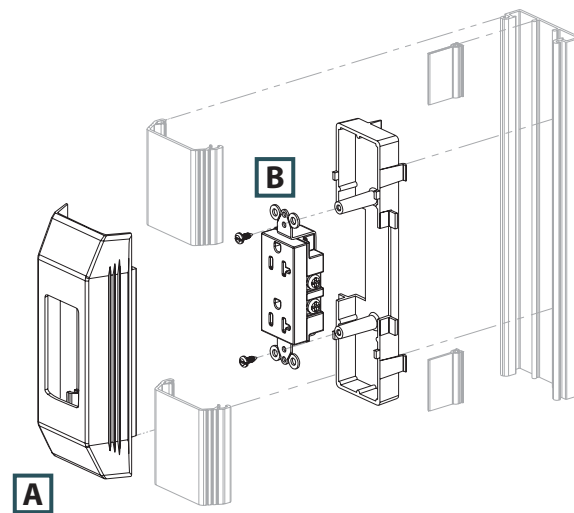

A.
System
Overview

B1.
Cable Ties

B2.
Cable
Accessories

B3.
Stainless
Steel Ties

C1.
Wiring
Duct

C2.
Surface
Raceway

C3.
Abrasion
Protection

C4.
Cable
Management

D1.
Terminals

D2.
Power
Connectors

D3.
Grounding
Connectors

E1.
Labeling
Systems

E2.
Labels

E3.
Pre-Printed
& Write-On
Markers

E4.
Permanent
Identification

E5.
Lockout/
Tagout/
& Safety
Solutions

F.
Index

A. System Overview



PAN-WAY® T-45 Surface Raceway System

B1. Cable Ties

- UL and CSA rated 600 V; meets UL 5A and CSA C22.2 No. 62.1-03 standards; FT4 rated
- Hinged cover allows easy access from either side
- Optional factory applied adhesive backing speeds installation

- Supplied with pre-punched mounting holes
- Tamper resistant
- Terminates using the T-45 hinged data or power brackets, offset box, or surface mount outlet box solutions

B2. Cable Accessories

B3. Stainless Steel Ties

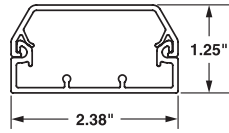

T-45
Internal Area = 2.12 Sq. In.

C1. Wiring Duct



T45B

C2. Surface Raceway



T45C

C3. Abrasion Protection

C4. Cable Management

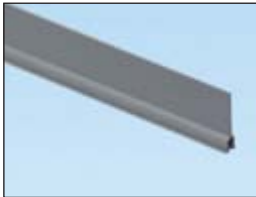

T45DW

D1. Terminals

D2. Power Connectors

D3. Grounding Connectors

E1. Labeling Systems

E2. Labels

E3. Pre-Printed & Write-On Markers

E4. Permanent Identification

E5. Lockout/Tagout & Safety Solutions

F. Index

| Part Number | Part Description | Raceway Size | Color‡ | Length (Ft.) | Std. Ctn. Qty. |
|---|---|---------------------------------|-----------|--------------|----------------|
| T-45 Raceway Base with Adhesive | | | | | |
| T45BIW8-A | T-45 raceway base in 8' and 10' lengths with adhesive. Supplied with pre-punched mounting holes. | 2.38" x 1.25" (60.3mm x 32.0mm) | Off White | 8 | 160 |
| T45BIW10-A | | 2.38" x 1.25" (60.3mm x 32.0mm) | | 10 | 200 |
| T-45 Raceway Base without Adhesive | | | | | |
| T45BIW8 | T-45 raceway base in 8' and 10' lengths with adhesive. Supplied with pre-punched mounting holes. | 2.38" x 1.25" (60.3mm x 32.0mm) | Off White | 8 | 160 |
| T45BIW10 | | | | 10 | 200 |
| T-45 Raceway Cover | | | | | |
| T45CIW8 | T-45 raceway cover in 8' and 10' lengths. Can be hinged open on either side of T-45 base. | — | Off White | 8 | 160 |
| T45CIW10 | | | | 10 | 200 |
| T-45 Raceway Divider Wall | | | | | |
| T45DW8 | T-45 divider wall. Snaps onto rails in T-45 raceway base to create separate channels. Must use wire retainers to ensure channel separation per UL/CSA. Available in 8' and 10' lengths. | — | Gray | 8 | 160 |
| T45DW10 | | | | 10 | 200 |

‡For other colors replace IW (Off White) with EI (Electric Ivory).
Order base and cover separately.
Order number of feet required in multiples of standard carton quantity.



PAN-WAY® T-45 Raceway Fittings

- T-45 fittings are designed to maintain the TIA/EIA-568-B and 569-B required minimum bend radius for high performance copper and fiber optic cabling systems



T45CC

T45RA



T45IC

T45OC



T45T

T45TD

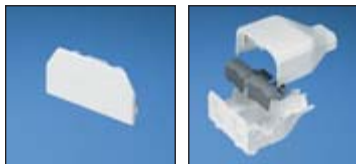

T45EC

T45EE



T45RLD

T45TRI

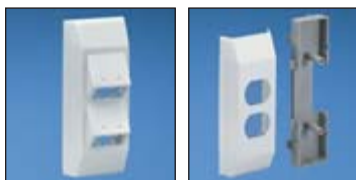

T45HDB

T45HEB

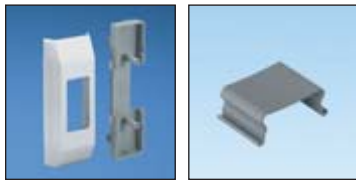

T45HEGB

T45WR-X



T45WC

T45WC2

| Part Number | Part Description | Color‡ | Std. Pkg. Qty. | Std. Ctn. Qty. |
|------------------|--|-----------|----------------|----------------|
| T45CCIW-X | Cover coupler fitting. Used to join two pieces of T-45 cover together. | Off White | 10 | 100 |
| T45RAIW | Right angle fitting. Used to join sections of T-45 raceway at 90° flat junction. | Off White | 1 | 10 |
| T45ICIW | Inside corner fitting. Used to join T-45 raceway at inside corner. | Off White | 1 | 10 |
| T45OCIW | Outside corner fitting. Used to join T-45 raceway at 90° outside corner. | Off White | 1 | 10 |
| T45TIW | Tee fitting. Used to join T-45 raceway at tee intersections. | Off White | 1 | 10 |
| T45TD | Divided insert. Used to separate power and data within the T45T. | Gray | 1 | 10 |
| T45ECIW | End cap fitting. Used to terminate T-45 raceway. | Off White | 1 | 10 |
| T45EEIW | Entrance end fitting. With knockouts for 1/2", 3/4", 1" and 1 1/4" conduit which allows entry from ceiling or wall. | Off White | 1 | 10 |
| T45RLDIW | Reducer fitting. Reduces from T-45 to LD10 profile raceway. | Off White | 1 | 10 |
| T45TRI | Provides bend radius control at transition from T-70 to T-45 when used with T70TR. | Gray | 1 | 10 |
| T45HDBIW | Snap-on hinged data bracket. Used for mounting <i>PANDUIT® MINI-COM®</i> Modules vertically inline within T-45 raceway. Can be hinged opened on either side of T-45 base. | Off White | 1 | 10 |
| T45HEBIW | Electrical bracket and box. Used for mounting standard duplex electrical outlets. | Off White | 1 | 10 |
| T45HEGBIW | Electrical bracket and box. Used for mounting standard rectangular style electrical outlets. | Off White | 1 | 10 |
| T45WR-X | Wire retainers. Used to hold wires in place during installation. | Gray | 10 | 100 |
| T45WCIW | Offset box. Allows for the mounting of any standard electrical or communication outlet offset from the raceway channel. Box accepts any NEMA standard screw-on faceplate or <i>PAN-WAY®</i> Electrical Snap-On Faceplates. | Off White | 1 | 10 |
| T45WC2IW | Offset box. Box accepts any <i>PAN-WAY®</i> Communication Snap-On Faceplates. | Off White | 1 | 10 |

‡For other colors replace IW (Off White) with EI (Electric Ivory). T45TD, T45TRI, and T45WR-X available in Gray only.

A. System Overview

B1. Cable Ties

B2. Cable Accessories

B3. Stainless Steel Ties

C1. Wiring Duct

C2. Surface Raceway

C3. Abrasion Protection

C4. Cable Management

D1. Terminals

D2. Power Connectors

D3. Grounding Connectors

E1. Labeling Systems

E2. Labels

E3. Pre-Printed & Write-On Markers

E4. Permanent Identification

E5. Lockout/Tagout & Safety Solutions

F. Index

A. System Overview

Cable Fill Capacities for T-45 Raceway

This information is to be used as a guide in selecting the proper size raceway. The maximum amounts may vary according to the cable installation methods, straightness of cables, etc.

B1. Cable Ties

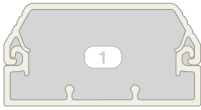

A = 2.13 in.²

Cable fill #1: T-45 with no devices.



A = 1.72 in.²

Cable fill #2: T-45 with wire retainer.

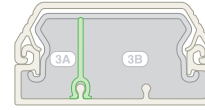

A = .44 in.²

B = 1.20 in.²

Cable fill #3: Power and data using a wire retainer and divider wall.

B2. Cable Accessories

B3. Stainless Steel Ties

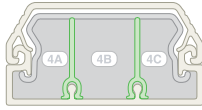

A = .44 in.²

B = .68 in.²

C = .44 in.²

Cable fill #4: Power and data using a wire retainer and divider walls.

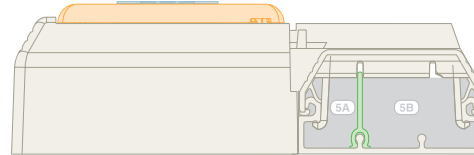

A = .41 in.²

B = 1.06 in.²

Cable fill #5: Power and data using the offset box.

C1. Wiring Duct

C2. Surface Raceway

C3. Abrasion Protection

C4. Cable Management

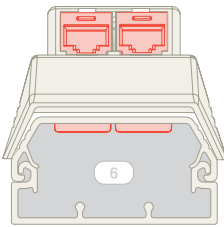

A = 2.00 in.²

Cable fill #6: Data only using hinged data bracket.

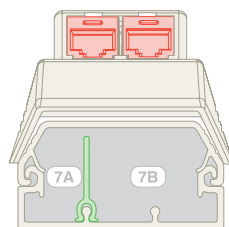

A = .52 in.²

B = 1.2 in.²

Cable fill #7: Power and data using hinged data bracket with divider insert.

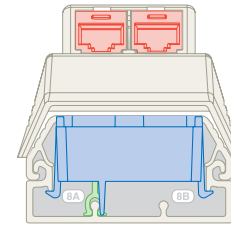

A = .22 in.²

B = .5 in.²

Cable fill #8: Power and data using electrical bracket/box and hinged data bracket.

D1. Terminals

D2. Power Connectors

D3. Grounding Connectors

E1. Labeling Systems

E2. Labels

E3. Pre-Printed & Write-On Markers

E4. Permanent Identification

E5. Lockout/Tagout & Safety Solutions

F. Index

SPEC = 40% cable fill – The recommended design in cable capacity, leaves room for future moves, adds, and changes.

MAX for Data = 60% cable fill – The maximum cable quantity based on cable interweaving and packing factors.

MAX for Power cable fill – The maximum of electrical cables based on UL temperature rise test.

| Raceway Type and Configuration | Fill Area (In. ²) | Electrical Cables | | | Data Grade Cables | | Data Grade Cables | | Audio/Video | | Fiber Optic Cable | | | |
|---|-------------------------------|-------------------|--------|--------|-------------------|---------------|-------------------|-----|-------------|-----|-------------------|-----|-------|--|
| | | 14 AWG | 12 AWG | 10 AWG | 23/24 AWG/UTP | 23 AWG/UTP CM | RG6 | | 2 Strand | | | | | |
| | | THHN/T90 | | | Cat 6. (4-pr.) | | Augmented Cat. 6 | | | | | | | |
| | | 0.111 | 0.130 | 0.164 | DIA. = .250 | | DIA. = .354 | | DIA. = .275 | | DIA. = .175 | | | |
| | | FILL | | | FILL | | FILL | | FILL | | FILL | | | |
| | | MAX | MAX | MAX | SPEC | MAX | SPEC | MAX | SPEC | MAX | SPEC | MAX | MAX | |
| (UL Temp Rise Test) | | | (40%) | | (60%) | | (40%) | | (60%) | | (40%) | | (60%) | |
| 1. T-45: No devices. | 2.13 | 36 | 27 | 25 | 17 | 26 | 9 | 14 | 14 | 21 | 35 | 53 | | |
| 2. T-45: No devices with wire retainer. | 1.72 | 36 | 27 | 25 | 14 | 21 | 8 | 12 | 11 | 17 | 28 | 42 | | |
| 3A. T-45: Power and data with wire retainer and divider wall | 0.44 | 12 | 11 | 8 | — | — | — | — | — | — | — | — | | |
| 3B. (2 channels). | 1.20 | — | — | — | 9 | 14 | 5 | 8 | 8 | 12 | 19 | 29 | | |
| 4A. T-45: Power and data with wire retainer and two divider walls (three channels). | 0.44 | 12 | 11 | 8 | 3 | 5 | 2 | 3 | 2 | 4 | 7 | 10 | | |
| 4B. | 0.68 | — | — | — | 5 | 8 | 3 | 4 | 4 | 6 | 11 | 16 | | |
| 4C. | 0.44 | — | — | — | 3 | 5 | 2 | 3 | 2 | 4 | 7 | 10 | | |
| 5A. T-45: Power and data using the offset box. | 0.41 | 12 | 11 | 8 | — | — | — | — | — | — | — | — | | |
| 5B. | 1.06 | — | — | — | 8 | 12 | 4 | 7 | 7 | 10 | 17 | 26 | | |
| 6. T-45: Data only using data bracket. | 2.00 | — | — | — | 16 | 24 | 9 | 14 | 13 | 20 | 33 | 49 | | |
| 7A. T-45: Power and data using hinged data bracket with divider insert. | 0.52 | 12 | 11 | 8 | — | — | — | — | — | — | — | — | | |
| 7B. | 1.2 | — | — | — | 9 | 14 | 5 | 8 | 8 | 12 | 19 | 29 | | |
| 8A. T-45: Power and data using electrical bracket and box. | 0.22 | 9 | 7 | 4 | — | — | — | — | — | — | — | — | | |
| 8B. | 0.5 | — | — | — | 4 | 6 | 2 | 3 | 3 | 5 | 8 | 12 | | |

AWG dimensions represent typical outer cable diameter in inches.

PAN-WAY® SNAP-ON FACEPLATES AND SURFACE MOUNT OUTLET BOXES

PAN-WAY® Snap-On Faceplates are designed for use with PANDUIT surface raceway systems and install faster than conventional screw-on faceplates, reducing labor costs and providing a more aesthetic appearance. PAN-WAY® Snap-On Communication Faceplates are available in vertical and horizontal orientation and accept PANDUIT® MINI-COM® Copper and Fiber Optic Modules. Electrical outlets are available in colors to complement PANDUIT raceway and are available in 20 A, 106 duplex, rectangular, TVSS and GFCI.



- Snap-on faceplates install without the use of screws providing faster installation and superior aesthetics
- FAST-SNAP™ Boxes assemble without the use of screws and accept PAN-WAY® Snap-On Faceplates
- Snap-on communication faceplates are available in horizontal or vertical sloped outlet configurations
- Snap-on electrical faceplates are available in 106 duplex or rectangular styles

Surface mount outlet boxes are available for both power and communication applications. They are compatible with PAN-WAY® LD, LDPH, LD2P10 and T-45 Raceway Systems. PAN-WAY® Snap-On Faceplates mount directly to Cove, TG-70, T-70, Twin-70 raceways, PAN-WAY® FAST-SNAP™ Boxes and PAN-POLE™ Aluminum Outlet Poles.

A. System Overview

B1. Cable Ties

B2. Cable Accessories

B3. Stainless Steel Ties

C1. Wiring Duct

C2. Surface Raceway

C3. Abrasion Protection

C4. Cable Management

D1. Terminals

D2. Power Connectors

D3. Grounding Connectors

E1. Labeling Systems

E2. Labels

E3. Pre-Printed & Write-On Markers

E4. Permanent Identification

E5. Lockout/Tagout & Safety Solutions

F. Index

A. System Overview



PAN-WAY® FAST-SNAP™ Surface Mount Outlet Boxes

B1. Cable Ties

- JB1FS and JBP2FS assemble without the use of screws for faster installation
- JB1FS and JBP2FS are supplied with adhesive backing to speed installation

- JB1FS and JBP2FS accept PAN-WAY® Snap-on Faceplates for superior aesthetics

B2. Cable Accessories



JB1FS**-A

B3. Stainless Steel Ties



JBP2FS**

C1. Wiring Duct

C2. Surface Raceway

C3. Abrasion Protection

C4. Cable Management

| Part Number | Part Description | Color‡ | Std. Pkg. Qty. | Std. Ctn. Qty. |
|------------------|--|-----------|----------------|----------------|
| JB1FSIW-A | Single gang two-piece snap together outlet box with adhesive backing. Box accepts PAN-WAY® Snap-On Faceplates. For use with PAN-WAY® T-45 or LD profile raceway. 5.00"L x 3.26"W x 1.62"H (127.1mm x 82.7mm x 41.1mm). Breakouts for 1/2", 3/4", or 1" diameter conduit. | Off White | 1 | 10 |
| JBP2FSIW | Double gang power rated two-piece snap together outlet box. Box accepts PAN-WAY® Snap-On Faceplates. For use with PAN-WAY® T-45 or LD profile raceway. 5.00"L x 6.14"W x 1.62"H (127.1mm x 155.9mm x 41.1mm). Breakouts for 1/2", 3/4", or 1" diameter conduit. | Off White | 1 | 10 |

‡For other colors replace IW (Off White) with EI (Electric Ivory), IG (International Gray), or WH (White). For complete labeling solutions and product information, reference chart below.



PAN-WAY® Classic Series Snap-On Faceplates for Use with PANDUIT® MINI-COM® Modules

- Can be used with PAN-WAY® Cove, TG-70, T-70, Twin-70, T-45 Raceway Systems, FAST-SNAP™ Outlet Boxes and PAN-POLE™ Aluminum Outlet Pole

D1. Terminals



T70FH2



T70FH4

D2. Power Connectors

D3. Grounding Connectors



T70FV2



T70FV4

E1. Labeling Systems

E2. Labels

E3. Pre-Printed & Write-On Markers

E4. Permanent Identification

E5. Lockout/Tagout & Safety Solutions

F. Index

| Part Number | Part Description | Color‡ | Std. Pkg. Qty. | Std. Ctn. Qty. |
|-----------------|--|-----------|----------------|----------------|
| T70FH2IW | Snap-on horizontal sloped communication faceplate. Accepts two PANDUIT® MINI-COM® Modules (not included). No additional mounting hardware required. | Off White | 1 | 10 |
| T70FH4IW | Snap-on horizontal sloped communication faceplate. Accepts four PANDUIT® MINI-COM® Modules (not included). No additional mounting hardware required. | Off White | 1 | 10 |
| T70FV2IW | Snap-on vertical sloped communication faceplate. Accepts two PANDUIT® MINI-COM® Modules (not included). No additional mounting hardware required. | Off White | 1 | 10 |
| T70FV4IW | Snap-on vertical sloped communication faceplate. Accepts four PANDUIT® MINI-COM® Modules (not included). No additional mounting hardware required. | Off White | 1 | 10 |

‡For other colors replace IW (Off White) with EI (Electric Ivory), IG (International Gray), or WH (White). For complete labeling solutions and product information, reference chart below.

Component Labels for PAN-WAY® Classic Series Snap-On Faceplates for Use with PANDUIT® MINI-COM® Modules and Inserts



| Faceplate Part Number | Suggested Label Solutions for TIA/EIA-606-A Compliance | | | |
|-----------------------|--|--|---------------------------------------|-------------------------------------|
| | Laser/Ink Jet Desktop Printer Label | TDP43MY Thermal Transfer Desktop Printer Label | PANTHER™ LS8E Hand-Held Printer Label | COUGAR™ LS9 Hand-Held Printer Label |
| T70FH2IW | C125X030FJJ | C125X030YPT | C125X030FJC | T031X000FJC-BK |
| T70FV2IW | | | | |
| T70FV4IW | | | | |
| All T70B Parts | | | | |
| T70FH4IW | C252X030FJJ | C252X030YPT | C252X030FJC | T031X000FJC-BK |



PAN-WAY® Classic Series Snap-On Faceplates for Use with PANDUIT® MINI-COM® Inserts

- Single gang vertical or horizontal sloped communication faceplates accept one or two PANDUIT® MINI-COM® Inserts
- Can be used with PAN-WAY® Cove, TG-70, T-70, Twin-70, T-45 Raceway Systems, FAST-SNAP™ Outlet Boxes and PAN-POLE™ Aluminum Outlet Pole



T70BH1



T70BH2



T70B1



T70B2

| Part Number | Part Description | Color‡ | Std. Pkg. Qty. | Std. Ctn. Qty. |
|-----------------|---|-----------|----------------|----------------|
| T70BH1IW | Snap-on horizontal communication faceplate. Accepts one 1/2-size PANDUIT® MINI-COM® Insert and two modules. No additional mounting hardware required. | Off White | 1 | 10 |
| T70BH2IW | Snap-on horizontal communication faceplate. Accepts two 1/2-size PANDUIT® MINI-COM® Inserts and four modules. No additional mounting hardware required. | Off White | 1 | 10 |
| T70B1IW | Snap-on vertical communication faceplate. Holds one 1/2-size PANDUIT® MINI-COM® Insert and two modules. No additional mounting hardware required. | Off White | 1 | 10 |
| T70B2IW | Snap-on vertical communication faceplate. Holds two 1/2-size PANDUIT® MINI-COM® Inserts and four modules. No additional mounting hardware required. | Off White | 1 | 10 |

‡For other colors replace IW (Off White) with EI (Electric Ivory), IG (International Gray), or WH (White). For complete labeling solutions and product information, reference chart on previous page.



PAN-WAY® Classic Series Snap-On Faceplates for Communication/Power

- Can be used with PAN-WAY® Cove, TG-70, T-70, Twin-70, T-45 Raceway Systems, FAST-SNAP™ Outlet Boxes and PAN-POLE™ Aluminum Outlet Pole



T70P



T70PG



T70PS



T70PGS



T70PN

| Part Number | Part Description | Color‡ | Std. Pkg. Qty. | Std. Ctn. Qty. |
|-----------------|---|-----------|----------------|----------------|
| T70PIW | Snap-on single gang 106 duplex electrical/communication faceplate. Used to cover one NEMA standard 106 duplex electrical outlet. In communication applications, covers one standard 106 duplex communication module frame. | Off White | 1 | 10 |
| T70PGIW | Snap-on single gang rectangular electrical/communication faceplate. Used to cover one NEMA standard rectangular electrical outlet. In communication applications, covers one standard rectangular communication module frame. | Off White | 1 | 10 |
| T70PSIW | Snap-on single gang 106 duplex communication faceplate. Used to cover one NEMA standard 106 duplex communication module frame. Module frame screw mounts directly to underside of snap-on faceplate. No mounting device needed. Supplied with one mounting screw. Note: Not for use with electrical devices. | Off White | 1 | 10 |
| T70PGSIW | Snap-on single gang rectangular communication faceplate. Used to cover one NEMA standard rectangular communication module frame. Module frame screw mounts directly to underside of snap-on faceplate. No mounting device needed. Supplied with two mounting screws. Note: Not for use with electrical devices. | Off White | 1 | 10 |
| T70PNIW | Snap-on single gang blank cover faceplate. | Off White | 1 | 10 |

‡For other colors replace IW (Off White) with EI (Electric Ivory), IG (International Gray), or WH (White). Component Labels for PAN-WAY® Classic Series Snap-On Faceplates for Communication and Power, please reference pg. C2.59.

A. System Overview

B1. Cable Ties

B2. Cable Accessories

B3. Stainless Steel Ties

C1. Wiring Duct

C2. Surface Raceway

C3. Abrasion Protection

C4. Cable Management

D1. Terminals

D2. Power Connectors

D3. Grounding Connectors

E1. Labeling Systems

E2. Labels

E3. Pre-Printed & Write-On Markers

E4. Permanent Identification

E5. Lockout/Tagout & Safety Solutions

F. Index

A. System Overview



PANDUIT® NETKEY® Snap-On Sloped Keystone Faceplates

B1. Cable Ties

- Accept all PANDUIT® NETKEY® Keystone Copper Modules and Duplex Fiber Optic Modules
- Snap into raceway channel, requires no additional mounting hardware or adapters – greatly reducing installation time
- Lowest cost for moves, adds, and changes

- Tamper resistant
- Can be used with PAN-WAY® Cove, TG-70, T70, Twin-70, T-45 Raceway Systems, FAST-SNAP™ Outlet Boxes, and PAN-POLE™ Aluminum Outlet Poles

B2. Cable Accessories

B3. Stainless Steel Ties

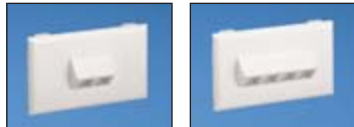

NK2HSRF

NK4HSRF

C1. Wiring Duct



NK4VSRF

C2. Surface Raceway

C3. Abrasion Protection

C4. Cable Management

| Part Number | Part Description | Color‡ | Std. Pkg. Qty. | Std. Ctn. Qty. |
|------------------|--|-----------|----------------|----------------|
| NK2HSRFIW | Snap-on 2-position sloped horizontal faceplate accepts any PANDUIT® NETKEY® Module. Compatible with PANDUIT® FAST-SNAP™ Outlet Boxes, Surface Raceway Systems, and PAN-POLE™ Outlet Poles. | Off White | 1 | 10 |
| NK4HSRFIW | Snap-on 4-position sloped horizontal faceplate accepts any PANDUIT® NETKEY® Module. Compatible with PANDUIT® FAST-SNAP™ Outlet Boxes, Surface Raceway Systems, and PAN-POLE™ Outlet Poles. | Off White | 1 | 10 |
| NK4VSRFIW | Snap-on 4-position sloped vertical faceplate accepts any PANDUIT® NETKEY® Module. Compatible with PANDUIT® FAST-SNAP™ Outlet Boxes, Surface Raceway Systems, and PAN-POLE™ Outlet Poles. | Off White | 1 | 10 |

PANDUIT® NETKEY® faceplates are NOT compatible with PANDUIT® MINI-COM® Modules.

‡For other colors replace IW (Off White) with EI (Electric Ivory), IG (International Gray), or WH (White).

For complete labeling solutions, reference chart below.



PANDUIT® NETKEY® Snap-On Flush Universal Keystone Faceplates

D1. Terminals

- Wider module spacing to accept common manufacturers' keystone modules .900 inches wide or less

- Can be used with PAN-WAY® Cove, TG-70, T70, Twin-70, T-45 Raceway Systems, FAST-SNAP™ Outlet Boxes, and PAN-POLE™ Aluminum Outlet Poles

D2. Power Connectors

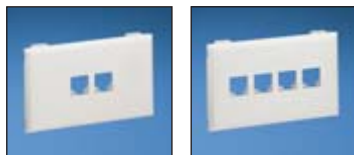

T70KW2

T70KW4

D3. Grounding Connectors

E1. Labeling Systems

E2. Labels

E3. Pre-Printed & Write-On Markers

E4. Permanent Identification

E5. Lockout/Tagout & Safety Solutions

F. Index

| Part Number | Part Description | Color‡ | Std. Pkg. Qty. | Std. Ctn. Qty. |
|-----------------|---|-----------|----------------|----------------|
| T70KW2IW | Snap-on 2-position flush mount faceplate accepts any PANDUIT® NETKEY® Module and most other manufacturers' keystone modules. Compatible with PANDUIT® FAST-SNAP™ Outlet Boxes, Surface Raceway Systems, and PAN-POLE™ Outlet Poles. | Off White | 1 | 10 |
| T70KW4IW | Snap-on 4-position flush mount faceplate accepts any PANDUIT® NETKEY® Module and most other manufacturers' keystone modules. Compatible with PANDUIT® FAST-SNAP™ Outlet Boxes, Surface Raceway Systems, and PAN-POLE™ Outlet Poles. | Off White | 1 | 10 |

PANDUIT® NETKEY® faceplates are NOT compatible with PANDUIT® MINI-COM® Modules.

‡For other colors replace IW (Off White) with EI (Electric Ivory), IG (International Gray), or WH (White).

For complete labeling solutions, reference chart below.

Component Labels for Snap-On “Sloped” (Keystone) Faceplates and Snap-On “Flush” Universal (Keystone) Faceplates

| Suggested Label Solutions for TIA/EIA-606-A Compliance | | | |
|--|-------------------------------------|---------------------------------------|-------------------------------------|
| Faceplate Part Number | Laser/Ink Jet Desktop Printer Label | PANTHER™ LS8E Hand-Held Printer Label | COUGAR™ LS9 Hand-Held Printer Label |
| NK2HSRFIW T70KW2IW | C125X030FJJ | C125X030FJC | T031X000FJC-BK |
| NK4VSRFIW | 2-C125X030FJJ | 2-C125X030FJC | |
| NK4HSRFIW T70KW4IW | C261X030FJJ | C125X030FJC | |



PAN-WAY® Snap-On Faceplates for SYSTIMAX* Communication Modules

• Can be used with PAN-WAY® Cove, TG-70, T70, Twin-70, T-45 Raceway Systems, FAST-SNAP™ Outlet Boxes, and PAN-POLE™ Aluminum Outlet Poles



T70L2



T70L4



T70LV2

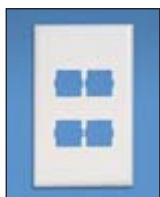

T70LV4

| Part Number | Part Description | Color‡ | Std. Pkg. Qty. | Std. Ctn. Qty. |
|-----------------|--|-----------|----------------|----------------|
| T70L2IW | Snap-on horizontal communication faceplate designed to accept two SYSTIMAX* communication modules (not included). Can be used with PANDUIT surface raceway systems and boxes that accept 70mm faceplates. No additional mounting hardware required. | Off White | 1 | 10 |
| T70L4IW | Snap-on horizontal communication faceplate designed to accept four SYSTIMAX* communication modules (not included). Can be used with PANDUIT surface raceway systems and boxes that accept 70mm faceplates. No additional mounting hardware required. | Off White | 1 | 10 |
| T70LV2IW | Snap-on vertical communication faceplate designed to accept two SYSTIMAX* communication modules (not included). Can be used with PANDUIT surface raceway systems and boxes that accept 70mm faceplates. No additional mounting hardware required. | Off White | 1 | 10 |
| T70LV4IW | Snap-on vertical communication faceplate designed to accept four SYSTIMAX* communication modules (not included). Can be used with PANDUIT surface raceway systems and boxes that accept 70mm faceplates. No additional mounting hardware required. | Off White | 1 | 10 |

‡For other colors replace IW (Off White) with EI (Electric Ivory), IG (International Gray), or WH (White).

*SYSTIMAX is a registered trademark of Commscope, Inc.

For complete labeling solutions, reference chart below.

Component Labels for PAN-WAY® Snap-On Faceplates for use with SYSTIMAX* Communication Modules

| Faceplate Part Number | Suggested Label Solutions for TIA/EIA-606-A Compliance | | |
|-----------------------|--|---------------------------------------|-------------------------------------|
| | Laser/Ink Jet Desktop Printer Label | PANTHER™ LS8E Hand-Held Printer Label | COUGAR™ LS9 Hand-Held Printer Label |
| T70L2IW T70LV2IW | C125X030FJJ | C125X030FJC | T031X000FJC-BK |
| T70LV4IW | 2-C125X030FJJ | 2-C125X030FJC | |
| T70L4IW | C261X030FJJ | C125X030FJC | |

*SYSTIMAX is a registered trademark of Commscope, Inc.

A. System Overview

B1. Cable Ties

B2. Cable Accessories

B3. Stainless Steel Ties

C1. Wiring Duct

C2. Surface Raceway

C3. Abrasion Protection

C4. Cable Management

D1. Terminals

D2. Power Connectors

D3. Grounding Connectors

E1. Labeling Systems

E2. Labels

E3. Pre-Printed & Write-On Markers

E4. Permanent Identification

E5. Lockout/Tagout & Safety Solutions

F. Index

A. System Overview



PAN-WAY® Snap-On Faceplates for Nordx/CDT* Communication Modules

B1. Cable Ties

- Can be used with *PAN-WAY*® Cove, TG-70, T70, Twin-70, T-45 Raceway Systems, *FAST-SNAP*™ Outlet Boxes, and *PAN-POLE*™ Aluminum Outlet Poles

B2. Cable Accessories



T70N2

B3. Stainless Steel Ties



T70N4

C1. Wiring Duct

C2. Surface Raceway



T70NV2

C3. Abrasion Protection

C4. Cable Management



T70NV4

D1. Terminals

D2. Power Connectors

D3. Grounding Connectors

E1. Labeling Systems

E2. Labels

E3. Pre-Printed & Write-On Markers

E4. Permanent Identification

E5. Lockout/Tagout & Safety Solutions

F. Index

| Part Number | Part Description | Color‡ | Std. Pkg. Qty. | Std. Ctn. Qty. |
|-----------------|--|-----------|----------------|----------------|
| T70N2IW | Snap-on horizontal communication faceplate designed to accept two Nordx/CDT* communication modules (not included). Can be used with <i>PANDUIT</i> surface raceway systems and boxes that accept 70mm faceplates. No additional mounting hardware required. | Off White | 1 | 10 |
| T70N4IW | Snap-on horizontal communication faceplate designed to accept four Nordx/CDT* communication modules (not included). Can be used with <i>PANDUIT</i> surface raceway systems and boxes that accept 70mm faceplates. No additional mounting hardware required. | Off White | 1 | 10 |
| T70NV2IW | Snap-on vertical communication faceplate designed to accept two Nordx/CDT* communication modules (not included). Can be used with <i>PANDUIT</i> surface raceway systems and boxes that accept 70mm faceplates. No additional mounting hardware required. | Off White | 1 | 10 |
| T70NV4IW | Snap-on vertical communication faceplate designed to accept two Nordx/CDT* communication modules (not included). Can be used with <i>PANDUIT</i> surface raceway systems and boxes that accept 70mm faceplates. No additional mounting hardware required. | Off White | 1 | 10 |

‡For other colors replace IW (Off White) with EI (Electric Ivory).

*Nordx/CDT is a registered trademark of Nordx/CDT, Inc.

For complete labeling solutions, reference chart below.

Component Labels for *PAN-WAY*® Snap-On Faceplates for use with Nordx/CDT* Communication Modules

| Suggested Label Solutions for TIA/EIA-606-A Compliance | | | |
|--|-------------------------------------|---|---|
| Faceplate Part Number | Laser/Ink Jet Desktop Printer Label | <i>PANTHER</i> ™ LS8E Hand-Held Printer Label | <i>COUGAR</i> ™ LS9 Hand-Held Printer Label |
| T70N2IW T70NV2IW | C125X030FJJ | C125X030FJC | T031X000FJC-BK |
| T70NV4IW | 2-C125X030FJJ | 2-C125X030FJC | |
| T70N4IW | C261X030FJJ | C125X030FJC | |

*Nordx/CDT is a registered trademark of Nordx/CDT, Inc.

For complete labeling solutions, reference charts on pages E2.4 and E2.5.



PAN-WAY® Low Voltage Surface Mount Outlet Boxes

- JBX3510 assembles without the use of screws for faster installation
- JB1 and JB1D are a one-piece design requiring no assembly
- JBX3510, JB1, and JB1D are supplied with adhesive backing to speed installation



JBX3510-A**



JB1-A**



JB1D-A**



JBP2

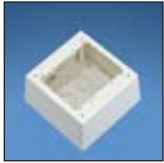

JBP2D



RJBX3510



JBA-X



JB1FS-A**

| Part Number | Part Description | Color‡ | Std. Pkg. Qty. | Std. Ctn. Qty. |
|--------------------|---|-----------|----------------|----------------|
| JBX3510IW-A | Single gang two-piece snap together outlet box with adhesive backing. Box accepts PAN-WAY® Screw-On Faceplates or any NEMA standard single gang faceplate. For use with PAN-WAY® T45 or LD profile raceway. 5.00"L x 3.26"W x 1.62"H (127.1mm x 82.7mm x 41.1mm). Breakouts for 1/2", 3/4", or 1" diameter conduit. | Off White | 1 | 10 |
| JB1IW-A | Single gang one-piece outlet box with adhesive backing. Box accepts PAN-WAY® Screw-On Faceplates or any NEMA standard single gang faceplate. For use with PAN-WAY® LD profile raceway. 5.09"L x 3.34"W x 1.75"H (129.4mm x 85.0mm x 44.4mm). Breakouts for 1/2", 3/4", or 1" diameter conduit. | Off White | 1 | 10 |
| JB1DIW-A | Single gang one-piece deep outlet box with adhesive backing. Box accepts PAN-WAY® Screw-On Faceplates or any NEMA standard single gang faceplate. For use with PAN-WAY® LD profile raceway. 5.23"L x 3.48"W x 2.75"H (133.0mm x 88.5mm x 69.8mm). Breakouts for 1/2", 3/4", or 1" diameter conduit. | Off White | 1 | 10 |
| JBP2IW | Double gang two-piece screw together outlet box. Box accepts PAN-WAY® Screw-On Faceplates or any NEMA standard double gang faceplates. For use with PAN-WAY® LD profile raceway. 5.05" L x 5.05" W x 1.62"H (128.2mm x 128.2mm x 41.1mm). Breakouts for 1/2" or 3/4" diameter conduit. | Off White | 1 | 10 |
| JBP2DIW | Double gang two-piece screw together deep outlet box. Box accepts PAN-WAY® Screw-On Faceplates or any NEMA standard double gang faceplate. For use with PAN-WAY® T-45 or LD profile raceway. 5.19"L x 5.19"W x 2.75"H (131.9mm x 131.9mm x 69.8mm). Breakouts for 3/4" or 1" diameter conduit. | Off White | 1 | 10 |
| RJBX3510IW | Single gang two-piece screw together round outlet box. Box accepts UL/CSA devices not to exceed 10 lbs. (5 lbs. per CSA). For use with PAN-WAY® LD profile raceway. Dia. = 5.48"D x 1.14"H (139.2mm x 29.0mm). Breakouts for 3/4" or 1" diameter conduit. | Off White | 1 | 5 |
| JBA-X | In-wall box adapter. Adapts single gang surface mount outlet boxes to in-wall conduit boxes. | — | 10 | 100 |
| JB1FSIW-A | Single gang two-piece snap together outlet box with adhesive backing. Box accepts PAN-WAY® Snap-On Faceplates. For use with PAN-WAY® T-45 or LD profile raceway. 5.00"L x 3.26"W x 1.62"H (127.1mm x 82.7mm x 41.1mm). Breakouts for 1/2", 3/4", or 1" diameter conduit. | Off White | 1 | 10 |

‡For other colors replace IW (Off White) with EI (Electric Ivory), IG (International Gray), or WH (White).

A. System Overview

B1. Cable Ties

B2. Cable Accessories

B3. Stainless Steel Ties

C1. Wiring Duct

C2. Surface Raceway

C3. Abrasion Protection

C4. Cable Management

D1. Terminals

D2. Power Connectors

D3. Grounding Connectors

E1. Labeling Systems

E2. Labels

E3. Pre-Printed & Write-On Markers

E4. Permanent Identification

E5. Lockout/Tagout & Safety Solutions

F. Index

A. System Overview



PAN-WAY® Power Rated Surface Mount Outlet Boxes

B1. Cable Ties

- JBX3510 assembles without the use of screws for faster installation
- JB1 and JB1D are a one-piece design requiring no assembly
- JBX3510, JB1, and JB1D are supplied with adhesive backing to speed installation

B2. Cable Accessories

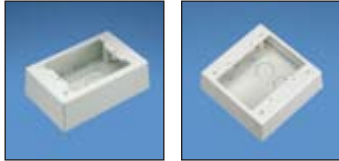

JBP1

JBP2

B3. Stainless Steel Ties

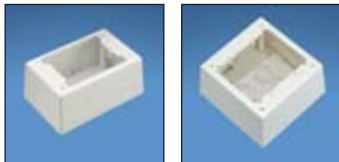

JBP1D

JBP2D

C1. Wiring Duct

C2. Surface Raceway

C3. Abrasion Protection



JBP1E

JBP1I

C4. Cable Management

D1. Terminals



PSJBX

JBD1

D2. Power Connectors

D3. Grounding Connectors



JBP2S

JBD2

E1. Labeling Systems

E2. Labels



JBP2FS

JBP1MR20

E3. Pre-Printed & Write-On Markers

E4. Permanent Identification



JBP1MD20

RJBX3510

E5. Lockout/Tagout & Safety Solutions

F. Index

| Part Number | Part Description | Color† | Std. Pkg. Qty. | Std. Ctn. Qty. |
|-------------------|---|-----------|----------------|----------------|
| JBP1IW | Single gang two-piece screw together outlet box. Box accepts PAN-WAY® Screw-On Faceplates or any NEMA standard single gang faceplate. For use with PAN-WAY® LD profile raceway. 5.19"L x 3.45"W x 1.75"H (131.9mm x 87.7mm x 44.4mm). Breakouts for 1/2", 3/4", or 1" diameter conduit. | Off White | 1 | 10 |
| JBP2IW | Double gang two-piece screw together outlet box. Box accepts PAN-WAY® Screw-On Faceplates or any NEMA standard double gang faceplates. For use with PAN-WAY® LD profile raceway. 5.05"L x 5.05"W x 1.62"H (128.2mm x 128.2mm x 41.1mm). Breakouts for 1/2" or 3/4" diameter conduit. | Off White | 1 | 10 |
| JBP1DIW | Single gang two-piece screw together deep outlet box. Box accepts PAN-WAY® Screw-On Faceplates or any NEMA standard single gang faceplate. For use with PAN-WAY® T-45, LD2P10 (when used with JBD1), or LD profile raceway. 5.19"L x 3.45"W x 2.75"H (131.9mm x 87.7mm x 69.8mm). Breakouts for 1/2", 3/4", or 1" diameter conduit. | Off White | 1 | 10 |
| JBP2DIW | Double gang two-piece screw together deep outlet box. Box accepts PAN-WAY® Screw-On Faceplates or any NEMA standard double gang faceplate. For use with PAN-WAY® T-45 or LD profile raceway. 5.19"L x 5.19"W x 2.75"H (131.9mm x 131.9mm x 69.8mm). Breakouts for 1/2", 3/4", or 1" diameter conduit. | Off White | 1 | 10 |
| JBP1EIW | Single gang two-piece screw together extension outlet box. Box accepts PAN-WAY® Screw-On Faceplates or any NEMA standard single gang faceplate. For use with PAN-WAY® LD profile raceway. 4.99"L x 3.30"W x 1.00"H (126.7mm x 83.8mm x 25.4mm). Breakouts for 1/2", 3/4", or 1" diameter conduit. | Off White | 1 | 10 |
| JBP1IIW | Single gang two-piece screw together intermediate outlet box. Box accepts PAN-WAY® Screw-On Faceplates or any NEMA standard single gang faceplate. For use with PAN-WAY® LD profile raceway. 5.12"L x 3.38"W x 2.27"H (130.2mm x 86.0mm x 57.7mm). Breakouts for 1/2" or 3/4" diameter conduit. | Off White | 1 | 10 |
| PSJBXIW | Single gang two-piece snap together power source box. For use with PAN-WAY® LDPH3, 5, 10, or LDS3, or 5 profile raceway. 5.02"L x 3.32"W x 1.31"H (127.6mm x 83.0mm x 33.3mm). Breakouts for 1/2", 3/4", or 1" diameter conduit. | Off White | 1 | 10 |
| JBD1 | Single gang pass-through divider. Allows power and communication outlets to be routed in series. For use with JBP1 or JBP1D when installing LD2P10 raceway. | Off White | 1 | 10 |
| JBP2SIW | Double gang two-piece screw together divided outlet box. Box accepts PAN-WAY® Screw-On Faceplates or any NEMA standard double gang faceplate. For use with PAN-WAY® T-45 or LD profile raceway. 5.05"L x 5.05"W x 1.62"H (128.2mm x 128.2mm x 41.1mm). Breakouts for 1/2" or 3/4" diameter conduit. | Off White | 1 | 10 |
| JBD2 | Double gang pass-through divider. Allows power and communication outlets to be routed in series. For use with JBP2D when installing LD2P10 raceway. | Off White | 1 | 10 |
| JBP2FSIW | Double gang power rated two-piece snap together outlet box. Box accepts PAN-WAY® Snap-On Faceplates. For use with PAN-WAY® T-45 or LD profile raceway. 5.00"L x 6.14"W x 1.62"H (127.1mm x 155.9mm x 41.1mm). Breakouts for 1/2", 3/4", or 1" diameter conduit. | Off White | 1 | 10 |
| JBP1MR20IW | Single gang two-piece power rated low profile snap together outlet box. Includes 20 A U.S. style rectangular electrical outlet. For use with PAN-WAY® LDPH3, 5, 10 or LDS3 or 5 profile raceway only. 4.84"L x 2.90"W x 1.20"H (122.9mm x 73.6mm x 30.4mm). | Off White | 1 | 10 |
| JBP1MD20IW | Single gang two-piece power rated low profile snap together outlet box. Includes 20 A U.S. style 106 duplex electrical outlet. For use with PAN-WAY® LDPH3, 5, 10 or LDS3 or 5 profile raceway only. 4.84"L x 2.90"W x 1.22"H (122.9mm x 73.6mm x 30.9mm). | Off White | 1 | 10 |
| RJBX3510IW | Single gang two-piece screw together round outlet box. Box accepts UL/CSA devices not to exceed 10 lbs. (5 lbs. per CSA). For use with PAN-WAY® LD profile raceway. Dia. = 5.48"D x 1.14"H (139.2mm x 29.0mm). Breakouts for 3/4" or 1" diameter conduit. | Off White | 1 | 5 |

†For other colors replace IW (Off White) with EI (Electric Ivory), IG (International Gray), or WH (White).



PAN-WAY® Classic Series Faceplates for Power and Communication Applications

• For use with JBP2S or JBP2D outlet boxes

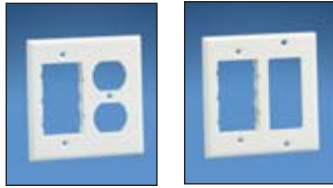

FP2DC

FP2RC

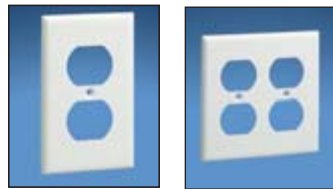

CP106

CP106**-2G

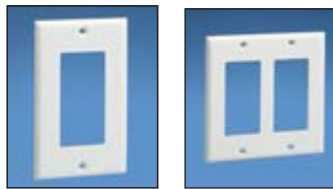

CPGIW

CPGI**-2G



CPN

CPN**-2G

| Part Number | Part Description | Color† | Std. Pkg. Qty. | Std. Ctn. Qty. |
|-------------------|--|-----------|----------------|----------------|
| FP2DCIW | Covers one NEMA standard 106 duplex electrical receptacle and accepts <i>PANDUIT</i> ® <i>MINI-COM</i> ® 1/2-size, 1/3-size, and 2/3-size Inserts. For product application, please reference LD profile raceway section. | Off White | 1 | 10 |
| FP2RCIW | Covers one NEMA standard rectangular electrical receptacle and accepts <i>PANDUIT</i> ® <i>MINI-COM</i> ® 1/2-size, 1/3-size, and 2/3-size Inserts. For product application, please reference LD profile raceway section. | Off White | 1 | 10 |
| CP106IW | Screw-on single gang 106 duplex faceplate. Covers one NEMA standard 106 duplex electrical outlet or one standard 106 communication module frame. | Off White | 1 | 10 |
| CP106IW-2G | Screw-on double gang 106 duplex faceplate. Covers two NEMA standard 106 duplex electrical outlets or two standard 106 communication module frames. | Off White | 1 | 10 |
| CPGIW | Screw-on single gang rectangular faceplate. Covers one NEMA standard rectangular electrical outlet or one standard rectangular communication module frame. | Off White | 1 | 10 |
| CPGIW-2G | Screw-on double gang rectangular faceplate. Covers two NEMA standard rectangular electrical outlets or two standard rectangular communication module frames. | Off White | 1 | 10 |
| CPNIW | Screw-on single gang blank cover faceplate. Can be used with <i>PAN-WAY</i> ® Cove, TG-70, T-70, Twin-70, T-45 Raceway Systems, <i>FAST-SNAP</i> ™ Outlet Boxes and <i>PAN-POLE</i> ™ Aluminum Outlet Pole. Supplied with two mounting screws. | Off White | 1 | 10 |
| CPNIW-2G | Screw-on double gang blank cover faceplate. For use with <i>PAN-WAY</i> ® Surface Mount Outlet Boxes. Supplied with four mounting screws. | Off White | 1 | 10 |

†For other colors replace suffix IW (Off White) with EI (Electric Ivory), IG (International Gray), WH (White), or AL (Almond).

All faceplates supplied with mounting screws.

For complete labeling solutions, reference label chart below.

Component Labels for *PAN-WAY*® Classic Series Faceplates for Power and Communication Applications

| Suggested Label Solutions for TIA/EIA-606-A Compliance | | | | |
|--|-------------------------------------|--|---|---|
| Faceplate Part Number | Laser/Ink Jet Desktop Printer Label | TDP43MY Thermal Transfer Desktop Printer Label | <i>PANTHER</i> ™ LS8E Hand-Held Printer Label | <i>COUGAR</i> ™ LS9 Hand-Held Printer Label |
| CPGIW T70PGS | C125X030FJJ | C125X030YPT | C125X030FJC | T031X000FJC-BK |
| CPGIW-2G FP2RC | 2-C125X030FJJ | 2-C125X030YPT | 2-C125X030FJC | T031X000FJC-BK |
| T70PG | C261X030FJJ | T031X000FJT | C261X030FJC | T031X000FJC-BK |

A. System Overview

B1. Cable Ties

B2. Cable Accessories

B3. Stainless Steel Ties

C1. Wiring Duct

C2. Surface Raceway

C3. Abrasion Protection

C4. Cable Management

D1. Terminals

D2. Power Connectors

D3. Grounding Connectors

E1. Labeling Systems

E2. Labels

E3. Pre-Printed & Write-On Markers

E4. Permanent Identification

E5. Lockout/Tagout & Safety Solutions

F. Index

A. System Overview

UL **SP** **PAN-WAY® Stainless Steel Faceplates**

B1. Cable Ties



WPS-20

WPS-202

B2. Cable Accessories

B3. Stainless Steel Ties

| Part Number | Part Description | Std. Pkg. Qty. | Std. Ctn. Qty. |
|----------------|--|----------------|----------------|
| WPS-20 | Stainless steel single gang 106 duplex screw-on faceplate. Covers one NEMA standard 106 duplex electrical outlet or one standard 106 communication module frame. | 1 | 10 |
| WPS-202 | Stainless steel double gang 106 duplex screw-on faceplate. Covers two NEMA standard 106 duplex electrical outlets or two standard 106 communication module frames. | 1 | 10 |

All faceplates supplied with mounting screws.

C1. Wiring Duct

PAN-WAY® Electrical Outlets

C2. Surface Raceway

• Electrical outlets are standard electrical devices that fit into *PAN-WAY®* Outlet Boxes or any NEMA standard outlet boxes

C3. Abrasion Protection

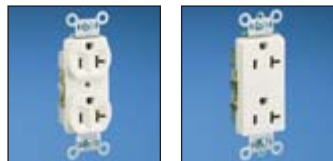

EDU20

ERU20

C4. Cable Management

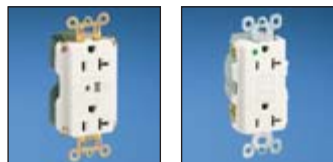

ETU20

EGU20

D1. Terminals

D2. Power Connectors

D3. Grounding Connectors

| Part Number | Part Description | Color‡ | Std. Pkg. Qty. |
|------------------|--|-----------|----------------|
| EDU20IW-X | 20 A specification grade 106 duplex outlet. | Off White | 10 |
| ERU20IW-X | 20 A specification grade rectangular outlet. | Off White | 10 |
| ETU20IW-X | 20 A specification grade TVSS rectangular outlet (transient voltage surge suppressor). | Off White | 10 |
| EGU20IW-X | 20 A specification grade GFCI rectangular outlet (ground fault circuit interrupter). | Off White | 10 |

‡For other colors, replace IW (Off White) with EI (Electric Ivory).
All outlets supplied with mounting screws.

E1. Labeling Systems

UL **SP** **PAN-WAY® Surface Mount Outlet Box with 20 A Electrical Outlet**

• Supplied with a 20 A U.S. style rectangular electrical outlet and a 20A 106 duplex electrical outlet.



JBP1MR20

E2. Labels

E3. Pre-Printed & Write-On Markers

E4. Permanent Identification



JBP1MD20

E5. Lockout/Tagout & Safety Solutions

F. Index

| Part Number | Part Description | Color‡ | Std. Pkg. Qty. | Std. Ctn. Qty. |
|-------------------|--|-----------|----------------|----------------|
| JBP1MR20IW | Single gang two-piece power rated low profile snap together outlet box. Includes 20 A U.S. style rectangular electrical outlet. For use with <i>PAN-WAY®</i> LDPH3, 5, 10 or LDS3 or 5 profile raceway only. 4.84"L x 2.90"W x 1.20"H (122.9mm x 73.6mm x 30.4mm). | Off White | 1 | 10 |
| JBP1MD20IW | Single gang two-piece power rated low profile snap together outlet box. Includes 20 A U.S. style 106 duplex electrical outlet. For use with <i>PAN-WAY®</i> LDPH3, 5, 10 or LDS3 or 5 profile raceway only. 4.84"L x 2.90"W x 1.22"H (122.9mm x 73.6mm x 30.9mm). | Off White | 1 | 10 |

‡For other color replace IW (Off White) with EI (Electric Ivory).

Selection Chart for using *PAN-WAY*® Surface Raceway with *PAN-WAY*® Surface Mount Outlet Boxes

How to use this chart:

1. Locate the desired *PAN-WAY*® Raceway in the left column.
2. Locate the desired *PAN-WAY*® Outlet Box in the top row.
3. Match up the raceway with the outlet box to see if they are compatible (Y = yes, N = no).
4. Select correct surface mount outlet box.

| <i>PAN-WAY</i> ® Surface Mount Outlet Boxes | | | | | | | | | |
|---|------------------------------------|------|-------|----------|---------------|--------------------------|----------------------|-------|---|
| Low Voltage or Fiber Optic ONLY | Power, Low Voltage, or Fiber Optic | | | | | | | | |
| JB1, JB1D JB1FS JBX3510 | RJBX3510 | JBP1 | JBP1D | JBP1E | JBP1J JBP2 | JBP2S JBP2D JBP2FS | JBP1MR20 JBP1MD20 | PSJBX | |
| Type LD (Low Voltage, or Fiber Optic ONLY) | | | | | | | | | |
| LD3 | Y | Y | Y | Y | Y | Y | Y | N | Y |
| LD5 | Y | Y | Y | Y | Y | Y | Y | N | Y |
| LD10 | Y | Y | Y | Y | Y | Y | Y | N | Y |
| Type LDPH (Power, Low Voltage, or Fiber Optic) | | | | | | | | | |
| LDPH3 | Y | Y | Y | Y | Y | Y | Y | Y | Y |
| LDPH5 | Y | Y | Y | Y | Y | Y | Y | Y | Y |
| LDPH10 | Y | Y | Y | Y | Y | Y | Y | Y | Y |
| Type LDS (Power, Low Voltage, or Fiber Optic) | | | | | | | | | |
| LDS3 | Y | Y | Y | Y | Y | Y | Y | Y | Y |
| LDS5 | Y | Y | Y | Y | Y | Y | Y | Y | Y |
| Type LD2P10 (Power, Low Voltage, or Fiber Optic) | | | | | | | | | |
| LD2P10 | N | N | N | Y w/JBD1 | N | N | Y | N | N |
| Type T-45 (Power, Low Voltage, or Fiber Optic) | | | | | | | | | |
| T-45 | Y (JB1FS and JBX3510) | N | N | Y | N | N | Y | N | N |

A.
System
Overview

B1.
Cable Ties

B2.
Cable
Accessories

B3.
Stainless
Steel Ties

C1.
Wiring
Duct

C2.
Surface
Raceway

C3.
Abrasion
Protection

C4.
Cable
Management

D1.
Terminals

D2.
Power
Connectors

D3.
Grounding
Connectors

E1.
Labeling
Systems

E2.
Labels

E3.
Pre-Printed
& Write-On
Markers

E4.
Permanent
Identification

E5.
Lockout/
Tagout/
& Safety
Solutions

F.
Index

A.
System
Overview

B1.
Cable Ties

B2.
Cable
Accessories

B3.
Stainless
Steel Ties

C1.
Wiring
Duct

C2.
Surface
Raceway

C3.
Abrasion
Protection

C4.
Cable
Management

D1.
Terminals

D2.
Power
Connectors

D3.
Grounding
Connectors

E1.
Labeling
Systems

E2.
Labels

E3.
Pre-Printed
& Write-On
Markers

E4.
Permanent
Identification

E5.
Lockout/
Tagout/
& Safety
Solutions

F.
Index

NOTES

PAN-WAY® LD PROFILE NON-METALLIC SURFACE RACEWAY

PAN-WAY® LD Profile Raceway is available in single and multi-channel styles to provide a solution for routing copper, fiber optic, and power cabling along fixed perimeter walls.



- LD2P10 features one-piece multi-channel design for both power and data applications
- LDPH is a tamper resistant two-piece latching surface raceway supplied with pre-applied adhesive backed tape
- LD features one-piece single channel design for data routing
- LDS features one-piece single channel tamper resistant design with maximum security for power OR data applications

PAN-WAY® LD Profile Raceways include a full complement of fittings for standard, bend radius control, power rated and multi-channel use, and transition easily to other PANDUIT raceway such as Cove, TG-70, T-70, Twin-70 and T-45.

A.
System
Overview

B1.
Cable Ties

B2.
Cable
Accessories

B3.
Stainless
Steel Ties

C1.
Wiring
Duct

C2.
Surface
Raceway

C3.
Abrasion
Protection

C4.
Cable
Management

D1.
Terminals

D2.
Power
Connectors

D3.
Grounding
Connectors

E1.
Labeling
Systems

E2.
Labels

E3.
Pre-Printed
& Write-On
Markers

E4.
Permanent
Identification

E5.
Lockout/
Tagout
& Safety
Solutions

F.
Index

A.
System
Overview

LD2P10 Profile Raceway Roadmap

B1.
Cable Ties

B2.
Cable
Accessories

B3.
Stainless
Steel Ties

C1.
Wiring
Duct

C2.
Surface
Raceway

C3.
Abrasion
Protection

C4.
Cable
Management

D1.
Terminals

D2.
Power
Connectors

D3.
Grounding
Connectors

E1.
Labeling
Systems

E2.
Labels

E3.
Pre-Printed
& Write-On
Markers

E4.
Permanent
Identification

E5.
Lockout/
Tagout/
& Safety
Solutions

F.
Index

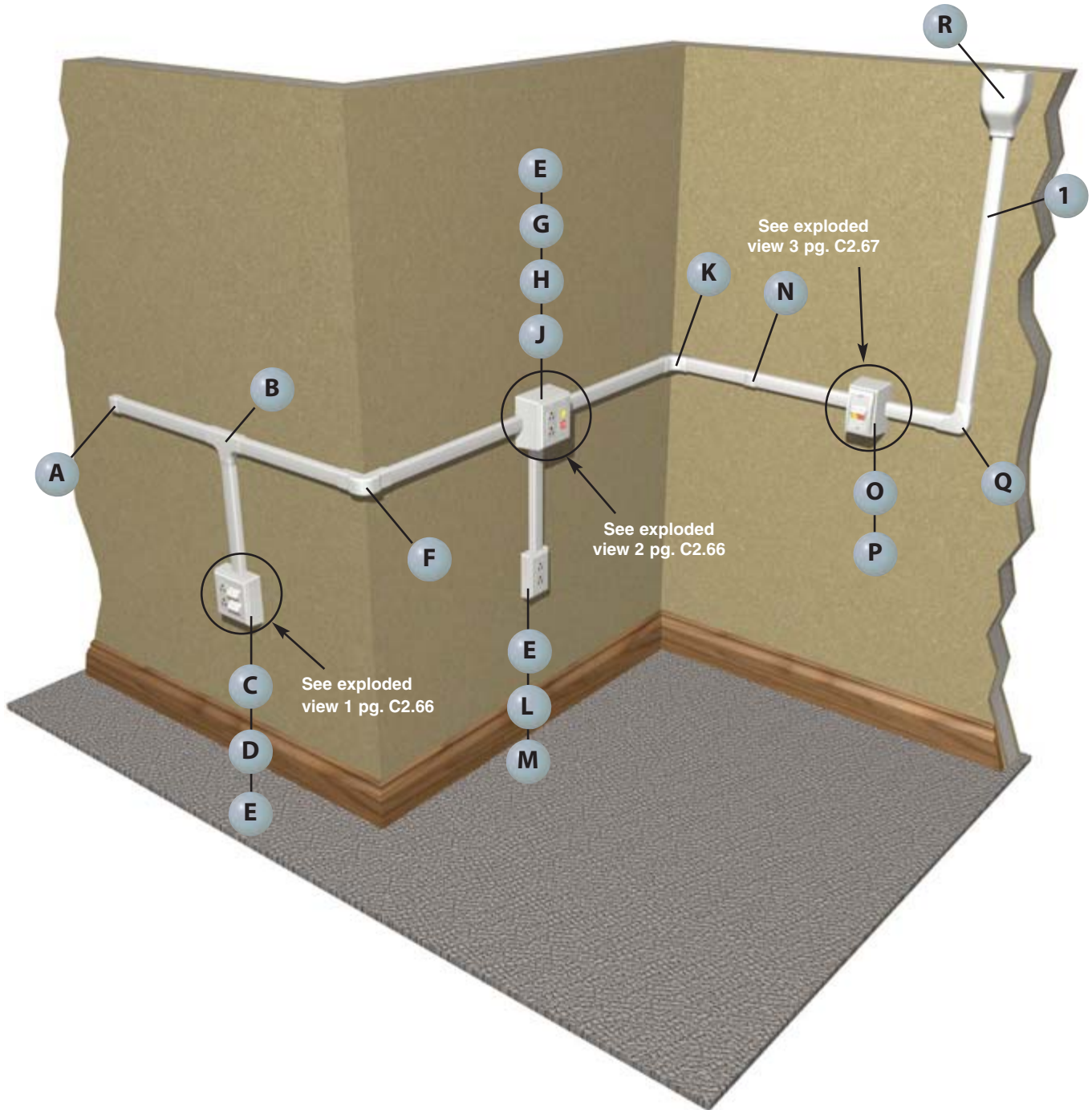

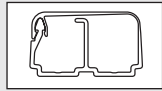

1 LD2P10 – Raceway (page C2.75)

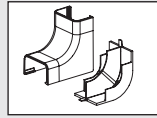

K ICFX10** – Power Rated Inside Corner Fitting (page C2.75)

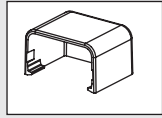

A ECFX10** – Power Rated End Cap Fitting (page C2.75)

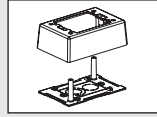

L JBP1** – Power Rated Single Gang Two-Piece Box (page C2.58)

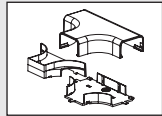

B TFXD10** – 1 Inch Bend Radius Tee Fitting (page C2.75)

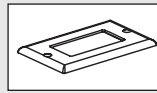

M CPG** – Single Gang Rectangular Screw-On Faceplate (page C2.59)

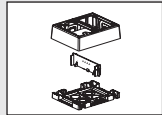

C JBP2S** – Power Rated Double Gang Three-Piece Divided Box (page C2.58)

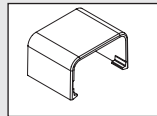

N CFX10** – Power Rated Coupler Fitting (page C2.75)

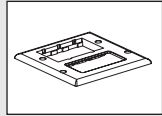

D FP2RC** – Double Gang Rectangular Electrical and Two Communication Insert Faceplate (page C2.59)

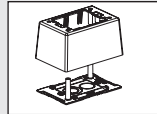

O JBP1D** – Single Gang Two-Piece Deep Box (page C2.58)

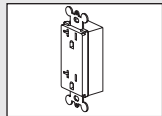

E ERU20** – 20 A Rectangular Electrical Outlet (page C2.60)

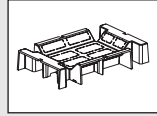

P JBD1 – Single Gang Pass Through Divider for LD2P10 Raceway (page C2.58)

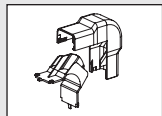

F OCFX10** – 1 Inch Bend Radius Outside Corner Fitting (page C2.75)

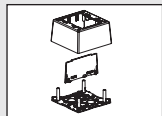

G JBP2D** – Power Rated Double Gang Two-Piece Deep Box (page C2.58)

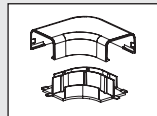

Q RAFX10** – Power Rated Right Angle Fitting (page C2.75)

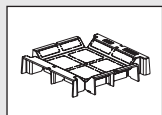

H JBD2 – Double Gang Pass Through and Divider for LD2P10 Raceway (page C2.58)

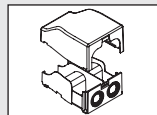

R EEFX** – Power Rated/1 Inch Bend Radius Entrance End Fitting (page C2.75)

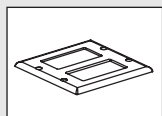

J CPG**-2G – Double Gang Rectangular Screw-On Faceplate (page C2.59)

A. System Overview

B1. Cable Ties

B2. Cable Accessories

B3. Stainless Steel Ties

C1. Wiring Duct

C2. Surface Raceway

C3. Abrasion Protection

C4. Cable Management

D1. Terminals

D2. Power Connectors

D3. Grounding Connectors

E1. Labeling Systems

E2. Labels

E3. Pre-Printed & Write-On Markers

E4. Permanent Identification

E5. Lockout/Tagout & Safety Solutions

F. Index

A.
System
Overview

LD2P10 Configurations

B1.
Cable Ties

Exploded View 1

| | Components Required | See page |
|----|--|----------|
| A. | PANDUIT® <i>MINI-COM</i> ® Modules. | — |
| B. | FP2RC = Double gang rectangular electrical and two communication insert faceplate (screws included). | C2.61 |
| C. | ERU20 = 20 A rectangular electrical outlet (screws included). | C2.62 |
| D. | JBP2S = Power rated double gang three-piece divided box (screws included). | C2.60 |

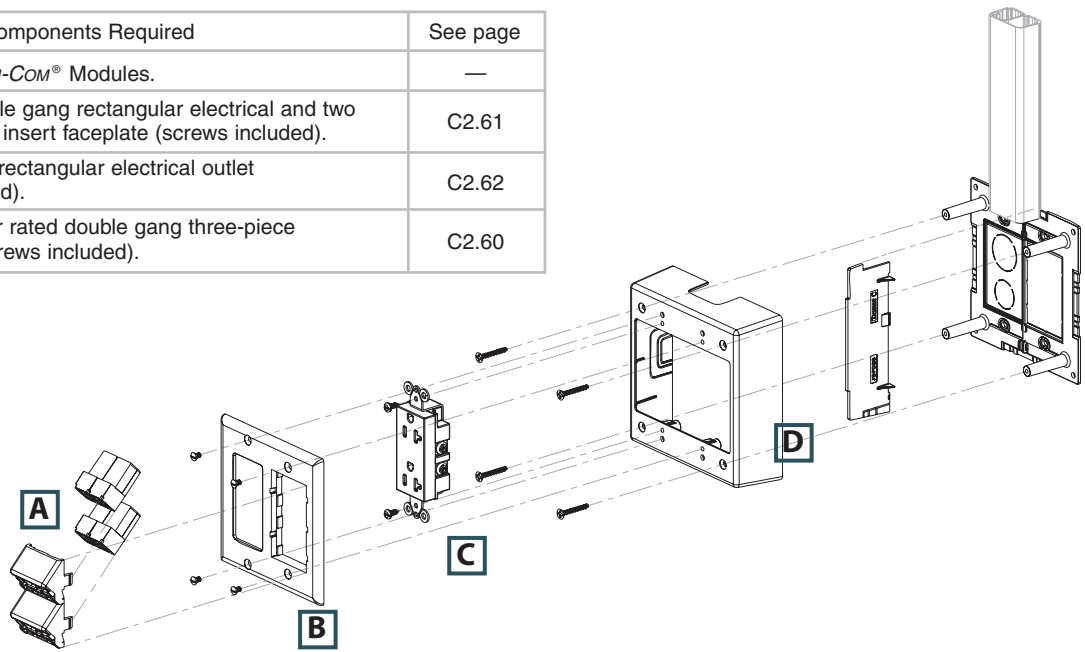

C1.
Wiring
Duct

C2.
Surface
Raceway

C3.
Abrasion
Protection

C4.
Cable
Management

D1.
Terminals

Exploded View 2

| | Components Required | See page |
|----|---|----------|
| A. | JBD2 = Double gang pass-through divider for LD2P10 raceway. | C2.58 |
| B. | JBP2D = Power rated double gang two-piece deep box. | C2.58 |
| C. | ERU20 = 20 A rectangular electrical outlet (screws included). | C2.60 |
| D. | PANDUIT® <i>MINI-COM</i> ® Modules. | — |
| E. | CPG2G = Double gang rectangular screw-on faceplate (screws included). | C2.59 |

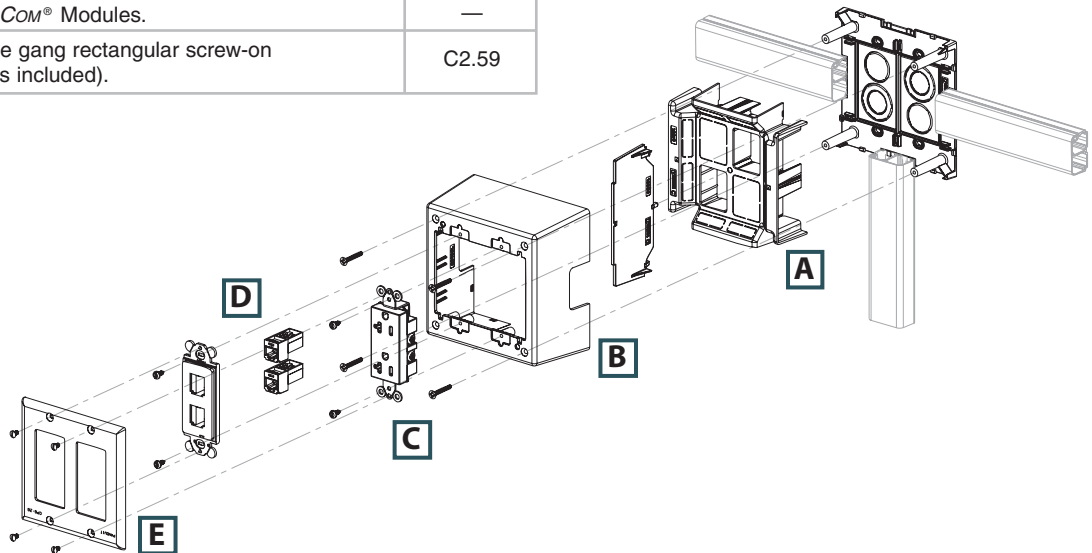

E2.
Labels

E3.
Pre-Printed
& Write-On
Markers

E4.
Permanent
Identification

E5.
Lockout/
Tagout
& Safety
Solutions

F.
Index

LD2P10 Configurations (continued)

Exploded View 3

| | Components Required | See page |
|----|--|----------|
| A. | UICFPSE2 = <i>ULTIMATE ID</i> ® Two-Position Executive Sloped Faceplate. | — |
| B. | <i>MINI-COM</i> ® Modules. | — |
| C. | JBP1D = Power rated single gang two-piece deep box (screws included). | C2.58 |
| D. | JBD1 = Single gang pass-through divider for LD2P10 raceway. | C2.58 |

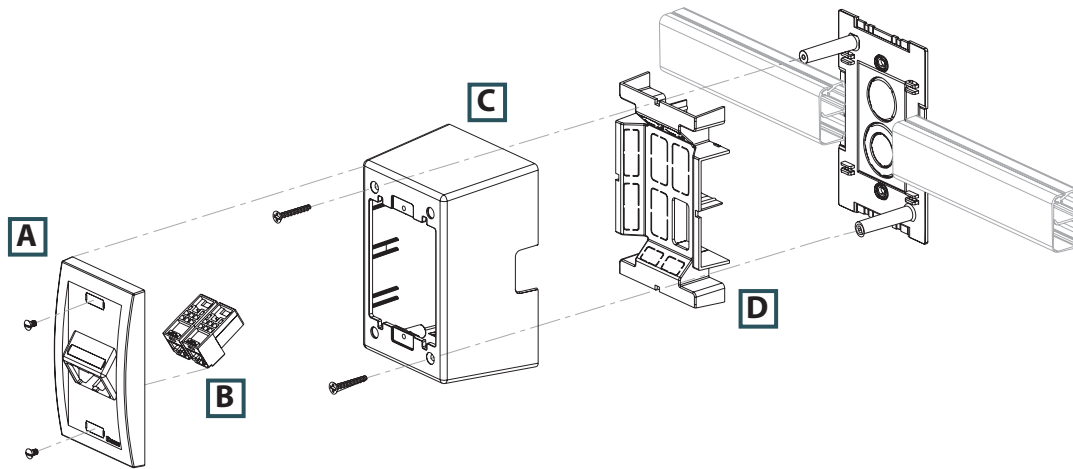

A.
System
Overview

B1.
Cable Ties

B2.
Cable
Accessories

B3.
Stainless
Steel Ties

C1.
Wiring
Duct

C2.
Surface
Raceway

C3.
Abrasion
Protection

C4.
Cable
Management

D1.
Terminals

D2.
Power
Connectors

D3.
Grounding
Connectors

E1.
Labeling
Systems

E2.
Labels

E3.
Pre-Printed
& Write-On
Markers

E4.
Permanent
Identification

E5.
Lockout/
Tagout/
& Safety
Solutions

F.
Index

A.
System
Overview

LD Profile Raceway Roadmap

B1.
Cable Ties

B2.
Cable
Accessories

B3.
Stainless
Steel Ties

C1.
Wiring
Duct

C2.
Surface
Raceway

C3.
Abrasion
Protection

C4.
Cable
Management

D1.
Terminals

D2.
Power
Connectors

D3.
Grounding
Connectors

E1.
Labeling
Systems

E2.
Labels

E3.
Pre-Printed
& Write-On
Markers

E4.
Permanent
Identification

E5.
Lockout/
Tagout/
& Safety
Solutions

F.
Index

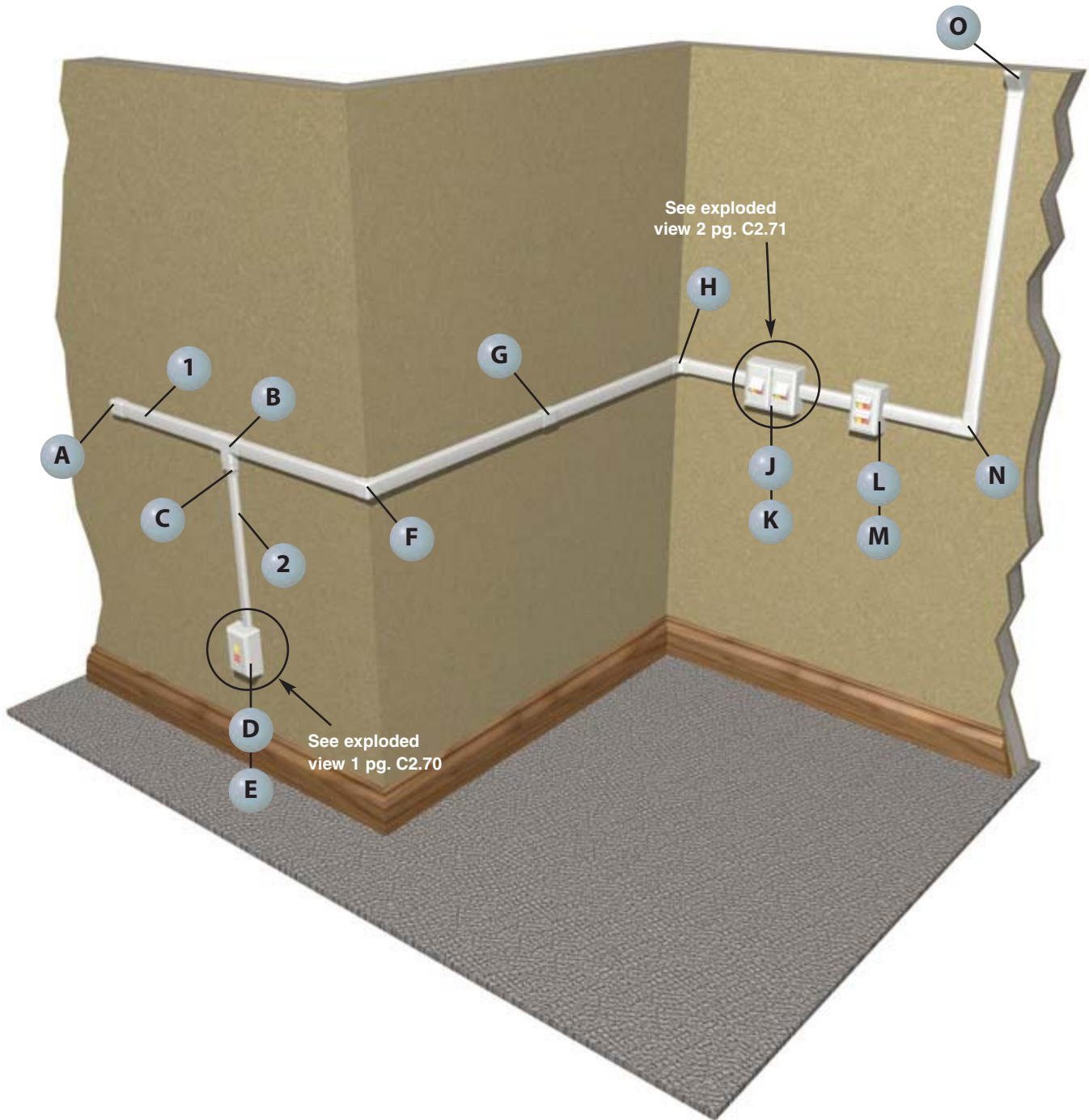

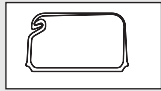

1 LD10 – Raceway (page C2.76)

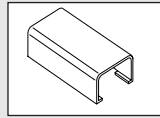

G CF10** – Coupler Fitting (page C2.79)



2 LD5 – Raceway (page C2.76)

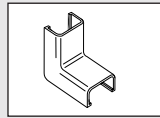

H ICF10** – Inside Corner Fitting (page C2.79)

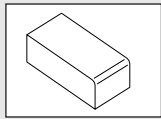

A ECF10** – End Cap Fitting (page C2.79)

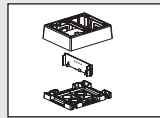

J JBP2FS** – *FAST-SNAP*™ Double Gang Power Rated Surface Mount Outlet Box (page C2.52)

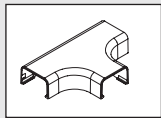

B TF10** – Tee Fitting (page C2.79)

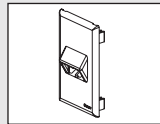

K T70FV2** – Snap-On Vertical Sloped Communication Faceplate (page C2.52)

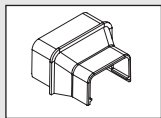

C RF10X5** – Reducer Fitting (page C2.79)

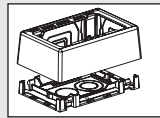

L JB1FS** – *FAST-SNAP*™ Single Gang Surface Mount Outlet Box (page C2.52)

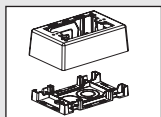

D JBX3510** – Single Gang Two-Piece Snap-Together Box (page C2.57)

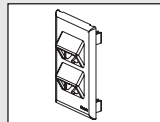

M T70FV4** – Snap-On Vertical Sloped Communication Faceplate (page C2.52)

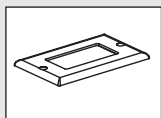

E CPG** – Single Gang Rectangular Screw-On Faceplate (page C2.59)

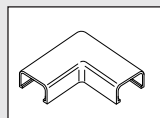

N RAF10** – Right Angle Fitting (page C2.79)

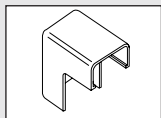

F OCF10** – Outside Corner Fitting (page C2.79)

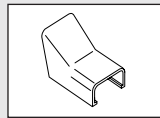

O DCF10** – Drop Ceiling/Entrance End Fitting (page C2.79)

A. System Overview

B1. Cable Ties

B2. Cable Accessories

B3. Stainless Steel Ties

C1. Wiring Duct

C2. Surface Raceway

C3. Abrasion Protection

C4. Cable Management

D1. Terminals

D2. Power Connectors

D3. Grounding Connectors

E1. Labeling Systems

E2. Labels

E3. Pre-Printed & Write-On Markers

E4. Permanent Identification

E5. Lockout/Tagout & Safety Solutions

F. Index

A.
System
Overview

LD Configurations

B1.
Cable Ties

Exploded View 1

B2.
Cable
Accessories

| | Components Required | See page |
|----|---|----------|
| A. | CPG = Single gang rectangular screw-on faceplate (screws included). | C2.59 |
| B. | CFG2 = <i>MINI-COM</i> ® Module Frame – 2-port. | — |
| C. | <i>MINI-COM</i> ® Modules. | — |
| D. | JBX3510 = Single gang two-piece snap together box. | C2.57 |

B3.
Stainless
Steel Ties

C1.
Wiring
Duct

C2.
Surface
Raceway

C3.
Abrasion
Protection

C4.
Cable
Management

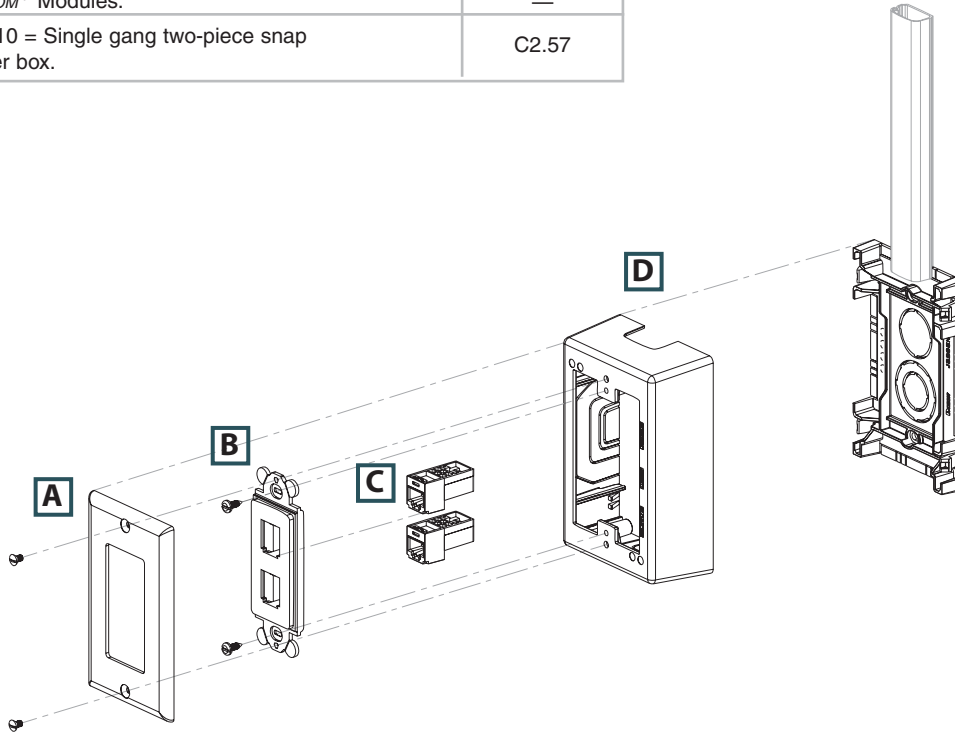

D1.
Terminals

D2.
Power
Connectors

D3.
Grounding
Connectors

E1.
Labeling
Systems

E2.
Labels

E3.
Pre-Printed
& Write-On
Markers

E4.
Permanent
Identification

E5.
Lockout/
Tagout/
& Safety
Solutions

F.
Index

LD Configurations (continued)

Exploded View 2

| | Components Required | See page |
|----|---|----------|
| A. | T70FV2 = Snap-on vertical sloped communication faceplate – 2-port. | C2.52 |
| B. | PANDUIT® MINI-COM® Modules. | — |
| C. | JBP2FS = FAST-SNAP™ double gang power rated surface mount outlet box. | C2.52 |

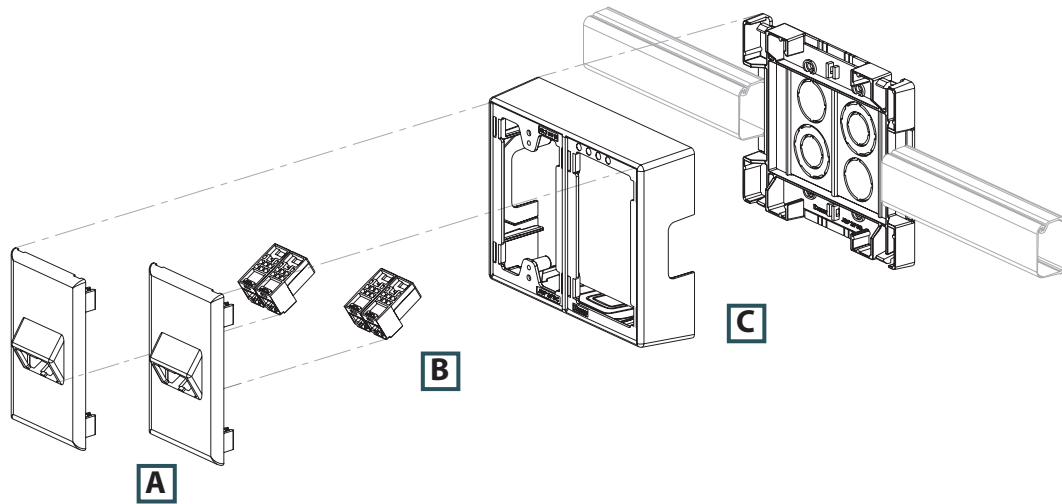

A.
System
Overview

B1.
Cable Ties

B2.
Cable
Accessories

B3.
Stainless
Steel Ties

C1.
Wiring
Duct

C2.
Surface
Raceway

C3.
Abrasion
Protection

C4.
Cable
Management

D1.
Terminals

D2.
Power
Connectors

D3.
Grounding
Connectors

E1.
Labeling
Systems

E2.
Labels

E3.
Pre-Printed
& Write-On
Markers

E4.
Permanent
Identification

E5.
Lockout/
Tagout/
& Safety
Solutions

F.
Index

A.
System
Overview

LDPH Profile Raceway Roadmap

B1.
Cable Ties

B2.
Cable
Accessories

B3.
Stainless
Steel Ties

C1.
Wiring
Duct

C2.
Surface
Raceway

C3.
Abrasion
Protection

C4.
Cable
Management

D1.
Terminals

D2.
Power
Connectors

D3.
Grounding
Connectors

E1.
Labeling
Systems

E2.
Labels

E3.
Pre-Printed
& Write-On
Markers

E4.
Permanent
Identification

E5.
Lockout/
Tagout/
& Safety
Solutions

F.
Index

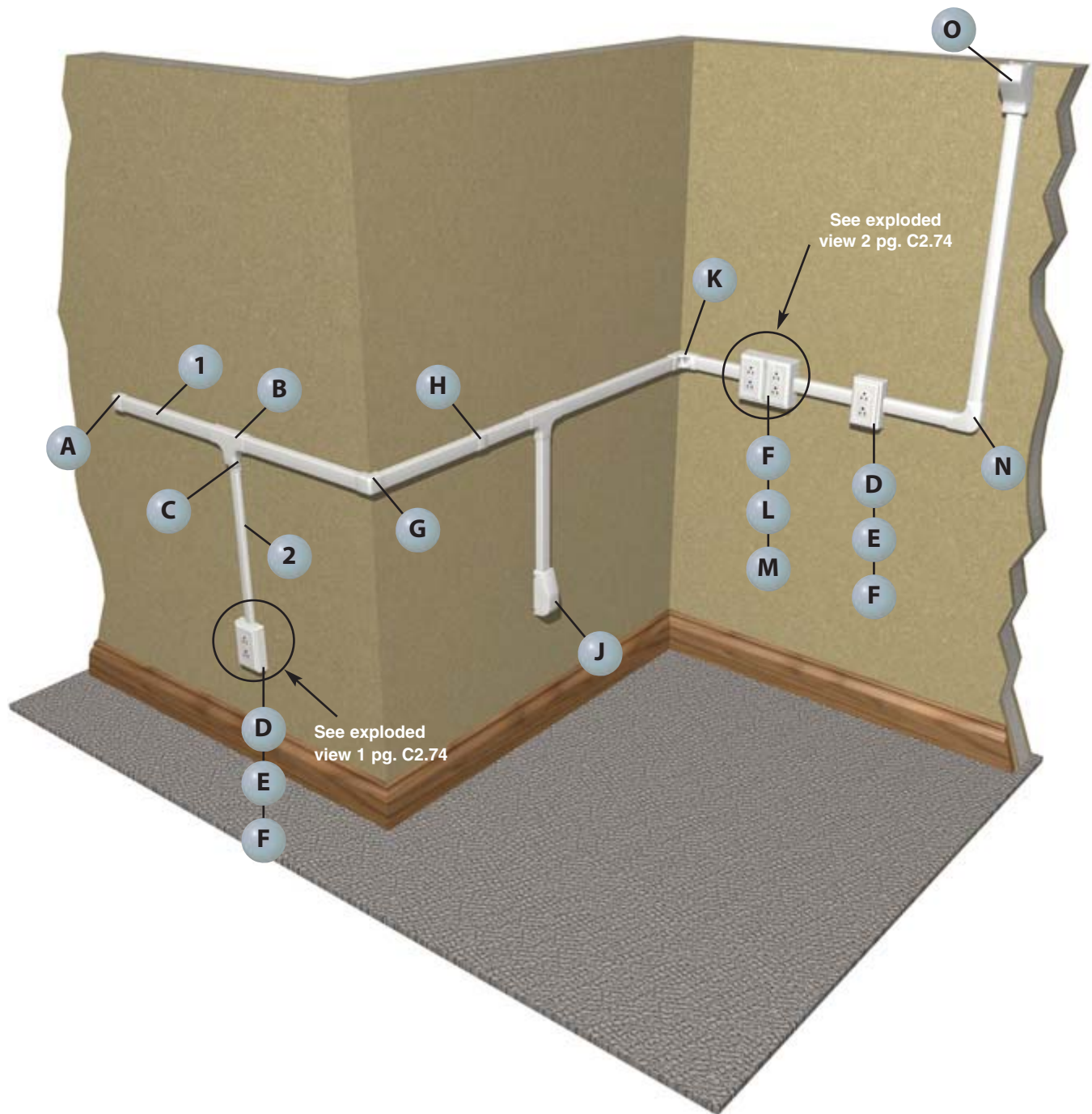

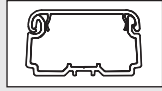

1 LDPH10 – Raceway (page C2.77)

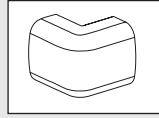

G OCFC10** – Power Rated Outside Corner Fitting (page C2.81)

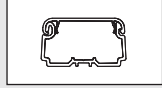

2 LDPH5 – Raceway (page C2.77)

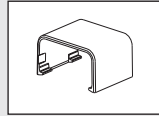

H CFX10** – Power Rated/1 Inch Bend Radius Coupler Fitting (page C2.80)

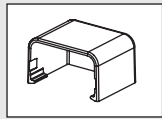

A ECFX10** – Power Rated/1 Inch Bend Radius End Cap Fitting (page C2.80)

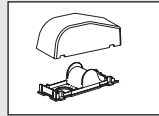

J RAEFX** – Power Rated/1 Inch Bend Radius Right Angle Entrance End Fitting (page C2.81)

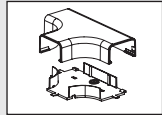

B TFX10** – Power Rated/1 Inch Bend Radius Tee Fitting (page C2.80)

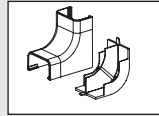

K ICFX10** – Power Rated Inside Corner Fitting (page C2.81)

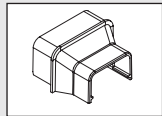

C RFX105** – Power Rated/1 Inch Bend Radius Reducer Fitting (page C2.80)

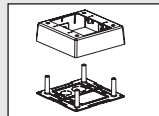

L JBP2** – Power Rated Double Gang Two-Piece Box (page C2.57)

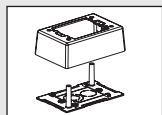

D JBP1** – Power Rated Single Gang Two-Piece Box (page C2.58)

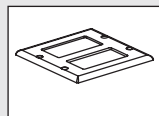

M CPG**-2G – Double Gang Rectangular Screw-On Faceplates (page C2.59)

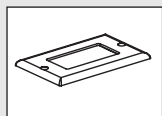

E CPG** – Single Gang Rectangular Screw-On Faceplate (page C2.59)

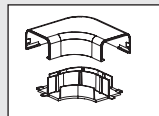

N RAFX10** – Power Rated Right Angle Fitting (page C2.81)

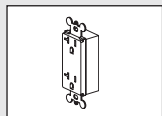

F ERU20** – 20 A Rectangular Electrical Outlet (page C2.60)

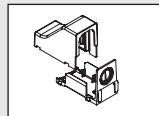

O DCEFX** – Power Rated/1 Inch Bend Radius Drop Ceiling Entrance End Fitting (page C2.80)

A.
System
Overview

B1.
Cable Ties

B2.
Cable
Accessories

B3.
Stainless
Steel Ties

C1.
Wiring
Duct

C2.
Surface
Raceway

C3.
Abrasion
Protection

C4.
Cable
Management

D1.
Terminals

D2.
Power
Connectors

D3.
Grounding
Connectors

E1.
Labeling
Systems

E2.
Labels

E3.
Pre-Printed
& Write-On
Markers

E4.
Permanent
Identification

E5.
Lockout/
Tagout
& Safety
Solutions

F.
Index

A.
System
Overview

LDPH Configurations

B1.
Cable Ties

Exploded View 1

| | Components Required | See page |
|----|---|----------|
| A. | CPG = Single gang rectangular screw-on faceplate (screws included). | C2.59 |
| B. | ERU20 = 20 A rectangular electrical outlet (screws included). | C2.60 |
| C. | JBP1 = Power rated single gang two-piece box (screws included). | C2.58 |

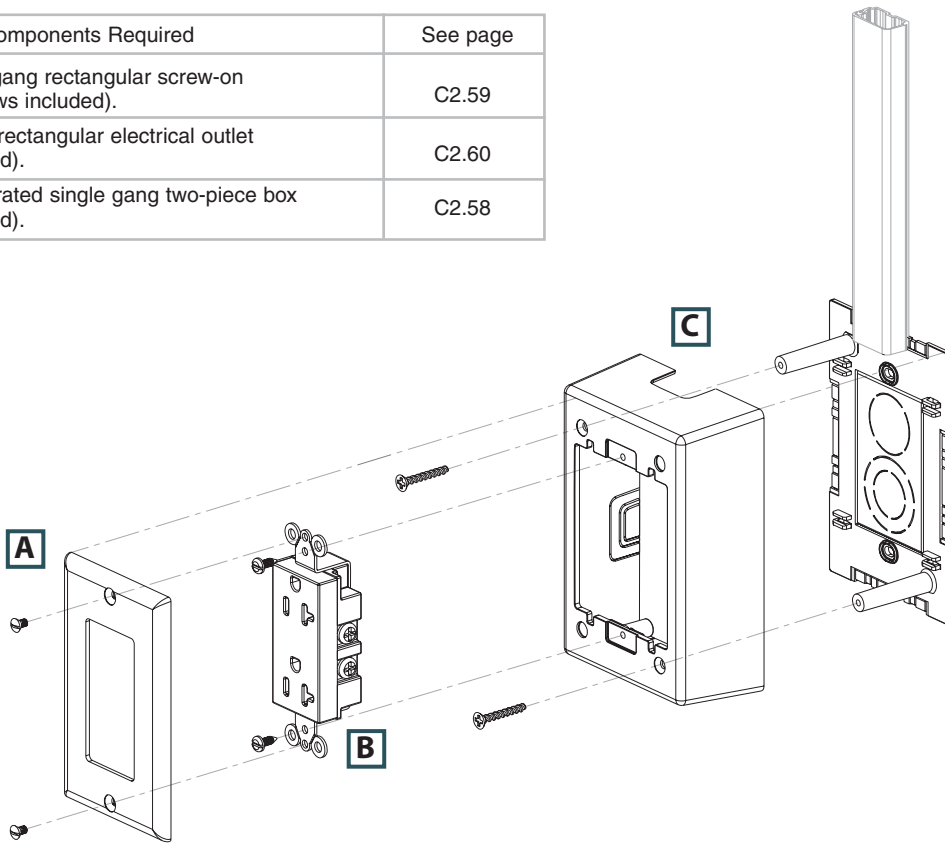

C1.
Wiring
Duct

C2.
Surface
Raceway

C3.
Abrasion
Protection

C4.
Cable
Management

D1.
Terminals

D2.
Power
Connectors

D3.
Grounding
Connectors

E1.
Labeling
Systems

E2.
Labels

E3.
Pre-Printed
& Write-On
Markers

E4.
Permanent
Identification

E5.
Lockout/
Tagout/
& Safety
Solutions

F.
Index

Exploded View 2

| | Components Required | See page |
|----|---|----------|
| A. | CPG**2G = Double gang rectangular screw-on faceplate (screws included). | C2.59 |
| B. | ERU20 = 20 A rectangular electrical outlet (screws included). | C2.60 |
| C. | JBP2 = Power rated double gang three-piece box (screws included). | C2.58 |

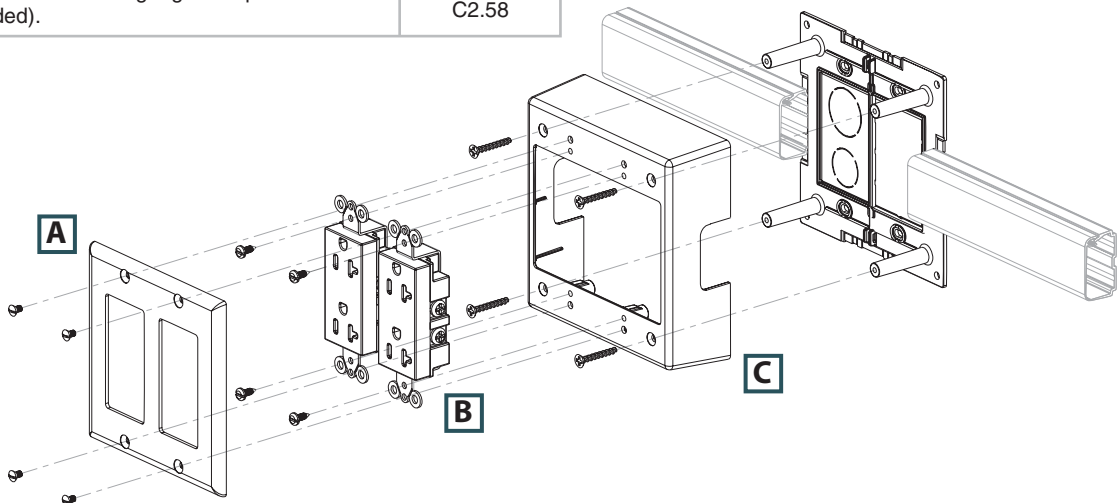



PAN-WAY® Type LD2P10 Multi-Channel Surface Raceway System

- UL and CSA rated 600 V; meets UL 5A and CSA C22.2 No. 62.1-03 standards; FT4 rated
- Routes power and data together
- One-piece hinged design allows cables to be laid in
- Tamper resistant

- Factory applied adhesive backing speeds installation
- Terminates using JBP1D, JBP2D, JBP2FS or JBP2S surface mount outlet box solutions

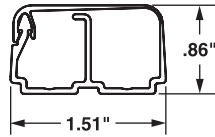

Left Internal Area = .43 Sq. In.
Right Internal Area = .50 Sq. In.



| Part Number | Part Description | Raceway Size | Color‡ | Length (Ft.) | Std. Ctn. Qty. |
|---------------------|---|-------------------|-----------|--------------|----------------|
| LD2P10IW8-A | Two channel tamper resistant one-piece latching surface raceway. Supplied with pre-applied adhesive backed tape. Available in 8' and 10' lengths. | 1.52" x .86" | Off White | 8 | 160 |
| LD2P10IW10-A | | (39.0mm x 22.0mm) | | 10 | 200 |

LD2P raceway requires screw mounting if it is being used for power cabling applications. Order number of feet required in multiples of standard length increments.

‡For other colors replace IW (Off White) with EI (Electric Ivory), IG (International Gray), or WH (White).



Multi-Channel Fittings for LD2P10

- Multi-channel fittings for LD2P10 are designed to maintain the TIA/EIA-568-B and 569-B required minimum bend radius for high performance copper and fiber optic cabling systems



| Part Number | Part Description | Color‡ | Std. Pkg. Qty. |
|-------------------|--|-----------|----------------|
| CFX10IW-X | Coupler fitting for use with LD10, LDPH10, and LD2P10 raceway. | Off White | 10 |
| RAFX10IW-X | Right angle fitting for use with LDPH10 and LD2P10 raceway. | Off White | 10 |
| ICFX10IW-X | Inside corner fitting for use with LDPH10 and LD2P10 raceway. | Off White | 10 |
| OCFX10IW-X | Outside corner fitting for use with LDPH10 and LD2P10 raceway. | Off White | 10 |
| TFXD10IW-X | Tee fitting with divided insert to maintain separation of power and data cabling. For use with LD2P10 raceway. | Off White | 10 |
| ECFX10IW-X | End cap fitting for use with LDPH10 and LD2P10 raceway. | Off White | 10 |
| EEFXIW | Entrance end fitting for LD2P10 raceway. Breakouts for 1/2" and 3/4" diameter conduit. | Off White | 1 |

‡For other colors replace IW (Off White) with EI (Electric Ivory), IG (International Gray), or WH (White).

A. System Overview

B1. Cable Ties

B2. Cable Accessories

B3. Stainless Steel Ties

C1. Wiring Duct

C2. Surface Raceway

C3. Abrasion Protection

C4. Cable Management

D1. Terminals

D2. Power Connectors

D3. Grounding Connectors

E1. Labeling Systems

E2. Labels

E3. Pre-Printed & Write-On Markers

E4. Permanent Identification

E5. Lockout/Tagout & Safety Solutions

F. Index

A. System Overview

PAN-WAY® LD Surface Raceway System

B1. Cable Ties

- For routing data and low voltage cabling
- One-piece hinged design allows cables to be laid in
- Factory applied adhesive backing speeds installation

- FT4 rated
- Terminates using surface mount outlet box solutions or *PANDUIT® MINI-COM®* Surface Mount Boxes

B2. Cable Accessories

B3. Stainless Steel Ties

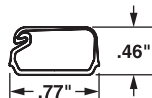

LD3
Internal Area = .21 Sq. In.

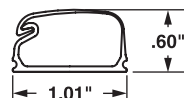

LD5
Internal Area = .38 Sq. In.

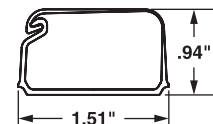

LD10
Internal Area = 1.00 Sq. In.



LD3



LD5



LD10

C1. Wiring Duct

C2. Surface Raceway

C3. Abrasion Protection

C4. Cable Management

D1. Terminals

D2. Power Connectors

D3. Grounding Connectors

E1. Labeling Systems

E2. Labels

E3. Pre-Printed & Write-On Markers

E4. Permanent Identification

E5. Lockout/Tagout & Safety Solutions

F. Index

| Part Number | Part Description | Raceway Size | Color‡ | Length (Ft.) | Std. Ctn. Qty. |
|-------------------------------|---|-----------------------------------|-----------|--------------|----------------|
| LD3 – Surface Raceway | | | | | |
| LD3IW6-A | One-piece latching surface raceway. Supplied with pre-applied adhesive backed tape. Available in 6', 8', and 10' lengths. | .77" x .46" (20.0mm x 12.0mm) | Off White | 6 | 120 |
| LD3IW8-A | | | | 8 | 160 |
| LD3IW10-A | | | | 10 | 200 |
| LD5 – Surface Raceway | | | | | |
| LD5IW6-A | One-piece latching surface raceway. Supplied with pre-applied adhesive backed tape. Available in 6', 8', and 10' lengths. | 1.01" x .58" (26.0mm x 15.0mm) | Off White | 6 | 120 |
| LD5IW8-A | | | | 8 | 160 |
| LD5IW10-A | | | | 10 | 200 |
| LD10 – Surface Raceway | | | | | |
| LD10IW6-A | One-piece latching surface raceway. Supplied with pre-applied adhesive backed tape. Available in 6', 8', and 10' lengths. | 1.51" x .94" (38.4mm x 24.0mm) | Off White | 6 | 120 |
| LD10IW8-A | | | | 8 | 160 |
| LD10IW10-A | | | | 10 | 200 |

‡For other colors replace IW (Off White) with EI (Electric Ivory), IG (International Gray), or WH (White).
Order number of feet required in multiples of standard length increments.

PAN-WAY® LDPH Surface Raceway System

- UL and CSA rated 600 V; meets UL 5A and CSA C22.2 No. 62.1-03 standards; FT4 rated
- Two-piece hinged design allows cables to be laid in
- Tamper resistant

- Factory applied adhesive backing speeds installation
- Terminates using surface mount outlet box solutions or *PANDUIT® MINI-COM®* Surface Mount Boxes

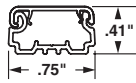

LDPH3
Internal Area = .17 Sq. In.

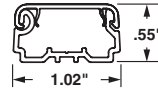

LDPH5
Internal Area = .33 Sq. In.

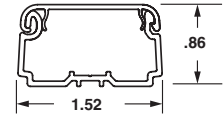

LDPH10
Internal Area = .89 Sq. In.



LDPH3



LDPH5



LDPH10

| Part Number | Part Description | Raceway Size | Color‡ | Length (Ft.) | Std. Ctn. Qty. |
|---------------------------------|---|-----------------------------------|-----------|--------------|----------------|
| LDPH3 – Surface Raceway | | | | | |
| LDPH3IW8-A | Tamper resistant one-piece latching surface raceway. Supplied with pre-applied adhesive backed tape. Available in 8' and 10' lengths. | .75" x .41" (20.0mm x 10.4mm) | Off White | 8 | 160 |
| LDPH3IW10-A | | | | 10 | 200 |
| LDPH5 – Surface Raceway | | | | | |
| LDPH5IW8-A | Tamper resistant one-piece latching surface raceway. Supplied with pre-applied adhesive backed tape. Available in 8' and 10' lengths. | 1.02" x .55" (26.0mm x 14.0mm) | Off White | 8 | 160 |
| LDPH5IW10-A | | | | 10 | 200 |
| LDPH10 – Surface Raceway | | | | | |
| LDPH10IW8-A | Tamper resistant two-piece latching surface raceway. Supplied with pre-applied adhesive backed tape. Available in 8' and 10' lengths. | 1.52" x .86" (39.0mm x 22.0mm) | Off White | 8 | 160 |
| LDPH10IW10-A | | | | 10 | 200 |

LDPH raceway requires screw mounting for power cabling applications.

Order number of feet required in multiples of standard length increments.

‡For other colors replace IW (Off White) with EI (Electric Ivory), IG (International Gray), or WH (White).

A.
System
Overview

B1.
Cable Ties

B2.
Cable
Accessories

B3.
Stainless
Steel Ties

C1.
Wiring
Duct

C2.
Surface
Raceway

C3.
Abrasion
Protection

C4.
Cable
Management

D1.
Terminals

D2.
Power
Connectors

D3.
Grounding
Connectors

E1.
Labeling
Systems

E2.
Labels

E3.
Pre-Printed
& Write-On
Markers

E4.
Permanent
Identification

E5.
Lockout/
Tagout/
& Safety
Solutions

F.
Index

A. System Overview



PAN-WAY® LDS Surface Raceway System

B1. Cable Ties

• UL and CSA rated 600 V; meets UL 5A and CSA C22.2 No. 62.1-03 standards; FT4 rated

• Tamper resistant non-hinged design

• Factory applied adhesive backing speeds installation

• Type LDS is **the only non-metallic raceway that is bendable** in low voltage applications to route around and over obstructions

• LDS raceway requires screw mounting using the LMD mounting straps for power cabling installations

• Terminates using surface mount outlet box solutions or *PANDUIT® MINI-COM®* Surface Mount Boxes

B2. Cable Accessories

B3. Stainless Steel Ties

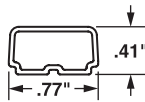

LDS3
Internal Area = .21 Sq. In.

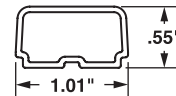

LDS5
Internal Area = .38 Sq. In.

C1. Wiring Duct



LDS3

C2. Surface Raceway



LDS5

C3. Abrasion Protection

C4. Cable Management



LMD3
LMD5

| Part Number | Part Description | Raceway Size | Color‡ | Length (Ft.) | Std. Ctn. Qty. |
|-------------|------------------|--------------|--------|--------------|----------------|
|-------------|------------------|--------------|--------|--------------|----------------|

LDS3 – Surface Raceway

| | | | | | |
|-------------------|---|----------------------------------|-----------|----|-----|
| LDS3IW10-A | Tamper resistant one-piece surface raceway. Supplied with pre-applied adhesive backed tape. Available in 10' lengths. | .77" x .41" (20.0mm x 10.4mm) | Off White | 10 | 200 |
|-------------------|---|----------------------------------|-----------|----|-----|

LDS5 – Surface Raceway

| | | | | | |
|-------------------|---|-----------------------------------|-----------|----|-----|
| LDS5IW10-A | Tamper resistant one-piece surface raceway. Supplied with pre-applied adhesive backed tape. Available in 10' lengths. | 1.01" x .55" (26.0mm x 14.0mm) | Off White | 10 | 200 |
|-------------------|---|-----------------------------------|-----------|----|-----|

Mounting Straps

| | | | | | |
|-----------------|----------------------------|--------|-----------|---|-----|
| LMD3IW-Q | For use with LDS3 raceway. | Size 3 | Off White | — | 100 |
| LMD5IW-Q | For use with LDS5 raceway. | Size 5 | Off White | — | 100 |

‡For other colors replace IW (Off White) with EI (Electric Ivory), IG (International Gray), or WH (White). Order number of feet required in multiples of standard length increments.

D1. Terminals

D2. Power Connectors

D3. Grounding Connectors

E1. Labeling Systems

E2. Labels

E3. Pre-Printed & Write-On Markers

E4. Permanent Identification

E5. Lockout/Tagout & Safety Solutions

F. Index

Method for Bending Type LDS Raceway (Low Voltage Applications)



1) Slide 18" to 30" section of LDS Raceway into PVC pipe heating blanket.
*(Recommended blanket designed for bending 1/2" to 1 1/2" PVC conduit.)



2) Allow section to heat approximately 2 – 3 minutes. Raceway will be soft and pliable, but should not stretch. (Time will vary with blanket temperature and raceway size.)



3) Remove raceway section from blanket and hold in desired position until the raceway cools. Install mounting straps immediately.

*Heating blanket not offered by *PANDUIT*.

Standard Fittings for Low Voltage Applications

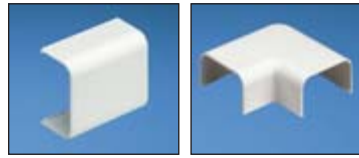

CF

RAF

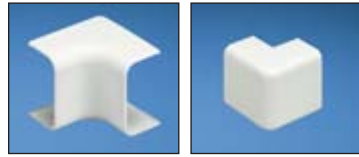

ICF

OCF

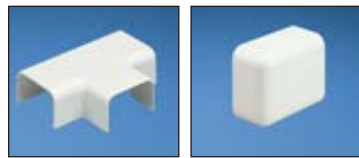

TF

ECF



CRFC

DCF

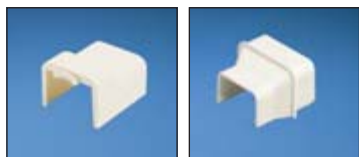

FBA

RF

| Part Number | Part Description | Color‡ | Std. Pkg. Qty. |
|-------------------|--|-----------|----------------|
| CF3IW-E | Coupler fitting for use with LD3 raceway. | Off White | 20 |
| CF5IW-E | Coupler fitting for use with LD5 raceway. | Off White | 20 |
| CF10IW-X | Coupler fitting for use with LD10 raceway. | Off White | 10 |
| RAF3IW-E | Right angle fitting for use with LD3 raceway. | Off White | 20 |
| RAF5IW-E | Right angle fitting for use with LD5 raceway. | Off White | 20 |
| RAF10IW-X | Right angle fitting for use with LD10 raceway. | Off White | 10 |
| ICF3IW-E | Inside corner fitting for use with LD3 raceway. | Off White | 20 |
| ICF5IW-E | Inside corner fitting for use with LD5 raceway. | Off White | 20 |
| ICF10IW-X | Inside corner fitting for use with LD10 raceway. | Off White | 10 |
| OCF3IW-E | Outside corner fitting for use with LD3 raceway. | Off White | 20 |
| OCF5IW-E | Outside corner fitting for use with LD5 raceway. | Off White | 20 |
| OCF10IW-X | Outside corner fitting for use with LD10 raceway. | Off White | 10 |
| TF3IW-E | Tee fitting for use with LD3 raceway. | Off White | 20 |
| TF5IW-E | Tee fitting for use with LD5 raceway. | Off White | 20 |
| TF10IW-X | Tee fitting for use with LD10 raceway. | Off White | 10 |
| ECF3IW-E | End cap fitting for use with LD3 raceway. | Off White | — |
| ECF5IW-E | End cap fitting for use with LD5 raceway. | Off White | — |
| ECF10IW-X | End cap fitting for use with LD10 raceway. | Off White | — |
| CRFC5IW-X | 4-way cross fitting for use with LD5, LDPH5, and LDS5 raceway. | Off White | 10 |
| DCF3IW-X | Drop ceiling/entrance end fitting for use with LD3 raceway. | Off White | 10 |
| DCF5IW-X | Drop ceiling/entrance end fitting for use with LD5 raceway. | Off White | 10 |
| DCF10IW-X | Drop ceiling/entrance end fitting for use with LD10 raceway. | Off White | 10 |
| FBA5IW-X | Fire box adapter for use with LD5/LDPH5 profile raceway. Note: For low voltage applications only. | Off White | 10 |
| FBA10IW-X | Fire box adapter for use with LD10/LDPH10 profile raceway. Note: For low voltage applications only. | Off White | 10 |
| RF5X3IW-E | Reducer fitting for LD raceway from size 5 to size 3. For use with LD5 and LD3 raceway. For in-line terminations, use with CF5**. | Off White | 20 |
| RF10X3IW-X | Reducer fitting for LD raceway from size 10 to size 3. For use with LD3 and LD10 raceway. For in-line terminations, use with CF10**. | Off White | 10 |
| RF10X5IW-X | Reducer fitting for LD raceway from size 10 to size 5. For use with LD5 and LD10 raceway. For in-line terminations, use with CF10**. | Off White | 10 |

‡For other colors replace IW (Off White) with EI (Electric Ivory), IG (International Gray), or WH (White).

A. System Overview



One Inch Bend Radius Fittings for TIA/EIA Compliance

B1. Cable Ties

- 1 inch bend radius fittings are designed to maintain the TIA/EIA-568-B and 569-B required minimum bend radius for high performance copper and fiber optic cabling systems

B2. Cable Accessories



CFX

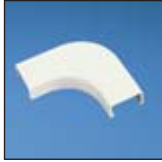

RAFC

B3. Stainless Steel Ties

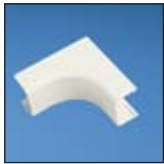

ICFC



OCFX

| Part Number | Part Description | Color‡ | Std. Pkg. Qty. |
|-------------------|---|-----------|----------------|
| CFX3IW-X | Coupler fitting for use with LD3, LDPH3, and LDS3 raceway. | Off White | 10 |
| CFX5IW-X | Coupler fitting for use with LD5, LDPH5, and LDS5 raceway. | Off White | 10 |
| CFX10IW-X | Coupler fitting for use with LD10, LDPH10, and LD2P10 raceway. | Off White | 10 |
| RAFC3IW-X | Right angle fitting for use with LD3, LDPH3, and LDS3 raceway. | Off White | 10 |
| RAFC5IW-X | Right angle fitting for use with LD5, LDPH5, and LDS5 raceway. | Off White | 10 |
| RAFC10IW-X | Right angle fitting for use with LD10 and LDPH10 raceway. | Off White | 10 |
| ICFC3IW-X | Inside corner fitting for use with LD3, LDPH3, and LDS3 raceway. | Off White | 10 |
| ICFC5IW-X | Inside corner fitting for use with LD5, LDPH5, and LDS5 raceway. | Off White | 10 |
| ICFC10IW-X | Inside corner fitting for use with LD10 and LDPH10 raceway. | Off White | 10 |
| OCFX3IW-X | Outside corner fitting for use with LDPH3 and LDS3 raceway. | Off White | 10 |
| OCFX5IW-X | Outside corner fitting for use with LDPH5 and LDS5 raceway. | Off White | 10 |
| OCFX10IW-X | Outside corner fitting for use with LDPH10 and LD2P10 raceway. | Off White | 10 |
| TFC3IW-X | Tee fitting for use with LD3, LDPH3, and LDS3 raceway. | Off White | 10 |
| TFC5IW-X | Tee fitting for use with LD5, LDPH5, and LDS5 raceway. | Off White | 10 |
| TFC10IW-X | Tee fitting for use with LD10 and LDPH10 raceway. | Off White | 10 |
| CRFC5IW-X | 4-way cross fitting for use with LD5, LDPH5, and LDS5 raceway. | Off White | 10 |
| ECFX3IW-X | End cap fitting for use with LDPH3 and LDS3 raceway. | Off White | 10 |
| ECFX5IW-X | End cap fitting for use with LDPH5 and LDS5 raceway. | Off White | 10 |
| ECFX10IW-X | End cap fitting for use with LDPH10 and LD2P10 raceway. | Off White | 10 |
| DCEFXIW-X | Drop ceiling/entrance end fitting for use with LD3, LDPH3, LDS3, LD5, LDPH5, LDS5, LD10 and LDPH10 raceway. Use CA3 or CA5 adapters for LD3 or LD5 profile raceway. | Off White | 10 |
| RAEFXIW-X | Right angle/entrance end fitting for use with LD3, LDPH3, LDS3, LD5, LDPH5, LDS5, LD10 and LDPH10 raceway. CA3 or CA5 adapters for LD3 or LD5 profile raceway. | Off White | 10 |
| RFX53IW-X | Reducer fitting for use with LD3, LDPH3, LDS3, LD5, LDPH5 and LDS5 raceway. For in-line terminations, use with CFX5**. | Off White | 10 |
| RFX103IW-X | Reducer fitting for use with LD3, LDPH3, LD10 and LDPH10 raceway. For in-line terminations, use with CFX10**. | Off White | 10 |
| RFX105IW-X | Reducer fitting for use with LD5, LDPH5, LDS5, LD10 and LDPH10 raceway. For in-line terminations, use with CFX10**. | Off White | 10 |

‡For other colors replace IW (Off White) with EI (Electric Ivory), IG (International Gray), or WH (White).

C1. Wiring Duct

C2. Surface Raceway

C3. Abrasion Protection

C4. Cable Management



TFC



CRFC5



ECFX



DCEFX

D1. Terminals

D2. Power Connectors

D3. Grounding Connectors



RAEFX



RFX

E1. Labeling Systems

E2. Labels

E3. Pre-Printed & Write-On Markers

E4. Permanent Identification

E5. Lockout/Tagout & Safety Solutions

F. Index



Power Rated Fittings for Power to 600 V – LDPH/LDS/LD2P Raceway Only



CFX



RAFX



ICFX



OCFC



TFX



CRFX



CEFX



ECFX



DCEFX



RAEFX



RFX

| Part Number | Part Description | Color‡ | Std. Pkg. Qty. |
|-------------------|--|-----------|----------------|
| CFX3IW-X | Coupler fitting for use with LD3, LDPH3, and LDS3 raceway. | Off White | 10 |
| CFX5IW-X | Coupler fitting for use with LD5, LDPH5, and LDS5 raceway. | Off White | 10 |
| CFX10IW-X | Coupler fitting for use with LD10, LDPH10, and LD2P10 raceway. | Off White | 10 |
| RAFX3IW-X | Right angle fitting for use with LDPH3 and LDS3 raceway. | Off White | 10 |
| RAFX5IW-X | Right angle fitting for use with LDPH5 and LDS5 raceway. | Off White | 10 |
| RAFX10IW-X | Right angle fitting for use with LDPH10 and LD2P10 raceway. | Off White | 10 |
| ICFX3IW-X | Inside corner fitting for use with LDPH3 and LDS3 raceway. | Off White | 10 |
| ICFX5IW-X | Inside corner fitting for use with LDPH5 and LDS5 raceway. | Off White | 10 |
| ICFX10IW-X | Inside corner fitting for use with LDPH10 and LD2P10 raceway. | Off White | 10 |
| OCFC3IW-X | Outside corner fitting for use with LDPH3 and LDS3 raceway. | Off White | 10 |
| OCFC5IW-X | Outside corner fitting for use with LDPH5 and LDS5 raceway. | Off White | 10 |
| OCFC10IW-X | Outside corner fitting for use with LDPH10 raceway only. | Off White | 10 |
| TFX3IW-X | Tee fitting for use with LDPH3 and LDS3 raceway. | Off White | 10 |
| TFX5IW-X | Tee fitting for use with LDPH5 and LDS5 raceway. | Off White | 10 |
| TFX10IW-X | Tee fitting for use with LDPH10 raceway only. | Off White | 10 |
| CRFX5IW-X | 4-way cross fitting for use with LD5, LDPH5, and LDS5 raceway. | Off White | 10 |
| CEFXIW-X | Conduit entrance end fitting. This power rated two-piece fitting is designed to accommodate the entrance of 1/2" conduit or align with knockouts on surface mount electrical boxes. For use with LD3/LDPH3 and has breakouts available to work with LD5/LDPH5 and LD10/LDPH10. Cover and base snap together – no hardware is required. | Off White | 10 |
| ECFX3IW-X | End cap fitting for use with LDPH3 and LDS3 raceway. | Off White | 10 |
| ECFX5IW-X | End cap fitting for use with LDPH5 and LDS5 raceway. | Off White | 10 |
| ECFX10IW-X | End cap fitting for use with LDPH10 and LD2P10 raceway. | Off White | 10 |
| DCEFXIW-X | Drop ceiling/entrance end fitting for use with LD3, LDPH3, LDS3, LD5, LDPH5, LDS5, LD10 and LDPH10 raceway. Use CA3 or CA5 adapters for LD3 or LD5 profile raceway. | Off White | 10 |
| RAEFXIW-X | Right angle/entrance end fitting for use with LD3, LDPH3, LDS3, LD5, LDPH5, LDS5, LD10 and LDPH10 raceway. CA3 or CA5 adapters for LD3 or LD5 profile raceway. | Off White | 10 |
| RFX53IW-X | Reducer fitting for use with LD3, LDPH3, LDS3, LD5, LDPH5 and LDS5 raceway. For in-line terminations, use with CFX5**. | Off White | 10 |
| RFX103IW-X | Reducer fitting for use with LD3, LDPH3, LD10 and LDPH10 raceway. For in-line terminations, use with CFX10**. | Off White | 10 |
| RFX105IW-X | Reducer fitting for use with LD5, LDPH5, LDS5, LD10 and LDPH10 raceway. For in-line terminations, use with CFX10**. | Off White | 10 |

‡For other colors replace IW (Off White) with EI (Electric Ivory), IG (International Gray), or WH (White).

A. System Overview

B1. Cable Ties

B2. Cable Accessories

B3. Stainless Steel Ties

C1. Wiring Duct

C2. Surface Raceway

C3. Abrasion Protection

C4. Cable Management

D1. Terminals

D2. Power Connectors

D3. Grounding Connectors

E1. Labeling Systems

E2. Labels

E3. Pre-Printed & Write-On Markers

E4. Permanent Identification

E5. Lockout/Tagout & Safety Solutions

F. Index

A. System Overview

Raceway Adapters for LD Raceway

- Fit into universal breakout of DCEFX or RAEFX fittings
- For use with types LD3, LDPH3, LDS3, LD5, LDPH5 and LDS5 raceway

B1. Cable Ties

B2. Cable Accessories



CA3
CA5

B3. Stainless Steel Ties

C1. Wiring Duct

C2. Surface Raceway

C3. Abrasion Protection

C4. Cable Management

| Part Number | Part Description | Color‡ | Std. Pkg. Qty. | Std. Ctn. Qty. |
|----------------|--|-----------|----------------|----------------|
| CA3IW-X | Adapter fits into universal breakout of DCEFX or RAEFX fittings. For use LD3, LDPH3, and LDS3 raceway. | Off White | 10 | 50 |
| CA5IW-X | Adapter fits into universal breakout of DCEFX or RAEFX fittings. For use LD5, LDPH5, and LDS5 raceway. | Off White | 10 | 50 |

‡For other colors replace IW (Off White) with EI (Electric Ivory), IG (International Gray), or WH (White).

D1. Terminals

D2. Power Connectors

D3. Grounding Connectors

Cable Fill Capacities for LD Profile Raceway

This information is to be used as a guide in selecting the proper size raceway. The maximum amounts may vary according to the cable installation methods, straightness of cables, etc.



| LD3 | LD5 | LD10 |
|----------------------|----------------------|-----------------------|
| .21 in. ² | .38 in. ² | 1.00 in. ² |

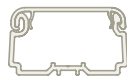

| LDPH3 | LDPH5 | LDPH10 |
|----------------------|----------------------|----------------------|
| .17 in. ² | .33 in. ² | .98 in. ² |

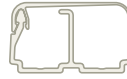

| LD2P10 – Left | LD2P10 – Right |
|----------------------|----------------------|
| .43 in. ² | .50 in. ² |



| LDS3 | LDS5 |
|----------------------|----------------------|
| .21 in. ² | .38 in. ² |

E1. Labeling Systems

E2. Labels

E3. Pre-Printed & Write-On Markers

E4. Permanent Identification

E5. Lockout/Tagout & Safety Solutions

F. Index

SPEC = 40% cable fill – The recommended design in cable capacity, leaves room for future moves, adds, and changes.

MAX for Data = 60% cable fill – The maximum cable quantity based on cable interweaving and packing factors.

MAX for Power cable fill – The maximum of electrical cables based on UL temperature rise test.

| Raceway Type and Configuration | Fill Area (In. ²) | Electrical Cables | | | Data Grade Cables | | Data Grade Cables | | Audio/Video | | Fiber Optic Cable | |
|--------------------------------|-------------------------------|-------------------|--------|--------|--------------------|-----|----------------------|-----|--------------|-----|-------------------|-----|
| | | 14 AWG | 12 AWG | 10 AWG | 23/24 AWG/UTP | | 23 AWG/UTP CM | | RG6 | | 2 Strand | |
| | | THHN/T90 | | | Category 6 (4-pr.) | | Augmented Category 6 | | | | | |
| | | 0.111 | 0.130 | 0.164 | Dia. = 0.250 | | Dia. = 0.354 | | Dia. = 0.275 | | Dia. = 0.175 | |
| | | FILL | | | FILL | | FILL | | FILL | | FILL | |
| | | MAX | MAX | MAX | SPEC | MAX | SPEC | MAX | SPEC | MAX | SPEC | MAX |
| LD3 | 0.21 | — | — | — | 1 | 2 | 0 | 1 | 1 | 2 | 3 | 5 |
| LD5 | 0.38 | — | — | — | 3 | 4 | 1 | 2 | 2 | 3 | 6 | 9 |
| LD10 | 1.00 | — | — | — | 8 | 12 | 4 | 7 | 6 | 10 | 16 | 24 |
| LDPH3 | 0.17 | 9 | 7 | 4 | 1 | 2 | 0 | 1 | 1 | 1 | 2 | 4 |
| LDPH5 | 0.33 | 14 | 12 | 8 | 2 | 4 | 1 | 2 | 2 | 3 | 5 | 8 |
| LDPH10 | 0.89 | 18 | 18 | 16 | 7 | 10 | 4 | 6 | 5 | 8 | 14 | 22 |
| LD2P10 – Left channel | 0.43 | 14 | 11 | 8 | — | — | — | — | — | — | — | — |
| LD2P10 – Right channel | 0.50 | — | — | — | 4 | 6 | 2 | 3 | 3 | 5 | 8 | 12 |
| LDS3 | 0.21 | 9 | 6 | 4 | 1 | 2 | 0 | 1 | 1 | 2 | 3 | 5 |
| LDS5 | 0.38 | 10 | 8 | 5 | 3 | 4 | 1 | 2 | 2 | 3 | 6 | 9 |

AWG dimensions represent typical outer cable diameter in inches.

Floor Guard

- Accessory to route cables over carpet, concrete, or tile to prevent tripping
- Flexible vinyl material can be easily cut to specific lengths
- Cables route through underside of product



FG1
FG3

| Part Number | Part Description | Color‡ | Std. Pkg. Qty. |
|------------------|---|----------------|----------------|
| FG1EI6-A | Flexible vinyl material used to route cabling over carpet, tile, and concrete. Product available in 6' and 50' rolls. | Electric Ivory | 1 |
| FG1EI50-A | Flexible vinyl material used to route cabling over carpet, tile, and concrete. Product available in 6' and 50' rolls. | Electric Ivory | 30 |
| FG3EI50-A | Flexible vinyl material used to route cabling over carpet, tile, and concrete. Product available in 6' and 50' rolls. | Electric Ivory | 1 |
| FG3EI6S-A | Flexible vinyl material used to route cabling over carpet, tile, and concrete. Product available in 6' and 50' rolls. | Electric Ivory | 30 |

Mounting tape is pre-applied only to FG3 in 6' lengths.

‡For other colors replace EI (Electric Ivory) with BR (Brown), YL (Safety Yellow) or BL (Black).

PAN-WAY® Surface Raceway Cutting Tool



| Part Number | Part Description | Std. Pkg. Qty. | Std. Ctn. Qty. |
|-------------|--|----------------|----------------|
| SRT | Used to cut all LD profile raceway. Leaves a clean burr-free finish on raceway. Can also be used to cut plastic conduit. | 1 | 10 |

A.
System
Overview

B1.
Cable Ties

B2.
Cable
Accessories

B3.
Stainless
Steel Ties

C1.
Wiring
Duct

C2.
Surface
Raceway

C3.
Abrasion
Protection

C4.
Cable
Management

D1.
Terminals

D2.
Power
Connectors

D3.
Grounding
Connectors

E1.
Labeling
Systems

E2.
Labels

E3.
Pre-Printed
& Write-On
Markers

E4.
Permanent
Identification

E5.
Lockout/
Tagout
& Safety
Solutions

F.
Index

A.
System
Overview

Foam Tape

B1.
Cable Ties

• Acrylic foam tape – Recommended for high temperature and outdoor applications (180°F) and exposure to UV light

• Rubber foam tape – Excellent quick tack designed for long term shear loads in indoor applications up to 120°F

B2.
Cable
Accessories



P32W2A2
P32W2R1

B3.
Stainless
Steel Ties

C1.
Wiring
Duct

C2.
Surface
Raceway

C3.
Abrasion
Protection

C4.
Cable
Management

D1.
Terminals

D2.
Power
Connectors

D3.
Grounding
Connectors

E1.
Labeling
Systems

E2.
Labels

E3.
Pre-Printed
& Write-On
Markers

E4.
Permanent
Identification

E5.
Lockout/
Tagout/
& Safety
Solutions

F.
Index

| Part Number | Part Description | Color | Std. Pkg. Qty. | Std. Ctn. Qty. |
|---|--|-------|----------------|----------------|
| 1/32" Thick White Acrylic Adhesive | | | | |
| P32W2A2-50-7 | Foam tape, 1/32" (thick) x .50" (wide) x 7 yards, acrylic adhesive. | White | 1 | 100 |
| P32W2A2-75-7 | Foam tape, 1/32" (thick) x .75" (wide) x 7 yards, acrylic adhesive. | White | 1 | 60 |
| P32W2A2-100-7 | Foam tape, 1/32" (thick) x 1" (wide) x 7 yards, acrylic adhesive. | White | 1 | 50 |
| P32W2A2-50-72 | Foam tape, 1/32" (thick) x .50" (wide) x 72 yards, acrylic adhesive. | White | 1 | 9 |
| P32W2A2-75-72 | Foam tape, 1/32" (thick) x .75" (wide) x 72 yards, acrylic adhesive. | White | 1 | 7 |
| P32W2A2-100-72 | Foam tape, 1/32" (thick) x 1" (wide) x 72 yards, acrylic adhesive. | White | 1 | 5 |
| 1/32" Thick White Rubber Adhesive | | | | |
| P32W2R1-50-7 | Foam tape, 1/32" (thick) x .50" (wide) x 7 yards, rubber adhesive. | White | 1 | 100 |
| P32W2R1-75-7 | Foam tape, 1/32" (thick) x .75" (wide) x 7 yards, rubber adhesive. | White | 1 | 60 |
| P32W2R1-100-7 | Foam tape, 1/32" (thick) x 1" (wide) x 7 yards, rubber adhesive. | White | 1 | 50 |
| P32W2R1-50-72 | Foam tape, 1/32" (thick) x .50" (wide) x 72 yards, rubber adhesive. | White | 1 | 9 |
| P32W2R1-75-72 | Foam tape, 1/32" (thick) x .75" (wide) x 72 yards, rubber adhesive. | White | 1 | 7 |
| P32W2R1-100-72 | Foam tape, 1/32" (thick) x 1" (wide) x 72 yards, rubber adhesive. | White | 1 | 5 |
| P32W2R1-150-72 | Foam tape, 1/32" (thick) x 1.5" (wide) x 72 yards, rubber adhesive. | White | 1 | 4 |

PAN-WAY® COVE RACEWAY

PAN-WAY® Cove Raceway is a full line of NEC and TIA/EIA compliant raceway, which has the appearance of architectural molding; that allows you to route, conceal, protect and terminate copper, voice, video, fiber optic or power cabling. This offering adds elegance to any room or work area by softening the horizontal angles between the wall and ceiling or the vertical angles between two walls.



- UL and CSA rated 600 V
- Bend radius control is maintained throughout the entire system as required by TIA/EIA-568-B and 569-B
- Product mounts high out of reach for increased tamper resistance
- Divided channel system allows for routing and terminations of both power and data cabling
- Raceway and fitting covers may be painted to match any décor



PAN-WAY® Cove Raceway includes a full complement of fittings and transitions easily to other PANDUIT raceway such as LD, LDPH, LD2P10, T-45 and T-70.

A.
System
Overview

B1.
Cable Ties

B2.
Cable
Accessories

B3.
Stainless
Steel Ties

C1.
Wiring
Duct

C2.
Surface
Raceway

C3.
Abrasion
Protection

C4.
Cable
Management

D1.
Terminals

D2.
Power
Connectors

D3.
Grounding
Connectors

E1.
Labeling
Systems

E2.
Labels

E3.
Pre-Printed
& Write-On
Markers

E4.
Permanent
Identification

E5.
Lockout/
Tagout
& Safety
Solutions

F.
Index

Cove Raceway Roadmap

A.
System
Overview

B1.
Cable Ties

B2.
Cable
Accessories

B3.
Stainless
Steel Ties

C1.
Wiring
Duct

C2.
Surface
Raceway

C3.
Abrasion
Protection

C4.
Cable
Management

D1.
Terminals

D2.
Power
Connectors

D3.
Grounding
Connectors

E1.
Labeling
Systems

E2.
Labels

E3.
Pre-Printed
& Write-On
Markers

E4.
Permanent
Identification

E5.
Lockout/
Tagout/
& Safety
Solutions

F.
Index

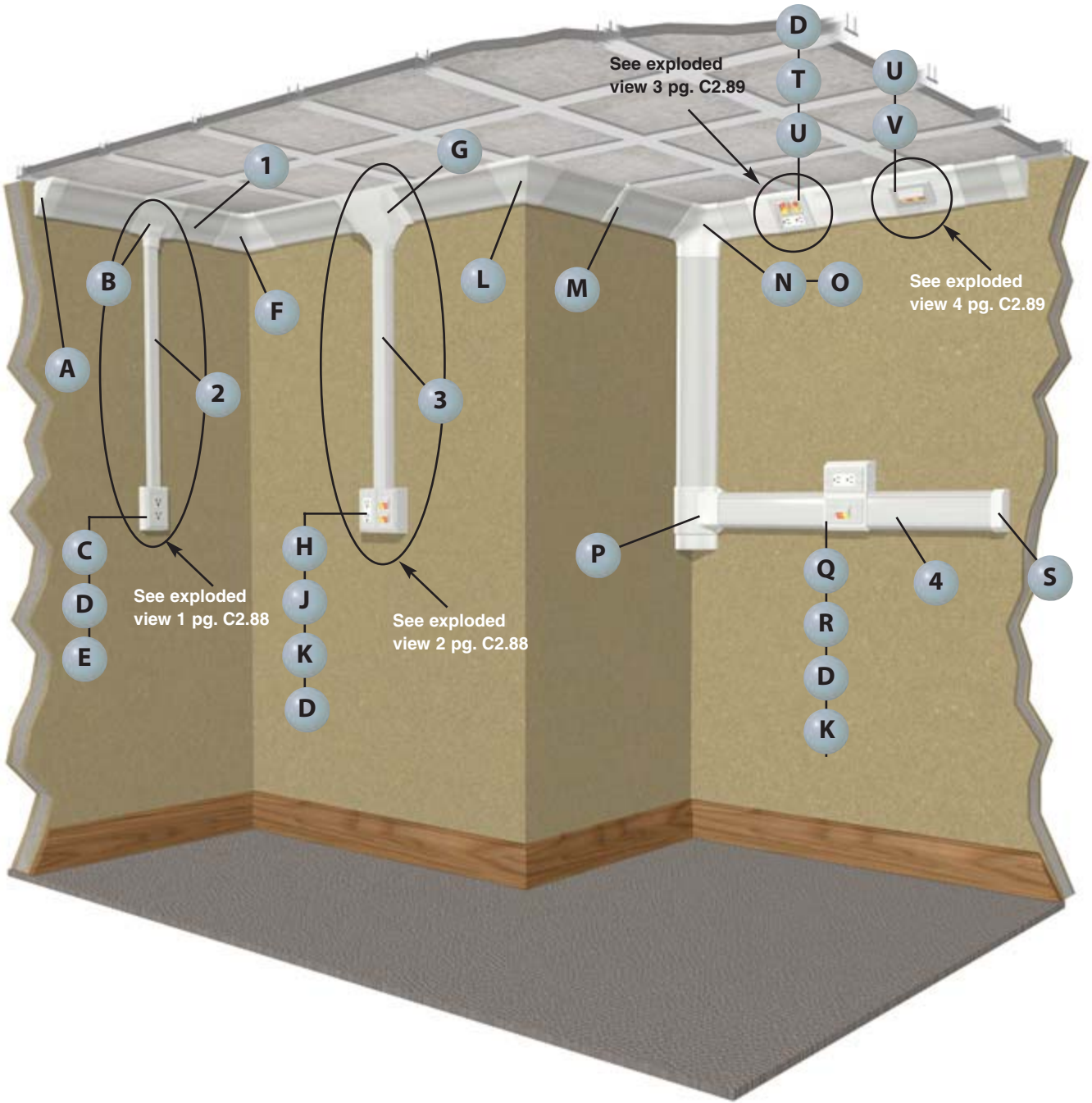

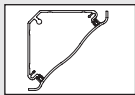

1 WCM35BIW, WCM35CIW – Cove Raceway Base and Cover (page C2.90)

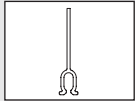

1 WCM35DW – Cove Raceway Divider Wall (page C2.90)

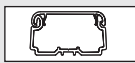

2 LDPH10** – LDPH10 Raceway (page C2.77)

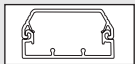

3 T45B**, T45C** – T-45 Raceway Base and Cover (page C2.48)

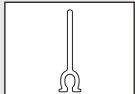

3 T45DW – T-45 Raceway Divider Wall (page C2.48)

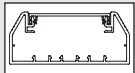

4 T70B**, T70C** – T-70 Raceway Base and Cover (page C2.37)

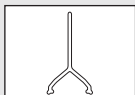

4 T70DW – T-70 Raceway Divider Wall (page C2.37)

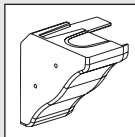

A WCM35ECIW – Cove Raceway End Cap (page C2.91)

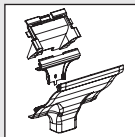

B WCM35TR10IW – Cove Raceway Low Profile Transition Fitting for LD/LDPH10 Raceway (page C2.91)

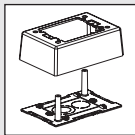

C JBP1** – Power Rated Single Gang Two-Piece Box (page C2.58)

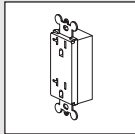

D ERU20** – 20 A Rectangular Outlet (page C2.60)

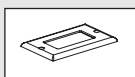

E CPG** – Single Gang Rectangular Electrical/Communication Screw-On Faceplate (page C2.59)

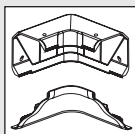

F WCM35ICIW – Cove Raceway Inside Corner Fitting (page C2.91)



G WCM35TRIW – Cove Raceway Transition Fitting for T-45 and LD Series Raceways (page C2.91)

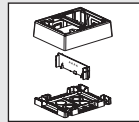

H JBP2FS** – FAST-SNAP™ Double Gang Power Rated Surface Mount Outlet Box (page C2.52)

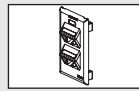

J UIT70FV4** – ULTIMATE ID® Sloped Vertical Snap-On Faceplate

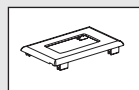

K T70PG** – Single Gang Rectangular Electrical/Communication Snap-On Faceplate (page C2.53)



L WCM35OCIW – Cove Raceway Outside Corner Fitting (page C2.91)



M WCM35CCIW – Cove Raceway Cover Coupler Fitting (page C2.91)

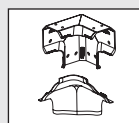

N WCM35TIW – Cove Raceway Tee Fitting (page C2.91)

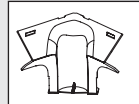

O WCM35TI – Cove Raceway Tee Fitting Insert (page C2.91)

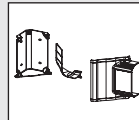

P WCM35TR70IW – Cove Raceway Low Profile Transition Fitting for T-70 Raceway (page C2.91)

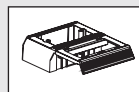

Q T70WC2** – T-70 WORKSTATION OUTLET CENTER™ Offset Box for Snap-On Faceplates (page C2.37)

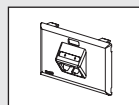

R UIT70FH2** – ULTIMATE ID® Horizontal Snap-On Faceplate



S T70EC** – T70 Raceway End Cap Fitting (page C2.37)

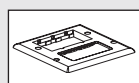

T FP2RC** – Double Gang Rectangular Electrical and Communication Faceplate (page C2.59)

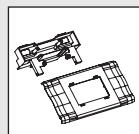

U WCM35DBFIW – Cove Raceway Device Box and Faceplate Adapter (page C2.91)

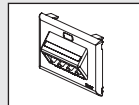

V UIT70FH4** – ULTIMATE ID® Horizontal Snap-On Faceplate

A.
System
Overview

Cove Configurations

B1.
Cable Ties

Exploded View 1

| | Components Required | See page |
|----|---|----------|
| A. | WCM35TR10 = Cove raceway low profile transition fitting for LD/LDP10 raceway. | C2.91 |
| B. | JBP1 = Power rated single gang two-piece box. | C2.58 |
| C. | ERU20 = 20 A rectangular electrical outlet (screws included). | C2.60 |
| D. | CPG = Screw-on single gang rectangular faceplate. | C2.59 |

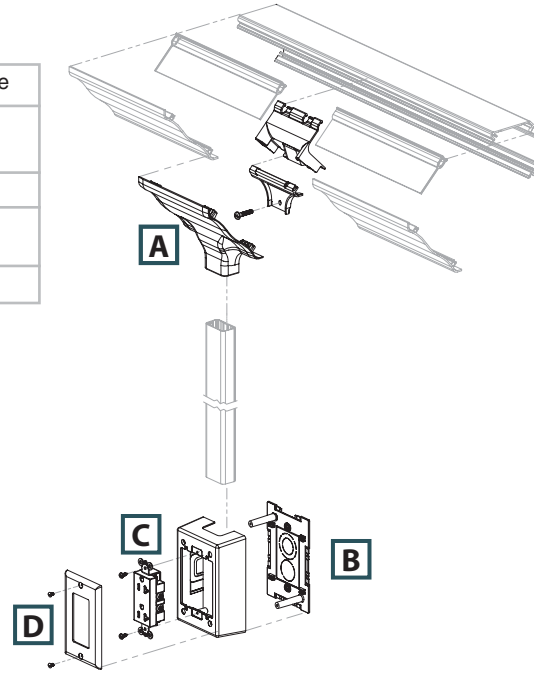

C1.
Wiring
Duct

C2.
Surface
Raceway

C3.
Abrasion
Protection

C4.
Cable
Management

Exploded View 2

| | Components Required | See page |
|----|--|----------|
| A. | WCM35TR = Cove raceway transition fitting. | C2.91 |
| B. | JBP2FS = <i>FAST-SNAP™</i> Double Gang Power Rated Surface Mount Outlet Box. | C2.52 |
| C. | <i>MINI-COM®</i> Modules. | — |
| D. | T70PG = Single gang rectangular electrical/communication snap-on faceplate. | C2.53 |
| E. | UIT70FV4 = <i>ULTIMATE ID®</i> Sloped Vertical Snap-On Faceplate. | — |
| F. | ERU20 = 20 A rectangular electrical outlet (screws included). | C2.60 |

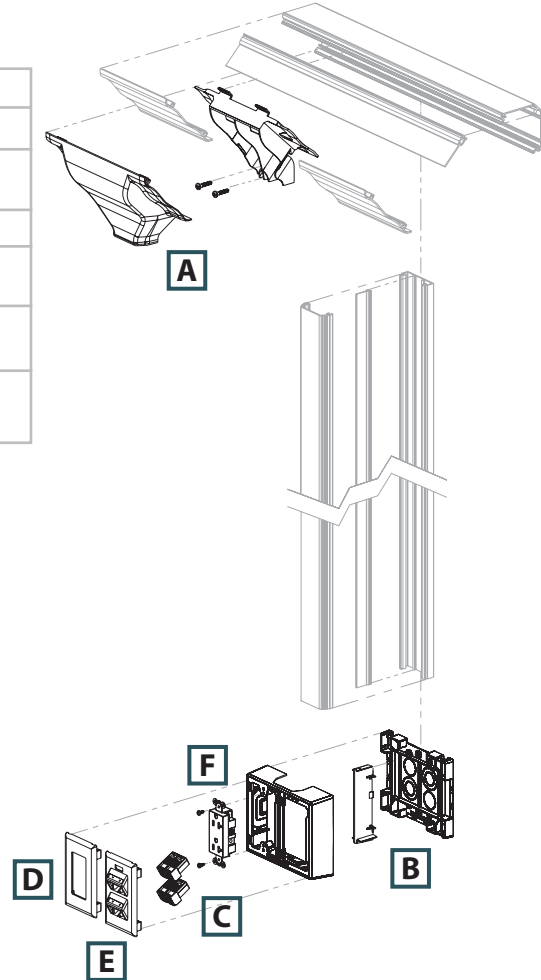

D1.
Terminals

D2.
Power
Connectors

D3.
Grounding
Connectors

E1.
Labeling
Systems

E2.
Labels

E3.
Pre-Printed
& Write-On
Markers

E4.
Permanent
Identification

E5.
Lockout/
Tagout/
& Safety
Solutions

F.
Index

Cove Configurations (continued)

Exploded View 3

| | Components Required | See page |
|----|---|----------|
| A. | WCM35DBF = Cove raceway device box and faceplate adapter. | C2.91 |
| B. | FP2RC = <i>PAN-WAY</i> ® Classic Series Faceplates for power and communication. | C2.59 |
| C. | <i>MINI-COM</i> ® Modules. | — |
| D. | ERU20 = 20 A rectangular electrical outlet (screws included). | C2.6 |

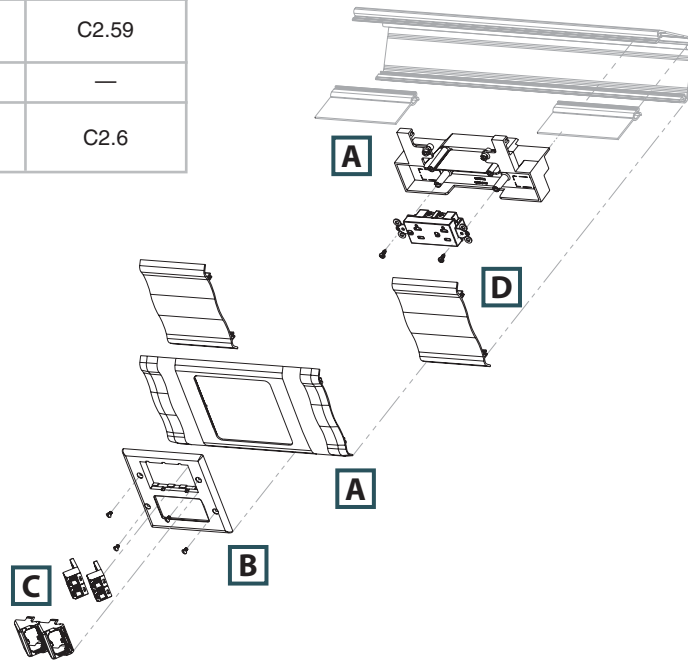

Exploded View 4

| | Components Required | See page |
|----|---|----------|
| A. | WCM35DBF = Cove raceway device box and faceplate adapter. | C2.91 |
| B. | <i>MINI-COM</i> ® Modules. | — |
| C. | UIT70FH4 = <i>ULTIMATE ID</i> ® Horizontal Snap-On Faceplate. | — |

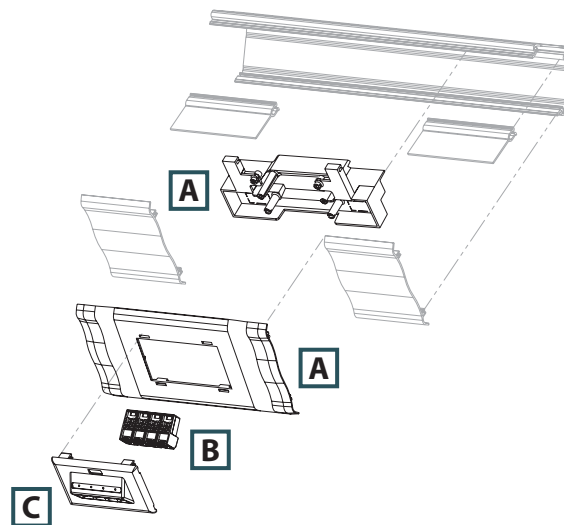

A.
System
Overview

B1.
Cable Ties

B2.
Cable
Accessories

B3.
Stainless
Steel Ties

C1.
Wiring
Duct

C2.
Surface
Raceway

C3.
Abrasion
Protection

C4.
Cable
Management

D1.
Terminals

D2.
Power
Connectors

D3.
Grounding
Connectors

E1.
Labeling
Systems

E2.
Labels

E3.
Pre-Printed
& Write-On
Markers

E4.
Permanent
Identification

E5.
Lockout/
Tagout/
& Safety
Solutions

F.
Index

A. System Overview



PAN-WAY® Cove Raceway System

B1. Cable Ties

- UL and CSA rated 600 V; meets UL 5A and CSA C22.2 No. 62.1-03 standards; FT4 rated
- Bend radius control is maintained throughout the entire cove raceway system as required by TIA/EIA-568-B and 569-B

- Tamper resistant
- Transitions to *PANDUIT* T-70, T-45, and LD profile raceway
- Cove raceway and fittings may be painted to blend with any decor
- Supplied with pre-punched mounting holes

B2. Cable Accessories

B3. Stainless Steel Ties

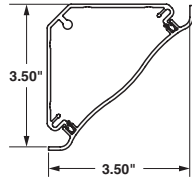

COVE RACEWAY
Internal Area = 5.40 Sq. In.
(3484 Sq. mm)

C1. Wiring Duct

C2. Surface Raceway



WCM35B

C3. Abrasion Protection

C4. Cable Management



WCM35C

D1. Terminals

D2. Power Connectors

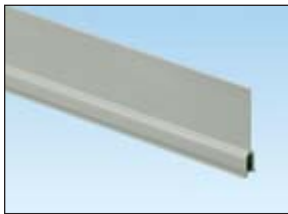

WCM35DW

D3. Grounding Connectors

E1. Labeling Systems

E2. Labels

E3. Pre-Printed & Write-On Markers

E4. Permanent Identification

E5. Lockout/Tagout & Safety Solutions

F. Index







| Part Number | Part Description | Raceway Size | Color† | Length (Ft.) | Std. Ctn. Qty. |
|----------------------------------|---|---------------------------------|-----------|--------------|----------------|
| Cove Raceway Base | | | | | |
| WCM35BIW8 | Cove raceway base is available in 8' lengths and is used for mounting in the horizontal corner between the ceiling and wall or vertical corner between walls. | 3.50" x 3.50" (89.0mm x 89.0mm) | Off White | 8 | 64 |
| Cove Raceway Cover | | | | | |
| WCM35CIW8 | Cove raceway cover available in 8' lengths. | — | Off White | 8 | 64 |
| Cove Raceway Divider Wall | | | | | |
| WCM35DW8 | Cove raceway divider wall. Snaps onto rails in cove raceway base to create separate channels. Must use wire retainers to ensure channel separation per UL/CSA. Available in 8' lengths. | — | Gray | 8 | 64 |

†All parts available in IW (Off White) only except for WCM35DW8 which is available in gray only. Order number of feet required in multiples of standard carton quantity. Order raceway base and cover separately.



PAN-WAY® Cove Raceway Fittings

- Cove raceway fittings are designed to maintain the TIA/EIA-568-B and 569-B required minimum bend radius for high performance copper and fiber optic cabling systems

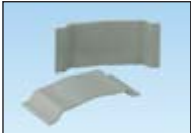
| Part Number | Part Description | Color‡ | Std. Pkg. Qty. | Std. Ctn. Qty. |
|---|---|-------------------|----------------|----------------|
|  <p>WCM35CC WCM35IC</p> | WCM35CCIW-X Cover coupler fittings. Used to join two pieces of cove raceway cover together. | Off White | 10 | 100 |
|  <p>WCM35OC WCM35T</p> | WCM35ICIW Inside corner fitting. Used to join cove raceway at inside corners. Maintains a minimum 1" bend radius of cabling. WCM35OCIW Outside corner fitting. Used to join cove raceway at outside corners. Maintains a minimum 1" bend radius of cabling. | Off White | 1 | 10 |
|  <p>WCM35TI WCM35EC</p> | WCM35TIW Tee fitting. Used to join sections of cove raceway to form a "tee" junction. Maintains a minimum 1" bend radius of cabling. WCM35TI Tee fitting insert. Mounts inside cove raceway tee fitting to maintain channel separation at tee junctions. Maintains a minimum 1" bend radius of cabling. | Off White Gray | 1 | 10 |
|  <p>WCM35TR WCM35TR5</p> | WCM35ECIW End cap fitting. Used to terminate or enter cove raceway. Includes breakouts for 1/2" and 3/4" conduit. WCM35TRIW Transition fitting. Used to transition from cove raceway to PAN-WAY® T-45 raceway or LD profile raceway. | Off White | 1 | 10 |
|  <p>WCM35TR10 WCM35TR70</p> | WCM35TR5IW Low profile transition fitting. Used to transition from cove raceway to LD/LDPH5. WCM35TR10IW Low profile transition fitting. Used to transition from cove raceway to LD/LDPH10. WCM35TR70IW Low profile transition fitting. Used to transition from cove raceway to T-70. | Off White | 1 | 10 |
|  <p>WCM35DBF WCM35BF</p> | WCM35DBFIW Device box and faceplate adapter. Used in cove raceway to install single or double gang power and/or data devices in-line. Will accept snap-on or screw-on single gang faceplate or screw-on double gang faceplate. Note: Will accept GFCI or TVSS outlets in single gang configuration only. WCM35BFIW Backfeed fitting. Inserts allow cable entry and exit through the back of the raceway and conduit. Breakouts include 1/2", 3/4", and 1". | Off White | 1 | 10 |
|  <p>WCM35WR-X</p> | WCM35WR-X Wire retainer. Holds wires in place. Will not interfere with cover installation. | Gray | 10 | — |

‡All parts available in IW (Off White) only except WCM35WR-X and WCM35TI which are available in gray only.

A. System Overview

B1. Cable Ties

B2. Cable Accessories

B3. Stainless Steel Ties

C1. Wiring Duct

C2. Surface Raceway

C3. Abrasion Protection

C4. Cable Management

D1. Terminals

D2. Power Connectors

D3. Grounding Connectors

E1. Labeling Systems

E2. Labels

E3. Pre-Printed & Write-On Markers

E4. Permanent Identification

E5. Lockout/Tagout & Safety Solutions

F. Index

A. System Overview

Cable Fill Capacities for Cove Raceway

This information is to be used as a guide in selecting the proper size raceway. The maximum amounts may vary according to the cable installation methods, straightness of cables, etc.

B1. Cable Ties

B2. Cable Accessories

B3. Stainless Steel Ties

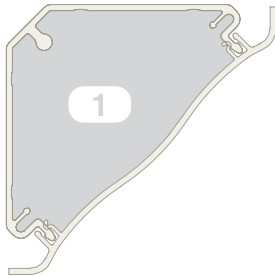

A = 5.4 in.²

Cable fill #1: Open channel without devices.

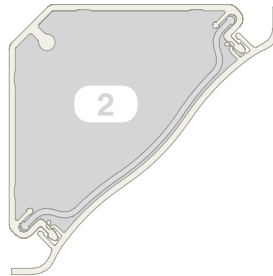

A = 5.0 in.²

Cable fill #2: Open channel with wire retainer.

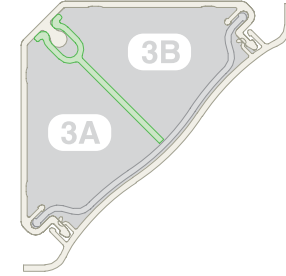

3A = 2.4 in.² 3B = 2.4 in.²

Cable fill #3: Divided channel (power and data) with wire retainer and divider wall.

C2. Surface Raceway

C3. Abrasion Protection

C4. Cable Management

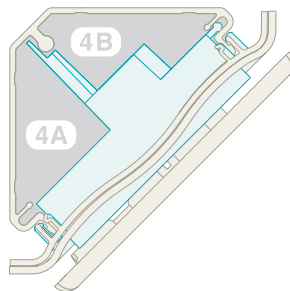

A = 1.6 in.²

A = 1.4 in.²

Cable fill #4: Divided channel (power and data) with device box and faceplate.



A = 1.8 in.²

A = 2.4 in.²

Cable fill #5: Divided channel (power and data) with low profile transition insert.

D1. Terminals

D2. Power Connectors

D3. Grounding Connectors

SPEC = 40% cable fill – The recommended design in cable capacity, leaves room for future moves, adds, and changes.

MAX for Data = 60% cable fill – The maximum cable quantity based on cable interweaving and packing factors.

MAX for Power cable fill – The maximum of electrical cables based on UL temperature rise test.

E1. Labeling Systems

E2. Labels

E3. Pre-Printed & Write-On Markers

E4. Permanent Identification

E5. Lockout/Tagout & Safety Solutions

F. Index

| Raceway Type and Configuration | Fill Area (In. ²) | Electrical Cables | | | Data Grade Cables | Data Grade Cables | Audio/Video | | Fiber Optic Cable | | | |
|---|-------------------------------|-------------------|--------|--------|-------------------|-------------------|--------------|-----|-------------------|-----|--------------|-----|
| | | 14 AWG | 12 AWG | 10 AWG | 24 AWG/UTP CM | 24 AWG/UTP CM | RG6 | | 2 Strand | | | |
| | | THHN/T90 | | | Category 6 | | Category 6A | | Dia. = 0.275 | | Dia. = 0.175 | |
| | | 0.111 | 0.130 | 0.164 | Dia. = 0.250 | | Dia. = 0.330 | | FILL | | FILL | |
| | | MAX | MAX | MAX | SPEC | MAX | SPEC | MAX | SPEC | MAX | SPEC | MAX |
| 1. WCM35: No devices. | 5.4 | 50 | 40 | 30 | 44 | 66 | 25 | 37 | 36 | 54 | 89 | 134 |
| 2. WCM35: Using wire retainer – no devices. | 5 | 50 | 40 | 30 | 40 | 61 | 23 | 35 | 33 | 50 | 83 | 124 |
| 3A. WCM35: Power and data using wire retainer and divider wall. | 2.4 | — | — | — | 19 | 29 | 11 | 16 | 16 | 24 | 39 | 59 |
| 3B. | 2.4 | 30 | 25 | 20 | — | — | — | — | — | — | — | — |
| 4A. WCM35: Power and data using device box and faceplate adapter. | 1.6 | — | — | — | 13 | 19 | 7 | 11 | 10 | 16 | 26 | 39 |
| 4B. | 1.4 | 25 | 25 | 20 | — | — | — | — | — | — | — | — |
| 5A. WCM35: Power and data using low profile transition insert. | 1.8 | 25 | 25 | 20 | — | — | — | — | — | — | — | — |
| 5B. | 2.4 | — | — | — | 20 | 30 | 11 | 17 | 16 | 25 | 41 | 62 |

AWG dimensions represent typical outer cable diameter in inches.

PAN-WAY® OFFICE FURNITURE RACEWAY

PAN-WAY® Office Furniture Raceway is a one-piece single channel system designed to route data cabling along the top of office furniture partitions. Outlets can be positioned at any point along the partition at desk level or in the corner at the intersection of two partitions. Office furniture raceway has a tamper resistant closure design, which protects sensitive cabling from accidental damage and discourages unauthorized access, yet the system is accessible by a qualified installer for moves, adds, and changes.



- Designed for desktop terminations which utilize the typically unused area of the cubicle
- Fittings meet TIA/EIA bend radius requirements preventing cable performance degradation, yet maintain original aesthetic “squared corner” styling of furniture
- Designed to work with major office furniture manufacturer’s panels (such as STEELCASE*, HERMAN MILLER® and others)
- Robust design includes a one-piece hinge and tamper resistant closure design which increases product stability and reduces inadvertent or unauthorized access to data cabling
- Designed for use with PANDUIT connectivity; also accepts common manufacturers’ connectivity with use of a NEMA standard 70mm faceplate or module frame

The system includes a full complement of fittings, accessories, and termination options. PAN-WAY® Office Furniture Raceway is available in four popular colors to blend with most office furniture systems and creates a virtually invisible cost effective routing solution.

*STEELCASE is a registered trademark of Steelcase Development, Inc.

*HERMAN MILLER is a registered trademark of Herman Miller, Inc., Zeeland MI.

A.
System
Overview

B1.
Cable Ties

B2.
Cable
Accessories

B3.
Stainless
Steel Ties

C1.
Wiring
Duct

C2.
Surface
Raceway

C3.
Abrasion
Protection

C4.
Cable
Management

D1.
Terminals

D2.
Power
Connectors

D3.
Grounding
Connectors

E1.
Labeling
Systems

E2.
Labels

E3.
Pre-Printed
& Write-On
Markers

E4.
Permanent
Identification

E5.
Lockout/
Tagout/
& Safety
Solutions

F.
Index

A.
System
Overview

Office Furniture Raceway Roadmap

B1.
Cable Ties

B2.
Cable
Accessories

B3.
Stainless
Steel Ties

C1.
Wiring
Duct

C2.
Surface
Raceway

C3.
Abrasion
Protection

C4.
Cable
Management

D1.
Terminals

D2.
Power
Connectors

D3.
Grounding
Connectors

E1.
Labeling
Systems

E2.
Labels

E3.
Pre-Printed
& Write-On
Markers

E4.
Permanent
Identification

E5.
Lockout/
Tagout/
& Safety
Solutions

F.
Index



Note: Office furniture raceway is designed to blend with its environment. Shown in white on office slate furniture for illustration purposes only.

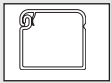

1 OFR20**6 – Office Furniture Raceway
(page C2.98)

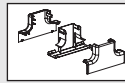

L OFR20MPT** – Mid Panel Tee Fitting
(page C2.100)

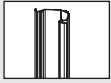

A OFCR70**6 – Corner Raceway Base
(page C2.98)

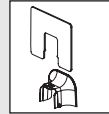

M OFR20WE** – Wall Entrance Fitting
(page C2.100)

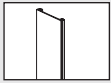

B OFCRC70**6 – Corner Raceway Cover
(page C2.98)

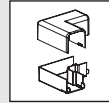

N OFR20RA** – Right Angle Fitting
(page C2.100)

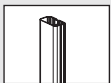

C OFVR5**6 – Vertical Raceway
(page C2.98)

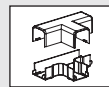

O OFR20T** – Tee Fitting (page C2.100)

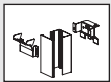

D OFR20CP**8 – Communication Pole
(page C2.99)

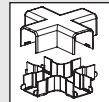

P OFR20CR** – Cross Fitting
(page C2.100)

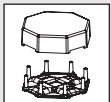

E OFR20OFCR70**4 – Four Cubicle Drop
Fitting (page C2.99)

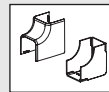

Q OFR20IC** – Inside Corner Fitting
(page C2.101)

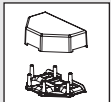

F OFR20OFCR70**2 – Two Cubicle Drop
Fitting (page C2.99)

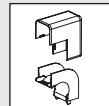

R OFR20OC** – Outside Corner Fitting
(page C2.101)

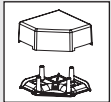

G OFR20OFCR70**1 – One Cubicle Drop
Fitting (page C2.99)



S OFR20CC** – Coupler Fitting
(page C2.101)

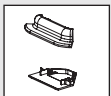

H OFCR70EC** – End Cap Fitting
(page C2.100)

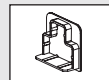

T OFR20EC** – End Cap Fitting
(page C2.101)

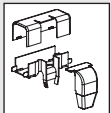

J OFR20SO** – Spill-Over Fitting
(page C2.100)

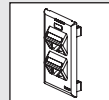

U OF70FV4** – Vertical Sloped
Communication Snap-On Faceplate
(page C2.101)

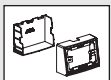

K OFR20DMB** – Desk Mount Box
(page C2.100)

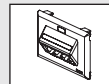

V OF70FH4** – Horizontal Sloped
Communication Snap-On Faceplate
(page C2.101)

A.
System
Overview

Office Furniture Configurations

B1.
Cable Ties

Exploded View 1

B2.
Cable
Accessories

B3.
Stainless
Steel Ties

C1.
Wiring
Duct

C2.
Surface
Raceway

C3.
Abrasion
Protection

C4.
Cable
Management

D1.
Terminals

D2.
Power
Connectors

D3.
Grounding
Connectors

E1.
Labeling
Systems

E2.
Labels

E3.
Pre-Printed
& Write-On
Markers

E4.
Permanent
Identification

E5.
Lockout/
Tagout/
& Safety
Solutions

F.
Index

| | Components Required | See page |
|----|--|----------|
| A. | OFR20OFCR70**4 = Four cubicle drop fitting. | C2.99 |
| B. | OFCR70**6 = Corner raceway base. | C2.98 |
| C. | OFCR70EC = End cap fitting. | C2.100 |
| D. | OF70FV4 = Vertical sloped communication snap-on faceplate. | C2.100 |
| E. | MINI-COM® Modules. | — |
| F. | OFCRC70**6 = Corner raceway cover. | C2.98 |

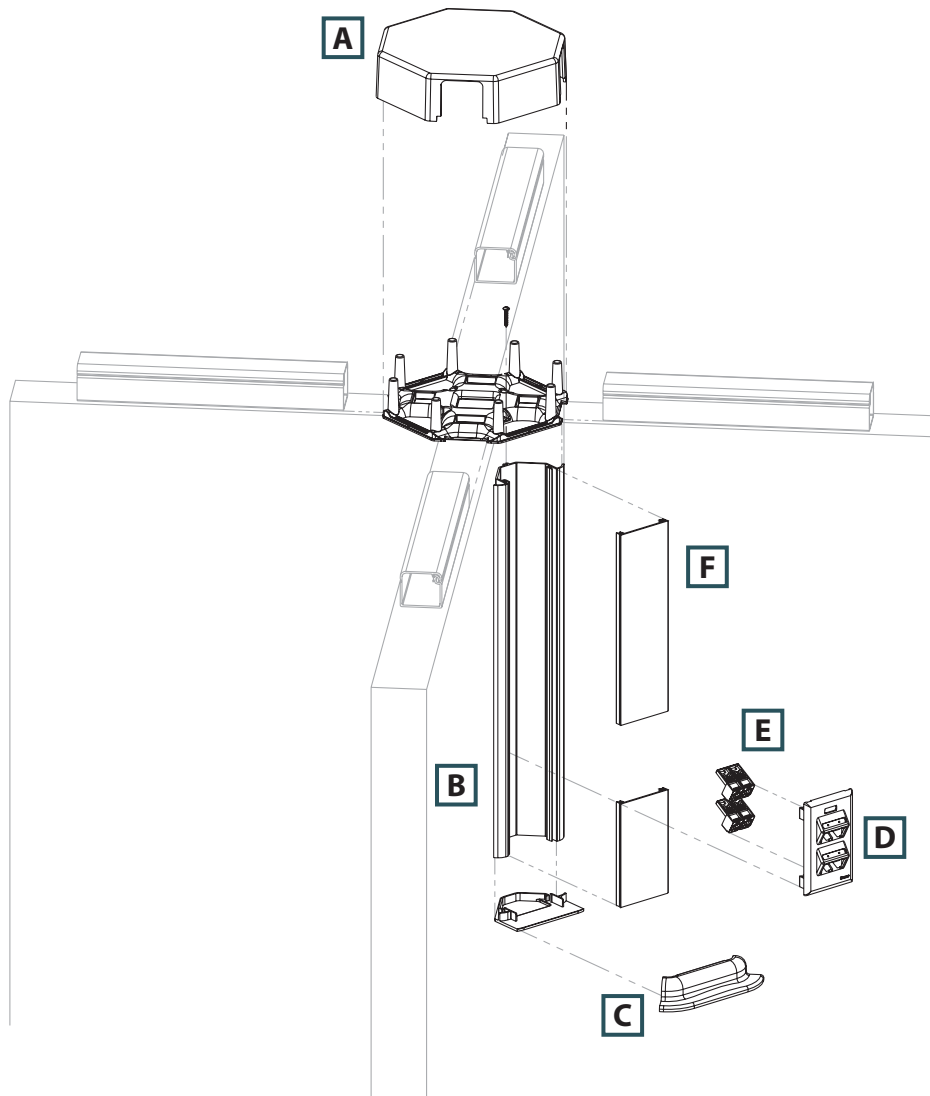

Office Furniture Configurations (continued)

Exploded View 2

| | Components Required | See page |
|----|--|----------|
| A. | OFR20SO** = Spill-over fitting. | C2.100 |
| B. | OFVR5**6 = Vertical raceway. | C2.98 |
| C. | OFR20DMB = Desk mount box. | C2.100 |
| D. | MINI-COM® Modules. | — |
| E. | OF70FH4** = Horizontal sloped communication snap-on faceplate. | C2.101 |

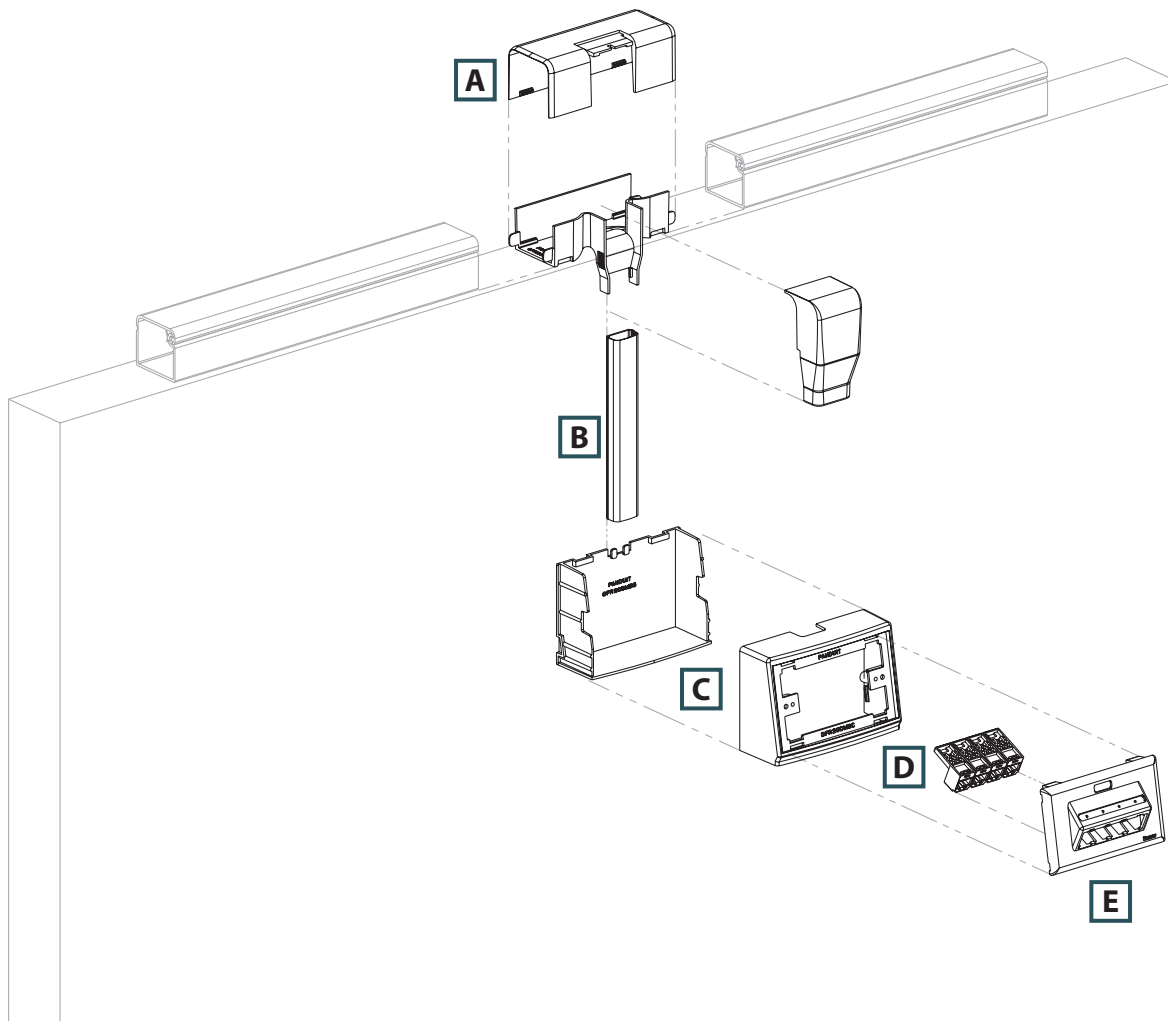

A.
System
Overview

B1.
Cable Ties

B2.
Cable
Accessories

B3.
Stainless
Steel Ties

C1.
Wiring
Duct

C2.
Surface
Raceway

C3.
Abrasion
Protection

C4.
Cable
Management

D1.
Terminals

D2.
Power
Connectors

D3.
Grounding
Connectors

E1.
Labeling
Systems

E2.
Labels

E3.
Pre-Printed
& Write-On
Markers

E4.
Permanent
Identification

E5.
Lockout/
Tagout/
& Safety
Solutions

F.
Index

A. System Overview

PAN-WAY® Office Furniture Raceway System

B1. Cable Ties

B2. Cable Accessories

B3. Stainless Steel Ties

C1. Wiring Duct

C2. Surface Raceway

C3. Abrasion Protection

C4. Cable Management

D1. Terminals

D2. Power Connectors

D3. Grounding Connectors

E1. Labeling Systems

E2. Labels

E3. Pre-Printed & Write-On Markers

E4. Permanent Identification

E5. Lockout/Tagout & Safety Solutions

F. Index

- UL listed in accordance with UL 5C requirements for Class 2 Communication Cable Management Systems
- Maintains bend radius control throughout the entire office furniture raceway system as required by TIA/EIA-568-B and 569-B
- Faceplates are compliant with the labeling requirements of the TIA/EIA-606-A standard
- Robust design and tamper resistant closure increases product stability and prevents damage to cabling during and after installation
- Product supplied with adhesive backing for fast and easy installation
- Creates a virtually invisible solution for routing data cables on panels from all common manufacturers with a top cap width between 1.88 and 2.30 inches
- Designed for use with *PAN-NET®* Connectivity, also accepts all common manufacturers' connectivity with use of a NEMA standard 70mm faceplate or module frame

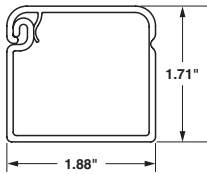

OFFICE FURNITURE RACEWAY
Internal Area = 2.31 Sq. In.



Office Beige (OB)

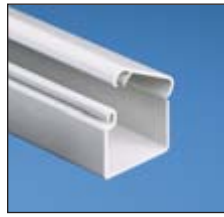

Office Gray (OG)

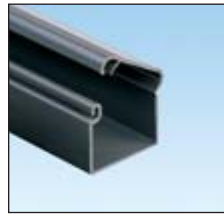

Office Slate (OS)

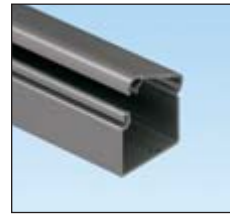

Medium Tone (MT)



OFR20

| Part Number | Part Description | Raceway Size | Color‡ | Length (Ft.) | Std. Pkg. Qty. | Std. Ctn. Qty. |
|-----------------|--|---------------------------------|--------------|--------------|----------------|----------------|
| OFR20OB6 | One-piece single channel low voltage raceway with adhesive tape backing for data cable routing along top of modular furniture partitions. Available in 6' lengths. | 1.88" x 1.71" (48.0mm x 44.0mm) | Office Beige | 6 | 6 | 48 |
| OFR20OB8 | One-piece single channel low voltage raceway with adhesive tape backing for data cable routing along top of modular furniture partitions. Available in 8' lengths. | 1.88" x 1.71" (48.0mm x 44.0mm) | Office Beige | 8 | 8 | 64 |

‡For other colors, replace OB (Office Beige) with OS (Office Slate), OG (Office Gray), or MT (Medium Tone). Order number of feet required in multiples of standard carton quantity.

PAN-WAY® Office Furniture Raceway Fittings

- Office furniture raceway fittings have been designed to maintain the TIA/EIA required 1 inch minimum bend radius for high performance copper and fiber optic cabling systems

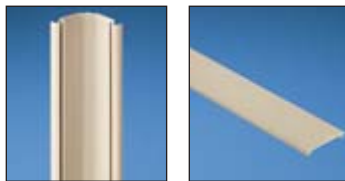

OFCR70

OFCRC70



OFVR5

| Part Number | Part Description | Labels Required | Color‡ | Std. Pkg. Qty. | Std. Ctn. Qty. |
|-------------------|---|-----------------|--------------|----------------|----------------|
| OFCR70OB6 | Office furniture corner raceway base. Used to terminate low voltage data cabling in the corner at the intersection of modular office furniture panels. Accepts 70mm standard faceplates. Available in 6' lengths. | — | Office Beige | 6 | 48 |
| OFCRC70OB6 | Office furniture corner raceway cover. Available in 6' lengths. | — | Office Beige | 6 | 48 |
| OFVR5OB6 | Office furniture vertical raceway. One-piece single channel raceway used to connect OFR20**6 or OFR20**8 to desk mount box (OFR20DMB**) and must be used with OFR20SO** or OFR20DSO**. Available in 6' lengths. | — | Office Beige | 6 | 120 |

‡For other colors, replace OB (Office Beige) with OS (Office Slate), OG (Office Gray), or MT (Medium Tone). Computer printable labels found on pages E2.4 and E2.5



PAN-WAY® Office Furniture Raceway Fittings (continued)

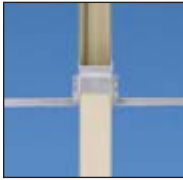

OFR20CP



OFR20FCR70**4



OFR20FCR70**2



OFR20FCR70**1



OFR20FCR70**1P



OFR20FCR70**2P



OFR20FCR70**4P

| Part Number | Part Description | Labels Required | Color‡ | Std. Pkg. Qty. | Std. Ctn. Qty. |
|-----------------------|--|-----------------|--------------|----------------|----------------|
| OFR20CPOB8 | Communication pole. Allows for data cable entry into office furniture raceway from suspended ceiling. 8" pole allows maximum 7" distance from top of furniture partition to ceiling. Must be used with OFR20MPT**. Note: Not intended for use at intersection of furniture panels. | — | Office Beige | 1 | — |
| OFR20FCR70OB4 | Four cubicle drop fitting. Allows the transition from office furniture raceway run horizontally along partition wall to office furniture corner raceway mounted vertically in four cubicles at the intersection of partitions. Fitting maintains 1" minimum bend radius of cabling. Supplied with adhesive tape. | — | Office Beige | 1 | 10 |
| OFR20FCR70OB2 | Two cubicle drop fitting. Allows the transition from office furniture raceway run horizontally along partition wall to office furniture corner raceway mounted vertically in two cubicles at the intersection of partitions. Fitting maintains 1" minimum bend radius of cabling. Supplied with adhesive tape. | — | Office Beige | 1 | 10 |
| OFR20FCR70OB1 | One cubicle drop fitting. Allows the transition from office furniture raceway run horizontally along partition wall to office furniture corner raceway mounted vertically in one cubicle at the intersection of partitions. Fitting maintains 1" minimum bend radius of cabling. Supplied with adhesive tape. | — | Office Beige | 1 | 10 |
| OFR20FCR70OB1P | One cubicle drop bypass fitting. Allows the transition from office furniture raceway run horizontally along partition wall, around existing furniture pole, to office furniture corner raceway mounted vertically in one cubicle at the intersection of partitions. Fitting maintains 1" minimum bend radius of cabling. Supplied with adhesive tape. | — | Office Beige | 1 | 10 |
| OFR20FCR70OB2P | Two cubicle drop bypass fitting. Allows the transition from office furniture raceway run horizontally along partition wall, around existing furniture pole, to office furniture corner raceway mounted vertically in two cubicles at the intersection of partitions. Fitting maintains 1" minimum bend radius of cabling. Supplied with adhesive tape. | — | Office Beige | 1 | 10 |
| OFR20FCR70OB4P | Four cubicle drop bypass fitting. Allows the transition from office furniture raceway run horizontally along partition wall, around existing furniture pole, to office furniture corner raceway mounted vertically in four cubicles at the intersection of partitions. Fitting maintains 1" minimum bend radius of cabling. Supplied with adhesive tape. | — | Office Beige | 1 | 10 |

‡For other colors, replace OB (Office Beige) with OS (Office Slate), OG (Office Gray), or MT (Medium Tone).
Computer printable labels found on pages E2.4 and E2.5

Table continues on page C2.100

A.
System
Overview

B1.
Cable Ties

B2.
Cable
Accessories

B3.
Stainless
Steel Ties

C1.
Wiring
Duct

C2.
Surface
Raceway

C3.
Abrasion
Protection

C4.
Cable
Management

D1.
Terminals

D2.
Power
Connectors

D3.
Grounding
Connectors

E1.
Labeling
Systems

E2.
Labels

E3.
Pre-Printed
& Write-On
Markers

E4.
Permanent
Identification

E5.
Lockout/
Tagout
& Safety
Solutions

F.
Index

A. System Overview



PAN-WAY® Office Furniture Raceway Fittings (continued)

B1. Cable Ties



OFRCR70EC

B2. Cable Accessories



OFR20SO

B3. Stainless Steel Ties



OFR20DSO

C1. Wiring Duct



OFR20DMB

C2. Surface Raceway



OFR20MPT

C3. Abrasion Protection

C4. Cable Management

D1. Terminals

D2. Power Connectors

D3. Grounding Connectors



OFR20WE

OFR20RA

E1. Labeling Systems



OFR20T

OFR20CR

E2. Labels

E3. Pre-Printed & Write-On Markers

E4. Permanent Identification

E5. Lockout/Tagout & Safety Solutions

| Part Number | Part Description | Labels Required | Color‡ | Std. Pkg. Qty. | Std. Ctn. Qty. |
|--------------------|---|-----------------|--------------|----------------|----------------|
| OFRCR70ECOB | Corner raceway end cap fitting. Opening allows cord passage through fitting such as monitor and keyboard cables. Supplied with adhesive tape. | — | Office Beige | 1 | 10 |
| OFR20SOOB | Spill-over fitting. Allows transition from office furniture raceway run horizontally along partition wall to office furniture vertical raceway in one location. Adjustable fitting maintains 1" minimum bend radius of cabling and works with various panel widths between 1.88"– 2.30" (47.7mm - 58mm). Supplied with adhesive tape. | — | Office Beige | 1 | 10 |
| OFR20DSOOB | Double spill-over fitting. Fitting is used to spill over both sides of the furniture partitions at the same location. Incorporates a built-in, yet removable end cap that eliminates the need for additional raceway and fittings to terminate the pathway. | — | Office Beige | 1 | 10 |
| OFR20DMBOB | Desk mount box. Box accepts office furniture snap-on faceplates as well as 70mm NEMA standard screw-on faceplates. Designed for use with OFVR5**6 raceway and OFR20SO**, OFR20DSO** spill-over fittings. Supplied with adhesive tape. | — | Office Beige | 1 | 10 |
| OFR20MPTOB | Mid-panel tee fitting. Used to connect communication pole to office furniture raceway run horizontally along partition wall. Supplied with adhesive tape. Note: not intended for use at intersection of furniture panels. | — | Office Beige | 1 | 10 |
| OFR20WEOB | Wall entrance fitting. Allows entry from wall to office furniture raceway run horizontally along partition walls. Fitting includes bend radius protection and trim plate to cover wall opening. Requires minimum wall opening of 4.5"W x 3.0"H (114.3mm x 76.2mm). Supplied with adhesive tape. | — | Office Beige | 1 | 10 |
| OFR20RAOB | Right angle fitting. Used to join sections of office furniture raceway at 90° flat junction. Supplied with adhesive tape. | — | Office Beige | 1 | 10 |
| OFR20TOB | Tee fitting. Used to create an undivided tee junction between sections of office furniture raceway. Supplied with adhesive tape. | — | Office Beige | 1 | 10 |
| OFR20CROB | Cross fitting. Used to join sections of office furniture raceway at four corners. Supplied with adhesive tape. | — | Office Beige | 1 | 10 |

‡For other colors, replace OB (Office Beige) with OS (Office Slate), OG (Office Gray), or MT (Medium Tone). Computer printable labels found on pages E2.4 and E2.5



PAN-WAY® Office Furniture Raceway Fittings (continued)

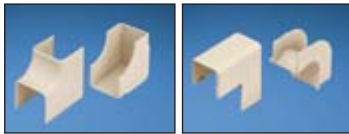

OFR20IC

OFR20OC



OFR20CC

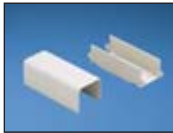

OFR20LC

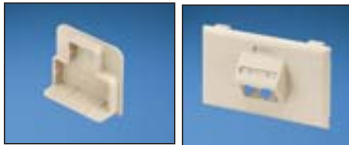

OFR20EC

OF70FH2

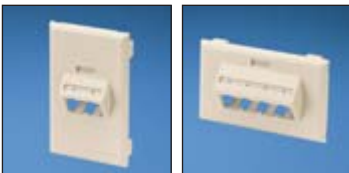

OF70FV2

OF70FH4

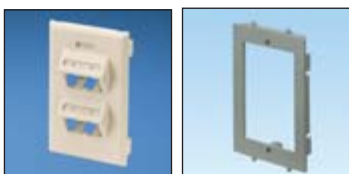

OF70FV4

T70SDB-X

| Part Number | Part Description | Labels Required | Color‡ | Std. Pkg. Qty. | Std. Ctn. Qty. |
|--------------------|--|---------------------------|--------------|----------------|----------------|
| OFR20ICOB | Inside corner fitting. Used to join sections of office furniture raceway at inside corner. Supplied with adhesive tape. | — | Office Beige | 1 | 10 |
| OFR20OCOB | Outside corner fitting. Used to join sections of office furniture raceway at outside corner. Supplied with adhesive tape. | — | Office Beige | 1 | 10 |
| OFR20CCOB-X | Coupler fitting. For use with office furniture raceway. | — | Office Beige | 10 | 100 |
| OFR20LCOB | Long coupler fitting (with base). Used to bridge office furniture raceway between panel sections. Can also be used to fill void left by spill-over fitting, when furniture partitions are reconfigured. Supplied with adhesive tape. | — | Office Beige | 1 | 10 |
| OFR20ECOB | End cap fitting. Used to terminate office furniture raceway. Supplied with adhesive tape. | — | Office Beige | 1 | 10 |
| OF70FH2OB | Snap-on single gang horizontal sloped communication faceplate. Accepts up to two PANDUIT® MINI-COM® Modules (not included). No additional mounting hardware required. TIA/EIA-606-A compliant. | 1-One Port 1-Two Port | Office Beige | 1 | 10 |
| OF70FV2OB | Snap-on single gang vertical sloped communication faceplate. Accepts up to two PANDUIT® MINI-COM® Modules (not included). No additional mounting hardware required. TIA/EIA-606-A compliant. | 1-One Port 1-Two Port | Office Beige | 1 | 10 |
| OF70FH4OB | Snap-on single gang horizontal sloped communication faceplate. Accepts up to four PANDUIT® MINI-COM® Modules (not included). No additional mounting hardware required. TIA/EIA-606-A compliant. | 1-One Port 1-Four Port | Office Beige | 1 | 10 |
| OF70FV4OB | Snap-on single gang vertical sloped communication faceplate. Accepts up to four PANDUIT® MINI-COM® Modules (not included). No additional mounting hardware required. TIA/EIA-606-A compliant. | 1-One Port 2-Two Port | Office Beige | 1 | 10 |
| T70SDB-X | Standard faceplate bracket. Used to mount NEMA standard 70mm single gang screw-on faceplates. Can be used with T-70, Twin-70, TG-70 raceway and PAN-POLE™ Communication Pole. | — | Gray | 10 | — |

‡For other colors, replace OB (Office Beige) with OS (Office Slate), OG (Office Gray), or MT (Medium Tone). Computer printable labels found on pages E2.4 and E2.5

A. System Overview

B1. Cable Ties

B2. Cable Accessories

B3. Stainless Steel Ties

C1. Wiring Duct

C2. Surface Raceway

C3. Abrasion Protection

C4. Cable Management

D1. Terminals

D2. Power Connectors

D3. Grounding Connectors

E1. Labeling Systems

E2. Labels

E3. Pre-Printed & Write-On Markers

E4. Permanent Identification

E5. Lockout/Tagout & Safety Solutions

F. Index

A.
System
Overview

Cable Fill Capacities for Office Furniture Raceway

B1.
Cable Ties

This information is to be used as a guide in selecting the proper size raceway. The maximum amounts may vary according to the cable installation methods, straightness of cables, etc.

B2.
Cable
Accessories

B3.
Stainless
Steel Ties

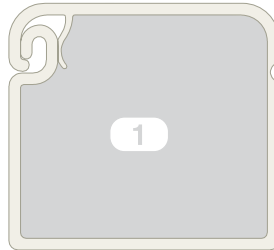

A = 2.31 in.²

Cable fill #1: Open channel without devices

C1.
Wiring
Duct

C2.
Surface
Raceway

C3.
Abrasion
Protection

SPEC = 40% cable fill – The recommended design in cable capacity, leaves room for future moves, adds, and changes.

MAX for Data = 60% cable fill – The maximum cable quantity based on cable interweaving and packing factors.

C4.
Cable
Management

D1.
Terminals

| Raceway Type and Configuration | Fill Area (In. ²) | Electrical Cables | | | Data Grade Cables | | Data Grade Cables | | Audio/Video | | Fiber Optic Cable | |
|--------------------------------|-------------------------------|-------------------|--------|--------|-------------------|-----|-------------------|-----|--------------|-----|-------------------|-----|
| | | 14 AWG | 12 AWG | 10 AWG | 24 AWG/UTP CM | | 24 AWG/UTP CM | | RG6 | | 2 Strand | |
| | | THHN/T90 | | | Cat. 6 | | Cat. 6A | | DIA. = 0.275 | | DIA. = 0.175 | |
| | | 0.111 | 0.130 | 0.164 | DIA. = 0.250 | | DIA. = 0.330 | | DIA. = 0.275 | | DIA. = 0.175 | |
| | | FILL | | | FILL | | FILL | | FILL | | FILL | |
| MAX | MAX | MAX | SPEC | MAX | SPEC | MAX | SPEC | MAX | SPEC | MAX | SPEC | MAX |
| 40% | 40% | 40% | 40% | 60% | 40% | 60% | 40% | 60% | 40% | 60% | 40% | 60% |
| OFR20 | 2.3 | — | — | — | 18 | 28 | 10 | 16 | 15 | 23 | 38 | 57 |

AWG dimensions represent typical outer cable diameter in inches.

E1.
Labeling
Systems

E2.
Labels

E3.
Pre-Printed
& Write-On
Markers

E4.
Permanent
Identification

E5.
Lockout/
Tagout/
& Safety
Solutions

F.
Index

PAN-POLE™ POWER AND COMMUNICATION POLES

PAN-POLE™ Power and Communication Poles provide industry-leading solutions for cable routing in the open office environment. Available with pre-terminated electrical outlets with divided channel for power and communication applications or as an open channel communication pole.



- Tamper resistant cover
- Bend radius control fitting (above ceiling) as required by TIA/EIA-568-B and 569-B.
- Complete with ceiling and floor mounting hardware

PAN-POLE™ Power and Communication Poles accept NEMA standard 70mm screw-on faceplates or superior PAN-WAY® Snap-On Faceplates.

A.
System
Overview

B1.
Cable Ties

B2.
Cable
Accessories

B3.
Stainless
Steel Ties

C1.
Wiring
Duct

C2.
Surface
Raceway

C3.
Abrasion
Protection

C4.
Cable
Management

D1.
Terminals

D2.
Power
Connectors

D3.
Grounding
Connectors

E1.
Labeling
Systems

E2.
Labels

E3.
Pre-Printed
& Write-On
Markers

E4.
Permanent
Identification

E5.
Lockout/
Tagout/
& Safety
Solutions

F.
Index

A. System Overview



PAN-POLE™ Power Pole

B1. Cable Ties

- Dual channel aluminum pole is equipped with pre-terminated electrical outlets and provides channel separation for the installation of communication cabling and modules

B2. Cable Accessories

- UL and CSA rated 600 V
- Available in 11 or 13 foot lengths and supplied with a non-metallic cover
- Electrical outlets are pre-wired

B3. Stainless Steel Ties

Pre-installed components include:

1. Blank non-metallic cover
2. Two 20 A factory wired rectangular outlets with wiring fed through power channel to base of power entry box

C1. Wiring Duct

C2. Surface Raceway

C3. Abrasion Protection

C4. Cable Management

D1. Terminals

D2. Power Connectors

D3. Grounding Connectors

E1. Labeling Systems

E2. Labels

E3. Pre-Printed & Write-On Markers

E4. Permanent Identification

E5. Lockout/Tagout & Safety Solutions

F. Index

3. Power entry with 1/2" and 3/4" conduit breakouts
4. Removable plate for power wiring connections
5. Ground screw pre-mounted behind removable plate

Supplied mounting hardware includes:

1. Entry end bend radius fitting
2. Ceiling T-bar bracket
3. Ceiling tile trim plate
4. End cap
5. End cap floor grip pad

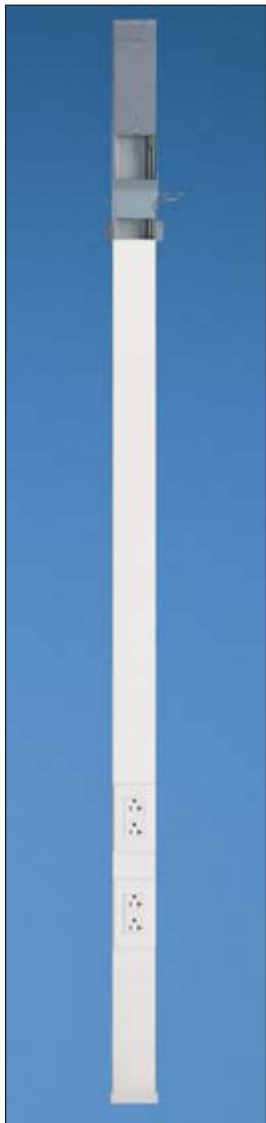

PCPA11R20
PCPA13R20

| Part Number | Part Description | Color‡ | Std. Pkg. Qty. |
|--------------------|---|-----------|----------------|
| PCPA11R20IW | PAN-POLE™ Power Pole assembly is supplied in 11' length for maximum ceiling height of 10'. Dual channel design allows for the installation of communication outlets. | Off White | 1 |
| PCPA13R20IW | PAN-POLE™ Power Pole assembly is supplied in 13' length for maximum ceiling heights of 12'. Dual channel design allows for the installation of communication outlets. | Off White | 1 |

Communication components sold separately.

‡For other colors replace IW (Off White) with EI (Electric Ivory).

Installation of Communication Outlets on *PAN-POLE™* Power Pole

Utilizing Standard Screw-On Faceplates

| | Components Required | See page |
|----|---|----------|
| A. | CPG** = Single gang rectangular screw-on faceplate (screws included). | C2.59 |
| B. | CFG2** = <i>MINI-COM</i> ® Module Frame – 2-port. | — |
| C. | <i>MINI-COM</i> ® Modules. | — |
| D. | T70SDB-X = Standard faceplate bracket. | C2.40 |
| E. | PCPA**R20 power pole. | C2.104 |

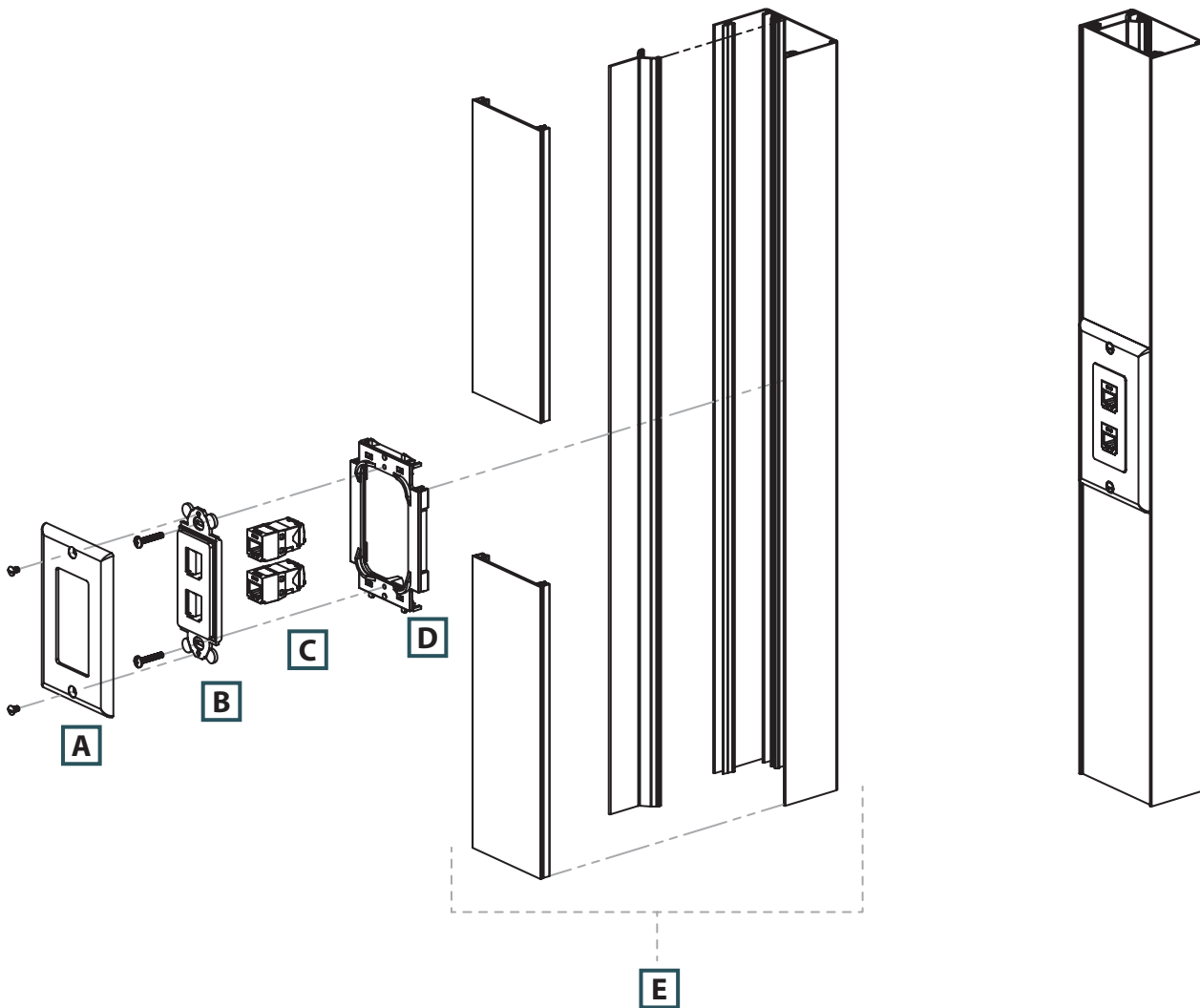

A.
System
Overview

B1.
Cable Ties

B2.
Cable
Accessories

B3.
Stainless
Steel Ties

C1.
Wiring
Duct

C2.
Surface
Raceway

C3.
Abrasion
Protection

C4.
Cable
Management

D1.
Terminals

D2.
Power
Connectors

D3.
Grounding
Connectors

E1.
Labeling
Systems

E2.
Labels

E3.
Pre-Printed
& Write-On
Markers

E4.
Permanent
Identification

E5.
Lockout/
Tagout/
& Safety
Solutions

F.
Index

A.
System
Overview

Installation of Communication Outlets on *PAN-POLE™* Power Pole (continued)

B1.
Cable Ties

Utilizing *PANDUIT* Snap-On Faceplates

B2.
Cable
Accessories

| | Components Required | See page |
|----|---|----------|
| A. | UIT70FV2** = Single gang vertical sloped communication snap-on faceplate. | — |
| B. | <i>MINI-COM</i> ® Modules. | — |
| C. | PCPA**R20 power pole. | C2.104 |

B3.
Stainless
Steel Ties

C1.
Wiring
Duct

C2.
Surface
Raceway

C3.
Abrasion
Protection

C4.
Cable
Management

D1.
Terminals

D2.
Power
Connectors

D3.
Grounding
Connectors

E1.
Labeling
Systems

E2.
Labels

E3.
Pre-Printed
& Write-On
Markers

E4.
Permanent
Identification

E5.
Lockout/
Tagout/
& Safety
Solutions

F.
Index

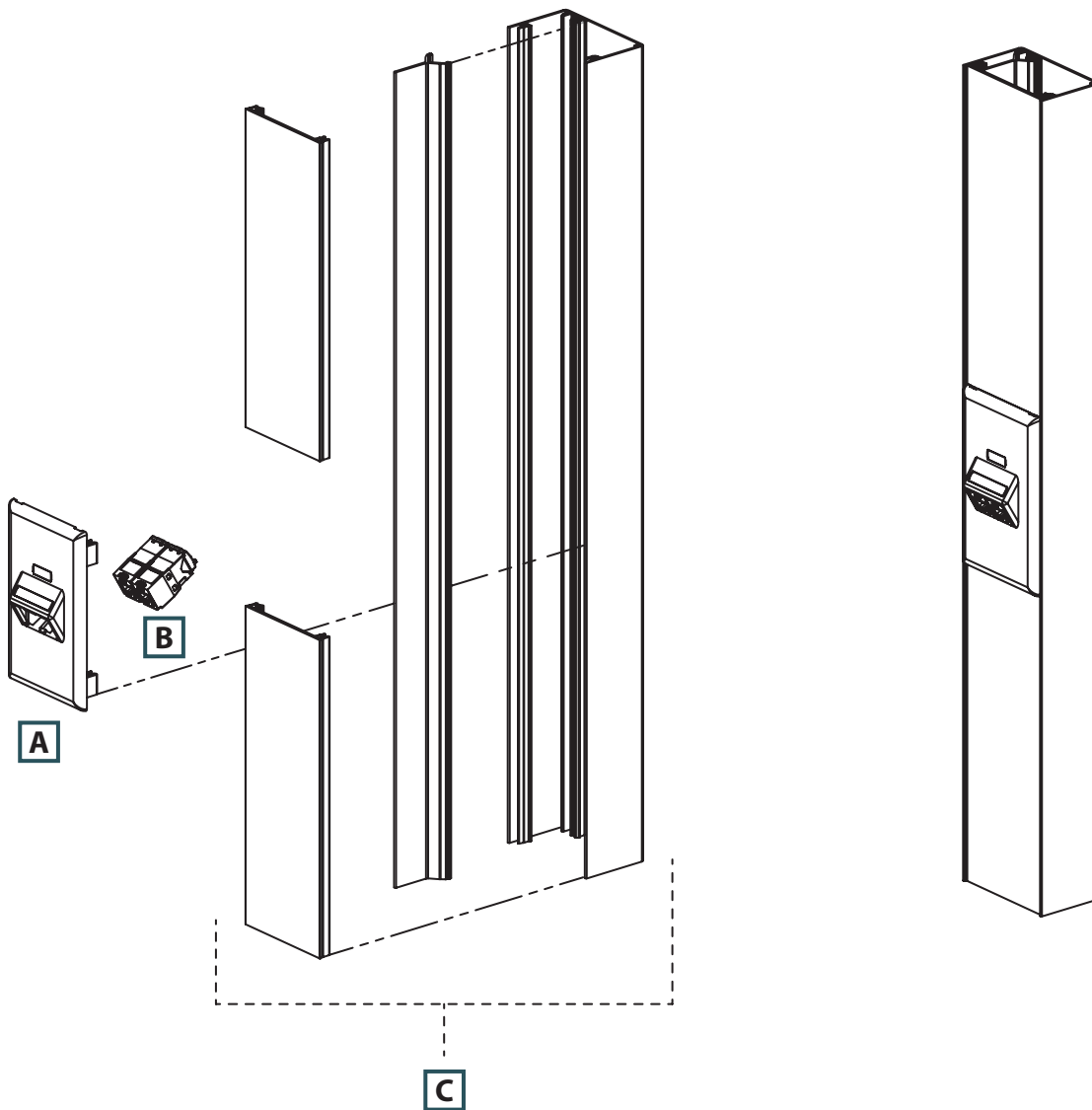

PAN-POLE™ Communication Pole

- Single channel aluminum pole for routing low voltage communication cabling only
- Poles are available in 11 or 13 foot lengths and are supplied with a non-metallic cover

Supplied mounting hardware includes:

1. Entry end bend radius fitting
2. Ceiling T-bar bracket
3. Ceiling tile trim plate
4. End cap
5. End cap floor grip pad

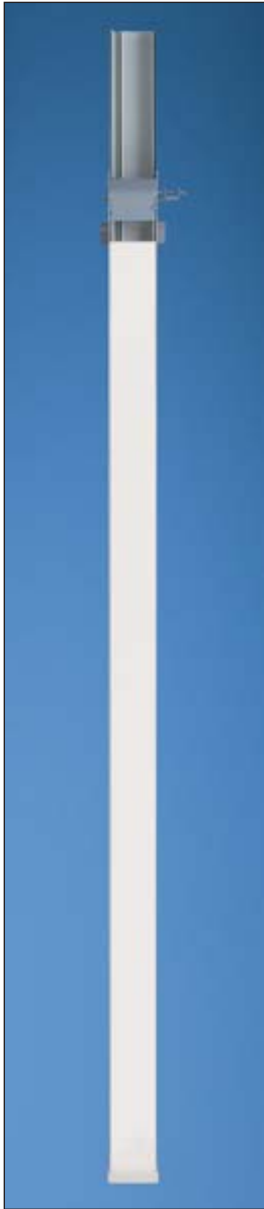

PCPA11
PCPA13

| Part Number | Part Description | Color‡ | Std. Pkg. Qty. |
|-----------------|--|-----------|----------------|
| PCPA11IW | PAN-POLE™ Communication Pole assembly is supplied in 11' length for maximum ceiling height of 10'. | Off White | 1 |
| PCPA13IW | PAN-POLE™ Communication Pole assembly is supplied in 13' length for maximum ceiling height of 12'. | Off White | 1 |

Communication components sold separately.

‡For other colors replace IW (Off White) with EI (Electric Ivory).

A.
System
Overview

B1.
Cable Ties

B2.
Cable
Accessories

B3.
Stainless
Steel Ties

C1.
Wiring
Duct

C2.
Surface
Raceway

C3.
Abrasion
Protection

C4.
Cable
Management

D1.
Terminals

D2.
Power
Connectors

D3.
Grounding
Connectors

E1.
Labeling
Systems

E2.
Labels

E3.
Pre-Printed
& Write-On
Markers

E4.
Permanent
Identification

E5.
Lockout/
Tagout/
& Safety
Solutions

F.
Index

A.
System
Overview

B1.
Cable Ties

B2.
Cable
Accessories

B3.
Stainless
Steel Ties

C1.
Wiring
Duct

C2.
Surface
Raceway

C3.
Abrasion
Protection

C4.
Cable
Management

D1.
Terminals

D2.
Power
Connectors

D3.
Grounding
Connectors

E1.
Labeling
Systems

E2.
Labels

E3.
Pre-Printed
& Write-On
Markers

E4.
Permanent
Identification

E5.
Lockout/
Tagout/
& Safety
Solutions

F.
Index

Installation of Communication Outlets on *PAN-POLE™* Communication Pole

Utilizing Standard Screw-On Faceplates

| | Components Required | See page |
|----|---|----------|
| A. | CPG** = Single gang rectangular screw-on faceplate (screws included). | C2.59 |
| B. | CFG2** = <i>MINI-COM</i> ® Module Frame – 2-port. | — |
| C. | <i>MINI-COM</i> ® Modules. | — |
| D. | T70SDB-X = Standard faceplate bracket. | C2.40 |
| E. | PCPA** = Communication pole. | C2.107 |

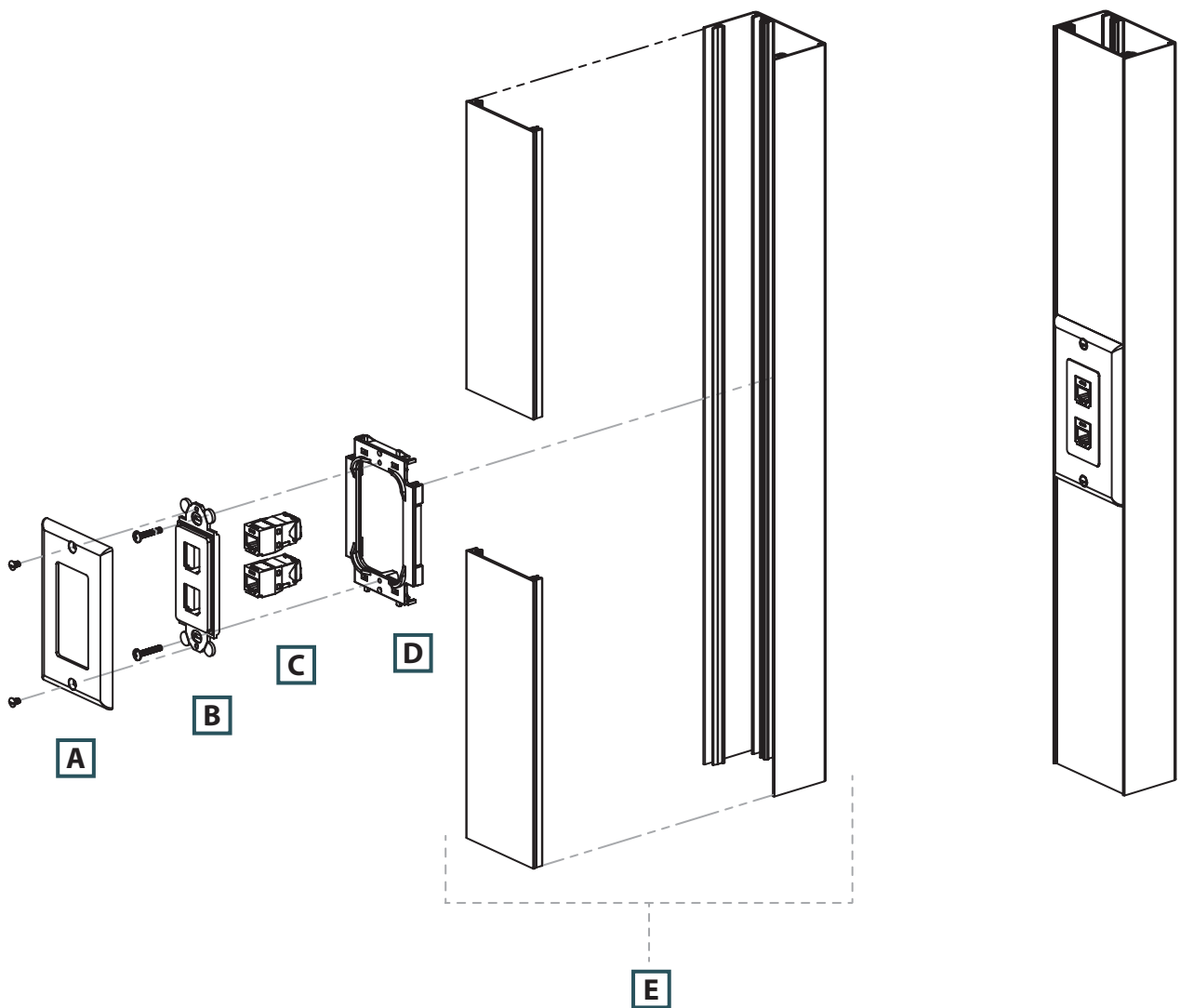

Installation of Communication Outlets on *PAN-POLE™* Communication Pole (continued)

Utilizing *PANDUIT* Snap-On Faceplates

| | Components Required | See page |
|----|---|----------|
| A. | UIT70FV2** = Single gang vertical sloped communication snap-on faceplate. | — |
| B. | MINI-COM® Modules. | — |
| C. | PCPA** = Communication pole. | C2.107 |

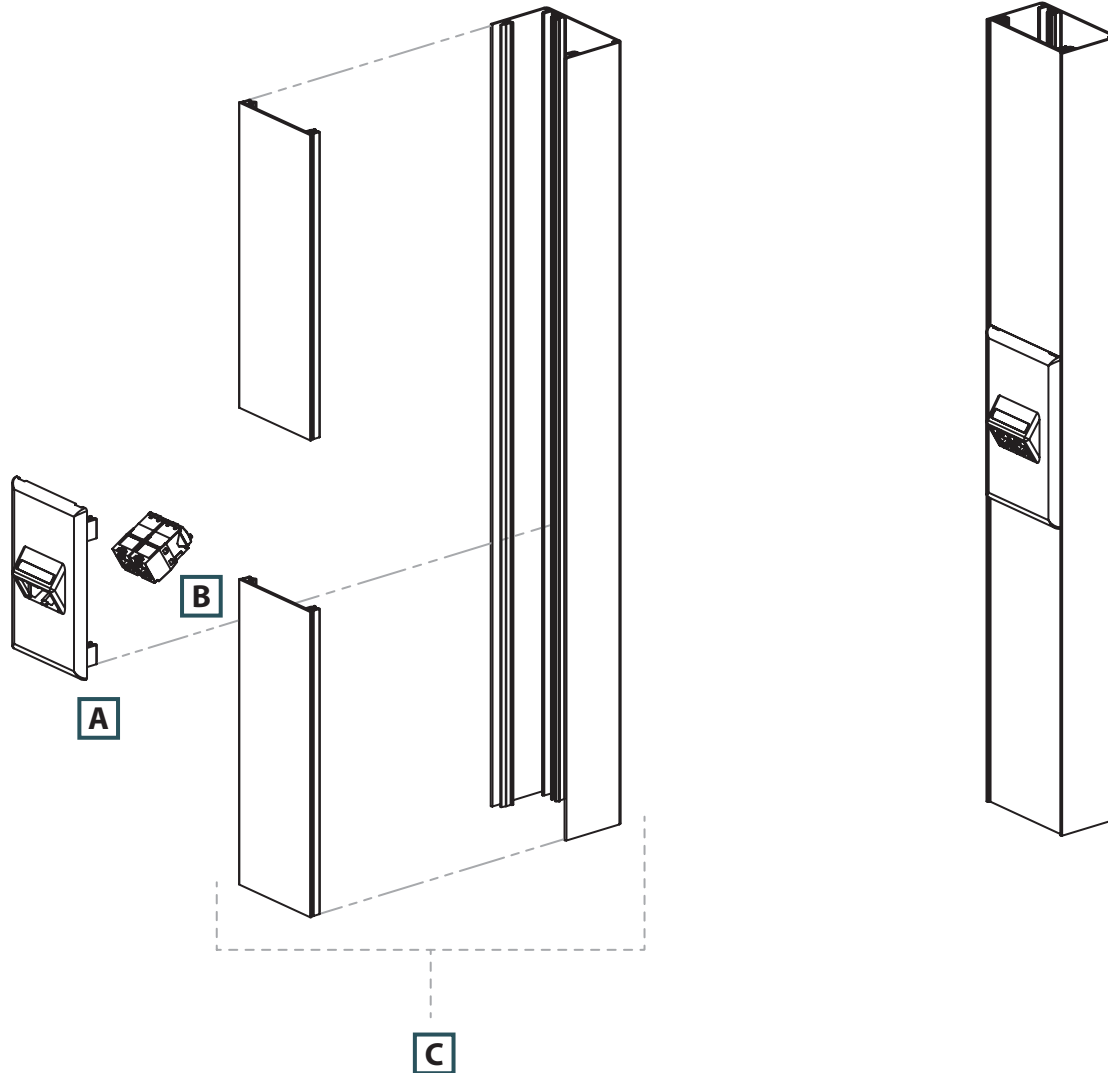

A.
System
Overview

B1.
Cable Ties

B2.
Cable
Accessories

B3.
Stainless
Steel Ties

C1.
Wiring
Duct

C2.
Surface
Raceway

C3.
Abrasion
Protection

C4.
Cable
Management

D1.
Terminals

D2.
Power
Connectors

D3.
Grounding
Connectors

E1.
Labeling
Systems

E2.
Labels

E3.
Pre-Printed
& Write-On
Markers

E4.
Permanent
Identification

E5.
Lockout/
Tagout
& Safety
Solutions

F.
Index

A. System Overview



PAN-POLE™ Extension Kits

B1. Cable Ties

B2. Cable Accessories

B3. Stainless Steel Ties

C1. Wiring Duct

C2. Surface Raceway

C3. Abrasion Protection

C4. Cable Management

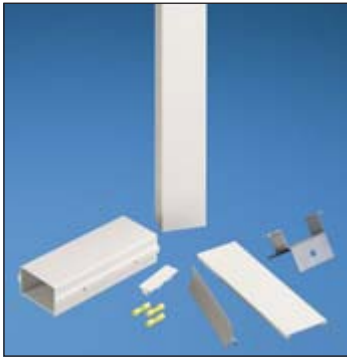

PCPAK22
PCPAK16

| Part Number | Part Description | Color‡ | Std. Pkg. Qty. |
|------------------|--|-----------|----------------|
| PCPAK22IW | <i>PAN-POLE™</i> Extension Kit. To extend the 11' pole to 22'. Extension kit includes: Fully assembled 11' pole with brace/coupler, additional wiring, and screws. Note: Customer needs to purchase a separate standard 11' pole to make the required length. | Off White | 1 |
| PCPAK16IW | <i>PAN-POLE™</i> Extension Kit. To extend the 13' pole to 16'. Extension kit includes: fully assembled 3' pole with brace/coupler, additional wiring, and screws. Note: Customer needs to purchase a separate standard 13' pole to make the required length. | Off White | 1 |

‡All product color is (IW) Off White.



PAN-POLE™ Power Addition Kits and Standard Faceplate Bracket

- Power addition kits (UL listed for field installation) provide for the addition of power outlets
- Allow for the installation of up to three additional duplex outlets (five outlets max.)

- Outlets may be added to the existing factory wired circuit or one additional circuit may be added



PCPAKR20



PCPAKR



T70SDB-X

| Part Number | Part Description | Color‡ | Std. Pkg. Qty. | Std. Ctn. Qty. |
|-------------------|--|-----------|----------------|----------------|
| PCPAKR20IW | Power addition kit includes 20 A rectangular outlet with two mounting screws, outlet mounting bracket with one mounting screw, and snap-on faceplate. | Off White | 1 | 10 |
| PCPAKRIW | Power addition kit includes outlet mounting bracket with one mounting screw and snap-on faceplate. <i>Rectangular power outlet purchased separately.</i> | Off White | 1 | 10 |
| T70SDB-X | Standard faceplate bracket. Used to mount NEMA standard 70mm single gang screw-on faceplates. Can be used with T-70, Twin-70, TG-70 raceway and <i>PAN-POLE™</i> Communication Pole. | Gray | 10 | — |

‡For other colors replace IW (Off White) with EI (Electric Ivory).

When purchasing power addition kit with 20A outlet, use with *PAN-POLE™* Power Pole, PCPA11R20IW and PCPA13R20IW.

When purchasing power addition it without outlet, rectangular power outlet needs to be purchased separately. Use with *PAN-POLE™* Power Pole, PCPA11R20EI and PCPA13R20EI.

D1. Terminals

D2. Power Connectors

D3. Grounding Connectors

E1. Labeling Systems

E2. Labels

E3. Pre-Printed & Write-On Markers

E4. Permanent Identification

E5. Lockout/Tagout & Safety Solutions

F. Index



PAN-POLE™ Replacement Parts



PCPKIT



PCPTP



PCPEC



PCBRC

| Part Number | Part Description | Color | Std. Pkg. Qty. | Std. Ctn. Qty. |
|-----------------|---|-----------|----------------|----------------|
| PCPKITIW | Replacement parts include: bend radius control ramp, two thumb screws, one two-piece ceiling trim plate and one end cap with floor grip pad. Also available in EI (Electric Ivory). | Off White | 1 | 5 |
| PCPTPIW | Replacement ceiling trim plate. | Off White | 1 | — |
| PCPECIW | Replacement end cap with floor grip pad. Also available in EI (Electric Ivory). | Off White | 1 | — |
| PCPBRC | Replacement bend radius control ramp with T-bar bracket for attaching pole to T-bar. Includes mounting screws. | Gray | 1 | — |

A. System Overview

B1. Cable Ties

B2. Cable Accessories

B3. Stainless Steel Ties

C1. Wiring Duct

C2. Surface Raceway

C3. Abrasion Protection

C4. Cable Management

D1. Terminals

D2. Power Connectors

D3. Grounding Connectors

E1. Labeling Systems

E2. Labels

E3. Pre-Printed & Write-On Markers

E4. Permanent Identification

E5. Lockout/Tagout & Safety Solutions

F. Index

A. System Overview

Cable Fill Capacities for *PAN-POLE™* Power and Communication Poles

The maximum amounts may vary according to the cable installation methods, straightness of cables, etc.

B1. Cable Ties

B2. Cable Accessories

B3. Stainless Steel Ties

C1. Wiring Duct

C2. Surface Raceway

C3. Abrasion Protection

C4. Cable Management

D1. Terminals

D2. Power Connectors

D3. Grounding Connectors

E1. Labeling Systems

E2. Labels

E3. Pre-Printed & Write-On Markers

E4. Permanent Identification

E5. Lockout/Tagout & Safety Solutions

F. Index

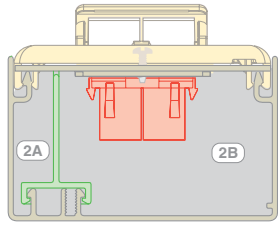

A = .47 in.² A = 2.75 in.²

Cable fill #1: Power pole with data terminals using vertical sloped snap-on communication faceplate.

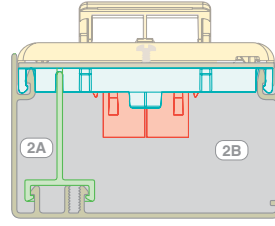

A = .43 in.² A = 2.15 in.²

Cable fill #2: Power pole with data terminals using sloped screw-on communication faceplate.

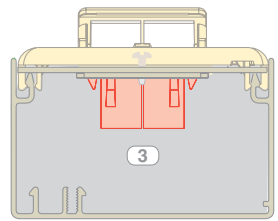

A = 3.47 in.²

Cable fill #3: Communication pole using vertical sloped snap-on communication faceplate.

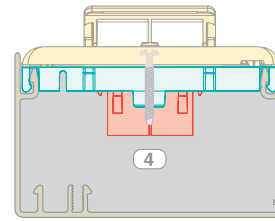

A = 2.83 in.²

Cable fill #4: communication pole using sloped screw-on communication faceplate.

SPEC = 40% cable fill – The recommended design in cable capacity, leaves room for future moves, adds, and changes.

MAX for Data = 60% cable fill – The maximum cable quantity based on cable interweaving and packing factors.

MAX for Power cable fill – The maximum of electrical cables based on UL temperature rise test.

| | Raceway Type and Configuration | Fill Area (In. ²) | Electrical Cables | | | Data Grade Cables | | Data Grade Cables | | Audio/Video | | Fiber Optic Cable | | |
|---------------------|---|-------------------------------|-------------------|--------|--------|-------------------|-------|-------------------|-------|--------------|-------|-------------------|-------|--|
| | | | 14 AWG | 12 AWG | 10 AWG | 24 AWG/UTP CM | | 24 AWG/UTP CM | | RG6 | | 2 Strand | | |
| | | | THHN/T90 | | | Cat. 6 (4-pr.) | | Augmented Cat. 6 | | | | | | |
| | | | 0.111 | 0.130 | 0.164 | DIA. = 0.250 | | DIA. = 0.354 | | DIA. = 0.275 | | DIA. = 0.175 | | |
| | | | FILL | | | FILL | | FILL | | FILL | | FILL | | |
| MAX | MAX | MAX | SPEC | MAX | SPEC | MAX | SPEC | MAX | SPEC | MAX | MAX | | | |
| (UL Temp Rise Test) | | | (40%) | | (60%) | | (40%) | | (60%) | | (40%) | | (60%) | |
| 1A. | Power and communication: snap-on faceplates (power). | 0.47 | — | 11 | — | — | — | — | 32 | 4 | 7 | 11 | | |
| 1B. | Communication. | 2.75 | — | — | — | 22 | 33 | 12 | 19 | 18 | 27 | 45 | 68 | |
| 2A. | Power and communication: Screw-on faceplates (power). | 0.43 | — | 11 | — | — | — | — | 2 | 4 | 7 | 10 | | |
| 2B. | Communication. | 2.15 | — | — | — | 17 | 26 | 10 | 15 | 14 | 21 | 35 | 53 | |
| 3. | Communication only Snap-on faceplate. | 3.47 | — | — | — | 28 | 42 | 16 | 24 | 23 | 35 | 57 | 86 | |
| 4. | Communication only: Screw-on faceplates. | 2.83 | — | — | — | 23 | 34 | 13 | 19 | 19 | 28 | 47 | 70 | |

AWG dimensions represent typical outer cable diameter in inches.

ABRASION PROTECTION

PANDUIT abrasion protection products provide an economical and easy way to insulate, protect, bundle and color-code components and cable. A wide variety of sizes and materials are available to meet a broad range of indoor and outdoor applications. To help assure optimum quality, *PANDUIT* abrasion protection products are designed and manufactured to meet applicable quality standards including International, UL, Military, ISO and Aerospace.



- *PAN-WRAP™* Split Harness Wrap features a patented slot pattern to improve flexibility and abrasion protection
- Spiral wrap bundles and protects wire and cable while providing the largest variety of colors, materials, and sizes to meet a variety of needs
- Grommet edging protects wire and cable from damage caused by sharp panel edges
- Heat shrink is available in many different materials and sizes to meet a variety of needs
- Corrugated loom tubing is crush, impact, and abrasion resistant to reduce the risk of damage to wire and cable
- Braided expandable sleeving provides continuous abrasion resistance and lightweight durable protection, with a flexible open weave that will not trap heat or humidity

PANDUIT abrasion protection products provide quality at the lowest installed cost. With a continued focus on new product development, *PANDUIT* continues to meet customer needs.

A.
System
Overview

B1.
Cable Ties

B2.
Cable
Accessories

B3.
Stainless
Steel Ties

C1.
Wiring
Duct

C2.
Surface
Raceway

C3.
Abrasion
Protection

C4.
Cable
Management

D1.
Terminals

D2.
Power
Connectors

D3.
Grounding
Connectors

E1.
Labeling
Systems

E2.
Labels

E3.
Pre-Printed
& Write-On
Markers

E4.
Permanent
Identification

E5.
Lockout/
Tagout
& Safety
Solutions

F.
Index

A. System Overview

PAN-WRAP™ Split Harness Wrap

B1. Cable Ties

- Patented slot pattern provides improved flexibility and abrasion protection in any application
- Unique wall design provides for easy cable breakouts
- Innovative design maintains uniform bundle protection in dynamic applications
- Large overlap accommodates a wide range of bundle diameters
- Packaged on a reel for easy handling and dispensing of product

B2. Cable Accessories

B3. Stainless Steel Ties



C1. Wiring Duct

C2. Surface Raceway

C3. Abrasion Protection

C4. Cable Management

D1. Terminals

D2. Power Connectors

D3. Grounding Connectors

E1. Labeling Systems

E2. Labels

E3. Pre-Printed & Write-On Markers

E4. Permanent Identification

E5. Lockout/Tagout & Safety Solutions

F. Index

| Part Number | Material | Color | Length Per Reel | | Max. Bundle Diameter | | Min. Bundle Diameter‡ | | Temperature Range | Nominal I.D. | | Std. Pkg. Qty.* |
|--------------------|------------------------------|---------|-----------------|------|----------------------|------|-----------------------|------|-----------------------------------|--------------|------|-----------------|
| | | | Ft. | m | In. | mm | In. | mm | | In. | mm | |
| PW50F-T | Polyethylene | Natural | 200 | 61.1 | .55 | 14.0 | .43 | 10.9 | -40°F to 122°F (-40°C to 50°C) | .50 | 12.7 | 1 |
| PW50F-T20 | Polyethylene | Black | 200 | 61.1 | .55 | 14.0 | .43 | 10.9 | -40°F to 122°F (-40°C to 50°C) | .50 | 12.7 | 1 |
| PW50FR-T | Flame Retardant Polyethylene | Natural | 200 | 61.1 | .55 | 14.0 | .43 | 10.9 | -4°F to 212°F (-20°C to 100°C) | .50 | 12.7 | 1 |
| PW50FR-T20 | Flame Retardant Polyethylene | Black | 200 | 61.1 | .55 | 14.0 | .43 | 10.9 | -4°F to 212°F (-20°C to 100°C) | .50 | 12.7 | 1 |
| PW75F-C | Polyethylene | Natural | 100 | 30.5 | .81 | 20.6 | .55 | 14.0 | -40°F to 122°F (-40°C to 50°C) | .75 | 19.1 | 1 |
| PW75F-C20 | Polyethylene | Black | 100 | 30.5 | .81 | 20.6 | .55 | 14.0 | -40°F to 122°F (-40°C to 50°C) | .75 | 19.1 | 1 |
| PW75FR-C | Flame Retardant Polyethylene | Natural | 100 | 30.5 | .81 | 20.6 | .55 | 14.0 | -4°F to 212°F (-20°C to 100°C) | .75 | 19.1 | 1 |
| PW75FR-C20 | Flame Retardant Polyethylene | Black | 100 | 30.5 | .81 | 20.6 | .55 | 14.0 | -4°F to 212°F (-20°C to 100°C) | .75 | 19.1 | 1 |
| PW100F-C | Polyethylene | Natural | 100 | 30.5 | 1.13 | 28.7 | .81 | 20.6 | -40°F to 122°F (-40°C to 50°C) | 1.00 | 25.4 | 1 |
| PW100F-C20 | Polyethylene | Black | 100 | 30.5 | 1.13 | 28.7 | .81 | 20.6 | -40°F to 122°F (-40°C to 50°C) | 1.00 | 25.4 | 1 |
| PW100FR-C | Flame Retardant Polyethylene | Natural | 100 | 30.5 | 1.13 | 28.7 | .81 | 20.6 | -4°F to 212°F (-20°C to 100°C) | 1.00 | 25.4 | 1 |
| PW100FR-C20 | Flame Retardant Polyethylene | Black | 100 | 30.5 | 1.13 | 28.7 | .81 | 20.6 | -4°F to 212°F (-20°C to 100°C) | 1.00 | 25.4 | 1 |
| PW150F-L | Polyethylene | Natural | 25 | 7.6 | 1.63 | 41.4 | 1.13 | 28.7 | -40°F to 122°F (-40°C to 50°C) | 1.50 | 38.1 | 1 |
| PW150F-L20 | Polyethylene | Black | 25 | 7.6 | 1.63 | 41.4 | 1.13 | 28.7 | -40°F to 122°F (-40°C to 50°C) | 1.50 | 38.1 | 1 |
| PW150FR-L | Flame Retardant Polyethylene | Natural | 25 | 7.6 | 1.63 | 41.4 | 1.13 | 28.7 | -40°F to 122°F (-40°C to 50°C) | 1.50 | 38.1 | 1 |
| PW150FR-L20 | Flame Retardant Polyethylene | Black | 25 | 7.6 | 1.63 | 41.4 | 1.13 | 28.7 | -40°F to 122°F (-40°C to 50°C) | 1.50 | 38.1 | 1 |

‡Diameter can be further reduced with the use of *PANDUIT* cable ties.

*Order number of reels required.

PAN-WRAP™ Installation Tools

- Patented installation tool with 180° opening allows easy loading of maximum bundle diameters to speed installation, providing the lowest installed cost



| Part Number | Color | For Use With | Std. Pkg. Qty.** |
|---------------|-------|--------------|------------------|
| PWT50 | White | PW50F- | 1 |
| PWT75 | White | PW75F- | 1 |
| PWT100 | White | PW100F- | 1 |
| PWT150 | White | PW150F- | 1 |

**Order number of tools required.

Part Number System for Spiral Wrap

| | | | | | |
|-----------------|--|--|---|---|---------------------|
| T | 25 | F | - | C | 16 |
| | | | | | |
| Type | Outside Diameter | Material | | Package Size | Color Suffix |
| T = Spiral Wrap | 12 = 1/8" 25 = 1/4" 38 = 3/8" 50 = 1/2" 62 = 5/8" 75 = 3/4" 100 = 1" | F = Polyethylene R = Fire Resistant Polyethylene FR = Flame Retardant Polyethylene N = Nylon T = TEFLON▲ | | X = 10' Q = 25' L = 50' C = 100' T = 200' TL = 250' D = 500' M = 1000' | See Table Below |

| Color | Color Suffix | MATERIAL AVAILABILITY | | | | |
|-------------------------|--------------------------|-----------------------|-----------------------------|------------------------------|-----------|---------|
| | | Polyethylene | Fire Resistant Polyethylene | Flame Retardant Polyethylene | Nylon 6.6 | TEFLON▲ |
| Natural* | No Suffix will be listed | ✓ | ✓* | ✓* | ✓ | ✓ |
| Weather Resistant Black | 0 | ✓ | | | ✓ | |
| Brown | 1 | ✓ | | | | |
| Red | 2 | ✓ | | | | |
| Orange | 3 | ✓ | | | | |
| Yellow | 4 | ✓ | | | | |
| Green | 5 | ✓ | | | | |
| Blue | 6 | ✓ | | | | |
| Purple | 7 | ✓ | | | | |
| Gray | 8 | ✓ | | | | |
| White | 10 | ✓ | | | | |
| Pink | 16 | ✓ | | | | |
| Black | 20 | ✓ | ✓ | ✓ | | |

Blank = Not applicable.

▲TEFLON or equivalent fluoropolymer PTFE material is used. TEFLON is a registered trademark of E.I. du Pont de Nemours and Company.

*Natural can range from transparent, opaque, to white.

A.
System
Overview

B1.
Cable Ties

B2.
Cable
Accessories

B3.
Stainless
Steel Ties

C1.
Wiring
Duct

C2.
Surface
Raceway

C3.
Abrasion
Protection

C4.
Cable
Management

D1.
Terminals

D2.
Power
Connectors

D3.
Grounding
Connectors

E1.
Labeling
Systems

E2.
Labels

E3.
Pre-Printed
& Write-On
Markers

E4.
Permanent
Identification

E5.
Lockout/
Tagout/
& Safety
Solutions

F.
Index

A. System Overview

Spiral Wrap

B1. Cable Ties



B2. Cable Accessories

- Harness multiple cables into a single manageable bundle
- Allows breakouts of single/multiple cables
- Provides protection for cables
- Multiple colors allow easy identification of cable bundles
- Installation tool supplied in each package

B3. Stainless Steel Ties

C1. Wiring Duct

C2. Surface Raceway

C3. Abrasion Protection

C4. Cable Management

D1. Terminals

D2. Power Connectors

D3. Grounding Connectors

E1. Labeling Systems

E2. Labels

E3. Pre-Printed & Write-On Markers

E4. Permanent Identification

E5. Lockout/Tagout & Safety Solutions

F. Index

| Part Number | Material* | Color | Length per Reel | | Bundle Diameter Range | | Outside Diameter | | Temperature Range | Wall Thickness | | Std. Pkg. Qty. |
|-----------------|--------------|---------|-----------------|------|-----------------------|--------------|------------------|------|--------------------------------|----------------|------|----------------|
| | | | Ft. | m | In. | mm | In. | mm | | In. | mm | |
| T12F-C | Polyethylene | Natural | 100 | 30.5 | 1/16 to 1/2 | 1.6 to 12.7 | .12 | 3.3 | -40°F to 122°F (-40°C to 50°C) | .03 | .76 | 1 |
| T19F-C | Polyethylene | Natural | 100 | 30.5 | 1/8 to 1 | 3.2 to 25.4 | .19 | 4.8 | -40°F to 122°F (-40°C to 50°C) | .03 | .89 | 1 |
| T25F-C | Polyethylene | Natural | 100 | 30.5 | 3/16 to 2 | 4.8 to 50.4 | .25 | 6.4 | -40°F to 122°F (-40°C to 50°C) | .04 | 1.02 | 1 |
| T25F-C1 | Polyethylene | Brown | 100 | 30.5 | 3/16 to 2 | 4.8 to 50.4 | .25 | 6.4 | -40°F to 122°F (-40°C to 50°C) | .04 | 1.02 | 1 |
| T25F-C10 | Polyethylene | White | 100 | 30.5 | 3/16 to 2 | 4.8 to 50.4 | .25 | 6.4 | -40°F to 122°F (-40°C to 50°C) | .04 | 1.02 | 1 |
| T25F-C16 | Polyethylene | Pink | 100 | 30.5 | 3/16 to 2 | 4.8 to 50.4 | .25 | 6.4 | -40°F to 122°F (-40°C to 50°C) | .04 | 1.02 | 1 |
| T25F-C2 | Polyethylene | Red | 100 | 30.5 | 3/16 to 2 | 4.8 to 50.4 | .25 | 6.4 | -40°F to 122°F (-40°C to 50°C) | .04 | 1.02 | 1 |
| T25F-C3Y | Polyethylene | Orange | 100 | 30.5 | 3/16 to 2 | 4.8 to 50.4 | .25 | 6.4 | -40°F to 122°F (-40°C to 50°C) | .04 | 1.02 | 1 |
| T25F-C4Y | Polyethylene | Yellow | 100 | 30.5 | 3/16 to 2 | 4.8 to 50.4 | .25 | 6.4 | -40°F to 122°F (-40°C to 50°C) | .04 | 1.02 | 1 |
| T25F-C5 | Polyethylene | Green | 100 | 30.5 | 3/16 to 2 | 4.8 to 50.4 | .25 | 6.4 | -40°F to 122°F (-40°C to 50°C) | .04 | 1.02 | 1 |
| T25F-C6 | Polyethylene | Blue | 100 | 30.5 | 3/16 to 2 | 4.8 to 50.4 | .25 | 6.4 | -40°F to 122°F (-40°C to 50°C) | .04 | 1.02 | 1 |
| T25F-C7 | Polyethylene | Purple | 100 | 30.5 | 3/16 to 2 | 4.8 to 50.4 | .25 | 6.4 | -40°F to 122°F (-40°C to 50°C) | .04 | 1.02 | 1 |
| T25F-C8 | Polyethylene | Gray | 100 | 30.5 | 3/16 to 2 | 4.8 to 50.4 | .25 | 6.4 | -40°F to 122°F (-40°C to 50°C) | .04 | 1.02 | 1 |
| T38F-C | Polyethylene | Natural | 100 | 30.5 | 5/16 to 3 | 7.9 to 76.2 | .38 | 9.5 | -40°F to 122°F (-40°C to 50°C) | .05 | 1.40 | 1 |
| T50F-X | Polyethylene | Natural | 10 | 3.05 | 3/8 to 4 | 9.5 to 101.6 | .50 | 12.7 | -40°F to 122°F (-40°C to 50°C) | .06 | 1.50 | 1 |
| T50F-C | Polyethylene | Natural | 100 | 30.5 | 3/8 to 4 | 9.5 to 101.6 | .50 | 12.7 | -40°F to 122°F (-40°C to 50°C) | .06 | 1.50 | 1 |
| T50F-C1 | Polyethylene | Brown | 100 | 30.5 | 3/8 to 4 | 9.5 to 101.6 | .50 | 12.7 | -40°F to 122°F (-40°C to 50°C) | .06 | 1.50 | 1 |
| T50F-C10 | Polyethylene | White | 100 | 30.5 | 3/8 to 4 | 9.5 to 101.6 | .50 | 12.7 | -40°F to 122°F (-40°C to 50°C) | .06 | 1.50 | 1 |
| T50F-C16 | Polyethylene | Pink | 100 | 30.5 | 3/8 to 4 | 9.5 to 101.6 | .50 | 12.7 | -40°F to 122°F (-40°C to 50°C) | .06 | 1.50 | 1 |

*Flame retardant products are manufactured from a material that is rated UL 94V-0.
 ‡Reel packaging may contain splices. Contact *PANDUIT* Customer Service for further information.

Spiral Wrap (continued)

| Part Number | Material* | Color | Length per Reel | | Bundle Diameter Range | | Outside Diameter | | Temperature Range | Wall Thickness | | Std. Pkg. Qty. |
|-------------|--------------------------------|---------|-----------------|------|-----------------------|---------------|------------------|------|--------------------------------|----------------|------|----------------|
| | | | Ft. | m | In. | mm | In. | mm | | In. | mm | |
| T50F-C2 | Polyethylene | Red | 100 | 30.5 | 3/8 to 4 | 9.5 to 101.6 | .50 | 12.7 | -40°F to 122°F (-40°C to 50°C) | .06 | 1.50 | 1 |
| T50F-C3Y | Polyethylene | Orange | 100 | 30.5 | 3/8 to 4 | 9.5 to 101.6 | .50 | 12.7 | -40°F to 122°F (-40°C to 50°C) | .06 | 1.50 | 1 |
| T50F-C4Y | Polyethylene | Yellow | 100 | 30.5 | 3/8 to 4 | 9.5 to 101.6 | .50 | 12.7 | -40°F to 122°F (-40°C to 50°C) | .06 | 1.50 | 1 |
| T50F-C5 | Polyethylene | Green | 100 | 30.5 | 3/8 to 4 | 9.5 to 101.6 | .50 | 12.7 | -40°F to 122°F (-40°C to 50°C) | .06 | 1.50 | 1 |
| T50F-C6 | Polyethylene | Blue | 100 | 30.5 | 3/8 to 4 | 9.5 to 101.6 | .50 | 12.7 | -40°F to 122°F (-40°C to 50°C) | .06 | 1.50 | 1 |
| T50F-C7 | Polyethylene | Purple | 100 | 30.5 | 3/8 to 4 | 9.5 to 101.6 | .50 | 12.7 | -40°F to 122°F (-40°C to 50°C) | .06 | 1.50 | 1 |
| T50F-C8 | Polyethylene | Gray | 100 | 30.5 | 3/8 to 4 | 9.5 to 101.6 | .50 | 12.7 | -40°F to 122°F (-40°C to 50°C) | .06 | 1.50 | 1 |
| T62F-C | Polyethylene | Natural | 100 | 30.5 | 1/2 to 4 1/2 | 12.7 to 114.3 | .62 | 15.9 | -40°F to 122°F (-40°C to 50°C) | .06 | 1.57 | 1 |
| T75F-C | Polyethylene | Natural | 100 | 30.5 | 5/8 to 5 | 15.9 to 127.0 | .75 | 19.1 | -40°F to 122°F (-40°C to 50°C) | .06 | 1.65 | 1 |
| T100F-C | Polyethylene | Natural | 100 | 30.5 | 7/8 to 6 | 22.2 to 152.4 | 1.00 | 25.4 | -40°F to 122°F (-40°C to 50°C) | .07 | 1.78 | 1 |
| T12F-C0 | Weather Resistant Polyethylene | Black | 100 | 30.5 | 1/16 to 1/2 | 1.6 to 12.7 | .12 | 3.3 | -40°F to 122°F (-40°C to 50°C) | .03 | .76 | 1 |
| T19F-C0 | Weather Resistant Polyethylene | Black | 100 | 30.5 | 1/8 to 1 | 3.2 to 25.4 | .19 | 4.8 | -40°F to 122°F (-40°C to 50°C) | .03 | .89 | 1 |
| T25F-X0 | Weather Resistant Polyethylene | Black | 10 | 3.05 | 3/16 to 2 | 4.8 to 50.4 | .25 | 6.4 | -40°F to 122°F (-40°C to 50°C) | .04 | 1.02 | 1 |
| T25F-C0 | Weather Resistant Polyethylene | Black | 100 | 30.5 | 3/16 to 2 | 4.8 to 50.4 | .25 | 6.4 | -40°F to 122°F (-40°C to 50°C) | .04 | 1.02 | 1 |
| T38F-C0 | Weather Resistant Polyethylene | Black | 100 | 30.5 | 5/16 to 3 | 7.9 to 76.2 | .38 | 9.5 | -40°F to 122°F (-40°C to 50°C) | .05 | 1.40 | 1 |
| T50F-X0 | Weather Resistant Polyethylene | Black | 10 | 3.05 | 3/8 to 4 | 9.5 to 101.6 | .50 | 12.7 | -40°F to 122°F (-40°C to 50°C) | .06 | 1.50 | 1 |
| T50F-C0 | Weather Resistant Polyethylene | Black | 100 | 30.5 | 3/8 to 4 | 9.5 to 101.6 | .50 | 12.7 | -40°F to 122°F (-40°C to 50°C) | .06 | 1.50 | 1 |
| T62F-C0 | Weather Resistant Polyethylene | Black | 100 | 30.5 | 1/2 to 4 1/2 | 12.7 to 114.3 | .62 | 15.9 | -40°F to 122°F (-40°C to 50°C) | .06 | 1.57 | 1 |
| T75F-C0 | Weather Resistant Polyethylene | Black | 100 | 30.5 | 5/8 to 5 | 15.9 to 127.0 | .75 | 19.1 | -40°F to 122°F (-40°C to 50°C) | .06 | 1.65 | 1 |
| T100F-C0 | Weather Resistant Polyethylene | Black | 100 | 30.5 | 7/8 to 6 | 22.2 to 152.4 | 1.00 | 25.4 | -40°F to 122°F (-40°C to 50°C) | .07 | 1.78 | 1 |
| T12R-CY | Fire Resistant Polyethylene | Natural | 100 | 30.5 | 1/16 to 1/2 | 1.6 to 12.7 | .12 | 3.3 | -40°F to 122°F (-40°C to 50°C) | .03 | .76 | 1 |
| T19R-CY | Fire Resistant Polyethylene | Natural | 100 | 30.5 | 1/8 to 1 | 3.2 to 25.4 | .19 | 4.8 | -40°F to 122°F (-40°C to 50°C) | .03 | .89 | 1 |
| T25R-CY | Fire Resistant Polyethylene | White | 100 | 30.5 | 3/16 to 2 | 4.8 to 50.4 | .25 | 6.4 | -40°F to 122°F (-40°C to 50°C) | .04 | 1.02 | 1 |
| T25R-C20Y | Fire Resistant Polyethylene | Black | 100 | 30.5 | 3/16 to 2 | 4.8 to 50.4 | .25 | 6.4 | -40°F to 122°F (-40°C to 50°C) | .04 | 1.02 | 1 |
| T38R-CY | Fire Resistant Polyethylene | White | 100 | 30.5 | 5/16 to 3 | 7.9 to 76.2 | .38 | 9.5 | -40°F to 122°F (-40°C to 50°C) | .05 | 1.40 | 1 |
| T50R-CY | Fire Resistant Polyethylene | White | 100 | 30.5 | 3/8 to 4 | 9.5 to 101.6 | .50 | 12.7 | -40°F to 122°F (-40°C to 50°C) | .06 | 1.50 | 1 |

*Flame retardant products are manufactured from a material that is rated UL 94V-0.
 †Reel packaging may contain splices. Contact PANDUIT Customer Service for further information.

Table continues on page C3.6

A.
System
Overview

B1.
Cable Ties

B2.
Cable
Accessories

B3.
Stainless
Steel Ties

C1.
Wiring
Duct

C2.
Surface
Raceway

C3.
Abrasion
Protection

C4.
Cable
Management

D1.
Terminals

D2.
Power
Connectors

D3.
Grounding
Connectors

E1.
Labeling
Systems

E2.
Labels

E3.
Pre-Printed
& Write-On
Markers

E4.
Permanent
Identification

E5.
Lockout/
Tagout
& Safety
Solutions

F.
Index

A. System Overview

Spiral Wrap (continued)

B1. Cable Ties

B2. Cable Accessories

B3. Stainless Steel Ties

C1. Wiring Duct

C2. Surface Raceway

C3. Abrasion Protection

C4. Cable Management

D1. Terminals

D2. Power Connectors

D3. Grounding Connectors

E1. Labeling Systems

E2. Labels

E3. Pre-Printed & Write-On Markers

E4. Permanent Identification

E5. Lockout/Tagout & Safety Solutions

F. Index

| Part Number | Material* | Color | Length per Reel | | Bundle Diameter Range | | Outside Diameter | | Temperature Range | Wall Thickness | | Std. Pkg. Qty. |
|-------------------|------------------------------|---------|-----------------|------|-----------------------|---------------|------------------|------|--------------------------------|----------------|------|----------------|
| | | | Ft. | m | In. | mm | In. | mm | | In. | mm | |
| T62R-CY | Fire Resistant Polyethylene | White | 100 | 30.5 | 1/2 to 4 1/2 | 12.7 to 114.3 | .62 | 15.9 | -40°F to 122°F (-40°C to 50°C) | .06 | .63 | 1 |
| T75R-CY | Fire Resistant Polyethylene | White | 100 | 30.5 | 5/8 to 5 | 15.9 to 127.0 | .75 | 19.1 | -40°F to 122°F (-40°C to 50°C) | .07 | 1.65 | 1 |
| T100R-CY | Fire Resistant Polyethylene | White | 100 | 30.5 | 7/8 to 6 | 22.2 to 152.4 | 1.00 | 25.4 | -40°F to 122°F (-40°C to 50°C) | .07 | 1.78 | 1 |
| T12FR-C | Flame Retardant Polyethylene | White | 100 | 30.5 | 1/16 to 1/2 | 1.6 to 12.7 | .12 | 3.3 | -4°F to 212°F (-20°C to 100°C) | .03 | .76 | 1 |
| T12FR-C20 | Flame Retardant Polyethylene | Black | 100 | 30.5 | 1/16 to 1/2 | 1.6 to 12.7 | .12 | 3.3 | -4°F to 212°F (-20°C to 100°C) | .03 | .76 | 1 |
| T19FR-C | Flame Retardant Polyethylene | White | 100 | 30.5 | 1/8 to 1 | 3.2 to 25.4 | .19 | 4.8 | -4°F to 212°F (-20°C to 100°C) | .03 | .89 | 1 |
| T19FR-C20 | Flame Retardant Polyethylene | Black | 100 | 30.5 | 1/8 to 1 | 3.2 to 25.4 | .19 | 4.8 | -4°F to 212°F (-20°C to 100°C) | .03 | .89 | 1 |
| T25FR-C | Flame Retardant Polyethylene | White | 100 | 30.5 | 3/16 to 2 | 4.8 to 50.4 | .25 | 6.4 | -4°F to 212°F (-20°C to 100°C) | .04 | 1.02 | 1 |
| T25FR-C20 | Flame Retardant Polyethylene | Black | 100 | 30.5 | 3/16 to 2 | 4.8 to 50.4 | .25 | 6.4 | -4°F to 212°F (-20°C to 100°C) | .04 | 1.02 | 1 |
| T38FR-C | Flame Retardant Polyethylene | White | 100 | 30.5 | 5/16 to 3 | 7.9 to 76.2 | .38 | 9.5 | -4°F to 212°F (-20°C to 100°C) | .05 | 1.40 | 1 |
| T38FR-C20 | Flame Retardant Polyethylene | Black | 100 | 30.5 | 5/16 to 3 | 7.9 to 76.2 | .38 | 9.5 | -4°F to 212°F (-20°C to 100°C) | .05 | 1.40 | 1 |
| T50FR-C | Flame Retardant Polyethylene | White | 100 | 30.5 | 3/8 to 4 | 9.5 to 101.6 | .50 | 12.7 | -4°F to 212°F (-20°C to 100°C) | .06 | 1.50 | 1 |
| T50FR-C20 | Flame Retardant Polyethylene | Black | 100 | 30.5 | 3/8 to 4 | 9.5 to 101.6 | .50 | 12.7 | -4°F to 212°F (-20°C to 100°C) | .06 | 1.50 | 1 |
| T62FR-C | Flame Retardant Polyethylene | White | 100 | 30.5 | 1/2 to 4 1/2 | 12.7 to 114.3 | .62 | 15.9 | -4°F to 212°F (-20°C to 100°C) | .06 | 1.57 | 1 |
| T62FR-C20 | Flame Retardant Polyethylene | Black | 100 | 30.5 | 1/2 to 4 1/2 | 12.7 to 114.3 | .62 | 15.9 | -4°F to 212°F (-20°C to 100°C) | .06 | 1.57 | 1 |
| T75FR-C | Flame Retardant Polyethylene | White | 100 | 30.5 | 5/8 to 5 | 15.9 to 127.0 | .75 | 19.1 | -4°F to 212°F (-20°C to 100°C) | .06 | 1.65 | 1 |
| T75FR-C20 | Flame Retardant Polyethylene | Black | 100 | 30.5 | 5/8 to 5 | 15.9 to 127.0 | .75 | 19.1 | -4°F to 212°F (-20°C to 100°C) | .06 | 1.65 | 1 |
| T100FR-C | Flame Retardant Polyethylene | White | 100 | 30.5 | 7/8 to 6 | 22.2 to 152.4 | 1.00 | 25.4 | -4°F to 212°F (-20°C to 100°C) | .07 | 1.78 | 1 |
| T100FR-C20 | Flame Retardant Polyethylene | Black | 100 | 30.5 | 7/8 to 6 | 22.2 to 152.4 | 1.00 | 25.4 | -4°F to 212°F (-20°C to 100°C) | .07 | 1.78 | 1 |
| T12N-C | Nylon 6.6 | Natural | 100 | 30.5 | 1/16 to 1/2 | 1.6 to 12.7 | .12 | 3.3 | -40°F to 149°F (-40°C to 65°C) | .03 | .76 | 1 |
| T19N-C | Nylon 6.6 | Natural | 100 | 30.5 | 3/16 to 2 | 4.8 to 50.4 | .25 | 6.4 | -40°F to 149°F (-40°C to 65°C) | .04 | 1.02 | 1 |
| T25N-C | Nylon 6.6 | Natural | 100 | 30.5 | 1/8 to 1 | 3.2 to 25.4 | .19 | 4.8 | -40°F to 149°F (-40°C to 65°C) | .03 | .89 | 1 |
| T38N-C | Nylon 6.6 | Natural | 100 | 30.5 | 5/16 to 3 | 7.9 to 76.2 | .38 | 9.7 | -40°F to 149°F (-40°C to 65°C) | .05 | 1.40 | 1 |

*Flame retardant products are manufactured from a material that is rated UL 94V-0.
 ‡Reel packaging may contain splices. Contact *PANDUIT* Customer Service for further information.

Spiral Wrap (continued)

| Part Number | Material* | Color | Length per Reel | | Bundle Diameter Range | | Outside Diameter | | Temperature Range | Wall Thickness | | Std. Pkg. Qty. |
|-------------|-----------------------------|---------|-----------------|------|-----------------------|---------------|------------------|------|---------------------------------|----------------|------|----------------|
| | | | Ft. | m | In. | mm | In. | mm | | In. | mm | |
| T50N-C | Nylon 6.6 | Natural | 100 | 30.5 | 3/8 to 4 | 9.5 to 101.6 | .50 | 12.7 | -40°F to 149°F (-40°C to 65°C) | .06 | 1.50 | 1 |
| T62N-C | Nylon 6.6 | Natural | 100 | 30.5 | 1/2 to 4 1/2 | 12.7 to 114.3 | .62 | 15.9 | -40°F to 149°F (-40°C to 65°C) | .06 | 1.57 | 1 |
| T75N-C | Nylon 6.6 | Natural | 100 | 30.5 | 5/8 to 5 | 15.9 to 127.0 | .75 | 19.1 | -40°F to 149°F (-40°C to 65°C) | .06 | 1.65 | 1 |
| T100N-C | Nylon 6.6 | Natural | 100 | 30.5 | 7/8 to 6 | 22.2 to 152.4 | 1.00 | 25.4 | -40°F to 149°F (-40°C to 65°C) | .07 | 1.78 | 1 |
| T12N-C0 | Weather Resistant Nylon 6.6 | Black | 100 | 30.5 | 1/16 to 1/2 | 1.6 to 12.7 | .12 | 3.3 | -40°F to 149°F (-40°C to 65°C) | .03 | .76 | 1 |
| T19N-C0 | Weather Resistant Nylon 6.6 | Black | 100 | 30.5 | 1/8 to 1 | 3.2 to 25.4 | .19 | 4.8 | -40°F to 149°F (-40°C to 65°C) | .03 | .89 | 1 |
| T25N-C0 | Weather Resistant Nylon 6.6 | Black | 100 | 30.5 | 3/16 to 2 | 4.8 to 50.4 | .25 | 6.4 | -40°F to 149°F (-40°C to 65°C) | .04 | 1.02 | 1 |
| T38N-C0 | Weather Resistant Nylon 6.6 | Black | 100 | 30.5 | 5/16 to 3 | 7.9 to 76.2 | .38 | 9.7 | -40°F to 149°F (-40°C to 65°C) | .05 | 1.40 | 1 |
| T50N-C0 | Weather Resistant Nylon 6.6 | Black | 100 | 30.5 | 3/8 to 4 | 9.5 to 101.6 | .50 | 12.7 | -40°F to 149°F (-40°C to 65°C) | .06 | 1.50 | 1 |
| T62N-C0 | Weather Resistant Nylon 6.6 | Black | 100 | 30.5 | 1/2 to 4 1/2 | 12.7 to 114.3 | .62 | 15.9 | -40°F to 149°F (-40°C to 65°C) | .06 | 1.57 | 1 |
| T75N-C0 | Weather Resistant Nylon 6.6 | Black | 100 | 30.5 | 5/8 to 5 | 15.9 to 127.0 | .75 | 19.1 | -40°F to 149°F (-40°C to 65°C) | .06 | 1.65 | 1 |
| T100N-C0 | Weather Resistant Nylon 6.6 | Black | 100 | 30.5 | 7/8 to 6 | 22.2 to 152.4 | 1.00 | 25.4 | -40°F to 149°F (-40°C to 65°C) | .07 | 1.78 | 1 |
| T12T-C | TEFLON* | Natural | 100 | 30.5 | 1/16 to 1/2 | 1.6 to 12.7 | .12 | 3.2 | -40°F to 500°F (-40°C to 260°C) | .03 | .76 | 1 |
| T19T-C | TEFLON* | Natural | 100 | 30.5 | 1/8 to 1 | 3.2 to 25.4 | .19 | 4.8 | -40°F to 500°F (-40°C to 260°C) | .03 | .89 | 1 |
| T25T-L | TEFLON* | Natural | 50 | 15.2 | 3/16 to 2 | 4.8 to 50.4 | .25 | 6.4 | -40°F to 500°F (-40°C to 260°C) | .04 | 1.02 | 1 |
| T50T-Q | TEFLON* | Natural | 25 | 7.6 | 3/8 to 4 | 9.5 to 101.6 | .50 | 12.7 | -40°F to 500°F (-40°C to 260°C) | .06 | 1.50 | 1 |
| T62T-Q | TEFLON* | Natural | 25 | 7.6 | 1/2 to 4 1/2 | 12.7 to 114.3 | .62 | 15.9 | -40°F to 500°F (-40°C to 260°C) | .06 | 1.57 | 1 |
| T75T-X | TEFLON* | Natural | 10 | 3.05 | 5/8 to 5 | 15.9 to 127.0 | .75 | 19.1 | -40°F to 500°F (-40°C to 260°C) | .06 | 1.65 | 1 |
| T100T-X | TEFLON* | Natural | 10 | 3.05 | 7/8 to 6 | 22.2 to 152.4 | 1.00 | 25.4 | -40°F to 500°F (-40°C to 260°C) | .07 | 1.78 | 1 |

*Flame retardant products are manufactured from a material that is rated UL 94V-0.

‡Reel packaging may contain splices. Contact PANDUIT Customer Service for further information.

*TEFLON or equivalent fluoropolymer PTFE material is used. TEFLON is a registered trademark of E.I. du Pont de Nemours and Company.

A.
System
Overview

B1.
Cable Ties

B2.
Cable
Accessories

B3.
Stainless
Steel Ties

C1.
Wiring
Duct

C2.
Surface
Raceway

C3.
Abrasion
Protection

C4.
Cable
Management

D1.
Terminals

D2.
Power
Connectors

D3.
Grounding
Connectors

E1.
Labeling
Systems

E2.
Labels

E3.
Pre-Printed
& Write-On
Markers

E4.
Permanent
Identification

E5.
Lockout/
Tagout
& Safety
Solutions

F.
Index

A. System Overview

Part Number System for Grommet Edging

B1. Cable Ties

GEE

36

F

-

A

-

C

0

B2. Cable Accessories

Type

Max. Panel Thickness

Material

Adhesive

Package Size

Color Suffix

GE = Grommet Edging Strips
 GEE = Slotted Grommet Edging
 GES = Solid Grommet Edging

36 = .036" thickness
 62 = .062" thickness
 99 = .099" thickness
 144 = .144" thickness
 189 = .189" thickness

F = Polyethylene
 N = Nylon 6.6
 FR = Flame Retardant Polyethylene

A = Adhesive Lined
 Leave Blank = Non-Adhesive

Q = 25'
 L = 50'
 C = 100'

0 = Weather Resistant Black
 Leave Blank = Natural

B3. Stainless Steel Ties

C1. Wiring Duct

C2. Surface Raceway

C3. Abrasion Protection

Grommet Edging

- Use product on irregularly shaped and round panel hole
- Provided in .030 inch (.8mm) thick material making it highly flexible

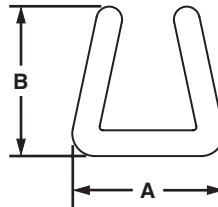
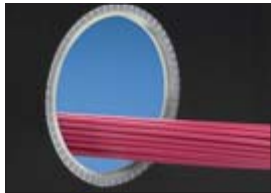

C4. Cable Management

D1. Terminals

D2. Power Connectors

D3. Grounding Connectors

| Part Number | Width A | | Height B | | Panel Thickness Range | | Material | Color | Temperature Range | Std. Pkg. Qty.‡ |
|-------------------|---------|-----|----------|-----|-----------------------|-----------|--------------------------------|---------|-----------------------------------|-----------------|
| | In. | mm | In. | mm | In. | mm | | | | |
| Slotted | | | | | | | | | | |
| GEE36F-C | .11 | 2.7 | .12 | 3.0 | .026 – .036 | 0.7 – 0.9 | Polyethylene | Natural | -40°F to 122°F (-40°C to 50°C) | 1 |
| GEE36F-C0 | .11 | 2.7 | .12 | 3.0 | .026 – .036 | 0.7 – 0.9 | Weather Resistant Polyethylene | Black | | 1 |
| GEE62F-C | .13 | 3.3 | .16 | 4.1 | .036 – .062 | 0.9 – 1.6 | Polyethylene | Natural | | 1 |
| GEE62F-C0 | .13 | 3.3 | .16 | 4.1 | .036 – .062 | 0.9 – 1.6 | Weather Resistant Polyethylene | Black | | 1 |
| GEE99F-C | .17 | 4.3 | .19 | 4.7 | .062 – .099 | 1.6 – 2.5 | Polyethylene | Natural | | 1 |
| GEE99F-C0 | .17 | 4.3 | .19 | 4.7 | .062 – .099 | 1.6 – 2.5 | Weather Resistant Polyethylene | Black | | 1 |
| GEE144F-C | .21 | 5.3 | .22 | 5.6 | .099 – .144 | 2.5 – 3.7 | Polyethylene | Natural | | 1 |
| GEE144F-C0 | .22 | 5.3 | .22 | 5.6 | .099 – .144 | 2.5 – 3.7 | Weather Resistant Polyethylene | Black | | 1 |

‡Reel packaging may contain splices. Contact PANDUIT Customer Service for further information.

E5. Lockout/Tagout & Safety Solutions

F. Index

Grommet Edging (continued)

| Part Number | Width A | | Height B | | Panel Thickness Range | | Material | Color | Temperature Range | Std. Pkg. Qty.‡ |
|--------------------------------|---------|-----|----------|-----|-----------------------|-----------|--------------------------------|---------|-----------------------------------|-----------------|
| | In. | mm | In. | mm | In. | mm | | | | |
| Solid | | | | | | | | | | |
| GES36F-C | .11 | 2.8 | .12 | 3.1 | .026 – .036 | 0.7 – 0.9 | Polyethylene | Natural | -40°F to 122°F (-40°C to 50°C) | 1 |
| GES36F-C0 | .11 | 2.8 | .12 | 3.1 | .026 – .036 | 0.7 – 0.9 | Weather Resistant Polyethylene | Black | | 1 |
| GES62F-C | .13 | 3.3 | .16 | 4.1 | .036 – .062 | 0.9 – 1.6 | Polyethylene | Natural | | 1 |
| GES62F-C0 | .13 | 3.3 | .16 | 4.1 | .036 – .062 | 0.9 – 1.6 | Weather Resistant Polyethylene | Black | | 1 |
| GES99F-C | .17 | 4.3 | .19 | 4.8 | .062 – .099 | 1.6 – 2.5 | Polyethylene | Natural | | 1 |
| GES99F-C0 | .17 | 4.3 | .19 | 4.8 | .062 – .099 | 1.6 – 2.5 | Weather Resistant Polyethylene | Black | | 1 |
| GES144F-C | .21 | 5.3 | .22 | 5.6 | .099 – .144 | 2.5 – 3.7 | Polyethylene | Natural | | 1 |
| GES144F-C0 | .21 | 5.3 | .22 | 5.6 | .099 – .144 | 2.5 – 3.7 | Weather Resistant Polyethylene | Black | | 1 |
| GES189F-C | .30 | 7.6 | .30 | 7.6 | .144 – .189 | 3.7 – 4.8 | Polyethylene | Natural | | 1 |
| GES189F-C0 | .30 | 7.6 | .30 | 7.6 | .144 – .189 | 3.7 – 4.8 | Weather Resistant Polyethylene | Natural | | 1 |
| Slotted Adhesive Lined | | | | | | | | | | |
| GEE62F-A-C | .13 | 3.3 | .16 | 4.1 | .036 – .062 | 0.9 – 1.6 | Polyethylene | Natural | -40°F to 122°F (-40°C to 50°C) | 1 |
| GEE62F-A-C0 | .13 | 3.3 | .16 | 4.1 | .036 – .062 | 0.9 – 1.6 | Weather Resistant Polyethylene | Black | | 1 |
| GEE99F-A-C | .17 | 4.3 | .19 | 4.7 | .062 – .099 | 1.6 – 2.5 | Polyethylene | Natural | | 1 |
| GEE99F-A-C0 | .17 | 4.3 | .19 | 4.7 | .062 – .099 | 1.6 – 2.5 | Weather Resistant Polyethylene | Black | | 1 |
| GEE144F-A-C | .21 | 5.3 | .22 | 5.6 | .099 – .144 | 2.5 – 3.7 | Polyethylene | Natural | | 1 |
| GEE144F-A-C0 | .21 | 5.3 | .22 | 5.6 | .099 – .144 | 2.5 – 3.7 | Weather Resistant Polyethylene | Black | | 1 |
| Solid Adhesive Lined | | | | | | | | | | |
| GES62F-A-C | .13 | 3.3 | .16 | 4.1 | .036 – .062 | 0.9 – 1.6 | Polyethylene | Natural | -40°F to 122°F (-40°C to 50°C) | 1 |
| GES62F-A-C0 | .13 | 3.3 | .16 | 4.1 | .036 – .062 | 0.9 – 1.6 | Weather Resistant Polyethylene | Black | | 1 |
| GES99F-A-C | .17 | 4.3 | .19 | 4.8 | .062 – .099 | 1.6 – 2.5 | Polyethylene | Natural | | 1 |
| GES99F-A-C0 | .17 | 4.3 | .19 | 4.8 | .062 – .099 | 1.6 – 2.5 | Weather Resistant Polyethylene | Black | | 1 |
| GES144F-A-C | .21 | 5.3 | .22 | 5.6 | .099 – .144 | 2.5 – 3.7 | Polyethylene | Natural | | 1 |
| GES144F-A-C0 | .21 | 5.3 | .22 | 5.6 | .099 – .144 | 2.5 – 3.7 | Weather Resistant Polyethylene | Black | | 1 |
| Slotted Flame Retardant | | | | | | | | | | |
| GEE36FR-C | .11 | 2.7 | .12 | 4.1 | .036 – .062 | 0.9 – 1.6 | Flame Retardant Polyethylene | Natural | -40°F to 194°F (-40°C to 90°C) | 1 |
| GEE62FR-C | .13 | 3.3 | .160 | 4.1 | .036 – .062 | 0.9 – 1.6 | Flame Retardant Polyethylene | Natural | | 1 |
| GEE99FR-C | .17 | 4.3 | .160 | 3.9 | .062 – .099 | 1.6 – 2.5 | Flame Retardant Polyethylene | Natural | | 1 |
| GEE144FR-C | .21 | 5.3 | .222 | 5.9 | .099 – .144 | 2.5 – 3.7 | Flame Retardant Polyethylene | Natural | | 1 |

‡Reel packaging may contain splices. Contact PANDUIT Customer Service for further information.

Table continues on page C3.10

A.
System
Overview

Grommet Edging (continued)

B1.
Cable Ties

| Part Number | Width A | | Height B | | Panel Thickness Range | | Material | Color | Temperature Range | Std. Pkg. Qty.‡ |
|-------------|------------|----|-------------|----|-----------------------|----|----------|-------|----------------------|-----------------------|
| | In. | mm | In. | mm | In. | mm | | | | |

B2.
Cable
Accessories

Solid Flame Retardant

| | | | | | | | | | | |
|-------------------|-----|-----|-----|-----|-------------|-----------|---------------------------------|---------|-----------------------------------|---|
| GES36FR-C | .11 | 2.8 | .12 | 3.1 | .036 – .062 | 0.9 – 1.6 | Polyethylene | Natural | -40°F to 122°F (-40°C to 50°C) | 1 |
| GES62FR-C | .13 | 3.3 | .16 | 4.1 | .036 – .062 | 0.9 – 1.6 | Flame Retardant Polyethylene | Natural | -40°F to 194°F (-40°C to 90°C) | 1 |
| GES99FR-C | .17 | 4.3 | .19 | 4.8 | .062 – .099 | 1.6 – 2.5 | Flame Retardant Polyethylene | Natural | | 1 |
| GES144FR-C | .21 | 5.3 | .22 | 5.6 | .099 – .144 | 2.5 – 3.7 | Flame Retardant Polyethylene | Natural | | 1 |

B3.
Stainless
Steel Ties

C1.
Wiring
Duct

Slotted Nylon

| | | | | | | | | | | |
|------------------|-----|-----|-----|-----|-------------|-----------|-----------|---------|-----------------------------------|---|
| GEE47N-C | .13 | 3.3 | .14 | 3.5 | .039 – .055 | 1.0 – 1.4 | Nylon 6.6 | Natural | -40°F to 149°F (-40°C to 65°C) | 1 |
| GEE55N-C | .13 | 3.4 | .14 | 3.5 | .047 – .063 | 1.2 – 1.6 | Nylon 6.6 | Natural | | 1 |
| GEE71N-C | .15 | 3.8 | .14 | 3.5 | .063 – .079 | 1.6 – 2.0 | Nylon 6.6 | Natural | | 1 |
| GEE98N-C | .18 | 4.6 | .14 | 3.5 | .091 – .106 | 2.3 – 2.7 | Nylon 6.6 | Natural | | 1 |
| GEE134N-C | .21 | 5.3 | .14 | 3.5 | .126 – .142 | 3.2 – 3.6 | Nylon 6.6 | Natural | | 1 |

C2.
Surface
Raceway

C3.
Abrasion
Protection

C4.
Cable
Management

Military Standard MS21266 in 12 3/4" Lengths

| | | | | | | | | | | |
|------------------|-----|------|-----|-----|-------------|------------|------------------------------|---------|-----------------------------------|-----|
| GE52-C | .15 | 3.8 | .16 | 3.9 | .015 – .052 | 0.4 – 1.3 | Nylon 6.6 | Natural | -40°F to 149°F (-40°C to 65°C) | 100 |
| GE52-C69 | .15 | 3.8 | .16 | 3.9 | .015 – .052 | 0.4 – 1.3 | Flame Retardant Nylon 6.6 | Natural | | 100 |
| GE85-C | .18 | 4.5 | .16 | 3.9 | .052 – .085 | 1.3 – 2.2 | Nylon 6.6 | Natural | | 100 |
| GE85-C69 | .18 | 4.5 | .16 | 3.9 | .052 – .085 | 1.3 – 2.2 | Flame Retardant Nylon 6.6 | Natural | | 100 |
| GE128-C | .22 | 5.6 | .16 | 3.9 | .085 – .128 | 2.2 – 3.3 | Nylon 6.6 | Natural | | 100 |
| GE128-C69 | .22 | 5.6 | .16 | 3.9 | .085 – .128 | 2.2 – 3.3 | Flame Retardant Nylon 6.6 | Natural | | 100 |
| GE192-L | .33 | 8.3 | .23 | 5.8 | .128 – .192 | 3.3 – 4.9 | Nylon 6.6 | Natural | | 50 |
| GE192-L69 | .33 | 8.3 | .23 | 5.8 | .128 – .192 | 3.3 – 4.9 | Flame Retardant Nylon 6.6 | Natural | | 50 |
| GE255-L | .39 | 9.8 | .24 | 6.1 | .192 – .255 | 4.9 – 6.5 | Nylon 6.6 | Natural | | 50 |
| GE318-L | .46 | 11.3 | .26 | 6.5 | .255 – .318 | 6.5 – 8.1 | Nylon 6.6 | Natural | | 50 |
| GE380-Q | .52 | 13.1 | .26 | 6.5 | .318 – .380 | 8.1 – 9.7 | Nylon 6.6 | Natural | | 25 |
| GE510-Q | .64 | 16.3 | .26 | 6.5 | .380 – .510 | 9.7 – 13.0 | Nylon 6.6 | Natural | | 25 |

‡Reel packaging may contain splices. Contact PANDUIT Customer Service for further information.

E4.
Permanent
Identification

E5.
Lockout/
Tagout/
& Safety
Solutions

F.
Index

Part Number System for Corrugated Loom Tubing

| | | | | | |
|--------------------------------------|---|---|---|--|--|
| CLT | 100 | N | - | C | 630 |
| Type | Bundle Diameter | Material | | Package Size | Color Suffix |
| CLT = Slit Wall CLTS = Solid Wall | 25 = 1/4" 35 = 5/16" 38 = 3/8" 50 = 1/2" 62 = 5/8" 75 = 3/4" 100 = 1" 125 = 1 1/4" 150 = 1 1/2" 188 = 1 7/8" | N = Heat Stabilized Nylon F = Polyethylene | | X = 10' L = 50' C = 100' T = 200' D = 500' | 630 = Heat Stabilized Black Nylon 6 20 = Black Polyethylene 3 = Orange Polyethylene 4 = Yellow Polyethylene |

Corrugated Loom Tubing – Slit

- Provides protection for cables
- Packaged on a reel for easy handling and dispensing of product
- For indoor use only



| Part Number | Material | Color | Length per Reel | | Inside Diameter | | Outside Diameter | | Temperature Range | Std. Pkg. Qty.* |
|-------------|--------------|--------|-----------------|------|-----------------|------|------------------|------|--------------------------------|-----------------|
| | | | Ft. | m | In. | mm | In. | mm | | |
| CLT25F-C3 | Polyethylene | Orange | 100 | 30.5 | .27 | 6.7 | .39 | 9.9 | -40°F to 122°F (-40°C to 50°C) | 1 |
| CLT25F-C20 | Polyethylene | Black | 100 | 30.5 | .27 | 6.7 | .39 | 9.9 | -40°F to 122°F (-40°C to 50°C) | 1 |
| CLT38F-C3 | Polyethylene | Orange | 100 | 30.5 | .41 | 10.5 | .56 | 14.2 | -40°F to 122°F (-40°C to 50°C) | 1 |
| CLT38F-C20 | Polyethylene | Black | 100 | 30.5 | .41 | 10.5 | .56 | 14.2 | -40°F to 122°F (-40°C to 50°C) | 1 |
| CLT50F-C3 | Polyethylene | Orange | 100 | 30.5 | .51 | 12.8 | .67 | 17.0 | -40°F to 122°F (-40°C to 50°C) | 1 |
| CLT50F-C20 | Polyethylene | Black | 100 | 30.5 | .51 | 12.8 | .67 | 17.0 | -40°F to 122°F (-40°C to 50°C) | 1 |
| CLT75F-C3 | Polyethylene | Orange | 100 | 30.5 | .76 | 19.3 | .94 | 23.8 | -40°F to 122°F (-40°C to 50°C) | 1 |
| CLT75F-C20 | Polyethylene | Black | 100 | 30.5 | .76 | 19.3 | .94 | 23.8 | -40°F to 122°F (-40°C to 50°C) | 1 |
| CLT100F-C3 | Polyethylene | Orange | 100 | 30.5 | .92 | 23.2 | 1.09 | 27.7 | -40°F to 122°F (-40°C to 50°C) | 1 |
| CLT100F-C20 | Polyethylene | Black | 100 | 30.5 | .92 | 23.2 | 1.09 | 27.7 | -40°F to 122°F (-40°C to 50°C) | 1 |
| CLT125F-L3 | Polyethylene | Orange | 50 | 15.2 | 1.29 | 32.8 | 1.50 | 38.1 | -40°F to 122°F (-40°C to 50°C) | 1 |
| CLT125F-L4 | Polyethylene | Yellow | 50 | 15.2 | 1.29 | 32.8 | 1.50 | 38.1 | -40°F to 122°F (-40°C to 50°C) | 1 |
| CLT125F-L20 | Polyethylene | Black | 50 | 15.2 | 1.29 | 32.8 | 1.50 | 38.1 | -40°F to 122°F (-40°C to 50°C) | 1 |
| CLT150F-T20 | Polyethylene | Black | 200 | 61.0 | 1.55 | 39.1 | 1.86 | 47.2 | -40°F to 122°F (-40°C to 50°C) | 1 |
| CLT150F-X3 | Polyethylene | Orange | 10 | 3.0 | 1.55 | 39.1 | 1.86 | 47.2 | -40°F to 122°F (-40°C to 50°C) | 1 |
| CLT150F-X4 | Polyethylene | Yellow | 10 | 3.0 | 1.55 | 39.1 | 1.86 | 47.2 | -40°F to 122°F (-40°C to 50°C) | 1 |
| CLT150F-X20 | Polyethylene | Black | 10 | 3.0 | 1.55 | 39.1 | 1.86 | 47.2 | -40°F to 122°F (-40°C to 50°C) | 1 |
| CLT188F-X3 | Polyethylene | Orange | 10 | 3.0 | 1.88 | 47.8 | 2.17 | 55.1 | -40°F to 122°F (-40°C to 50°C) | 1 |
| CLT188F-X4 | Polyethylene | Yellow | 10 | 3.0 | 1.88 | 47.8 | 2.17 | 55.1 | -40°F to 122°F (-40°C to 50°C) | 1 |
| CLT188F-X20 | Polyethylene | Black | 10 | 3.0 | 1.88 | 47.8 | 2.17 | 55.1 | -40°F to 122°F (-40°C to 50°C) | 1 |

*Reel packaging may contain splices. Contact PANDUIT Customer Service for further information.

Table continues on page C3.12

A. System Overview

Corrugated Loom Tubing – Slit (continued)

B1. Cable Ties

| Part Number | Material | Color | Length per Reel | | Inside Diameter | | Outside Diameter | | Temperature Range | Std. Pkg. Qty.* |
|-------------|----------|-------|-----------------|---|-----------------|----|------------------|----|-------------------|-----------------|
| | | | Ft. | m | In. | mm | In. | mm | | |

Solid Wall

B2. Cable Accessories

B3. Stainless Steel Ties

C1. Wiring Duct

C2. Surface Raceway

| | | | | | | | | | | |
|-------------|--------------|--------|-----|-------|------|------|------|------|--------------------------------|---|
| CLTS25F-C3 | Polyethylene | Orange | 100 | 30.5 | .28 | 7.0 | .39 | 9.9 | -40°F to 122°F (-40°C to 50°C) | 1 |
| CLTS25F-C | Polyethylene | Black | 100 | 30.5 | .28 | 7.0 | .39 | 9.9 | -40°F to 122°F (-40°C to 50°C) | 1 |
| CLTS38F-C3 | Polyethylene | Orange | 100 | 30.5 | .42 | 10.5 | .56 | 14.1 | -40°F to 122°F (-40°C to 50°C) | 1 |
| CLTS38F-C | Polyethylene | Black | 100 | 30.5 | .42 | 10.5 | .56 | 14.1 | -40°F to 122°F (-40°C to 50°C) | 1 |
| CLTS50F-C3 | Polyethylene | Orange | 100 | 30.5 | .51 | 12.8 | .67 | 17.0 | -40°F to 122°F (-40°C to 50°C) | 1 |
| CLTS50F-C | Polyethylene | Black | 100 | 30.5 | .51 | 12.8 | .67 | 17.0 | -40°F to 122°F (-40°C to 50°C) | 1 |
| CLTS75F-C3 | Polyethylene | Orange | 100 | 30.5 | .76 | 19.3 | .94 | 23.8 | -40°F to 122°F (-40°C to 50°C) | 1 |
| CLTS75F-C | Polyethylene | Black | 100 | 30.5 | .76 | 19.3 | .94 | 23.8 | -40°F to 122°F (-40°C to 50°C) | 1 |
| CLTS100F-C3 | Polyethylene | Orange | 100 | 30.5 | .92 | 23.2 | 1.09 | 27.7 | -40°F to 122°F (-40°C to 50°C) | 1 |
| CLTS100F-C | Polyethylene | Black | 100 | 30.5 | .92 | 23.2 | 1.09 | 27.7 | -40°F to 122°F (-40°C to 50°C) | 1 |
| CLTS125F-L3 | Polyethylene | Orange | 50 | 15.2 | 1.29 | 32.8 | 1.50 | 38.1 | -40°F to 122°F (-40°C to 50°C) | 1 |
| CLTS125F-L | Polyethylene | Black | 50 | 15.2 | 1.29 | 32.8 | 1.50 | 38.1 | -40°F to 122°F (-40°C to 50°C) | 1 |
| CLTS150F-D3 | Polyethylene | Orange | 500 | 152.4 | 1.48 | 37.6 | 1.73 | 43.9 | -40°F to 122°F (-40°C to 50°C) | 1 |

Nylon Slotted

C3. Abrasion Protection

C4. Cable Management

D1. Terminals

D2. Power Connectors

| | | | | | | | | | | |
|---------------|---------------------------|-------|-----|-------|------|------|------|------|---------------------------------|---|
| CLT25N-C630 | Heat Stabilized Nylon 6.6 | Black | 100 | 30.5 | .27 | 6.7 | .39 | 9.9 | -40°F to 230°F (-40°C to 110°C) | 1 |
| CLT35N-C630 | Heat Stabilized Nylon 6.6 | Black | 100 | 30.5 | .35 | 8.9 | .50 | 12.7 | -40°F to 230°F (-40°C to 110°C) | 1 |
| CLT38N-C630 | Heat Stabilized Nylon 6.6 | Black | 100 | 30.5 | .41 | 10.5 | .56 | 14.2 | -40°F to 230°F (-40°C to 110°C) | 1 |
| CLT50N-C630 | Heat Stabilized Nylon 6.6 | Black | 100 | 30.5 | .51 | 12.8 | .67 | 17.0 | -40°F to 230°F (-40°C to 110°C) | 1 |
| CLT75N-C630 | Heat Stabilized Nylon 6.6 | Black | 100 | 30.5 | .76 | 19.3 | .94 | 23.8 | -40°F to 230°F (-40°C to 110°C) | 1 |
| CLT100N-C630 | Heat Stabilized Nylon 6.6 | Black | 100 | 30.5 | .92 | 23.2 | 1.09 | 27.7 | -40°F to 230°F (-40°C to 110°C) | 1 |
| CLT125N-L630 | Heat Stabilized Nylon 6.6 | Black | 50 | 15.2 | 1.29 | 32.8 | 1.50 | 38.1 | -40°F to 230°F (-40°C to 110°C) | 1 |
| CLT150N-D630 | Heat Stabilized Nylon 6.6 | Black | 500 | 152.4 | 1.55 | 39.1 | 1.86 | 47.2 | -40°F to 230°F (-40°C to 110°C) | 1 |
| CLT188N-6C630 | Heat Stabilized Nylon 6.6 | Black | 600 | 183.0 | 1.88 | 47.8 | 2.17 | 55.1 | -40°F to 230°F (-40°C to 110°C) | 1 |

Nylon Solid

D3. Grounding Connectors

E1. Labeling Systems

E2. Labels

| | | | | | | | | | | |
|------------|---------------------------|-------|-----|------|-----|------|------|------|---------------------------------|---|
| CLTS25N-C | Heat Stabilized Nylon 6.6 | Black | 100 | 30.5 | .28 | 7.0 | .39 | 9.9 | -40°F to 230°F (-40°C to 110°C) | 1 |
| CLTS35N-C | Heat Stabilized Nylon 6.6 | Black | 100 | 30.5 | .35 | 8.9 | .50 | 12.7 | -40°F to 230°F (-40°C to 110°C) | 1 |
| CLTS38N-C | Heat Stabilized Nylon 6.6 | Black | 100 | 30.5 | .42 | 10.5 | .56 | 14.1 | -40°F to 230°F (-40°C to 110°C) | 1 |
| CLTS50N-C | Heat Stabilized Nylon 6.6 | Black | 100 | 30.5 | .51 | 12.8 | .67 | 17.0 | -40°F to 230°F (-40°C to 110°C) | 1 |
| CLTS75N-C | Heat Stabilized Nylon 6.6 | Black | 100 | 30.5 | .76 | 19.3 | .94 | 23.8 | -40°F to 230°F (-40°C to 110°C) | 1 |
| CLTS100N-C | Heat Stabilized Nylon 6.6 | Black | 100 | 30.5 | .92 | 23.4 | 1.09 | 27.7 | -40°F to 230°F (-40°C to 110°C) | 1 |

*Reel packaging may contain splices. Contact PANDUIT Customer Service for further information.

E3. Pre-Printed & Write-On Markers

Corrugated Loom Tubing Fittings

- Provide a secure way to join CLT at junctions and breakouts while improving the appearance of wire harnesses
- Color: Black
- Material: Polyethylene



E4. Permanent Identification

E5. Lockout/Tagout & Safety Solutions

F. Index

| Part Number | Branch Diameter | | Trunk Diameter | | Std. Pkg. Qty. | Std. Ctn. Qty. |
|--------------------|-----------------|------|----------------|-----|----------------|----------------|
| | In. | mm | In. | mm | | |
| CF382538F-Q | .38 | 9.5 | .25 | 6.4 | 25 | 100 |
| CF502550F-Q | .50 | 12.7 | .25 | 6.4 | 25 | 100 |
| CF503850F-Q | .50 | 12.7 | .38 | 9.5 | 25 | 100 |
| CF752575F-Q | .75 | 19.0 | .25 | 6.4 | 25 | 100 |
| CF753875F-Q | .75 | 19.0 | .38 | 9.5 | 25 | 100 |

Part Number System for Braided Expandable Sleeving

| SE | 25 | PFR | - | M | R | 0 |
|--------------------------|-----------------------|--|----------|--------------------|----------|--------------|
| Type | Nominal I.D. Size | Material | | Package Size | R = Reel | Color Suffix |
| SE = Sleeving Expandable | 12 = 1/8" (3.2mm) | P = Polyethylene Terephthalate (PET) | | L = 50' (15.2M) | | 0 = Black |
| | 25 = 1/4" (6.4mm) | PFR = Polyethylene Terephthalate (PET) Flame Retardant | | C = 100' (30.5M) | | 8 = Gray |
| | 38 = 3/8" (9.5mm) | PSC = Fray Resistant Polyethylene Terephthalate (PET) | | T = 200' (61.0M) | | 10 = White |
| | 50 = 1/2" (12.7mm) | | | D = 500' (152.4M) | | |
| | 75 = 3/4" (19.1mm) | | | M = 1000' (304.8M) | | |
| | 125 = 1 1/4" (31.8mm) | | | | | |
| | 150 = 1 1/2" (38.1mm) | | | | | |
| | 175 = 1 3/4" (44.5mm) | | | | | |



Braided Expandable Sleeving – Polyethylene Terephthalate (PET)

- Provides continuous abrasion protection for wires, cables, hoses and tubing
- Highly flexible open weave will not trap heat or humidity



| Part Number | Color | Nominal I.D. | | Nominal Diameter Range | | Length per Reel | | Std. Pkg. Qty. | Std. Ctn. Qty. |
|-------------|-------|--------------|------|------------------------|--------------|-----------------|-------|----------------|----------------|
| | | In. | mm | In. | mm | Ft. | m | | |
| SE12P-TR0 | Black | .12 | 3.2 | .094 to .250 | 2.4 to 6.4 | 200 | 61.0 | 1 | 4 |
| SE12P-TR8 | Gray | .12 | 3.2 | .094 to .250 | 2.4 to 6.4 | 200 | 61.0 | 1 | 4 |
| SE12P-MR0 | Black | .12 | 3.2 | .094 to .250 | 2.4 to 6.4 | 1000 | 304.8 | 1 | 2 |
| SE12P-MR8 | Gray | .12 | 3.2 | .094 to .250 | 2.4 to 6.4 | 1000 | 304.8 | 1 | 2 |
| SE12P-MR10 | White | .12 | 3.2 | .094 to .250 | 2.4 to 6.4 | 1000 | 304.8 | 1 | 2 |
| SE25P-TR0 | Black | .25 | 6.4 | .125 to .375 | 3.2 to 9.5 | 200 | 61.0 | 1 | 4 |
| SE25P-TR8 | Gray | .25 | 6.4 | .125 to .375 | 3.2 to 9.5 | 200 | 61.0 | 1 | 4 |
| SE25P-MR0 | Black | .25 | 6.4 | .125 to .375 | 3.2 to 9.5 | 1000 | 304.8 | 1 | 2 |
| SE25P-MR8 | Gray | .25 | 6.4 | .125 to .375 | 3.2 to 9.5 | 1000 | 304.8 | 1 | 2 |
| SE25P-MR10 | White | .25 | 6.4 | .125 to .375 | 3.2 to 9.5 | 1000 | 304.8 | 1 | 2 |
| SE38P-TR0 | Black | .38 | 9.5 | .188 to .625 | 4.7 to 15.9 | 200 | 61.0 | 1 | 4 |
| SE38P-TR8 | Gray | .37 | 9.5 | .188 to .625 | 4.7 to 15.9 | 200 | 61.0 | 1 | 4 |
| SE38P-MR0 | Black | .37 | 9.5 | .188 to .625 | 4.7 to 15.9 | 1000 | 304.8 | 1 | 2 |
| SE38P-MR8 | Gray | .37 | 9.5 | .188 to .625 | 4.7 to 15.9 | 1000 | 304.8 | 1 | 2 |
| SE38P-MR10 | White | .37 | 9.5 | .188 to .625 | 4.7 to 15.9 | 1000 | 304.8 | 1 | 2 |
| SE50P-CR0 | Black | .50 | 12.7 | .250 to .750 | 6.4 to 19.1 | 100 | 30.5 | 1 | 4 |
| SE50P-CR8 | Gray | .50 | 12.7 | .250 to .750 | 6.4 to 19.1 | 100 | 30.5 | 1 | 4 |
| SE50P-DR0 | Black | .50 | 12.7 | .250 to .750 | 6.4 to 19.1 | 500 | 152.4 | 1 | 2 |
| SE50P-DR8 | Gray | .50 | 12.7 | .250 to .750 | 6.4 to 19.1 | 500 | 152.4 | 1 | 2 |
| SE50P-DR10 | White | .50 | 12.7 | .250 to .750 | 6.4 to 19.1 | 500 | 150.4 | 1 | 2 |
| SE75P-CR0 | Black | .75 | 19.1 | .500 to 1.25 | 12.7 to 31.8 | 100 | 30.5 | 1 | 4 |
| SE75P-CR8 | Gray | .75 | 19.1 | .500 to 1.25 | 12.7 to 31.8 | 100 | 30.5 | 1 | 4 |
| SE75P-DR0 | Black | .75 | 19.1 | .500 to 1.25 | 12.7 to 31.8 | 500 | 152.4 | 1 | 2 |
| SE75P-DR8 | Gray | .75 | 19.1 | .500 to 1.25 | 12.7 to 31.8 | 500 | 152.4 | 1 | 2 |
| SE75P-DR10 | White | .75 | 19.1 | .500 to 1.25 | 12.7 to 31.8 | 500 | 152.4 | 1 | 2 |
| SE125P-LR0 | Black | 1.25 | 31.8 | .750 to 1.50 | 19.1 to 38.1 | 50 | 15.2 | 1 | 4 |
| SE125P-LR8 | Gray | 1.25 | 31.8 | .750 to 1.50 | 19.1 to 38.1 | 50 | 15.2 | 1 | 4 |
| SE125P-TR0 | Black | 1.25 | 31.8 | .750 to 1.50 | 19.1 to 38.1 | 200 | 61.0 | 1 | 2 |
| SE125P-TR8 | Gray | 1.25 | 31.8 | .750 to 1.50 | 19.1 to 38.1 | 200 | 61.0 | 1 | 2 |
| SE125P-TR10 | White | 1.25 | 31.8 | .750 to 1.50 | 19.1 to 38.1 | 200 | 61.0 | 1 | 2 |
| SE150P-LR0 | Black | 1.50 | 38.1 | 1.00 to 2.25 | 25.4 to 57.2 | 50 | 15.2 | 1 | 4 |
| SE150P-LR8 | Gray | 1.50 | 38.1 | 1.00 to 2.25 | 25.4 to 57.2 | 50 | 15.2 | 1 | 4 |
| SE150P-TR0 | Black | 1.50 | 38.1 | 1.00 to 2.25 | 25.4 to 57.2 | 200 | 61.0 | 1 | 2 |
| SE150P-TR8 | Gray | 1.50 | 38.1 | 1.00 to 2.25 | 25.4 to 57.2 | 200 | 61.0 | 1 | 2 |
| SE150P-TR10 | White | 1.50 | 38.1 | 1.00 to 2.25 | 25.4 to 57.2 | 200 | 61.0 | 1 | 2 |
| SE175P-TR0 | Black | 1.75 | 44.5 | 1.25 to 2.75 | 31.8 to 69.8 | 200 | 61.0 | 1 | 2 |

Reel packaging may contain splices. Contact PANDUIT Customer Service for further information.

A. System Overview

B1. Cable Ties

B2. Cable Accessories

B3. Stainless Steel Ties

C1. Wiring Duct

C2. Surface Raceway

C3. Abrasion Protection

C4. Cable Management

D1. Terminals

D2. Power Connectors

D3. Grounding Connectors

E1. Labeling Systems

E2. Labels

E3. Pre-Printed & Write-On Markers

E4. Permanent Identification

E5. Lockout/Tagout & Safety Solutions

F. Index

A. System Overview



Braided Expandable Sleeving – Flame Retardant Polyethylene Terephthalate

B1. Cable Ties

- Provides continuous abrasion protection for wires, cables, hoses and tubing
- Highly flexible open weave will not trap heat or humidity
- Rated for use up to 257°F (125°C)
- Allows for use with irregular shapes
- Flammability: Meets UL 224 VW-1

B2. Cable Accessories



B3. Stainless Steel Ties

C1. Wiring Duct

C2. Surface Raceway

C3. Abrasion Protection

C4. Cable Management

D1. Terminals

D2. Power Connectors

D3. Grounding Connectors

E1. Labeling Systems

E2. Labels

E3. Pre-Printed & Write-On Markers

E4. Permanent Identification

E5. Lockout/Tagout & Safety Solutions

F. Index

| Part Number | Color | Nominal I.D. | | Nominal Diameter Range | | Length per reel | | Std. Pkg. Qty. | Std. Ctn. Qty. |
|----------------------|-------|--------------|------|------------------------|--------------|-----------------|-------|----------------|----------------|
| | | In. | mm | In. | mm | Ft. | m | | |
| SE12PFR-TR0 | Black | .12 | 3.2 | .094 to .250 | 2.4 to 6.4 | 200 | 61.0 | 1 | 4 |
| SE12PFR-MR0 | Black | .12 | 3.2 | .094 to .250 | 2.4 to 6.4 | 1000 | 304.8 | 1 | 2 |
| SE12PFR-TR8 | Gray | .12 | 3.2 | .094 to .250 | 2.4 to 6.4 | 200 | 61.0 | 1 | 4 |
| SE12PFR-MR8 | Gray | .12 | 3.2 | .094 to .250 | 2.4 to 6.4 | 1000 | 304.8 | 1 | 2 |
| SE12PFR-MR10 | White | .12 | 3.2 | .094 to .250 | 2.4 to 6.4 | 1000 | 304.8 | 1 | 2 |
| SE25PFR-TR0 | Black | .25 | 6.4 | .125 to .375 | 3.2 to 9.5 | 200 | 61.0 | 1 | 4 |
| SE25PFR-MR0 | Black | .25 | 6.4 | .125 to .375 | 3.2 to 9.5 | 1000 | 304.8 | 1 | 2 |
| SE25PFR-TR8 | Gray | .25 | 6.4 | .125 to .375 | 3.2 to 9.5 | 200 | 61.0 | 1 | 4 |
| SE25PFR-MR8 | Gray | .25 | 6.4 | .125 to .375 | 3.2 to 9.5 | 1000 | 304.8 | 1 | 2 |
| SE25PFR-MR10 | White | .25 | 6.4 | .125 to .375 | 3.2 to 9.5 | 1000 | 304.8 | 1 | 2 |
| SE38PFR-MR8 | Gray | .37 | 9.5 | .188 to .625 | 4.7 to 15.9 | 1000 | 304.8 | 1 | 2 |
| SE38PFR-MR10 | White | .37 | 9.5 | .188 to .625 | 4.7 to 15.9 | 1000 | 304.8 | 1 | 2 |
| SE50PFR-CR0 | Black | .50 | 12.7 | .250 to .750 | 6.4 to 19.1 | 100 | 30.5 | 1 | 4 |
| SE50PFR-CR8 | Gray | .50 | 12.7 | .250 to .750 | 6.4 to 19.1 | 100 | 30.5 | 1 | 4 |
| SE50PFR-DR0 | Black | .50 | 12.7 | .250 to .750 | 6.4 to 19.1 | 500 | 152.4 | 1 | 2 |
| SE50PFR-DR8 | Gray | .50 | 12.7 | .250 to .750 | 6.4 to 19.1 | 500 | 152.4 | 1 | 2 |
| SE50PFR-DR10 | White | .50 | 12.7 | .250 to .750 | 6.4 to 19.1 | 500 | 152.4 | 1 | 2 |
| SE75PFR-CR0 | Black | .75 | 19.1 | .500 to 1.25 | 12.7 to 31.8 | 100 | 30.5 | 1 | 4 |
| SE75PFR-CR8 | Gray | .75 | 19.1 | .500 to 1.25 | 12.7 to 31.8 | 100 | 30.5 | 1 | 4 |
| SE75PFR-DR0 | Black | .75 | 19.1 | .500 to 1.25 | 12.7 to 31.8 | 500 | 152.4 | 1 | 2 |
| SE75PFR-DR8 | Gray | .75 | 19.1 | .500 to 1.25 | 12.7 to 31.8 | 500 | 152.4 | 1 | 2 |
| SE75PFR-DR10 | White | .75 | 19.1 | .500 to 1.25 | 12.7 to 31.8 | 500 | 152.4 | 1 | 2 |
| SE125PFR-LR0 | Black | 1.25 | 31.8 | .750 to 1.50 | 19.1 to 38.1 | 50 | 15.2 | 1 | 4 |
| SE125PFR-LR8 | Gray | 1.25 | 31.8 | .750 to 1.50 | 19.1 to 38.1 | 50 | 15.2 | 1 | 4 |
| SE125PFR-TR0 | Black | 1.25 | 31.8 | .750 to 1.50 | 19.1 to 38.1 | 200 | 61.0 | 1 | 2 |
| SE125PFR-TR8 | Gray | 1.25 | 31.8 | .750 to 1.50 | 19.1 to 38.1 | 200 | 61.0 | 1 | 2 |
| SE125PFR-TR10 | White | 1.25 | 31.8 | .750 to 1.50 | 19.1 to 38.1 | 200 | 61.0 | 1 | 2 |
| SE150PFR-LR0 | Black | 1.50 | 38.1 | 1.00 to 2.25 | 25.4 to 57.2 | 500 | 152.4 | 1 | 4 |
| SE150PFR-LR8 | Gray | 1.50 | 38.1 | 1.00 to 2.25 | 25.4 to 57.2 | 50 | 5.2 | 1 | 4 |
| SE150PFR-TR0 | Black | 1.50 | 38.1 | 1.00 to 2.25 | 25.4 to 57.2 | 200 | 61.0 | 1 | 2 |
| SE150PFR-TR8 | Gray | 1.50 | 38.1 | 1.00 to 2.25 | 25.4 to 57.2 | 200 | 61.0 | 1 | 2 |
| SE150PFR-TR10 | White | 1.50 | 38.1 | 1.00 to 2.25 | 25.4 to 57.2 | 200 | 61.0 | 1 | 2 |
| SE175PFR-TR0 | Black | 1.75 | 44.5 | 1.25 to 2.75 | 31.8 to 69.8 | 200 | 61.0 | 1 | 2 |

Reel packaging may contain splices. Contact PANDUIT Customer Service for further information.

Tooling Head

- Sleeving cutter/end sealer blade – used with popular soldering guns to cut and seal sleeving



| Part Number | Description | Std. Pkg. Qty. |
|-------------|---|----------------|
| HKBS | For dual straight shank soldering guns with .500" spacing typical guns: WELLER Straight Shank Model 8200; WEN Model 199 or 100 (Replace tip holding screws with (2) screws included). | 1 |

Fray Resistant Braided Expandable Sleeving

- Fray-resistant design resists fraying when cut with scissors
- Provides continuous abrasion protection resistance for wires, cables, and tubing
- For indoor use only
- Material: Polyethylene Terephthalate



| Part Number | Color | Nominal I.D. | | Nominal Diameter Range | | Length per Reel‡ | | Std. Pkg. Qty. | Std. Ctn. Qty. |
|--------------|-------|--------------|------|------------------------|--------------|------------------|------|----------------|----------------|
| | | In. | mm | In. | mm | Ft. | m | | |
| SE12PSC-TR0 | Black | .13 | 3.1 | .13 to .25 | 3.2 to 6.4 | 200 | 61.0 | 1 | 4 |
| SE25PSC-TR0 | Black | .25 | 6.4 | .16 to .44 | 4.0 to 11.1 | 200 | 61.0 | 1 | 4 |
| SE38PSC-TR0 | Black | .38 | 9.5 | .19 to .63 | 4.8 to 15.9 | 200 | 61.0 | 1 | 4 |
| SE50PSC-CR0 | Black | .50 | 12.7 | .25 to .75 | 6.4 to 19.0 | 100 | 30.5 | 1 | 4 |
| SE75PSC-CR0 | Black | .75 | 19.1 | .63 to 1.0 | 15.9 to 25.4 | 100 | 30.5 | 1 | 4 |
| SE125PSC-LR0 | Black | 1.25 | 31.8 | 1.0 to 1.5 | 25.4 to 38.1 | 50 | 15.2 | 1 | 4 |
| SE150PSC-LR0 | Black | 1.50 | 38.1 | 1.3 to 2.0 | 31.8 to 50.8 | 50 | 15.2 | 1 | 4 |

‡Reel packaging may contain splices. Contact *PANDUIT* Customer Service for further information.

A.
System
Overview

B1.
Cable Ties

B2.
Cable
Accessories

B3.
Stainless
Steel Ties

C1.
Wiring
Duct

C2.
Surface
Raceway

C3.
Abrasion
Protection

C4.
Cable
Management

D1.
Terminals

D2.
Power
Connectors

D3.
Grounding
Connectors

E1.
Labeling
Systems

E2.
Labels

E3.
Pre-Printed
& Write-On
Markers

E4.
Permanent
Identification

E5.
Lockout/
Tagout/
& Safety
Solutions

F.
Index

A. System Overview

B1. Cable Ties

B2. Cable Accessories

B3. Stainless Steel Ties

C1. Wiring Duct

C2. Surface Raceway

C3. Abrasion Protection

C4. Cable Management

D1. Terminals

D2. Power Connectors

D3. Grounding Connectors

E1. Labeling Systems

E2. Labels

E3. Pre-Printed & Write-On Markers

E4. Permanent Identification

E5. Lockout/Tagout & Safety Solutions

F. Index

Part Number System for Non-Shrink PVC Tubing

| | | | |
|--------------------|---|---------------------|-------------------------|
| TV105 | — | 12 | M |
| Type | | Nominal Size | Package Quantity |
| TV105 = PVC Tubing | | 1 = 1 AWG | C = 100' (30.5m) |
| | | 12 = 12 AWG | TL = 250' (76.2m) |
| | | 6 = 6 AWG | D = 500' (152.4m) |
| | | .38 = 3/8" | M = 1000' (304.8m) |
| | | .50 = 1/2" | |
| | | .75 = 3/4" | |
| | | 1.0 = 1" | |

Non-Shrink PVC Tubing

- Provides insulation and protection for lead wires, wire harness assemblies, soldered joints, and components in electrical and electronic equipment
- All purpose flexible and non-shrinkable
- Resistant to heat and moisture
- UL Recognized, CSA Certified
- Flammability: Meets UL 224 VW-1
- Voltage rating: 300 V and 600 V
- ASTM D-922 Grade CFR
- MIL-I-631 Type F, Form U, Grade C- Class 1 Category 1
- Material: Polyvinyl chloride (PVC)



| Part Number | Color | Nominal Size | Length per Reel | | Max. Inside Diameter | | Wall Thickness | | Max. Voltage Rating | Std. Pkg. Qty. | Std. Ctn. Qty. |
|-----------------------|-------|--------------|-----------------|-------|----------------------|-------|----------------|-----|---------------------|----------------|----------------|
| | | | Ft. | m | In. | mm | In. | mm | | | |
| TV105-12MY | Clear | 12 AWG | 1000 | 304.8 | .089 | 2.26 | .016 | .41 | 300 V | 1 | 2 |
| TV105-12M20Y | Black | 12 AWG | 1000 | 304.8 | .089 | 2.26 | .016 | .41 | 300 V | 1 | 2 |
| TV105-6MY | Clear | 6 AWG | 1000 | 304.8 | .178 | 4.52 | .020 | .51 | 300 V | 1 | 2 |
| TV105-6M20Y | Black | 6 AWG | 1000 | 304.8 | .178 | 4.52 | .020 | .51 | 300 V | 1 | 2 |
| TV105-3MY | Clear | 3 AWG | 1000 | 304.8 | .249 | 6.32 | .020 | .51 | 300 V | 1 | 2 |
| TV105-3M20Y | Black | 3 AWG | 1000 | 4.8 | .249 | 6.32 | .020 | .51 | 300 V | 1 | 2 |
| TV105-1MY | Clear | 1 AWG | 1000 | 304.8 | .311 | 7.89 | .020 | .51 | 300 V | 1 | 0 |
| TV105-1M20Y | Black | 1 AWG | 1000 | 304.8 | .311 | 7.89 | .020 | .51 | 300 V | 1 | 0 |
| TV105-.38DY | Clear | 3/8 | 500 | 152.4 | .399 | 10.13 | .025 | .64 | 600 V | 1 | 0 |
| TV105-.38D20Y | Black | 3/8 | 500 | 152.4 | .399 | 10.13 | .025 | .64 | 600 V | 1 | 0 |
| TV105-.50DY | Clear | 1/2 | 500 | 152.4 | .524 | 13.30 | .025 | .64 | 600 V | 1 | 0 |
| TV105-.50D20Y | Black | 1/2 | 500 | 152.4 | .524 | 13.30 | .025 | .64 | 600 V | 1 | 0 |
| TV105-.75TLY | Clear | 3/4 | 250 | 76.2 | .786 | 19.96 | .035 | .89 | 600 V | 1 | 0 |
| TV105-.75TL20Y | Black | 3/4 | 250 | 76.2 | .786 | 19.96 | .035 | .89 | 600 V | 1 | 0 |
| TV105-1.0CY | Clear | 1 | 100 | 30.5 | 1.036 | 26.31 | .035 | .89 | 600 V | 1 | 2 |
| TV105-1.0C20Y | Black | 1 | 100 | 30.5 | 1.036 | 26.31 | .035 | .89 | 600 V | 1 | 2 |

Duct Seal – Sealing Compounds

- Seals irregular openings from air, dust, or water
- Non-hardening sealant that adheres to metal, masonry, wood or plastic
- Provides vibration dampening
- Meets the requirements of UL 514A (paragraph 29.5.1 to 29.5.3) – electrical outlet box cover water seal
- Safe and easy to use, non-corrosive, non-toxic, no asbestos, will not stain or harm hands, and no unpleasant odor.
- Dielectric strength: 200 V/Mil, Min .030 inches thick



| Part Number | Description | Std. Pkg. Qty. |
|-------------|--|----------------|
| DS1 | Duct seal (sealing compound) 1 lb. package | 1 |
| DS5 | Duct seal (sealing compound) 5 lb. package | 1 |

Flammability Tests and Classification

Abrasion Protection Products Flammability Tests and Classifications



- A number of test procedures have been developed which can be used for the evaluation and comparison of various materials to support combustion
- Review the following classifications to find which category is designed to suit your abrasion and protection applications

UL 94 Vertical Burning Test

Test samples of material, with dimension $125 \pm 5\text{mm}$ by $13.0 \pm 5\text{mm}$ and provided in the minimum and maximum thickness of the intended end use product, are tested in an unconditioned (as manufactured) state and in a conditioned state (7 days at 168F° , 75°C). The test requires the placement of a precisely controlled flame under a vertically supported specimen for a 10 second period. The flame is removed and the duration of flaming is recorded. If the flame extinguishes, the specimen is immediately subjected to a second 10 second ignition period. Duration of flaming is again recorded. A piece of 100% cotton is placed under the specimen. Also observed and documented is if the sample drips flaming particles that ignite the cotton indicator below.

Materials Classification

| Criteria Conditions | V-0 | V-1 | V-2 |
|--|-------------------|--------------------|--------------------|
| Afterflame time for each individual specimen t_1 or t_2 | $\leq 10\text{s}$ | $\leq 30\text{s}$ | $\leq 30\text{s}$ |
| Total afterflame time for any condition set (t_1 plus t_2 for the 5 specimens) | $\leq 50\text{s}$ | $\leq 250\text{s}$ | $\leq 250\text{s}$ |
| Afterflame plus afterglow time for each individual specimen after the second flame application ($t_2 + t_3$) | $\leq 30\text{s}$ | $\leq 60\text{s}$ | $\leq 60\text{s}$ |
| Afterflame or afterglow of any specimen up to the holding clamp | No | No | No |
| Cotton indicator ignited by flaming particles or drops | No | No | Yes |

| | |
|-------|--|
| t_1 | After flame time after first flame application |
| t_2 | After flame time after flame application |
| t_3 | After glow time after second flame application |

MATERIALS CLASSIFIED UL 94 HB

- Specimens shall have a maximum burn rate of <1.5 in./min over 3 inches of thickness of .120 inches to .5 inches
- Specimens shall have a maximum burn rate of <30 in./min over 3 inches for a thickness less than .120 inches

UL 224 VERTICAL WIRE FLAME TEST

Samples of fully recovered tubing are placed over a length of fine spring steel music wire. The test requires the precise placement of a controlled flame that contacts the heat shrink tubing. The flame is applied in five 15 second intervals with a time period between applications. If the flame extinguishes immediately after the first flame removal, subsequent flame applications are made to the tubing. Duration of specimen flaming is noted. A piece of surgical cotton is placed under the specimen. If a flaming or glowing piece of tubing drips and ignites the cotton, this is also noted.

MATERIALS CLASSIFIED AS VW-1 SHALL:

- Not flame or glow longer than 60 seconds following any of the five applications of the flame
- Not ignite or damage more than 25% of kraft paper flag that is placed around the top of the tubing
- Not have any specimens which drip flaming particles and ignite the surgical cotton located 9 1/2 inches below the test specimen

A.
System
Overview

B1.
Cable
Ties

B2.
Cable
Accessories

B3.
Stainless
Steel Ties

C1.
Wiring
Duct

C2.
Surface
Raceway

C3.
Abrasion
Protection

C4.
Cable
Management

D1.
Terminals

D2.
Power
Connectors

D3.
Grounding
Connectors

E1.
Labeling
Systems

E2.
Labels

E3.
Pre-Printed
& Write-On
Markers

E4.
Permanent
Identification

E5.
Lockout/
Tagout
& Safety
Solutions

F.
Index

| |
|--|
| A. System Overview |
| B1. Cable Ties |
| B2. Cable Accessories |
| B3. Stainless Steel Ties |
| C1. Wiring Duct |
| C2. Surface Raceway |
| C3. Abrasion Protection |
| C4. Cable Management |
| D1. Terminals |
| D2. Power Connectors |
| D3. Grounding Connectors |
| E1. Labeling Systems |
| E2. Labels |
| E3. Pre-Printed & Write-On Markers |
| E4. Permanent Identification |
| E5. Lockout/ Tagout & Safety Solutions |
| F. Index |

Abrasion Protection Materials Technical Data

| | Ratings and Approvals | Physical Properties | | | | | | Chemical Resistance | | | | |
|---|--|---|--------------------------------|---------------------|--|-------------------------|-----------------------------|---------------------------------|---|------------------------------|-------------------------------------|------------------------------|
| | | UL Temperature Index | Flammability (UL 94) | Melting Temperature | Abrasion Resistance (Lower number is better) | Specific Gravity (D792) | Minimum Tensile @23°C (psi) | Water Absorption (Max. 24 hrs.) | Organic Solvents | Alkalies | Acids | Petro-Chemicals |
| SPIRAL WRAP | Natural Polyethylene Lowest cost material for indoor use up to 122°C. Natural is available in all sizes. | -40°F (-40°C) to 122°F (50°C) | HB | 239°F (115°C) | 22 mg | .91 – .93 | 1400 (D368) | .01% | Resistant below 140°F (60°C) except to chlorinated solvents | Resistant | Resistant except to oxidizing acids | Some Discoloration |
| | Weather Resistant Polyethylene This material has the same properties as natural polyethylene, and also has additives which allow it to resist the effects of ultraviolet light and acid rain in an outdoor environment. This product is available only. | -40°F (-40°C) to 122°F (50°C) | HB | 239°F (115°C) | 20 mg | .93 – 1.09 | 2000 (D368) | .03% | Resistant below 140°F (60°C) except to chlorinated solvents | Resistant | Resistant except to oxidizing acids | No Discoloration |
| | Fire Resistant Polyethylene UL 94-V2 Rating This material is self-extinguishing and passes the UL 94 flame retardant test with V2 rating. | -40°F (-40°C) to 194°F (90°C) | V-2 | 239°F (115°C) | 27 mg | 1.00 – 1.30 | 1400 (D368) | .02% | Resistant below 140°F (60°C) except to chlorinated solvents | Resistant | Resistant except to oxidizing acids | Some Discoloration |
| | Flame Retardant Polyethylene UL 94-V0 Rating. This material is self extinguishing and passes the UL 94 flame retardant test with a V0 rating. | -4°F (-20°C) to 212°F (100°C) | V-0 | 270°F (132°C) | 22 mg | 1.23 – 1.37 | 1500 (D368) | .02% | Resistant except to halogenated hydrocarbons | Resistant | Resistant | Resistant Some Discoloration |
| | Nylon 6.6 Nylon is strong, durable, self-extinguishing material for indoor use up to 149°F. It offers a combination of lightweight, wide temperature range, and high abrasion resistance. This material is suitable for applications where heavy vibration or stress exists on the wiring or tubing. | -40°F (-40°C) to 149°F (65°C) | V-2 | 505°F (263°C) | 7 mg | 1.13 – 1.15 | 12,400 (D368) | 1.2% | Resistant except to halogenated hydrocarbons | Resistant | Not recommended | Resistant No Discoloration |
| | Weather Resistant Nylon This material has the same properties as natural Nylon and also has additives which allow it to resist the effects of ultraviolet light in an outdoor environment. This product is available in black only. | -40°F (-40°C) to 149°F (65°C) | V-2 | 505°F (263°C) | 7 mg | 1.13 – 1.15 | 12,400 (D368) | 1.2% | Resistant except to halogenated hydrocarbons | Resistant | Not recommended | Resistant No Discoloration |
| | TEFLON‡ This material is a non-flammable, fluorocarbon resin material. Suitable for use in any application (including nuclear containment). It is rated up to 356°F. Color: Opaque to Translucent | -40°F (-40°C) to 500°F (260°C) | V-0 | 648°F (342°C) | 7 mg | 2.13 – 2.22 | 3000 (D876) | .01% | Resistant | Resistant | Resistant | Resistant No Discoloration |
| | Natural Polyethylene Lowest cost material for indoor use up to 50°C. Natural is available in all sizes. | -40°C to 50°C | HB | 115°C | 22 mg | .91 – .93 | 1400 (D638) | .01% | Resistant below 60°C except to chlorinated solvents | Resistant | Resistant except to oxidizing acids | Some Discoloration |
| | Flame Retardant Polyethylene UL 94-V0 Rating. This material is self extinguishing and passes the UL 94 flame retardant test with a V0 rating. | -4°F (-20°C) to 212°F (100°C) | V-0 | 132°C | 22 mg | 1.15 | 1500 (D876) | .02% | Resistant except to halogenated hydrocarbons | Resistant | Resistant | Resistant Some Discoloration |
| | SLEEVING | Polyethylene Terephthalate (PET) This material is a thermoplastic polyester material designed for indoor applications. It is rated for use up to 257°F and will tolerate short-term exposure up to 446°F. Colors: Black, White and Gray | -94°F (-70°C) to 257°F (125°C) | HB | 500°F (260°C) | — | 1.39 | 100,000 (D876) | .08% | Resistant to some solvents | Resistant to most weak bases | Resistant |
| Flame Ret. Polyethylene Terephthalate (PET) This material is a self-extinguishing thermoplastic polyester that can be used indoors. It is also rated for use up to 257°F and will tolerate short term exposure up to 446°F. It is provided with tracers to identify the flame retardant material. | | -94°F (-70°C) to 257°F (125°C) | UL 1441 VW-1 | 469°F | — | 1.39 | 39,295 (D876) | .08% | Resistant to some solvents | Resistant to most weak bases | Resistant | Resistant Some Discoloration |

Note: Typical operating temperature ranges are extended based on end use application and specific environment tests.
‡TEFLON or equivalent fluorocarbon PTFE is used. TEFLON is a registered trademark of E.I. du Pont de Nemours and Company.

Abrasion Protection Materials Technical Data (continued)

| | | Ratings and Approvals | | | Physical Properties | | | | Chemical Resistance | | | |
|----------------|--|--------------------------------|----------------------|---------------------|--|-------------------------|-----------------------------|---------------------------------|---|-----------|-------------------------------------|------------------------------|
| | | UL Temperature Index | Flammability (UL 94) | Melting Temperature | Abrasion Resistance (Lower number is better) | Specific Gravity (D792) | Minimum Tensile @23°C (psi) | Water Absorption (Max. 24 hrs.) | Organic Solvents | Alkalies | Acids | Petro-Chemicals |
| CLT | Black Polyethylene Lowest cost material is for use up to 122°F. Other colors may be available. | -40°F (-40°C) to 122°F (50°C) | HB | — | — | .926 – .940 | 1500 (D638) | — | Resistant except to halogenated hydrocarbons | Resistant | Resistant | Resistant No Discoloration |
| | Nylon 6 Nylon is a strong, impact modified, heat stabilized, durable high abrasion resistant material. | -40°F (-40°C) to 230°F (110°C) | HB | 410°F (211°C) | — | 1.06 – 1.16 | 8000 (D638) | — | Resistant except to halogenated hydrocarbons | Resistant | Not recommended | Resistant No Discoloration |
| PVC | PVC Non-Shrink Tubing This material provides insulation and protection for continuous use at temperature -4°F (-20°C) to 221°F (105°C) | -4°F (-20°C) to 221°F (105°C) | UL 224 VW-1 | — | — | 1.35 | 2500 (D876) | — | Resistant except to aromatic hydrocarbons, ketones and esters | Resistant | Resistant | Resistant No Discoloration |
| CLT FITTINGS | Black Polyethylene Lowest cost material is for use up to 122°F. Other colors may be available. | — | UL 94 HB | — | — | 1.04 | 3,900 (D638) | .02-.03% | Resistant except to halogenated hydrocarbons | Resistant | Resistant except to oxidizing acids | Resistant Some Discoloration |
| GROMMET EDGING | Natural Polyethylene Lowest cost material for indoor use up to 122° F. Natural is available in all sizes. | -40°F (-40°C) to 122°F (50°C) | HB | 239°F (115°C) | 22 mg | .91 – 1.09 | 1400 (D638) | — | Resistant below 140°F (60°C) except to chlorinated solvents | Resistant | Resistant except to oxidizing acids | Some Discoloration |
| | Weather Resistant Polyethylene This material has the same properties as natural polyethylene, and also has additives which allow it to resist the effects of ultraviolet light and acid rain in an outdoor environment. This product is available only. | -40°F (-40°C) to 122°F (50°C) | HB | 239°F (115°C) | 20 mg | .93 – 1.09 | 2000 (D638) | .03% | Resistant below 140°F (60°C) except to chlorinated solvents | Resistant | Resistant except to oxidizing acids | No Discoloration |
| | Flame Retardant Polyethylene UL 94-V0 Rating This material is self-extinguishing and passes the UL 94 flame retardant test with a V0 rating. | -40°F (-40°C) to 194°F (90°C) | V-0 | 270°F (132°C) | 22 mg | 1.23 – 1.37 | 1200 | .02% | Resistant below 194°F (90°C) except to chlorinated solvents | Resistant | Resistant except to oxidizing acids | Some Discoloration |
| | Nylon Nylon is strong, durable, self-extinguishing material for indoor use up to 149°F. It offers a combination of lightweight, wide temperature range, and high abrasion resistance. This material is suitable for applications where heavy vibration or stress exists on the wiring or tubing. | -40°F (-40°C) to 149°F (65°C) | V-2 | 491°F (255°C) | 7 mg | 1.03 – 1.15 | 12,400 (D638) | 1.5% | Resistant except to phenols and formic acid | Resistant | Resistant to most weak acids | No Discoloration |

Note: Typical operating temperature ranges are extended based on end use application and specific environment tests.

A. System Overview

B1. Cable Ties

B2. Cable Accessories

B3. Stainless Steel Ties

C1. Wiring Duct

C2. Surface Raceway

C3. Abrasion Protection

C4. Cable Management

D1. Terminals

D2. Power Connectors

D3. Grounding Connectors

E1. Labeling Systems

E2. Labels

E3. Pre-Printed & Write-On Markers

E4. Permanent Identification

E5. Lockout/Tagout & Safety Solutions

F. Index

A. System Overview

PANDUIT Heat Shrink Tubing Heat Shrink Tubing Quick Selection Guide

B1. Cable Ties

Quick reference for PANDUIT Heat Shrink for specific location applications

B2. Cable Accessories



B3. Stainless Steel Ties

C1. Wiring Duct

C2. Surface Raceway

C3. Abrasion Protection

C4. Cable Management

CHARACTERISTICS

| | HSTT | HSTTV | HSTTN | HSTTK | HSTTT | HSTTP | HSTTPN | HSTTVA | HSTTRA | HSTTA | HST | HSEC | HSECFR |
|---------------------------------|---------------|---------------|-------|-------|-------|-------|--------|---------------|--------|-------|---------------|-------|--------|
| UL Listed | | | | | | | | | | | X | | |
| UL Recognized | X‡ | X | | X | | X | X | | | | | | |
| CSA Certified | X‡3 | X3 | | | | X3 | X | | | | X | | |
| VW-1-Rated | | X | | X | | X | X | | | | | | |
| Very Flexible | | X | X | | | | | | | | | | |
| Flexible | X | | | | | X | X | X | | X | | | |
| Semi-Rigid | | | | X | X | | X | | X | | X | | |
| Thin Wall | X | X | X | X | X | X | X | X | X | X | | | |
| Thick Wall | | | | | | | | | | | X | X | X |
| Cross-Linked Material | X | X | X | X | | X | | X | X | X | X | X | X |
| Colors Available | X | X | | | | | | | | | X* | | |
| Shrink Ratio | 2:1 | 2:1 | 2:1 | 2:1 | 2:1 | 2:1 | 2:1 | 2:1 | 5:1 | 3:1 | 3:1 | 3:1 | 3:1 |
| Flame Retardant | X‡ | X | X | X | X | X | X | X | X | X | X | | X |
| Adhesive Lined (Dual Wall) | | | | | | | | X | X | X | X | X | X |
| Meets Military Specifications | X | X | X | X | X | | X | X | X | X | X | | |
| Below Ground Application | | | | | | | | | | | X | | |
| High Temp Applications (>250°F) | | | | X | X | | | | | | | | |
| Highly Chemical Resistant | | | X | X | X | | | | | | | | |
| Low Coefficient of Friction | | | | | X | | | | | | | | |
| Custom Cut Lengths | X | X | X | X | X | X | | X | X | X | X | | |
| Standard 6" pieces | X | X | | | | | | X | | X | | | |
| Standard 4" lengths | X | X | | X | X | | | X | X | X | X | | |
| Small 25' Reels | X | X | X | | | X | | | | | | | |
| Large Reels | X | X | X | | | X | X | | | | | | |
| IP Rating | 62 | 62 | 62 | 62 | 62 | 62 | 62 | 66 | 66 | 66 | 68 | 68 | 68 |
| Found on Page... | C3.22 – C3.25 | C3.26 – C3.29 | C3.31 | C3.33 | C3.32 | C3.30 | C3.31 | C3.33 – C3.34 | C3.35 | C3.34 | C3.35 – C3.36 | C3.37 | C3.37 |

*Black/Red
‡Except Clear

E2. Labels

E3. Pre-Printed & Write-On Markers

E4. Permanent Identification

E5. Lockout/Tagout & Safety Solutions

F. Index

Part Number System for Thin Wall Heat Shrink

| HSTT | 12 | 48 | Q | 10 |
|--|-----------------------|--------------------|-------------------------------|-----------------------|
| Type | Expanded Diameter | Tube Length | Package Quantity | Color |
| HSTT = Thin Wall | 05 = 3/64" (1.2mm) | 3 = 3" (76.2mm) | (If Tube Length Specified) | NONE = Black |
| HSTTV = Thin Wall VW-1 | 06 = 1/16" (1.6mm) | 6 = 6" (152.4mm) | 1 = 1 pc. | C = Clear |
| HSTTN = Thin Wall Neoprene | 09 = 3/32" (2.4mm) | 9 = 9" (228.6mm) | 2 = 2 Pcs. | 2 = Red |
| HSTTK = Thin Wall PVDF KYNAR ▲ | 12 = 1/8" (3.2mm) | 12 = 12" (304.8mm) | 3 = 3 Pcs. | 4 = Yellow |
| HSTTT = Thin Wall TFE TEFLON ‡ | 19 = 3/16" (4.8mm) | 48" = (1.2m) | 5 = 5 Pcs. | 5 = Green |
| HSTTP = Thin Wall PVC | 25 = 1/4" (6.4mm) | NONE = REEL | X = 10 Pcs. | 6 = Blue |
| HSTTPN = Crystal Clear Thin Wall PVC | 38 = 3/8" (9.5mm) | | Q = 25 Pcs. | 10 = White |
| HSTTV A = Flexible Adhesive Lined | 50 = 1/2" (12.7mm) | | LQ = 75 Pcs. | 45 = Yellow/ Green |
| HSTTR A = Semi-Rigid Adhesive Lined | 75 = 3/4" (19.0mm) | | CQ = 125 Pcs. | |
| HSTTA = Thin Wall Adhesive Lined | 100 = 1" (25.4mm) | | T = 200 Pcs. | |
| HST = Thick Wall Adhesive Lined | 150 = 1 1/2" (38.1mm) | | TL = 250 Pcs. | |
| HSEC = Heat Shrink End Caps Adhesive Lined | 200 = 2" (50.5mm) | | Y = 6" Pcs. | |
| HSECFR = Heat Shrink End Caps Flame Retardant Adhesive Lined | 300 = 3" (76.2mm) | | | |
| | 400 = 4" (10.16mm) | | Reels | |
| | 0.4 = .40" (10.1mm) | | (If No Tube Length Specified) | |
| | 0.5 = .47" (11.9mm) | | Q = 25' (7.6m) | |
| | 0.8 = .80" (20.3mm) | | L = 50' (15.2m) | |
| | 1.0 = 1.0" (25.4mm) | | C = 100' (30.5m) | |
| | 1.1 = 1.1" (27.9mm) | | T = 200' (61.0m) | |
| | 1.5 = 1.5" (38.1mm) | | D = 500' (152.4m) | |
| | 2.0 = 2.0" (50.5mm) | | M = 1000' (304.8m) | |
| | 3.0 = 3.0" (76.2mm) | | | |
| | 4.0 = 4.0" (101.6mm) | | | |

For Standard Packages containing 6" (152.4mm) lengths, refer to individual pages for complete part number offering.

Note: The above information is to be used as a guide. For specific part number offerings review individual pages for verification.

▲KYNAR is a registered trademark of Atofina Chemicals, Inc.

‡TEFLON is a registered trademark of E.I. du Pont de Nemours and Company.

A.
System
Overview

B1.
Cable Ties

B2.
Cable
Accessories

B3.
Stainless
Steel Ties

C1.
Wiring
Duct

C2.
Surface
Raceway

C3.
Abrasion
Protection

C4.
Cable
Management

D1.
Terminals

D2.
Power
Connectors

D3.
Grounding
Connectors

E1.
Labeling
Systems

E2.
Labels

E3.
Pre-Printed
& Write-On
Markers

E4.
Permanent
Identification

E5.
Lockout/
Tagout
& Safety
Solutions

F.
Index

A. System Overview

HSTT Heat Shrink 4 Foot Pieces and Reels

B1. Cable Ties

- Applications include insulating, protecting, and color coding wires and cables
- Mil Spec: AMS-DTL-23053/5 Class 1 (Colors) Class 2 (Clear)

B2. Cable Accessories

- Voltage: 600 V
- Shrink ratio: 2:1
- Flammability: Flame retardant EXCEPT clear
- Material: Black cross-linked Polyolefin
- UL Recognized, CSA Certified

B3. Stainless Steel Ties



C1. Wiring Duct



C2. Surface Raceway

C3. Abrasion Protection

C4. Cable Management

D1. Terminals

D2. Power Connectors

D3. Grounding Connectors

E1. Labeling Systems

E2. Labels

E3. Pre-Printed & Write-On Markers

E4. Permanent Identification

E5. Lockout/Tagout & Safety Solutions

F. Index

| Part Number* | Nominal Diameter | | Min. Expanded I.D. | | Max. Recovered I.D. | | Nominal Recovered Wall Thickness | | Length | | Length per Reel | | Std. Pkg. Qty. | Std Ctn. Qty. |
|--------------------|------------------|-----|--------------------|-----|---------------------|-----|----------------------------------|----|--------|-----|-----------------|-------|----------------|---------------|
| | In. | mm | In. | mm | In. | mm | In. | mm | Ft. | m | Ft. | m | | |
| HSTT05-48-Q | .046 | 1.2 | .046 | 1.2 | .023 | .6 | .016 | .4 | 4 | 1.2 | — | — | 25 | — |
| HSTT05-48-TL | .046 | 1.2 | .046 | 1.2 | .023 | .6 | .016 | .4 | 4 | 1.2 | — | — | 250 | — |
| HSTT05-C‡ | .046 | 1.2 | .046 | 1.2 | .023 | .6 | .016 | .4 | — | — | 100 | 30.5 | 1 | 10 |
| HSTT05-M‡ | .046 | 1.2 | .046 | 1.2 | .023 | .6 | .016 | .4 | — | — | 1000 | 304.8 | 1 | 2 |
| HSTT06-48-Q | .063 | 1.6 | .063 | 1.6 | .031 | .8 | .017 | .4 | 4 | 1.2 | — | — | 25 | — |
| HSTT06-48-TL | .063 | 1.6 | .063 | 1.6 | .031 | .8 | .017 | .4 | 4 | 1.2 | — | — | 250 | — |
| HSTT06-C‡ | .063 | 1.6 | .063 | 1.6 | .031 | .8 | .017 | .4 | — | — | 100 | 30.5 | 1 | 10 |
| HSTT06-M‡ | .063 | 1.6 | .063 | 1.6 | .031 | .8 | .017 | .4 | — | — | 1000 | 304.8 | 1 | 2 |
| HSTT09-48-Q | .093 | 2.4 | .093 | 2.4 | .046 | 1.2 | .020 | .5 | 4 | 1.2 | — | — | 25 | — |
| HSTT09-48-TL | .093 | 2.4 | .093 | 2.4 | .046 | 1.2 | .020 | .5 | 4 | 1.2 | — | — | 250 | — |
| HSTT09-C‡ | .093 | 2.4 | .093 | 2.4 | .046 | 1.2 | .020 | .5 | — | — | 100 | 30.5 | 1 | 10 |
| HSTT09-M‡ | .093 | 2.4 | .093 | 2.4 | .046 | 1.2 | .020 | .5 | — | — | 1000 | 304.8 | 1 | 2 |
| HSTT12-48-Q | .125 | 3.2 | .125 | 3.2 | .062 | 1.6 | .020 | .5 | 4 | 1.2 | — | — | 25 | — |
| HSTT12-48-TL | .125 | 3.2 | .125 | 3.2 | .062 | 1.6 | .020 | .5 | 4 | 1.2 | — | — | 250 | — |
| HSTT12-C‡ | .125 | 3.2 | .125 | 3.2 | .062 | 1.6 | .020 | .5 | — | — | 100 | 30.5 | 1 | 10 |
| HSTT12-M‡ | .125 | 3.2 | .125 | 3.2 | .062 | 1.6 | .020 | .5 | — | — | 1000 | 304.8 | 1 | 2 |
| HSTT19-48-Q | .187 | 4.8 | .187 | 4.8 | .093 | 2.4 | .020 | .5 | 4 | 1.2 | — | — | 25 | — |
| HSTT19-48-TL | .187 | 4.8 | .187 | 4.8 | .093 | 2.4 | .020 | .5 | 4 | 1.2 | — | — | 250 | — |
| HSTT19-C‡ | .187 | 4.8 | .187 | 4.8 | .093 | 2.4 | .020 | .5 | — | — | 100 | 30.5 | 1 | 10 |
| HSTT19-M‡ | .187 | 4.8 | .187 | 4.8 | .093 | 2.4 | .020 | .5 | — | — | 1000 | 304.8 | 1 | 2 |
| HSTT25-48-Q | .250 | 6.4 | .250 | 6.4 | .125 | 3.2 | .025 | .6 | 4 | 1.2 | — | — | 25 | — |
| HSTT25-48-TL | .250 | 6.4 | .250 | 6.4 | .125 | 3.2 | .025 | .6 | 4 | 1.2 | — | — | 250 | — |
| HSTT25-C‡ | .250 | 6.4 | .250 | 6.4 | .125 | 3.2 | .025 | .6 | — | — | 100 | 30.5 | 1 | 10 |
| HSTT25-D‡ | .250 | 6.4 | .250 | 6.4 | .125 | 3.2 | .025 | .6 | — | — | 500 | 152.4 | 1 | 2 |
| HSTT38-48-Q | .375 | 9.5 | .375 | 9.5 | .187 | 4.8 | .025 | .6 | 4 | 1.2 | — | — | 25 | — |
| HSTT38-48-TL | .375 | 9.5 | .375 | 9.5 | .187 | 4.8 | .025 | .6 | 4 | 1.2 | — | — | 250 | — |
| HSTT38-C‡ | .375 | 9.5 | .375 | 9.5 | .187 | 4.8 | .025 | .6 | — | — | 100 | 30.5 | 1 | 10 |
| HSTT38-T‡ | .375 | 9.5 | .375 | 9.5 | .187 | 4.8 | .025 | .6 | — | — | 200 | 61.1 | 1 | 2 |

*For colors, add C (Clear), 2 (Red), 4 (Yellow), 45 (Yellow/Green), 5 (Green), 6 (Blue) and 10 (White) to end of part number.
 ‡Part sold per reel

HSTT Heat Shrink 4 Foot Pieces and Reels (continued)



| Part Number* | Nominal Diameter | | Min. Expanded I.D. | | Max. Recovered I.D. | | Nominal Recovered Wall Thickness | | Length | | Length per Reel | | Std. Pkg. Qty. | Std. Ctn. Qty. |
|----------------------|------------------|-------|--------------------|-------|---------------------|------|----------------------------------|-----|--------|-----|-----------------|------|----------------|----------------|
| | In. | mm | In. | mm | In. | mm | In. | mm | Ft. | m | Ft. | m | | |
| HSTT50-48-Q | .500 | 12.7 | .500 | 12.7 | .250 | 6.4 | .025 | .6 | 4 | 1.2 | — | — | 25 | — |
| HSTT50-48-T | .500 | 12.7 | .500 | 12.7 | .250 | 6.4 | .025 | .6 | 4 | 1.2 | — | — | 200 | — |
| HSTT50-C‡ | .500 | 12.7 | .500 | 12.7 | .250 | 6.4 | .025 | .6 | — | — | 100 | 30.5 | 1 | 10 |
| HSTT50-T‡ | .500 | 12.7 | .500 | 12.7 | .250 | 6.4 | .025 | .6 | — | — | 200 | 61.1 | 1 | 2 |
| HSTT75-48-5 | .750 | 19.0 | .750 | 19.0 | .375 | 9.5 | .030 | .8 | 4 | 1.2 | — | — | 5 | — |
| HSTT75-48-CQ | .750 | 19.0 | .750 | 19.0 | .375 | 9.5 | .030 | .8 | 4 | 1.2 | — | — | 125 | — |
| HSTT75-T‡ | .750 | 19.0 | .750 | 19.0 | .375 | 9.5 | .030 | .8 | — | — | 200 | 61.1 | 1 | 2 |
| HSTT100-48-5 | 1.00 | 25.4 | 1.00 | 25.4 | .500 | 12.7 | .035 | .9 | 4 | 1.2 | — | — | 5 | — |
| HSTT100-48-LQ | 1.00 | 25.4 | 1.00 | 25.4 | .500 | 12.7 | .035 | .9 | 4 | 1.2 | — | — | 75 | — |
| HSTT100-C‡ | 1.00 | 25.4 | 1.00 | 25.4 | .500 | 12.7 | .035 | .9 | — | — | 100 | 30.5 | 1 | 2 |
| HSTT150-48-5 | 1.50 | 38.1 | 1.50 | 38.1 | .750 | 19.0 | .040 | 1.0 | 4 | 1.2 | — | — | 5 | — |
| HSTT150-C‡ | 1.50 | 38.1 | 1.50 | 38.1 | .750 | 19.0 | .040 | 1.0 | — | — | 100 | 30.5 | 1 | 2 |
| HSTT200-48-5 | 2.00 | 50.8 | 2.00 | 50.8 | 1.00 | 25.4 | .045 | 1.1 | 4 | 1.2 | — | — | 5 | — |
| HSTT200-L‡ | 2.00 | 50.8 | 2.00 | 50.8 | 1.00 | 25.4 | .045 | 1.1 | — | — | 50 | 15.2 | 1 | 2 |
| HSTT300-48-2 | 3.00 | 76.2 | 3.00 | 76.2 | 1.50 | 38.1 | .050 | 1.3 | 4 | 1.2 | — | — | 2 | — |
| HSTT300-L‡ | 3.00 | 76.2 | 3.00 | 76.2 | 1.50 | 38.1 | .050 | 1.3 | — | — | 50 | 15.2 | 1 | 1 |
| HSTT400-48-2 | 4.00 | 101.6 | 4.00 | 101.6 | 2.00 | 50.8 | .055 | 1.4 | 4 | 1.2 | — | — | 2 | — |
| HSTT400-L‡ | 4.00 | 101.6 | 4.00 | 101.6 | 2.00 | 50.8 | .055 | 1.4 | — | — | 50 | 15.2 | 1 | 1 |

*For colors, add C (Clear), 2 (Red), 4 (Yellow), 45 (Yellow/Green), 5 (Green), 6 (Blue) and 10 (White) to end of part number.
 ‡Part sold per reel

HSTT Heat Shrink on 25 Foot Reels

- Applications include insulating, protecting, and color coding wires and cables
- Voltage: 600 V
- Shrink ratio: 2:1
- Flammability: Flame retardant EXCEPT clear
- UL Recognized, CSA Certified
- Mil Spec: AMS-DTL-23053/5 Class 1 (Colors) Class 2 (Clear)
- Temperature range: -67°F to 275°F (-55°C to 135°C)
- For dry locations
- Material: Cross-linked Polyolefin



| Part Number* | Nominal Diameter | | Min. Expanded I.D. | | Max. Recovered I.D. | | Nominal Recovered Wall Thickness | | Std. Pkg. Qty. | Std. Ctn. Qty. |
|-----------------|------------------|------|--------------------|------|---------------------|-----|----------------------------------|----|----------------|----------------|
| | In. | mm | In. | mm | In. | mm | In. | mm | | |
| HSTT05-Q | .046 | 1.2 | .046 | 1.2 | .023 | .6 | .016 | .4 | 1 | 10 |
| HSTT06-Q | .063 | 1.6 | .063 | 1.6 | .031 | .8 | .017 | .4 | 1 | 10 |
| HSTT09-Q | .093 | 2.4 | .093 | 2.4 | .046 | 1.2 | .020 | .5 | 1 | 10 |
| HSTT12-Q | .125 | 3.2 | .125 | 3.2 | .062 | 1.6 | .020 | .5 | 1 | 10 |
| HSTT19-Q | .187 | 4.8 | .187 | 4.8 | .093 | 2.4 | .020 | .5 | 1 | 10 |
| HSTT25-Q | .250 | 6.4 | .250 | 6.4 | .125 | 3.2 | .025 | .6 | 1 | 10 |
| HSTT38-Q | .375 | 9.5 | .375 | 9.5 | .187 | 4.8 | .025 | .6 | 1 | 10 |
| HSTT50-Q | .500 | 12.7 | .500 | 12.7 | .250 | 6.4 | .025 | .6 | 1 | 10 |
| HSTT75-Q | .750 | 19.0 | .750 | 19.0 | .375 | 9.5 | .030 | .8 | 1 | 10 |

*For colors, add C (Clear), 2 (Red), 4 (Yellow), 45 (Yellow/Green), 5 (Green), 6 (Blue), and 10 (White) to end of part number.

A. System Overview

B1. Cable Ties

B2. Cable Accessories

B3. Stainless Steel Ties

C1. Wiring Duct

C2. Surface Raceway

C3. Abrasion Protection

C4. Cable Management

D1. Terminals

D2. Power Connectors

D3. Grounding Connectors

E1. Labeling Systems

E2. Labels

E3. Pre-Printed & Write-On Markers

E4. Permanent Identification

E5. Lockout/Tagout & Safety Solutions

F. Index

A. System Overview

Heat Shrink in 6 Inch Pieces; Single Color, Single Diameter

B1. Cable Ties

- Applications include insulating, protecting, and color coding wires and cables
- Voltage: 600 V
- Shrink ratio: 2:1

- Mil Spec: AMS-DTL-23053/5 Class 1 (Colors) Class 2 (Clear)
- Temperature range: -67°F to 275°F (-55°C to 135°C)
- For dry locations
- Material: Cross-linked Polyolefin
- Colors include: Black and Clear

B2. Cable Accessories

- Flammability: Flame retardant EXCEPT clear
- UL Recognized, CSA Certified



B3. Stainless Steel Ties



C1. Wiring Duct

C2. Surface Raceway

C3. Abrasion Protection

C4. Cable Management

| Part Number | Nominal Diameter | | Min. Expanded I.D. | | Max. Recovered I.D. | | Nominal Recovered Wall Thickness | | Std. Pkg. Qty. | Std. Ctn. Qty. |
|------------------|------------------|------|--------------------|------|---------------------|------|----------------------------------|----|----------------|----------------|
| | In. | mm | In. | mm | In. | mm | In. | mm | | |
| HSTT06-Y | .063 | 1.6 | .063 | 1.6 | .031 | .8 | .017 | .4 | 1 | 10 |
| HSTT09-Y | .093 | 2.4 | .093 | 2.4 | .046 | 1.2 | .020 | .5 | 1 | 10 |
| HSTT12-Y | .125 | 3.2 | .125 | 3.2 | .062 | 1.6 | .020 | .5 | 1 | 10 |
| HSTT19-Y | .187 | 4.8 | .187 | 4.8 | .093 | 2.4 | .020 | .5 | 1 | 10 |
| HSTT25-Y | .250 | 6.4 | .250 | 6.4 | .125 | 3.2 | .025 | .6 | 1 | 10 |
| HSTT38-Y | .375 | 9.5 | .375 | 9.5 | .187 | 4.8 | .025 | .6 | 1 | 10 |
| HSTT50-Y | .500 | 12.7 | .500 | 12.7 | .250 | 6.4 | .025 | .6 | 1 | 10 |
| HSTT75-Y | .750 | 19.0 | .750 | 19.0 | .375 | 9.5 | .030 | .8 | 1 | 10 |
| HSTT100-Y | 1.00 | 25.4 | 1.00 | 25.4 | .500 | 12.7 | .035 | .9 | 1 | 10 |

**For colors add C (Clear), 2 (Red), 4 (Yellow), 5 (Green), 6 (Blue) and 10 (White) to suffix (Example: HSTT06-YC).

D1. Terminals

Heat Shrink in 6 Inch Pieces; Multi-Color, Single Diameter

D2. Power Connectors

- Applications include insulating, protecting, and color coding wires and cables
- Voltage: 600 V
- Shrink ratio: 2:1

- Mil Spec: AMS-DTL-23053/5 Class 1 (Colors) Class 2 (Clear)
- Temperature range: -67°F to 275°F (-55°C to 135°C)
- For dry locations
- Material: Cross-linked Polyolefin
- Colors include: clear, red, yellow, green, blue and white

D3. Grounding Connectors

- Flammability: Flame retardant EXCEPT clear
- UL Recognized, CSA Certified



E1. Labeling Systems



E2. Labels

E3. Pre-Printed & Write-On Markers

E4. Permanent Identification

E5. Lockout/Tagout & Safety Solutions

F. Index

| Part Number | Nominal Diameter | | Min. Expanded I.D. | | Max. Recovered I.D. | | Black No. of Pieces | Each Color No. of Pieces | Std. Pkg. Qty. | Std. Ctn. Qty. |
|--------------------|------------------|------|--------------------|------|---------------------|------|---------------------|--------------------------|----------------|----------------|
| | In. | mm | In. | mm | In. | mm | | | | |
| HSTT06-YK1 | .063 | 1.6 | .063 | 1.6 | .031 | 0.8 | 8 | 3 | 1 | 10 |
| HSTT09-YK1 | .093 | 2.4 | .093 | 2.4 | .046 | 1.2 | 6 | 3 | 1 | 10 |
| HSTT12-YK1 | .125 | 3.2 | .125 | 3.2 | .062 | 1.6 | 2 | 3 | 1 | 10 |
| HSTT19-YK1 | .187 | 4.8 | .187 | 4.8 | .093 | 2.4 | 6 | 2 | 1 | 10 |
| HSTT25-YK1 | .250 | 6.4 | .250 | 6.4 | .125 | 3.2 | 2 | 2 | 1 | 10 |
| HSTT38-YK1 | .375 | 9.5 | .375 | 9.5 | .187 | 4.8 | 6 | 1 | 1 | 10 |
| HSTT50-YK1 | .500 | 12.7 | .500 | 12.7 | .250 | 6.4 | 4 | 1 | 1 | 10 |
| HSTT75-YK1 | .750 | 19.0 | .750 | 19.0 | .375 | 9.5 | 2 | 1 | 1 | 10 |
| HSTT100-YK1 | 1.00 | 25.4 | 1.00 | 25.4 | .500 | 12.7 | 1 | 1 | 1 | 10 |

Heat Shrink in 6 Inch Pieces; Black, Multiple Diameters

- Applications include insulating, protecting, and color coding wires and cables
- Voltage: 600 V
- Shrink ratio: 2:1
- UL Recognized, CSA Certified
- Mil Spec: AMS-DTL-23053/5 Class 1 (Colors) Class 2 (Clear)
- Temperature range: -67°F to 275°F (-55°C to 135°C)
- For dry locations
- Material: Cross-linked Polyolefin



| Part Number | Nominal Diameter | No. of Pieces by Diameter | Std. Pkg. Qty. | Std. Ctn. Qty. |
|-----------------|-------------------------|---|----------------|----------------|
| HSTT-YK1 | Various – Smaller Range | Two pcs. each 1/8", 1/16", 3/32", 1/8", 3/16", 3/8", 1/2" | 1 | 10 |
| HSTT-YK2 | Various – Larger Range | Two pcs. each 3/8", 1/2", 3/4", 1" | 1 | 10 |

Heat Shrink in 6 Inch Pieces; Yellow/Green Stripe, Multiple Diameters

- Applications include insulating, protecting, and color coding wires and cables
- Voltage: 600 V
- Shrink ratio: 2:1
- Flammability: Flame retardant
- UL Recognized, CSA Certified
- Mil Spec: AMS-DTL-23053/5 Class 1
- Temperature range: -67°F to 275°F (-55°C to 135°C)
- For dry locations
- Material: Cross-linked Polyolefin



| Part Number | Nominal Diameter | No. of Pieces by Diameter | Std. Pkg. Qty. | Std. Ctn. Qty. |
|--------------------|-------------------------|---------------------------------------|----------------|----------------|
| HSTT-YK1-45 | Various – Smaller Range | Two pcs. each 1/8", 3/16", 1/4", 3/8" | 1 | 10 |
| HSTT-YK2-45 | Various – Larger Range | Two pcs. each 3/8", 1/2", 3/4" | 1 | 10 |

A.
System
Overview

B1.
Cable Ties

B2.
Cable
Accessories

B3.
Stainless
Steel Ties

C1.
Wiring
Duct

C2.
Surface
Raceway

C3.
Abrasion
Protection

C4.
Cable
Management

D1.
Terminals

D2.
Power
Connectors

D3.
Grounding
Connectors

E1.
Labeling
Systems

E2.
Labels

E3.
Pre-Printed
& Write-On
Markers

E4.
Permanent
Identification

E5.
Lockout/
Tagout
& Safety
Solutions

F.
Index

A.
System
Overview

HSTTV Heat Shrink 4 Foot Pieces

B1.
Cable Ties

- Applications include insulating, protecting, and color coding wires and cables
- Fast shrink time
- Voltage: 600 V
- Shrink ratio: 2:1
- Flammability: Meets UL 224 VW-1
- UL Recognized, CSA Certified
- Mil Spec: AMS-DTL-23053/5 Class 3
- Temperature range: -67°F to 275°F (-55°C to 135°C)
- For dry locations
- Material: Black cross-linked Polyolefin

B2.
Cable
Accessories

B3.
Stainless
Steel Ties



C1.
Wiring
Duct

C2.
Surface
Raceway

C3.
Abrasion
Protection

C4.
Cable
Management

D1.
Terminals

D2.
Power
Connectors

D3.
Grounding
Connectors

E1.
Labeling
Systems

E2.
Labels

E3.
Pre-Printed
& Write-On
Markers

E4.
Permanent
Identification

E5.
Lockout/
Tagout/
& Safety
Solutions

F.
Index



| Part Number | Nominal Diameter | | Min. Expanded I.D. | | Max. Recovered I.D. | | Nominal Recovered Wall Thickness | | Std. Pkg. Qty. | Std. Ctn. Qty. |
|---------------------|------------------|------|--------------------|------|---------------------|------|----------------------------------|-----|----------------|----------------|
| | In. | mm | In. | mm | In. | mm | In. | mm | | |
| HSTTV05-48-Q | .046 | 1.2 | .046 | 1.2 | .023 | 0.6 | .016 | 0.4 | 25 | — |
| HSTTV05-48-TL | .046 | 1.2 | .046 | 1.2 | .023 | 0.6 | .016 | 0.4 | 250 | — |
| HSTTV06-48-Q | .063 | 1.6 | .063 | 1.6 | .031 | 0.8 | .017 | 0.4 | 25 | — |
| HSTTV06-48-TL | .063 | 1.6 | .063 | 1.6 | .031 | 0.8 | .017 | 0.4 | 250 | — |
| HSTTV09-48-Q | .093 | 2.4 | .093 | 2.4 | .046 | 1.2 | .020 | 0.5 | 25 | — |
| HSTTV09-48-TL | .093 | 2.4 | .093 | 2.4 | .046 | 1.2 | .020 | 0.5 | 250 | — |
| HSTTV12-48-Q | .125 | 3.2 | .125 | 3.2 | .062 | 1.6 | .020 | 0.5 | 25 | — |
| HSTTV12-48-TL | .125 | 3.2 | .125 | 3.2 | .062 | 1.6 | .020 | 0.5 | 250 | — |
| HSTTV19-48-Q | .187 | 4.8 | .187 | 4.8 | .093 | 2.4 | .020 | 0.5 | 25 | — |
| HSTTV19-48-TL | .187 | 4.8 | .187 | 4.8 | .093 | 2.4 | .020 | 0.5 | 250 | — |
| HSTTV25-48-Q | 250 | 6.4 | .250 | 6.4 | .125 | 3.2 | .025 | 0.6 | 25 | — |
| HSTTV25-48-TL | .250 | 6.4 | .250 | 6.4 | .125 | 3.2 | .025 | 0.6 | 250 | — |
| HSTTV38-48-Q | .375 | 9.5 | .375 | 9.5 | .187 | 4.8 | .025 | 0.6 | 25 | — |
| HSTTV38-48-TL | .375 | 9.5 | .375 | 9.5 | .187 | 4.8 | .025 | 0.6 | 250 | — |
| HSTTV50-48-Q | 500 | 12.7 | .500 | 12.7 | .250 | 6.4 | .025 | 0.6 | 25 | — |
| HSTTV50-48-T | .500 | 12.7 | .500 | 12.7 | .250 | 6.4 | .025 | 0.6 | 200 | — |
| HSTTV75-48-5 | .750 | 19.0 | .75 | 19.0 | .375 | 9.5 | .030 | 0.8 | 5 | — |
| HSTTV75-48-CQ | 750 | 19.0 | .75 | 19.0 | .375 | 9.5 | .030 | 0.8 | 125 | — |
| HSTTV100-48-5 | 1.00 | 25.4 | 1.00 | 25.4 | .500 | 12.7 | .035 | 0.9 | 5 | — |
| HSTTV100-48-LQ | 1.00 | 25.4 | 1.00 | 25.4 | .500 | 12.7 | .035 | 0.9 | 75 | — |
| HSTTV150-48-5 | 1.50 | 38.1 | 1.50 | 38.1 | .750 | 19.0 | .040 | 1.0 | 5 | — |

HSTTV Heat Shrink on 100 Foot Reels

- Applications include insulating, protecting, and color coding wires and cables
- Fast shrink time
- Voltage: 600 V
- Shrink ratio: 2:1
- Flammability: Meets UL 224 VW-1
- UL Recognized, CSA Certified
- Mil Spec: AMS-DTL-23053/5 Class 3
- Temperature range: -67°F to 275°F (-55°C to 135°C)
- For dry locations
- Material: Cross-linked Polyolefin UV Resistant



| Part Number | Nominal Diameter | | Min. Expanded I.D. | | Max. Recovered I.D. | | Nominal Recovered Wall Thickness | | Std. Pkg. Qty. | Std. Ctn. Qty. |
|-------------|------------------|------|--------------------|------|---------------------|------|----------------------------------|-----|----------------|----------------|
| | In. | mm | In. | mm | In. | mm | In. | mm | | |
| HSTTV05-C | .046 | 1.2 | .046 | 1.2 | .023 | 0.6 | .016 | 0.4 | 1 | 10 |
| HSTTV06-C | .063 | 1.6 | .063 | 1.6 | .031 | 0.8 | .017 | 0.4 | 1 | 10 |
| HSTTV09-C | .093 | 2.4 | .093 | 2.4 | .046 | 1.2 | .020 | 0.5 | 1 | 10 |
| HSTTV12-C | .125 | 3.2 | .125 | 3.2 | .062 | 1.6 | .020 | 0.5 | 1 | 10 |
| HSTTV19-C | .187 | 4.8 | .187 | 4.8 | .093 | 2.4 | .020 | 0.5 | 1 | 10 |
| HSTTV25-C | .250 | 6.4 | .250 | 6.4 | .125 | 3.2 | .025 | 0.6 | 1 | 10 |
| HSTTV38-C | .375 | 9.5 | .375 | 9.5 | .187 | 4.8 | .025 | 0.6 | 1 | 10 |
| HSTTV50-C | .500 | 12.7 | .500 | 12.7 | .250 | 6.4 | .025 | 0.6 | 1 | 10 |
| HSTTV75-C | .750 | 19.0 | .750 | 19.0 | .375 | 9.5 | .030 | 0.8 | 1 | 10 |
| HSTTV100-C | 1.00 | 25.4 | 1.00 | 25.4 | .500 | 12.7 | .035 | 0.9 | 1 | 2 |
| HSTTV150-C | 1.50 | 38.1 | 1.50 | 38.1 | .750 | 19.0 | .040 | 1.0 | 1 | 2 |

A.
System
Overview

B1.
Cable Ties

B2.
Cable
Accessories

B3.
Stainless
Steel Ties

C1.
Wiring
Duct

C2.
Surface
Raceway

C3.
Abrasion
Protection

C4.
Cable
Management

D1.
Terminals

D2.
Power
Connectors

D3.
Grounding
Connectors

E1.
Labeling
Systems

E2.
Labels

E3.
Pre-Printed
& Write-On
Markers

E4.
Permanent
Identification

E5.
Lockout/
Tagout/
& Safety
Solutions

F.
Index

A.
System
Overview

HSTTV Heat Shrink on Bulk Reels

B1.
Cable Ties

- Applications include insulating, protecting, and color coding wires and cables
- Fast shrink time
- Voltage: 600 V
- Shrink ratio: 2:1
- Flammability: Meets UL 224 VW-1
- UL Recognized, CSA Certified
- Mil Spec: AMS-DTL-23053/5 Class 3
- Temperature range: -67°F to 275°F (-55°C to 135°C)
- For dry locations
- Material: Cross-linked Polyolefin

B2.
Cable
Accessories

B3.
Stainless
Steel Ties



C1.
Wiring
Duct



C2.
Surface
Raceway

C3.
Abrasion
Protection

C4.
Cable
Management

D1.
Terminals

D2.
Power
Connectors

D3.
Grounding
Connectors

E1.
Labeling
Systems

E2.
Labels

E3.
Pre-Printed
& Write-On
Markers

E4.
Permanent
Identification

E5.
Lockout/
Tagout
& Safety
Solutions

F.
Index

| Part Number | Nominal Diameter | | Min. Expanded I.D. | | Max. Recovered I.D. | | Nominal Recovered Wall Thickness | | Length per Reel | | Color | Std. Pkg. Qty. | Std. Ctn. Qty. |
|------------------|------------------|------|--------------------|------|---------------------|-----|----------------------------------|-----|-----------------|-------|--------|----------------|----------------|
| | In. | mm | In. | mm | In. | mm | In. | mm | Ft. | m | | | |
| HSTTV05-M | .046 | 1.2 | .046 | 1.2 | .023 | 0.6 | .016 | 0.4 | 1000 | 304.8 | Black | 1 | 2 |
| HSTTV05-M2 | .046 | 1.2 | .046 | 1.2 | .023 | 0.6 | .016 | 0.4 | 1000 | 304.8 | Red | 1 | 2 |
| HSTTV05-M4 | .046 | 1.2 | .046 | 1.2 | .023 | 0.6 | .016 | 0.4 | 1000 | 304.8 | Yellow | 1 | 2 |
| HSTTV05-M6 | .046 | 1.2 | .046 | 1.2 | .023 | 0.6 | .016 | 0.4 | 1000 | 304.8 | Blue | 1 | 2 |
| HSTTV06-M | .063 | 1.6 | .063 | 1.6 | .031 | 0.8 | .017 | 0.4 | 1000 | 304.8 | Black | 1 | 2 |
| HSTTV06-M2 | .063 | 1.6 | .063 | 1.6 | .031 | 0.8 | .017 | 0.4 | 1000 | 304.8 | Red | 1 | 2 |
| HSTTV06-M4 | .063 | 1.6 | .063 | 1.6 | .031 | 0.8 | .017 | 0.4 | 1000 | 304.8 | Yellow | 1 | 2 |
| HSTTV06-M6 | .063 | 1.6 | .063 | 1.6 | .031 | 0.8 | .017 | 0.4 | 1000 | 304.8 | Blue | 1 | 2 |
| HSTTV09-M | .093 | 2.4 | .093 | 2.4 | .046 | 1.2 | .02 | 0.5 | 1000 | 304.8 | Black | 1 | 2 |
| HSTTV09-M2 | .093 | 2.4 | .093 | 2.4 | .046 | 1.2 | .02 | 0.5 | 1000 | 304.8 | Red | 1 | 2 |
| HSTTV09-M4 | .093 | 2.4 | .093 | 2.4 | .046 | 1.2 | .02 | 0.5 | 1000 | 304.8 | Yellow | 1 | 2 |
| HSTTV09-M6 | .093 | 2.4 | .093 | 2.4 | .046 | 1.2 | .02 | 0.5 | 1000 | 304.8 | Blue | 1 | 2 |
| HSTTV12-M | .125 | 3.2 | .125 | 3.2 | .062 | 1.6 | .02 | 0.5 | 1000 | 304.8 | Black | 1 | 2 |
| HSTTV12-M2 | .125 | 3.2 | .125 | 3.2 | .062 | 1.6 | .02 | 0.5 | 1000 | 304.8 | Red | 1 | 2 |
| HSTTV12-M4 | .125 | 3.2 | .125 | 3.2 | .062 | 1.6 | .02 | 0.5 | 1000 | 304.8 | Yellow | 1 | 2 |
| HSTTV12-M6 | .125 | 3.2 | .125 | 3.2 | .062 | 1.6 | .02 | 0.5 | 1000 | 304.8 | Blue | 1 | 2 |
| HSTTV19-M | .187 | 4.8 | .187 | 4.8 | .093 | 2.4 | .02 | 0.5 | 1000 | 304.8 | Black | 1 | 2 |
| HSTTV19-M2 | .187 | 4.8 | .187 | 4.8 | .093 | 2.4 | .02 | 0.5 | 1000 | 304.8 | Red | 1 | 2 |
| HSTTV19-M4 | .187 | 4.8 | .187 | 4.8 | .093 | 2.4 | .02 | 0.5 | 1000 | 304.8 | Yellow | 1 | 2 |
| HSTTV19-M6 | .187 | 4.8 | .187 | 4.8 | .093 | 2.4 | .02 | 0.5 | 1000 | 304.8 | Blue | 1 | 2 |
| HSTTV25-D | .250 | 6.4 | .250 | 6.4 | .125 | 3.2 | .025 | 0.6 | 500 | 152.4 | Black | 1 | 2 |
| HSTTV25-D2 | .250 | 6.4 | .250 | 6.4 | .125 | 3.2 | .025 | 0.6 | 500 | 152.4 | Red | 1 | 2 |
| HSTTV25-D4 | .250 | 6.4 | .250 | 6.4 | .125 | 3.2 | .025 | 0.6 | 500 | 152.4 | Yellow | 1 | 2 |
| HSTTV25-D6 | .250 | 6.4 | .250 | 6.4 | .125 | 3.2 | .025 | 0.6 | 500 | 152.4 | Blue | 1 | 2 |
| HSTTV38-T | .375 | 9.5 | .375 | 9.5 | .187 | 4.8 | .025 | 0.6 | 200 | 61.1 | Black | 1 | 2 |
| HSTTV38-T2 | .375 | 9.5 | .375 | 9.5 | .187 | 4.8 | .025 | 0.6 | 200 | 61.1 | Red | 1 | 2 |
| HSTTV38-T4 | .375 | 9.5 | .375 | 9.5 | .187 | 4.8 | .025 | 0.6 | 200 | 61.1 | Yellow | 1 | 2 |
| HSTTV38-T6 | .375 | 9.5 | .375 | 9.5 | .187 | 4.8 | .025 | 0.6 | 200 | 61.1 | Blue | 1 | 2 |
| HSTTV50-T | .500 | 12.7 | .500 | 12.7 | .250 | 6.4 | .025 | 0.6 | 200 | 61.1 | Black | 1 | 2 |
| HSTTV50-T2 | .500 | 12.7 | .500 | 12.7 | .250 | 6.4 | .025 | 0.6 | 200 | 61.1 | Red | 1 | 2 |
| HSTTV50-T4 | .500 | 12.7 | .500 | 12.7 | .250 | 6.4 | .025 | 0.6 | 200 | 61.1 | Yellow | 1 | 2 |
| HSTTV50-T6 | .500 | 12.7 | .500 | 12.7 | .250 | 6.4 | .025 | 0.6 | 200 | 61.1 | Blue | 1 | 2 |
| HSTTV75-T | .750 | 19.0 | .750 | 19.0 | .375 | 9.5 | .03 | 0.8 | 200 | 61.1 | Black | 1 | 2 |
| HSTTV75-T2 | .750 | 19.0 | .750 | 19.0 | .375 | 9.5 | .03 | 0.8 | 200 | 61.1 | Red | 1 | 2 |
| HSTTV75-T4 | .750 | 19.0 | .750 | 19.0 | .375 | 9.5 | .03 | 0.8 | 200 | 61.1 | Yellow | 1 | 2 |
| HSTTV75-T6 | .750 | 19.0 | .750 | 19.0 | .375 | 9.5 | .03 | 0.8 | 200 | 61.1 | Blue | 1 | 2 |

UL **SP** HSTTV Heat Shrink on 25 Foot Reels

- Applications include insulating, protecting, and color coding wires and cables
- Fast shrink time
- Voltage: 600 V
- Shrink ratio: 2:1
- Flammability: Meets UL 224 VW-1
- UL Recognized, CSA Certified
- Mil Spec: AMS-DTL-23053/5 Class 3
- Temperature range: -67°F to 275°F (-55°C to 135°C)
- For dry locations
- Material: Black cross-linked Polyolefin



| Part Number | Nominal Diameter | | Min. Expanded I.D. | | Max. Recovered I.D. | | Nominal Recovered Wall Thickness | | Std. Pkg. Qty. | Std. Ctn. Qty. |
|------------------|------------------|------|--------------------|------|---------------------|------|----------------------------------|-----|----------------|----------------|
| | In. | mm | In. | mm | In. | mm | In. | mm | | |
| HSTTV05-Q | .046 | 1.2 | .046 | 1.2 | .023 | 0.6 | .016 | 0.4 | 1 | 10 |
| HSTTV06-Q | .063 | 1.6 | .063 | 1.6 | .031 | 0.8 | .017 | 0.4 | 1 | 10 |
| HSTTV09-Q | .093 | 2.4 | .093 | 2.4 | .046 | 1.2 | .020 | 0.5 | 1 | 10 |
| HSTTV12-Q | .125 | 3.2 | .125 | 3.2 | .062 | 1.6 | .020 | 0.5 | 1 | 10 |
| HSTTV19-Q | .187 | 4.8 | .187 | 4.8 | .093 | 2.4 | .020 | 0.5 | 1 | 10 |
| HSTTV25-Q | 250 | 6.4 | .250 | 6.4 | .125 | 3.2 | .025 | 0.6 | 1 | 10 |
| HSTTV38-Q | .375 | 9.5 | .375 | 9.5 | .187 | 4.8 | .025 | 0.6 | 1 | 10 |
| HSTTV50-Q | .500 | 12.7 | .500 | 12.7 | .250 | 6.4 | .025 | 0.6 | 1 | 10 |
| HSTTV75-Q | .750 | 19.0 | .750 | 19.0 | .375 | 9.5 | .030 | 0.8 | 1 | 10 |
| HSTTV100-Q | 1.00 | 25.4 | 1.00 | 25.4 | .500 | 12.7 | .035 | 0.9 | 1 | 2 |

UL **SP** HSTTV Heat Shrink 6 Inch Pieces

- Applications include insulating, protecting, and color coding wires and cables
- Fast shrink time
- Voltage: 600 V
- Shrink ratio: 2:1
- Flammability: Meets UL 224 VW-1
- UL Recognized, CSA Certified
- Mil Spec: AMS-DTL-23053/5 Class 3
- Temperature range: -67°F to 275°F (-55°C to 135°C)
- For dry locations
- Material: Black cross-linked Polyolefin



| Part Number | Nominal Diameter / Size | | Min. Expanded I.D. | | Max. Recovered I.D. | | Pieces per Package | Std. Pkg. Qty. | Std. Ctn. Qty. |
|-------------|-------------------------|------|--------------------|------|---------------------|------|--------------------|----------------|----------------|
| | In. | mm | In. | mm | In. | mm | | | |
| HSTTV05-Y | .046 | 1.2 | .046 | 1.2 | .023 | 0.6 | 26 | 1 | 10 |
| HSTTV06-Y | .063 | 1.6 | .063 | 1.6 | .031 | 0.8 | 26 | 1 | 10 |
| HSTTV09-Y | .093 | 2.4 | .093 | 2.4 | .046 | 1.2 | 24 | 1 | 10 |
| HSTTV12-Y | .125 | 3.2 | .125 | 3.2 | .062 | 1.6 | 20 | 1 | 10 |
| HSTTV19-Y | .187 | 4.8 | .187 | 4.8 | .093 | 2.4 | 18 | 1 | 10 |
| HSTTV25-Y | .250 | 6.4 | .250 | 6.4 | .125 | 3.2 | 14 | 1 | 10 |
| HSTTV38-Y | .375 | 9.5 | .375 | 9.5 | .187 | 4.8 | 12 | 1 | 10 |
| HSTTV50-Y | .500 | 12.7 | .500 | 12.7 | .250 | 6.4 | 10 | 1 | 10 |
| HSTTV75-Y | .750 | 19.0 | .750 | 19.0 | .375 | 9.5 | 8 | 1 | 10 |
| HSTTV100-Y | 1.00 | 25.4 | 1.00 | 25.4 | .500 | 12.7 | 6 | 1 | 10 |

A.
System
Overview

B1.
Cable Ties

B2.
Cable
Accessories

B3.
Stainless
Steel Ties

C1.
Wiring
Duct

C2.
Surface
Raceway

C3.
Abrasion
Protection

C4.
Cable
Management

D1.
Terminals

D2.
Power
Connectors

D3.
Grounding
Connectors

E1.
Labeling
Systems

E2.
Labels

E3.
Pre-Printed
& Write-On
Markers

E4.
Permanent
Identification

E5.
Lockout/
Tagout
& Safety
Solutions

F.
Index

A. System Overview

HSTTP PVC Heat Shrink

B1. Cable Ties

- Applications include insulating, protecting, and color coding wires and cables
- Good resistance to most fuels and oils
- Voltage: 600 V
- Shrink ratio: 2:1
- Flammability: Meets UL 224 VW-1
- UL Recognized, CSA Certified
- Temperature range: -4°F to 221°F (-20°C to 105°C)
- For dry locations
- Material: Black cross-linked Polyvinyl Chloride

B2. Cable Accessories

B3. Stainless Steel Ties



C1. Wiring Duct



C2. Surface Raceway

C3. Abrasion Protection

C4. Cable Management

D1. Terminals

D2. Power Connectors

D3. Grounding Connectors

E1. Labeling Systems

E2. Labels

E3. Pre-Printed & Write-On Markers

E4. Permanent Identification

E5. Lockout/Tagout & Safety Solutions

F. Index

| Part Number | Nominal Diameter | | Min. Expanded I.D. | | Max. Recovered I.D. | | Nominal Recovered Wall Thickness | | Length per reel | | Std. Pkg. Qty. | Std. Ctn. Qty. |
|--------------------|------------------|------|--------------------|------|---------------------|------|----------------------------------|-----|-----------------|-------|----------------|----------------|
| | In. | mm | In. | mm | In. | mm | In. | mm | Ft. | m | | |
| HSTTP05-QY | .046 | 1.2 | .046 | 1.2 | .023 | 0.6 | .020 | 0.5 | 25 | 7.5 | 1 | 10 |
| HSTTP05-CY | .046 | 1.2 | .046 | 1.2 | .023 | 0.6 | .020 | 0.5 | 100 | 30.5 | 1 | 2 |
| HSTTP05-MY | .046 | 1.2 | .046 | 1.2 | .023 | 0.6 | .020 | 0.5 | 1000 | 304.8 | 1 | 2 |
| HSTTP06-QY | .063 | 1.6 | .063 | 1.6 | .031 | 0.8 | .020 | 0.5 | 25 | 7.5 | 1 | 10 |
| HSTTP06-CY | .063 | 1.6 | .063 | 1.6 | .031 | 0.8 | .020 | 0.5 | 100 | 30.5 | 1 | 2 |
| HSTTP06-MY | .063 | 1.6 | .063 | 1.6 | .031 | 0.8 | .020 | 0.5 | 1000 | 304.8 | 1 | 2 |
| HSTTP09-QY | .093 | 2.4 | .093 | 2.4 | .046 | 1.2 | .025 | 0.6 | 25 | 7.5 | 1 | 10 |
| HSTTP09-CY | .093 | 2.4 | .093 | 2.4 | .046 | 1.2 | .025 | 0.6 | 100 | 30.5 | 1 | 2 |
| HSTTP09-MY | .093 | 2.4 | .093 | 3/32 | .046 | 1.2 | .025 | 0.6 | 1000 | 304.8 | 1 | 2 |
| HSTTP12-QY | .125 | 3.2 | .125 | 3.2 | .062 | 1.6 | .025 | 0.6 | 25 | 7.5 | 1 | 10 |
| HSTTP12-CY | .125 | 3.2 | .125 | 3.2 | .062 | 1.6 | .025 | 0.6 | 100 | 30.5 | 1 | 2 |
| HSTTP12-MY | .125 | 3.2 | .125 | 3.2 | .062 | 1.6 | .025 | 0.6 | 1000 | 304.8 | 1 | 2 |
| HSTTP19-QY | .187 | 4.8 | .187 | 4.8 | .093 | 2.4 | .025 | 0.6 | 25 | 7.5 | 1 | 10 |
| HSTTP19-CY | .187 | 4.8 | .187 | 4.8 | .093 | 2.4 | .025 | 0.6 | 100 | 30.5 | 1 | 2 |
| HSTTP19-MY | .187 | 4.8 | .187 | 4.8 | .093 | 2.4 | .025 | 0.6 | 1000 | 304.8 | 1 | 2 |
| HSTTP25-QY | .250 | 6.4 | .250 | 6.4 | .125 | 3.2 | .025 | 0.6 | 25 | 7.5 | 1 | 10 |
| HSTTP25-CY | .250 | 6.4 | .250 | 6.4 | .125 | 3.2 | .025 | 0.6 | 100 | 30.5 | 1 | 2 |
| HSTTP25-DY | .250 | 6.4 | .250 | 6.4 | .125 | 3.2 | .025 | 0.6 | 500 | 152.4 | 1 | 2 |
| HSTTP38-QY | .375 | 9.5 | .375 | 9.5 | .187 | 4.8 | .030 | 0.8 | 25 | 7.5 | 1 | 10 |
| HSTTP38-CY | .375 | 9.5 | .375 | 9.5 | .187 | 4.8 | .030 | 0.8 | 100 | 30.5 | 1 | 2 |
| HSTTP38-TY | .375 | 9.5 | .375 | 9.5 | .187 | 4.8 | .030 | 0.8 | 200 | 61.1 | 1 | 2 |
| HSTTP50-QY | .500 | 12.7 | .500 | 12.7 | .250 | 6.4 | .030 | 0.8 | 25 | 7.5 | 1 | 10 |
| HSTTP50-CY | .500 | 12.7 | .500 | 12.7 | .250 | 6.4 | .030 | 0.8 | 100 | 30.5 | 1 | 2 |
| HSTTP75-QY | .750 | 19.0 | .750 | 19.0 | .375 | 9.5 | .035 | 0.9 | 25 | 7.5 | 1 | 10 |
| HSTTP75-CY | .750 | 19.0 | .750 | 19.0 | .375 | 9.5 | .035 | 0.9 | 100 | 30.5 | 1 | 2 |
| HSTTP100-QY | 1.00 | 25.4 | 1.00 | 25.4 | .500 | 12.7 | .040 | 1.0 | 25 | 7.5 | 1 | 2 |
| HSTTP100-CY | 1.00 | 25.4 | 1.00 | 25.4 | .500 | 12.7 | .040 | 1.0 | 100 | 30.5 | 1 | 2 |
| HSTTP150-QY | 1.50 | 38.1 | 1.50 | 38.1 | .750 | 19.0 | .045 | 1.1 | 25 | 7.5 | 1 | 2 |
| HSTTP150-CY | 1.50 | 38.1 | 1.50 | 38.1 | .750 | 19.0 | .045 | 1.1 | 100 | 30.5 | 1 | 2 |
| HSTTP200-QY | 2.00 | 50.8 | 2.00 | 50.8 | 1.00 | 25.4 | .050 | 1.3 | 25 | 7.5 | 1 | 2 |

HSTTPN Crystal Clear PVC Heat Shrink



- Low shrink temperature (store below 90° F) to speed installation
- Crystal clear material ensures easy to read labels and splice inspections
- Mil Spec: AMS-DTL-23052/2 Class 2
- Highly flame retardant product manufactured from a material that is rated UL 224 VW-1
- Shrink ratio of 2:1 insulates a wide range of diameters and irregular shapes



| Part Number | Nominal Diameter | | Min. Expanded I.D. | | Max. Recovered I.D. | | Nominal Recovered Wall Thickness | | Length | | Length per Reel | | Std. Pkg. Qty. | Std. Ctn. Qty. |
|-----------------|------------------|------|--------------------|-------|---------------------|------|----------------------------------|-----|--------|-------|-----------------|------|----------------|----------------|
| | In. | mm | In. | mm | In. | mm | In. | mm | In. | mm | Ft. | m | | |
| HSTTPN50-438-L | .50 | 12.7 | .50 | 12.7 | .25 | 6.4 | .03 | 0.8 | 4.38 | 111.1 | — | — | 50 | 500 |
| HSTTPN50-713-Q | .50 | 12.7 | .50 | 12.7 | .25 | 6.4 | .30 | 0.8 | 7.13 | 181.0 | — | — | 25 | 250 |
| HSTTPN62-750-Q | .63 | 15.9 | .63 | 15.9 | .31 | 7.9 | .04 | 1.0 | 7.5 | 190.5 | — | — | 25 | 250 |
| HSTTPN75-775-Q | .75 | 19.1 | .75 | 19.1 | .38 | 9.5 | .04 | 1.0 | 7.8 | 197.0 | — | — | 25 | 250 |
| HSTTPN150-925-X | 1.5 | 38.1 | 1.5 | 38.1 | .75 | 19.1 | .05 | 1.3 | 9.3 | 235.0 | — | — | 10 | 100 |
| HSTTPN200-950-X | 2.0 | 50.8 | 2.0 | 50.8 | 1.0 | 25.4 | .05 | 1.3 | 10.0 | 241.3 | — | — | 10 | 100 |
| HSTTPN50-CC | .50 | 12.7 | .50 | 12.7 | .25 | 6.4 | .03 | 0.8 | — | — | 100 | 30.5 | 1 | 2 |
| HSTTPN62-CC | .63 | 15.9 | .63 | 15.9 | .31 | 7.9 | .04 | 1.0 | — | — | 100 | 30.5 | 1 | 2 |
| HSTTPN75-CC | .75 | 19.1 | .75 | 19.05 | .38 | 9.5 | .04 | 1.0 | — | — | 100 | 30.5 | 1 | 2 |
| HSTTPN100-CC | 1.0 | 25.4 | 1.0 | 25.4 | .50 | 12.7 | .04 | 1.0 | — | — | 100 | 30.5 | 1 | 2 |
| HSTTPN150-CC | 1.5 | 38.1 | 1.5 | 38.1 | .75 | 19.1 | .05 | 1.3 | — | — | 100 | 30.5 | 1 | 2 |
| HSTTPN100-775-Q | 1.0 | 25.4 | 1.0 | 25.4 | .50 | 12.7 | .04 | 1.0 | 7.8 | 197.0 | — | — | 25 | 250 |
| HSTTPN200-CC | 2.0 | 50.8 | 2.0 | 50.8 | 1.0 | 25.4 | .05 | 1.3 | — | — | 100 | 30.5 | 1 | 2 |

HSTTN Neoprene Heat Shrink

- Applications include insulating, protecting, and color coding wires and cables
- Excellent chemical resistance especially to fuels and oils
- Voltage: 600 V
- Shrink ratio: 2:1
- Mil Spec: AMS-DTL-23053/1 Class 2
- Temperature range: -94°F to 250°F (-70°C to 121°C)
- For dry locations
- Material: Black cross-linked Neoprene



| Part Number | Nominal Diameter | | Min. Expanded I.D. | | Max. Recovered I.D. | | Nominal Recovered Wall Thickness | | Length per Reel | | Std. Pkg. Qty. | Std. Ctn. Qty. |
|-------------|------------------|------|--------------------|------|---------------------|------|----------------------------------|-----|-----------------|------|----------------|----------------|
| | In. | mm | In. | mm | In. | mm | In. | mm | Ft. | m | | |
| HSTTN25-C | .250 | 6.4 | .250 | 6.4 | .143 | 3.6 | .035 | 0.9 | 100 | 30.5 | 1 | 2 |
| HSTTN38-C | .375 | 9.5 | .375 | 9.5 | .211 | 5.4 | .040 | 1.0 | 100 | 30.5 | 1 | 2 |
| HSTTN50-C | .500 | 12.7 | .500 | 12.7 | .286 | 7.3 | .048 | 1.2 | 100 | 30.5 | 1 | 2 |
| HSTTN63-C | .625 | 15.9 | .625 | 15.9 | .357 | 9.1 | .052 | 1.3 | 100 | 30.5 | 1 | 2 |
| HSTTN75-C | .750 | 19.0 | .750 | 19.0 | .428 | 10.9 | .057 | 1.5 | 100 | 30.5 | 1 | 2 |
| HSTTN88-C | .875 | 22.2 | .875 | 22.2 | .500 | 12.7 | .065 | 1.7 | 100 | 30.5 | 1 | 2 |
| HSTTN100-C | 1.00 | 25.4 | 1.00 | 25.4 | .570 | 14.5 | .070 | 1.8 | 100 | 30.5 | 1 | 2 |
| HSTTN125-C | 1.25 | 31.8 | 1.25 | 31.8 | .714 | 18.1 | .087 | 2.2 | 100 | 30.5 | 1 | 2 |
| HSTTN150-C | 1.50 | 38.1 | 1.50 | 38.1 | .875 | 21.8 | .095 | 2.4 | 100 | 30.5 | 1 | 2 |
| HSTTN200-Q | 2.00 | 50.8 | 2.00 | 50.8 | 1.14 | 29.0 | .110 | 2.8 | 25 | 7.5 | 1 | 2 |
| HSTTN300-Q | 3.00 | 76.2 | 3.00 | 76.2 | 1.71 | 43.4 | .125 | 3.8 | 25 | 7.5 | 1 | 2 |

A.
System
Overview

B1.
Cable Ties

B2.
Cable
Accessories

B3.
Stainless
Steel Ties

C1.
Wiring
Duct

C2.
Surface
Raceway

C3.
Abrasion
Protection

C4.
Cable
Management

D1.
Terminals

D2.
Power
Connectors

D3.
Grounding
Connectors

E1.
Labeling
Systems

E2.
Labels

E3.
Pre-Printed
& Write-On
Markers

E4.
Permanent
Identification

E5.
Lockout/
Tagout
& Safety
Solutions

F.
Index

A. System Overview

TEFLON[®] Heat Shrink

B1. Cable Ties

- Applications include insulating, protecting, and color coding wires and cables
- Voltage: 600 V
- Shrink ratio: 2:1
- Mil Spec: AMS-DTL-23053/12 Class 3
- Temperature range: -400°F to 500°F (-240°C to 260°C)
- Color: Opaque
- For dry locations
- Material: Polytetrafluoroethylene (PTFE)
- See page C3.39 for shrink instructions

B2. Cable Accessories

B3. Stainless Steel Ties



C1. Wiring Duct

C2. Surface Raceway

C3. Abrasion Protection

C4. Cable Management

| Part Number | Nominal Diameter | | Min. Expanded I.D. | | Max. Recovered I.D. | | Nominal Recovered Wall Thickness | | Length | | Std. Pkg. Qty. |
|---------------|------------------|------|--------------------|------|---------------------|------|----------------------------------|----|--------|-----|----------------|
| | In. | mm | In. | mm | In. | mm | In. | mm | Ft. | m | |
| HSTTT03-48-Q | 30 AWG | 0.9 | .034 | .9 | .015 | .4 | .009 | .2 | 4 | 1.2 | 25 |
| HSTTT04-48-Q | 28 AWG | 1.0 | .038 | 1.0 | .018 | .5 | .009 | .2 | 4 | 1.2 | 25 |
| HSTTT046-48-Q | 26 AWG | 1.2 | .046 | 1.2 | .022 | .5 | .010 | .3 | 4 | 1.2 | 25 |
| HSTTT05-48-Q | 24 AWG | 1.3 | .050 | 1.3 | .027 | .7 | .010 | .3 | 4 | 1.2 | 25 |
| HSTTT055-48-Q | 22 AWG | 1.4 | .055 | 1.4 | .032 | .8 | .012 | .3 | 4 | 1.2 | 25 |
| HSTTT06-48-Q | 20 AWG | 1.5 | .060 | 1.5 | .039 | 1.0 | .012 | .3 | 4 | 1.2 | 25 |
| HSTTT08-48-Q | 18 AWG | 1.9 | .076 | 1.9 | .049 | 1.2 | .012 | .3 | 4 | 1.2 | 25 |
| HSTTT09-48-Q | 16 AWG | 2.3 | .093 | 2.3 | .061 | 1.6 | .012 | .3 | 4 | 1.2 | 25 |
| HSTTT12-48-Q | 14 AWG | 3.0 | .120 | 3.0 | .072 | 1.8 | .012 | .3 | 4 | 1.2 | 25 |
| HSTTT15-48-Q | 12 AWG | 3.8 | .150 | 3.8 | .089 | 2.3 | .012 | .3 | 4 | 1.2 | 25 |
| HSTTT19-48-Q | 10 AWG | 4.9 | .191 | 4.9 | .112 | 2.8 | .012 | .3 | 4 | 1.2 | 25 |
| HSTTT24-48-Q | 8 AWG | 6.0 | .240 | 6.0 | .141 | 3.6 | .015 | .4 | 4 | 1.2 | 25 |
| HSTTT30-48-Q | 6 AWG | 7.7 | .302 | 7.7 | .178 | 4.5 | .015 | .4 | 4 | 1.2 | 25 |
| HSTTT37-48-Q | 4 AWG | 9.4 | .370 | 9.4 | .224 | 5.7 | .015 | .4 | 4 | 1.2 | 25 |
| HSTTT43-48-Q | 2 AWG | 10.9 | .430 | 10.9 | .278 | 7.0 | .015 | .4 | 4 | 1.2 | 25 |
| HSTTT47-48-Q | 0 AWG | 11.9 | .470 | 11.9 | .347 | 8.8 | .015 | .4 | 4 | 1.2 | 25 |
| HSTTT56-48-5 | 9/16 | 14.2 | .560 | 14.2 | .399 | 10.1 | .015 | .4 | 4 | 1.2 | 5 |
| HSTTT66-48-5 | 5/8 | 16.6 | .655 | 16.6 | .462 | 11.7 | .018 | .5 | 4 | 1.2 | 5 |
| HSTTT75-48-5 | 3/4 | 19.0 | .750 | 19.0 | .524 | 13.3 | .018 | .5 | 4 | 1.2 | 5 |
| HSTTT93-48-5 | 15/16 | 23.6 | .930 | 23.6 | .655 | 16.6 | .020 | .5 | 4 | 1.2 | 5 |
| HSTTT112-48-5 | 1 1/8 | 28.6 | 1.12 | 26.6 | .786 | 20.0 | .025 | .6 | 4 | 1.2 | 5 |
| HSTTT131-48-2 | 1 5/16 | 33.3 | 1.310 | 33.3 | .911 | 23.1 | .030 | .8 | 4 | 1.2 | 2 |
| HSTTT150-48-2 | 1 1/2 | 38.1 | 1.500 | 38.1 | 1.036 | 26.3 | .030 | .8 | 4 | 1.2 | 2 |

*TEFLON is a registered trademark of E.I. du Pont de Nemours and Company.

D1. Terminals

D2. Power Connectors

D3. Grounding Connectors

E1. Labeling Systems

E2. Labels

E3. Pre-Printed & Write-On Markers

E4. Permanent Identification

E5. Lockout/Tagout & Safety Solutions

F. Index

UL® **CS®** HSTTK Kynar* Heat Shrink 4 Foot Pieces

- Applications include insulating, protecting, and color coding wires and cables
- Excellent chemical and abrasion resistance
- Use in high temperature or solvent rich environment
- Voltage: 600 V
- Shrink ratio: 2:1
- Flammability: Meets UL 224 VW-1
- Mil Spec: AMS-DTL-23053/8
- Temperature range: -67°F to 347°F (-55°C to 175°C)
- For dry locations
- Material: Cross-linked Polyvinylidene Fluoride (PVDF)

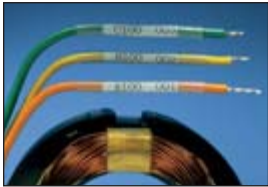

| Part Number | Nominal Diameter | | Min. Expanded I.D. | | Max. Recovered I.D. | | Nominal Recovered Wall Thickness | | Std. Pkg. Qty. |
|---------------|------------------|------|--------------------|------|---------------------|------|----------------------------------|-----|----------------|
| | In. | mm | In. | mm | In. | mm | In. | mm | |
| HSTTK05-48-Q | .046 | 1.2 | .046 | 1.2 | .023 | 0.6 | .010 | 0.3 | 25 |
| HSTTK06-48-Q | .063 | 1.6 | .063 | 1.6 | .031 | 0.8 | .010 | 0.3 | 25 |
| HSTTK09-48-Q | .093 | 2.4 | .093 | 2.4 | .046 | 1.2 | .010 | 0.3 | 25 |
| HSTTK12-48-Q | .125 | 3.2 | .125 | 3.2 | .062 | 1.6 | .010 | 0.3 | 25 |
| HSTTK19-48-Q | .187 | 4.8 | .187 | 4.8 | .093 | 2.4 | .010 | 0.3 | 25 |
| HSTTK25-48-Q | .250 | 6.4 | .250 | 6.4 | .125 | 3.2 | .010 | 0.3 | 25 |
| HSTTK38-48-Q | .375 | 9.5 | .375 | 9.5 | .187 | 4.8 | .012 | 0.3 | 25 |
| HSTTK50-48-5 | .500 | 12.7 | .500 | 12.7 | .250 | 6.4 | .012 | 0.3 | 5 |
| HSTTK75-48-5 | .750 | 19.0 | .750 | 19.0 | .375 | 9.5 | .017 | 0.4 | 5 |
| HSTTK100-48-5 | 1.00 | 25.4 | 1.00 | 25.4 | .500 | 12.7 | .019 | 0.5 | 5 |

*KYNAR is a registered trademark of Atofina Chemicals, Inc.

HSTTVA Heat Shrink 4 Foot and 6 Inch Pieces

- Applications include insulating, protecting, and color coding wires and cables
- Flexible tubing with an adhesive inner wall which seals and protects components from moisture and corrosion
- Voltage rating: 600 V
- Shrink ratio: 2:1
- Flammability: Highly flame retardant outer wall meets UL 224 VW-1
- Mil Spec: AMS-DTL-23053/4 Class 2
- Temperature range: -67°F to 230°F (-55°C to 110°C)
- For damp locations
- Material: Adhesive lined black cross-linked Polyolefin



| Part Number | Nominal Diameter | | Min. Expanded I.D. | | Max. Recovered I.D. | | Nominal Recovered Wall Thickness | | Std. Pkg. Qty. |
|------------------|------------------|------|--------------------|------|---------------------|------|----------------------------------|-----|----------------|
| | In. | mm | In. | mm | In. | mm | In. | mm | |
| 4' pieces | | | | | | | | | |
| HSTTVA12-48-Q | .125 | 3.2 | .125 | 3.2 | .062 | 1.6 | .020 | 0.5 | 25 |
| HSTTVA19-48-Q | .187 | 4.8 | .187 | 4.8 | .093 | 2.4 | .022 | 0.6 | 25 |
| HSTTVA25-48-Q | .250 | 6.4 | .250 | 6.4 | .125 | 3.2 | .030 | 0.8 | 25 |
| HSTTVA38-48-Q | .375 | 9.5 | .375 | 9.5 | .187 | 4.8 | .031 | 0.8 | 25 |
| HSTTVA50-48-5 | .500 | 12.7 | .500 | 12.7 | .250 | 6.4 | .032 | 0.8 | 5 |
| HSTTVA75-48-5 | .750 | 19.0 | .750 | 19.0 | .375 | 9.5 | .037 | 0.9 | 5 |
| HSTTVA100-48-5 | 1.00 | 25.4 | 1.00 | 25.4 | .500 | 12.7 | .046 | 1.2 | 5 |
| HSTTVA150-48-5 | 1.50 | 38.1 | 1.50 | 38.1 | .750 | 19.0 | .049 | 1.2 | 5 |

Table continues on page C3.34

A. System Overview

HSTTVA Heat Shrink 4 Foot and 6 Inch Pieces (continued)

B1. Cable Ties

B2. Cable Accessories

B3. Stainless Steel Ties

C1. Wiring Duct

C2. Surface Raceway

C3. Abrasion Protection

C4. Cable Management

D1. Terminals

D2. Power Connectors

D3. Grounding Connectors

E1. Labeling Systems

E2. Labels

E3. Pre-Printed & Write-On Markers

E4. Permanent Identification

E5. Lockout/Tagout & Safety Solutions

F. Index

| Part Number | Nominal Diameter | | Min. Expanded I.D. | | Max. Recovered I.D. | | Nominal Recovered Wall Thickness | | Std. Pkg. Qty. | |
|---|------------------|------|--------------------|------|---------------------|------|----------------------------------|-----|----------------|--|
| | In. | mm | In. | mm | In. | mm | In. | mm | | |
| Standard Packs of HSTTVA Heat Shrink – 6" (152.4mm) Pieces | | | | | | | | | | |
| HSTTVA12-Y | .125 | 3.2 | .125 | 3.2 | .062 | 1.6 | .020 | 0.5 | 1 | |
| HSTTVA19-Y | .187 | 4.8 | .187 | 4.8 | .093 | 2.4 | .022 | 0.6 | 1 | |
| HSTTVA25-Y | .250 | 6.4 | .250 | 6.4 | .125 | 3.2 | .030 | 0.8 | 1 | |
| HSTTVA38-Y | .375 | 9.5 | .375 | 9.5 | .187 | 4.8 | .031 | 0.8 | 1 | |
| HSTTVA50-Y | .500 | 12.7 | .500 | 12.7 | .250 | 6.4 | .032 | 0.8 | 1 | |
| HSTTVA75-Y | .750 | 19.0 | .750 | 19.0 | .375 | 9.5 | .037 | 0.9 | 1 | |
| HSTTVA100-Y | 1.00 | 25.4 | 1.00 | 25.4 | .500 | 12.7 | .046 | 1.2 | 1 | |

HSTTA Heat Shrink 4 Foot and 6 Inch Pieces

- Applications include insulating, protecting, and color coding wires and cables
- Flexible tubing with an adhesive inner wall which seals and protects components from moisture and corrosion
- Voltage rating: 600 V
- Shrink ratio: 3:1
- Flammability: Outer wall flame retardant
- Mil Spec: AMS-DTL-23053/4 Class 3
- Temperature range: -67°F to 230°F (-55°C to 110°C)
- For damp locations
- Material: Adhesive lined black cross-linked Polyolefin



| Part Number | Nominal Diameter | | Min. Expanded I.D. | | Max. Recovered I.D. | | Nominal Recovered Wall Thickness | | Std. Pkg. Qty. | Std. Ctn. Qty. |
|------------------|------------------|------|--------------------|------|---------------------|------|----------------------------------|-----|----------------|----------------|
| | In. | mm | In. | mm | In. | mm | In. | mm | | |
| 4' pieces | | | | | | | | | | |
| HSTTA19-48-Q | .187 | 4.8 | .187 | 4.8 | .062 | 1.6 | .040 | 1.0 | 25 | — |
| HSTTA25-48-Q | .250 | 6.4 | .250 | 6.4 | .080 | 2.0 | .040 | 1.0 | 25 | — |
| HSTTA25-48-TL | .250 | 6.4 | .250 | 6.4 | .080 | 2.0 | .040 | 1.0 | 250 | — |
| HSTTA38-48-Q | .375 | 9.5 | .375 | 9.5 | .120 | 3.0 | .055 | 1.4 | 25 | — |
| HSTTA38-48-TL | .375 | 9.5 | .375 | 9.5 | .120 | 3.0 | .055 | 1.4 | 250 | — |
| HSTTA50-48-5 | .500 | 12.7 | .500 | 12.7 | .160 | 4.1 | .070 | 1.8 | 5 | — |
| HSTTA50-48-T | .500 | 12.7 | .500 | 12.7 | .160 | 4.1 | .070 | 1.8 | 200 | — |
| HSTTA75-48-5 | .750 | 19.0 | .750 | 19.0 | .250 | 6.4 | .085 | 2.2 | 5 | — |
| HSTTA75-48-C | .750 | 19.0 | .750 | 19.0 | .250 | 6.4 | .085 | 2.2 | 100 | — |
| HSTTA100-48-5 | 1.00 | 25.4 | 1.00 | 25.4 | .320 | 8.1 | .100 | 2.5 | 5 | — |
| HSTTA100-48-L | 1.00 | 25.4 | 1.00 | 25.4 | .320 | 8.1 | .100 | 2.5 | 50 | — |
| HSTTA150-48-5 | 1.50 | 38.1 | 1.50 | 38.1 | .510 | 12.9 | .100 | 2.5 | 5 | — |
| HSTTA150-48-Q | 1.50 | 38.1 | 1.50 | 38.1 | .510 | 12.9 | .100 | 2.5 | 25 | — |

| Standard Packs of HSTTA Heat Shrink – 6" (152.44mm) Pieces | | | | | | | | | | |
|---|------|------|------|------|------|------|------|-----|---|----|
| HSTTA19-Y | .187 | 4.8 | .187 | 4.8 | .062 | 1.6 | .040 | 1.0 | 1 | 10 |
| HSTTA25-Y | .250 | 6.4 | .250 | 6.4 | .080 | 2.0 | .040 | 1.0 | 1 | 10 |
| HSTTA38-Y | .375 | 9.5 | .375 | 9.5 | .120 | 3.0 | .055 | 1.4 | 1 | 10 |
| HSTTA50-Y | .500 | 12.7 | .50 | 12.7 | .160 | 4.1 | .070 | 1.8 | 1 | 10 |
| HSTTA75-Y | .750 | 19.0 | .750 | 19.0 | .250 | 6.4 | .085 | 2.2 | 1 | 10 |
| HSTTA100-Y | 1.00 | 25.4 | 1.00 | 25.4 | .320 | 8.1 | .100 | 2.5 | 1 | 10 |
| HSTTA150-Y | 1.50 | 38.1 | 1.50 | 38.1 | .510 | 12.9 | .100 | 2.5 | 1 | 10 |

HSTTRA Heat Shrink 4 Foot Pieces

- Applications include insulating, protecting, and color coding wires and cables
- Semi-rigid tubing with an adhesive inner wall seals and protects components from moisture and corrosion
- Voltage rating: 600 V
- Shrink ratio: 2.5:1
- Mil Spec: AMS-DTL-23053/4 Class 1
- Temperature range: -67°F to 230°F (-55°C to 110°C)
- For damp locations
- Material: Adhesive lined black cross-linked Polyolefin



| Part Number | Nominal Diameter | | Min. Expanded I.D. | | Max. Recovered I.D. | | Nominal Recovered Wall Thickness | | Std. Pkg. Qty. |
|----------------------|------------------|------|--------------------|------|---------------------|------|----------------------------------|-----|----------------|
| | In. | mm | In. | mm | In. | mm | In. | mm | |
| HSTTRA12-48-Q | .125 | 3.2 | .125 | 3.2 | .023 | 0.6 | .038 | 1.0 | 25 |
| HSTTRA19-48-Q | .187 | 4.8 | .187 | 4.8 | .060 | 1.5 | .043 | 1.1 | 25 |
| HSTTRA25-48-Q | .250 | 6.4 | .250 | 6.4 | .080 | 2.0 | .047 | 1.2 | 25 |
| HSTTRA38-48-Q | .375 | 9.5 | .375 | 9.5 | .135 | 3.4 | .050 | 1.3 | 25 |
| HSTTRA50-48-5 | .500 | 12.7 | .500 | 12.7 | .195 | 5.0 | .059 | 1.5 | 5 |
| HSTTRA100-48-5 | 1.00 | 25.4 | 1.00 | 25.4 | .400 | 10.6 | .075 | 1.9 | 5 |

UL® Thick Wall Polyolefin Heat Shrink

- Applications include insulating, protecting, and color coding wires and cables
- Adhesive-lined inner wall seals and protects against moisture
- Thick wall suitable for direct burial according to UL 486D and provides excellent protection
- Voltage rating: UL 486D Listed for 600 V 1 kV 90°C continuous use
- Shrink ratio: 3:1
- Flammability: Flame retardant outer wall meets UL 224 VW-1
- UL Listed (Except HST3.0), CSA Certified
- Mil Spec: AMS-DTL-23053/15
- Temperature range: -85°F to 230°F (-65°C to 110°C)
- For wet locations
- Material: Adhesive lined black cross-linked Polyolefin



| Part Number | Min. Expanded I.D. | | Max. Recovered I.D. | | Nominal Recovered Wall Thickness | | Copper Conductor Size Range | | Min. Cable O.D. | | Max. Connector O.D. | | Length | | Std. Pkg. Qty. | Std. Ctn. Qty. |
|--------------------|--------------------|------|---------------------|-----|----------------------------------|-----|-----------------------------|--------|-----------------|-----|---------------------|-----|--------|--------|----------------|----------------|
| | In. | mm | In. | mm | In. | mm | AWG/MCM | mm² | In. | mm | In. | mm | In. | mm | | |
| HST0.4-3-Q | .40 | 10.1 | .15 | 3.8 | .090 | 2.3 | #12 – #6 AWG | 4 – 10 | .170 | 4.3 | .350 | 8.9 | 3.00 | 76.2 | 25 | 100 |
| HST0.4-6-3 | .40 | 10.1 | .15 | 3.8 | .090 | 2.3 | #12 – #6 AWG | 4 – 10 | .170 | 4.3 | .350 | 8.9 | 6.00 | 152.4 | 3 | 30 |
| HST0.4-6-X | .40 | 10.1 | .15 | 3.8 | .090 | 2.3 | #12 – #6 AWG | 4 – 10 | .170 | 4.3 | .350 | 8.9 | 6.00 | 152.4 | 10 | 100 |
| HST0.4-48-5 | .40 | 10.1 | .15 | 3.8 | .090 | 2.3 | #12 – #6 AWG | 4 – 10 | .170 | 4.3 | .350 | 8.9 | 48.00 | 1200.0 | 5 | 20 |

Table continues on page C3.36

A. System Overview

B1. Cable Ties

B2. Cable Accessories

B3. Stainless Steel Ties

C1. Wiring Duct

C2. Surface Raceway

C3. Abrasion Protection

C4. Cable Management

D1. Terminals

D2. Power Connectors

D3. Grounding Connectors

E1. Labeling Systems

E2. Labels

E3. Pre-Printed & Write-On Markers

E4. Permanent Identification

E5. Lockout/Tagout & Safety Solutions

F. Index

A.
System
Overview

Thick Wall Polyolefin Heat Shrink (continued)

B1.
Cable Ties

B2.
Cable
Accessories

B3.
Stainless
Steel Ties

C1.
Wiring
Duct

C2.
Surface
Raceway

C3.
Abrasion
Protection

C4.
Cable
Management

D1.
Terminals

D2.
Power
Connectors

D3.
Grounding
Connectors

E1.
Labeling
Systems

E2.
Labels

E3.
Pre-Printed
& Write-On
Markers

E4.
Permanent
Identification

E5.
Lockout/
Tagout/
& Safety
Solutions

F.
Index

| Part Number | Min. Expanded I.D. | | Max. Recovered I.D. | | Nominal Recovered Wall Thickness | | Copper Conductor Size Range | | Min. Cable O.D. | | Max. Connector O.D. | | Length | | Std. Pkg. Qty. | Std. Ctn. Qty. |
|--------------------|--------------------|------|---------------------|------|----------------------------------|-----|-----------------------------|-----------------|-----------------|------|---------------------|------|--------|--------|----------------|----------------|
| | In. | mm | In. | mm | In. | mm | AWG/MCM | mm ² | In. | mm | In. | mm | In. | mm | | |
| HST0.8-6-3 | .80 | 20.3 | .26 | 6.4 | .110 | 2.8 | #8 – #1/0 AWG | 10 – 50 | .240 | 6.1 | .650 | 16.5 | 6.00 | 152.4 | 3 | 30 |
| HST0.8-6-X | .80 | 20.3 | .26 | 6.4 | .110 | 2.8 | #8 – #1/0 AWG | 10 – 50 | .240 | 6.1 | .650 | 16.5 | 6.00 | 152.4 | 10 | 100 |
| HST0.8-9-X | .80 | 20.3 | .26 | 6.4 | .110 | 2.8 | #8 – #1/0 AWG | 10 – 50 | .240 | 6.1 | .650 | 16.5 | 9.00 | 228.6 | 10 | 100 |
| HST0.8-12-5 | .80 | 20.3 | .26 | 6.4 | .110 | 2.8 | #8 – #1/0 AWG | 10 – 50 | .240 | 6.1 | .650 | 16.5 | 12.00 | 304.8 | 5 | 50 |
| HST0.8-48-5 | .80 | 20.3 | .26 | 6.4 | .110 | 2.8 | #8 – #1/0 AWG | 10 – 50 | .240 | 6.1 | .650 | 16.5 | 48.00 | 1200.0 | 5 | 20 |
| HST1.1-6-3 | 1.10 | 27.9 | .37 | 9.4 | .120 | 3.0 | #2 – #4/0 AWG | 35 – 95 | .400 | 10.1 | .875 | 22.2 | 6.00 | 152.4 | 3 | 30 |
| HST1.1-6-X | 1.10 | 27.9 | .37 | 9.4 | .120 | 3.0 | #2 – #4/0 AWG | 35 – 95 | .400 | 10.1 | .875 | 22.2 | 6.00 | 152.4 | 10 | 100 |
| HST1.1-9-2 | 1.10 | 27.9 | .37 | 9.4 | .120 | 3.0 | #2 – #4/0 AWG | 35 – 95 | .400 | 10.1 | .875 | 22.2 | 9.00 | 228.6 | 2 | 20 |
| HST1.1-9-X | 1.10 | 27.9 | .37 | 9.4 | .120 | 3.0 | #2 – #4/0 AWG | 35 – 95 | .400 | 10.1 | .875 | 22.2 | 9.00 | 228.6 | 10 | 100 |
| HST1.1-12-5 | 1.10 | 27.9 | .37 | 9.4 | .120 | 3.0 | #2 – #4/0 AWG | 35 – 95 | .400 | 10.1 | .875 | 22.2 | 12.00 | 304.8 | 5 | 50 |
| HST1.1-48-5 | 1.10 | 27.9 | .37 | 9.4 | .120 | 3.0 | #2 – #4/0 AWG | 35 – 95 | .400 | 10.1 | .875 | 22.2 | 48.00 | 1200.0 | 5 | 20 |
| HST1.5-9-X | 1.50 | 38.1 | .50 | 12.7 | .170 | 4.3 | #3/0 – #400 MCM | 95 – 185 | .600 | 15.2 | 1.190 | 30.2 | 9.00 | 228.6 | 10 | 100 |
| HST1.5-12-1 | 1.50 | 38.1 | .50 | 12.7 | .170 | 4.3 | #3/0 – #400 MCM | 95 – 185 | .600 | 15.2 | 1.190 | 30.2 | 12.00 | 304.8 | 1 | 10 |
| HST1.5-12-5 | 1.50 | 38.1 | .50 | 12.7 | .170 | 4.3 | #3/0 – #400 MCM | 95 – 185 | .600 | 15.2 | 1.190 | 30.2 | 12.00 | 304.8 | 5 | 50 |
| HST1.5-48-5 | 1.50 | 38.1 | .50 | 12.7 | .170 | 4.3 | #250 – #750 MCM | 240 – 500 | .600 | 15.2 | 1.190 | 30.2 | 48.00 | 1200.0 | 5 | 15 |
| HST2.0-9-5 | 2.00 | 50.8 | .67 | 16.9 | .170 | 4.3 | #250 – #750 MCM | 240 – 500 | .750 | 19.1 | 1.600 | 40.6 | 9.00 | 228.6 | 5 | 50 |
| HST2.0-12-2 | 2.00 | 50.8 | .67 | 16.9 | .170 | 4.3 | #250 – #750 MCM | 240 – 500 | .750 | 19.1 | 1.600 | 40.6 | 12.00 | 304.8 | 2 | 20 |
| HST2.0-48-2 | 2.00 | 50.8 | .67 | 16.9 | .170 | 4.3 | #600 – #1250 MCM | 300 – 625 | .75 | 19.1 | 1.600 | 40.6 | 48.00 | 1200.0 | 2 | 8 |
| HST3.0-12-2 | 3.00 | 76.2 | 1.00 | 25.4 | .170 | 4.3 | #600 – #1250 MCM | 300 – 625 | 1.200 | 30.5 | 2.250 | 57.2 | 12.00 | 304.8 | 2 | 20 |
| HST3.0-48-2 | 3.00 | 76.2 | 1.00 | 25.4 | .170 | 4.3 | #600 – #1250 MCM | 300 – 625 | 1.20 | 30.5 | 2.250 | 57.2 | 48.00 | 1200.0 | 2 | 8 |

Heat Shrink End Caps

- Applications include insulating, protecting, and color coding wires and cables
- Adhesive lined inner wall seals and provides excellent protection against moisture
- Voltage rating of 600 V
- Shrink ratio: 3:1
- Temperature range: -67°F to 230°F (-55°C to 110°C)
- For wet locations
- Material: Adhesive lined black cross-linked Polyolefin



| Part Number | Min. Expanded I.D. | | Max. Recovered I.D. | | Nominal Recovered Wall Thickness | | Copper Conductor Size Range | Cap Length | | Std. Pkg. Qty. | Std. Ctn. Qty. |
|--------------------|--------------------|-------|---------------------|------|----------------------------------|-----|-----------------------------|------------|-------|----------------|----------------|
| | In. | mm | In. | mm. | In. | mm | | In. | mm | | |
| HSEC0.5-X | .47 | 11.9 | .18 | 4.6 | .100 | 2.5 | #8 – #4 AWG | 1.4 | 35.1 | 10 | 100 |
| HSEC0.8-X | .79 | 20.1 | .30 | 7.6 | .100 | 2.5 | #4 – #3/0 AWG | 2.1 | 54.1 | 10 | 100 |
| HSEC1.0-X | 1.02 | 25.9 | .45 | 11.4 | .100 | 2.5 | #2 – #4/0 AWG | 3.2 | 82.0 | 10 | 100 |
| HSEC1.5-5 | 1.58 | 40.1 | .68 | 17.3 | .110 | 2.8 | #250 – #500 MCM | 3.8 | 98.0 | 5 | 50 |
| HSEC2.0-5 | 2.25 | 57.2 | .87 | 22.1 | .150 | 3.8 | #600 – #1000 MCM | 5.5 | 140.2 | 5 | 50 |
| HSEC4.0-2 | 4.14 | 105.2 | 1.78 | 45.2 | .150 | 3.8 | #1500 – #2000 MCM | 6.9 | 175.3 | 2 | 10 |
| HSECFR0.5-X | .51 | 13.0 | .16 | 4.1 | .090 | 2.4 | #8 – #6 AWG | 3.00 | 76.2 | 10 | 100 |
| HSECFR0.8-X | .75 | 19.0 | .24 | 6.1 | .090 | 2.4 | #6 – #2 AWG | 3.50 | 88.9 | 10 | 100 |
| HSECFR1.0-X | 1.10 | 27.9 | .35 | 8.9 | .120 | 3.0 | #1 – #3/0 MCM | 4.00 | 101.6 | 10 | 100 |
| HSECFR1.5-5 | 1.50 | 38.1 | .47 | 11.9 | .160 | 4.1 | #2/0 – #350 MCM | 4.50 | 114.3 | 5 | 50 |
| HSECFR2.0-5 | 2.00 | 50.8 | .63 | 16.0 | .160 | 4.1 | #250 – #500 MCM | 4.50 | 114.3 | 5 | 50 |

A. System Overview

B1. Cable Ties

B2. Cable Accessories

B3. Stainless Steel Ties

C1. Wiring Duct

C2. Surface Raceway

C3. Abrasion Protection

C4. Cable Management

D1. Terminals

D2. Power Connectors

D3. Grounding Connectors

E1. Labeling Systems

E2. Labels

E3. Pre-Printed & Write-On Markers

E4. Permanent Identification

E5. Lockout/Tagout & Safety Solutions

F. Index

A.
System
Overview

Plastic Heat Shrink Tubing Kit Boxes – For Dry Locations

B1.
Cable Ties



B2.
Cable
Accessories

B3.
Stainless
Steel Ties

| Part Number | Part Description | Contents | Std. Pkg. Qty. |
|-----------------|--|--|----------------|
| KP-HSTT1 | Heat shrink kit box – plastic case, various sizes. black only. | 35 ea. of 3/32", 1/8" 21 ea. of 3/16", 1/4" 7 ea. of 3/8", 1/2" | 1 |
| KP-HSTT2 | Heat shrink kit box – plastic case, various sizes, various colors. | 35 ea. (5 ea. color) 3/32", 1/8" 21 ea. (3 ea. color) 3/16", 1/4" 7 ea. (1 ea. color) 3/8", 1/2" | 1 |
| KP-HSTTA | Dual Wall Adhesive Lined Thin Wall Heat Shrink: Plastic Kit Box – Black only | 14 ea. 3/16" 12 ea. 1/4" 10 ea. 3/8" 6 ea. 1/2" 3 ea. 3/4" 2 ea. 1" | 1 |

C1.
Wiring
Duct

C2.
Surface
Raceway

C3.
Abrasion
Protection



Heat Shrink Tools and Accessories

C4.
Cable
Management



D1.
Terminals

D2.
Power
Connectors

D3.
Grounding
Connectors

E1.
Labeling
Systems

E2.
Labels

E3.
Pre-Printed
& Write-On
Markers

E4.
Permanent
Identification

E5.
Lockout/
Tagout/
& Safety
Solutions

F.
Index

| Part Number | Part Description | Std. Pkg. Qty. | Std. Ctn. Qty. |
|---------------------|--|----------------|----------------|
| HSG-115V-650 | Heat gun with temperature range of 650°F (344°C) to 900°F (482°C). | 1 | — |
| HSG-A1 | Shrink tube reflector for tubing up to 3/4" inside diameter. Directs heat around tubing to reduce shrink time. | 1 | 10 |
| HSG-A2 | Shrink tube reflector for tubing up to 1 1/2" inside diameter. Directs heat around tubing to reduce shrink time. | 1 | 10 |
| HSG-A3 | Shrink tube concentrator. Directs heat toward tubing and away from heat sensitive items. | 1 | 10 |
| HSG-A4 | Black polyethylene case stores heat gun, stand, and all three accessories. | 1 | — |
| HSG-P1 | Replacement brush/spring kit. | 1 | 5 |
| HSG-P2 | Replacement switch 20 A. | 1 | 5 |
| HSG-P3 | Replacement bearing kit. | 1 | 5 |
| HSG-P7 | Replacement heat element 650°F. | 1 | — |

Heat Shrink Installation Instructions

General Instructions

Position heat shrink over the object to be covered. Using a heat gun, soft yellow flame torch, infrared heat source or oven, evenly heat the tubing until it has fully recovered and conforms to the object. Use caution not to char or burn the tubing.

Special Instructions for HSTTT

TFE Heat Shrink is the most difficult to recover due to its high shrink temperature. TFE shrink tubing must be heated to the gel state 621°F (327°C) to completely recover. This can be recognized when the tubing changes from milky white to clear. Because of the unique characteristics of this material, a controlled temperature oven will achieve the most reliable results – it is difficult to consistently recover this product using a high-temp heat gun or similar heat source. These methods have a tendency to overheat the tube in one area while other areas remain cool.

When recovering onto objects, use a temperature controlled oven set at 660°F – 680°F (349°C – 360°C) for approximately 10 minutes is recommended. It is best to place the product on a fiberglass mat or suspend as opposed to contacting the oven rack. Do NOT heat the product above 700°F (371°C), or degradation damage to the TFE polymer will occur.

Size Selection for Heat Shrink Tubing

Generally, the largest tube that shrinks down tightly onto an object should be chosen. This allows the heat shrink tubing maximum stress relief and this will yield the longest service life.

Example:

A multi-conductor cable needs to be covered with HSTT Type *DRY-SHRINK™* Heat Shrink. The area to be covered has a measured outside diameter of .700" (17.8mm). The two possibilities are HSTT75-48-5 and HSTT100-48-5.

| Part Number | Expanded I.D. In. (mm) | Recovered I.D. In. (mm) |
|--------------|---------------------------|----------------------------|
| HSTT75-48-5 | .750 (19.0) | .375 (9.5) |
| HSTT100-48-5 | 1.00 (25.4) | .500 (12.7) |

The proper choice is HSTT100-48-5 since the tube will recover more than HSTT75-48-5. The HSTT75-48-5 will fit over the .700 inch (17.8mm) outside diameter; however, this is not the proper choice since it is smaller than the HSTT100-48-5. In general, heat shrink should recover at least 10% – 20% to reduce stress and yield the longest service life.

A.
System
Overview

B1.
Cable Ties

B2.
Cable
Accessories

B3.
Stainless
Steel Ties

C1.
Wiring
Duct

C2.
Surface
Raceway

C3.
Abrasion
Protection

C4.
Cable
Management

D1.
Terminals

D2.
Power
Connectors

D3.
Grounding
Connectors

E1.
Labeling
Systems

E2.
Labels

E3.
Pre-Printed
& Write-On
Markers

E4.
Permanent
Identification

E5.
Lockout/
Tagout/
& Safety
Solutions

F.
Index

A. System Overview

Recommended Tubing Size for Common Wire Types Based on Location For Insulated Wire, Non-Insulated Wire, and Insulated Wire with Copper Connectors

B1. Cable Ties

Instructions for Tube Selection:

1) Determine location type.

B2. Cable Accessories

LOCATION:

DRY – IP62: A location not normally subject to dampness or wetness. A location classified as dry may be temporarily subject to dampness or wetness, as in the case of a building under construction.

B3. Stainless Steel Ties

DAMP – IP66: Partially protected locations under canopies, marquees, roofed open porches and like locations, and interior locations subject to moderate degrees of moisture, such as some basements, barns, and cold-storage warehouses.

WET – IP68: Installations underground or in concrete slabs or masonry in direct contact with the earth, and locations subject to saturation with water or other liquids, such as vehicle washing areas, and locations exposed to weather and unprotected.

C1. Wiring Duct

2) Match wire size to location type under required application – insulated wire, non-insulated wire, or insulated wire with copper connectors.

3) Read corresponding part number.

C2. Surface Raceway

4) Part numbers with “-Y” are packages containing 6 inch pieces. Part numbers with “-48” are 48 inch pieces.

5) Part numbers shown below are for black heat shrink.

C3. Abrasion Protection

| Wire Size | Insulated Wire | | | Uninsulated Wire | | | Insulated Wire with Copper Connector | | |
|-----------|----------------|--------------|-------------|------------------|--------------|-------------|--------------------------------------|--------------|-------------|
| | DRY-SHRINK™ | DAMP-SHRINK™ | WET-SHRINK™ | DRY-SHRINK™ | DAMP-SHRINK™ | WET-SHRINK™ | DRY-SHRINK™ | DAMP-SHRINK™ | WET-SHRINK™ |
| 24 | HSTT12-Y | HSTTA19-Y | — | — | — | — | HSTT12-Y | — | — |
| 22 | HSTT12-Y | HSTTA19-Y | — | — | — | — | HSTT12-Y | — | — |
| 20 | HSTT12-Y | HSTTA19-Y | — | HSTT06-Y | — | — | HSTT19-Y | HSTTA19-Y | — |
| 18 | HSTT19-Y | HSTTA19-Y | — | HSTT06-Y | — | — | HSTT19-Y | HSTTA19-Y | — |
| 16 | HSTT19-Y | HSTTA25-Y | — | HSTT06-Y | — | — | HSTT19-Y | HSTTA25-Y | — |
| 14 | HSTT19-Y | HSTTA25-Y | — | HSTT12-Y | HSTTA19-Y | — | HSTT19-Y | HSTTA25-Y | — |
| 12 | HSTT25-Y | HSTTA38-Y | HST0.4-48-5 | HSTT12-Y | HSTTA19-Y | — | HSTT25-Y | HSTTA38-Y | HST0.4-48-5 |
| 10 | HSTT25-Y | HSTTA38-Y | HST0.4-48-5 | HSTT19-Y | HSTTA25-Y | — | HSTT25-Y | HSTTA38-Y | HST0.4-48-5 |
| 8 | HSTT38-Y | HSTTA50-Y | HST0.4-48-5 | HSTT25-Y | HSTTA25-Y | — | HSTT38-Y | HSTTA50-Y | HST0.4-48-5 |
| 6 | HSTT50-Y | HSTTA50-Y | HST0.8-48-5 | HSTT25-Y | HSTTA38-Y | HST0.4-48-5 | HSTT50-Y | HSTTA50-Y | HST0.8-48-5 |
| 4 | HSTT50-Y | HSTTA75-Y | HST0.8-48-5 | HSTT38-Y | HSTTA38-Y | HST0.4-48-5 | HSTT50-Y | HSTTA75-Y | HST0.8-48-5 |
| 3 | HSTT50-Y | HSTTA75-Y | HST0.8-48-5 | HSTT38-Y | HSTTA50-Y | HST0.4-48-5 | HSTT50-Y | HSTTA75-Y | HST0.8-48-5 |
| 2 | HSTT75-Y | HSTTA100-Y | HST0.8-48-5 | HSTT50-Y | HSTTA50-Y | HST0.8-48-5 | HSTT75-Y | HSTTA100-Y | HST0.8-48-5 |
| 1 | HSTT75-Y | HSTTA100-Y | HST0.8-48-5 | HSTT50-Y | HSTTA50-Y | HST0.8-48-5 | HSTT75-Y | HSTTA100-Y | HST1.1-48-5 |
| 1/0 | HSTT75-Y | HSTTA100-Y | HST1.1-48-5 | HSTT50-Y | HSTTA75-Y | HST0.8-48-5 | HSTT75-Y | HSTTA100-Y | HST1.1-48-5 |
| 2/0 | HSTT100-Y | HSTTA100-Y | HST1.1-48-5 | HSTT50-Y | HSTTA75-Y | HST0.8-48-5 | HSTT100-Y | HSTTA100-Y | HST1.1-48-5 |
| 3/0 | HSTT100-Y | HSTTA150-Y | HST1.1-48-5 | HSTT75-Y | HSTTA100-Y | HST0.8-48-5 | HSTT100-Y | HSTTA150-Y | HST1.5-48-5 |
| 4/0 | HSTT100-Y | HSTTA150-Y | HST1.5-48-5 | HSTT75-Y | HSTTA100-Y | HST1.1-48-5 | HSTT100-Y | HSTTA150-Y | HST1.5-48-5 |
| 250 | HSTT100-Y | HSTTA150-Y | HST1.5-48-5 | HSTT100-Y | HSTTA100-Y | HST1.1-48-5 | HSTT100-Y | HSTTA150-Y | HST1.5-48-5 |
| 300 | HSTT150-48-5 | HSTTA150-Y | HST1.5-48-5 | HSTT100-Y | HSTTA100-Y | HST1.1-48-5 | HSTT100-Y | HSTTA150-Y | HST1.5-48-5 |
| 350 | HSTT150-48-5 | HSTTA150-Y | HST1.5-48-5 | HSTT100-Y | HSTTA150-Y | HST1.5-48-5 | HSTT150-48-5 | HSTTA150-Y | HST2.0-48-2 |
| 400 | HSTT150-48-5 | HSTTA150-Y | HST2.0-48-2 | HSTT100-Y | HSTTA150-Y | HST1.5-48-5 | HSTT150-48-5 | HSTTA150-Y | HST2.0-48-2 |
| 500 | HSTT150-48-5 | HSTTA150-Y | HST2.0-48-2 | HSTT100-Y | HSTTA150-Y | HST1.5-48-5 | HSTT150-48-5 | HSTTA150-Y | HST2.0-48-2 |
| 600 | HSTT150-48-5 | HSTTA150-Y | HST2.0-48-2 | HSTT150-48-5 | HSTTA150-Y | HST2.0-48-2 | HSTT150-48-5 | HSTTA150-Y | HST2.0-48-2 |
| 700 | HSTT200-48-5 | HSTTA150-Y | HST2.0-48-2 | HSTT150-48-5 | HSTTA150-Y | HST2.0-48-2 | HSTT200-48-5 | — | HST2.0-48-2 |
| 750 | HSTT200-48-5 | HSTTA150-Y | HST3.0-48-2 | HSTT150-48-5 | HSTTA150-Y | HST2.0-48-2 | HSTT200-48-5 | — | HST3.0-48-2 |
| 800 | HSTT200-48-5 | — | HST3.0-48-2 | HSTT150-48-5 | HSTTA150-Y | HST2.0-48-2 | HSTT200-48-5 | — | HST3.0-48-2 |
| 900 | HSTT200-48-5 | — | HST3.0-48-2 | HSTT150-48-5 | HSTTA150-Y | HST2.0-48-2 | HSTT200-48-5 | — | HST3.0-48-2 |
| 1000 | HSTT200-48-5 | — | HST3.0-48-2 | HSTT200-48-5 | HSTTA150-Y | HST2.0-48-2 | HSTT200-48-5 | — | HST3.0-48-2 |
| 1250 | HSTT300-48-2 | — | HST3.0-48-2 | HSTT200-48-5 | HSTTA150-Y | HST2.0-48-2 | — | — | HST3.0-48-2 |
| 1500 | HSTT300-48-2 | — | HST3.0-48-2 | HSTT200-48-5 | — | HST3.0-48-2 | — | — | — |
| 1750 | HSTT300-48-2 | — | HST3.0-48-2 | HSTT200-48-5 | — | HST3.0-48-2 | — | — | — |
| 2000 | HSTT300-48-2 | — | HST3.0-48-2 | HSTT200-48-5 | — | HST3.0-48-2 | — | — | — |

C4. Cable Management

D1. Terminals

D2. Power Connectors

D3. Grounding Connectors

E1. Labeling Systems

E2. Labels

E3. Pre-Printed & Write-On Markers

E4. Permanent Identification

E5. Lockout/Tagout & Safety Solutions

F. Index

Sizing information is based on the following wire types: MTW, THHN, THWN, TFN, THW, TW, TF, RHW, RH, RHH and UL 1015.

THHN is the most common wire type.

Portions reprinted with permission from NFPA, the National Electrical Code* Handbook, Copyright 1996, National Fire Protection Association, Quincy, MA 02269.

*All rights reserved. National Electrical Code and NEC are registered trademarks of the National Fire Protection Association, Inc., Quincy, MA 02269.

IP (Ingress Protection) as defined by the International Standard IEC 529

The IEC 529 international standard describes a system for classifying the degrees of protection provided by the enclosures of electrical equipment and is a recognized standard around the world. An independent test laboratory has tested *PANDUIT* Heat Shrink Tubing to the IEC 529 standard. The following information exhibits the IP ratings for *PANDUIT* heat shrink tubing and how each of the IP ratings relates to the USA.

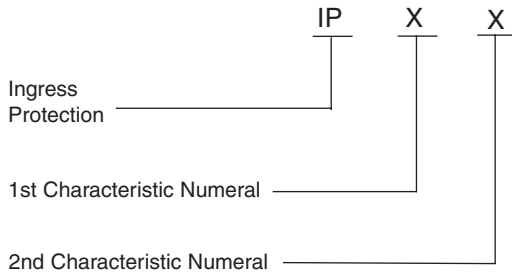



The first characteristic numeral indicates the level of protection against the ingress of solid foreign objects.

The second characteristic numeral indicates the level of protection against the ingress of water.

| 1st Characteristic Numeral | |
|--|------------------------|
| Ingress Protection (IP) | Meaning for Protection |
| Against ingress of solid object | |
| 0 | Non-Protected |
| 1 | 50mm diameter |
| 2 | 12.5mm diameter |
| 3 | 2.5mm diameter |
| 4 | 1.0mm diameter |
| 5 | Dust Protected |
| <i>DRY-SHRINK™</i> , <i>DAMP-SHRINK™</i> and <i>WET-SHRINK™</i> Heat Shrink Tubing | Dust Tight |

| 2nd Characteristic Numeral | | |
|--|--------------------------|------------------------|
| <i>PANDUIT</i> Heat Shrink | Ingress Protection (IP) | Meaning for Protection |
| | Against ingress of water | |
| | 0 | Non-Protected |
| | 1 | Vertically Dripping |
| <i>DRY-SHRINK™</i> Heat Shrink Tubing | 2 | Dripping (15° tilted) |
| | 3 | Spraying |
| | 4 | Splashing |
| | 5 | Jetting |
| <i>DAMP-SHRINK™</i> Heat Shrink Tubing | 6 | Powerful Jetting |
| | 7 | Temporary Immersion |
| <i>WET-SHRINK™</i> Heat Shrink Tubing | 8 | Continuous Immersion |

| | Intended Application Location | Ingress Protection Rating | Description |
|---|--|---------------------------|--|
|  | DRY locations not normally subject to moisture | IP62 | Protected against the ingress of dust but not protected against the ingress of water |
|  | DAMP locations subjected to moderate degrees of water and moisture | IP66 | Protected against the ingress of dust and protected against the ingress of power jet of water |
|  | WET locations are defined as underground burial or immersion in water | IP68 | Protected against the ingress of dust and protected against the ingress of water to a depth of 10m |

DRY-SHRINK™ Heat Shrink has been tested in accordance with EN 60529 paragraph 13.4 thereby providing *PANDUIT DRY-SHRINK™* Heat Shrink with an ingress protection rating of IP62.

DAMP-SHRINK™ Heat Shrink has been tested in accordance with EN 60529 paragraph 13.4 and with paragraph 14.2.6 thereby providing *PANDUIT® DAMP-SHRINK™* with an ingress protection rating of IP66.

WET-SHRINK™ Heat Shrink has been tested in accordance with EN 60529 paragraph 13.4, paragraph 14.2.6 and with paragraph 14.2.7 thereby providing *WET-SHRINK™* Heat Shrink with an ingress protection rating of IP68. *PANDUIT® WET-SHRINK™* Heat Shrink has passed EN 60529 paragraph 14.2.7 at depth of 10m.

A. System Overview

B1. Cable Ties

B2. Cable Accessories

B3. Stainless Steel Ties

C1. Wiring Duct

C2. Surface Raceway

C3. Abrasion Protection

C4. Cable Management

D1. Terminals

D2. Power Connectors

D3. Grounding Connectors

E1. Labeling Systems

E2. Labels

E3. Pre-Printed & Write-On Markers

E4. Permanent Identification

E5. Lockout/Tagout & Safety Solutions

F. Index

A. System Overview

DRY-SHRINK™, DAMP-SHRINK™, and WET-SHRINK™ Heat Shrink Tubing

B1. Cable Ties

Technical Data

General Information

| Product Type | Typical Applications | Specific Gravity | Flammability | Water Absorption | Dielectric Strength |
|---------------|--|--|---|------------------------|---|
| HSTT | Economical and easy way to insulate, protect, harness and identify electrical and electronic components in a wide variety of applications. Black is U.V. Resistant. | Class 1, 1.35 Class 2, 1.0 ASTM D792 | Class 1 Self Extinguishing Class 2 N/A ASTM D2671 Procedure B | .5% MAX. ASTM D570 | 500 V/MIL. (19.7 Kv/mm) min. ASTM D2671 |
| HSTTV | Use where UL recognition with VW-1 rating is required. Use where the wire component cannot tolerate higher shrink temperatures, reduces application time to insulate, protect, identify, etc. Black is U.V. Resistant. | 1.50 ASTM D792 | VW-1 per UL 224 | .5% MAX. ASTM D570 | 500 V/MIL. (19.7 Kv/mm) min. ASTM D2671 |
| HSTTP | Ripple free conformance around sharp bends as in appliance handles and bus bars. Good cut through and solder-iron resistance. Black is U.V. Resistant. | 1.35 MAX. | VW-1 per UL 224 | 1.0% MAX. ASTM D570 | 400 V/MIL. (15.8 Kv/mm) min. ASTM D2671 |
| HSTTPN | Crystal clear product that is excellent for protecting wire and cable markers and continuous inspection of splices | N/A | UL 224 VW-1 | 1.0% MAX. ASTM D570 | 400 V/MIL. (15.8 Kv/mm) min. ASTM D2671 |
| HSTTN | Insulation and abrasion resistance, extensive military uses on vehicles and ship-board. Excellent chemical resistance especially to fuels and oils. Black is U.V. Resistant. | 1.30 ASTM D792 | Self Extinguishing ASTM D876 | 1.0% MAX. ASTM D570 | 300 V/MIL. (11.8 Kv/mm) min. ASTM D2671 |
| HSTTT | High insulation and abrasion resistance. High temperature, strain relief, resists corrosive atmosphere, self lubrication and non-wetting. Can be used with fiber optics and as a strain relief for high density connectors. U.V. Resistant | 2.2 MAX. ASTM D792 | VW-1 per UL 224 | .01% MAX. ASTM D570 | 800 V/MIL. (31.5 Kv/mm) min. ASTM D2671 |
| HSTTK | Protection and strain relief for wires or connectors in a high temperature or solvent rich environment. Insulation of heater leads. | 1.8 MAX. ASTM D792 | VW-1 per UL 224 | .5% MAX. ASTM D570 | Size to (12.7mm) 800 V/MIL. (31.5 Kv/mm) min Over (12.7mm) 600 V/MIL. (23.6 Kv/mm) min ASTM D2671 |
| HSTTVA | Seals and protects components from moisture and corrosion. Use where a flexible tubing is needed. Suitable for damp locations. | N/A | Self Extinguishing ASTM D2671 Procedure B | .5% MAX. ASTM D570 | 500 V/MIL. (19.7 Kv/mm) min. ASTM D2671 |
| HSTTA | Environmentally seals and protects components. The 3:1 shrink ratio is a benefit when working with connector to cable transitions. Suitable for damp locations. | N/A | Self Extinguishing ASTM D2671 Procedure B | 1.0% MAX.ASTM D570 | 300 V/MIL. (11.8 Kv/mm) min. ASTM D2671 |
| HSTTRA | Environmentally seals and protects components forming a rugged and heavy duty covering. The 2.5:1 shrink ratio is a benefit when working with connector to cable transitions. Suitable for damp locations. | N/A | N/A | .5% MAX. ASTM D570 | 500 V/MIL. (19.7 Kv/mm) min. ASTM D2671 |
| HST | Seals and protects electrical connections and splices above or below ground, 3:1 shrink ratio. Suitable for outdoor and wet locations. | 1.2 MAX. | Self Extinguishing ASTM D2671 Procedure C | .5% MAX. ASTM D570 | 200 V/MIL. (7.9 Kv/mm) min. ASTM D2671 |

E4. Permanent Identification

E5. Lockout/ Tagout & Safety Solutions

F. Index

CABLE MANAGEMENT

PANDUIT offers a complete line of cable management products and accessories to route and secure cable. These products are an essential part of a clean, professional installation, which help improve quality and increase system performance.



PANDUIT solutions provide the options necessary to handle the most demanding installations while providing the flexibility to facilitate system upgrades now and in the future.

- Maintains bend radius control and cable performance while bundling and securing cable to prevent snags and stress from over bending
- Provides attractive installations and allows for easier moves, adds, and changes while reducing stress on cable
- Organizes cable in a variety of applications where depth is critical or space is limited

A.
System
Overview

B1.
Cable Ties

B2.
Cable
Accessories

B3.
Stainless
Steel Ties

C1.
Wiring
Duct

C2.
Surface
Raceway

C3.
Abrasion
Protection

C4.
Cable
Management

D1.
Terminals

D2.
Power
Connectors

D3.
Grounding
Connectors

E1.
Labeling
Systems

E2.
Labels

E3.
Pre-Printed
& Write-On
Markers

E4.
Permanent
Identification

E5.
Lockout/
Tagout
& Safety
Solutions

F.
Index



COOL BOOT™ Raised Floor Assembly

A. System Overview

B1. Cable Ties

B2. Cable Accessories

B3. Stainless Steel Ties

C1. Wiring Duct

C2. Surface Raceway

C3. Abrasion Protection

C4. Cable Management

D1. Terminals

D2. Power Connectors

D3. Grounding Connectors

E1. Labeling Systems

E2. Labels

E3. Pre-Printed & Write-On Markers

E4. Permanent Identification

E5. Lockout/Tagout & Safety Solutions

F. Index

- Air tight fabric minimizes bypass of air through cutouts in the raised floor to decrease energy costs in hot aisle/cold aisle data center designs
- **ULTRA-CINCH™** Tie closes top of fabric to prevent air from escaping around cable bundles
- Electrostatic dissipative material provides a pathway to ground reducing the chance of damaging network equipment with electric shock
- Vertical **TAK-TY®** Hook & Loop Cable Tie closure system allows for installation on existing cable bundles
- Horizontal **TAK-TY®** Hook & Loop Cable Tie closure system allows two or more bundles to be separated in existing or new installations

- Flexible polycarbonate outer ring houses fabric to allow user to secure product to raised floor tile; slit allows outer ring to flex so entire cable bundle can be inserted to allow for retrofit installations even when vertical cable managers are already in place
- Low profile polycarbonate outer ring extends 7/16" above top of raised floor tile to allow compatibility with vertical cable managers.
- Self-tapping #10 screws (included) allow a secure fastening method to top of raised floor tile that also provides a pathway to ground
- Color: Black polycarbonate outer ring with navy blue fabric
- Manufactured from flame retardant material



RFG*X*SM

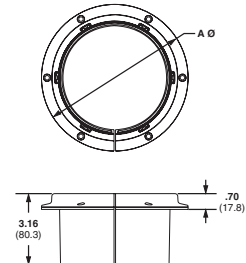
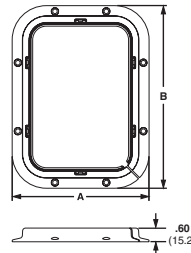

| Part Number | Material | Length | | Width | | Diameter | | Max. Bundle Diameter | | Std. Pkg. Qty. | Std. Ctn. Qty. |
|----------------------|---|--------|-------|-------|-------|----------|-------|----------------------|---------------|----------------|----------------|
| | | In. | mm | In. | mm | In. | mm | In. | mm | | |
| Surface Mount | | | | | | | | | | | |
| RFG6X8SM | Polycarbonate outer ring with vinyl coated fabric | 8.0 | 203.2 | 6.0 | 152.4 | — | — | 4.2 x 6.2 | 106.7 x 157.4 | 1 | 1 |
| RFG8X8SM | Polycarbonate outer ring with vinyl coated fabric | 8.0 | 203.2 | 8.0 | 203.2 | — | — | 6.2 x 6.2 | 157.4 x 157.4 | 1 | 1 |
| RFG10X8SM | Flame Retardant Conductive Polycarbonate with a Conductive Fabric | 8.0 | 203.2 | 10.0 | 254.0 | — | — | 8.2 x 6.2 | 208.3 x 157.4 | 1 | 1 |
| RFG12X4SM | Flame Retardant Conductive Polycarbonate with a Conductive Fabric | 4.0 | 101.6 | 12.0 | 304.8 | — | — | 10.2 x 2.2 | 259.1 x 55.9 | 1 | 1 |
| RFG12X8SM | Flame Retardant Conductive Polycarbonate with a Conductive Fabric | 8.0 | 203.2 | 12.0 | 304.8 | — | — | 10.2 x 6.2 | 259.1 x 157.4 | 1 | 1 |
| RFG3DSM | Flame Retardant Conductive Polycarbonate with a Conductive Fabric | — | — | — | — | 4.5 | 114.3 | 2.7 | 68.6 | 1 | 1 |
| RFG5DSM | Flame Retardant Conductive Polycarbonate with a Conductive Fabric | — | — | — | — | 6.5 | 165.1 | 4.7 | 119.4 | 1 | 1 |

Product complies with Article 645 Section 5(D)(4) of the 2005 National Electrical Code.
 Compatible with **NETRUNNER™** and **PATCHRUNNER™** Cable Managers, and **PANDUIT NET-ACCESS™** Cabinets to create a complete cable management system.
 *Integral products include a flexible sub-grommet to prevent damage to cable from sharp edges of cut floor tile.

COOL BOOT™ Raised Floor Assembly (continued)



RFG*X*

| Part Number | Material | Length | | Width | | Diameter | | Max. Bundle Diameter | | Std. Pkg. Qty. | Std. Ctn. Qty. |
|------------------------|---|--------|-------|-------|-------|----------|-------|----------------------|---------------|----------------|----------------|
| | | In. | mm | In. | mm | In. | mm | In. | mm | | |
| Integral Mount* | | | | | | | | | | | |
| RFG6X8 | Flame Retardant Conductive Polycarbonate with a Conductive Fabric | 8.0 | 203.2 | 6.0 | 152.4 | — | — | 4.2 x 6.2 | 106.7 x 157.4 | — | — |
| RFG8X8 | Flame Retardant Conductive Polycarbonate with a Conductive Fabric | 8.0 | 203.2 | 8.0 | 203.2 | — | — | 6.2 x 6.2 | 157.4 x 157.4 | 1 | 1 |
| RFG10X8 | Flame Retardant Conductive Polycarbonate with a Conductive Fabric | 8.0 | 203.2 | 10.0 | 254.0 | — | — | 8.2 x 6.2 | 208.3 x 157.4 | 1 | 1 |
| RFG12X4 | Flame Retardant Conductive Polycarbonate with a Conductive Fabric | 4.0 | 101.6 | 12.0 | 304.8 | — | — | 10.2 x 2.2 | 259.1 x 55.9 | 1 | 1 |
| RFG12X8 | Flame Retardant Conductive Polycarbonate with a Conductive Fabric | 8.0 | 203.2 | 12.0 | 304.8 | — | — | 10.2 x 2.2 | 259.1 x 157.4 | 1 | 1 |
| RFG3D | Flame Retardant Conductive Polycarbonate with a Conductive Fabric | — | — | — | — | 4.5 | 114.3 | 3.0 | 68.6 | 1 | 1 |
| RFG5D | Flame Retardant Conductive Polycarbonate with a Conductive Fabric and Thermoplastic Elastomer | — | — | — | — | 6.5 | 165.1 | 4.7 | 119.4 | 1 | 1 |

Product complies with Article 645 Section 5(D)(4) of the 2005 National Electrical Code.

Compatible with *NETRUNNER™* and *PATCHRUNNER™* Cable Managers, and *PANDUIT NET-ACCESS™* Cabinets to create a complete cable management system.

*Integral products include a flexible sub-grommet to prevent damage to cable from sharp edges of cut floor tile.

A.
System
Overview

B1.
Cable Ties

B2.
Cable
Accessories

B3.
Stainless
Steel Ties

C1.
Wiring
Duct

C2.
Surface
Raceway

C3.
Abrasion
Protection

C4.
Cable
Management

D1.
Terminals

D2.
Power
Connectors

D3.
Grounding
Connectors

E1.
Labeling
Systems

E2.
Labels

E3.
Pre-Printed
& Write-On
Markers

E4.
Permanent
Identification

E5.
Lockout/
Tagout/
& Safety
Solutions

F.
Index

A. System Overview



J-PRO™ Cable Support System

B1. Cable Ties

• Patent pending design provides complete horizontal and vertical 1 inch bend radius control that helps prevent degradation of cable performance

• Wide cable support base prevents pinch points that could cause damage to cables

B2. Cable Accessories

• UL 2043 and CAN/ULC S102.2 approved and suitable for use in air handling spaces

• Cable tie channel allows user to easily install 3/4" *TAK-TY*® Cable Ties to retain cable bundle

B3. Stainless Steel Ties

• Pre-ripped assemblies allow for attachment to walls, ceilings, beams, threaded rods, drop wires and underfloor supports to meet requirements of a variety of applications

• Durable non-metallic J Hook materials provide the ability to manage and support a large number of cables

C1. Wiring Duct



JP2W-L20

| Part Number* | Part Description | Max. Bundle Capacity | | Max. Cable Capacity | | | Max. Static Load | | Std. Pkg. Qty. |
|-------------------|--|----------------------|-------|---------------------|----------------|-----------------|------------------|-------|----------------|
| | | In. | mm | Cat. 6A (.330") | Cat. 6 (.250") | Cat. 5e (.187") | Lbs. | kg. | |
| Wall Mount | | | | | | | | | |
| JP75W-L20‡ | J Hook for wall mount applications. One 1/4" (M6) mounting hole for user supplied screw. | .75 | 19.0 | 2 | 11 | 15 | 15 | 6.81 | 50 |
| JP131W-L20 | | 1.31 | 33.3 | 9 | 26 | 32 | 20 | 9.07 | 50 |
| JP2W-L20‡ | | 2.00 | 50.8 | 23 | 50 | 64 | 30 | 13.6 | 50 |
| JP4W-X20‡‡ | | 4.00 | 101.6 | 103 | 225 | 250 | 100 | 45.37 | 10 |

C2. Surface Raceway



JP2WP-L20

| | | | | | | | | | |
|--------------------------------|---|------|-------|-----|-----|-----|-----|-------|----|
| Wall Mount with Bracket | | | | | | | | | |
| JP75WP-L20‡ | J Hook for powder actuated installation on walls. One 5/32" (M4) mounting hole for user supplied fasteners. | .75 | 19.0 | 2 | 11 | 15 | 15 | 6.81 | 50 |
| JP131WP-L20 | | 1.31 | 33.3 | 9 | 26 | 32 | 20 | 9.07 | 50 |
| JP2WP-L20‡ | | 2.00 | 50.8 | 23 | 50 | 64 | 30 | 13.61 | 50 |
| JP4WP-X20 | | 4.00 | 101.6 | 103 | 225 | 250 | 100 | 45.37 | 10 |

D1. Terminals



JP2CM-L20

| | | | | | | | | | |
|----------------------|--|------|-------|-----|-----|-----|-----|-------|----|
| Ceiling Mount | | | | | | | | | |
| JP75CM-L20‡ | J Hook with ceiling mount bracket that has one 3/16" (M5), 1/4" (M6) and 3/8" (M10) mounting hole. | .75 | 19.0 | 2 | 11 | 15 | 15 | 6.81 | 50 |
| JP131CM-L20 | | 1.31 | 33.3 | 9 | 26 | 32 | 20 | 9.07 | 50 |
| JP2CM-L20‡ | | 2.00 | 50.8 | 23 | 50 | 64 | 30 | 13.61 | 50 |
| JP4CM-X20 | | 4.00 | 101.6 | 103 | 225 | 250 | 100 | 45.37 | 10 |

D2. Power Connectors



JP2DW-L20

| | | | | | | | | | |
|--|--|------|------|----|----|----|----|------|----|
| Drop Wire and Threaded Rod Clip | | | | | | | | | |
| JP75DW-L20‡ | J Hook with clip for use with #12 wire, threaded rod up to 1/4" in diameter, or 1/8" - 1/4" thick flanges. | .75 | 19.0 | 2 | 11 | 15 | 10 | 4.53 | 50 |
| JP131DW-L20 | | 1.31 | 33.3 | 9 | 26 | 32 | 10 | 4.53 | 50 |
| JP2DW-L20 | | 2.00 | 50.8 | 23 | 50 | 64 | 10 | 4.53 | 50 |

D3. Grounding Connectors

E1. Labeling Systems

E2. Labels

E3. Pre-Printed & Write-On Markers

E4. Permanent Identification

E5. Lockout/Tagout & Safety Solutions

F. Index

*Suitable for use in air handling spaces in accordance with Sec. 300-22(c) and (d) of the National Electrical Code. JP4 family of parts suitable for use in single unit configurations. Listed in accordance with CAN/ULC S102.2 when mounted as single units or in pairs. Minimum spacing of 4' (1220mm) required between mount points. (Flame spread rating = 0, Smoke developed classification = 30)

‡Standard product is black in color. For red replace - L20 with - L2 in part number suffix.

‡‡Standard product is black in color. For red replace - X20 with - X2, for blue replace - X20 with - X6 in part number suffix.



J-PRO™ Cable Support System (continued)



JP2SBC50R-L20



JP2SBC50-L20



JP2SBC87-L20



JP2SBC87R-L20



JP2HBC25R-L20
JP2HBC50R-L20
JP2HBC75R-L20

| Part Number* | Part Description | Max. Bundle Capacity | | Max. Cable Capacity | | | Max. Static Load | | Std. Pkg. Qty. |
|------------------------------|--|----------------------|-------|---------------------|----------------|-----------------|------------------|-------|----------------|
| | | In. | mm | Cat. 6A (.330") | Cat. 6 (.250") | Cat. 5e (.187") | Lbs. | kg. | |
| Screw-On Beam Clamps | | | | | | | | | |
| JP75SBC50-L20 | J Hook with screw-on beam clamp for use with flanges up to 1/2" thick. | .75 | 19.0 | 2 | 11 | 15 | 15 | 6.81 | 50 |
| JP131SBC50-L20 | | 1.31 | 33.3 | 9 | 26 | 32 | 20 | 9.07 | 50 |
| JP2SBC50-L20 | | 2.00 | 50.8 | 23 | 50 | 64 | 30 | 13.61 | 50 |
| JP4SBC50-X20 | | 4.00 | 101.6 | 103 | 225 | 250 | 100 | 45.37 | 10 |
| JP75SBC50R-L20‡ | J Hook with screw-on beam clamp for use with flanges up to 1/2" thick. Rotates 360 degrees. | .75 | 19.0 | 2 | 11 | 15 | 15 | 6.81 | 50 |
| JP131SBC50R-L20 | | 1.31 | 33.3 | 9 | 26 | 32 | 20 | 9.07 | 50 |
| JP2SBC50R-L20‡ | | 2.00 | 50.8 | 23 | 50 | 64 | 30 | 13.61 | 50 |
| JP4SBC50R-X20 | | 4.00 | 101.6 | 103 | 225 | 250 | 100 | 45.37 | 10 |
| JP75SBC87-L20 | J Hook with screw-on beam clamp for use with flanges up to 3/4" thick. | .75 | 19.0 | 2 | 11 | 15 | 15 | 6.81 | 50 |
| JP131SBC87-L20 | | 1.31 | 33.3 | 9 | 26 | 32 | 20 | 9.07 | 50 |
| JP2SBC87-L20 | | 2.00 | 50.8 | 23 | 50 | 64 | 30 | 13.61 | 50 |
| JP4SBC87-X20 | | 4.00 | 101.6 | 103 | 225 | 250 | 100 | 45.37 | 10 |
| JP75SBC87R-L20 | J Hook with screw-on beam clamp for use with flanges up to 3/4" thick. | .75 | 19.0 | 2 | 11 | 15 | 15 | 6.81 | 50 |
| JP131SBC87R-L20 | | 1.31 | 33.3 | 9 | 26 | 32 | 20 | 9.07 | 50 |
| JP2SBC87R-L20 | | 2.00 | 50.8 | 23 | 50 | 64 | 30 | 13.61 | 50 |
| JP4SBC87R-X20 | | 4.00 | 101.6 | 103 | 225 | 250 | 100 | 45.37 | 10 |
| Hammer-On Beam Clamps | | | | | | | | | |
| JP75HBC25R-L20 | J Hook with hammer-on beam clamp for use with flanges 1/8" – 1/4" thick. Rotates 360 degrees. | .75 | 19.0 | 2 | 11 | 15 | 15 | 13.61 | 50 |
| JP131HBC25R-L20 | | 1.31 | 33.3 | 9 | 26 | 32 | 230 | 9.07 | 50 |
| JP2HBC25R-L20 | | 2.00 | 50.8 | 23 | 50 | 64 | 30 | 13.61 | 50 |
| JP4HBC25R-X20 | | 4.00 | 101.6 | 103 | 225 | 250 | 30 | 13.61 | 150 |
| JP75HBC50R-L20 | J Hook with hammer-on beam clamp for use with flanges 5/16" – 1/2" thick. Rotates 360 degrees. | .75 | 19.0 | 2 | 11 | 15 | 15 | 6.81 | 50 |
| JP131HBC50R-L20 | | 1.31 | 33.3 | 9 | 26 | 32 | 20 | 9.07 | 50 |
| JP2HBC50R-L20 | | 2.00 | 50.8 | 23 | 50 | 64 | 30 | 13.61 | 50 |
| JP4HBC50R-X20 | | 4.00 | 101.6 | 103 | 225 | 250 | 30 | 13.61 | 10 |
| JP75HBC75R-L20 | J Hook with hammer-on beam clamp for use with flanges 9/16" – 3/4" thick. Rotates 360 degrees. | .75 | 19.0 | 2 | 11 | 15 | 15 | 6.81 | 50 |
| JP131HBC75R-L20 | | 1.31 | 33.3 | 9 | 26 | 32 | 20 | 9.07 | 50 |
| JP2HBC75R-L20 | | 2.00 | 50.8 | 23 | 50 | 64 | 30 | 13.61 | 50 |
| JP4HBC75R-X20 | | 4.0 | 101.6 | 1.03 | 225 | 250 | 30 | 13.61 | 10 |

*Suitable for use in air handling spaces in accordance with Sec. 300-22(c) and (d) of the National Electrical Code. JP4 family of parts suitable for use in single unit configurations. Listed in accordance with CAN/ULC S102.2 when mounted as single units or in pairs. Minimum spacing of 4" (1220mm) required between mount points. (Flame spread rating = 0, Smoke developed classification = 30)

‡Standard product is black in color. For red replace – L20 with – L2 in part number suffix.

‡‡Standard product is black in color. For red replace – X20 with – X2, for blue replace – X20 with – X6 in part number suffix.

Table continues on page C4.6

A.
System
Overview

B1.
Cable Ties

B2.
Cable
Accessories

B3.
Stainless
Steel Ties

C1.
Wiring
Duct

C2.
Surface
Raceway

C3.
Abrasion
Protection

C4.
Cable
Management

D1.
Terminals

D2.
Power
Connectors

D3.
Grounding
Connectors

E1.
Labeling
Systems

E2.
Labels

E3.
Pre-Printed
& Write-On
Markers

E4.
Permanent
Identification

E5.
Lockout/
Tagout
& Safety
Solutions

F.
Index

A.
System
Overview



J-PRO™ Cable Support System (continued)

B1.
Cable Ties



JP2ZP-L20

B2.
Cable
Accessories

B3.
Stainless
Steel Ties

C1.
Wiring
Duct



JP2CP-L20

C2.
Surface
Raceway

C3.
Abrasion
Protection



JP2UF100-L20

C4.
Cable
Management

D1.
Terminals

D2.
Power
Connectors

D3.
Grounding
Connectors

E1.
Labeling
Systems

E2.
Labels

E3.
Pre-Printed
& Write-On
Markers

E4.
Permanent
Identification

E5.
Lockout/
Tagout/
& Safety
Solutions

F.
Index

| Part Number* | Part Description | Max. Bundle Capacity | | Max. Cable Capacity | | | Max. Static Load | | Std. Pkg. Qty. |
|--|--|----------------------|-------|---------------------|----------------|-----------------|------------------|-------|----------------|
| | | In. | mm | Cat. 6A (.330") | Cat. 6 (.250") | Cat. 5e (.187") | Lbs. | kg. | |
| Z-Purlin Clips | | | | | | | | | |
| JP75ZP-L20 | J Hook with z-purlin clip for use with angled flanges up to 1/4" thick. | .75 | 19.0 | 2 | 11 | 15 | 15 | 6.81 | 50 |
| JP131ZP-L20 | | 1.31 | 33.3 | 9 | 26 | 32 | 20 | 9.07 | 50 |
| JP2ZP-L20 | | 2.00 | 50.8 | 23 | 50 | 64 | 30 | 13.61 | 50 |
| JP4ZP-X20 | | 4.00 | 101.6 | 103 | 225 | 250 | 60 | 27.22 | 10 |
| C-Purlin Clips | | | | | | | | | |
| JP75CP-L20 | J Hook with c-purlin clip for use with vertical flanges up to 1/4" thick. | .75 | 19.0 | 2 | 11 | 15 | 15 | 6.81 | 50 |
| JP131CP-L20 | | 1.31 | 33.3 | 9 | 26 | 32 | 20 | 9.07 | 50 |
| JP2CP-L20 | | 2.00 | 50.8 | 23 | 50 | 64 | 30 | 13.61 | 50 |
| JP4CP-X20 | | 4.00 | 101.6 | 103 | 225 | 250 | 60 | 27.22 | 10 |
| Underfloor Pedestal Support Clamp | | | | | | | | | |
| JP75UF100-L20 | J Hook with underfloor pedestal support clamp for use with pedestal support up to 1" diameter. | .75 | 19.0 | 2 | 11 | 15 | 15 | 6.81 | 50 |
| JP131UF100-L20 | | 1.31 | 33.3 | 9 | 26 | 32 | 20 | 9.07 | 50 |
| JP2UF100-L20 | | 2.00 | 50.8 | 23 | 50 | 64 | 30 | 13.61 | 50 |
| JP4UF100-X20 | | 4.00 | 101.6 | 103 | 225 | 250 | 50 | 22.69 | 10 |

*Suitable for use in air handling spaces in accordance with Sec. 300-22(c) and (d) of the National Electrical Code. JP4 family of parts suitable for use in single unit configurations. Listed in accordance with CAN/ULC S102.2 when mounted as single units or in pairs. Minimum spacing of 4' (1220mm) required between mount points. (Flame spread rating = 0, Smoke developed classification = 30)

‡Standard product is black in color. For red replace – L20 with – L2 in part number suffix.

‡‡Standard product is black in color. For red replace – X20 with – X2, for blue replace – X20 with – X6 in part number suffix.



J-MOD® Cable Support System

- Modular design allows flexibility to assemble system in multiple configurations
- Unique chaining bracket design creates a strong metal backbone and allows expansion of the system without disturbance of an existing installation

- Brackets allow for attachment to ceilings, beams, threaded rods and drop wires to meet requirements of a variety of applications
- Manufactured from materials that meet UL 2043 and are suitable for use in air handling spaces
- Complete horizontal and vertical 1" bend radius control
- Cables do not come in contact with metal



JMJDW-X20

JMJDH-X20

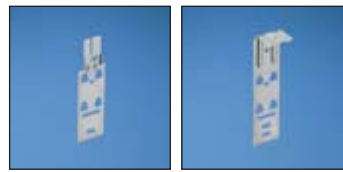

JMJDH-X20

JMJDW-X20

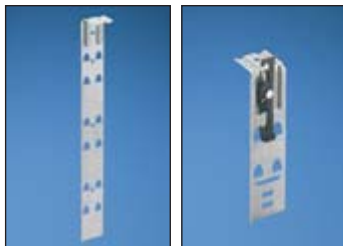

JMJDW-3-X

JMJDWB-1-X



JMJDWB-1-X

JMJDWB-3-X

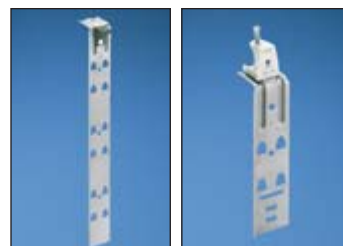

JMJDWB-3-X

JMJDWB-1-X



JMJDWB-3-X

| Part Number | Part Description | Material* | Max. Static Load | | Std. Pkg. Qty. | Std. Ctn. Qty. |
|---|---|---|------------------|-------|----------------|----------------|
| | | | Lbs. | Kg. | | |
| J Hook with Maximum 2" Bundle Capacity | | | | | | |
| JMJDW-X20* | J Hook for wall mount applications only. Two 1/4" (M6) mounting holes for user supplied screws. | Nylon 6.6 | 30 | 13.61 | 10 | 50 |
| JMJDH-X20* | J Hook with snap lock attachments for use with all brackets listed below. | Nylon 6.6 | 30 | 13.61 | 10 | 50 |
| Chaining Bracket | | | | | | |
| JMJDH-X | Chaining bracket to extend J-MOD® capacity one level. Capacity: three levels maximum. For use with all single-level mounting brackets listed below. | Zinc Plated Steel | 120 | 54.45 | 10 | 50 |
| Ceiling Mount Brackets | | | | | | |
| JMJDW-1-X | Single-level ceiling mount bracket with one 1/4" (M6) mounting hole. | Galvanized Steel | 180 | 81.65 | 10 | 50 |
| JMJDW-3-X** | Three-level ceiling mount bracket with one 1/4" (M6) mounting hole. Maximum capacity of six J Hooks. | Galvanized Steel | 180 | 81.65 | 10 | 50 |
| Drop Wire Brackets | | | | | | |
| JMJDWB-1-X | Single-level drop wire bracket. Attaches to #12 wire or 1/4" plain rod. Maximum capacity of one J Hook per level. | Galvanized Steel with Metal Attachments | 20 | 9.07 | 10 | 50 |
| JMJDWB-3-X** | Three-level drop wire bracket. Attaches to #12 wire or 1/4" plain rod. Maximum capacity of one J Hook for each of three levels. | Galvanized Steel with Metal Attachments | 40 | 18.14 | 10 | 50 |
| Threaded Rod Brackets | | | | | | |
| JMJDWB-1-X | Single-level threaded rod bracket. Accepts 1/4" – 3/8" threaded rod. | Galvanized Steel with Metal Attachments | 180 | 81.65 | 10 | 50 |
| JMJDWB-3-X** | Three-level threaded rod bracket. Accepts 1/4" – 3/8" threaded rod. Maximum capacity of six J Hooks. | Galvanized Steel with Metal Attachments | 180 | 81.65 | 10 | 50 |
| Screw-On Beam Clamp Brackets | | | | | | |
| JMJDWB-1-X | Single-level screw-on beam clamp bracket for use with flanges up to 3/4" thick. | Galvanized Steel with Metal Attachments | 180 | 81.65 | 10 | 50 |
| JMJDWB-3-X** | Three-level screw-on beam clamp bracket for use with flanges up to 3/4" thick. Maximum capacity of six J Hooks. | Galvanized Steel with Metal Attachments | 180 | 81.65 | 10 | 50 |

*Suitable for use in air handling spaces and listed in accordance with UL 2043 and CAN/ULC S102.2 when mounted as single units or in pairs. Maximum spacing of 4' (1220mm) required between mount points. (Flame Spread Rating = 0, Smoke Developed Classification = 30)

**Not for use with chaining brackets.

A. System Overview

B1. Cable Ties

B2. Cable Accessories

B3. Stainless Steel Ties

C1. Wiring Duct

C2. Surface Raceway

C3. Abrasion Protection

C4. Cable Management

D1. Terminals

D2. Power Connectors

D3. Grounding Connectors

E1. Labeling Systems

E2. Labels

E3. Pre-Printed & Write-On Markers

E4. Permanent Identification

E5. Lockout/Tagout & Safety Solutions

F. Index

A.
System
Overview

Conduit Waterfall

B1.
Cable Ties

- Helps prevent pinch points and over bending that could cause damage to cable
- Suitable for use in air handling spaces per UL 2043
- UL listed per UL 1565

- Unique patent pending design allows for use in both new and retrofit applications
- Allows user to install 3/4" *TAK-TY*® Cable Ties to provide a method to retain and manage the cable bundle
- Material: Black Glass-Filled PBT meets UL 94V-0 specifications

B2.
Cable
Accessories

- Able to manage and support a large capacity of cables
- Easy and fast to install reducing labor cost

B3.
Stainless
Steel Ties



| Part Number | Part Description | Std. Pkg. Qty. | Std. Ctn. Qty. |
|---------------|--|----------------|----------------|
| CWF400 | Provides bend radius control for cables entering/exiting 4" EMT conduit. Secure to conduit without tools utilizing integral thumb screw and captive nut. | 1 | 10 |

C1.
Wiring
Duct

C2.
Surface
Raceway

C3.
Abrasion
Protection

Waterfall Accessories

C4.
Cable
Management

- Patented bend radius control product
- Product available as a kit (includes base, two wings, and cable ties) or purchased separately
- Easy to install waterfall kit maintains bend radius control in both vertical and horizontal directions to provide a TIA/EIA-568-B compliant installation

- Base attaches to either the rung or stringer on most standard ladder racks for a variety of installations/configurations
- Modular components allow user to custom configure each location where cable management is required
- Material: Black Glass-Filled Nylon 6.6 meets UL 94V-0 specifications

D1.
Terminals

D2.
Power
Connectors

D3.
Grounding
Connectors

E1.
Labeling
Systems

E2.
Labels

E3.
Pre-Printed
& Write-On
Markers

E4.
Permanent
Identification

E5.
Lockout/
Tagout/
& Safety
Solutions

F.
Index



CMW-KIT

| Part Number | Part Description | Color* | Std. Pkg. Qty. | Std. Ctn. Qty. |
|----------------|--|--------|----------------|----------------|
| CMW-KIT | Cable management waterfall kit. Provides bend radius control when transferring cables from standard ladder rack. Kit includes CMWB, two CMWW, and cable ties. | Black | 1 | 10 |
| CMWB | Cable management waterfall base. Used to maintain 1.75" bend radius control vertically when transferring cable off of ladder rack. Mounts to ladder rack rung or stringer with standard cross section cable ties (included). | | 1 | 10 |
| CMWW | Cable management waterfall wing. Used in conjunction with CMWB to maintain 1.00" bend radius control horizontally when transferring cable off ladder rack. | | 1 | 10 |

*For white, include suffix of 10. For example: CMW-KIT10.



CMWB



CMWW



Double Waterfall Accessory

- Double waterfall base attaches to the rung on most standard ladder racks to allow bend radius control for cables coming from either direction
- UL 94V-0 Rated Material
- Easy to install double waterfall base maintains bend radius control in a vertical direction to provide a TIA/EIA-568-B compliant installation



| Part Number | Part Description | Color | Std. Pkg. Qty. | Std. Ctn. Qty. |
|-------------|--|-------|----------------|----------------|
| CMW2B | Cable management double waterfall base. Used to maintain 1.75" bend radius control vertically when transferring cable off either side of ladder rack rung. Mounts to ladder rack rung with standard cross section cable ties (included). | Black | 1 | 10 |

Stackable Cable Rack Spacers

- Patented ladder rack accessories
- Separate and support cable and prevent pinch points between the bottom row of cable and the rung as a result of the weight of multiple cable layers applied on top of each other
- Mount to ladder rack with standard cross section cable ties
- Maximize rack space by stacking products for maximum cable capacity
- Provide an alternative to lacing cord by allowing user to secure cable to spacer to prevent movement of cable
- Color: Black



CRS6-X



CRS1-X



CRS4-125-X



CRS1-125-X

| Part Number | Part Description | Width | | Std. Pkg. Qty. | Std. Ctn. Qty. |
|-------------|--|-------|-------|----------------|----------------|
| | | In. | mm | | |
| CRS6-X | Six space stackable cable rack spacer. Accepts cable up to .80" diameter. | 5.25 | 133.4 | 10 | 100 |
| CRS1-X | One space stackable cable rack spacer. Use with CRS6 to fill width of ladder rack. Accepts cable up to .80" diameter. | 1.13 | 28.58 | 10 | 100 |
| CRS4-125-X | Four space stackable cable rack spacer. Accepts cable up to 1.25" diameter. | 5.24 | 133.1 | 10 | 100 |
| CRS1-125-X | One space stackable cable rack spacer. Use with CRS4 to fill width of ladder rack. Accepts cable up to 1.25" diameter. | 1.55 | 39.4 | 10 | 100 |

A. System Overview

B1. Cable Ties

B2. Cable Accessories

B3. Stainless Steel Ties

C1. Wiring Duct

C2. Surface Raceway

C3. Abrasion Protection

C4. Cable Management

D1. Terminals

D2. Power Connectors

D3. Grounding Connectors

E1. Labeling Systems

E2. Labels

E3. Pre-Printed & Write-On Markers

E4. Permanent Identification

E5. Lockout/Tagout & Safety Solutions

F. Index

A. System Overview

Threaded Rod Cover

B1. Cable Ties

- Protects cable from abrasion caused by contact with threaded rod
- Material meets UL 94V-0 specifications
- Available in 18 inch lengths
- Accept 1/2" to 5/8" threaded rod
- For indoor use only
- Material: Gray Polyethylene

B2. Cable Accessories



B3. Stainless Steel Ties

| Part Number | Part Description | Std. Pkg. Qty. | Std. Ctn. Qty. |
|-------------------|--|----------------|----------------|
| TRC18FR-X8 | Used to protect cabling from threaded rod. Vertical slit allows easy installation. | 10 | 100 |

C1. Wiring Duct

C2. Surface Raceway

C3. Abrasion Protection

Vertical D-Rings **PATENTED**

C4. Cable Management

- Patented cable manager ring
- Standard EIA hole spacing allows product to be mounted to any standard rack
- Flexible material allows arm to rotate so entire cable bundle can be inserted and removed
- 1/4" mounting holes allow for a variety of screws to secure the D-ring to a surface
- Material: Black Polycarbonate

D1. Terminals

D2. Power Connectors

D3. Grounding Connectors



E1. Labeling Systems



E2. Labels

E3. Pre-Printed & Write-On Markers



E4. Permanent Identification

E5. Lockout/Tagout & Safety Solutions

F. Index

| Part Number | Part Description | Fiber | ScTP | UTP | Std. Pkg. Qty. | Std. Ctn. Qty. |
|----------------|--|-------|------|-----|----------------|----------------|
| CMVDR1 | Vertical D-ring. Outside dimensions 5.70"L x 2.00"W. | 252 | 48 | 96 | 1 | 10 |
| CMVDR1S | Vertical D-ring. Outside dimensions 3.30"L x 2.00"W. | 132 | 32 | 52 | 1 | 10 |
| CMVDR2 | Vertical D-ring. Outside dimensions 5.70"L x 3.00"W. | 504 | 96 | 192 | 1 | 10 |
| CMVDR2S | Vertical D-ring. Outside dimensions 3.30"L x 3.00"W. | 252 | 48 | 96 | 1 | 10 |
| CMVDRC | Center mounted vertical D-ring for routing cables between two adjacent racks. Requires 8.25" spacing between the center lines of the adjacent rack's mounting holes. Outside dimensions 5.60"L x 8.00"W. | 1000 | 200 | 400 | 1 | 10 |

All product color is black.

TAK-TY® Hook & Loop Cable Tie Mounts

- For use with TAK-TY® Hook & Loop Cable Ties, see page B1.87
- Unique cradle design provides maximum stability for cable bundle
- For indoor use only
- Dimensions: 1.10"L x 1.10"W x .34"H (27.9mm x 27.9mm x 8.6mm)

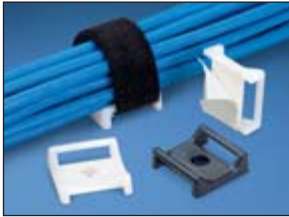

| Part Number | Used with Cable Ties‡ | Material | Color | Max. Static Load | | Mounting Method* | Std. Pkg. Qty. | Std. Ctn. Qty. | |
|--------------------|-----------------------|-----------|---------|------------------|-----|------------------|----------------|----------------|------|
| | | | | Lbs. | g | | | | |
| ABMT-A-C | HLT | Nylon 6.6 | Natural | .38 | 174 | Rubber | 100 | 1000 | |
| ABMT-A-C20 | | | Black | | | | | | |
| ABMT-S6-C | | | Natural | — | — | | #6 (M3) Screw | 100 | 1000 |
| ABMT-S6-C20 | | | Black | | | | | | |
| ABMT-S6-C60 | | Black | | | | | | | |
| ABMT-S6-C69 | | Natural | | | | | | | |

‡Cable tie cross section sizes: HLT/HLS = TAK-TY® Hook & Loop Ties.

*For proper selection of adhesives see page B2.52.

Flat PAN-POST™ Standoffs

- Standard EIA hole spacing allows product to be mounted with user supplied screws up to 1/4" diameter
- Organize cables in standard cabinets and racks
- Mounting method: 1/4" (M6) screw
- Use where space is limited
- For indoor use only



| Part Number | Part Description | Std. Pkg. Qty. | Std. Ctn. Qty. |
|-----------------------|---|----------------|----------------|
| PPF2S-S25-V | Nylon 6.6 flat PAN-POST™ Standoff. Use with miniature, intermediate, and standard cross section cable ties. Dimensions 5.4"L x 1.5"H x .2"W (137.2mm x 38.1mm x 5.1mm). | 5 | 100 |
| PPF2S-S25-V69 | Flame retardant Nylon 6.6 flat PAN-POST™ Standoff. Use with miniature, intermediate, and standard cross section cable ties. Material meets UL 94V-0 specifications. Dimensions 5.4"L x 1.5"H x .2"W (137.2mm x 38.1mm x 5.1mm). | 5 | 100 |
| PPF2SV-S25-V | Nylon 6.6 flat PAN-POST™ Standoff. Use with TAK-TY® Hook & Loop Cable Ties. Dimensions 5.6"L x 1.6"H x .2"W (142.2mm x 40.6mm x 5.1mm). | 5 | 100 |
| PPF2SV-S25-V69 | Flame retardant Nylon 6.6 flat PAN-POST™ Standoff. Use with TAK-TY® Hook & Loop Cable Ties. Material meets UL 94V-0 specifications. Dimensions 5.6"L x 1.6"H x .2"W (144.8mm x 53.3mm x 5.1mm). | 5 | 100 |

A. System Overview

B1. Cable Ties

B2. Cable Accessories

B3. Stainless Steel Ties

C1. Wiring Duct

C2. Surface Raceway

C3. Abrasion Protection

C4. Cable Management

D1. Terminals

D2. Power Connectors

D3. Grounding Connectors

E1. Labeling Systems

E2. Labels

E3. Pre-Printed & Write-On Markers

E4. Permanent Identification

E5. Lockout/Tagout & Safety Solutions

F. Index

A.
System
Overview

Communication Cable Management Kit for Cabinets

B1.
Cable Ties

- Kit of cable management accessories specifically designed for use in a network cabinet or enclosure

B2.
Cable
Accessories



B3.
Stainless
Steel Ties

| Part Number | Part Description | Std. Pkg. Qty. | Std. Ctn. Qty. |
|----------------|---|----------------|----------------|
| CCMKIT1 | Kit includes the following: 1 roll (15' length) .33" <i>TAK-TY</i> ® Cable Ties 24 nylon cable ties 12 adhesive backed cable tie mounts 6 push style cable tie mounts 4 vertical wire saddles 8 flat <i>PAN-POST</i> ™ Standoffs for use with std. nylon cable ties | 1 | 100 |
| CCMKIT2 | Kit includes the following: 1 roll (15' length) .75" <i>TAK-TY</i> ® Cable Ties 12 nylon cable ties 6 adhesive backed cable tie mounts 6 adhesive backed mounts for .75" <i>TAK-TY</i> ® Cable Ties 6 screw mounts for .75" <i>TAK-TY</i> ® Cable Ties 4 vertical wire saddles 6 flat <i>PAN-POST</i> ™ Standoffs for use with .75" <i>TAK-TY</i> ® Cable Ties | 1 | 100 |

Order the number of kits required.

C1.
Wiring
Duct

C2.
Surface
Raceway

C3.
Abrasion
Protection

C4.
Cable
Management

D1.
Terminals

D2.
Power
Connectors

D3.
Grounding
Connectors

E1.
Labeling
Systems

E2.
Labels

E3.
Pre-Printed
& Write-On
Markers

E4.
Permanent
Identification

E5.
Lockout/
Tagout/
& Safety
Solutions

F.
Index

PAN-TERM® TERMINALS

PANDUIT® PAN-TERM® Terminals are designed and manufactured for fast assembly, and reliable performance. PANDUIT provides an extensive line of tooling designed specifically to provide optimum performance. As the demand for loose piece terminals increases, it becomes essential to provide a complete system for termination products.



- Funnel entry available on vinyl and nylon insulated terminals and disconnects, speeds insertion, and minimizes turned back wire strands
- Made of electrolytic copper to provide an optimum combination of crimp forming and high conductivity properties to provide superior terminations
- Offered in various types including rings, forks, flanged forks, locking forks and short locking forks
- Available in sizes from #26 – 2 AWG and stud hole diameters from #2 – 1/2"; non-insulated tubular terminals sizes from #8 – 250 kcmil
- Applicable sizes are UL Listed and CSA Certified, RoHS compliant, ABS (American Bureau of Shipping) Approved, Class IE Nuclear Rated, DFARS 252.225-7014 Compliant and meet Military Specifications MS25036 and MS20659 as noted
- Wide assortment of manual, controlled cycle, battery operated hydraulic and pneumatic crimping tools for reliable connections at the lowest installed cost

PANDUIT continually provides new designs to meet the application challenges encountered by our customers. PANDUIT offers a wide assortment of PAN-TERM® termination products to meet customer needs at the lowest installed cost.

A.
System
Overview

B1.
Cable Ties

B2.
Cable
Accessories

B3.
Stainless
Steel Ties

C1.
Wiring
Duct

C2.
Surface
Raceway

C3.
Abrasion
Protection

C4.
Cable
Management

D1.
Terminals

D2.
Power
Connectors

D3.
Grounding
Connectors

E1.
Labeling
Systems

E2.
Labels

E3.
Pre-Printed
& Write-On
Markers

E4.
Permanent
Identification

E5.
Lockout/
Tagout
& Safety
Solutions

F.
Index

A. System Overview

Features and Benefits – PAN-TERM® Terminals

B1. Cable Ties

All PANDUIT terminals feature high quality materials made with electrolytic copper for high conductivity and are tin-plated for corrosion resistance.

B2. Cable Accessories

Non-Insulated Terminals Type P

Maximum recommended operating temperature 302°F (150°C)

Product markings provide easy identification of wire size



Extended barrel length assures a good quality crimp and makes crimping easier

Internal barrel serrations assure good wire contact and maximum tensile strength

Brazed seam assures crimp reliability

Internally beveled barrel for quick easy wire insertion



UL and CSA rated up to 2000 V per UL 486A.
Nickel plated terminals rated up to 650°F (343°C) maximum operating temperature.

Nylon Insulated Terminals with Insulation Grip Sleeve Type PN or PNF

Internal barrel serrations assure good wire contact and maximum tensile strength

Insulation grip sleeve provides a superior insulation crimp for high vibration and high strain relief applications

Funnel entry for faster insertion and lower installed cost



Maximum insulation temperature 221°F (105°C)

Sleeved barrel assures crimp reliability

Color coded insulation identifies wire range



UL and CSA rated up to 600 V per UL 486.
Flammability – UL 94V-2/HB.
Proprietary blend of UL 94V-2 and UL 94HB flammability rated materials.

D1. Terminals

Vinyl Insulated Terminals With Insulation Support Type PV

Internal barrel serrations assure good wire contact and maximum tensile strength

Insulation crimp provides insulation support to protect electrical crimp

Funnel entry for faster insertion and lower installed cost



Maximum insulation temperature 221°F (105°C)

Brazed seam assures crimp reliability

Color coded insulation identifies wire range



UL and CSA rated up to 600 V per UL 486.
Flammability – UL 94V-0.

Non-Insulated Seamless Tubular Terminals Type S

Internally beveled barrel for quick easy wire insertion

Seamless tubular barrel provides consistent, high performance, quality crimps

Maximum recommended operating temperature 302°F (150°C)

Inspection hole allows visual inspection for proper wire insertion

Product markings provide easy identification of wire sizes

Double thickness provides a strong ring tongue



UL and CSA rated up to 2000 V per UL 486A.

D2. Power Connectors

D3. Grounding Connectors

E1. Labeling Systems

E2. Labels

E3. Pre-Printed & Write-On Markers

E4. Permanent Identification

E5. Lockout/Tagout & Safety Solutions

F. Index



PANDUIT extensive line of tooling is specifically designed for optimum crimping performance.

See pages D1.83 – D1.88.



PANDUIT designs and manufactures a full line of labeling products, software and printers to assist you with your labeling requirements.

See pages E1.1 – E2.30.

Selection Guide – PAN-TERM® Ring Terminals

| Insulation Material | | Style | Feature | Type | Page Number |
|------------------------------|--------------------|---|--------------------------------|---------|-------------|
| Ring Terminals | Nylon | Standard Ring | Insulation Grip | PN-R | D1.6 |
| | | | Funnel Entry | PNF-R | D1.8 |
| | | | Expanded Insulation | PN-RX | D1.7 |
| | | | Heavy Duty | PN-HDR | D1.13 |
| | | Multiple Stud | Insulation Grip | PN-610R | D1.9 |
| | Vinyl | Standard Ring | Insulation Support | PV-R | D1.10 |
| | | | Expanded Insulation | PV-RX | D1.11 |
| | | | Heavy Duty | PV-HDR | D1.14 |
| | | | Large Wire, Insulation Support | PV-R/X | D1.15 |
| | | Expanded Insulation, Insulation Support | PV-RX | D1.16 | |
| Multiple Stud | Insulation Support | PV-610R | D1.12 | | |
| Heat Shrink | Standard Ring | Heat Shrink Insulation | PH-R | D1.13 | |
| KYNAR [®] Insulated | Standard Ring | Insulation Grip | PK-R | D1.12 | |
| Non-Insulated | Standard Ring | Brazed Seam | P-R | D1.17 | |
| | | High Temp, Brazed Seam | P-RHT | D1.18 | |
| | | Heavy Duty | P-HDR | D1.19 | |
| | | Large Wire | P-R | D1.19 | |
| | Multiple Stud | Brazed Seam | P-610R | D1.18 | |
| | Tubular Ring | Large Wire, Seamless Barrel | S-R | D1.20 | |



▪KYNAR is a registered trademark of Atofina Chemicals, Inc.

A. System Overview

B1. Cable Ties

B2. Cable Accessories

B3. Stainless Steel Ties

C1. Wiring Duct

C2. Surface Raceway

C3. Abrasion Protection

C4. Cable Management

D1. Terminals

D2. Power Connectors

D3. Grounding Connectors

E1. Labeling Systems

E2. Labels

E3. Pre-Printed & Write-On Markers

E4. Permanent Identification

E5. Lockout/Tagout & Safety Solutions

F. Index

Selection Guide – PAN-TERM® Fork Terminals

A. System Overview

B1. Cable Ties

B2. Cable Accessories

B3. Stainless Steel Ties

C1. Wiring Duct

C2. Surface Raceway

C3. Abrasion Protection

C4. Cable Management

D1. Terminals

D2. Power Connectors

D3. Grounding Connectors

E1. Labeling Systems

E2. Labels

E3. Pre-Printed & Write-On Markers

E4. Permanent Identification

E5. Lockout/Tagout & Safety Solutions

F. Index

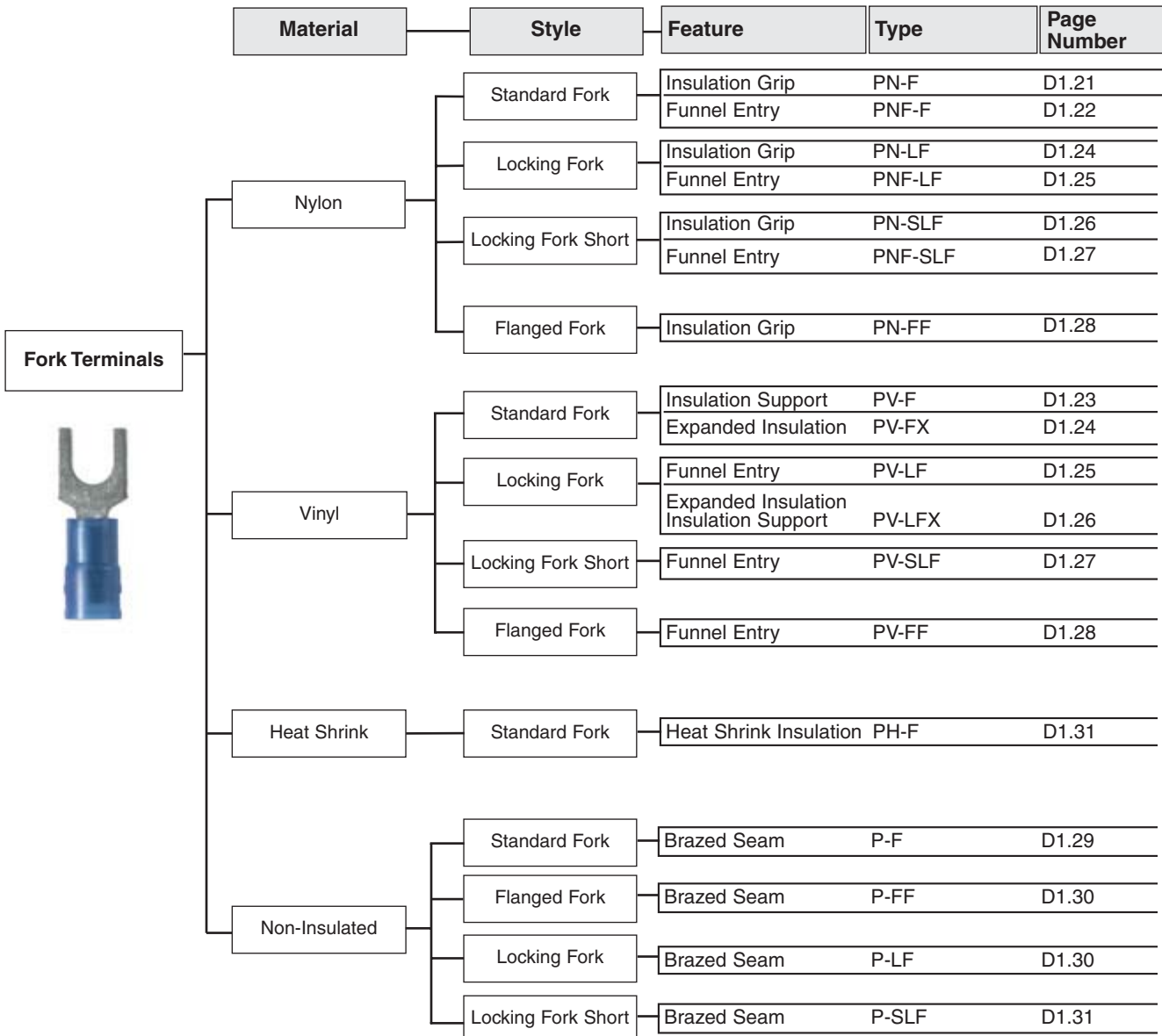

Part Number System for *PAN-TERM*® Terminals

| <u>P</u> | <u>N</u> | <u>14</u> | <u>4</u> | <u>R</u> | <u>X</u> | <u>C</u> |
|-----------------------------|--|--|--|--|--|---|
| Type | Insulation | Wire Range | Stud Size | Tongue Configuration | Special Configuration | Std. Pkg. Size |
| P = Seamed Barrel | K = KYNAR [®] Insulated | 22 = #26 - 22 18 = #22 - 18 | 2 = #2 4 = #4 | HDR = Heavy Duty Ring F = Fork | HT6 = High Temperature | 5 = 5 X = 10 |
| S = Seamless Tubular Barrel | N = Nylon Insulated | 14 = #16 - 14 12 = #16 - 12 | 5 = #5 6 = #6 | FF = Flanged Fork LF = Locking Fork | N = Narrow Tongue | E = 20 Q = 25 |
| | NF = Nylon Insulated Funnel Entry | 10 = #12 - 10 8 = #8 6 = #6 | 8 = #8 14 = 1/4" | R = Ring SLF = Short Locking Fork | W = Wide Tongue X = Expanded Insulation | L = 50 C = 100 T = 200 D = 500 M = 1000 |
| | V = Vinyl Insulated Non-Ins. (leave blank) | 4 = #4 2 = #2 1 = #1 | 56 = 5/16" 38 = 3/8" 76 = 7/16" 12 = 1/2" | | = Non-Expanded Insulation (leave blank) | |
| | | 1/0 = 1/0 2/0 = 2/0 3/0 = 3/0 4/0 = 4/0 250 = 250kcmil | | | | |

■KYNAR is a registered trademark of Atofina Chemicals, Inc.

A.
System
Overview

B1.
Cable Ties

B2.
Cable
Accessories

B3.
Stainless
Steel Ties

C1.
Wiring
Duct

C2.
Surface
Raceway

C3.
Abrasion
Protection

C4.
Cable
Management

D1.
Terminals

D2.
Power
Connectors

D3.
Grounding
Connectors

E1.
Labeling
Systems

E2.
Labels

E3.
Pre-Printed
& Write-On
Markers

E4.
Permanent
Identification

E5.
Lockout/
Tagout
& Safety
Solutions

F.
Index

A. System Overview

B1. Cable Ties



Ring Terminal, Nylon Insulated

Type PN-R

- Ring tongue design assures a secure connection in high vibration applications
- Metal insulation grip sleeve crimps to wire insulation, providing protection to the crimp joint during high vibration applications
- Internal barrel serrations assure good wire contact and maximum tensile strength

- UL Flammability UL 94V-2/HB, maximum insulation temperature 221°F (105°C)
- UL and CSA rated up to 600 V per UL 486

B2. Cable Accessories

B3. Stainless Steel Ties

C1. Wiring Duct

C2. Surface Raceway

C3. Abrasion Protection

C4. Cable Management

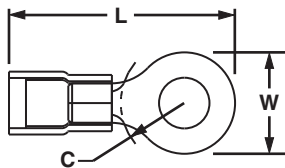

D1. Terminals

D2. Power Connectors

D3. Grounding Connectors

E1. Labeling Systems

E2. Labels

E3. Pre-Printed & Write-On Markers

E4. Permanent Identification

E5. Lockout/Tagout & Safety Solutions

F. Index

| Part Number | Wire Range | Color Code | Stock Thickness | Max. Ins. | Stud Size | Figure Dimensions (In.) | | | Recommended Installation Tool | Std. Pkg. Qty.** | Std. Ctn. Qty. | |
|-------------|-------------|------------|-----------------|-----------|-----------|-------------------------|-----|------|--|--|----------------|-----|
| | | | | | | L | W | C | | | | |
| PN22-2R-C* | 26 – 22 AWG | Yellow | .02 | .090 | #2 | .69 | .20 | .18 | CT-100, CT-600-A, CT-1525, CT-2500 | 100 | 1000 | |
| PN22-4R-C* | | | .02 | .090 | #4 | .69 | .20 | .18 | | 100 | 1000 | |
| PN22-6R-C* | | | .02 | .090 | #6 | .69 | .20 | .18 | | 100 | 1000 | |
| PN22-8R-C* | | | .02 | .090 | #8 | .78 | .26 | .26 | | 100 | 1000 | |
| PN22-10R-C* | 22 – 18 AWG | Red | .02 | .090 | #10 | .78 | .31 | .24 | CT-100‡, CT-600-A‡, CT-1550‡, CT-1551‡, CT-2500‡ | 100 | 1000 | |
| PN18-4RN-C^ | | | .03 | .145 | #4 | .74 | .22 | .18 | | 100 | 500 | |
| PN18-4R-C | | | .03 | .145 | #4 | .80 | .25 | .22 | | 100 | 500 | |
| PN18-6RN-C^ | | | .03 | .145 | #6 | .77 | .22 | .18 | | 100 | 500 | |
| PN18-6R-C^ | | | .03 | .145 | #6 | .80 | .25 | .22 | | 100 | 500 | |
| PN18-8R-C^ | | | .03 | .145 | #8 | .86 | .31 | .25 | | 100 | 500 | |
| PN18-10R-C^ | | | .03 | .145 | #10 | .88 | .31 | .25 | | 100 | 500 | |
| PN18-14R-C^ | | | .03 | .145 | 1/4" | 1.09 | .45 | .38 | | 100 | 500 | |
| PN18-56R-C^ | .03 | .145 | 5/16" | 1.09 | .46 | .38 | 100 | 500 | | | | |
| PN18-38R-C^ | 18 – 14 AWG | Blue | .03 | .145 | 3/8" | 1.17 | .53 | .43 | CT-100‡, CT-600-A‡, CT-1550‡, CT-1551‡, CT-2500‡ | 100 | 500 | |
| PN18-12R-C | | | .03 | .145 | 1/2" | 1.35 | .72 | .53 | | 100 | 500 | |
| PN14-4R-C^ | | | .03 | .162 | #4 | .78 | .25 | .20 | | CT-100‡, CT-600-A‡, CT-1550‡, CT-1551‡, CT-2500‡ | 100 | 500 |
| PN14-6RN-C^ | | | .03 | .162 | #6 | .76 | .25 | .20 | | | 100 | 500 |
| PN14-6R-C^ | | | .03 | .162 | #6 | .85 | .31 | .25 | | | 100 | 500 |
| PN14-8R-C^ | | | .03 | .162 | #8 | .85 | .31 | .25 | | | 100 | 500 |
| PN14-10R-C^ | | | .03 | .162 | #10 | .85 | .31 | .25 | | | 100 | 500 |
| PN14-14R-C^ | | | .03 | .162 | 1/4" | 1.05 | .46 | .38 | | | 100 | 500 |
| PN14-56R-C^ | | | .03 | .162 | 5/16" | 1.05 | .46 | .38 | | | 100 | 500 |
| PN14-38R-L^ | | | .03 | .162 | 3/8" | 1.14 | .53 | .43 | | | 50 | 500 |
| PN14-12R-L | | | .03 | .162 | 1/2" | 1.35 | .72 | .53 | | | 50 | 500 |
| PN10-6R-L^ | | | 12 – 10 AWG | Yellow | .04 | .225 | #6 | 1.06 | | | .37 | .31 |
| PN10-8R-L^ | .04 | .225 | | | #8 | 1.06 | .37 | .31 | 50 | | 500 | |
| PN10-10R-L^ | .04 | .225 | | | #10 | 1.06 | .38 | .31 | 50 | | 500 | |
| PN10-14R-L^ | .04 | .225 | | | 1/4" | 1.21 | .52 | .38 | 50 | 500 | | |
| PN10-56R-L^ | .04 | .225 | | | 5/16" | 1.21 | .52 | .38 | 50 | 500 | | |
| PN10-38R-L^ | .04 | .225 | | | 3/8" | 1.29 | .58 | .43 | 50 | 500 | | |
| PN10-12R-L | .04 | .225 | 1/2" | 1.47 | .72 | .53 | 50 | 500 | | | | |

*Wire sizes #26 – 22 AWG, are not UL Listed or CSA Certified.

**To order in bulk, replace -C in the part number with -M for a bulk package of 1000 and replace -L with -D for a bulk package of 500.

^For military specification cross reference see page D1.95

‡UL and CSA approved tooling/product combinations. For crimping tool information, see pages D1.83, D1.84, D1.86 and D1.88.



Ring Terminal, Nylon Insulated – Expanded Insulation

Type PN-RX

- Expanded wire entry designed to accommodate wire with a larger insulation thickness
- Ring tongue design assures a secure connection in high vibration applications
- Metal insulation grip sleeve crimps to wire insulation, providing protection to the crimp joint during high vibration applications
- Internal barrel serrations assure good wire contact and maximum tensile strength
- UL Flammability UL 94V-2/HB, maximum insulation temperature 221°F (105°C)
- UL and CSA rated up to 600 V per UL 486

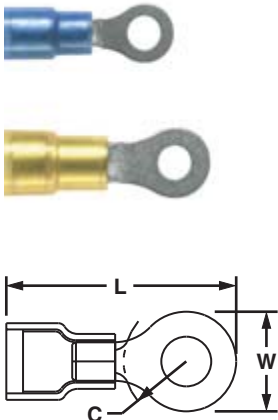

| Part Number | Wire Range | Color Code | Stock Thickness | Max. Ins. | Stud Size | Figure Dimensions (In.) | | | Recommended Installation Tool | Std. Pkg. Qty.** | Std. Ctn. Qty. |
|-------------|-------------|------------|-----------------|-----------|-----------|-------------------------|-----|-----|--|------------------|----------------|
| | | | | | | L | W | C | | | |
| PN14-6RX-C | 16 – 14 AWG | Blue | .03 | .200 | #6 | .93 | .31 | .25 | CT-100‡, CT-600-A‡, CT-1550‡, CT-1551‡, CT-2500‡ | 100 | 500 |
| PN14-8RX-C | | | .03 | .200 | #8 | .93 | .31 | .25 | | | |
| PN14-10RX-C | | | .03 | .200 | #10 | .93 | .31 | .25 | | | |
| PN14-14RX-C | | | .03 | .200 | 1/4" | 1.13 | .46 | .38 | | | |
| PN10-6RX-L | 12 – 10 AWG | Yellow | .04 | .265 | #6 | 1.13 | .37 | .33 | CT-100‡, CT-600-A‡, CT-1550‡, CT-1551‡, CT-2500‡ | 50 | 500 |
| PN10-8RX-L | | | .04 | .265 | #8 | 1.13 | .37 | .33 | | | |
| PN10-10RX-L | | | .04 | .265 | #10 | 1.13 | .37 | .33 | | | |
| PN10-14RX-L | | | .04 | .265 | 1/4" | 1.27 | .52 | .42 | | | |
| PN10-56RX-L | | | .04 | .265 | 5/16" | 1.27 | .52 | .42 | | | |
| PN10-38RX-L | | | .04 | .265 | 3/8" | 1.35 | .58 | .46 | | | |

**To order in bulk, replace -C in the part number with -M for a bulk package of 1000 and replace -L with -D for a bulk package of 500.
 ‡UL and CSA approved tooling/product combinations. For crimping tool information, see pages D1.83, D1.84, D1.86 and D1.88.

A. System Overview

B1. Cable Ties

B2. Cable Accessories

B3. Stainless Steel Ties

C1. Wiring Duct

C2. Surface Raceway

C3. Abrasion Protection

C4. Cable Management

D1. Terminals

D2. Power Connectors

D3. Grounding Connectors

E1. Labeling Systems

E2. Labels

E3. Pre-Printed & Write-On Markers

E4. Permanent Identification

E5. Lockout/Tagout & Safety Solutions

F. Index

A. System Overview

B1. Cable Ties



Ring Terminal, Nylon Insulated – Funnel Entry

Type PNF-R

- Ring tongue design assures a secure connection in high vibration applications
- Metal insulation grip sleeve crimps to wire insulation, providing protection to the crimp joint during high vibration applications
- Internal barrel serrations assure good wire contact and maximum tensile strength

- UL Flammability UL 94V-2/HB, maximum insulation temperature 221°F (105°C)
- UL and CSA rated up to 600 V per UL 486

B2. Cable Accessories

B3. Stainless Steel Ties

C1. Wiring Duct



C2. Surface Raceway



C3. Abrasion Protection



C4. Cable Management

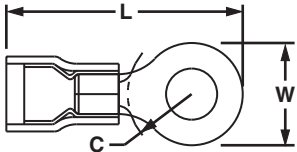

D1. Terminals

D2. Power Connectors

D3. Grounding Connectors

E1. Labeling Systems

E2. Labels

E3. Pre-Printed & Write-On Markers

E4. Permanent Identification

E5. Lockout/Tagout & Safety Solutions

F. Index

| Part Number | Wire Range | Color Code | Stock Thickness | Max. Ins. | Stud Size | Figure Dimensions (In.) | | | Recommended Installation Tool | Std. Pkg. Qty.** | Std. Ctn. Qty. | | | |
|---------------------|-------------|------------|-----------------|-----------|-----------|-------------------------|-----|------|--|------------------|--|--|-----|-----|
| | | | | | | L | W | C | | | | | | |
| PNF18-4R-C | 22 – 18 AWG | Red | .03 | .136 | #4 | .77 | .25 | .20 | CT-100‡, CT-600-A‡, CT-1550‡, CT-1551‡, CT-2500‡ | 100 | 500 | | | |
| PNF18-6RN-C^ | | | .03 | .136 | #6 | .76 | .22 | .18 | | 100 | 500 | | | |
| PNF18-6R-C^ | | | .03 | .136 | #6 | .77 | .25 | .20 | | 100 | 500 | | | |
| PNF18-8R-C^ | | | .03 | .136 | #8 | .87 | .31 | .24 | | 100 | 500 | | | |
| PNF18-10R-C^ | | | .03 | .136 | #10 | .87 | .32 | .25 | | 100 | 500 | | | |
| PNF18-14R-C^ | | | .03 | .136 | 1/4" | 1.08 | .46 | .38 | | 100 | 500 | | | |
| PNF18-56R-C^ | | | .03 | .136 | 5/16" | 1.08 | .46 | .39 | | 100 | 500 | | | |
| PNF18-38R-C^ | | | .03 | .136 | 3/8" | 1.16 | .53 | .41 | | 100 | 500 | | | |
| PNF14-4R-C^ | | | 16 – 14 AWG | Blue | .03 | .162 | #4 | .78 | | .25 | .18 | CT-100‡, CT-600-A‡, CT-1550‡, CT-1551‡, CT-2500‡ | 100 | 500 |
| PNF14-6RN-C^ | | | | | .03 | .162 | #6 | .78 | | .25 | .18 | | 100 | 500 |
| PNF14-6R-C^ | .03 | .162 | | | #6 | .87 | .31 | .24 | 100 | 500 | | | | |
| PNF14-8R-C^ | .03 | .162 | | | #8 | .87 | .31 | .25 | 100 | 500 | | | | |
| PNF14-10R-C^ | .03 | .162 | | | #10 | .85 | .31 | .29 | 100 | 500 | | | | |
| PNF14-14R-C^ | .03 | .162 | | | 1/4" | 1.06 | .46 | .40 | 100 | 500 | | | | |
| PNF14-56R-C^ | .03 | .162 | | | 5/16" | 1.06 | .46 | .40 | 100 | 500 | | | | |
| PNF14-38R-L^ | .03 | .162 | | | 3/8" | 1.14 | .53 | .45 | 50 | 500 | | | | |
| PNF10-6R-L^ | 12 – 10 AWG | Yellow | | | .04 | .225 | #6 | 1.06 | .37 | .31 | CT-100‡, CT-600-A‡, CT-1550‡, CT-1551‡, CT-2500‡ | | 50 | 500 |
| PNF10-8R-L^ | | | | | .04 | .225 | #8 | 1.06 | .37 | .31 | | | 50 | 500 |
| PNF10-10R-L^ | | | .04 | .225 | #10 | 1.06 | .37 | .31 | 50 | 500 | | | | |
| PNF10-14R-L^ | | | .04 | .225 | 1/4" | 1.21 | .52 | .38 | 50 | 500 | | | | |
| PNF10-56R-L^ | | | .04 | .225 | 5/16" | 1.21 | .52 | .38 | 50 | 500 | | | | |
| PNF10-38R-L^ | | | .04 | .225 | 3/8" | 1.29 | .58 | .43 | 50 | 500 | | | | |

**To order in bulk, replace -C in the part number with -M for a bulk package of 1000 and replace -L with -D for a bulk package of 500.

^For military specification cross reference see page D1.95.

‡UL and CSA approved tooling/product combinations. For crimping tool information, see pages D1.83, D1.84, D1.86 and D1.88.

UL LISTED **SP CERTIFIED** **Multiple Stud Terminal, Nylon Insulated**

Type PN-610R

- Teardrop shaped mounting hole of multiple stud terminals permits use with #6, #8, or #10 size studs
- Ring tongue design assures a secure connection in high vibration applications
- Metal insulation grip sleeve crimps to wire insulation, providing protection to the crimp joint during high vibration applications
- Internal barrel serrations assure good wire contact and maximum tensile strength
- UL Flammability UL 94V-2/HB, maximum insulation temperature 221°F (105°C)
- UL and CSA rated up to 600 V per UL 486

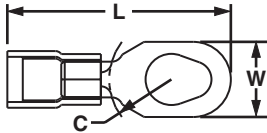

| Part Number | Wire Range | Color Code | Stock Thickness | Max. Ins. | Stud Size | Figure Dimensions (In.) | | | Recommended Installation Tool | Std. Pkg. Qty.** | Std. Ctn. Qty. |
|--------------------|-------------|------------|-----------------|-----------|-------------|-------------------------|-----|-----|--|------------------|----------------|
| | | | | | | L | W | C | | | |
| PN18-610R-C | 22 – 18 AWG | Red | .03 | .145 | #6, #8, #10 | .95 | .31 | .25 | CT-100‡, CT-600-A‡, CT-1550‡, CT-1551‡, CT-2500‡, CT-400 | 100 | 500 |
| PN14-610R-C | 16 – 14 AWG | Blue | .03 | .165 | | .95 | .31 | .25 | | | |
| PN10-610R-L | 12 – 10 AWG | Yellow | .04 | .225 | | 1.17 | .37 | .33 | | 50 | 500 |

**To order in bulk, replace -C or -CY in the part number with -M or -MY for a bulk package of 1000 and replace -L with -D for a bulk package of 500.
 ‡UL and CSA approved tooling/product combinations. For crimping tool information, see pages D1.83, D1.84, D1.86 and D1.88.

A. System Overview

B1. Cable Ties

B2. Cable Accessories

B3. Stainless Steel Ties

C1. Wiring Duct

C2. Surface Raceway

C3. Abrasion Protection

C4. Cable Management

D1. Terminals

D2. Power Connectors

D3. Grounding Connectors

E1. Labeling Systems

E2. Labels

E3. Pre-Printed & Write-On Markers

E4. Permanent Identification

E5. Lockout/Tagout & Safety Solutions

F. Index

A. System Overview

B1. Cable Ties

B2. Cable Accessories

B3. Stainless Steel Ties

C1. Wiring Duct

C2. Surface Raceway

C3. Abrasion Protection

C4. Cable Management

D1. Terminals

D2. Power Connectors

D3. Grounding Connectors

E1. Labeling Systems

E2. Labels

E3. Pre-Printed & Write-On Markers

E4. Permanent Identification

E5. Lockout/Tagout & Safety Solutions

F. Index



Ring Terminal, Vinyl Insulated – Funnel Entry

Type PV-R

- Insulation support helps to prevent wire damage in bending applications
- Ring tongue design assures a secure connection in high vibration applications
- Brazed seam protects terminal barrel from splitting during the crimp process
- UL Flammability UL 94V-0, maximum insulation temperature 221°F (105°C)
- Internal barrel serrations assure good wire contact and maximum tensile strength
- UL and CSA rated up to 600 V per UL 486

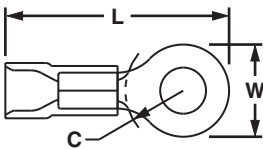

| Part Number | Wire Range | Color Code | Stock Thickness | Max. Ins. | Stud Size | Figure Dimensions (In.) | | | Recommended Installation Tool | Std. Pkg. Qty.** | Std. Ctn. Qty. | | | |
|-------------|-------------|------------|-----------------|-----------|-----------|-------------------------|--|-----|--|------------------|----------------|-----|-----|--|
| | | | | | | L | W | C | | | | | | |
| PV22-2R-C* | 26 – 22 AWG | Yellow | .02 | .110 | #2 | .68 | .21 | .18 | CT-100, CT-600-A, CT-1525, CT-2500 | 100 | 1000 | | | |
| PV22-4R-C* | | | .02 | .110 | #4 | .68 | .21 | .18 | | | | | | |
| PV22-6R-C* | | | .02 | .110 | #6 | .68 | .21 | .18 | | | | | | |
| PV22-8R-C* | | | .02 | .110 | #8 | .78 | .26 | .26 | | | | | | |
| PV22-10R-C* | | | .02 | .110 | #10 | .78 | .32 | .24 | | | | | | |
| PV18-4R-CY | 22 – 18 AWG | Red | .03 | .150 | #4 | .84 | .25 | .22 | CT-100‡, CT-600-A‡, CT-1550‡, CT-1551‡, CT-2500‡ | 100 | 500 | | | |
| PV18-6R-CY | | | .03 | .150 | #6 | .86 | .25 | .22 | | | | | | |
| PV18-8R-CY | | | .03 | .150 | #8 | .91 | .31 | .26 | | | | | | |
| PV18-10R-CY | | | .03 | .150 | #10 | .94 | .31 | .27 | | | | | | |
| PV18-14R-CY | | | .03 | .150 | 1/4" | 1.11 | .46 | .37 | | | | | | |
| PV18-56R-CY | | | .03 | .150 | 5/16" | 1.11 | .46 | .39 | | | | | | |
| PV18-38R-CY | | | .03 | .150 | 3/8" | 1.19 | .53 | .42 | | | | | | |
| PV18-12R-CY | .03 | .150 | 1/2" | 1.42 | .72 | .53 | CT-100‡, CT-600-A‡, CT-1550‡, CT-1551‡, CT-2500‡ | 100 | 500 | | | | | |
| PV14-4R-C | 16 – 14 AWG | Blue | .03 | .170 | #4 | .84 | | | | .25 | .19 | | | |
| PV14-6RN-C | | | .03 | .170 | #6 | .84 | | | | .25 | .19 | | | |
| PV14-6R-C | | | .03 | .170 | #6 | .92 | | | | .31 | .25 | | | |
| PV14-8R-C | | | .03 | .170 | #8 | .92 | | | | .31 | .25 | | | |
| PV14-10R-C | | | .03 | .170 | #10 | .92 | | | | .31 | .25 | | | |
| PV14-14R-C | | | .03 | .170 | 1/4" | 1.12 | | | | .46 | .38 | | | |
| PV14-56R-C | | | .03 | .170 | 5/16" | 1.12 | | | | .46 | .38 | | | |
| PV14-38R-L | | | .03 | .170 | 3/8" | 1.21 | | | | .53 | .43 | | | |
| PV14-12R-L | | | .03 | .170 | 1/2" | 1.42 | | | | .72 | .53 | | | |
| PV10-6R-L | | | 12 – 10 AWG | Yellow | .04 | .225 | | | | #6 | 1.05 | .31 | .31 | CT-100‡, CT-600-A‡, CT-1550‡, CT-1551‡, CT-2500‡ |
| PV10-8R-L | .04 | .225 | | | #8 | 1.05 | | | | .31 | .31 | | | |
| PV10-10R-L | .04 | .225 | | | #10 | 1.05 | | | | .31 | .31 | | | |
| PV10-14R-L | .04 | .225 | | | 1/4" | 1.23 | .52 | .38 | | | | | | |
| PV10-56R-L | .04 | .225 | | | 5/16" | 1.23 | .52 | .38 | | | | | | |
| PV10-38R-L | .04 | .225 | | | 3/8" | 1.31 | .58 | .41 | | | | | | |
| PV10-12R-L | .04 | .225 | | | 1/2" | 1.46 | .72 | .53 | | | | | | |

*Wire sizes #26 – 22 AWG, are not UL Listed or CSA Certified.

**To order in bulk, replace -C or -CY in the part number with -M or -MY for a bulk package of 1000 and replace -L with -D for a bulk package of 500.

‡UL and CSA approved tooling/product combinations. For crimping tool information, see pages D1.83, D1.84, D1.86 and D1.88.



Ring Terminal, Vinyl Expanded Insulation

Type PV-RX

- Expanded wire entry designed to accommodate wire with a larger insulation thickness
- Ring tongue design assures a secure connection in high vibration applications
- Insulation support helps to prevent wire damage in bending applications
- Brazed seam protects terminal barrel from splitting during the crimp process
- UL Flammability UL 94V-0, maximum insulation temperature 221°F (105°C)
- Internal barrel serrations assure good wire contact and maximum tensile strength
- UL and CSA rated up to 600 V per UL 486

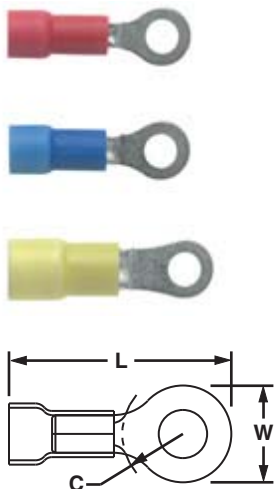

| Part Number | Wire Range | Color Code | Stock Thickness | Max. Ins. | Stud Size | Figure Dimensions (in.) | | | Recommended Installation Tool | Std. Pkg. Qty.** | Std. Ctn. Qty. |
|--------------|-------------|------------|-----------------|-----------|-----------|-------------------------|-----|-----|--|------------------|----------------|
| | | | | | | L | W | C | | | |
| PV18-4RX-CY | 22 – 18 AWG | Red | .03 | .170 | #4 | .88 | .25 | .22 | CT-100‡, CT-600-A‡, CT-1550‡, CT-1551‡, CT-2500‡ | 100 | 500 |
| PV18-6RX-CY | | | .03 | .170 | #6 | .89 | .25 | .22 | | 100 | 500 |
| PV18-8RX-CY | | | .03 | .170 | #8 | .97 | .31 | .27 | | 100 | 500 |
| PV18-10RX-CY | | | .03 | .170 | #10 | .96 | .31 | .27 | | 100 | 500 |
| PV18-14RX-CY | | | .03 | .170 | 1/4" | 1.17 | .46 | .40 | | 100 | 500 |
| PV18-56RX-CY | | | .03 | .170 | 5/16" | 1.17 | .46 | .40 | | 100 | 500 |
| PV18-38RX-CY | | | .03 | .170 | 3/8" | 1.25 | .53 | .45 | | 100 | 500 |
| PV14-4RX-C | 16 – 14 AWG | Blue | .03 | .200 | #4 | .87 | .25 | .19 | CT-100‡, CT-600-A‡, CT-1550‡, CT-1551‡, CT-2500‡ | 100 | 500 |
| PV14-6RX-C | | | .03 | .200 | #6 | .96 | .31 | .25 | | 100 | 500 |
| PV14-8RX-C | | | .03 | .200 | #8 | .96 | .31 | .25 | | 100 | 500 |
| PV14-10RX-C | | | .03 | .200 | #10 | .96 | .31 | .25 | | 100 | 500 |
| PV14-14RX-C | | | .03 | .200 | 1/4" | 1.16 | .46 | .37 | | 100 | 500 |
| PV14-56RX-C | | | .03 | .200 | 5/16" | 1.16 | .46 | .37 | | 100 | 500 |
| PV14-38RX-L | | | .03 | .200 | 3/8" | 1.25 | .53 | .42 | | 50 | 500 |
| PV10-6RX-L | 12 – 10 AWG | Yellow | .04 | .250 | #6 | 1.10 | .31 | .30 | CT-100‡, CT-600-A‡, CT-1550‡, CT-1551‡, CT-2500‡ | 50 | 500 |
| PV10-8RX-L | | | .04 | .250 | #8 | 1.10 | .31 | .30 | | 50 | 500 |
| PV10-10RX-L | | | .04 | .250 | #10 | 1.10 | .31 | .30 | | 50 | 500 |
| PV10-14RX-L | | | .04 | .250 | 1/4" | 1.29 | .52 | .39 | | 50 | 500 |
| PV10-56RX-L | | | .04 | .250 | 5/16" | 1.29 | .52 | .42 | | 50 | 500 |
| PV10-38RX-L | | | .04 | .250 | 3/8" | 1.39 | .58 | .46 | | 50 | 500 |

**To order in bulk, replace -C or -CY in the part number with -M or -MY for a bulk package of 1000 and replace -L with -D for a bulk package of 500.

‡UL and CSA approved tooling/product combinations. For crimping tool information, see pages D1.83, D1.84, D1.86 and D1.88.

A. System Overview

B1. Cable Ties

B2. Cable Accessories

B3. Stainless Steel Ties

C1. Wiring Duct

C2. Surface Raceway

C3. Abrasion Protection

C4. Cable Management

D1. Terminals

D2. Power Connectors

D3. Grounding Connectors

E1. Labeling Systems

E2. Labels

E3. Pre-Printed & Write-On Markers

E4. Permanent Identification

E5. Lockout/Tagout & Safety Solutions

F. Index

A. System Overview

B1. Cable Ties

B2. Cable Accessories

B3. Stainless Steel Ties

C1. Wiring Duct

C2. Surface Raceway

C3. Abrasion Protection

C4. Cable Management

D1. Terminals

D2. Power Connectors

D3. Grounding Connectors

E1. Labeling Systems

E2. Labels

E3. Pre-Printed & Write-On Markers

E4. Permanent Identification

E5. Lockout/Tagout & Safety Solutions

F. Index



Multiple Stud Terminal, Vinyl Insulated – Funnel Entry

Type PV-610R

- Teardrop shaped mounting hole of multiple stud terminals permits use with #6, #8, or #10 size studs
- Ring tongue design assures a secure connection in high vibration applications
- Insulation support helps to prevent wire damage in bending applications
- Brazed seam protects terminal barrel from splitting during the crimp process
- UL Flammability UL 94V-0, maximum insulation temperature 221°F (105°C)
- Internal barrel serrations assure good wire contact and maximum tensile strength
- UL and CSA rated up to 600 V per UL 486

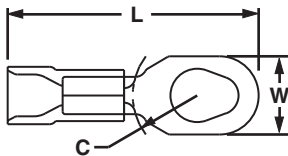

| Part Number | Wire Range | Color Code | Stock Thickness | Max. Ins. | Stud Size | Figure Dimensions (In.) | | | Recommended Installation Tool | Std. Pkg. Qty.** | Std. Ctn. Qty. |
|---------------------|-------------|------------|-----------------|-----------|-------------|-------------------------|-----|-----|---|------------------|----------------|
| | | | | | | L | W | C | | | |
| PV18-610R-CY | 22 – 18 AWG | Red | .03 | .150 | #6, #8, #10 | 1.00 | .31 | .25 | CT-100, CT-600-A‡, CT-1550‡, CT-1551‡, CT-2500‡ | 100 | 500 |
| PV14-610R-C | 16 – 14 AWG | Blue | .03 | .170 | | 1.00 | .31 | .25 | | 100 | 500 |
| PV10-610R-L | 12 – 10 AWG | Yellow | .04 | .225 | | 1.17 | .37 | .31 | | 50 | 500 |

**To order in bulk, replace -C or -CY in the part number with -M or -MY for a bulk package of 1000 and replace -L with -D for a bulk package of 500.

‡UL and CSA approved tooling/product combinations. For crimping tool information, see pages D1.83, D1.84, D1.86 and D1.88.



Ring Terminal, KYNAR® Insulated

Type PK-R

- For nuclear containment areas and high temperature to 300°F (150°C) applications
- Color code: natural with appropriate color stripe to identify wire range
- Ring tongue design assures a secure connection in high vibration applications
- Classified as Class 1E in accordance with IEEE 323-2003
- Metal insulation grip sleeve crimps to wire insulation, providing protection to the crimp joint during high vibration applications

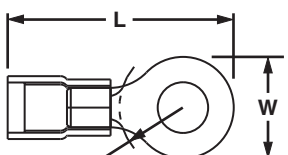

| Part Number | Wire Range | Color Code | Stock Thickness | Max. Ins. | Stud Size | Figure Dimensions (In.) | | | Recommended Installation Tool | Std. Pkg. Qty.** | Std. Ctn. Qty. |
|-------------------|-------------|---------------|-----------------|-----------|-----------|-------------------------|-----|-----|---|------------------|----------------|
| | | | | | | L | W | C | | | |
| PK18-4R-C | 22 – 18 AWG | Red Stripe | .03 | .145 | #4 | .81 | .25 | .22 | CT-100, CT-600-A‡, CT-1550‡, CT-1551‡, CT-2500‡ | 100 | 500 |
| PK18-6R-C | | | .03 | .145 | #6 | .81 | .25 | .22 | | 100 | 500 |
| PK18-8R-C | | | .03 | .145 | #8 | .90 | .31 | .29 | | 100 | 500 |
| PK18-10R-C | | | .03 | .145 | #10 | .90 | .31 | .29 | | 100 | 500 |
| PK14-4R-C | 16 – 14 AWG | Blue Stripe | .03 | .162 | #4 | .79 | .25 | .22 | CT-100, CT-600-A‡, CT-1550‡, CT-1551‡, CT-2500‡ | 100 | 500 |
| PK14-6R-C | | | .03 | .162 | #6 | .88 | .31 | .29 | | 100 | 500 |
| PK14-8R-C | | | .03 | .162 | #8 | .88 | .31 | .29 | | 100 | 500 |
| PK14-10R-C | | | .03 | .162 | #10 | .88 | .31 | .29 | | 100 | 500 |
| PK14-14R-C | | | .03 | .162 | 1/4" | 1.09 | .46 | .40 | | 100 | 500 |
| PK10-6R-L | 12 – 10 AWG | Yellow Stripe | .04 | .225 | #6 | 1.08 | .37 | .33 | CT-100, CT-600-A‡, CT-1550‡, CT-1551‡, CT-2500‡ | 50 | 500 |
| PK10-8R-L | | | .04 | .225 | #8 | 1.08 | .37 | .33 | | 50 | 500 |
| PK10-10R-L | | | .04 | .225 | #10 | 1.08 | .37 | .33 | | 50 | 500 |
| PK10-14R-L | | | .04 | .225 | 1/4" | 1.23 | .52 | .42 | | 50 | 500 |

*KYNAR is a registered trademark of Atofina Chemicals, Inc.

‡UL approved tooling/product combinations. For tooling information, see pages D1.83, D1.84, D1.86 and D1.88.

UL LISTED SF CERTIFIED Heat Shrink, Ring Terminal

Type PH-R

- Heat shrink polyolefin sleeve with hot melt adhesive protects against moisture
- Heat shrink sleeving forms a protective barrier to provide environmentally sealed terminations ideal for high moisture applications
- Ring tongue design assures a secure connection in high vibration applications
- Brazed seam protects terminal barrel from splitting during the crimp process
- Heat shrink installation is completed with a standard heat gun
- Minimum continuous operating temperature -65°F (-55°C)
- Maximum continuous operation temperature 230°F (110°C)
- Shrink temperature 250°F (120°C)

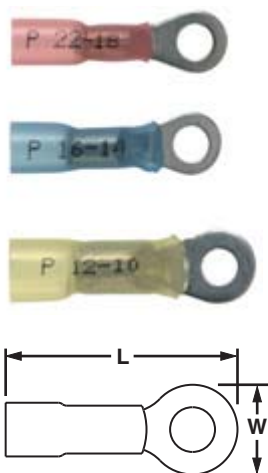

| Part Number | Wire Range | Color Code | Max. Ins. | Stud Size | Figure Dimensions (In.) | | | Wire Strip Length (In.) | Recommended Installation Tool | Std. Pkg. Qty. | Std. Ctn. Qty. |
|-------------|-------------|------------|-----------|-----------|-------------------------|-----|---|-------------------------|-------------------------------|----------------|----------------|
| | | | | | L | W | C | | | | |
| PH18-6R-Q | 22 – 18 AWG | Red | .170 | #6 | 1.05 | .25 | | 5/16 | CT-310 | 25 | 125 |
| PH18-8R-Q | | | .170 | #8 | 1.08 | .31 | | 5/16 | | 25 | 125 |
| PH18-10R-Q | | | .170 | #10 | 1.08 | .31 | | 5/16 | | 25 | 125 |
| PH18-14R-Q | | | .170 | 1/4" | 1.30 | .47 | | 5/16 | | 25 | 125 |
| PH14-6R-Q | 16 – 14 AWG | Blue | .190 | #6 | 1.06 | .31 | | 5/16 | CT-310 | 25 | 125 |
| PH14-8R-Q | | | .190 | #8 | 1.03 | .31 | | 5/16 | | 25 | 125 |
| PH14-10R-Q | | | .190 | #10 | 1.12 | .31 | | 5/16 | | 25 | 125 |
| PH14-14R-Q | | | .190 | 1/4" | 1.24 | .46 | | 5/16 | | 25 | 125 |
| PH14-56R-Q | | | .190 | 5/16" | 1.27 | .46 | | 5/16 | | 25 | 125 |
| PH14-38R-Q | | | .190 | 3/8" | 1.26 | .53 | | 5/16 | | 25 | 125 |
| PH10-8R-E | 12 – 10 AWG | Yellow | .240 | #8 | 1.22 | .37 | | 5/16 | CT-310 | 20 | 100 |
| PH10-10R-E | | | .240 | #10 | 1.20 | .37 | | 5/16 | | 20 | 100 |
| PH10-14R-E | | | .240 | 1/4" | 1.41 | .52 | | 5/16 | | 20 | 100 |
| PH10-38R-E | | | .240 | 3/8" | 1.45 | .59 | | 5/16 | | 20 | 100 |
| PH10-12R-E | | | .240 | 1/2" | 1.54 | .72 | | 5/16 | | 20 | 100 |

For crimping tool information, see page D1.85.

UL LISTED SF CERTIFIED Ring Terminal, Heavy Duty, Nylon Insulated

Type PN-HDR

- Manufactured from stock 56% thicker than a standard #16 – 14 AWG terminal for use in heavy-duty applications
- Insulation housing is marked with "HDR" to signify heavy-duty ring
- Metal insulation grip sleeve crimps to wire insulation, providing protection to the crimp joint during high vibration applications
- Internal barrel serrations assure good wire contact and maximum tensile strength
- UL Flammability UL 94V-2/HB, maximum insulation temperature 221°F (105°C)
- UL and CSA rated up to 600 V per UL 486



| Part Number | Wire Range | Color Code | Stock Thickness | Max. Ins. | Stud Size | Figure Dimensions (In.) | | | Recommended Installation Tool | Std. Pkg. Qty.** | Std. Ctn. Qty. |
|--------------|-------------|------------|-----------------|-----------|-----------|-------------------------|-----|-----|----------------------------------|------------------|----------------|
| | | | | | | L | W | C | | | |
| PN12-8HDR-L | 16 – 12 AWG | Yellow | .05 | .225 | #8 | 1.06 | .31 | .35 | CT-1550‡ CT-1551‡ CT-2500‡ | 50 | 500 |
| PN12-10HDR-L | | | .05 | .225 | #10 | 1.09 | .37 | .33 | | 50 | 500 |
| PN12-14HDR-L | | | .05 | .225 | 1/4" | 1.24 | .52 | .42 | | 50 | 500 |
| PN12-56HDR-L | | | .05 | .225 | 5/16" | 1.24 | .52 | .42 | | 50 | 500 |
| PN12-38HDR-L | | | .05 | .225 | 3/8" | 1.30 | .58 | .46 | | 50 | 500 |

**To order in bulk, replace -L with -D for a bulk package of 500.

‡UL and CSA approved tooling/product combinations. For crimping tool information, see pages D1.84 and D1.88.

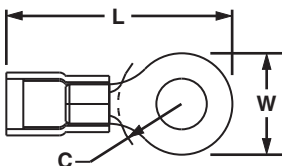

A. System Overview

B1. Cable Ties

B2. Cable Accessories

B3. Stainless Steel Ties

C1. Wiring Duct

C2. Surface Raceway

C3. Abrasion Protection

C4. Cable Management

D1. Terminals

D2. Power Connectors

D3. Grounding Connectors

E1. Labeling Systems

E2. Labels

E3. Pre-Printed & Write-On Markers

E4. Permanent Identification

E5. Lockout/Tagout & Safety Solutions

F. Index

A. System Overview

B1. Cable Ties

B2. Cable Accessories

B3. Stainless Steel Ties

C1. Wiring Duct

C2. Surface Raceway

C3. Abrasion Protection

C4. Cable Management

D1. Terminals

D2. Power Connectors

D3. Grounding Connectors

E1. Labeling Systems

E2. Labels

E3. Pre-Printed & Write-On Markers

E4. Permanent Identification

E5. Lockout/Tagout & Safety Solutions

F. Index



Ring Terminal, Heavy Duty, Vinyl Insulated – Funnel Entry

Type PV-HDR

- Manufactured from stock 56% thicker than a standard #16 – 14 AWG terminal for use in heavy-duty applications
- Insulation housing is marked with “HDR” to signify heavy-duty ring
- Insulation support helps to prevent wire damage in bending applications
- Brazed seam protects terminal barrel from splitting during the crimp process
- UL Flammability UL 94V-0, maximum insulation temperature 221°F (105°C)
- Internal barrel serrations assure good wire contact and maximum tensile strength
- UL and CSA rated up to 600 V per UL 486

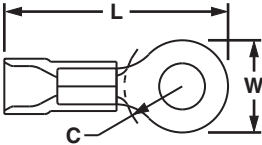

| Part Number | Wire Range | Color Code | Stock Thickness | Max. Ins. | Stud Size | Figure Dimensions (In.) | | | Recommended Installation Tool | Std. Pkg. Qty.** | Std. Ctn. Qty. |
|-----------------------------|-------------|------------|-----------------|-----------|-----------|-------------------------|-----|-----|---|------------------|----------------|
| | | | | | | L | W | C | | | |
| Standard Insulation | | | | | | | | | | | |
| PV12-6HDR-L | 16 – 12 AWG | Yellow | .05 | .225 | #6 | 1.05 | .31 | .35 | CT-600-A‡, CT-1550‡, CT-1551‡, CT-2500‡ | 50 | 500 |
| PV12-8HDR-L | | | .05 | .225 | #8 | 1.05 | .31 | .35 | | 50 | 500 |
| PV12-10HDR-L | | | .05 | .225 | #10 | 1.08 | .37 | .33 | | 50 | 500 |
| PV12-14HDR-L | | | .05 | .225 | 1/4" | 1.23 | .52 | .42 | | 50 | 500 |
| PV12-56HDR-L | | | .05 | .225 | 5/16" | 1.23 | .52 | .42 | | 50 | 500 |
| PV12-38HDR-L | | | .05 | .225 | 3/8" | 1.31 | .58 | .46 | | 50 | 500 |
| Expanded Insulation* | | | | | | | | | | | |
| PV12-6HDRX-L | 16 – 12 AWG | Yellow | .05 | .250 | #6 | 1.05 | .31 | .35 | CT-600-A‡, CT-1550‡, CT-1551‡, CT-2500‡ | 50 | 500 |
| PV12-8HDRX-L | | | .05 | .250 | #8 | 1.05 | .31 | .35 | | 50 | 500 |
| PV12-10HDRX-L | | | .05 | .250 | #10 | 1.08 | .37 | .33 | | 50 | 500 |
| PV12-14HDRX-L | | | .05 | .250 | 1/4" | 1.23 | .52 | .42 | | 50 | 500 |
| PV12-56HDRX-L | | | .05 | .250 | 5/16" | 1.23 | .52 | .42 | | 50 | 500 |
| PV12-38HDRX-L | | | .05 | .250 | 3/8" | 1.31 | .58 | .46 | | 50 | 500 |

*Expanded insulation parts do not have funnel entry.

**To order in bulk, replace -L with -D for a bulk package of 500.

‡UL and CSA approved tooling/product combinations. For tooling information, see pages D1.84, D1.86, and D1.88.



Ring Terminal, Large Wire, Vinyl Insulated

Type PV-R

- Insulation support helps to prevent wire damage in bending applications
- Brazed seam protects terminal barrel from splitting during the crimp process
- UL Flammability UL 94V-0, maximum insulation temperature 221°F (105°C)
- Internal barrel serrations assure good wire contact and maximum tensile strength
- UL and CSA rated up to 600 V per UL 486

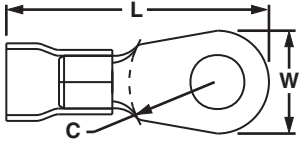

| Part Number | Wire Range | Color Code | Stock Thickness | Max. Ins. | Stud Size | Figure Dimensions (In.) | | | Recommended Installation Tool | Std. Pkg. Qty.** | Std. Ctn. Qty. |
|-------------|------------|------------|-----------------|-----------|-----------|-------------------------|-----|-----|-------------------------------|------------------|----------------|
| | | | | | | L | W | C | | | |
| PV8-8R-QY | 8 AWG | Red | .04 | .280 | #8 | 1.51 | .42 | .43 | CT-720, CD-720PV8-2‡ | 25 | 250 |
| PV8-10R-QY | | | .04 | .280 | #10 | 1.53 | .47 | .43 | | 25 | 250 |
| PV8-14R-QY | | | .04 | .280 | 1/4" | 1.53 | .47 | .43 | | 25 | 250 |
| PV8-56R-QY | | | .04 | .280 | 5/16" | 1.64 | .59 | .49 | | 25 | 250 |
| PV8-38R-QY | | | .04 | .280 | 3/8" | 1.64 | .59 | .51 | | 25 | 250 |
| PV8-12R-QY | | | .04 | .280 | 1/2" | 1.74 | .82 | .51 | | 25 | 250 |
| PV6-8R-E | 6 AWG | Blue | .05 | .340 | #8 | 1.61 | .47 | .43 | CT-720, CD-720PV8-2‡ | 20 | 200 |
| PV6-10R-E | | | .05 | .340 | #10 | 1.62 | .47 | .43 | | 20 | 200 |
| PV6-14R-E | | | .05 | .340 | 1/4" | 1.65 | .47 | .48 | | 20 | 200 |
| PV6-56R-E | | | .05 | .340 | 5/16" | 1.74 | .62 | .53 | | 20 | 200 |
| PV6-38R-E | | | .05 | .340 | 3/8" | 1.74 | .62 | .51 | | 20 | 200 |
| PV6-12R-E | | | .05 | .340 | 1/2" | 1.84 | .82 | .51 | | 20 | 200 |
| PV4-10R-E | 4 AWG | Yellow | .05 | .450 | #10 | 1.88 | .55 | .50 | CT-720, CD-720PV8-2‡ | 20 | 200 |
| PV4-14R-E | | | .05 | .450 | 1/4" | 1.88 | .55 | .50 | | 20 | 200 |
| PV4-56R-E | | | .05 | .450 | 5/16" | 1.95 | .68 | .50 | | 20 | 200 |
| PV4-38R-E | | | .05 | .450 | 3/8" | 1.95 | .68 | .50 | | 20 | 200 |
| PV4-12R-E | | | .05 | .450 | 1/2" | 2.04 | .86 | .50 | | 20 | 200 |
| PV2-10R-XY | 2 AWG | Red | .06 | .560 | #10 | 1.96 | .68 | .58 | CT-720, CD-720PV8-2‡ | 10 | 100 |
| PV2-14R-XY | | | .06 | .560 | 1/4" | 1.96 | .68 | .58 | | 10 | 100 |
| PV2-56R-XY | | | .06 | .560 | 5/16" | 1.96 | .68 | .58 | | 10 | 100 |
| PV2-38R-XY | | | .06 | .560 | 3/8" | 1.96 | .68 | .58 | | 10 | 100 |
| PV2-12R-XY | | | .06 | .560 | 1/2" | 2.05 | .86 | .58 | | 10 | 100 |

**To order in bulk, replace -QY, -E, or -XY in the part number with -T or -TY for a bulk package of 200.
‡UL approved tooling/product combinations. For crimping tool information, see page D1.87.

A. System Overview

B1. Cable Ties

B2. Cable Accessories

B3. Stainless Steel Ties

C1. Wiring Duct

C2. Surface Raceway

C3. Abrasion Protection

C4. Cable Management

D1. Terminals

D2. Power Connectors

D3. Grounding Connectors

E1. Labeling Systems

E2. Labels

E3. Pre-Printed & Write-On Markers

E4. Permanent Identification

E5. Lockout/Tagout & Safety Solutions

F. Index

A. System Overview

B1. Cable Ties



Ring Terminal, Large Wire, Vinyl Expanded Insulation

Type PV-RX

- Expanded wire entry designed to accommodate wire with a larger insulation thickness
- Insulation support helps to prevent wire damage in bending applications
- Brazed seam protects terminal barrel from splitting during the crimp process
- UL Flammability UL 94V-0, maximum insulation temperature 221 °F (105°C)
- Internal barrel serrations assure good wire contact and maximum tensile strength
- UL rated up to 600 V per UL 486

B2. Cable Accessories

B3. Stainless Steel Ties



C1. Wiring Duct

C2. Surface Raceway

C3. Abrasion Protection

C4. Cable Management

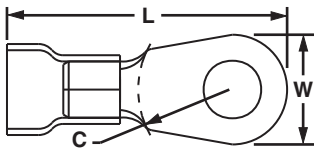

D1. Terminals

D2. Power Connectors

D3. Grounding Connectors

E1. Labeling Systems

E2. Labels

E3. Pre-Printed & Write-On Markers

E4. Permanent Identification

E5. Lockout/Tagout & Safety Solutions

F. Index

| Part Number | Wire Range | Color Code | Stock Thickness | Max. Ins. | Stud Size | Figure Dimensions (In.) | | | Recommended Installation Tool | Std. Pkg. Qty.** | Std. Ctn. Qty. |
|-------------|------------|------------|-----------------|-----------|-----------|-------------------------|-----|-----|-------------------------------|------------------|----------------|
| | | | | | | L | W | C | | | |
| PV8-8RX-QY | 8 AWG | Red | .04 | .360 | #8 | 1.50 | .42 | .43 | CT-720, CD-720PV8-2‡ | 25 | 250 |
| PV8-10RX-QY | | | .04 | .360 | #10 | 1.52 | .47 | .43 | | | |
| PV8-14RX-QY | | | .04 | .360 | 1/4" | 1.52 | .47 | .43 | | | |
| PV8-56RX-QY | | | .04 | .360 | 5/16" | 1.62 | .59 | .51 | | | |
| PV8-38RX-QY | | | .04 | .360 | 3/8" | 1.62 | .59 | .51 | | | |
| PV8-12RX-QY | | | .04 | .360 | 1/2" | 1.74 | .82 | .51 | | | |
| PV6-8RX-E | 6 AWG | Blue | .05 | .436 | #8 | 1.61 | .47 | .43 | CT-720, CD-720PV8-2‡ | 20 | 200 |
| PV6-10RX-E | | | .05 | .436 | #10 | 1.61 | .47 | .43 | | | |
| PV6-14RX-E | | | .05 | .436 | 1/4" | 1.61 | .47 | .43 | | | |
| PV6-56RX-E | | | .05 | .436 | 5/16" | 1.73 | .62 | .51 | | | |
| PV6-38RX-E | | | .05 | .436 | 3/8" | 1.73 | .62 | .53 | | | |
| PV6-12RX-E | | | .05 | .436 | 1/2" | 1.83 | .82 | .53 | | | |
| PV4-10RX-E | 4 AWG | Yellow | .05 | .515 | #10 | 1.87 | .55 | .53 | CT-720, CD-720PV8-2‡ | 20 | 200 |
| PV4-14RX-E | | | .05 | .515 | 1/4" | 1.87 | .55 | .53 | | | |
| PV4-56RX-E | | | .05 | .515 | 5/16" | 1.94 | .68 | .53 | | | |
| PV4-38RX-E | | | .05 | .515 | 3/8" | 1.94 | .68 | .53 | | | |
| PV4-12RX-E | | | .05 | .515 | 1/2" | 2.03 | .86 | .53 | | 20 | 200 |
| PV2-10RX-XY | 2 AWG | Red | .06 | .632 | #10 | 1.94 | .68 | .58 | CT-720, CD-720PV8-2‡ | 10 | 100 |
| PV2-14RX-XY | | | .06 | .632 | 1/4" | 1.94 | .68 | .58 | | | |
| PV2-56RX-XY | | | .06 | .632 | 5/16" | 1.94 | .68 | .58 | | | |
| PV2-38RX-XY | | | .06 | .632 | 3/8" | 1.94 | .68 | .58 | | | |
| PV2-12RX-XY | | | .06 | .632 | 1/2" | 2.03 | .86 | .58 | | | |

**To order in bulk, replace -QY, -E, or -XY in the part number with -T or -TY for a bulk package of 200.
‡UL approved tooling/product combinations. For crimping tool information, see pages D1.87 and D3.37.

UL LISTED **CSA CERTIFIED** **Ring Terminal, Non-Insulated**

Type P-R

- Ring tongue design assures a secure connection in high vibration applications
- Internal barrel serrations assure good wire contact and maximum tensile strength
- Brazed seam protects terminal barrel from splitting during the crimp process

- Barrel of terminal internally beveled to provide quick and easy wire insertion
- UL and CSA rated up to 2000 V per UL 486
- Maximum recommended operating temperature 302°F (150°C)

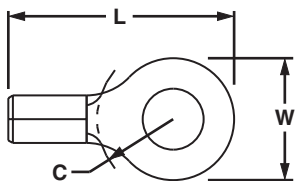

| Part Number | Wire Range | Stock Thickness | Stud Size | Figure Dimensions (In.) | | | Recommended Installation Tool | Std. Pkg. Qty.** | Std. Ctn. Qty. | | |
|-------------------|-------------|-----------------|-----------|-------------------------|-----|-----|---|---|---|-----|------|
| | | | | L | W | C | | | | | |
| P22-2R-C* | 26 – 22 AWG | .02 | #2 | .52 | .20 | .16 | CT-100, CT-200 | 100 | 1000 | | |
| P22-4R-C* | | .02 | #4 | .52 | .20 | .16 | | 100 | 1000 | | |
| P22-6R-C* | | .02 | #6 | .52 | .20 | .16 | | 100 | 1000 | | |
| P22-8R-C* | | .02 | #8 | .63 | .26 | .25 | | 100 | 1000 | | |
| P22-10R-C* | | .02 | #10 | .63 | .31 | .22 | | 100 | 1000 | | |
| P18-4R-C | 22 – 16 AWG | .03 | #4 | .62 | .25 | .21 | CT-100‡, CT-200‡, CT-600-A‡, CT-1570‡, CT-2500‡ | 100 | 1000 | | |
| P18-6RN-C | | .03 | #6 | .60 | .22 | .19 | | 100 | 1000 | | |
| P18-6R-C | | .03 | #6 | .62 | .25 | .21 | | 100 | 1000 | | |
| P18-8R-C | | .03 | #8 | .71 | .31 | .25 | | 100 | 1000 | | |
| P18-10R-C | | .03 | #10 | .71 | .31 | .25 | | 100 | 1000 | | |
| P18-14R-C | | .03 | 1/4" | .91 | .46 | .38 | | 100 | 1000 | | |
| P18-56R-C | | .03 | 5/16" | .91 | .46 | .38 | | 100 | 1000 | | |
| P18-38R-C | | .03 | 3/8" | 1.0 | .53 | .43 | | 100 | 1000 | | |
| P18-12R-C | | .03 | 1/2" | 1.20 | .72 | .53 | | 100 | 1000 | | |
| P14-4R-C | | 18 – 14 AWG | .03 | #4 | .62 | .25 | | .20 | CT-100‡, CT-200‡, CT-600-A‡, CT-1570‡, CT-2500‡ | 100 | 1000 |
| P14-6R-C | .03 | | #6 | .62 | .25 | .20 | 100 | 1000 | | | |
| P14-8R-C | .03 | | #8 | .71 | .31 | .25 | 100 | 1000 | | | |
| P14-10R-C | .03 | | #10 | .71 | .31 | .25 | 100 | 1000 | | | |
| P14-14R-C | .03 | | 1/4" | .91 | .46 | .38 | 100 | 1000 | | | |
| P14-56R-C | .03 | | 5/16" | .91 | .46 | .38 | 100 | 1000 | | | |
| P14-38R-C | .03 | | 3/8" | 1.0 | .53 | .43 | 100 | 1000 | | | |
| P14-12R-L | .03 | | 1/2" | 1.20 | .72 | .53 | 50 | 500 | | | |
| P10-6R-L^ | 14 – 10 AWG | | .04 | #6 | .78 | .31 | .31 | CT-100‡, CT-200‡, CT-600-A‡, CT-1570‡, CT-1701‡, CT-2500‡ | | 50 | 500 |
| P10-8R-L | | | .04 | #8 | .78 | .31 | .31 | | | 50 | 500 |
| P10-10R-L^ | | .04 | #10 | .81 | .38 | .31 | 50 | | 500 | | |
| P10-14R-L | | .04 | 1/4" | .96 | .52 | .38 | 50 | | 500 | | |
| P10-56R-L^ | | .04 | 5/16" | .95 | .52 | .38 | 50 | | 500 | | |
| P10-38R-L^ | | .04 | 3/8" | 1.05 | .58 | .44 | 50 | | 500 | | |
| P10-12R-L | | .04 | 1/2" | 1.20 | .72 | .53 | 50 | | 500 | | |

*Wire sizes #26 – 22 AWG are not UL Listed or CSA Certified.

**To order in bulk, replace -C in the part number with -M for a bulk package of 1000 and replace -L with -D for a bulk package of 500.

^For military specification cross reference see page D1.95.

‡UL and CSA approved tooling/product combinations. For crimping tool information, see pages D1.83, D1.84, D1.86 and D1.88.

A. System Overview

B1. Cable Ties

B2. Cable Accessories

B3. Stainless Steel Ties

C1. Wiring Duct

C2. Surface Raceway

C3. Abrasion Protection

C4. Cable Management

D1. Terminals

D2. Power Connectors

D3. Grounding Connectors

E1. Labeling Systems

E2. Labels

E3. Pre-Printed & Write-On Markers

E4. Permanent Identification

E5. Lockout/Tagout & Safety Solutions

F. Index

A. System Overview



Multiple Stud Terminal, Non-Insulated

B1. Cable Ties

Type P-610R

- Teardrop shaped mounting hole of multiple stud terminals permits use with #6, #8, or #10 size studs
- UL and CSA rated up to 2000 V per UL 486
- Maximum recommended operating temperature 302°F (150°C)
- Internal barrel serrations assure good wire contact and maximum tensile strength
- Brazed seam protects terminal barrel from splitting during the crimp process
- Barrel of terminal internally beveled to provide quick and easy wire insertion
- Internal barrel serrations assure good wire contact and maximum tensile strength
- Brazed seam protects terminal barrel from splitting during the crimp process
- UL and CSA rated up to 2000 V per UL 486A
- Maximum recommended operating temperature 302°F (150°C)
- Teardrop shaped mounting hole of multiple stud terminals permits use with #6, #8, or #10 size studs

B2. Cable Accessories

B3. Stainless Steel Ties

C1. Wiring Duct

C2. Surface Raceway

C3. Abrasion Protection

C4. Cable Management



| Part Number | Wire Range | Stock Thickness | Stud Size | Figure Dimensions (In.) | | | Recommended Installation Tool | Std. Pkg. Qty.** | Std. Ctn. Qty. |
|-------------|-------------|-----------------|-------------|-------------------------|-----|-----|---|------------------|----------------|
| | | | | L | W | C | | | |
| P18-610R-C | 22 – 16 AWG | .03 | #6, #8, #10 | .80 | .31 | .25 | CT-100‡, CT-200‡, CT-600-A‡, CT-1570‡, CT-1701‡, CT-2500‡ | 100 | 500 |
| P14-610R-C | 18 – 14 AWG | .03 | | .80 | .31 | .25 | | | |
| P10-610R-L | 14 – 10 AWG | .04 | | .90 | .37 | .31 | | 50 | 500 |

**To order in bulk, replace -C in the part number with -M for a bulk package of 1000 and replace -L with -D for a bulk package of 500.
‡UL and CSA approved tooling/product combinations. For tooling information, see pages D1.83, D1.84, D1.86 and D1.88.

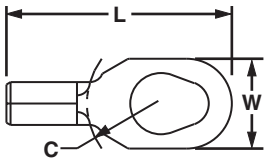

D1. Terminals

D2. Power Connectors

D3. Grounding Connectors

Ring Terminal, Non-Insulated – High Temperature

Type P-RHT

- Nickel plated copper for temperatures up to 650°F (343°C)
- Internal barrel serrations assure good wire contact and maximum tensile strength
- Brazed seam protects terminal barrel from splitting during the crimp process
- Barrel of terminal internally beveled to provide quick and easy wire insertion

E1. Labeling Systems

E2. Labels

E3. Pre-Printed & Write-On Markers

E4. Permanent Identification

E5. Lockout/Tagout & Safety Solutions

F. Index



| Part Number | Wire Range | Stock Thickness | Stud Size | Figure Dimensions (In.) | | | Recommended Installation Tool | Std. Pkg. Qty.** | Std. Ctn. Qty. |
|--------------|-------------|-----------------|-----------|-------------------------|-----|-----|---|------------------|----------------|
| | | | | L | W | C | | | |
| P18-6RHT6-C | 22 – 16 AWG | .03 | #6 | .62 | .25 | .21 | CT-100, CT-200, CT-600-A, CT-1570, CT-2500 | 100 | 1000 |
| P18-8RHT6-C | | .03 | #8 | .71 | .31 | .25 | | | |
| P18-10RHT6-C | | .03 | #10 | .71 | .31 | .25 | | 100 | 1000 |
| P14-6RHT6-C | 18 – 14 AWG | .03 | #6 | .62 | .25 | .20 | CT-100, CT-200, CT-600-A, CT-1570, CT-2500 | 100 | 1000 |
| P14-8RHT6-C | | .03 | #8 | .71 | .31 | .25 | | | |
| P14-10RHT6-C | | .03 | #10 | .71 | .31 | .25 | | 100 | 1000 |
| P10-6RHT6-L | 12 – 10 AWG | .04 | #6 | .78 | .31 | .35 | CT-100, CT-200, CT-600-A, CT-1570, CT-1701, CT-2500 | 50 | 500 |
| P10-8RHT6-L | | .04 | #8 | .78 | .31 | .35 | | | |
| P10-10RHT6-L | | .04 | #10 | .81 | .38 | .33 | | 50 | 500 |
| P10-14RHT6-L | | .04 | 1/4" | .96 | .53 | .42 | | 50 | 500 |

**To order in bulk, replace -C in the part number with -M for a bulk package of 1000 and replace -L with -D for a bulk package of 500.
For crimping tool information, see pages D1.83, D1.84, D1.86 and D1.88.

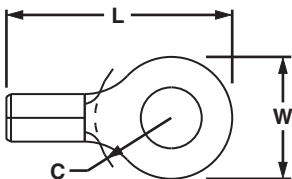

UL LISTED CERTIFIED Ring Terminal, Heavy Duty Non-Insulated

Type P-HDR

- Manufactured from stock 56% thicker than a standard #16 – 14 AWG terminal for use in heavy-duty applications
- Internal barrel serrations assure good wire contact and maximum tensile strength
- Brazed seam protects terminal barrel from splitting during the crimp process
- Barrel of terminal internally beveled to provide quick and easy wire insertion
- UL and CSA rated up to 2000 V per UL 486
- Maximum recommended operating temperature 302°F (150°C)

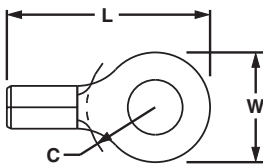

| Part Number | Wire Range | Stock Thickness | Stud Size | Figure Dimensions (In.) | | | Recommended Installation Tool | Std. Pkg. Qty.** | Std. Ctn. Qty. |
|-------------|-------------|-----------------|-----------|-------------------------|-----|-----|------------------------------------|------------------|----------------|
| | | | | L | W | C | | | |
| P12-6HDR-L | 16 – 12 AWG | .05 | #6 | .78 | .31 | .36 | CT-100, CT-200, CT-1570‡, CT-2500‡ | 50 | 500 |
| P12-8HDR-L | | .05 | #8 | .78 | .31 | .36 | | 50 | 500 |
| P12-10HDR-L | | .05 | #10 | .81 | .37 | .36 | | 50 | 500 |
| P12-14HDR-L | | .05 | 1/4" | .96 | .52 | .43 | | 50 | 500 |
| P12-56HDR-L | | .05 | 5/16" | .96 | .52 | .43 | | 50 | 500 |
| P12-38HDR-L | | .05 | 3/8" | 1.04 | .58 | .48 | | 50 | 500 |

**To order in bulk, replace -L with -D for a bulk package of 500.

‡UL and CSA approved tooling/product combinations. For crimping tool information, see pages D1.83, D1.84, and D1.88.

UL LISTED CERTIFIED Ring Terminal, Large Wire Non-Insulated

Type P-R

- Designed for use with #8 – 2 AWG copper wire
- Ring tongue design assures a secure connection in high vibration applications
- Internal barrel serrations assure good wire contact and maximum tensile strength
- Brazed seam protects terminal barrel from splitting during the crimp process
- Barrel of terminal internally beveled to provide quick and easy wire insertion
- Maximum recommended operating temperature 302°F (150°C)

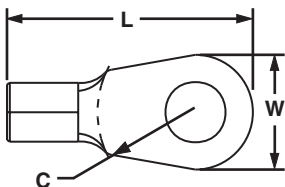

| Part Number | Wire Range | Stock Thickness | Stud Size | Figure Dimensions (In.) | | | Recommended Installation Tool | Std. Pkg. Qty.** | Std. Ctn. Qty. |
|-------------|------------|-----------------|-----------|-------------------------|------|-----|-------------------------------|------------------|----------------|
| | | | | L | W | C | | | |
| P8-8R-Q | 8 AWG | .04 | #8 | 1.12 | .42 | .43 | CT-1701‡ | 25 | 250 |
| P8-10R-Q | | .04 | #10 | 1.14 | .47 | .43 | | 25 | 250 |
| P8-14R-Q | | .04 | 1/4" | 1.14 | .47 | .43 | | 25 | 250 |
| P8-56R-Q | | .04 | 5/16" | 1.25 | .59 | .51 | | 25 | 250 |
| P8-38R-Q | | .04 | 3/8" | 1.25 | .59 | .51 | | 25 | 250 |
| P8-12R-Q | | .04 | 1/2" | 1.36 | .82 | .54 | | 25 | 250 |
| P6-8R-E | 6 AWG | .05 | #8 | 1.21 | .47 | .43 | CT-1701‡ | 20 | 200 |
| P6-10R-E | | .05 | #10 | 1.21 | .47 | .43 | | 20 | 200 |
| P6-14R-E | | .05 | 1/4" | 1.21 | .47 | .43 | | 20 | 200 |
| P6-56R-E | | .05 | 5/16" | 1.33 | .62 | .51 | | 20 | 200 |
| P6-38R-E | | .05 | 3/8" | 1.33 | .62 | .51 | | 20 | 200 |
| P6-12R-E | | .05 | 1/2" | 1.43 | .82 | .51 | | 20 | 200 |
| P4-10R-E | 4 AWG | .05 | #10 | 1.40 | .55 | .50 | CT-1701‡ | 20 | 200 |
| P4-14R-E | | .05 | 1/4" | 1.40 | .55 | .50 | | 20 | 200 |
| P4-56R-E | | .05 | 5/16" | 1.46 | .68 | .50 | | 20 | 200 |
| P4-38R-E | | .05 | 3/8" | 1.46 | .68 | .50 | | 20 | 200 |
| P4-12R-E | | .05 | 1/2" | 1.55 | .86 | .53 | | 20 | 200 |
| P2-10R-X | | 2 AWG | .06 | #10 | 1.46 | .68 | | .58 | CT-1701‡ |
| P2-14R-X | .06 | | 1/4" | 1.46 | .68 | .58 | 10 | 100 | |
| P2-56R-X | .06 | | 5/16" | 1.46 | .68 | .58 | 10 | 100 | |
| P2-38R-X | .06 | | 3/8" | 1.46 | .68 | .58 | 10 | 100 | |
| P2-12R-X* | .06 | | 1/2" | 1.55 | .86 | .58 | 10 | 100 | |

*Not CSA Certified.

**To order in bulk, replace -Q, -E, or -X in the part number with -T for a bulk package of 200.

‡UL and CSA approved tooling/product combinations. For crimping tool information, see page D1.84.

A. System Overview

B1. Cable Ties

B2. Cable Accessories

B3. Stainless Steel Ties

C1. Wiring Duct

C2. Surface Raceway

C3. Abrasion Protection

C4. Cable Management

D1. Terminals

D2. Power Connectors

D3. Grounding Connectors

E1. Labeling Systems

E2. Labels

E3. Pre-Printed & Write-On Markers

E4. Permanent Identification

E5. Lockout/Tagout & Safety Solutions

F. Index

A. System Overview

B1. Cable Ties



Tubular Ring Terminal, Non-Insulated

Type S-R

- Seamless tubular barrel provides a consistent high performance quality crimp
- Round double thick tongue for reliable power applications
- Barrel of terminal internally beveled to provide quick and easy wire insertion
- Inspection window allows visual inspection of proper wire insertion
- UL and CSA rated up to 2000 V per UL 486A
- Maximum recommended operating temperature 302°F (150°C)

B3. Stainless Steel Ties



C1. Wiring Duct

C2. Surface Raceway

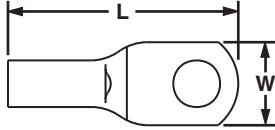

C3. Abrasion Protection

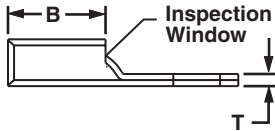

C4. Cable Management

D1. Terminals

| Min. Tensile Strength of Tubular Ring Terminals | | | |
|---|-----|-----|-----|
| #8 | #6 | #4 | #2 |
| 90 | 100 | 140 | 180 |

D2. Power Connectors

D3. Grounding Connectors

E1. Labeling Systems

E2. Labels

E3. Pre-Printed & Write-On Markers

E4. Permanent Identification

E5. Lockout/Tagout & Safety Solutions

F. Index

| Part Number | Wire Range | Stud Hole Size | Tongue Width W | Figure Dimensions (In.) | | | Recommended Installation Tool | Std. Pkg. Qty.* | Std. Ctn. Qty. |
|-------------------|------------|----------------|-------------------|-------------------------|------|-----|---|-----------------|----------------|
| | | | | L | B | T | | | |
| S8-10R-Q | 8 AWG | #10 | .41 | 1.10 | .40 | .08 | CT-1700, CT-720, CT-930, CT-930CH, CT-940CH, CT-2001, CT-2002, CT-2931, CT-2940 | 25 | 250 |
| S8-14R-Q | | 1/4" | .48 | 1.20 | .40 | .07 | | 25 | 250 |
| S8-56R-Q | | 5/16" | .60 | 1.30 | .40 | .05 | | 25 | 250 |
| S8-38R-Q | | 3/8" | .60 | 1.40 | .40 | .05 | | 25 | 250 |
| S6-10R-E | 6 AWG | #10 | .45 | 1.20 | .48 | .09 | | 20 | 200 |
| S6-14R-E | | 1/4" | .48 | 1.30 | .48 | .08 | | 20 | 200 |
| S6-56R-E | | 5/16" | .56 | 1.40 | .48 | .07 | | 20 | 200 |
| S6-38R-E | 4 AWG | 3/8" | .62 | 1.50 | .48 | .06 | | 20 | 200 |
| S4-10R-E | | #10 | .55 | 1.20 | .48 | .09 | | 20 | 200 |
| S4-14R-E | | 1/4" | .55 | 1.30 | .48 | .09 | | 20 | 200 |
| S4-56R-E | | 5/16" | .55 | 1.40 | .48 | .09 | | 20 | 200 |
| S4-38R-E | 1 - 2 AWG | 3/8" | .62 | 1.50 | .48 | .07 | | 20 | 200 |
| S2-10R-X | | #10 | .70 | 1.60 | .59 | .11 | 10 | 100 | |
| S2-14R-X | | 1/4" | .70 | 1.60 | .59 | .11 | 10 | 100 | |
| S2-56R-X | | 5/16" | .70 | 1.70 | .59 | .11 | 10 | 100 | |
| S2-38R-X | | 3/8" | .70 | 1.70 | .59 | .11 | 10 | 100 | |
| S2-12R-X | 1/0 AWG | 1/2" | .79 | 1.90 | .59 | .09 | 10 | 100 | |
| S1/0-14R-X | | 1/4" | .76 | 1.60 | .58 | .12 | 10 | 100 | |
| S1/0-56R-X | | 5/16" | .76 | 1.70 | .58 | .12 | 10 | 100 | |
| S1/0-38R-X | | 3/8" | .76 | 1.70 | .58 | .12 | 10 | 100 | |
| S1/0-12R-X | | 1/2" | .82 | 1.90 | .58 | .12 | 10 | 100 | |
| S2/0-14R-X | | 2/0 AWG | 1/4" | .85 | 1.90 | .66 | .13 | 10 | 100 |
| S2/0-56R-X | 5/16" | | .85 | 1.90 | .66 | .13 | 10 | 100 | |
| S2/0-38R-X | 3/8" | | .85 | 1.90 | .66 | .13 | 10 | 100 | |
| S2/0-76R-X | 7/16" | | .85 | 2.10 | .66 | .13 | 10 | 100 | |
| S2/0-12R-X | 1/2" | | .85 | 2.10 | .66 | .13 | 10 | 100 | |
| S3/0-14R-5 | 3/0 AWG | 1/4" | .96 | 2.10 | .83 | .13 | CT-720, CT-930, CT-930CH, CT-940CH, CT-2001, CT-2002, CT-980, CT-2980, CT-980CH, CT-2931, CT-2940 | 5 | 50 |
| S3/0-56R-5 | | 5/16" | .96 | 2.10 | .83 | .13 | | 5 | 50 |
| S3/0-38R-5 | | 3/8" | .96 | 2.10 | .83 | .13 | | 5 | 50 |
| S3/0-76R-5 | | 7/16" | .96 | 2.30 | .83 | .13 | | 5 | 50 |
| S3/0-12R-5 | 4/0 AWG | 1/2" | .96 | 2.30 | .83 | .13 | | 5 | 50 |
| S4/0-56R-5 | | 5/16" | 1.06 | 2.30 | .91 | .14 | | 5 | 50 |
| S4/0-38R-5 | | 3/8" | 1.06 | 2.30 | .91 | .14 | | 5 | 50 |
| S4/0-76R-5 | | 7/16" | 1.06 | 2.50 | .91 | .14 | | 5 | 50 |
| S4/0-12R-5 | | 1/2" | 1.06 | 2.50 | .91 | .14 | | 5 | 50 |
| S250-56R-5 | 250 kcmil | 5/16" | 1.17 | 2.50 | 1.01 | .14 | | 5 | 50 |
| S250-38R-5 | | 3/8" | 1.17 | 2.50 | 1.01 | .14 | 5 | 50 | |
| S250-76R-5 | | 7/16" | 1.17 | 2.60 | 1.01 | .14 | 5 | 50 | |
| S250-12R-5 | | 1/2" | 1.17 | 2.60 | 1.01 | .14 | 5 | 50 | |

For crimping tool information, see pages D1.84, D1.87, and D3.37 through D3.46.
*Contact PANDUIT Customer Service for bulk packaging.



Fork Terminal, Nylon Insulated

Type PN-F

- Fork design provides for fast and easy installation, without the need to remove fastener
- Metal insulation grip sleeve crimps to wire insulation, providing protection to the crimp joint during high vibration applications
- Internal barrel serrations assure good wire contact and maximum tensile strength
- UL Flammability UL 94V-2/HB, maximum insulation temperature 221°F (105°C)
- UL and CSA rated up to 600 V per UL 486



| Part Number | Wire Range | Color Code | Stock Thickness | Max. Ins. | Stud Size | Figure Dimensions (In.) | | | Recommended Installation Tool | Std. Pkg. Qty.** | Std. Ctn. Qty. |
|-------------|-------------|------------|-----------------|-----------|-----------|-------------------------|-----|------|--|------------------|--|
| | | | | | | L | W | C | | | |
| PN22-2F-C* | 26 – 22 AWG | Yellow | .02 | .090 | #2 | .66 | .20 | .19 | CT-100, CT-600-A, CT-1525, CT-2500 | 100 | 1000 |
| PN22-4F-C* | | | .02 | .090 | #4 | .67 | .20 | .21 | | 100 | 1000 |
| PN22-6F-C* | | | .02 | .090 | #6 | .77 | .25 | .26 | | 100 | 1000 |
| PN18-6FN-C | 22 – 18 AWG | Red | .03 | .145 | #6 | .78 | .24 | .20 | CT-100‡, CT-600-A‡, CT-1550‡, CT-1551‡, CT-2500‡ | 100 | 500 |
| PN18-6F-C | | | .03 | .145 | #6 | .78 | .30 | .20 | | 100 | 500 |
| PN18-8F-C | | | .03 | .145 | #8 | .85 | .32 | .23 | | 100 | 500 |
| PN18-10FN-C | | | .03 | .145 | #10 | .86 | .31 | .25 | | 100 | 500 |
| PN18-10F-C | | | .03 | .145 | #10 | .86 | .35 | .25 | | 100 | 500 |
| PN18-14F-C | | | .03 | .145 | #10 | 1.03 | .44 | .33 | | 100 | 500 |
| PN14-6FN-C | | | 18 – 14 AWG | Blue | .03 | .162 | #6 | .79 | | .24 | .19 |
| PN14-6F-C | .03 | .162 | | | #6 | .79 | .28 | .19 | 100 | 500 | |
| PN14-8F-C | .03 | .162 | | | #8 | .85 | .31 | .23 | 100 | 500 | |
| PN14-10FN-C | .03 | .162 | | | #10 | .87 | .31 | .24 | 100 | 500 | |
| PN14-10F-C | .03 | .162 | | | #10 | .87 | .34 | .24 | 100 | 500 | |
| PN14-14F-C | .03 | .162 | | | #10 | 1.02 | .44 | .32 | 100 | 500 | |
| PN10-6F-L | 12 – 10 AWG | Yellow | | | .04 | .225 | #6 | 1.00 | .31 | .22 | CT-100‡, CT-600-A‡, CT-1550‡, CT-1551‡, CT-2500‡ |
| PN10-8F-L | | | .04 | .225 | #8 | 1.03 | .37 | .22 | 50 | 500 | |
| PN10-10F-L | | | .04 | .225 | #10 | 1.04 | .37 | .22 | 50 | 500 | |
| PN10-14F-L | | | .04 | .225 | #10 | 1.14 | .49 | .30 | 50 | 500 | |

*Not UL Listed or CSA Certified.

**To order in bulk, replace -C in the part number with -M for a bulk package of 1000 and replace -L with -D for a bulk package of 500.

‡UL and CSA approved tooling/product combinations. For crimping tool information, see pages D1.83, D1.84, D1.86 and D1.88.

A. System Overview

B1. Cable Ties

B2. Cable Accessories

B3. Stainless Steel Ties

C1. Wiring Duct

C2. Surface Raceway

C3. Abrasion Protection

C4. Cable Management

D1. Terminals

D2. Power Connectors

D3. Grounding Connectors

E1. Labeling Systems

E2. Labels

E3. Pre-Printed & Write-On Markers

E4. Permanent Identification

E5. Lockout/Tagout & Safety Solutions

F. Index

A. System Overview

B1. Cable Ties



Fork Terminal, Nylon Insulated – Funnel Entry

Type PNF-F

- Fork design provides for fast and easy installation, without the need to remove fastener
- Metal insulation grip sleeve crimps to wire insulation, providing protection to the crimp joint during high vibration applications
- Internal barrel serrations assure good wire contact and maximum tensile strength
- UL Flammability UL 94V-2/HB, maximum insulation temperature 221°F (105°C)
- UL and CSA rated up to 600 V per UL 486

B2. Cable Accessories

B3. Stainless Steel Ties



C1. Wiring Duct



C2. Surface Raceway



C3. Abrasion Protection

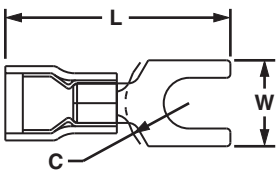

C4. Cable Management

D1. Terminals

D2. Power Connectors

D3. Grounding Connectors

E1. Labeling Systems

E2. Labels

E3. Pre-Printed & Write-On Markers

E4. Permanent Identification

E5. Lockout/Tagout & Safety Solutions

F. Index

| Part Number | Wire Range | Color Code | Stock Thickness | Max. Ins. | Stud Size | Figure Dimensions (In.) | | | Recommended Installation Tool | Std. Pkg. Qty.** | Std. Ctn. Qty. |
|--------------------|-------------|------------|-----------------|-----------|-----------|-------------------------|-----|-----|--|------------------|----------------|
| | | | | | | L | W | C | | | |
| PNF18-6F-C | 22 – 18 AWG | Red | .03 | .136 | #6 | .80 | .30 | .22 | CT-100‡, CT-600-A‡, CT-1550‡, CT-1551‡, CT-2500‡ | 100 | 500 |
| PNF18-8F-C | | | .03 | .136 | #8 | .86 | .31 | .25 | | | |
| PNF18-10F-C | | | .03 | .136 | #10 | .87 | .34 | .26 | | | |
| PNF18-14F-C | | | .03 | .136 | 1/4" | 1.05 | .44 | .35 | | | |
| PNF14-6F-C | 16 – 14 AWG | Blue | .03 | .162 | #6 | .80 | .28 | .22 | CT-100‡, CT-600-A‡, CT-1550‡, CT-1551‡, CT-2500‡ | 100 | 500 |
| PNF14-8F-C | | | .03 | .162 | #8 | .85 | .31 | .25 | | | |
| PNF14-10F-C | | | .03 | .162 | #10 | .87 | .34 | .26 | | | |
| PNF14-14F-C | | | .03 | .162 | 1/4" | 1.05 | .44 | .35 | | | |
| PNF10-6F-L | 12 – 10 AWG | Yellow | .04 | .225 | #6 | 1.01 | .31 | .24 | CT-100‡, CT-600-A‡, CT-1550‡, CT-1551‡, CT-2500‡ | 50 | 500 |
| PNF10-8F-L | | | .04 | .225 | #8 | 1.02 | .37 | .24 | | | |
| PNF10-10F-L | | | .04 | .225 | #10 | 1.04 | .37 | .24 | | | |
| PNF10-14F-L | | | .04 | .225 | 1/4" | 1.15 | .50 | .31 | | | |

**To order in bulk, replace -C in the part number with -M for a bulk package of 1000 and replace -L with -D for a bulk package of 500.
 ‡UL and CSA approved tooling/product combinations. For crimping tool information, see pages D1.83, D1.84, D1.86 and D1.88.



Fork Terminal, Vinyl Insulated – Funnel Entry

Type PV-F

- Fork design provides for fast and easy installation, without the need to remove fastener
- Insulation support helps to prevent wire damage in bending applications
- Brazed seam protects terminal barrel from splitting during the crimp process
- UL Flammability UL 94V-0, maximum insulation temperature 221°F (105°C)
- Internal barrel serrations assure good wire contact and maximum tensile strength
- UL and CSA rated up to 600 V per UL 486

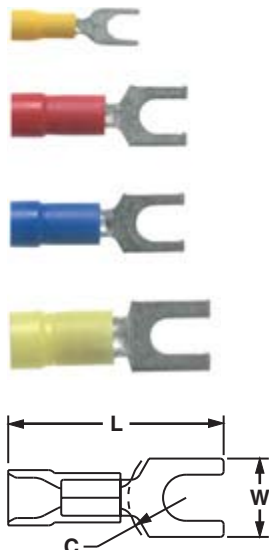

| Part Number | Wire Range | Color Code | Stock Thickness | Max. Ins. | Stud Size | Figure Dimensions (In.) | | | Recommended Installation Tool | Std. Pkg. Qty.** | Std. Ctn. Qty. |
|---------------|-------------|------------|-----------------|-----------|-----------|-------------------------|-----|-----|--|------------------|----------------|
| | | | | | | L | W | C | | | |
| PV22-2F-C* | 26 – 22 AWG | Yellow | .02 | .110 | #2 | .61 | .20 | .19 | CT-100, CT-600-A, CT-1525, CT-2500 | 100 | 1000 |
| PV22-4F-C* | | | .02 | .110 | #4 | .67 | .20 | .21 | | | |
| PV22-6F-C* | | | .02 | .110 | #6 | .76 | .25 | .26 | | | |
| PV18-6FN-CY* | 22 – 16 AWG | Red | .03 | .150 | #6 | .85 | .24 | .21 | CT-100‡, CT-600-A‡, CT-1550‡, CT-1551‡, CT-2500‡ | 100 | 500 |
| PV18-6F-CY | | | .03 | .150 | #6 | .86 | .30 | .21 | | | |
| PV18-8F-CY | | | .03 | .150 | #8 | .93 | .32 | .25 | | | |
| PV18-10FN-CY* | | | .03 | .150 | #10 | .93 | .31 | .25 | | | |
| PV18-10F-CY | | | .03 | .150 | #10 | .93 | .35 | .25 | | | |
| PV14-6FN-C | | | 16 – 14 AWG | Blue | .03 | .170 | #6 | .84 | | | |
| PV14-6F-C | .03 | .170 | | | #6 | .84 | .28 | .19 | | | |
| PV14-8F-C | .03 | .170 | | | #8 | .90 | .31 | .23 | | | |
| PV14-10FN-C | .03 | .170 | | | #10 | .92 | .31 | .24 | | | |
| PV14-10F-C | .03 | .170 | | | #10 | .92 | .34 | .24 | | | |
| PV14-14F-C | .03 | .170 | | | 1/4" | 1.09 | .44 | .32 | | | |
| PV10-6F-L | 14 – 10 AWG | Yellow | .04 | .225 | #6 | 1.01 | .31 | .25 | CT-100‡, CT-600-A‡, CT-1550‡, CT-1551‡, CT-2500‡ | 50 | 500 |
| PV10-8F-L | | | .04 | .225 | #8 | 1.04 | .37 | .25 | | | |
| PV10-10F-L | | | .04 | .225 | #10 | 1.04 | .37 | .25 | | | |
| PV10-14F-L | | | .04 | .225 | 1/4" | 1.14 | .49 | .32 | | | |

*Not UL Listed or CSA Certified.

**To order in bulk, replace -C or -CY in the part number with -M or -MY for a bulk package of 1000 and replace -L with -D for a bulk package of 500.

‡UL and CSA approved tooling/product combinations. For crimping tool information, see pages D1.83, D1.84, D1.86 and D1.88.

A. System Overview

B1. Cable Ties

B2. Cable Accessories

B3. Stainless Steel Ties

C1. Wiring Duct

C2. Surface Raceway

C3. Abrasion Protection

C4. Cable Management

D1. Terminals

D2. Power Connectors

D3. Grounding Connectors

E1. Labeling Systems

E2. Labels

E3. Pre-Printed & Write-On Markers

E4. Permanent Identification

E5. Lockout/Tagout & Safety Solutions

F. Index

A. System Overview

B1. Cable Ties

B2. Cable Accessories

B3. Stainless Steel Ties

C1. Wiring Duct

C2. Surface Raceway

C3. Abrasion Protection

C4. Cable Management

D1. Terminals

D2. Power Connectors

D3. Grounding Connectors

E1. Labeling Systems

E2. Labels

E3. Pre-Printed & Write-On Markers

E4. Permanent Identification

E5. Lockout/Tagout & Safety Solutions

F. Index



Fork Terminal, Vinyl Insulated – Expanded Insulation

Type PV-FX

- Expanded wire entry designed to accommodate wire with a larger insulation thickness
- Fork design provides for fast and easy installation, without the need to remove fastener
- Insulation support helps to prevent wire damage in bending applications
- Brazed seam protects terminal barrel from splitting during the crimp process
- UL Flammability UL 94V-0, maximum insulation temperature 221°F (105°C)
- Internal barrel serrations assure good wire contact and maximum tensile strength
- UL and CSA rated up to 600 V per UL 486

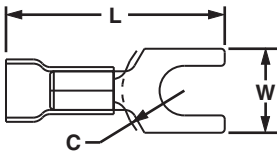

| Part Number | Wire Range | Color Code | Stock Thickness | Max. Ins. | Stud Size | Figure Dimensions (In.) | | | Recommended Installation Tool | Std. Pkg. Qty.** | Std. Ctn. Qty. |
|--------------|-------------|------------|-----------------|-----------|-----------|-------------------------|-----|-----|--|------------------|----------------|
| | | | | | | L | W | C | | | |
| PV18-6FX-CY | 22 – 18 AWG | Red | .03 | .170 | #6 | .83 | .30 | .21 | CT-100‡, CT-600-A‡, CT-1550‡, CT-1551‡, CT-2500‡ | 100 | 500 |
| PV18-8FX-CY | | | .03 | .170 | #8 | .89 | .32 | .25 | | | |
| PV18-10FX-CY | | | .03 | .170 | #10 | .91 | .35 | .25 | | | |
| PV14-6FX-C | 18 – 14 AWG | Blue | .03 | .200 | #6 | .89 | .28 | .16 | CT-100‡, CT-600-A‡, CT-1550‡, CT-1551‡, CT-2500‡ | 100 | 500 |
| PV14-8FX-C | | | .03 | .200 | #8 | .96 | .31 | .20 | | | |
| PV14-10FX-C | | | .03 | .200 | #10 | .97 | .34 | .22 | | | |
| PV10-8FX-L | 12 – 10 AWG | Yellow | .04 | .250 | #8 | 1.11 | .37 | .24 | CT-100‡, CT-600-A‡, CT-1550‡, CT-1551‡, CT-2500‡ | 50 | 500 |
| PV10-10FX-L | | | .04 | .250 | #10 | 1.11 | .37 | .24 | | | |
| PV10-14FX-L | | | .04 | .250 | 1/4" | 1.22 | .50 | .32 | | | |

**To order in bulk, replace -C or -CY in the part number with -M or -MY for a bulk package of 1000 and replace -L with -D for a bulk package of 500.

‡UL and CSA approved tooling/product combinations. For crimping tool information, see pages D1.83, D1.84, D1.86 and D1.88.



Locking Fork Terminal, Nylon Insulated

Type PN-LF

- Locks in place for secure connection
- Fork design provides for fast and easy installation, without the need to remove fastener
- Metal insulation grip sleeve crimps to wire insulation, providing protection to the crimp joint during high vibration applications
- Internal barrel serrations assure good wire contact and maximum tensile strength
- UL Flammability UL 94V-2/HB, maximum insulation temperature 221°F (105°C)
- UL and CSA rated up to 600 V per UL 486

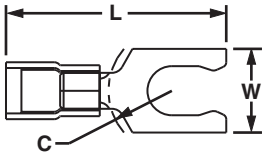

| Part Number | Wire Range | Color Code | Stock Thickness | Max. Ins. | Stud Size | Figure Dimensions (In.) | | | Recommended Installation Tool | Std. Pkg. Qty.** | Std. Ctn. Qty. |
|---------------|-------------|------------|-----------------|-----------|-----------|-------------------------|--|-----|--|------------------|----------------|
| | | | | | | L | W | C | | | |
| PN18-6LF-C | 22 – 18 AWG | Red | .03 | .145 | #6 | .82 | .27 | .22 | CT-100‡, CT-600-A‡, CT-1550‡, CT-1551‡, CT-2500‡ | 100 | 500 |
| PN18-6LFW-C | | | .03 | .145 | #6 | .85 | .29 | .22 | | | |
| PN18-8LF-C | | | .03 | .145 | #8 | .89 | .29 | .25 | | | |
| PN18-10LF-C | | | .03 | .145 | #10 | .89 | .33 | .25 | | | |
| PN18-10LFN-C* | | | .03 | .145 | #10 | .91 | .29 | .25 | | | |
| PN14-6LF-C | 18 – 14 AWG | Blue | .03 | .162 | #6 | .86 | .25 | .22 | CT-100‡, CT-600-A‡, CT-1550‡, CT-1551‡, CT-2500‡ | 100 | 500 |
| PN14-6LFW-C | | | .03 | .162 | #6 | .84 | .29 | .22 | | | |
| PN14-8LF-C | | | .03 | .162 | #8 | .92 | .29 | .25 | | | |
| PN14-10LF-C | | | .03 | .162 | #10 | .91 | .33 | .25 | | | |
| PN14-10LFN-C | .03 | .162 | #10 | .91 | .28 | .25 | CT-100‡, CT-600-A‡, CT-1550‡, CT-1551‡, CT-2500‡ | 100 | 500 | | |
| PN10-6LF-L | 12 – 10 AWG | Yellow | .04 | .225 | #6 | 1.02 | | | | .30 | .23 |
| PN10-8LF-L | | | .04 | .225 | #8 | 1.05 | | | | .30 | .23 |
| PN10-10LF-L | | | .04 | .225 | #10 | 1.05 | | | | .34 | .23 |
| PN10-14LF-L | | | .04 | .225 | 1/4" | 1.17 | .46 | .32 | | | |

*Not UL Listed or CSA Certified.

**To order in bulk, replace -C in the part number with -M for a bulk package of 1000 and replace -L with -D for a bulk package of 500.

‡UL and CSA approved tooling/product combinations. For crimping tool information, see pages D1.83, D1.84, D1.86 and D1.88.



Locking Fork Terminal, Nylon Insulated – Funnel Entry

Type PNF-LF

- Locks in place for secure connection
- Fork design provides for fast and easy installation, without the need to remove fastener
- Metal insulation grip sleeve crimps to wire insulation, providing protection to the crimp joint during high vibration applications

- Internal barrel serrations assure good wire contact and maximum tensile strength
- UL Flammability UL 94V-2/HB, maximum insulation temperature 221°F (105°C)
- UL and CSA rated up to 600 V per UL 486

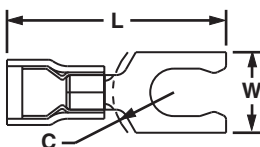

| Part Number | Wire Range | Color Code | Stock Thickness | Max. Ins. | Stud Size | Figure Dimensions (In.) | | | Recommended Installation Tool | Std. Pkg. Qty.** | Std. Ctn. Qty. |
|---------------------|-------------|------------|-----------------|-----------|-----------|-------------------------|-----|-----|--|------------------|----------------|
| | | | | | | L | W | C | | | |
| PNF18-6LF-C | 22 – 18 AWG | Red | .03 | .145 | #6 | .82 | .27 | .20 | CT-100‡, CT-600-A‡, CT-1550‡, CT-1551‡, CT-2500‡ | 100 | 500 |
| PNF18-6LFW-C | | | .03 | .145 | #6 | .85 | .29 | .20 | | | |
| PNF18-8LF-C | | | .03 | .145 | #8 | .89 | .29 | .26 | | | |
| PNF18-10LF-C | | | .03 | .145 | #10 | .89 | .33 | .25 | | | |
| PNF14-6LF-C | 18 – 14 AWG | Blue | .03 | .162 | #6 | .87 | .25 | .20 | CT-100‡, CT-600-A‡, CT-1550‡, CT-1551‡, CT-2500‡ | 100 | 500 |
| PNF14-6LFW-C | | | .03 | .162 | #6 | .84 | .29 | .20 | | | |
| PNF14-8LF-C | | | .03 | .162 | #8 | .93 | .29 | .25 | | | |
| PNF14-10LF-C | | | .03 | .162 | #10 | .93 | .33 | .25 | | | |
| PNF10-6LF-L | 12 – 10 AWG | Yellow | .04 | .225 | #6 | 1.02 | .30 | .20 | CT-100‡, CT-600-A‡, CT-1550‡, CT-1551‡, CT-2500‡ | 50 | 500 |
| PNF10-8LF-L | | | .04 | .225 | #8 | 1.05 | .30 | .20 | | | |
| PNF10-10LF-L | | | .04 | .225 | #10 | 1.05 | .34 | .22 | | | |
| PNF10-14LF-L | | | .04 | .225 | 1/4" | 1.19 | .46 | .33 | | | |

**To order in bulk, replace -C in the part number with -M for a bulk package of 1000 and replace -L with -D for a bulk package of 500.

‡UL and CSA approved tooling/product combinations. For crimping tool information, see pages D1.83, D1.84, D1.86 and D1.88.



Locking Fork Terminal, Vinyl Insulated – Funnel Entry

Type PV-LF

- Locks in place for secure connection
- Fork design provides for fast and easy installation, without the need to remove fastener
- Insulation support helps to prevent wire damage in bending applications

- UL Flammability UL 94V-0, maximum insulation temperature 221°F (105°C)
- Internal barrel serrations assure good wire contact and maximum tensile strength
- UL and CSA rated to 600 V per UL 486

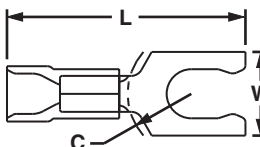

| Part Number | Wire Range | Color Code | Stock Thickness | Max. Ins. | Stud Size | Figure Dimensions (In.) | | | Recommended Installation Tool | Std. Pkg. Qty.** | Std. Ctn. Qty. |
|-----------------------|-------------|------------|-----------------|-----------|-----------|-------------------------|-----|-----|--|------------------|----------------|
| | | | | | | L | W | C | | | |
| PV18-6LF-CY | 22 – 18 AWG | Red | .03 | .150 | #6 | .90 | .27 | .22 | CT-100‡, CT-600-A‡, CT-1550‡, CT-1551‡, CT-2500‡ | 100 | 500 |
| PV18-6LFW-CY | | | .03 | .150 | #6 | .90 | .29 | .22 | | | |
| PV18-8LF-CY | | | .03 | .150 | #8 | .97 | .29 | .25 | | | |
| PV18-10LF-CY | | | .03 | .150 | #10 | .97 | .33 | .25 | | | |
| PV18-10LFN-CY* | | | .03 | .150 | #10 | .97 | .29 | .25 | | | |
| PV14-6LF-C | 18 – 14 AWG | Blue | .03 | .170 | #6 | .90 | .25 | .22 | CT-100‡, CT-600-A‡, CT-1550‡, CT-1551‡, CT-2500‡ | 100 | 500 |
| PV14-6LFW-C | | | .03 | .170 | #6 | .90 | .29 | .22 | | | |
| PV14-8LF-C | | | .03 | .170 | #8 | .97 | .29 | .25 | | | |
| PV14-10LF-C | | | .03 | .170 | #10 | .97 | .33 | .25 | | | |
| PV14-10LFN-C | 12 – 10 AWG | Yellow | .03 | .170 | #10 | .97 | .29 | .25 | CT-100‡, CT-600-A‡, CT-1550‡, CT-1551‡, CT-2500‡ | 100 | 500 |
| PV10-6LF-L | | | .04 | .225 | #6 | 1.03 | .30 | .23 | | | |
| PV10-8LF-L | | | .04 | .225 | #8 | 1.05 | .30 | .23 | | | |
| PV10-10LF-L | | | .04 | .225 | #10 | 1.04 | .34 | .23 | | | |
| PV10-14LF-L | | | .04 | .225 | 1/4" | 1.19 | .46 | .36 | | 50 | 500 |

*Not UL Listed or CSA Certified.

**To order in bulk, replace -C or -CY in the part number with -M or -MY for a bulk package of 1000 and replace -L with -D for a bulk package of 500.

‡UL and CSA approved tooling/product combinations. For crimping tool information, see pages D1.83, D1.84, D1.86 and D1.88.

A. System Overview

B1. Cable Ties

B2. Cable Accessories

B3. Stainless Steel Ties

C1. Wiring Duct

C2. Surface Raceway

C3. Abrasion Protection

C4. Cable Management

D1. Terminals

D2. Power Connectors

D3. Grounding Connectors

E1. Labeling Systems

E2. Labels

E3. Pre-Printed & Write-On Markers

E4. Permanent Identification

E5. Lockout/Tagout & Safety Solutions

F. Index

A. System Overview

B1. Cable Ties

B2. Cable Accessories

B3. Stainless Steel Ties

C1. Wiring Duct

C2. Surface Raceway

C3. Abrasion Protection

C4. Cable Management

D1. Terminals

D2. Power Connectors

D3. Grounding Connectors

E1. Labeling Systems

E2. Labels

E3. Pre-Printed & Write-On Markers

E4. Permanent Identification

E5. Lockout/Tagout & Safety Solutions

F. Index



Locking Fork Terminal, Vinyl Insulated – Expanded Insulation

Type PV-LFX

- Expanded wire entry designed to accommodate wire with a larger insulation thickness
- Locks in place for secure connection
- Insulation support helps to prevent wire damage in bending applications
- Brazed seam protects terminal barrel from splitting during the crimp process
- UL Flammability UL 94V-0, maximum insulation temperature 221°F (105°C)
- Internal barrel serrations assure good wire contact and maximum tensile strength
- UL and CSA rated up to 600 V per UL 486

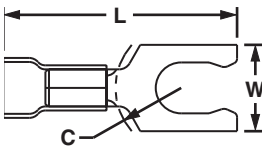

| Part Number | Wire Range | Color Code | Stock Thickness | Max. Ins. | Stud Size | Figure Dimensions (In.) | | | Recommended Installation Tool | Std. Pkg. Qty.** | Std. Ctn. Qty. |
|---------------|-------------|------------|-----------------|-----------|-----------|-------------------------|-----|-----|--|------------------|----------------|
| | | | | | | L | W | C | | | |
| PV18-6LFX-CY | 22 – 16 AWG | Red | .03 | .170 | #6 | .95 | .27 | .20 | CT-100‡, CT-600-A‡, CT-1550‡, CT-1551‡, CT-2500‡ | 100 | 500 |
| PV18-8LFX-CY | | | .03 | .170 | #8 | 1.01 | .29 | .20 | | | |
| PV18-10LFX-CY | | | .03 | .170 | #10 | 1.04 | .33 | .23 | | | |
| PV14-6LFX-C | 18 – 14 AWG | Blue | .03 | .200 | #6 | .95 | .25 | .20 | CT-100‡, CT-600-A‡, CT-1550‡, CT-1551‡, CT-2500‡ | 100 | 500 |
| PV14-8LFX-C | | | .03 | .200 | #8 | 1.01 | .29 | .23 | | | |
| PV14-10LFX-C | | | .03 | .200 | #10 | 1.01 | .33 | .23 | | | |
| PV10-6LFX-L | 12 – 10 AWG | Yellow | .04 | .250 | #6 | 1.09 | .30 | .23 | CT-100‡, CT-600-A‡, CT-1550‡, CT-1551‡, CT-2500‡ | 50 | 500 |
| PV10-8LFX-L | | | .04 | .250 | #8 | 1.12 | .30 | .23 | | | |
| PV10-10LFX-L | | | .04 | .250 | #10 | 1.12 | .34 | .23 | | | |
| PV10-14LFX-L | | | .04 | .250 | 1/4" | 1.25 | .46 | .32 | | 50 | 500 |

**To order in bulk, replace -C or -CY in the part number with -M or -MY for a bulk package of 1000 and replace -L with -D for a bulk package of 500.

‡UL and CSA approved tooling/product combinations. For crimping tool information, see pages D1.83, D1.84, D1.86 and D1.88.



Short Locking Fork Terminal, Nylon Insulated

Type PN-SLF

- Locks in place for a secure connection in limited spaces
- Fork design provides for fast and easy installation, without the need to remove fastener
- Metal insulation grip sleeve crimps to wire insulation, providing protection to the crimp joint during high vibration applications
- Internal barrel serrations assure good wire contact and maximum tensile strength
- UL Flammability UL 94V-2/HB, maximum insulation temperature 221°F (105°C)
- UL and CSA rated up to 600 V per UL 486

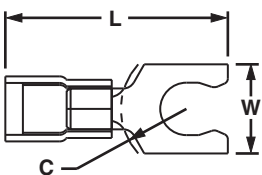

| Part Number | Wire Range | Color Code | Stock Thickness | Max. Ins. | Stud Size | Figure Dimensions (In.) | | | Recommended Installation Tool | Std. Pkg. Qty.** | Std. Ctn. Qty. |
|--------------|-------------|------------|-----------------|-----------|-----------|-------------------------|-----|-----|-------------------------------|------------------|----------------|
| | | | | | | L | W | C | | | |
| PN18-5SLF-C | 22 – 18 AWG | Red | .03 | .145 | #5 | .75 | .26 | .19 | CT-1550, CT-1551, CT-2500 | 100 | 500 |
| PN18-6SLF-C | | | .03 | .145 | #6 | .75 | .27 | .19 | | | |
| PN18-8SLF-C | | | .03 | .145 | #8 | .80 | .29 | .23 | | | |
| PN18-10SLF-C | | | .03 | .145 | #10 | .81 | .33 | .23 | | | |
| PN14-5SLF-C | 16 – 14 AWG | Blue | .03 | .162 | #5 | .75 | .25 | .19 | CT-1550, CT-1551, CT-2500 | 100 | 500 |
| PN14-6SLF-C | | | .03 | .162 | #6 | .75 | .25 | .19 | | | |
| PN14-8SLF-C | | | .03 | .162 | #8 | .80 | .29 | .23 | | | |
| PN14-10SLF-C | | | .03 | .162 | #10 | .81 | .33 | .23 | | | |
| PN14-14SLF-C | | | .03 | .162 | 1/4" | .90 | .44 | .28 | | 100 | 500 |
| PN10-5SLF-L | 12 – 10 AWG | Yellow | .04 | .225 | #5 | .86 | .25 | .22 | CT-1550, CT-1551, CT-2500 | 50 | 500 |
| PN10-6SLF-L | | | .04 | .225 | #6 | .86 | .25 | .22 | | | |
| PN10-8SLF-L | | | .04 | .225 | #8 | .92 | .29 | .26 | | | |
| PN10-10SLF-L | | | .04 | .225 | #10 | .92 | .33 | .26 | | | |
| PN10-14SLF-L | | | .04 | .225 | 1/4" | 1.01 | .45 | .33 | | 50 | 500 |

**To order in bulk, replace -C in the part number with -M for a bulk package of 1000 and replace -L with -D for a bulk package of 500.

For crimping tool information, see pages D1.84 and D1.88.



Short Locking Fork Terminal, Nylon Insulated – Funnel Entry

Type PNF-SLF

- Locks in place for a secure connection in limited spaces
- Fork design provides for fast and easy installation, without the need to remove fastener
- Metal insulation grip sleeve crimps to wire insulation, providing protection to the crimp joint during high vibration applications
- Internal barrel serrations assure good wire contact and maximum tensile strength
- UL Flammability UL 94V-2/HB, maximum insulation temperature 221°F (105°C)
- UL and CSA rated up to 600 V per UL 486

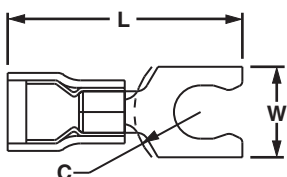

| Part Number | Wire Range | Color Code | Stock Thickness | Max. Ins. | Stud Size | Figure Dimensions (In.) | | | Recommended Installation Tool | Std. Pkg. Qty.** | Std. Ctn. Qty. |
|---------------|-------------|------------|-----------------|-----------|-----------|-------------------------|-----|-----|-------------------------------|------------------|----------------|
| | | | | | | L | W | C | | | |
| PNF18-5SLF-C | 22 – 18 AWG | Red | .03 | .145 | #5 | .75 | .26 | .19 | CT-1550, CT-1551, CT-2500 | 100 | 500 |
| PNF18-6SLF-C | | | .03 | .145 | #6 | .75 | .27 | .19 | | | |
| PNF18-8SLF-C | | | .03 | .145 | #8 | .80 | .29 | .23 | | | |
| PNF18-10SLF-C | | | .03 | .145 | #10 | .81 | .33 | .23 | | | |
| PNF14-5SLF-C | 16 – 14 AWG | Blue | .03 | .162 | #5 | .75 | .25 | .19 | CT-1550, CT-1551, CT-2500 | 100 | 500 |
| PNF14-6SLF-C | | | .03 | .162 | #6 | .75 | .25 | .19 | | | |
| PNF14-8SLF-C | | | .03 | .162 | #8 | .82 | .29 | .23 | | | |
| PNF14-10SLF-C | | | .03 | .162 | #10 | .81 | .33 | .23 | | | |
| PNF14-14SLF-C | | | .03 | .162 | 1/4" | .91 | .44 | .28 | | 100 | 500 |
| PNF10-6SLF-L | 12 – 10 AWG | Yellow | .04 | .225 | #6 | .91 | .25 | .17 | CT-1550, CT-1551, CT-2500 | 50 | 500 |
| PNF10-8SLF-L | | | .04 | .225 | #8 | .92 | .29 | .22 | | | |
| PNF10-10SLF-L | | | .04 | .225 | #10 | .93 | .33 | .22 | | | |
| PNF10-14SLF-L | | | .04 | .225 | 1/4" | 1.02 | .45 | .28 | | | |

**To order in bulk, replace -C in the part number with -M for a bulk package of 1000 and replace -L with -D for a bulk package of 500.

For crimping tool information, see pages D1.84 and D1.88.



Short Locking Fork Terminal, Vinyl Insulated – Funnel Entry

Type PV-SLF

- Locks in place for a secure connection in limited spaces
- Fork design provides for fast and easy installation, without the need to remove fastener
- Insulation support helps to prevent wire damage in bending applications
- Internal barrel serrations assure good wire contact and maximum tensile strength
- UL Flammability UL 94V-0, maximum insulation temperature 221°F (105°C)
- UL and CSA rated up to 600 V per UL 486

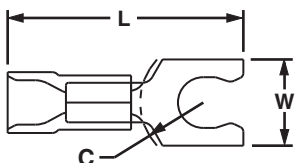

| Part Number | Wire Range | Color Code | Stock Thickness | Max. Ins. | Stud Size | Figure Dimensions (In.) | | | Recommended Installation Tool | Std. Pkg. Qty.** | Std. Ctn. Qty. |
|----------------|-------------|------------|-----------------|-----------|-----------|-------------------------|-----|-----|-------------------------------|------------------|----------------|
| | | | | | | L | W | C | | | |
| PV18-5SLF-CY^ | 22 – 18 AWG | Red | .03 | .150 | #5 | .82 | .26 | .19 | CT-1550, CT-1551, CT-2500 | 100 | 500 |
| PV18-6SLF-CY^ | | | .03 | .150 | #6 | .82 | .27 | .19 | | | |
| PV18-8SLF-CY^ | | | .03 | .150 | #8 | .87 | .29 | .23 | | | |
| PV18-10SLF-CY^ | | | .03 | .150 | #10 | .88 | .33 | .23 | | | |
| PV14-5SLF-C* | 16 – 14 AWG | Blue | .03 | .175 | #5 | .80 | .25 | .22 | CT-1550, CT-1551, CT-2500 | 100 | 1000 |
| PV14-6SLF-C* | | | .03 | .175 | #6 | .80 | .25 | .22 | | | |
| PV14-8SLF-C* | | | .03 | .175 | #8 | .85 | .29 | .26 | | | |
| PV14-10SLF-C* | | | .03 | .175 | #10 | .86 | .33 | .26 | | | |
| PV14-14SLF-C* | | | .03 | .175 | 1/4" | .95 | .44 | .33 | | 100 | 1000 |
| PV10-5SLF-L | 12 – 10 AWG | Yellow | .04 | .225 | #5 | .86 | .25 | .22 | CT-1550, CT-1551, CT-2500 | 50 | 500 |
| PV10-6SLF-L | | | .04 | .225 | #6 | .87 | .25 | .22 | | | |
| PV10-8SLF-L | | | .04 | .225 | #8 | .92 | .29 | .26 | | | |
| PV10-10SLF-L | | | .04 | .225 | #10 | .92 | .33 | .26 | | | |
| PV10-14SLF-L | | | .04 | .225 | 1/4" | 1.02 | .45 | .33 | | | |

*Not UL Listed or CSA Certified.

**To order in bulk, replace -C or -CY in the part number with -M or -MY for a bulk package of 1000 and replace -L with -D for a bulk package of 500.

For crimping tool information, see pages D1.84 and D1.88.

^CSA Certified only.

A. System Overview

B1. Cable Ties

B2. Cable Accessories

B3. Stainless Steel Ties

C1. Wiring Duct

C2. Surface Raceway

C3. Abrasion Protection

C4. Cable Management

D1. Terminals

D2. Power Connectors

D3. Grounding Connectors

E1. Labeling Systems

E2. Labels

E3. Pre-Printed & Write-On Markers

E4. Permanent Identification

E5. Lockout/Tagout & Safety Solutions

F. Index

A. System Overview

B1. Cable Ties

B2. Cable Accessories

B3. Stainless Steel Ties

C1. Wiring Duct

C2. Surface Raceway

C3. Abrasion Protection

C4. Cable Management

D1. Terminals

D2. Power Connectors

D3. Grounding Connectors

E1. Labeling Systems

E2. Labels

E3. Pre-Printed & Write-On Markers

E4. Permanent Identification

E5. Lockout/Tagout & Safety Solutions

F. Index



Flanged Fork Terminal, Nylon Insulated

Type PN-FF

- Flange design provides extra secure connection on a variety of applications
- Metal insulation grip sleeve crimps to wire insulation, providing protection to the crimp joint during high vibration applications
- Internal barrel serrations assure good wire contact and maximum tensile strength

- UL Flammability UL 94V-2/HB, maximum insulation temperature 221°F (105°C)
- UL and CSA rated up to 600 V per UL 486

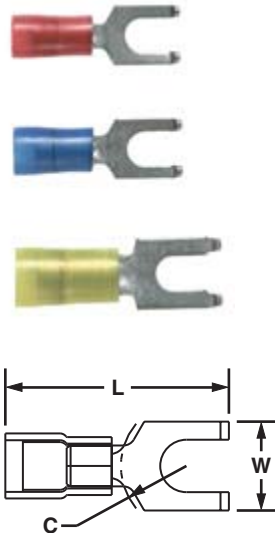

| Part Number | Wire Range | Color Code | Stock Thickness | Max. Ins. | Stud Size | Figure Dimensions (In.) | | | Recommended Installation Tool | Std. Pkg. Qty.** | Std. Ctn. Qty. |
|--------------------|-------------|------------|-----------------|-----------|-----------|-------------------------|-----|-----|--|------------------|----------------|
| | | | | | | L | W | C | | | |
| PN18-6FF-C | 22 – 16 AWG | Red | .03 | .136 | #6 | .81 | .28 | .20 | CT-100‡, CT-600-A‡, CT-1550‡, CT-1551‡, CT-2500‡ | 100 | 500 |
| PN18-8FF-C | | | .03 | .136 | #8 | .88 | .31 | .23 | | | |
| PN18-10FF-C | | | .03 | .136 | #10 | .86 | .35 | .23 | | | |
| PN14-6FF-C | 18 – 14 AWG | Blue | .03 | .162 | #6 | .79 | .28 | .20 | CT-100‡, CT-600-A‡, CT-1550‡, CT-1551‡, CT-2500‡ | 100 | 500 |
| PN14-8FF-C | | | .03 | .162 | #8 | .86 | .31 | .23 | | | |
| PN14-10FF-C | | | .03 | .162 | #10 | .86 | .36 | .23 | | | |
| PN10-8FF-L | 12 – 10 AWG | Yellow | .04 | .225 | #8 | 1.05 | .37 | .28 | CT-100‡, CT-600-A‡, CT-1550‡, CT-1551‡, CT-2500‡ | 50 | 500 |
| PN10-10FF-L | | | .04 | .225 | #10 | 1.05 | .37 | .28 | | | |

**To order in bulk, replace -C in the part number with -M for a bulk package of 1000 and replace -L with -D for a bulk package of 500.

‡UL and CSA approved tooling/product combinations. For crimping tool information, see pages D1.83, D1.84, D1.86 and D1.88.



Flanged Fork Terminal, Vinyl Insulated – Funnel Entry

Type PV-FF

- Flange design provides extra secure connection on a variety of applications
- Insulation support helps to prevent wire damage in bending applications
- Brazed seam protects terminal barrel from splitting during the crimp process

- UL Flammability UL 94V-0, maximum insulation temperature 221°F (105°C)
- Internal barrel serrations assure good wire contact and maximum tensile strength
- UL and CSA rated up to 600 V per UL 486

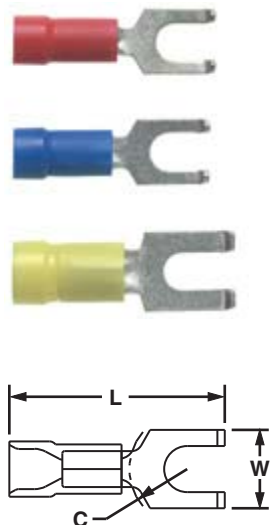

| Part Number | Wire Range | Color Code | Stock Thickness | Max. Ins. | Stud Size | Figure Dimensions (In.) | | | Recommended Installation Tool | Std. Pkg. Qty.** | Std. Ctn. Qty. |
|---------------------|-------------|------------|-----------------|-----------|-----------|-------------------------|-----|-----|--|------------------|----------------|
| | | | | | | L | W | C | | | |
| PV18-6FF-CY | 22 – 16 AWG | Red | .03 | .150 | #6 | .87 | .28 | .19 | CT-100‡, CT-600-A‡, CT-1550‡, CT-1551‡, CT-2500‡ | 100 | 500 |
| PV18-8FF-CY | | | .03 | .150 | #8 | .94 | .31 | .23 | | | |
| PV18-10FF-CY | | | .03 | .150 | #10 | .93 | .35 | .23 | | | |
| PV14-6FF-C | 16 – 14 AWG | Blue | .03 | .165 | #6 | .88 | .28 | .19 | CT-100‡, CT-600-A‡, CT-1550‡, CT-1551‡, CT-2500‡ | 100 | 500 |
| PV14-8FF-C | | | .03 | .165 | #8 | .94 | .31 | .23 | | | |
| PV14-10FF-C | | | .03 | .165 | #10 | .94 | .35 | .23 | | | |
| PV10-8FF-L | 14 – 10 AWG | Yellow | .04 | .225 | #8 | 1.03 | .37 | .22 | CT-100‡, CT-600-A‡, CT-1550‡, CT-1551‡, CT-2500‡ | 50 | 500 |
| PV10-10FF-L | | | .04 | .225 | #10 | 1.03 | .37 | .22 | | | |

**To order in bulk, replace -C or -CY in the part number with -M or -MY for a bulk package of 1000 and replace -L with -D for a bulk package of 500.

‡UL and CSA approved tooling/product combinations. For crimping tool information, see pages D1.83, D1.84, D1.86 and D1.88.



Fork Terminal, Non-Insulated

Type P-F

- Fork design provides for fast and easy installation, without the need to remove fastener
- Internal barrel serrations assure good wire contact and maximum tensile strength
- Brazed seam protects terminal barrel from splitting during the crimp process

- Barrel of terminal internally beveled to provide quick and easy wire insertion
- UL and CSA rated up to 2000 V per UL 486
- Maximum recommended operating temperature 302°F (150°C)

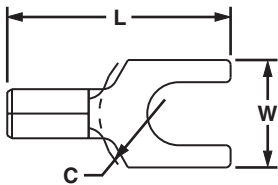

| Part Number | Wire Range | Stock Thickness | Stud Size | Figure Dimensions (In.) | | | Recommended Installation Tool | Std. Pkg. Qty.** | Std. Ctn. Qty. |
|--------------------|-------------|-----------------|-----------|-------------------------|-----|-----|---|------------------|----------------|
| | | | | L | W | C | | | |
| P22-2F-C* | 26 – 22 AWG | .02 | #2 | .49 | .19 | .19 | CT-100, CT-200 | 100 | 1000 |
| P22-4F-C* | | .02 | #4 | .49 | .20 | .19 | | 100 | 1000 |
| P22-6F-C* | | .02 | #6 | .59 | .25 | .26 | | 100 | 1000 |
| P18-6FN-C* | 22 – 16 AWG | .03 | #6 | .63 | .24 | .19 | CT-100‡, CT-200‡, CT-600-A‡, CT-1570‡, CT-2500‡ | 100 | 1000 |
| P18-6F-C | | .03 | #6 | .63 | .30 | .21 | | 100 | 1000 |
| P18-8F-C | | .03 | #8 | .69 | .32 | .25 | | 100 | 1000 |
| P18-10FN-C* | | .03 | #10 | .71 | .31 | .25 | | 100 | 1000 |
| P18-10F-C | | .03 | #10 | .71 | .35 | .25 | | 100 | 1000 |
| P18-14F-C | | .03 | 1/4" | .88 | .44 | .33 | | 100 | 1000 |
| P14-6FN-C | 18 – 14 AWG | .03 | #6 | .63 | .24 | .20 | CT-100‡, CT-200‡, CT-600-A‡, CT-1570‡, CT-2500‡ | 100 | 1000 |
| P14-6F-C | | .03 | #6 | .63 | .28 | .20 | | 100 | 1000 |
| P14-8F-C | | .03 | #8 | .69 | .31 | .23 | | 100 | 1000 |
| P14-10FN-C | | .03 | #10 | .71 | .31 | .25 | | 100 | 1000 |
| P14-10F-C | | .03 | #10 | .71 | .34 | .25 | | 100 | 1000 |
| P14-14F-C | | .03 | 1/4" | .88 | .44 | .33 | | 100 | 1000 |
| P10-6F-L | 12 – 10 AWG | .04 | #6 | .75 | .31 | .22 | CT-100‡, CT-200‡, CT-600-A‡, CT-1570‡, CT-1701‡, CT-2500‡ | 50 | 500 |
| P10-8F-L | | .04 | #8 | .78 | .37 | .22 | | 50 | 500 |
| P10-10F-L | | .04 | #10 | .78 | .37 | .23 | | 50 | 500 |
| P10-14F-L | | .04 | 1/4" | .89 | .50 | .30 | | 50 | 500 |

*Not UL Listed or CSA Certified.

**To order in bulk, replace -C in the part number with -M for a bulk package of 1000 and replace -L with -D for a bulk package of 500.

‡UL and CSA approved tooling/product combinations. For crimping tool information, see pages D1.83, D1.84, D1.86 and D1.88.

A. System Overview

B1. Cable Ties

B2. Cable Accessories

B3. Stainless Steel Ties

C1. Wiring Duct

C2. Surface Raceway

C3. Abrasion Protection

C4. Cable Management

D1. Terminals

D2. Power Connectors

D3. Grounding Connectors

E1. Labeling Systems

E2. Labels

E3. Pre-Printed & Write-On Markers

E4. Permanent Identification

E5. Lockout/Tagout & Safety Solutions

F. Index

A. System Overview

B1. Cable Ties



Flanged Fork Terminal, Non-Insulated

Type P-FF

- Flange design provides extra secure connection on a variety of applications
- Internal barrel serrations assure good wire contact and maximum tensile strength
- Brazed seam protects terminal barrel from splitting during the crimp process

- Barrel of terminal internally beveled to provide quick and easy wire insertion
- UL and CSA rated up to 2000 V per UL 486
- Maximum recommended operating temperature 302°F (150°C)

B2. Cable Accessories

B3. Stainless Steel Ties



C1. Wiring Duct



C2. Surface Raceway



C3. Abrasion Protection

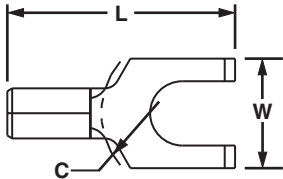

C4. Cable Management

| Part Number | Wire Range | Stock Thickness | Stud Size | Figure Dimensions (In.) | | | Recommended Installation Tool | Std. Pkg. Qty.** | Std. Ctn. Qty. |
|-------------------|-------------|-----------------|-----------|-------------------------|-----|-----|---|------------------|----------------|
| | | | | L | W | C | | | |
| P18-8FF-C | 22 – 16 AWG | .03 | #8 | .72 | .31 | .25 | CT-100‡, CT-200‡, CT-600-A‡, CT-1570‡, CT-2500‡ | 100 | 500 |
| P14-6FF-C | 16 – 14 AWG | .03 | #6 | .65 | .28 | .22 | | 100 | 500 |
| P14-8FF-C | | .03 | #8 | .72 | .31 | .25 | | 100 | 500 |
| P10-10FF-L | 12 – 10 AWG | .04 | #10 | .80 | .38 | .28 | CT-100‡, CT-200‡, CT-600-A‡, CT-1570‡, CT-1701‡, CT-2500‡ | 50 | 500 |

**To order in bulk, replace -C in the part number with -M for a bulk package of 1000 and replace -L with -D for a bulk package of 500.

‡UL and CSA approved tooling/product combinations. For crimping tool information, see pages D1.83, D1.84, D1.86 and D1.88.

D1. Terminals



Locking Fork Terminal, Non-Insulated

Type P-LF

- Locks in place for secure connection
- Fork design provides for fast and easy installation, without the need to remove fastener
- Internal barrel serrations assure good wire contact and maximum tensile strength
- Brazed seam protects terminal barrel from splitting during the crimp process

- Barrel of terminal internally beveled to provide quick and easy wire insertion
- UL and CSA rated up to 2000 V per UL 486
- Maximum recommended operating temperature 302°F (150°C)

D2. Power Connectors

D3. Grounding Connectors



E3. Pre-Printed & Write-On Markers

E4. Permanent Identification

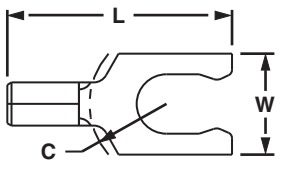

E5. Lockout/Tagout & Safety Solutions

| Part Number | Wire Range | Stock Thickness | Stud Size | Figure Dimensions (In.) | | | Recommended Installation Tool | Std. Pkg. Qty.** | Std. Ctn. Qty. |
|---------------------|-------------|-----------------|-----------|-------------------------|-----|-----|---|------------------|----------------|
| | | | | L | W | C | | | |
| P18-6LF-C | 22 – 16 AWG | .03 | #6 | .68 | .27 | .22 | CT-100‡, CT-200‡, CT-600-A‡, CT-1570‡, CT-2500‡ | 100 | 500 |
| P18-6LFW-C | | .03 | #6 | .70 | .29 | .22 | | 100 | 500 |
| P18-8LF-C | | .03 | #8 | .74 | .29 | .23 | | 100 | 500 |
| P18-10LFN-C* | | .03 | #10 | .74 | .28 | .23 | | 100 | 500 |
| P18-10LF-C | | .03 | #10 | .74 | .33 | .23 | | 100 | 500 |
| P14-6LF-C | 18 – 14 AWG | .03 | #6 | .70 | .25 | .22 | CT-100‡, CT-200‡, CT-600-A‡, CT-1570‡, CT-2500‡ | 100 | 500 |
| P14-6LFW-C | | .03 | #6 | .70 | .29 | .22 | | 100 | 500 |
| P14-8LF-C | | .03 | #8 | .77 | .29 | .27 | | 100 | 500 |
| P14-10LFN-C | | .03 | #10 | .77 | .29 | .27 | | 100 | 500 |
| P14-10LF-C | | .03 | #10 | .77 | .33 | .27 | | 100 | 500 |
| P10-6LF-L | 14 – 10 AWG | .04 | #6 | .77 | .30 | .23 | CT-100‡, CT-200‡, CT-600-A‡, CT-1570‡, CT-1701‡, CT-2500‡ | 50 | 500 |
| P10-8LF-L | | .04 | #8 | .79 | .30 | .23 | | 50 | 500 |
| P10-10LF-L | | .04 | #10 | .79 | .34 | .23 | | 50 | 500 |
| P10-14LF-L | | .04 | 1/4" | .92 | .46 | .33 | | 50 | 500 |

*Not UL Listed or CSA Certified.

**To order in bulk, replace -C in the part number with -M for a bulk package of 1000 and replace -L with -D for a bulk package of 500.

‡UL and CSA approved tooling/product combinations. For crimping tool information, see pages D1.83, D1.84, D1.86 and D1.88.

UL LISTED CERTIFIED Short Locking Fork Terminal, Non-Insulated

Type P-SLF

- Locks in place for a secure connection in limited spaces
- Fork design provides for fast and easy installation, without the need to remove fastener
- Internal barrel serrations assure good wire contact and maximum tensile strength
- Brazed seam protects terminal barrel from splitting during the crimp process
- Barrel of terminal internally beveled to provide quick and easy wire insertion
- UL and CSA rated up to 2000 V per UL 486
- Maximum recommended operating temperature 302°F (150°C)

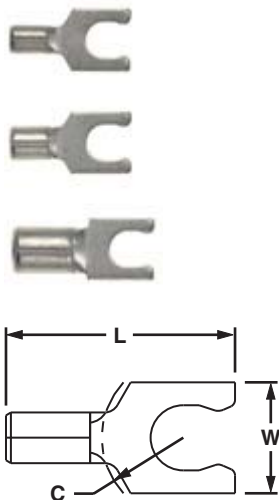

| Part Number | Wire Range | Stock Thickness | Stud Size | Figure Dimensions (In.) | | | Recommended Installation Tool | Std. Pkg. Qty.** | Std. Ctn. Qty. |
|-------------|-------------|-----------------|-----------|-------------------------|-----|-----|---|------------------|----------------|
| | | | | L | W | C | | | |
| P18-6SLF-C | 22 – 16 AWG | .03 | #6 | .51 | .27 | .22 | CT-100‡, CT-200‡, CT-600-A‡, CT-1570‡, CT-2500‡ | 100 | 1000 |
| P18-8SLF-C | | .03 | #8 | .56 | .29 | .25 | | 100 | 1000 |
| P18-10SLF-C | | .03 | #10 | .57 | .33 | .25 | | 100 | 1000 |
| P14-6SLF-C | 16 – 14 AWG | .03 | #6 | .51 | .25 | .22 | CT-100‡, CT-200‡, CT-600-A‡, CT-1570‡, CT-2500‡ | 100 | 1000 |
| P14-8SLF-C | | .03 | #8 | .56 | .29 | .25 | | 100 | 1000 |
| P14-10SLF-C | | .03 | #10 | .57 | .33 | .25 | | 100 | 1000 |
| P14-14SLF-C | | .03 | 1/4" | .66 | .44 | .35 | | 100 | 1000 |
| P10-5SLF-L | 14 – 10 AWG | .04 | #5 | .60 | .25 | .19 | CT-100‡, CT-200‡, CT-600-A‡, CT-1570‡, CT-1701‡, CT-2500‡ | 50 | 500 |
| P10-8SLF-L | | .04 | #8 | .66 | .29 | .23 | | 50 | 500 |
| P10-10SLF-L | | .04 | #10 | .67 | .33 | .23 | | 50 | 500 |
| P10-14SLF-L | | .04 | 1/4" | .76 | .45 | .28 | | 50 | 500 |

**To order in bulk, replace -C in the part number with -M for a bulk package of 1000 and replace -L with -D for a bulk package of 500.

‡UL and CSA approved tooling/product combinations. For crimping tool information, see pages D1.83, D1.84, D1.86 and D1.88.

UL LISTED CERTIFIED Heat Shrink, Fork Terminal

Type PH-F

- Heat shrink polyolefin sleeve with hot melt adhesive protects against moisture
- Heat shrink sleeving forms a protective barrier to provide environmentally sealed terminations ideal for high moisture applications
- Fork design provides for fast and easy installation, without the need to remove fastener
- Brazed seam protects terminal barrel from splitting during the crimp process
- Heat shrink insulation is completed with a standard heat gun
- Minimum continuous operating temperature -65°F (-55°C)
- Maximum continuous operation temperature 230°F (110°C)
- Shrink temperature 250°F (120°C)



| Part Number | Wire Range | Color Code | Max. Ins. | Stud Size | Figure Dimensions (In.) | | Wire Strip Length | Recommended Installation Tool | Std. Pkg. Qty. | Std. Ctn. Qty. |
|-------------|-------------|------------|-----------|-----------|-------------------------|-----|-------------------|-------------------------------|----------------|----------------|
| | | | | | L | W | | | | |
| PH18-6F-Q | 22 – 18 AWG | Red | .170 | #6 | 1.04 | .32 | 5/16 | CT-310 | 25 | 125 |
| PH18-8F-Q | | | .170 | #8 | 1.04 | .32 | 5/16 | | 25 | 125 |
| PH18-10F-Q | | | .170 | #10 | 1.04 | .32 | 5/16 | | 25 | 125 |
| PH14-6F-Q | 16 – 14 AWG | Blue | .190 | #6 | 1.07 | .38 | 5/16 | CT-310 | 25 | 125 |
| PH14-8F-Q | | | .190 | #8 | 1.07 | .38 | 5/16 | | 25 | 125 |
| PH14-10F-Q | | | .190 | #10 | 1.07 | .38 | 5/16 | | 25 | 125 |
| PH10-8F-E | 12 – 10 AWG | Yellow | .240 | #8 | 1.20 | .38 | 5/16 | CT-310 | 20 | 100 |
| PH10-10F-E | | | .240 | #10 | 1.20 | .38 | 5/16 | | 20 | 100 |

For crimping tool information, see page D1.85.

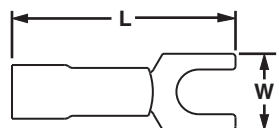

A. System Overview

B1. Cable Ties

B2. Cable Accessories

B3. Stainless Steel Ties

C1. Wiring Duct

C2. Surface Raceway

C3. Abrasion Protection

C4. Cable Management

D1. Terminals

D2. Power Connectors

D3. Grounding Connectors

E1. Labeling Systems

E2. Labels

E3. Pre-Printed & Write-On Markers

E4. Permanent Identification

E5. Lockout/Tagout & Safety Solutions

F. Index

A. System Overview

Features and Benefits – PAN-TERM® Metric Terminals

All PANDUIT terminals feature high quality materials made with electrolytic copper for high conductivity and are tin-plated for corrosion resistance.

B1. Cable Ties

B2. Cable Accessories

B3. Stainless Steel Ties

C1. Wiring Duct

C2. Surface Raceway

C3. Abrasion Protection

C4. Cable Management

Nylon Insulated Terminals with Insulation Grip Sleeve Type PMN or PMNF

Internal barrel serrations assure good wire contact and maximum tensile strength



Maximum insulation temperature 221°F (105°C)

Sleeved barrel assures crimp reliability

Insulation grip sleeve provides a superior insulation crimp for high vibration and high strain relief applications

Color-coded insulation identifies wire range

Funnel entry for faster insertion and lower installed cost

Rated up to 600 V per UL 486.

Flammability – UL 94V-21HB.

Proprietary blend of UL 094V-2 and UL 94HB flammability related materials.

Vinyl Insulated Terminals with Insulation Support Type PMV

Internal barrel serrations assure good wire contact and maximum tensile strength



Maximum insulation temperature 221°F (105°C)

Color-coded insulation identifies wire range

Brazed seam assures crimp reliability

Insulation crimp provides insulation support to protect electrical crimp

Funnel entry for faster insertion and lower installed cost

Rated up to 600 V per UL 486.

Flammability – UL 94V-0.

Non-Insulated Terminals Type PM

Product markings provide easy identification of wire size



Maximum recommended operating temperature 302°F (150°C)

Extended barrel length assures a good quality crimp and makes crimping easier

Internal barrel serrations assure good wire contact and maximum tensile strength

Brazed seam assures crimp reliability

Internally beveled barrel for quick easy wire insertion

Rated up to 2000 V per UL 486.

D1. Terminals

D2. Power Connectors

D3. Grounding Connectors

E1. Labeling Systems

E2. Labels

E3. Pre-Printed & Write-On Markers

E4. Permanent Identification

E5. Lockout/Tagout & Safety Solutions

F. Index



PANDUIT extensive line of tooling is specifically designed for optimum crimping performance.

See pages D1.83 – D1.88.



PANDUIT designs and manufactures a full line of labeling products, software, and printers to assist you with your labeling requirements.

See pages E1.1 – E2.30.

Part Number System for *PAN-TERM*® Metric Terminals

| PM | V | 1 | — | 3 | R | B | — | C |
|-------------------------------|---|--|----------|---|----------------------|-----------------------|----------|---|
| Type | Insulation | Wire Range | | Stud Size | Tongue Configuration | Special Configuration | | Std. Pkg. Size |
| PM = <i>PAN-TERM</i> ® Metric | N = Nylon NF = Nylon Funnel V = Vinyl | 1 = .5 – 1.0mm ² (22 – 18 AWG) 2 = 1.5 – 2.5mm ² (16 – 14 AWG) 6 = 4.0 – 6.0mm ² (12 – 10 AWG) | | 3 = M3 (#6) 4 = M4 (#8) 5 = M5 (#10) 6 = M6 (1/4) 8 = M8 (5/16) | R = Ring F = Fork | B = Butted Seam | | X = 10 E = 20 Q = 25 L = 50 C = 100 |

Metric Ring Terminal, Nylon Insulated – Funnel Entry

Type PMNF-R

- Ring tongue design assures a secure connection in high vibration applications
- Metal insulation grip sleeve crimps to wire insulation, providing protection to the crimp joint during high vibration applications
- Internal barrel serrations assure good wire contact and maximum tensile strength
- Maximum insulation temperature 221°F (105°C)

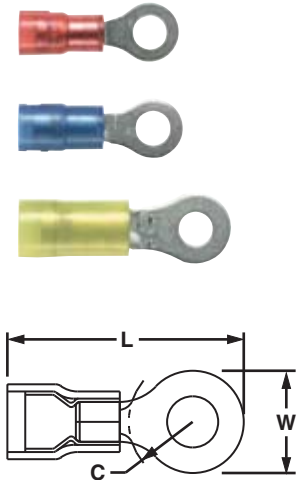

| Part Number | Wire Range (mm ²) | Color Code | Max. Ins. | Stud Size | Figure Dimensions (mm) | | | Recommended Installation Tool | Std. Pkg. Qty. | Std. Ctn. Qty. |
|-------------|-------------------------------|------------|-----------|-----------|------------------------|------|------|-------------------------------|----------------|----------------|
| | | | | | L | W | C | | | |
| PMNF1-3R-C | .5 – 1.5 | Red | 3.76 | M3 | 19.3 | 5.8 | 5.3 | CT-1550, CT-2500 | 100 | 500 |
| PMNF1-4R-C | | | 3.76 | M4 | 21.6 | 7.9 | 6.4 | | 100 | 500 |
| PMNF1-5R-C | | | 3.76 | M5 | 21.8 | 8.9 | 6.4 | | 100 | 500 |
| PMNF1-6R-C | | | 3.76 | M6 | 26.7 | 10.9 | 9.7 | | 100 | 500 |
| PMNF2-3R-C | 1.5 – 2.5 | Blue | 4.11 | M3 | 19.4 | 5.9 | 4.8 | CT-1550, CT-2500 | 100 | 500 |
| PMNF2-4R-C | | | 4.11 | M4 | 21.8 | 7.9 | 7.4 | | 100 | 500 |
| PMNF2-5R-C | | | 4.11 | M5 | 22.4 | 8.9 | 7.4 | | 100 | 500 |
| PMNF2-6R-C | | | 4.11 | M6 | 26.5 | 10.9 | 10.7 | | 100 | 500 |
| PMNF6-3R-L | 2.5 – 6.0 | Yellow | 5.94 | M3 | 26.7 | 5.8 | 9.1 | CT-1550, CT-2500 | 50 | 250 |
| PMNF6-4R-L | | | 5.94 | M4 | 27.4 | 7.9 | 9.1 | | 50 | 250 |
| PMNF6-5R-L | | | 5.94 | M5 | 28.5 | 9.7 | 9.1 | | 50 | 250 |
| PMNF6-6R-L | | | 5.94 | M6 | 30.2 | 10.9 | 10.9 | | 50 | 250 |
| PMNF6-8R-L | | | 5.94 | M8 | 31.5 | 13.2 | 10.9 | | 50 | 250 |

For crimping tool information, see pages D1.84 and D1.88.

A. System Overview

B1. Cable Ties

B2. Cable Accessories

B3. Stainless Steel Ties

C1. Wiring Duct

C2. Surface Raceway

C3. Abrasion Protection

C4. Cable Management

D1. Terminals

D2. Power Connectors

D3. Grounding Connectors

E1. Labeling Systems

E2. Labels

E3. Pre-Printed & Write-On Markers

E4. Permanent Identification

E5. Lockout/Tagout & Safety Solutions

F. Index

A. System Overview

Metric Ring Terminal, Vinyl Insulated – Funnel Entry

B1. Cable Ties

Type PMV-R

- Ring tongue design assures a secure connection in high vibration applications
- Insulation support helps to prevent wire damage in bending applications
- Brazed seam protects terminal barrel from splitting during the crimp process
- Internal barrel serrations assure good wire contact and maximum tensile strength
- Maximum insulation temperature 221°F (105°C)

B2. Cable Accessories

B3. Stainless Steel Ties



C1. Wiring Duct



C2. Surface Raceway



C3. Abrasion Protection

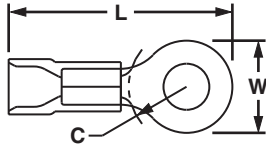

C4. Cable Management

| Part Number | Wire Range (mm ²) | Color Code | Max. Ins. | Stud Size | Figure Dimensions (mm) | | | Recommended Installation Tool | Std. Pkg. Qty. | Std. Ctn. Qty. |
|-------------|-------------------------------|------------|-----------|-----------|------------------------|------|------|-------------------------------|----------------|----------------|
| | | | | | L | W | C | | | |
| PMV1-3RB-CY | .5 – 1.5 | Red | 4.01 | M3 | 20.8 | 5.8 | 5.6 | CT-1550, CT-2500 | 100 | 500 |
| PMV1-4RB-CY | | | 4.01 | M4 | 23.1 | 7.9 | 7.4 | | | |
| PMV1-5RB-CY | | | 4.01 | M5 | 23.1 | 8.9 | 7.4 | | | |
| PMV1-6RB-CY | | | 4.01 | M6 | 28.2 | 10.9 | 10.7 | | | |
| PMV2-3RB-C | 1.5 – 2.5 | Blue | 4.70 | M3 | 20.5 | 5.8 | 6.4 | CT-1550, CT-2500 | 100 | 500 |
| PMV2-4RB-C | | | 4.70 | M4 | 23.1 | 7.9 | 6.4 | | | |
| PMV2-5RB-C | | | 4.70 | M5 | 23.8 | 8.9 | 6.4 | | | |
| PMV2-6RB-C | | | 4.70 | M6 | 25.7 | 10.9 | 9.7 | | | |
| PMV6-3R-L | 2.5 – 6.0 | Yellow | 6.10 | M3 | 26.1 | 5.8 | 7.9 | CT-1550, CT-2500 | 50 | 250 |
| PMV6-4R-L | | | 6.10 | M4 | 26.5 | 7.9 | 7.9 | | | |
| PMV6-5R-L | | | 6.10 | M5 | 27.1 | 9.5 | 7.9 | | | |
| PMV6-6R-L | | | 6.10 | M6 | 30.3 | 10.9 | 9.7 | | | |
| PMV6-7R-L | | | 6.10 | M7 | 31.3 | 11.9 | 9.7 | | | |
| PMV6-8R-L | | | 6.10 | M8 | 31.4 | 13.2 | 9.7 | | | |

For crimping tool information, see page D1.84 and D1.88.

D1. Terminals

Metric Ring Terminal, Non-Insulated

D2. Power Connectors

Type PM-R

- Ring tongue design assures a secure connection in high vibration applications
- Internal barrel serrations assure good wire contact and maximum tensile strength
- Brazed seam protects terminal barrel from splitting during the crimp process
- Barrel of terminal internally beveled to provide quick and easy wire insertion
- Maximum recommended operating temperature 302°F (150°C)

D3. Grounding Connectors

E1. Labeling Systems



E2. Labels



E3. Pre-Printed & Write-On Markers



E4. Permanent Identification

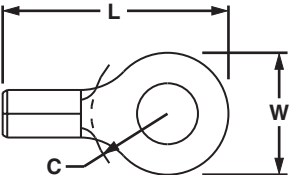

E5. Lockout/Tagout & Safety Solutions

F. Index

| Part Number | Wire Range (mm ²) | Stud Size | Figure Dimensions (mm) | | | Recommended Installation Tool | Std. Pkg. Qty. | Std. Ctn. Qty. |
|-------------|-------------------------------|-----------|------------------------|------|-----|-------------------------------|----------------|----------------|
| | | | L | W | C | | | |
| PM1-3R-C | .5 – 1.5 | M3 | 15.8 | 5.8 | 5.6 | CT-1570, CT-2500 | 100 | 500 |
| PM1-4R-C | | M4 | 18.0 | 7.9 | 7.4 | | | |
| PM1-5R-C | | M5 | 18.0 | 8.9 | 7.4 | | | |
| PM2-3R-C | 1.5 – 2.5 | M3 | 15.8 | 5.8 | 5.6 | CT-1570, CT-2500 | 100 | 500 |
| PM2-4R-C | | M4 | 18.0 | 7.9 | 7.4 | | | |
| PM2-5R-C | | M5 | 18.0 | 8.9 | 7.4 | | | |
| PM6-3R-L | 2.5 – 6.0 | M3 | 19.2 | 5.8 | 7.9 | CT-1570, CT-2500 | 50 | 250 |
| PM6-4R-L | | M4 | 19.8 | 7.9 | 7.9 | | | |
| PM6-5R-L | | M5 | 20.6 | 9.5 | 7.9 | | | |
| PM6-6R-L | | M6 | 23.5 | 10.9 | 9.7 | | | |
| PM6-7R-L | | M7 | 24.7 | 11.9 | 9.7 | | | |
| PM6-8R-L | | M8 | 24.7 | 13.3 | 9.7 | | | |

For crimping tool information, see pages D1.84 and D1.88.

Metric Fork Terminal, Nylon Insulated – Funnel Entry

Type PMNF-F

- Fork design provides for fast and easy installation, without the need to remove fastener
- Metal insulation grip sleeve crimps to wire insulation, providing protection to the crimp joint during high vibration applications
- Internal barrel serrations assure good wire contact and maximum tensile strength
- Maximum insulation temperature 221°F (105°C)

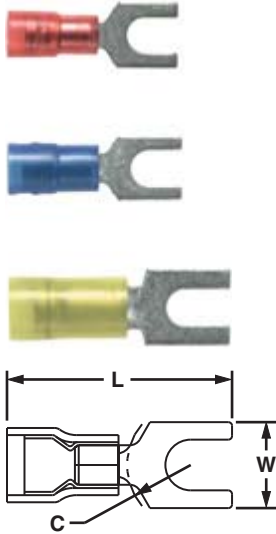

| Part Number | Wire Range (mm²) | Color Code | Max. Ins. | Stud Size | Figure Dimensions (mm) | | | Recommended Installation Tool | Std. Pkg. Qty. | Std. Ctn. Qty. |
|-------------|------------------|------------|-----------|-----------|------------------------|------|-----|-------------------------------|----------------|----------------|
| | | | | | L | W | C | | | |
| PMNF1-3F-C | .5 – 1.5 | Red | 3.76 | M3 | 21.1 | 5.9 | 5.1 | CT-1550, CT-2500 | 100 | 500 |
| PMNF1-4F-C | | | 3.76 | M4 | 22.6 | 8.1 | 5.8 | | 100 | 500 |
| PMNF1-5F-C | | | 3.76 | M5 | 22.9 | 8.9 | 6.4 | | 100 | 500 |
| PMNF1-6F-C | | | 3.76 | M6 | 27.4 | 11.2 | 8.4 | | 100 | 500 |
| PMNF2-3F-C | 1.5 – 2.5 | Blue | 4.11 | M3 | 19.8 | 5.9 | 5.1 | CT-1550, CT-2500 | 100 | 500 |
| PMNF2-4F-C | | | 4.11 | M4 | 21.3 | 7.9 | 5.9 | | 100 | 500 |
| PMNF2-5F-C | | | 4.11 | M5 | 21.9 | 8.6 | 6.4 | | 100 | 500 |
| PMNF2-6F-C | | | 4.11 | M6 | 26.2 | 11.2 | 8.5 | | 100 | 500 |
| PMNF6-4F-L | 2.5 – 6.0 | Yellow | 5.94 | M4 | 27.2 | 7.9 | 6.2 | CT-1550, CT-2500 | 50 | 250 |
| PMNF6-5F-L | | | 5.94 | M5 | 26.9 | 9.5 | 6.2 | | 50 | 250 |
| PMNF6-6F-L | | | 5.94 | M6 | 29.0 | 11.0 | 8.2 | | 50 | 250 |

For crimping tool information, see pages D1.84 and D1.88.

Metric Fork Terminal, Vinyl Insulated – Funnel Entry

Type PMV-F

- Ring tongue design assures a secure connection in high vibration applications
- Insulation support helps to prevent wire damage in bending applications
- Brazed seam protects terminal barrel from splitting during the crimp process
- Internal barrel serrations assure good wire contact and maximum tensile strength
- Maximum insulation temperature 221°F (105°C)

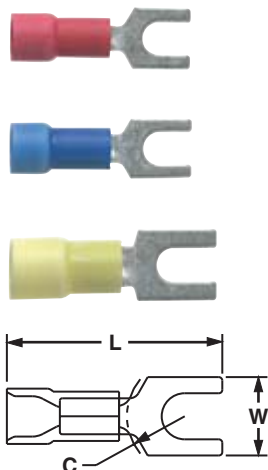

| Part Number | Wire Range (mm²) | Color Code | Max. Ins. | Stud Size | Figure Dimensions (mm) | | | Recommended Installation Tool | Std. Pkg. Qty. | Std. Ctn. Qty. |
|-------------|------------------|------------|-----------|-----------|------------------------|------|-----|-------------------------------|----------------|----------------|
| | | | | | L | W | C | | | |
| PMV1-3FB-CY | .5 – 1.5 | Red | 4.01 | M3 | 21.6 | 5.8 | 4.8 | CT-1550, CT-2500 | 100 | 500 |
| PMV1-4FB-CY | | | 4.01 | M4 | 23.1 | 8.1 | 5.8 | | 100 | 500 |
| PMV1-5FB-CY | | | 4.01 | M5 | 23.6 | 9.1 | 6.1 | | 100 | 500 |
| PMV1-6FB-CY | | | 4.01 | M6 | 27.9 | 11.2 | 8.1 | | 100 | 500 |
| PMV2-3FB-C | 1.5 – 2.5 | Blue | 4.70 | M3 | 21.3 | 5.8 | 4.8 | CT-1550, CT-2500 | 100 | 500 |
| PMV2-4FB-C | | | 4.70 | M4 | 22.9 | 7.9 | 5.8 | | 100 | 500 |
| PMV2-5FB-C | | | 4.70 | M5 | 23.4 | 8.6 | 6.1 | | 100 | 500 |
| PMV2-6FB-C | | | 4.70 | M6 | 27.7 | 11.2 | 8.1 | | 100 | 500 |
| PMV6-4F-L | 2.5 – 6.0 | Yellow | 6.10 | M4 | 26.4 | 8.1 | 5.6 | CT-1550, CT-2500 | 50 | 250 |
| PMV6-5F-L | | | 6.10 | M5 | 26.4 | 9.7 | 5.6 | | 50 | 250 |
| PMV6-6F-L | | | 6.10 | M6 | 29.5 | 10.9 | 8.1 | | 50 | 250 |

For crimping tool information, see pages D1.84 and D1.88.

A. System Overview

B1. Cable Ties

B2. Cable Accessories

B3. Stainless Steel Ties

C1. Wiring Duct

C2. Surface Raceway

C3. Abrasion Protection

C4. Cable Management

D1. Terminals

D2. Power Connectors

D3. Grounding Connectors

E1. Labeling Systems

E2. Labels

E3. Pre-Printed & Write-On Markers

E4. Permanent Identification

E5. Lockout/Tagout & Safety Solutions

F. Index

A. System Overview

Metric Fork Terminal, Non-Insulated

B1. Cable Ties

Type PM-F

- Fork design provides for fast and easy installation, without the need to remove fastener
- Internal barrel serrations assure good wire contact and maximum tensile strength
- Brazed seam protects terminal barrel from splitting during the crimp process
- Barrel of terminal internally beveled to provide quick and easy wire insertion
- Maximum recommended operating temperature 302°F (150°C)

B2. Cable Accessories

B3. Stainless Steel Ties



C1. Wiring Duct

C2. Surface Raceway

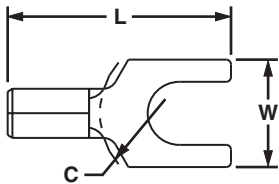

C3. Abrasion Protection

C4. Cable Management

| Part Number | Wire Range (mm ²) | Stud Size | Figure Dimensions (mm) | | | Recommended Installation Tool | Std. Pkg. Qty. | Std. Ctn. Qty. |
|-----------------|-------------------------------|-----------|------------------------|------|-----|-------------------------------|----------------|----------------|
| | | | L | W | C | | | |
| PM1-3F-C | .5 – 1.5 | M3 | 16.0 | 5.8 | 5.6 | CT-1570, CT-2500 | 100 | 500 |
| PM1-4F-C | | M4 | 17.5 | 8.1 | 6.4 | | 100 | 500 |
| PM1-5F-C | | M5 | 18.0 | 8.8 | 6.6 | | 100 | 500 |
| PM2-3F-C | 1.5 – 2.5 | M3 | 16.0 | 5.8 | 5.6 | CT-1570, CT-2500 | 100 | 500 |
| PM2-4F-C | | M4 | 17.5 | 7.9 | 6.4 | | 100 | 500 |
| PM2-5F-C | | M5 | 18.0 | 8.6 | 6.9 | | 100 | 500 |
| PM6-5F-L | 2.5 – 6.0 | M5 | 19.4 | 9.5 | 7.1 | CT-1570, CT-2500 | 50 | 250 |
| PM6-6F-L | | M6 | 22.6 | 10.9 | 8.6 | | 50 | 250 |

For crimping tool information, see pages D1.84 and D1.88.

D1. Terminals

Plastic Box Terminal Kits

- Ideal for maintenance and construction wiring
- Positive latching case prevents accidental opening
- With the case top closed, parts remain in their compartments
- Case features a hanging tab for storage

D2. Power Connectors

D3. Grounding Connectors



KP-1075Y



KP-1165Y

E1. Labeling Systems

E2. Labels

E3. Pre-Printed & Write-On Markers

E4. Permanent Identification

E5. Lockout/Tagout & Safety Solutions

F. Index

| Part Number | Part Description | Std. Pkg. Qty. |
|-----------------|--|----------------|
| KP-1075Y | Terminal kit without crimping tool. Includes the following: (20) PV18-8R; PV18-6F; PV14-8F; PV14-10R; (10) PV10-8R; PV10-10R; DNF14-250; DNF18-250; BSV18X; BSV14X; BSV10X; (5) JN418-212. | 1 |
| KP-1000 | Empty plastic box, twelve terminal compartments and one tool compartment, measures 11" wide x 6 3/4" deep x 1 3/4" high. Positive latch prevents accidental opening. Once top is closed, terminals remain in their compartments. | 1 |
| KP-1165Y | Includes the following: (18) PV18-8R; PV14-10R; PV18-6F; PV14-8F; (10) PV10-8R; PV10-10R; BSV18X; BSV14X; BSV10X; DV18-250B; DV14-188B; (5) JN418-212; (1) CT-160 tool; KP-1000 box. | 1 |
| KP-1166 | Includes the following: (18) P18-8R; P14-10R; P18-6F; P14-8F; (10) P10-8R; P10-10R; BS18; BS14; BS10; D18-250; D14-188; (5) JN218-216; (1) CT-160 tool; KP-1000 box. | 1 |

Steel Kit Boxes

- Latch prevents accidental opening
- Once lid is closed, terminals remain in their compartments
- Handle for portability or as drawer pull when used in rack



- Drop-in label area on front measures: 2.13"H x 13.75"W x 9.75"D (54.0mm x 349.3mm x 247.7mm)

| Part Number | Part Description | Std. Pkg. Qty. |
|-------------|--|----------------|
| K-1000 | Empty steel box, 20 terminal compartments and one tool compartment, dimensions: 2.00"H x 13.33"W x 9.33"D (50.8mm x 338.6mm x 237.0mm). | 1 |
| K-1001 | Empty steel kit box, 15 terminal compartments and two tool compartments, box dimensions: 2.00"H x 13.33"W x 9.33"D (50.8mm x 338.6mm x 237.0mm). | 1 |
| K-1100 | Steel box and CT-100 crimping tool. | 1 |
| K-1102Y | Includes the following: (100) PV18-6LF; PV18-8LF; PV14-8LF; PV14-10LF; BSV18X; BSV14X; (50) PV10-10LF; BSV10X; (1) CT-100 tool; K-1000 box. | 1 |
| K-1103Y | Includes the following: (100) DV18-250B; DV14-250B; DV14-250MB; D18-250; D14-250; (50) DV10-250; D10-250; (1) CT-100 tool; K-1000 box. | 1 |
| K-1104 | Includes the following: (50) PN18-10R; PN14-6R; PN14-10R; PN18-6F; PN14-6F; PN14-10F; (25) PN10-10R; PN10-56R; PN10-10F; BSN14; BSN10; JN418-212; (1) CT-100 tool; K-1000 box. | 1 |

Steel Slide Racks

- Steel boxes for cable tie kits and K-1000 terminal kits
- Steel boxes, storage slide racks, and base can be combined for neat and organized storage of cable ties and terminals

- Rugged and durable steel construction
- Empty boxes, full kits, slide racks and base are purchased according to your application needs



| Part Number | Part Description | Std. Pkg. Qty. |
|-------------|---|----------------|
| SR2 | 2-drawer slide rack to hold K-504 cable tie kit or K-1000 series terminal kit. Dimensions: 6.25"H x 15.25"W x 11.75"D (158.7mm x 387.4mm x 298.5mm) | 1 |
| SR4 | 4-drawer slide rack to hold K-1000 series terminal kit. Dimensions: 11.25"H x 15.25"W x 11.75"D (285.8mm x 387.4mm x 298.5mm) | 1 |
| SR6 | 6-drawer slide rack to hold K-1000 series terminal kit. Dimensions: 16.38"H x 15.25"W x 11.75"D (416.1mm x 387.4mm x 298.5mm) | 1 |

Base and slide racks are sold separately.

| Slide racks will accommodate the following PANDUIT kits: | |
|--|-----------|
| K-1000 | K-1103Y |
| K-1001 | K-1104 |
| K-1100 | K1-PNKIT |
| K-1102Y | K2-PVKITY |

A. System Overview

B1. Cable Ties

B2. Cable Accessories

B3. Stainless Steel Ties

C1. Wiring Duct

C2. Surface Raceway

C3. Abrasion Protection

C4. Cable Management

D1. Terminals

D2. Power Connectors

D3. Grounding Connectors

E1. Labeling Systems

E2. Labels

E3. Pre-Printed & Write-On Markers

E4. Permanent Identification

E5. Lockout/ Tagout & Safety Solutions

F. Index

A.
System
Overview

Industrial Maintenance Kits

B1.
Cable Ties

- Steel kits have individual compartments for storage of terminals
- Once top is closed, terminals remain in their compartments
- Convenient carrying handle

B2.
Cable
Accessories

B3.
Stainless
Steel Ties

C1.
Wiring
Duct

C2.
Surface
Raceway

C3.
Abrasion
Protection

C4.
Cable
Management

D1.
Terminals

D2.
Power
Connectors

D3.
Grounding
Connectors

E1.
Labeling
Systems

E2.
Labels

E3.
Pre-Printed
& Write-On
Markers

E4.
Permanent
Identification

E5.
Lockout/
Tagout/
& Safety
Solutions

F.
Index



K1-PNKIT



K2-PVKITY



K-205

| Part Number | Part Description | Std. Pkg. Qty. |
|-------------|--|----------------|
| K1-PNKIT | <p>Kit contains:</p> <ul style="list-style-type: none"> (1) K-1001 steel kit box (1) CT-260 installation tool <p><u>Cable Ties</u></p> <ul style="list-style-type: none"> (100) PLT2S cable ties <p><u>Terminals</u></p> <ul style="list-style-type: none"> (100) PN14-610R multi-stud terminals (100) PN18-610R multi-stud terminals (100) PN18-6LF locking fork terminals (100) PN14-8LF locking fork terminals (50) PN10-10LF locking fork terminals (100) PN18-8F fork terminals (100) PN14-10R ring terminals (50) PN10-10R ring terminals <p><u>Disconnects</u></p> <ul style="list-style-type: none"> (100) DNF18-250 disconnects (100) DNF14-250 disconnects (50) DV10-250 disconnects <p><u>Splices</u></p> <ul style="list-style-type: none"> (50) BSN18 butt splices (50) BSN14 butt splices (25) BSN10 butt splices <p><u>Marking System</u></p> <ul style="list-style-type: none"> (1) PMD-0-9 marking dispenser and tape (100) MP150 marker tags (1) PX-0 marker | 1 |
| K2-PVKITY | <p>Kit contains:</p> <ul style="list-style-type: none"> (1) K-1001 steel kit box (1) CT-260 installation tool <p><u>Cable Ties</u></p> <ul style="list-style-type: none"> (100) PLT2S cable ties <p><u>Terminals</u></p> <ul style="list-style-type: none"> (100) PV18-8F fork terminals (100) PV18-6LF locking fork terminals (100) PV14-8LF locking fork terminals (50) PV10-10LF locking fork terminals (100) PV18-610R multi-stud terminals (100) PV14-10R ring terminals (50) PV10-10R ring terminals <p><u>Disconnects</u></p> <ul style="list-style-type: none"> (100) DNF18-250 disconnects (100) DV14-250B disconnects (50) DV10-250 disconnects <p><u>Splices</u></p> <ul style="list-style-type: none"> (50) BSV18X butt splices (50) BSV14X butt splices (25) BSV10X butt splices <p><u>Wire Joints</u></p> <ul style="list-style-type: none"> (30) JN224-318 (15) JN314-412 <p><u>Marking System</u></p> <ul style="list-style-type: none"> (1) PMD-0-9 marking dispenser and tape | 1 |
| K-205* | <p>Kit for Indoor Use</p> <p>PAN-Ty® Cable Ties, cable tie installation tool, terminals, splices and crimp tool:</p> <ul style="list-style-type: none"> (1) GTS tool (1) CT-100 crimp tool <p><u>Natural Nylon 6.6 Cable Ties</u></p> <ul style="list-style-type: none"> (100) PLT1M (100) PLT1.5I (100) PLT2S <p><u>Terminals</u></p> <ul style="list-style-type: none"> (100) PV18-6LF (100) PV14-8LF (100) PV14-10LF (50) PV10-10LF <p><u>Splices</u></p> <ul style="list-style-type: none"> (50) BSV10X (100) BSV14X (100) BSV18X | 1 |

*The K-205 does not fit into the SR2, SR4, or SR6.

PAN-TERM® DISCONNECTS

PANDUIT® PAN-TERM® Disconnects are designed and precision made to function as a reliable method of making quick, repeatable interconnections. Available with nylon, premium nylon, vinyl insulation or non-insulated.



- Fully insulated design provides excellent protection from electrical shorts and provides additional installer protection for safety from electrical shocks
- Funnel entry speeds insertion and minimizes turned back wire strands
- Integrated metal insulation grip provides double crimp insulation grip for high vibration or conductor strain environments on select SUPRA-GRIP™ Disconnects and DISCO-LOK™ Disconnects and DISCOGRIP™ Disconnects
- Applicable sizes are UL Listed and CSA Certified, as noted
- Wide assortment of manual, controlled cycle, battery operated hydraulic and pneumatic crimping tools for reliable connections at the lowest installed cost

PANDUIT continually provides new designs to meet the application challenges encountered by our customers. PANDUIT offers a wide assortment of PAN-TERM® termination products at the lowest installed cost.

A.
System
Overview

B1.
Cable Ties

B2.
Cable
Accessories

B3.
Stainless
Steel Ties

C1.
Wiring
Duct

C2.
Surface
Raceway

C3.
Abrasion
Protection

C4.
Cable
Management

D1.
Terminals

D2.
Power
Connectors

D3.
Grounding
Connectors

E1.
Labeling
Systems

E2.
Labels

E3.
Pre-Printed
& Write-On
Markers

E4.
Permanent
Identification

E5.
Lockout/
Tagout/
& Safety
Solutions

F.
Index

A. System Overview

Features and Benefits – PAN-TERM® Disconnects

PAN-TERM® Disconnects are fabricated from brass and are electro tin-plated for a long, corrosion resistant operating life.

B1. Cable Ties

B2. Cable Accessories

B3. Stainless Steel Ties

C1. Wiring Duct

C2. Surface Raceway

C3. Abrasion Protection

C4. Cable Management

Nylon Fully Insulated Female Receptacles and Male Tabs Type DNF-FIB

Available in tab sizes to accommodate .110", .187", .205" or .250" tabs

Fully insulated design provides protection from electrical shorts

Expanded wire entry (on select sizes) accommodates large insulation or multiple wires

Maximum insulation temperature 257°F (125°C)

Insulation support restricts excessive wire movement to minimize stress on crimp joint

Funnel entry for faster wire insertion and lower installed cost



UL and CSA rated up to 600 V per UL 310.

DISCO-GRIP™ Premium Nylon Fully Insulated Female Receptacles and Male Tabs Type DNF and DPF

Available in tab sizes to accommodate .110", .187", .205" or .250" tabs

Fully insulated design provides protection from electrical shorts

Maximum insulation temperature 221°F (105°C)

Funnel entry for faster wire insertion and lower installed cost



UL and CSA rated up to 600 V per UL 310.

Male products available .250" width in standard and oversized housing configurations.

D1. Terminals

D2. Power Connectors

D3. Grounding Connectors

E1. Labeling Systems

E2. Labels

E3. Pre-Printed & Write-On Markers

E4. Permanent Identification

E5. Lockout/Tagout & Safety Solutions

F. Index

SUPRA-GRIP™ Nylon Fully Insulated Female Disconnects Type DNG-FB

Available in tab sizes to accommodate .187" or .250" tabs

Fully insulated design provides protection from electrical shorts

Maximum insulation temperature 221°F (105°C)

Funnel entry for faster wire insertion and lower installed cost

Fully integrated metal insulation grip for high vibration, high strain relief, and double crimp requirements



UL and CSA rated up to 600 V per UL 310.

DISCO-LOK™ Nylon Fully Insulated Locking Female Disconnects Type DNG-FL

Available in tab sizes to accommodate .250" tabs

Unique locking mechanism allows for low insertion forces (mating) and positive locking for secure connections

Maximum insulation temperature 221°F (105°C)

Funnel entry for faster wire insertion and lower installed cost

Insulation grip sleeve provides a superior insulation crimp for high vibration and high strain relief applications



UL and CSA rated up to 300 V.



PANDUIT extensive line of tooling is specifically designed for optimum crimping performance.

See pages D1.83 – D1.88.



PANDUIT designs and manufactures a full line of labeling products, software, and printers to assist you with your labeling requirements.

See pages E1.1 – E2.30.

Features and Benefits – PAN-TERM® Disconnects (continued)

Nylon Barrel Insulated Female Receptacles and Male Tabs Type DNF

Available in tab sizes to accommodate .110", .187", .205" or .250" tabs

Maximum insulation temperature 221°F (105°C)

Funnel entry for faster wire insertion and lower installed cost

Insulation grip sleeve provides a superior insulation crimp for high vibration and high strain relief applications



UL and CSA rated up to 300 V.
Male products available .250" width.

Vinyl Barrel Insulated Female Receptacles and Male Tabs Type DV and DVF

Available in tab sizes to accommodate .187", .205", or .250" tabs

Maximum insulation temperature 221°F (105°C)

Insulation support to protect electrical crimp

Insulation grip sleeve provides a superior insulation crimp for high vibration and high strain relief applications



UL and CSA rated up to 600 V.
Male products available .250" width.
Flammability – UL 94V-0.

Non-Insulated Female Receptacles and Male Tabs Type D

Available in tab sizes to accommodate .187" or .250" tabs

Sleeved barrel assures crimp reliability

Maximum recommended operating temperature 302°F (150°C)



Male products available .250" width.

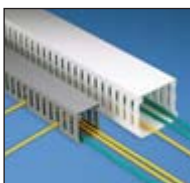

PANDUIT wiring duct offers a wide variety of sizes and types to meet the wire capacity needs and space constraints of the smallest wall mounted to the largest integrated systems.

See pages C1.1 – C1.52.



A comprehensive selection of cable ties used to bundle, mount, and identify wire and cable.

See pages B1.1 – B1.122.

A. System Overview

B1. Cable Ties

B2. Cable Accessories

B3. Stainless Steel Ties

C1. Wiring Duct

C2. Surface Raceway

C3. Abrasion Protection

C4. Cable Management

D1. Terminals

D2. Power Connectors

D3. Grounding Connectors

E1. Labeling Systems

E2. Labels

E3. Pre-Printed & Write-On Markers

E4. Permanent Identification

E5. Lockout/ Tagout & Safety Solutions

F. Index

A. System Overview

Selection Guide – PAN-TERM® Disconnects

B1. Cable Ties

B2. Cable Accessories

B3. Stainless Steel Ties

C1. Wiring Duct

C2. Surface Raceway

C3. Abrasion Protection

C4. Cable Management

D1. Terminals

D2. Power Connectors

D3. Grounding Connectors

E1. Labeling Systems

E2. Labels

E3. Pre-Printed & Write-On Markers

E4. Permanent Identification

E5. Lockout/Tagout & Safety Solutions

F. Index

| Material | Style | Design | Feature | Type | Page Number |
|---------------|-------------------------|--------------------|------------------------------------|----------|-------------------------|
| Nylon | Fully Insulated | Female | Funnel Entry, Ins. Grip | DNG-FB | D1.43 |
| | | Female | Funnel, Ins. Grip, Locking | DNG-FL | D1.44 |
| | | Female | Funnel, Ins. Support, Two-Pc. | DNF-FIB | D1.45 |
| | | Female | Funnel, Ins. Support, Three-Pc. | DNF-FI | D1.45 |
| | | Female | Funnel Entry, Premium Nylon | DPF-FIB | D1.46 |
| | | Male | Funnel, Ins. Support, Two-Pc. | DNF-FIM | D1.44 |
| | | Male | Premium Nylon | DPF-FIM | D1.46 |
| | | Female Right Angle | Funnel Entry, Ins. Support | DNFR-FIB | D1.49 |
| | | Female Right Angle | Funnel Entry, Open Top | DNFR-B | D1.50 |
| | | Nylon | Barrel Insulated | Female | Funnel Entry, Ins. Grip |
| Male | Funnel Entry, Ins. Grip | | | DNF-M | D1.52 |
| Vinyl | Barrel Insulated | Female | Funnel Entry, Ins. Grip, Three-Pc. | DVF | D1.48 |
| | | Female | Funnel Entry, Butted Seam, Two-Pc. | DV-B | D1.48 |
| | | Male | Funnel Entry, Butted Seam, Two-Pc. | DV-MB | D1.52 |
| | | Piggyback | Funnel Entry, Ins. Grip | DV-P | D1.51 |
| Heat Shrink | Fully Insulated | Female | Heat Shrink Insulated | DNH-FIB | D1.47 |
| | | Male | Heat Shrink Insulated | DNH-FIM | D1.47 |
| Non-Insulated | | Female | Sleeved Barrel | D | D1.49 |
| | | Female Right Angle | Sleeved Barrel | DR | D1.50 |
| | | Female Right Angle | Butted Seam | DR-B | D1.51 |
| | | Male | Butted Seam | D-MB | D1.53 |
| | | Adapter | Two Female to One Male | D-A | D1.51 |

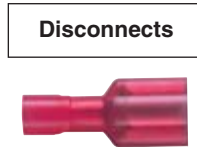

Part Number System for PAN-TERM® Disconnects

| D | NF | — | 14 | 250 | FIB | — | M |
|-----------------|---|---|---------------|------------------------|---|---|-----------------------|
| Type | Insulation | | Wire Range | Tab Size | Special Configuration | | Standard Package Size |
| D = Disconnects | N = Nylon | | 18 = #22 – 18 | 110 = .110 x .032 | A = Adapter | | L = 50 |
| | NF = Nylon, Funnel Entry | | 14 = #16 – 14 | 111 = .110 x .020 | B = Butted Seam | | C = 100 |
| | NFR = Nylon, Funnel Entry, Right Angle | | 10 = #12 – 10 | 145 = .145 x .032 | FB = Metal Insulation Grip, Female | | D = 500 |
| | NG = Nylon, Funnel Entry, Metal Insulation Grip | | | 187 = .187 x .032 | FI = Fully Insulated, Female | | M = 1000 |
| | | | | 188 = .187 x .020 | FIB = Fully Insulated, Butted Seam, Female | | |
| | | | | 205 = .187/.205 x .032 | FIM = Fully Insulated, Male | | |
| | PF = Premium Grade Nylon, Funnel Entry | | | 206 = .187/.205 x .020 | FIMB = Fully Insulated, Male with Oversized Housing | | |
| | R = Non-insulated, Right Angle | | | 250 = .250 x .032 | FL = Locking, Metal Insulation Grip, Female | | |
| | V = Vinyl | | | | M = Male | | |
| | = Non-Insulated (leave blank) | | | | = Female (leave blank) | | |
| | | | | | P = Piggyback | | |

UL LISTED CERTIFIED SUPRA-GRIP™ Female Disconnect, Nylon Fully Insulated – Funnel Entry

Type DNG-FB

- Disconnect can be inserted and removed from the male tab without the use of tools for lower installed cost
- Flared barrel extension integrated into stamping to provide insulation grip for double crimp requirements
- Internal barrel serrations assure good wire contact and maximum tensile strength
- Internal wire stop assures proper length of insertion into terminal barrel, providing a higher-quality connection
- Mates with DNF-FIMB Family

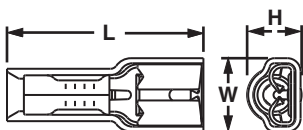

| Part Number | Wire Range | Color Code | Max. Ins. | Figure Dimensions (In.) | | | Tab Size | Recommended Installation Tool | Std. Pkg. Qty.** | Std. Ctn. Qty. |
|----------------|-------------|------------|-----------|-------------------------|-----|-----|-------------|-------------------------------|------------------|----------------|
| | | | | L | W | H | | | | |
| DNG18-187FB-C | 22 – 18 AWG | Red | .126 | .89 | .29 | .22 | .187 x .032 | CT-1015 | 100 | 1000 |
| DNG18-188FB-C | | | .126 | .89 | .29 | .22 | .187 x .020 | | 100 | 1000 |
| DNG18-250FB-C | | | .126 | .93 | .35 | .22 | .250 x .032 | | 100 | 1000 |
| DNG14-187FB-C* | 16 – 14 AWG | Blue | .153 | .89 | .29 | .25 | .187 x .032 | CT-1015 | 100 | 1000 |
| DNG14-188FB-C* | | | .153 | .89 | .29 | .25 | .187 x .020 | | 100 | 1000 |
| DNG14-250FB-C | | | .153 | .93 | .35 | .25 | .250 x .032 | | 100 | 1000 |

*UL Recognized for use with copper alloy tabs.

**To order in bulk, replace -C in the part number with -M for a bulk package of 1000.

For crimping tool information, see page D1.84.

A. System Overview

B1. Cable Ties

B2. Cable Accessories

B3. Stainless Steel Ties

C1. Wiring Duct

C2. Surface Raceway

C3. Abrasion Protection

C4. Cable Management

D1. Terminals

D2. Power Connectors

D3. Grounding Connectors

E1. Labeling Systems

E2. Labels

E3. Pre-Printed & Write-On Markers

E4. Permanent Identification

E5. Lockout/Tagout & Safety Solutions

F. Index

A. System Overview

UL® DISCO-LOK™ Female Disconnect, Nylon Fully Insulated – Funnel Entry

Type DNG-FL

- Disconnect can be inserted and removed from the male tab without the use of tools for lower installed cost
- Unique locking mechanism design allows for low insertion forces (mating) and positive lock for high vibration applications where a secure connection is mandatory
- Fully insulated design provides protection from electrical shorts
- Flared barrel extension integrated into stamping to provide insulation grip for double crimp requirements
- Insulation housing moves back and forth to engage and disengage locking mechanism for repeated use.
- Specialty tool required to install this disconnect (CT-1014)
- Mates with DNF-FIMB family

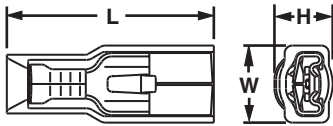

| Part Number | Wire Range | Color Code | Max. Ins. | Figure Dimensions (In.) | | | Tab Size | Recommended Installation Tool | Std. Pkg. Qty.** | Std. Ctn. Qty. |
|----------------------|------------|------------|-----------|-------------------------|-----|-----|-------------|-------------------------------|------------------|----------------|
| | | | | L | W | H | | | | |
| DNG18-250FL-C | 22–18 AWG | Red | .126 | .97 | .36 | .24 | .250 x .032 | CT-1014 | 100 | 1000 |
| DNG14-250FL-C | 16–14 AWG | Blue | .150 | .97 | .36 | .25 | .250 x .032 | CT-1014 | 100 | 1000 |

**To order in bulk, replace -C in the part number with -M for a bulk package of 1000. For crimping tool information, see page D1.84.

B1. Cable Ties

B2. Cable Accessories

B3. Stainless Steel Ties

C1. Wiring Duct

C2. Surface Raceway

C3. Abrasion Protection

C4. Cable Management

UL® DISCO-LOK™ Male/Female Coupler, Nylon Fully Insulated – Funnel Entry

Type DNF

- Disconnect can be inserted and removed from the male tab without the use of tools for lower installed cost
- Fully insulated design provides protection from electrical shorts
- Metal insulation grip sleeve crimps to wire insulation, providing protection to the crimp joint during high vibration applications
- Internal barrel serrations assure good wire contact and maximum tensile strength
- Internal wire stop assures proper length of insertion into terminal barrel, providing a higher quality connection
- UL Flammability UL 94V-2/HB, maximum insulation temperature 221°F (105°C)
- Coupler, male, and female parts sold separately

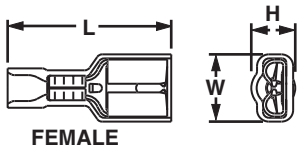
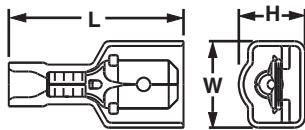

| Part Number | Wire Range | Color Code | Max. Ins. | Figure Dimensions (In.) | | | Tab Size | Recommended Installation Tool | Std. Pkg. Qty.** | Std. Ctn. Qty. |
|------------------------------|-------------|------------|-----------|-------------------------|-----|-----|-------------|---|--|----------------|
| | | | | L | W | H | | | | |
| DNF18-250FIM-C Male | 22 – 18 AWG | Red | .133 | .90 | .42 | .27 | .250 x .032 | CT-100‡, CT-600-A, CT-1525‡, CT-2500‡ | 100 | 1000 |
| DNF18-250FIMB-L Male | | | .136 | .91 | .45 | .34 | .250 x .032 | | 50 | 500 |
| DNF18-250FIB-C Female | | | .136 | .84 | .35 | .22 | .250 x .032 | CT-100, CT-600-A, CT-1525‡, CT-2500‡ | 100 | 1000 |
| DNF14-250FIM-C Male | 16 – 14 AWG | Blue | .158 | .90 | .42 | .27 | .250 x .032 | CT-600-A, CT-1525‡, CT-2500‡ | 100 | 1000 |
| DNF14-250FIMB-L Male | | | .160 | .91 | .45 | .34 | .250 x .032 | | 50 | 500 |
| DNF14-250FIB-C Female | | | .160 | .84 | .35 | .22 | .250 x .032 | CT-100, CT-600-A, CT-1525‡, CT-2500‡ | 100 | 1000 |
| DNF10-250FIMB-L Male | 12 – 10 AWG | Yellow | .220 | .96 | .45 | .36 | .250 x .032 | CT-600-A‡, CT-1550‡, CT-1551‡, CT-2500‡ | 50 | 500 |
| DNF10-250FI-L Female | | | .220 | .95 | .36 | .27 | .250 x .032 | | CT-100‡, CT-600-A‡, CT-1550‡, CT-1551‡, CT-2500‡ | 50 |

**To order in bulk, replace -C in the part number with -M for a bulk package of 1000 and replace -L with -D for a bulk package of 500.
‡UL and CSA approved tooling/product combinations. For crimping tool information, see pages D1.83, D1.84, D1.86 and D1.88.



Female Disconnect,, Nylon Fully Insulated – Funnel Entry

Type DNF-FIB

- Disconnect can be inserted and removed from the male tab without the use of tools for lower installed cost
- Premium nylon insulation retains its shape when crimped and provides a tight grip around the wire insulation for maximum strain relief
- Fully insulated design provides protection from electrical shorts
- Internal wire stop assures proper length of insertion into terminal barrel, providing a higher quality connection
- Disconnects available in common industry tab sizes
- UL and CSA rated up to 600 V per UL 310



| Part Number | Wire Range | Color Code | Max. Ins. | Figure Dimensions (In.) | | | Tab Size | Recommended Installation Tool | Std. Pkg. Qty.** | Std. Ctn. Qty. |
|-----------------------|-------------|------------|-----------|-------------------------|-----|-----|------------------|--------------------------------------|------------------|----------------|
| | | | | L | W | H | | | | |
| DNF18-110FIB-C | 22 – 18 AWG | Red | .120 | .71 | .19 | .16 | .110 x .032 | CT-100, CT-600-A, CT-1525‡, CT-2500‡ | 100 | 1000 |
| DNF18-111FIB-C | | | .120 | .71 | .19 | .16 | .110 x .020 | | 100 | 1000 |
| DNF18-187FIB-C | | | .136 | .78 | .29 | .16 | .187 x .032 | | 100 | 1000 |
| DNF18-188FIB-C | | | .136 | .78 | .29 | .16 | .187 x .020 | | 100 | 1000 |
| DNF18-205FIB-C | | | .136 | .78 | .31 | .22 | .205/.187 x .032 | | 100 | 1000 |
| DNF18-206FIB-C | | | .136 | .78 | .31 | .22 | .205/.187 x .020 | | 100 | 1000 |
| DNF18-250FIB-C | 16 – 14 AWG | Blue | .136 | .84 | .35 | .22 | .250 x .032 | CT-100, CT-600-A, CT-1525‡, CT-2500‡ | 100 | 1000 |
| DNF14-187FIB-C | | | .160 | .78 | .29 | .18 | .187 x .032 | | 100 | 1000 |
| DNF14-188FIB-C | | | .160 | .78 | .29 | .18 | .187 x .020 | | 100 | 1000 |
| DNF14-205FIB-C | | | .160 | .78 | .31 | .22 | .205/.187 x .032 | | 100 | 1000 |
| DNF14-206FIB-C | | | .160 | .78 | .31 | .22 | .205/.187 x .020 | | 100 | 1000 |
| DNF14-250FIB-C | 12 – 10 AWG | Yellow | .160 | .84 | .35 | .22 | .250 x .032 | CT-1525‡, CT-2500‡ | 100 | 1000 |
| DNF10-250FIB-L | | | .220 | .96 | .35 | .23 | .250 x .032 | | 50 | 500 |

**To order in bulk, replace -C in the part number with -M for a bulk package of 1000 and replace -L with -D for a bulk package of 500.

‡UL and CSA approved tooling/product combinations. For crimping tool information, see pages D1.83, D1.84, D1.86 and D1.88.



Female Disconnect, Nylon Fully Insulated – Funnel Entry, Metal Collar

Type DNF-FI

- Disconnect can be inserted and removed from the male tab without the use of tools for lower installed cost
- Fully insulated design provides protection from electrical shorts
- Internal wire stop assures proper length of insertion into terminal barrel, providing a higher quality connection
- Barrel design with larger outside diameter for use with more common hand tools
- UL and CSA rated up to 600 V per UL 310

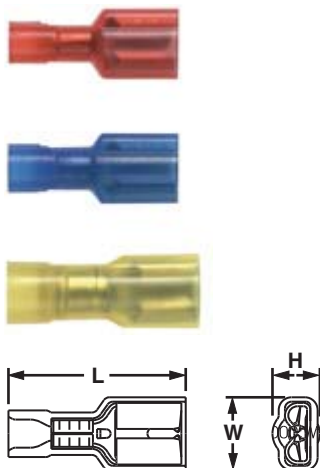

| Part Number | Wire Range | Color Code | Max. Ins. | Figure Dimensions (In.) | | | Tab Size | Recommended Installation Tool | Std. Pkg. Qty.** | Std. Ctn. Qty. |
|----------------------|-------------|------------|-----------|-------------------------|-----|-----|-------------|--|------------------|----------------|
| | | | | L | W | H | | | | |
| DNF18-250FI-C | 22 – 18 AWG | Red | .140 | .94 | .36 | .21 | .250 x .032 | CT-100, CT-600-A, CT-1550, CT-1551, CT-2500 | 100 | 1000 |
| DNF14-250FI-C | 16 – 14 AWG | Blue | .160 | .94 | .36 | .24 | .250 x .032 | | 100 | 1000 |
| DNF10-250FI-L | 12 – 10 AWG | Yellow | .220 | .95 | .36 | .27 | .250 x .032 | CT-100‡, CT-600-A‡, CT-1550‡, CT-1551‡, CT-2500‡ | 50 | 500 |

**To order in bulk, replace -C in the part number with -M for a bulk package of 1000 and replace -L with -D for a bulk package of 500.

‡UL and CSA approved tooling/product combination. For crimping tool information, see pages D1.83, D1.84, D1.86 and D1.88.

A. System Overview

B1. Cable Ties

B2. Cable Accessories

B3. Stainless Steel Ties

C1. Wiring Duct

C2. Surface Raceway

C3. Abrasion Protection

C4. Cable Management

D1. Terminals

D2. Power Connectors

D3. Grounding Connectors

E1. Labeling Systems

E2. Labels

E3. Pre-Printed & Write-On Markers

E4. Permanent Identification

E5. Lockout/Tagout & Safety Solutions

F. Index

A. System Overview

B1. Cable Ties

B2. Cable Accessories

B3. Stainless Steel Ties

C1. Wiring Duct

C2. Surface Raceway

C3. Abrasion Protection

C4. Cable Management

D1. Terminals

D2. Power Connectors

D3. Grounding Connectors

E1. Labeling Systems

E2. Labels

E3. Pre-Printed & Write-On Markers

E4. Permanent Identification

E5. Lockout/Tagout & Safety Solutions

F. Index

DISCOGRIP™ Male Disconnect, Premium Nylon Fully Insulated – Funnel Entry

Type DPF-FIM

- Disconnect can be inserted and removed from the male tab without the use of tools for lower installed cost
- Premium nylon insulation retains its shape when crimped and provides a tight grip around the wire insulation for maximum strain relief
- Fully insulated design provides protection from electrical shorts
- Oversized housing designed for maximum versatility to mate with most commercially available fully insulated female disconnects
- Internal wire stop assures proper length of insertion into terminal barrel, providing a higher quality connection
- UL and CSA rated up to 600 V per UL 310

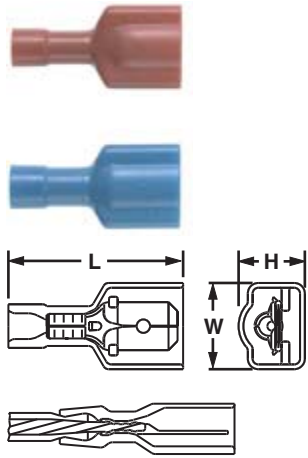

| Part Number | Wire Range | Color Code | Max. Ins. | Figure Dimensions (In.) | | | Tab Size | Recommended Installation Tool | Std. Pkg. Qty.** | Std. Ctn. Qty. |
|-------------------------|-------------|------------|-----------|-------------------------|-----|-----|-------------|-------------------------------|------------------|----------------|
| | | | | L | W | H | | | | |
| DPF18-250FIM-C | 22 – 18 AWG | Red | .133 | .90 | .41 | .29 | .250 x .032 | CT-600-A, CT-1525, CT-2500 | 100 | 1000 |
| DPF14-250FIM-C | 16 – 14 AWG | Blue | .156 | .90 | .41 | .29 | .250 x .032 | | 100 | 1000 |
| DPF18-250FIMB-L* | 22 – 18 AWG | Red | .133 | .92 | .46 | .34 | .250 x .032 | | 50 | 500 |
| DPF14-250FIMB-L* | 16 – 14 AWG | Blue | .156 | .92 | .46 | .34 | .250 x .032 | | 50 | 500 |

*Oversized housing design will mate with receptacles up to .390" wide and .235" (.285" high for parts with orientation bump).
 **To order in bulk, replace -C in the part number with -M for a bulk package of 1000 and replace -L with -D for a bulk package of 500.
 For crimping tool information, see pages D1.84, D1.86, and D1.88.

DISCOGRIP™ Female Disconnect, Premium Nylon Fully Insulated – Funnel Entry

Type DPF-FIB

- Disconnect can be inserted and removed from the male tab without the use of tools for lower installed cost
- Premium nylon insulation retains its shape when crimped and provides a tight grip around the wire insulation for maximum strain relief
- Fully insulated design provides protection from electrical shorts
- Internal wire stop assures proper length of insertion into terminal barrel, providing a higher quality connection
- Disconnects available in common industry tab sizes
- UL and CSA rated up to 600 V per UL 310

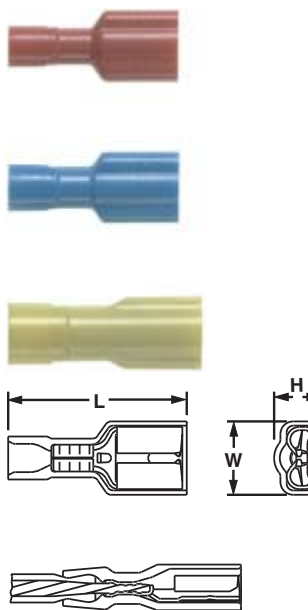

| Part Number | Wire Range | Color Code | Max. Ins. | Figure Dimensions (In.) | | | Tab Size | Recommended Installation Tool | Std. Pkg. Qty.** | Std. Ctn. Qty. |
|-----------------------|-------------|------------|-----------|-------------------------|-----|-----|------------------|-------------------------------|------------------|----------------|
| | | | | L | W | H | | | | |
| DPF18-110FIB-C | 22 – 18 AWG | Red | .132 | .71 | .19 | .16 | .110 x .032 | CT-600-A‡, CT-1525‡, CT-2500‡ | 100 | 1000 |
| DPF18-111FIB-C | | | .132 | .71 | .19 | .16 | .110 x .020 | | 100 | 1000 |
| DPF18-205FIB-C | | | .133 | .78 | .31 | .22 | .205/.187 x .032 | | 100 | 1000 |
| DPF18-206FIB-C | | | .133 | .78 | .31 | .22 | .205/.187 x .020 | | 100 | 1000 |
| DPF18-250FIB-C | | | .133 | .84 | .35 | .22 | .250 x .032 | | 100 | 1000 |
| DPF14-205FIB-C | 16 – 14 AWG | Blue | .156 | .78 | .31 | .22 | .205/.187 x .032 | CT-600-A‡, CT-1525‡, CT-2500‡ | 100 | 1000 |
| DPF14-206FIB-C | | | .156 | .78 | .31 | .22 | .205/.187 x .020 | | 100 | 1000 |
| DPF14-250FIB-C | | | .156 | .84 | .35 | .22 | .250 x .032 | | 100 | 1000 |
| DPF10-250FI-L* | 12 – 10 AWG | Yellow | .218 | .95 | .36 | .27 | .250 x .032 | CT-600-A‡, CT-1525‡, CT-2500‡ | 50 | 500 |
| DPF10-250FIB-L | | | .220 | .96 | .35 | .23 | .250 x .032 | | 50 | 500 |

*Not UL listed or CSA approved.
 **To order in bulk, replace -C in the part number with -M for a bulk package of 1000 and replace -L with -D for a bulk package of 500.
 ‡UL and CSA approved tooling/product combinations. For crimping tool information, see pages D1.84, D1.86, and D1.88.

Heat Shrink Disconnects, Fully Insulated – Funnel Entry

Type DNH

- Disconnect can be inserted and removed from the male tab without the use of tools for lower installed cost
- Heat shrink polyolefin sleeve with hot melt adhesive protects against moisture
- Heat shrink sleeving forms a protective barrier to provide environmentally sealed terminations ideal for high moisture applications
- Heat shrink sleeving provides additional level of strain relief for the wire
- Minimum continuous operating temperature -65°F (-55°C)
- Maximum continuous operation temperature 230°F (110°C)
- Shrink temperature 250°F (120°C)

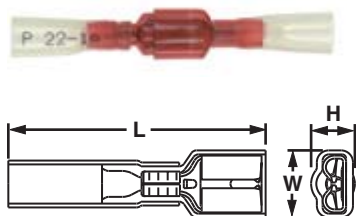

| Part Number | Wire Range | Color Code | Max. Ins. | Figure Dimensions (In.) | | | Type | Wire Strip Length | Recommended Installation Tool | Std. Pkg. Qty. | Std. Ctn. Qty. |
|----------------|-------------|------------|-----------|-------------------------|-----|-----|--------|-------------------|-------------------------------|----------------|----------------|
| | | | | L | W | H | | | | | |
| DNH18-250FIM-Q | 22 – 18 AWG | Red | .133 | 1.50 | .41 | .31 | Male | 5/16 | CT-310 | 25 | 125 |
| DNH18-250FIB-Q | | | .132 | 1.44 | .35 | .22 | Female | | | | |
| DNH14-250FIM-Q | 16 – 14 AWG | Blue | .158 | 1.50 | .41 | .31 | Male | | | 25 | 125 |
| DNH14-250FIB-Q | | | .156 | 1.44 | .35 | .22 | Female | | | | |
| DNH10-250FI-E | 12 – 10 AWG | Yellow | .230 | 1.44 | .35 | .27 | Female | | | 20 | 100 |

For crimping tool information, see page D1.85.

Female Disconnect, Nylon Barrel Insulated – Funnel Entry

Type DNF

- Disconnect can be inserted and removed from the male tab without the use of tools for lower installed cost
- Fully insulated design provides protection from electrical shorts
- Metal insulation grip sleeve crimps to wire insulation, providing protection to the crimp joint during high vibration applications
- Internal barrel serrations assure good wire contact and maximum tensile strength
- Internal wire stop assures proper length of insertion into terminal barrel, providing a higher quality connection
- UL Flammability UL 94V-2/HB, maximum insulation temperature 194°F (90°C)

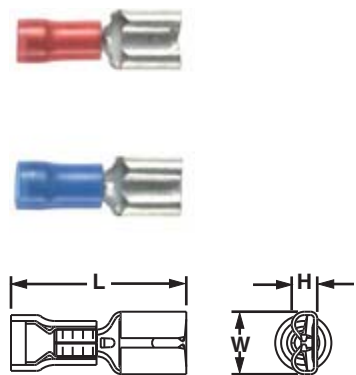

| Part Number | Wire Range | Color Code | Max. Ins. | Figure Dimensions (In.) | | | Tab Size | Recommended Installation Tool | Std. Pkg. Qty.** | Std. Ctn. Qty. | | |
|--------------|-------------|------------|-------------|-------------------------|------|-----|------------------|--------------------------------------|------------------|--------------------------------------|-----|-------------|
| | | | | L | W | H | | | | | | |
| DNF18-110-C | 22 – 18 AWG | Red | .100 | .69 | .15 | .08 | .110 x .032 | CT-600-A‡, CT-1525‡, CT-2500‡ | 100 | 500 | | |
| DNF18-111-C | | | .100 | .69 | .15 | .07 | .110 x .020 | | | | | |
| DNF18-187-C | | | .137 | .76 | .23 | .10 | .187 x .032 | CT-600-A‡, CT-1550, CT-1551, CT-2500 | 100 | 500 | | |
| DNF18-188-C | | | .137 | .76 | .23 | .10 | .187 x .020 | | | | | |
| DNF18-205-C | | | .137 | .76 | .25 | .12 | .205/.187 x .032 | | | | | |
| DNF18-206-C | | | .137 | .76 | .25 | .12 | .205/.187 x .020 | | | | | |
| DNF18-250-C | | | .138 | .81 | .29 | .12 | .250 x .032 | | | | | |
| DNF14-110-C* | | | 16 – 14 AWG | Blue | .162 | .75 | .15 | | | | .08 | .110 x .032 |
| DNF14-111-C* | | | | | .162 | .75 | .15 | .07 | .110 x .020 | | | |
| DNF14-187-C | | | | | .162 | .76 | .23 | .10 | .187 x .032 | CT-600-A‡, CT-1550, CT-1551, CT-2500 | 100 | 500 |
| DNF14-188-C | .162 | .76 | | | .23 | .10 | .187 x .020 | | | | | |
| DNF14-205-C | .162 | .76 | | | .25 | .12 | .205/.187 x .032 | | | | | |
| DNF14-206-C | .162 | .76 | | | .25 | .12 | .205/.187 x .020 | | | | | |
| DNF14-250-C | .162 | .83 | | | .29 | .12 | .250 x .032 | | | | | |

*Not UL Listed or CSA Certified.

**To order in bulk, replace -C in the part number with -M for a bulk package of 1000.

‡UL and CSA approved tooling/product combinations. For crimping tool information, see pages D1.84, D1.86, and D1.88.

A. System Overview

B1. Cable Ties



Female Disconnect, Vinyl Barrel Insulated – Funnel Entry

Type DVF

- Disconnect can be inserted and removed from the male tab without the use of tools for lower installed cost
- Metal insulation grip sleeve crimps to wire insulation, providing protection to the crimp joint during high vibration applications
- Internal barrel serrations assure good wire contact and maximum tensile strength
- Internal wire stop assures proper length of insertion into terminal barrel, providing a higher quality connection
- UL Flammability UL 94V-0, maximum insulation temperature 194°F (90°C)

B2. Cable Accessories

B3. Stainless Steel Ties



C1. Wiring Duct



C2. Surface Raceway

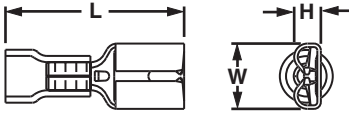

C3. Abrasion Protection

| Part Number | Wire Range | Color Code | Max. Ins. | Figure Dimensions (In.) | | | Tab Size | Recommended Installation Tool | Std. Pkg. Qty.** | Std. Ctn. Qty. |
|---------------------|-------------|------------|-----------|-------------------------|-----|-----|------------------|-------------------------------|------------------|----------------|
| | | | | L | W | H | | | | |
| DVF18-187-CY | 22 – 18 AWG | Red | .137 | .76 | .23 | .10 | .187 x .032 | CT-1550‡, CT-1551‡, CT-2500‡ | 100 | 500 |
| DVF18-188-CY | | | .137 | .76 | .23 | .10 | .187 x .020 | | 100 | 500 |
| DVF18-205-CY | | | .137 | .76 | .25 | .12 | .205/.187 x .032 | | 100 | 500 |
| DVF18-206-CY | | | .137 | .76 | .25 | .12 | .205/.187 x .020 | | 100 | 500 |
| DVF18-250-CY | | | .137 | .81 | .29 | .12 | .250 x .032 | | 100 | 500 |
| DVF14-187-C | 16 – 14 AWG | Blue | .162 | .76 | .23 | .10 | .187 x .032 | CT-1550‡, CT-1551‡, CT-2500‡ | 100 | 500 |
| DVF14-188-C | | | .162 | .76 | .23 | .10 | .187 x .020 | | 100 | 500 |
| DVF14-205-C | | | .162 | .76 | .25 | .12 | .205/.187 x .032 | | 100 | 500 |
| DVF14-206-C | | | .162 | .76 | .25 | .12 | .205/.187 x .020 | | 100 | 500 |
| DVF14-250-C | | | .162 | .81 | .29 | .12 | .250 x .032 | | 100 | 500 |

**To order in bulk, replace -C or -CY in the part number with -M or -MY for a bulk package of 1000.

‡UL and CSA approved tooling/product combinations. For crimping tool information, see pages D1.84 and D1.88.

C4. Cable Management

D1. Terminals



Female Disconnect, Vinyl Barrel Insulated – Butted Seam

Type DV-B

- Disconnect can be inserted and removed from the male tab without the use of tools for lower installed cost
- Metal insulation grip sleeve crimps to wire insulation, providing protection to the crimp joint during high vibration applications
- Internal barrel serrations assure good wire contact and maximum tensile strength
- Internal wire stop assures proper length of insertion into terminal barrel, providing a higher quality connection
- UL Flammability UL 94V-0, maximum insulation temperature 221°F (105°C)

D2. Power Connectors

D3. Grounding Connectors



E1. Labeling Systems



E2. Labels



E3. Pre-Printed & Write-On Markers

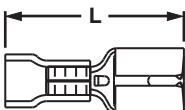

E4. Permanent Identification

E5. Lockout/Tagout & Safety Solutions

F. Index

| Part Number | Wire Range | Color Code | Max. Ins. | Figure Dimensions (In.) | | | Tab Size | Recommended Installation Tool | Std. Pkg. Qty.** | Std. Ctn. Qty. |
|---------------------|-------------|------------|-----------|-------------------------|-----|-----|------------------|-------------------------------|------------------|----------------|
| | | | | L | W | H | | | | |
| DV18-187B-CY | 22 – 18 AWG | Red | .150 | .75 | .23 | .10 | .187 x .032 | CT-1525‡, CT-2500‡ | 100 | 500 |
| DV18-188B-CY | | | .150 | .76 | .23 | .10 | .187 x .020 | | 100 | 500 |
| DV18-205B-CY | | | .150 | .75 | .25 | .12 | .187/.205 x .032 | | 100 | 500 |
| DV18-206B-CY | | | .150 | .75 | .25 | .12 | .187/.205 x .020 | | 100 | 500 |
| DV18-250B-CY | | | .150 | .81 | .29 | .12 | .250 x .032 | | 100 | 500 |
| DV14-187B-C | 16 – 14 AWG | Blue | .170 | .75 | .23 | .10 | .187 x .032 | CT-1525^, CT-2500 | 100 | 500 |
| DV14-188B-C | | | .162 | .79 | .23 | .10 | .187 x .020 | | 100 | 500 |
| DV14-205B-C | | | .170 | .75 | .25 | .12 | .187/.205 x .032 | | 100 | 500 |
| DV14-206B-C | | | .170 | .75 | .25 | .12 | .187/.205 x .020 | | 100 | 500 |
| DV14-250B-C | | | .170 | .81 | .29 | .12 | .250 x .032 | | 100 | 500 |
| DV10-250-L* | 12 – 10 AWG | Yellow | .229 | 1.03 | .30 | .13 | .250 x .032 | CT-1550^, CT-1551^, CT-2500 | 50 | 500 |

*Sleeved barrel, maximum insulation temperature 194°F (90°C).

**To order in bulk, replace -C or -CY in the part number with -M or -MY for a bulk package of 1000 and replace -L with -D for a bulk package of 500.

‡UL and CSA approved tooling/product combinations. For crimping tool information, see page D1.84 and D1.88.

^CSA approved tooling/product combinations.

*UL Recognized only.



Female Disconnect, Non-Insulated – Metal Sleeve

Type D

- Disconnect can be inserted and removed from the male tab without the use of tools for lower installed cost
- Sleeved barrel helps to facilitate high mechanical and electrical performance when crimping
- Barrel of terminal internally beveled to provide quick and easy wire insertion
- Internal barrel serrations assure good wire contact and maximum tensile strength
- Internal wire stop assures proper length of insertion into terminal barrel, providing a higher quality connection
- Maximum recommended operating temperature 302°F (150°C)

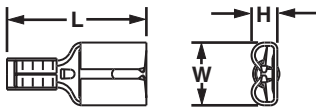

| Part Number | Wire Range | Figure Dimensions (In.) | | | Tab Size | Recommended Installation Tool | Std. Pkg. Qty.** | Std. Ctn. Qty. |
|--------------------|-------------|-------------------------|-----|-----|-------------|--|------------------|----------------|
| | | L | W | H | | | | |
| D18-187-C | 22 – 18 AWG | .58 | .23 | .10 | .187 x .032 | CT-100‡, CT-200‡, CT-1570‡, CT-2500‡ | 100 | 500 |
| D18-188-C | | .58 | .23 | .10 | .187 x .020 | | 100 | 500 |
| D18-250-C | | .66 | .30 | .12 | .250 x .032 | | 100 | 500 |
| ▲ D14-187-C | 16 – 14 AWG | .58 | .23 | .10 | .187 x .032 | CT-100, CT-200, CT-600-A, CT-1570, CT-2500 | 100 | 500 |
| ▲ D14-188-C | | .58 | .23 | .10 | .187 x .020 | | 100 | 500 |
| ▲ D14-250-C | | .66 | .30 | .12 | .250 x .032 | | 100 | 500 |
| D10-250-L | 12 – 10 AWG | .72 | .30 | .12 | .250 x .032 | CT-600-A‡, CT-1570‡, CT-1701‡, CT-2500‡ | 50 | 500 |

**To order in bulk, replace -C in the part number with -M for a bulk package of 1000 and replace -L with -D for a bulk package of 500.

‡UL and CSA approved tooling/product combinations. For crimping tool information, see pages D1.83, D1.84, D1.86 and D1.88.

*UL Recognized only.



Right Angle Female Disconnect, Nylon Fully Insulated – Funnel Entry

Type DNFR-FIB

- Right angle design for use in limited space applications
- Fully insulated design provides protection from electrical shorts
- Internal wire stop assures proper length of insertion into terminal barrel, providing a higher quality connection
- Disconnect can be inserted and removed from the male tab without the use of tools for lower installed cost
- Disconnects available in common industry tab sizes

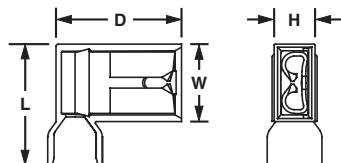

| Part Number | Wire Range | Color Code | Max. Ins. | Figure Dimensions (In.) | | | | Tab Size | Recommended Installation Tool | Std. Pkg. Qty.** | Std. Ctn. Qty. |
|------------------------|-------------|------------|-----------|-------------------------|-----|-----|-----|------------------|-------------------------------|------------------|----------------|
| | | | | L | W | H | D | | | | |
| DNFR18-205FIB-C | 22 – 18 AWG | Red | .178 | .58 | .37 | .21 | .60 | .205/.187 x .032 | CT-300-1 | 100 | 1000 |
| DNFR18-206FIB-C | | | .178 | .58 | .37 | .21 | .60 | .205/.187 x .020 | | 100 | 1000 |
| DNFR18-250FIB-C | | | .178 | .58 | .37 | .21 | .60 | .250 x .032 | | 100 | 1000 |
| DNFR14-205FIB-C | 16 – 14 AWG | Blue | .178 | .58 | .37 | .21 | .60 | .205/.187 x .032 | CT-300-1 | 100 | 1000 |
| DNFR14-206FIB-C | | | .178 | .58 | .37 | .21 | .60 | .205/.187 x .020 | | 100 | 1000 |
| DNFR14-250FIB-C | | | .178 | .58 | .37 | .21 | .60 | .250 x .032 | | 100 | 1000 |

**To order in bulk, replace -C in the part number with -M for a bulk package of 1000. For crimping tool information, see page D1.85.

A. System Overview

B1. Cable Ties

B2. Cable Accessories

B3. Stainless Steel Ties

C1. Wiring Duct

C2. Surface Raceway

C3. Abrasion Protection

C4. Cable Management

D1. Terminals

D2. Power Connectors

D3. Grounding Connectors

E1. Labeling Systems

E2. Labels

E3. Pre-Printed & Write-On Markers

E4. Permanent Identification

E5. Lockout/Tagout & Safety Solutions

F. Index

A. System Overview

B1. Cable Ties

B2. Cable Accessories

B3. Stainless Steel Ties

C1. Wiring Duct

C2. Surface Raceway

C3. Abrasion Protection

C4. Cable Management

D1. Terminals

D2. Power Connectors

D3. Grounding Connectors

E1. Labeling Systems

E2. Labels

E3. Pre-Printed & Write-On Markers

E4. Permanent Identification

E5. Lockout/Tagout & Safety Solutions

F. Index



Right Angle Female Disconnect, Nylon Insulated – Funnel Entry

Type DNFR-B

- Right angle design for use in limited space applications
- Disconnect can be inserted and removed from the male tab without the use of tools for lower installed cost
- Disconnects available in common industry tab sizes
- Longer barrel design for use with PANDUIT standard disconnect tool

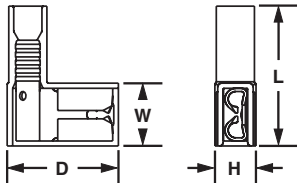

| Part Number | Wire Range | Color Code | Max. Ins. | Figure Dimensions (In.) | | | | Tab Size | Recommended Installation Tool | Std. Pkg. Qty. | Std. Ctn. Qty. |
|----------------------|-------------|------------|-----------|-------------------------|-----|-----|-----|------------------|-------------------------------|----------------|----------------|
| | | | | L | W | H | D | | | | |
| DNFR18-205B-C | 22 – 18 AWG | Red | .130 | .78 | .36 | .20 | .62 | .205/.187 x .032 | CT-1525‡, CT-2500‡ | 100 | 1000 |
| DNFR18-206B-C | | | .130 | .78 | .36 | .20 | .62 | .205/.187 x .020 | | | |
| DNFR18-250B-C | | | .130 | .78 | .36 | .20 | .62 | .250 x .032 | | | |
| DNFR14-205B-C | 16 – 14 AWG | Blue | .155 | .78 | .36 | .20 | .63 | .205/.187 x .032 | CT-1525‡, CT-2500‡ | 100 | 1000 |
| DNFR14-206B-C | | | .155 | .78 | .36 | .20 | .63 | .205/.187 x .020 | | | |
| DNFR14-250B-C | | | .155 | .78 | .36 | .20 | .63 | .250 x .032 | | | |

**To order in bulk, replace -C in the part number with -M for a bulk package of 1000 and replace -L with -D for a bulk package of 500.
‡UL and CSA approved tooling/product combinations. For crimping tool information, see pages D1.84 and D1.88.



Right Angle Female Disconnect, Non-Insulated – Metal Sleeve

Type DR

- Right angle design for use in limited space applications
- Disconnect can be inserted and removed from the male tab without the use of tools for lower installed cost
- Sleeved barrel helps to facilitate high mechanical and electrical performance when crimping
- Barrel of terminal internally beveled to provide quick and easy wire insertion
- Internal barrel serrations assure good wire contact and maximum tensile strength
- Maximum recommended operating temperature 302°F (150°C)

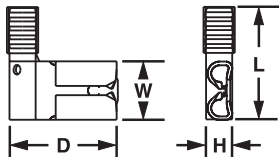

| Part Number | Wire Range | Figure Dimensions (In.) | | | | Tab Size | Recommended Installation Tool | Std. Pkg. Qty. | Std. Ctn. Qty. |
|-------------------|-------------|-------------------------|-----|-----|-----|------------------|---|----------------|----------------|
| | | L | W | H | D | | | | |
| DR18-205-C | 22 – 18 AWG | .54 | .25 | .12 | .53 | .205/.187 x .032 | CT-100‡, CT-200‡, CT-600-A‡, CT-1570‡, CT-2500‡ | 100 | 1000 |
| DR18-206-C | | .54 | .25 | .12 | .53 | .205/.187 x .020 | | | |
| DR18-250-C | | .57 | .30 | .12 | .54 | .250 x .032 | | | |
| DR14-205-C | 16 – 14 AWG | .54 | .25 | .12 | .55 | .205/.187 x .032 | CT-100‡, CT-200‡, CT-600-A‡, CT-1570‡, CT-2500‡ | 100 | 1000 |
| DR14-206-C | | .54 | .25 | .12 | .55 | .205/.187 x .020 | | | |
| DR14-250-C | | .57 | .30 | .12 | .55 | .250 x .032 | | | |
| DR10-250-L | 12 – 10 AWG | .61 | .30 | .12 | .57 | .250 x .032 | CT-100‡, CT-200‡, CT-600-A‡, CT-1570‡, CT-1701‡, CT-2500‡ | 50 | 500 |

**To order in bulk, replace -C in the part number with -M for a bulk package of 1000 and replace -L with -D for a bulk package of 500.
‡UL and CSA approved tooling/product combinations. For crimping tool information, see pages D1.83, D1.84, D1.86 and D1.88.
▲UL Recognized only.

SP® Right Angle Female Disconnect, Non-Insulated

Type DR-B

- Barrel of terminal internally beveled to provide quick and easy wire insertion
- Internal barrel serrations assure good wire contact and maximum tensile strength
- Butted seam offers an economical solution for less demanding applications
- For use in limited space applications

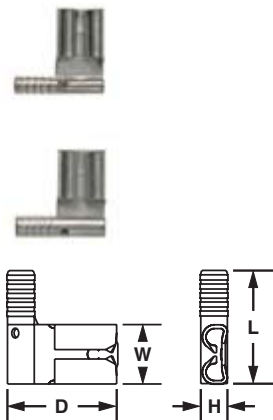

| Part Number | Wire Range | Figure Dimensions (In.) | | | | Tab Size | Recommended Installation Tool | Std. Pkg. Qty.** | Std. Ctn. Qty. |
|--------------|-------------|-------------------------|-----|-----|-----|------------------|-------------------------------|------------------|----------------|
| | | L | W | H | D | | | | |
| DR18-205B-C | 22 – 18 AWG | .54 | .25 | .12 | .53 | .205/.187 x .032 | CT-100, CT-200 | 100 | 1000 |
| DR18-206B-C | | .54 | .25 | .12 | .53 | .205/.187 x .020 | | 100 | 1000 |
| DR18-250B-C | | .55 | .30 | .12 | .53 | .250 x .032 | | 100 | 1000 |
| DR14-205B-C* | 16 – 14 AWG | .54 | .25 | .12 | .55 | .205/.187 x .032 | CT-100, CT-200 | 100 | 1000 |
| DR14-206B-C* | | .54 | .25 | .12 | .55 | .205/.187 x .020 | | 100 | 1000 |
| DR14-250B-C | | .55 | .30 | .12 | .55 | .250 x .032 | | 100 | 1000 |

*Not CSA Certified.

**To order in bulk, replace -C in the part number with -M for a bulk package of 1000. For crimping tool information, see page D1.83.

Piggyback Disconnect, Vinyl Insulated

Type DV-P

- Combination of female disconnect and male tab allows versatility in points of connection
- Multiple connection points allow additional circuits to be added to existing equipment without expensive rework
- Metal insulation grip sleeve crimps to wire insulation, providing protection to the crimp joint during high vibration applications

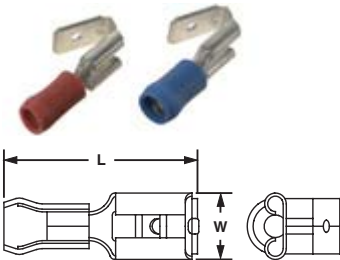

| Part Number | Wire Range | Color Code | Max. Ins. | Figure Dimensions (In.) | | Tab Size | Recommended Installation Tool | Std. Pkg. Qty.** | Std. Ctn. Qty. |
|--------------|-------------|------------|-----------|-------------------------|-----|-------------|---|------------------|----------------|
| | | | | L | W | | | | |
| DV18-250P-CY | 22 – 18 AWG | Red | .130 | .88 | .29 | .250 x .032 | CT-100, CT-260, CT-1550, CT-1551, CT-2500 | 100 | 1000 |
| DV14-250P-C | 16 – 14 AWG | Blue | .160 | .88 | .29 | .250 x .032 | | 100 | 1000 |

**To order in bulk, replace -C or CY in the part number with -M or MY for a bulk package of 1000. For crimping tool information, see pages D1.83, D1.84, and D1.88.

Disconnect Adapter, Non-Insulated

Type D-A

- Couples two female disconnects to one male disconnect (all .250 x .032)
- Multiple connection points allow additional circuits to be added to existing equipment without expensive rework
- Disconnect can be inserted and removed from the male tab without the use of tools for lower installed cost

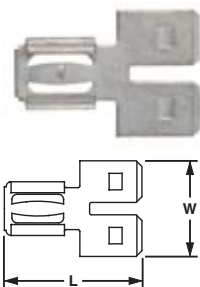

| Part Number | Figure Dimensions (In.) | | Tab Size | Std. Pkg. Qty.** | Std. Ctn. Qty. |
|-------------|-------------------------|-----|-------------|------------------|----------------|
| | L | W | | | |
| D-250A-C | .82 | .57 | .250 x .032 | 100 | 1000 |

**To order in bulk, replace -C in the part number with -M for a bulk package of 1000.

A. System Overview

B1. Cable Ties

B2. Cable Accessories

B3. Stainless Steel Ties

C1. Wiring Duct

C2. Surface Raceway

C3. Abrasion Protection

C4. Cable Management

D1. Terminals

D2. Power Connectors

D3. Grounding Connectors

E1. Labeling Systems

E2. Labels

E3. Pre-Printed & Write-On Markers

E4. Permanent Identification

E5. Lockout/Tagout & Safety Solutions

F. Index

A. System Overview

B1. Cable Ties

B2. Cable Accessories

B3. Stainless Steel Ties

C1. Wiring Duct

C2. Surface Raceway

C3. Abrasion Protection

C4. Cable Management

D1. Terminals

D2. Power Connectors

D3. Grounding Connectors

E1. Labeling Systems

E2. Labels

E3. Pre-Printed & Write-On Markers

E4. Permanent Identification

E5. Lockout/Tagout & Safety Solutions

F. Index

SP CERTIFIED Male Disconnect, Nylon Barrel Insulated – Funnel Entry

Type DNF-M

- Male tab couples with (all .250 x .032) female disconnects
- Male tab can be inserted and removed from the female disconnect without the use of tools for lower installed cost
- Metal insulation grip sleeve crimps to wire insulation, providing protection to the crimp joint during high vibration applications
- Internal barrel serrations assure good wire contact and maximum tensile strength
- Maximum insulation temperature 221°F (105°C)

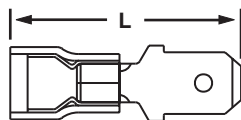

| Part Number | Wire Range | Color Code | Max. Ins. | Figure Dimensions (In.) | | Tab Size | Recommended Installation Tool | Std. Pkg. Qty.** | Std. Ctn. Qty. |
|----------------------|-------------|------------|-----------|-------------------------|--|-------------|-------------------------------|------------------|----------------|
| | | | | L | | | | | |
| DNF18-250M-C | 22 – 18 AWG | Red | .136 | .90 | | .250 x .032 | CT-1550, CT-1551, CT-2500 | 100 | 1000 |
| DNF14-250M-C | 16 – 14 AWG | Blue | .162 | .90 | | .250 x .032 | | 100 | 1000 |
| DNF10-250M-L* | 12 – 10 AWG | Yellow | .230 | 1.03 | | .250 x .032 | | 50 | 500 |

*Not UL Listed or CSA Certified.

**To order in bulk, replace -C in the part number with -M for a bulk package of 1000 and replace -L with -D for a bulk package of 500.

For crimping tool information, see pages D1.84 and D1.88.

SP CERTIFIED Male Disconnect, Vinyl Barrel Insulated – Funnel Entry

Type DV-MB

- Male tab couples with (all .250 x .032) female disconnects
- Insulation support helps to prevent wire damage in bending applications
- Male tab can be inserted and removed from the female disconnect without the use of tools for lower installed cost
- UL and CSA rated up to 600 V per UL 310

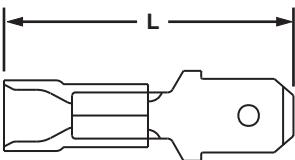

| Part Number | Wire Range | Color Code | Max. Ins. | Figure Dimensions (In.) | | Tab Size | Recommended Installation Tool | Std. Pkg. Qty.** | Std. Ctn. Qty. |
|----------------------|-------------|------------|-----------|-------------------------|--|-------------|-------------------------------|------------------|----------------|
| | | | | L | | | | | |
| DV18-250MB-CY | 22 – 18 AWG | Red | .154 | .98 | | .250 x .032 | CT-1550, CT-1551, CT-2500 | 100 | 500 |
| DV14-250MB-C | 16 – 14 AWG | Blue | .180 | .96 | | .250 x .032 | | 100 | 500 |
| DV10-250M-L* | 12 – 10 AWG | Yellow | .235 | .98 | | .250 x .032 | | 50 | 500 |

*Not UL Listed or CSA Certified.

**To order in bulk, replace -C or -CY in the part number with -M or -MY for a bulk package of 1000 and replace -L with -D for a bulk package of 500.

For crimping tool information, see pages D1.84 and D1.88.

Male Disconnect, Non-Insulated – Butted Seam

Type D-MB

- Male tab couples with (all .250 x .032) female disconnects
- Male tab can be inserted and removed from the female disconnect without the use of tools for lower installed cost
- Internal barrel serrations assure good wire contact and maximum tensile strength
- Barrel of terminal internally beveled to provide quick and easy wire insertion
- Maximum recommended operating temperature 302°F (150°C)

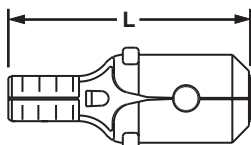

| Part Number | Wire Range | Figure Dimensions (In.) | Tab Size | Recommended Installation Tool | Std. Pkg. Qty.** | Std. Ctn. Qty. |
|--------------------|-------------|-------------------------|-------------|--|------------------|----------------|
| | | L | | | | |
| D18-250MB-C | 22 – 18 AWG | .69 | .250 x .032 | CT-100 | 100 | 500 |
| D14-250MB-C | 16 – 14 AWG | .69 | .250 x .032 | | 100 | 500 |
| D10-250M-L* | 12 – 10 AWG | .72 | .250 x .032 | CT-100, CT-200, CT-260, CT-1570, CT-2500 | 50 | 500 |

*Brazed seam.

**To order in bulk, replace -C in the part number with -M for a bulk package of 1000 and replace -L with -D for a bulk package of 500.

For crimping tool information, see pages D1.83, D1.84, and D1.88.

A.
System
Overview

B1.
Cable
Ties

B2.
Cable
Accessories

B3.
Stainless
Steel Ties

C1.
Wiring
Duct

C2.
Surface
Raceway

C3.
Abrasion
Protection

C4.
Cable
Management

D1.
Terminals

D2.
Power
Connectors

D3.
Grounding
Connectors

E1.
Labeling
Systems

E2.
Labels

E3.
Pre-Printed
& Write-On
Markers

E4.
Permanent
Identification

E5.
Lockout/
Tagout/
& Safety
Solutions

F.
Index

A. System Overview

Selection Guide – Specialty Terminals

B1. Cable Ties

B2. Cable Accessories

B3. Stainless Steel Ties

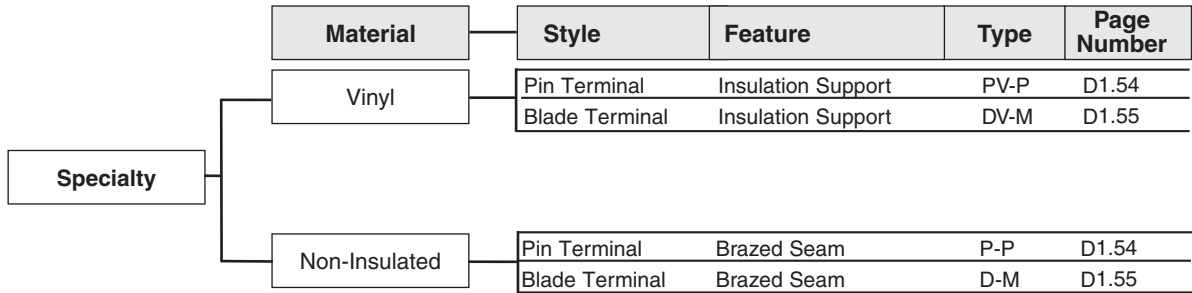

C1. Wiring Duct

Pin Terminal, Vinyl Insulated – Funnel Entry Type PV-P

C2. Surface Raceway

- Solid pin designed to prevent damage to the wire from over tightening, resulting in a reliable electrical connection
- Insulation support helps to prevent wire damage in bending applications
- Brazen seam protects terminal barrel from splitting during the crimp process

- Internal barrel serrations assure good wire contact and maximum tensile strength
- UL rated up to 600 V per UL 486 (18 and 14 gauge only)
- For use with pin-type terminal blocks

C3. Abrasion Protection



C4. Cable Management



D1. Terminals



| Part Number | Wire Range | Color Code | Max. Ins. | Figure Dimensions (In.) | | | Recommended Installation Tool | Std. Pkg. Qty.** | Std. Ctn. Qty. |
|--------------------|-------------|------------|-----------|-------------------------|-----|-----|---|------------------|----------------|
| | | | | L | W | P | | | |
| PV18-P47-CY | 22 – 18 AWG | Red | .150 | .97 | .07 | .49 | CT-100, CT-260, CT-1550, CT-1551, CT-2500 | 100 | 1000 |
| PV14-P47-C | 16 – 14 AWG | Blue | .170 | .97 | .07 | .49 | | 100 | 1000 |
| PV10-P55-L* | 12 – 10 AWG | Yellow | .250 | 1.10 | .10 | .55 | | 50 | 500 |

*Not UL Recognized.

**To order in bulk, replace -C or -CY in the part number with -M or -MY for a bulk package of 1000 and replace -L with -D for a bulk package of 500.

For crimping tool information, see pages D1.83, D1.84, and D1.88.

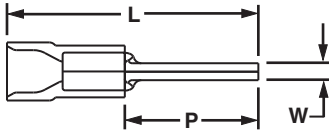

D2. Power Connectors

D3. Grounding Connectors

Pin Terminal, Non-Insulated Type P-P

E1. Labeling Systems

- Solid pin designed to prevent damage to the wire from over tightening, resulting in a reliable electrical connection
- Brazen seam protects terminal barrel from splitting during the crimp process
- Internal barrel serrations assure good wire contact and maximum tensile strength

- Barrel of terminal internally beveled to provide quick and easy wire insertion
- UL rated up to 600 V per UL 486 (18 and 14 gauge only)
- Maximum recommended operating temperature 302°F (150°C)
- For use with pin-type terminal blocks

E2. Labels

E3. Pre-Printed & Write-On Markers



E4. Permanent Identification



E5. Lockout/Tagout & Safety Solutions



| Part Number | Wire Range | Figure Dimensions (In.) | | | Recommended Installation Tool | Std. Pkg. Qty.** | Std. Ctn. Qty. |
|-------------------|-------------|-------------------------|-----|-----|--|------------------|----------------|
| | | L | W | P | | | |
| P18-P47-C | 22 – 18 AWG | .75 | .07 | .49 | CT-100, CT-200, CT-260, CT-1570, CT-2500 | 100 | 1000 |
| P14-P47-C | 16 – 14 AWG | .75 | .07 | .49 | | 100 | 1000 |
| P10-P55-L* | 12 – 10 AWG | .79 | .11 | .55 | CT-100, CT-200, CT-260, CT-1570, CT-2500 | 50 | 500 |

*Not UL Recognized.

**To order in bulk, replace -C in the part number with -M for a bulk package of 1000 and replace -L with -D for a bulk package of 500.

‡UL and CSA approved tooling/product combinations. For crimping tool information, see pages D1.83, D1.84, and D1.88.

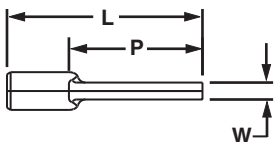

PA **SP** Male Blade Adapter, Vinyl Insulated – Funnel Entry

Type DV-M

- Flat blade design to prevent damage to the wire from over tightening, resulting in a reliable electrical connection
- For use with blade-type terminal blocks
- Insulation support helps to prevent wire damage in bending applications
- Brazed seam protects terminal barrel from splitting during the crimp process

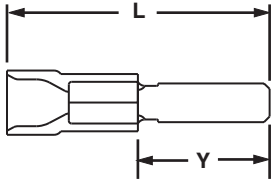

| Part Number | Wire Range | Color Code | Max. Ins. | Figure Dimensions (In.) | | Tab Size | Recommended Installation Tool | Std. Pkg. Qty.** | Std. Ctn. Qty. |
|---------------------|-------------|------------|-----------|-------------------------|-----|-------------|---|------------------|----------------|
| | | | | L | Y | | | | |
| DV18-145M-CY | 22 – 18 AWG | Red | .150 | .97 | .42 | .145 x .032 | CT-600-A, CT-1550‡, CT-1551‡, CT-2500‡ | 100 | 500 |
| DV14-145M-C | 16 – 14 AWG | Blue | .170 | .97 | .42 | .145 x .032 | | 100 | 500 |

**To order in bulk, replace -C or -CY in the part number with -M or -MY for a bulk package of 1000.
‡UL and CSA approved tooling/product combinations. For crimping tool information, see pages D1.84, D1.86, and D1.88.

PA **SP** Male Blade Adapter, Non-Insulated

Type D-M

- Flat blade design to prevent damage to the wire from over tightening, resulting in a reliable electrical connection
- For use with blade-type terminal blocks
- Internal barrel serrations assure good wire contact and maximum tensile strength
- Brazed seam protects terminal barrel from splitting during the crimp process
- Barrel of terminal internally beveled to provide quick and easy wire insertion

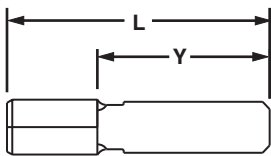

| Part Number | Wire Range | Figure Dimensions (In.) | | Tab Size | Recommended Installation Tool | Std. Pkg. Qty.** | Std. Ctn. Qty. |
|-------------------|-------------|-------------------------|-----|-------------|--|------------------|----------------|
| | | L | Y | | | | |
| D18-145M-C | 22 – 18 AWG | .75 | .42 | .145 x .032 | CT-100‡, CT-200‡, CT-600-A, CT-1570‡, CT-2500‡ | 100 | 500 |
| D14-145M-C | 16 – 14 AWG | .75 | .42 | .145 x .032 | | 100 | 500 |

**To order in bulk, replace -C in the part number with -M for a bulk package of 1000.
‡UL and CSA approved tooling/product combinations. For crimping tool information, see pages D1.83, D1.84, D1.86 and D1.88.

A.
System
Overview

B1.
Cable
Ties

B2.
Cable
Accessories

B3.
Stainless
Steel Ties

C1.
Wiring
Duct

C2.
Surface
Raceway

C3.
Abrasion
Protection

C4.
Cable
Management

D1.
Terminals

D2.
Power
Connectors

D3.
Grounding
Connectors

E1.
Labeling
Systems

E2.
Labels

E3.
Pre-Printed
& Write-On
Markers

E4.
Permanent
Identification

E5.
Lockout/
Tagout
& Safety
Solutions

F.
Index

A. System Overview

Features and Benefits – PAN-TERM® Metric Disconnects

B1. Cable Ties

Metric Nylon Fully Insulated Female and Male Tabs Type DMNF-FIB

Available in tab sizes to accommodate 2.8, 4.8, and 6.3mm tabs

Fully insulated design provides protection from electrical shorts

Expanded wire entry (on select sizes) accommodates large insulation or multiple wires

Maximum insulation temperature 257°F (125°C)

Insulation support restricts excessive wire movement to minimize stress on crimp joint

Funnel entry for faster wire insertion and lower installed cost

Rated at 600 V.

B2. Cable Accessories

B3. Stainless Steel Ties

C1. Wiring Duct

C2. Surface Raceway

C3. Abrasion Protection

C4. Cable Management

D1. Terminals

D2. Power Connectors

D3. Grounding Connectors

E1. Labeling Systems

E2. Labels

E3. Pre-Printed & Write-On Markers

E4. Permanent Identification

E5. Lockout/Tagout & Safety Solutions

F. Index

Nylon Barrel Insulated Female Receptacles and Male Tabs Type DMNF

Available in tab sizes to accommodate 2.8, 4.8, and 6.3mm tabs

Maximum insulation temperature 194°F (90°C)

Funnel entry for faster wire insertion and lower installed cost

Rated at 600 V.

Vinyl Barrel Insulated Female Receptacles Type DMV

Available in tab sizes to accommodate 2.8, 4.8, and 6.3mm tabs

Maximum insulation temperature 221°F (105°C)

Insulation support to protect electrical crimp

Insulation grip sleeve provides a superior insulation crimp for high vibration and high strain relief applications

Rated at 600 V.
Flammability UL 94V-0.

Non-Insulated Female Receptacles and Male Tabs Type DM

Available in tab sizes to accommodate 2.8, 4.8, and 6.3mm tabs

Maximum recommended operating temperature 302°F (150°C)

Sleeved barrel assures crimp reliability



PANDUIT extensive line of tooling is specifically designed for optimum crimping performance.

See pages D1.83 – D1.88.



PANDUIT designs and manufactures a full line of labeling products, software, and printers to assist you with your labeling requirements.

See pages E1.1 – E2.30.

Part Number System for PAN-TERM® Metric Disconnects

| | | | | | | | | |
|------------------------|---|--|---|---|---|---|---|---|
| DM | NF | 1 | — | 285 | — | FIB | — | C |
| Type | Insulation | Wire Range | | Size and Type | | Special Configuration | | Package Size |
| DM = Disconnect Metric | N = Nylon NF = Nylon Funnel V = Vinyl | 1 = .5 – 1.0mm ² (22 – 18 AWG) 2 = 1.5 – 2.5mm ² (16 – 14 AWG) 6 = 4.0 – 6.0mm ² (12 – 10 AWG) | | 285 = 2.8mm x .5mm (.110 x .020) 288 = 2.8mm x .8mm (.110 x .032) 488 = 4.8mm x .8mm (.188 x .032) 63 = 6.3mm x .8mm (.250 x .032) | | B = Butted Seam FI = Fully Insulated Female FIB = Fully Insulated Butted Seam Female FIM = Fully Insulated Male M = Male MB = Butted Seam Male | | X = 10 E = 20 Q = 25 L = 50 C = 100 |

Female Metric Disconnect, Fully Insulated Nylon – Funnel Entry

Type DMNF-FIB

- Disconnect can be inserted and removed from the male tab without the use of tools for lower installed cost
- Fully insulated design provides protection from electrical shorts
- Disconnects available in common industry tab sizes
- Internal wire stop assures proper length of insertion into terminal barrel, providing a higher quality connection

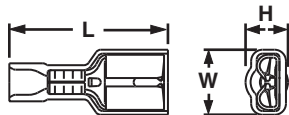

| Part Number | Wire Range | Color Code | Max. Ins. | Figure Dimensions (mm) | | | Tab Size | Recommended Installation Tool | Std. Pkg. Qty. | Std. Ctn. Qty. |
|------------------|------------|------------|-----------|------------------------|-----|-----|----------|-------------------------------|----------------|----------------|
| | | | | L | W | H | | | | |
| DMNF1-285FIB-C | .5 – 1.0 | Red | 3.05 | 18.0 | 4.8 | 4.1 | 2.8 x .5 | CT-1525, CT-2500 | 100 | 500 |
| DMNF1-288FIB-C | | | 3.05 | 18.0 | 4.8 | 4.1 | 2.8 x .8 | | 100 | 500 |
| DMNF1-488FIB-C** | .5 – 1.0 | | 3.35 | 19.8 | 7.9 | 5.5 | 4.8 x .8 | | 100 | 1000 |
| DMNF1-63FIB-C | | | 3.35 | 21.3 | 8.9 | 5.5 | 6.3 x .8 | | 100 | 500 |
| DMNF2-488FIB-C** | 1.5 – 2.5 | Blue | 3.96 | 19.8 | 7.9 | 5.5 | 4.8 x .8 | CT-1551 | 100 | 1000 |
| DMNF2-63FIB-C | | | 3.96 | 21.3 | 8.9 | 5.5 | 6.3 x .8 | | 100 | 500 |
| DMNF6-63FI-L | 4.0 – 6.0 | Yellow | 5.84 | 24.4 | 8.9 | 6.9 | 6.3 x .8 | | 50 | 250 |

**Only DMNF1-488FIB and DMNF2-488FIB are available in bulk; to order, replace -C in the part number with -M for a bulk package of 1000.

For crimping tool information, see pages D1.84 and D1.88.

A. System Overview

B1. Cable Ties

B2. Cable Accessories

B3. Stainless Steel Ties

C1. Wiring Duct

C2. Surface Raceway

C3. Abrasion Protection

C4. Cable Management

D1. Terminals

D2. Power Connectors

D3. Grounding Connectors

E1. Labeling Systems

E2. Labels

E3. Pre-Printed & Write-On Markers

E4. Permanent Identification

E5. Lockout/Tagout & Safety Solutions

F. Index

A. System Overview

Female Metric Disconnect, Nylon Barrel Insulated – Funnel Entry

B1. Cable Ties

Type DMNF

- Disconnect can be inserted and removed from the male tab without the use of tools for lower installed cost
- Fully insulated design provides protection from electrical shorts
- Metal insulation grip sleeve crimps to wire insulation, providing protection to the crimp joint during high vibration applications
- Internal barrel serrations assure good wire contact and maximum tensile strength
- Internal wire stop assures proper length of insertion into terminal barrel, providing a higher quality connection

B2. Cable Accessories

B3. Stainless Steel Ties



C1. Wiring Duct



C2. Surface Raceway

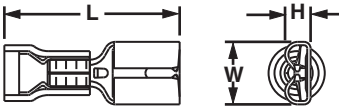

| Part Number | Wire Range (mm ²) | Color Code | Max. Ins. | Figure Dimensions (mm) | | | Tab Size (mm) | Recommended Installation Tool | Std. Pkg. Qty. | Std. Ctn. Qty. |
|-------------|-------------------------------|------------|-----------|------------------------|-----|-----|---------------|-------------------------------|----------------|----------------|
| | | | | L | W | H | | | | |
| DMNF1-285-C | .5 – 1.0 | Red | 2.50 | 17.8 | 3.8 | 2.0 | 2.8 x .5 | CT-1551 | 100 | 500 |
| DMNF1-288-C | | | 2.50 | 17.6 | 3.8 | 2.0 | 2.8 x .8 | | 100 | 500 |
| DMNF1-488-C | | | 3.60 | 19.6 | 5.8 | 2.5 | 4.8 x .8 | | 100 | 500 |
| DMNF1-63-C | .5 – 1.5 | Red | 3.58 | 20.7 | 7.4 | 3.1 | 6.3 x .8 | | 100 | 500 |
| DMNF2-288-C | | | 4.20 | 18.8 | 3.8 | 2.0 | 2.8 x .8 | | 100 | 500 |
| DMNF2-488-C | | | 4.20 | 19.6 | 5.8 | 2.5 | 4.8 x 0.8 | | 100 | 500 |
| DMNF2-63-C | 1.5 – 2.5 | Blue | 4.22 | 21.1 | 7.4 | 3.1 | 6.3 x 0.8 | | 100 | 500 |

For crimping tool information, see page D1.84.

C3. Abrasion Protection

Female Metric Disconnect, Vinyl Barrel Insulated – Funnel Entry

C4. Cable Management

Type DMV

- Disconnect can be inserted and removed from the male tab without the use of tools for lower installed cost
- Metal insulation grip sleeve crimps to wire insulation, providing protection to the crimp joint during high vibration applications
- Internal barrel serrations assure good wire contact and maximum tensile strength
- Internal wire stop assures proper length of insertion into terminal barrel, providing a higher quality connection

D1. Terminals

D2. Power Connectors



D3. Grounding Connectors

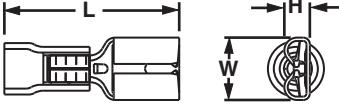

| Part Number | Wire Range (mm ²) | Color Code | Max. Ins. | Figure Dimensions (mm) | | | Tab Size (mm) | Recommended Installation Tool | Std. Pkg. Qty. | Std. Ctn. Qty. |
|-------------|-------------------------------|------------|-----------|------------------------|-----|-----|---------------|-------------------------------|----------------|----------------|
| | | | | L | W | H | | | | |
| DMV6-63-L | 4.0 – 6.0 | Yellow | 5.80 | 25.7 | 7.6 | 3.3 | 6.3 x .8 | CT-1551 | 50 | 250 |

For crimping tool information, see page D1.84.

E1. Labeling Systems

Female Metric Disconnect, Non-Insulated – Metal Sleeve

E2. Labels

Type DM

- Disconnect can be inserted and removed from the male tab without the use of tools for lower installed cost
- Sleeved barrel helps to facilitate high mechanical and electrical performance when crimping
- Barrel of terminal internally beveled to provide quick and easy wire insertion
- Internal barrel serrations assure good wire contact and maximum tensile strength
- Internal wire stop assures proper length of insertion into terminal barrel, providing a higher quality connection

E3. Pre-Printed & Write-On Markers



E4. Permanent Identification



E5. Lockout/Tagout & Safety Solutions

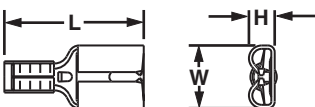

| Part Number | Wire Range (mm ²) | Figure Dimensions (mm) | | | Tab Size (mm) | Recommended Installation Tool | Std. Pkg. Qty. | Std. Ctn. Qty. |
|-------------|-------------------------------|------------------------|-----|-----|---------------|-------------------------------|----------------|----------------|
| | | L | W | H | | | | |
| DM1-488-C | .5 – 1.0 | 15.0 | 5.9 | 2.5 | 4.8 x .8 | CT-1570, CT-2500 | 100 | 500 |
| DM1-63-C | .5 – 1.0 | 16.8 | 7.6 | 3.0 | 6.3 x .8 | | 100 | 500 |
| DM2-488-C | 1.5 – 2.5 | 15.0 | 5.9 | 2.5 | 4.8 x .8 | | 100 | 500 |
| DM2-63-C | 1.5 – 2.5 | 16.8 | 7.6 | 3.0 | 6.3 x .8 | | 100 | 500 |
| DM6-63-L | 4.0 – 6.0 | 18.2 | 7.6 | 3.0 | 6.3 x .8 | | 50 | 250 |

For crimping tool information, see pages D1.84 and D1.88.

Piggyback Metric Disconnect, Vinyl Barrel Insulated

Type DMV-P

- Combination of female disconnect and male tab allows versatility in points of connection
- Multiple connection points allow additional circuits to be added to existing equipment without expensive rework
- Metal insulation grip sleeve crimps to wire insulation, providing protection to the crimp joint during high vibration applications

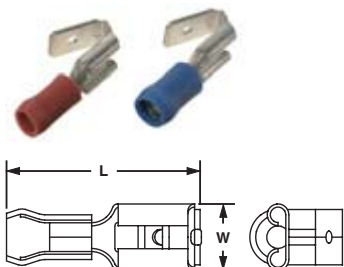

| Part Number | Wire Range (mm ²) | Color Code | Max. Ins. | Figure Dimensions (mm) | | Tab Size (mm) | Recommended Installation Tool | Std. Pkg. Qty. | Std. Ctn. Qty. |
|-------------|-------------------------------|------------|-----------|------------------------|-----|---------------|-------------------------------|----------------|----------------|
| | | | | L | W | | | | |
| DMV1-63P-CY | .5 – 1.5 | Red | 3.30 | 22.4 | 7.4 | 6.3 x .8 | CT-1551 | 100 | 500 |
| DMV2-63P-C | 1.5 – 2.5 | Blue | 4.06 | 22.4 | 7.4 | 6.3 x .8 | | 100 | 500 |

For crimping tool information, see page D1.84.

Male Metric Disconnect, Fully Insulated Nylon – Funnel Entry

Type DMNF-FIM

- Male tab couples with (all .250 x .032) female disconnects
- Fully insulated design provides protection from electrical shorts
- Male tab can be inserted and removed from the female disconnect without the use of tools for lower installed cost
- Internal barrel serrations assure good wire contact and maximum tensile strength

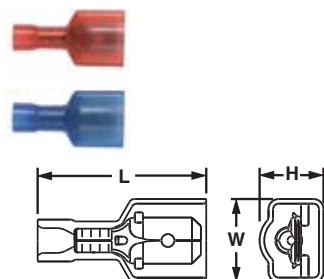

| Part Number | Wire Range (mm ²) | Color Code | Max. Ins. | Figure Dimensions (mm) | | | Tab Size (mm) | Recommended Installation Tool | Std. Pkg. Qty. | Std. Ctn. Qty. |
|---------------|-------------------------------|------------|-----------|------------------------|------|------|---------------|-------------------------------|----------------|----------------|
| | | | | L | W | H | | | | |
| DMNF1-63FIM-C | .5 – 1.0 | Red | 3.38 | 22.9 | 10.3 | 7.03 | 6.3 x .8 | CT-1525, CT-2500 | 100 | 500 |
| DMNF2-63FIM-C | 1.5 – 2.5 | Blue | 4.01 | 22.9 | 10.4 | 7.05 | 6.3 x .8 | | 100 | 500 |

For crimping tool information, see pages D1.84 and D1.88.

Male Metric Disconnect, Nylon Barrel Insulated – Funnel Entry

Type DMNF-M

- Male tab couples with (all .250 x .032) female disconnects
- Male tab can be inserted and removed from the female disconnect without the use of tools for lower installed cost
- Metal insulation grip sleeve crimps to wire insulation, providing protection to the crimp joint during high vibration applications
- Internal barrel serrations assure good wire contact and maximum tensile strength

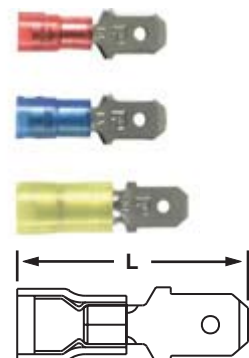

| Part Number | Wire Range (mm ²) | Color Code | Max. Ins. | Figure Dimensions (mm) | Tab Size (mm) | Recommended Installation Tool | Std. Pkg. Qty. | Std. Ctn. Qty. |
|-------------|-------------------------------|------------|-----------|------------------------|---------------|-------------------------------|----------------|----------------|
| | | | | L | | | | |
| DMNF1-63M-C | .5 – 1.5 | Red | 3.96 | 22.7 | 6.3 x .8 | CT-1551 | 100 | 500 |
| DMNF2-63M-C | 1.5 – 2.5 | Blue | 4.83 | 23.6 | 6.3 x .8 | | 100 | 500 |
| DMNF6-63M-L | 2.5 – 6.0 | Yellow | 6.20 | 23.6 | 6.3 x .8 | | 50 | 250 |

For crimping tool information, see page D1.84.

A. System Overview

B1. Cable Ties

B2. Cable Accessories

B3. Stainless Steel Ties

C1. Wiring Duct

C2. Surface Raceway

C3. Abrasion Protection

C4. Cable Management

D1. Terminals

D2. Power Connectors

D3. Grounding Connectors

E1. Labeling Systems

E2. Labels

E3. Pre-Printed & Write-On Markers

E4. Permanent Identification

E5. Lockout/Tagout & Safety Solutions

F. Index

A. System Overview

Male Metric Disconnect, Non-Insulated – Butted Seam

B1. Cable Ties

Type DM-M

- Male tab couples with (all 250 x .032) female disconnects
- Male tab can be inserted and removed from the female disconnect without the use of tools for lower installed cost
- Internal barrel serrations assure good wire contact and maximum tensile strength
- Barrel of terminal internally beveled to provide quick and easy wire insertion

B2. Cable Accessories



B3. Stainless Steel Ties



C1. Wiring Duct



C2. Surface Raceway

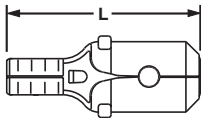

| Part Number | Wire Range (mm ²) | Figure Dimensions (mm) | | | Recommended Installation Tool | Std. Pkg. Qty. | Std. Ctn. Qty. |
|-------------|-------------------------------|------------------------|-----|----|-------------------------------|----------------|----------------|
| | | L | W | P | | | |
| DM1-63M-C | .5 – 1.0 | 19.2 | 6.3 | .8 | CT-1570, CT-2500 | 100 | 500 |
| DM2-63M-C | 1.5 – 2.5 | 19.2 | 6.3 | .8 | | 100 | 500 |
| DM6-63M-L* | 2.5 – 6.0 | 18.2 | 6.3 | .8 | | 50 | 250 |

*Brazen seam.
For crimping tool information, see pages D1.84 and D1.88.

C3. Abrasion Protection

Metric Pin Terminal, Vinyl Insulated – Funnel Entry

C4. Cable Management

Type PMV-P

- Solid pin designed to prevent damage to the wire from over tightening, resulting in a reliable electrical connection
- For use with pin-type terminal blocks
- Insulation support helps to prevent wire damage in bending applications
- Brazen seam protects terminal barrel from splitting during the crimp process
- Internal barrel serrations assure good wire contact and maximum tensile strength

D1. Terminals



D2. Power Connectors



D3. Grounding Connectors

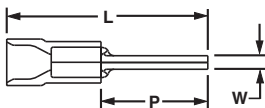

| Part Number | Wire Range (mm ²) | Color Code | Max. Ins. | Figure Dimensions (mm) | | | Recommended Installation Tool | Std. Pkg. Qty. | Std. Ctn. Qty. |
|-------------|-------------------------------|------------|-----------|------------------------|-----|------|-------------------------------|----------------|----------------|
| | | | | L | W | P | | | |
| PMV1-P10-CY | .5 – 1.5 | Red | 3.80 | 21.1 | 2.0 | 11.9 | CT-1550, CT-2500 | 100 | 500 |
| PMV2-P10-C | 1.5 – 2.5 | Blue | 4.30 | 21.1 | 2.0 | 11.9 | | 100 | 500 |
| PMV6-P10-L | 2.5 – 6.0 | Yellow | 6.40 | 27.9 | 2.5 | 14.0 | | 50 | 250 |

For crimping tool information, see pages D1.84 and D1.88.

E1. Labeling Systems

Metric Pin Terminal, Non-Insulated

E2. Labels

Type PM-P

- Solid pin designed to prevent damage to the wire from over tightening, resulting in a reliable electrical connection
- For use with pin-type terminal blocks
- Insulation support helps to prevent wire damage in bending applications
- Brazen seam protects terminal barrel from splitting during the crimp process
- Internal barrel serrations assure good wire contact and maximum tensile strength

E3. Pre-Printed & Write-On Markers



E4. Permanent Identification



E5. Lockout/Tagout & Safety Solutions

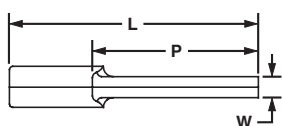

| Part Number | Wire Range (mm ²) | Figure Dimensions (mm) | | | Recommended Installation Tool | Std. Pkg. Qty. | Std. Ctn. Qty. |
|-------------|-------------------------------|------------------------|-----|------|-------------------------------|----------------|----------------|
| | | L | W | P | | | |
| PM1-P10-C | .5 – 1.0 | 19.0 | 1.8 | 12.4 | CT-1570, CT-2500 | 100 | 500 |
| PM2-P10-C | 1.5 – 2.5 | 19.0 | 1.8 | 12.4 | | 100 | 500 |
| PM6-P10-L | 4.0 – 6.0 | 20.1 | 2.8 | 14.0 | | 50 | 250 |

For crimping tool information, see pages D1.84 and D1.88.

F. Index

PAN-TERM® SPLICES

PANDUIT® PAN-TERM® Splices are designed and manufactured for fast assembly, and long reliable performance. As the demand for splices increases, it becomes essential to provide a complete system for termination products. We provide an extensive line of tooling designed specifically to provide optimum performance when used as a system for terminating.



- Suitable for in-line, parallel, and group splicing of wires
- Nylon and vinyl insulated as well as non-insulated
- Available in sizes from #26 – 10 AWG
- Internal wire stops on butt splices prevent over insertion of wires
- Applicable sizes are UL Listed and CSA Certified, as noted
- Wide assortment of manual, controlled cycle, battery operated hydraulic and pneumatic crimping tools for reliable connections at the lowest installed cost

PANDUIT continually provides new designs to meet the application challenges encountered by our customers. PANDUIT offers a wide assortment of PAN-TERM® termination products to meet customer needs at the lowest installed cost.

A.
System
Overview

B1.
Cable Ties

B2.
Cable
Accessories

B3.
Stainless
Steel Ties

C1.
Wiring
Duct

C2.
Surface
Raceway

C3.
Abrasion
Protection

C4.
Cable
Management

D1.
Terminals

D2.
Power
Connectors

D3.
Grounding
Connectors

E1.
Labeling
Systems

E2.
Labels

E3.
Pre-Printed
& Write-On
Markers

E4.
Permanent
Identification

E5.
Lockout/
Tagout/
& Safety
Solutions

F.
Index

A. System Overview

Features and Benefits – PAN-TERM® Splices and Wire Joints

B1. Cable Ties

Non-Insulated Wire Joints Type J

Only one crimp needed to complete splice

Maximum recommended operating temperature 302°F (150°C)



Internally beveled barrel for quick easy wire insertion

UL and CSA rated up to 600 V.

Non-Insulated Parallel Splices Type PS

Seamless tubular barrel provides consistent high performance quality crimps

Maximum recommended operating temperature 302°F (150°C)



Only one crimp needed to complete splice

UL and CSA rated up to 300 V.

B2. Cable Accessories

B3. Stainless Steel Ties

C1. Wiring Duct

C2. Surface Raceway

C3. Abrasion Protection

C4. Cable Management

D1. Terminals

D2. Power Connectors

D3. Grounding Connectors

E1. Labeling Systems

E2. Labels

E3. Pre-Printed & Write-On Markers

E4. Permanent Identification

E5. Lockout/Tagout & Safety Solutions

F. Index

Nylon Wire Joints Type JN

Fully insulated housing protects crimp joint

Maximum insulation temperature 221°F (105°C)



Only one crimp needed to complete splice

Deep skirt to accommodate multiple variations of wire combinations

UL and CSA rated up to 600 V. Metric versions available.

Nylon Parallel Splices Type PSN

Maximum insulation temperature 221°F (105°C)



Only one crimp needed to complete splice

UL and CSA rated up to 300 V.



PANDUIT extensive line of tooling is specifically designed for optimum crimping performance.

See pages D1.83 – D1.88.



PANDUIT designs and manufactures a full line of labeling products, software, and printers to assist you with your labeling requirements.

See pages E1.1 – E2.30.

Features and Benefits – PAN-TERM® Splices

Nylon Butt Splices Type BSN

Internal wire stops assure proper insertion length



Maximum insulation temperature 221°F (105°C)

Brazed seam assures crimp reliability

UL and CSA rated up to 600 V.

Vinyl Butt Splices Type BSV

Internal wire stops assure proper insertion, length



Maximum insulation temperature 221°F (105°C)

Brazed seam assures crimp reliability

Expanded wire entry accommodates larger insulation

UL and CSA rated up to 600 V.
Flammability – UL 94V-0.
Metric versions available.

Non-Insulated Butt Splices Type BS

Internal wire stops assure proper insertion length



Brazed seam assures crimp reliability

Maximum recommended operating temperature 302°F (150°C)

Internally beveled barrel for quick easy wire insertion

UL and CSA rated up to 600 V.
Metric versions available.

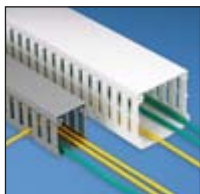

PANDUIT wiring duct offers a wide variety of sizes and types to meet the wire capacity needs and space constraints of the smallest wall mounted to the largest integrated systems.

See pages C1.1 – C1.52.



A comprehensive selection of cable ties used to bundle, mount, and identify wire and cable.

See pages B1.1 – B1.122.

A. System Overview

B1. Cable Ties

B2. Cable Accessories

B3. Stainless Steel Ties

C1. Wiring Duct

C2. Surface Raceway

C3. Abrasion Protection

C4. Cable Management

D1. Terminals

D2. Power Connectors

D3. Grounding Connectors

E1. Labeling Systems

E2. Labels

E3. Pre-Printed & Write-On Markers

E4. Permanent Identification

E5. Lockout/ Tagout & Safety Solutions

F. Index

A. System Overview

Selection Guide – PAN-TERM® Splices and Wire Joints

B1. Cable Ties

B2. Cable Accessories

B3. Stainless Steel Ties

C1. Wiring Duct

C2. Surface Raceway

C3. Abrasion Protection

C4. Cable Management

D1. Terminals

D2. Power Connectors

D3. Grounding Connectors

E1. Labeling Systems

E2. Labels

E3. Pre-Printed & Write-On Markers

E4. Permanent Identification

E5. Lockout/Tagout & Safety Solutions

F. Index



Splices and Wire Joints

| Material | Style | Feature | Type | Page Number |
|---------------|-----------------|-------------------------|------|-------------|
| Nylon | Butt Splice | Brazed Seam | BSN | D1.65 |
| | Parallel Splice | Seamless Barrel | PSN | D1.66 |
| | Wire Joint | Multiple Wire Connector | JN | D1.67 |
| Vinyl | Butt Splice | Expanded Insulation | BSV | D1.65 |
| Heat Shrink | Butt Splice | Heat Shrink Insulation | BSH | D1.68 |
| Non-Insulated | Butt Splice | Brazed Seam | BS | D1.66 |
| | Parallel Splice | Seamless Barrel | PS | D1.67 |
| | Wire Joint | | J | D1.68 |

Part Number System for PAN-TERM® Splices

BS

Type

BS = Butt Splice
PS = Parallel Splice

V

Insulation

N = Nylon
V = Vinyl

14

Wire Range

22 = #26 – 22
18 = #22 – 18
14 = #16 – 14
13 = #14 – 12
10 = #12 – 10

X

Special Configuration

X = Expanded Insulation

—

M

Standard Package Size

X = 10
Q = 25
L = 50
C = 100
T = 200
D = 500
M = 1000

Part Number System for PAN-TERM® Wire Joints

JN

Type

J = Non-Insulated
JN = Nylon-Insulated

418-212

Wire Range

J Types
214 – 312 = 2 #14 – 3 #12
318 – 412 = 3 #14 – 4 #12
216 – 410 = 2 #16 – 4 #10

JN Types
224 – 318 = 2 #24 – 3 #18
218 – 216 = 2 #18 – 2 #16
418 – 212 = 4 #18 – 2 #12
314 – 412 = 3 #14 – 4 #12

—

C

Standard Package Size

X = 10
Q = 25
L = 50
C = 100
T = 200
D = 500
M = 1000

UL LISTED CERTIFIED **Butt Splice, Nylon Insulated**

Type BSN

- Designed to splice two solid or stranded wires together to repair or lengthen wires
- Butted configuration provides low profile for limited space applications
- Brazed seam protects terminal barrel from splitting during the crimp process
- Internal wire stop assures proper length of insertion into terminal barrel
- UL Flammability UL 94V-2/HB, maximum insulation temperature 221°F (105°C)
- UL and CSA rated up to 600 V per UL 486

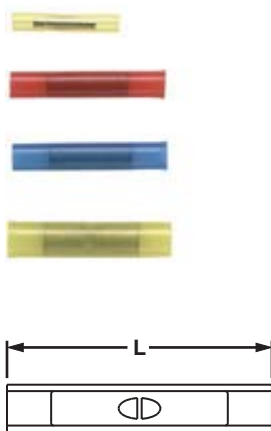

| Part Number | Wire Range | Color Code | Max. Ins. | Figure Dimensions (In.) | Recommended Installation Tool | Std. Pkg. Qty.** | Std. Ctn. Qty. |
|-----------------|-------------|------------|-----------|-------------------------|---|------------------|----------------|
| | | | | L | | | |
| BSN22-C* | 26 – 22 AWG | Yellow | .080 | .79 | CT-100, CT-1525, CT-2500 | 100 | 1000 |
| BSN18-C | 22 – 18 AWG | Red | .115 | 1.15 | CT-100, CT-600-A, CT-1550, CT-1551, CT-2500 | 100 | 1000 |
| BSN14-C | 16 – 14 AWG | Blue | .148 | 1.15 | CT-100, CT-600-A, CT-1550, CT-1551, CT-2500 | 100 | 1000 |
| BSN10-L | 12 – 10 AWG | Yellow | .210 | 1.14 | CT-100, CT-600-A, CT-1550, CT-1551, CT-2500 | 50 | 500 |

*Not UL Listed.

**To order in bulk, replace -C in the part number with -M for a bulk package of 1000 and replace -L with -D for a bulk package of 500.

For crimping tool information, see pages D1.83, D1.84, D1.86 and D1.88.

UL LISTED CERTIFIED **Butt Splice, Vinyl Insulated**

Type BSV

- Expanded wire entry designed to accommodate wire with a larger insulation thickness
- Designed to splice two solid or stranded wires together to repair or lengthen wires
- Brazed seam protects terminal barrel from splitting during the crimp process
- Internal wire stop assures proper length of insertion into terminal barrel
- UL Flammability UL 94V-0, maximum insulation temperature 221°F (105°C)
- UL and CSA rated up to 600 V per UL 486

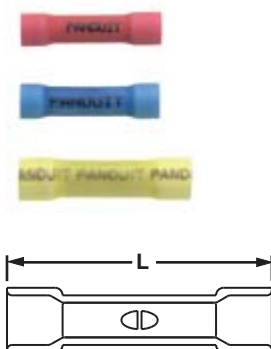

| Part Number | Wire Range | Color Code | Max. Ins. | Figure Dimensions (In.) | Recommended Installation Tool | Std. Pkg. Qty.** | Std. Ctn. Qty. |
|------------------|-------------|------------|-----------|-------------------------|---|------------------|----------------|
| | | | | L | | | |
| BSV18X-CY | 22 – 18 AWG | Red | .170 | 1.03 | CT-100, CT-600-A, CT-1550, CT-1551, CT-2500 | 100 | 1000 |
| BSV14X-C | 16 – 14 AWG | Blue | .200 | 1.04 | | 100 | 1000 |
| BSV10X-L | 12 – 10 AWG | Yellow | .250 | 1.18 | | 50 | 500 |

**To order in bulk, replace -C or -CY in the part number with -M or -MY for a bulk package of 1000 and replace -L with -D for a bulk package of 500.

For crimping tool information, see pages D1.83, D1.84, D1.86 and D1.88.

A. System Overview

B1. Cable Ties

B2. Cable Accessories

B3. Stainless Steel Ties

C1. Wiring Duct

C2. Surface Raceway

C3. Abrasion Protection

C4. Cable Management

D1. Terminals

D2. Power Connectors

D3. Grounding Connectors

E1. Labeling Systems

E2. Labels

E3. Pre-Printed & Write-On Markers

E4. Permanent Identification

E5. Lockout/Tagout & Safety Solutions

F. Index

A. System Overview

B1. Cable Ties



Butt Splice, Non-Insulated

Type BS

- Designed to splice two solid or stranded wires together to repair or lengthen wires
- Butted configuration provides low profile for limited space applications
- Brazed seam protects terminal barrel from splitting during the crimp process
- Internal wire stop assures proper length of insertion into terminal barrel
- Maximum recommended operating temperature 302°F (150°C)
- Non-insulated barrel can be used to provide an economical termination when insulation is not required

B2. Cable Accessories

B3. Stainless Steel Ties



C1. Wiring Duct



C2. Surface Raceway



C3. Abrasion Protection

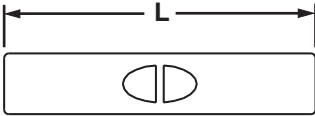

C4. Cable Management

D1. Terminals

D2. Power Connectors

D3. Grounding Connectors

| Part Number | Wire Range | Figure Dimensions (In.) | Recommended Installation Tool | Std. Pkg. Qty.** | Std. Ctn. Qty. |
|----------------|-------------|-------------------------|--|------------------|----------------|
| | | L | | | |
| BS22-C* | 26 – 22 AWG | .47 | CT-100 | 100 | 1000 |
| BS18-C | 22 – 18 AWG | .62 | CT-100, CT-200, CT-600-A, CT-1570, CT-2500 | 100 | 1000 |
| BS14-C | 16 – 14 AWG | .62 | CT-100, CT-200, CT-600-A, CT-1570, CT-2500 | 100 | 1000 |
| BS10-L | 12 – 10 AWG | .63 | CT-100, CT-200, CT-600-A, CT-1570, CT-2500, CT-1701‡ | 50 | 500 |

*Not UL Listed.
 **To order in bulk, replace -C in the part number with -M for a bulk package of 1000 and replace -L with -D for a bulk package of 500.
 ‡UL and CSA approved tooling/product combinations. For crimping tool information, see pages D1.83, D1.84, D1.86 and D1.88.

E1. Labeling Systems

E2. Labels

E3. Pre-Printed & Write-On Markers

Parallel Splice, Nylon Insulated

Type PSN

- Designed to splice two solid or stranded wires together to repair or lengthen wires
- Parallel design results in only one crimp required to complete splice
- Seamless tubular barrel provides a consistent high performance quality crimp
- UL Flammability UL 94V-2/HB, maximum insulation temperature 221°F (105°C)
- UL and CSA rated up to 300 V

E4. Permanent Identification



E5. Lockout/Tagout & Safety Solutions

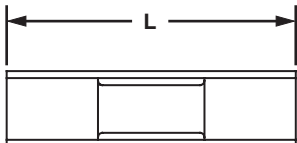

F. Index

| Part Number | Wire Range | Color Code | Max. Ins. | Figure Dimensions (In.) | Wire Strip Length (In.) | Recommended Installation Tool | Std. Pkg. Qty.** | Std. Ctn. Qty. |
|----------------|-------------|------------|-----------|-------------------------|-------------------------|-------------------------------|------------------|----------------|
| | | | | L | | | | |
| PSN18-C | 22 – 18 AWG | Red | .120 | .75 | 5/16 | CT-100, CT-1525, CT-2500 | 100 | 500 |
| PSN16-C | 20 – 16 AWG | Blue | .150 | .75 | 5/16 | | 100 | 500 |
| PSN12-L | 14 – 12 AWG | Yellow | .210 | .83 | 7/16 | CT-100 | 50 | 500 |

**To order in bulk, replace -C in the part number with -M for a bulk package of 1000 and replace -L with -D for a bulk package of 500.
 For crimping tool information, see pages D1.83, D1.84, and D1.88.



Parallel Splice, Non-Insulated

Type PS

- Designed to splice two solid or stranded wires together to repair or lengthen wires
- Parallel design results in only one crimp required to complete splice
- Seamless tubular barrel provides a consistent high performance quality crimp
- Maximum recommended operating temperature 302°F (150°C)
- Non-insulated barrel can be used to provide an economical termination when insulation is not required

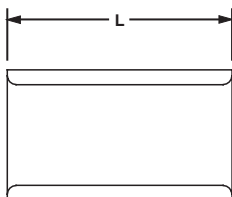

| Part Number | Wire Range | Color Code | Max. Ins. | Figure Dimensions (In.) | Wire Strip Length (In.) | Recommended Installation Tool | Std. Pkg. Qty.** | Std. Ctn. Qty. |
|---------------|-------------|------------|-----------|-------------------------|-------------------------|-------------------------------|------------------|----------------|
| | | | | L | | | | |
| PS18-C | 22 – 18 AWG | — | — | .29 | 5/16 | CT-100, CT-200 | 100 | 500 |
| PS16-C | 20 – 16 AWG | — | — | .29 | 5/16 | | 100 | 500 |
| PS12-L | 14 – 12 AWG | — | — | .38 | 7/16 | | 50 | 500 |

**To order in bulk, replace -C in the part number with -M for a bulk package of 1000 and replace -L with -D for a bulk package of 500.
For crimping tool information, see page D1.83.



Wire Joint, Nylon Insulated

Type JN

- Large barrel, designed to accommodate from one to seven wires with just one crimp
- Accommodates multiple wire sizes in varying combinations
- Barrel of terminal internally beveled to provide quick and easy wire insertion
- UL and CSA rated up to 600 V per UL 486
- UL Flammability UL 94V-2/HB, maximum insulation temperature 221°F (105°C)

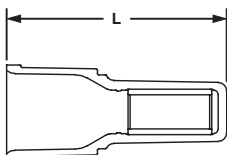

| Part Number | Wire Range | Color Code | CMA Range | | Figure Dimensions (In.) | Wire Strip Length (In.) | Recommended Installation Tool | Std. Pkg. Qty.** | Std. Ctn. Qty. |
|---------------------|-------------------|------------|-----------|-------|-------------------------|-------------------------|---------------------------------------|------------------|----------------|
| | | | Min. | Max. | L | | | | |
| JN224-318-C | (2) #24 – (2) #16 | Red | 808 | 5160 | .79 | 7/16 | CT-1550‡, CT-1551‡, CT-2500‡ | 100 | 1000 |
| JN218-216-C | (2) #22 – (2) #16 | Clear | 1284 | 5160 | .78 | 7/16 | CT-1550‡, CT-1551‡, CT-2500‡ | 100 | 1000 |
| JN418-212-C | (4) #18 – (2) #12 | Clear | 6480 | 14750 | .93 | 1/2 | CT-100‡, CT-1550‡, CT-1551‡, CT-2500‡ | 100 | 1000 |
| JN314-412-C* | (3) #14 – (4) #12 | Clear | 10320 | 26120 | .97 | 5/8 | CT-100, CT-160, CT-260 | 100 | 1000 |

*Not UL Listed.

**To order in bulk, replace -C in the part number with -M for a bulk package of 1000, with exception of JN418-212-C, replace -C with -D for bulk package of 500.

‡UL and CSA approved tooling/product combinations. For crimping tool information, see pages D1.83, D1.84, and D1.88.

Note: Wire combinations using #24 AWG wire are not UL Listed or CSA Certified.

A. System Overview

B1. Cable Ties

B2. Cable Accessories

B3. Stainless Steel Ties

C1. Wiring Duct

C2. Surface Raceway

C3. Abrasion Protection

C4. Cable Management

D1. Terminals

D2. Power Connectors

D3. Grounding Connectors

E1. Labeling Systems

E2. Labels

E3. Pre-Printed & Write-On Markers

E4. Permanent Identification

E5. Lockout/Tagout & Safety Solutions

F. Index

A. System Overview

B1. Cable Ties



Wire Joint, Non-Insulated

Type J

- Large barrel, designed to accommodate from one to seven wires with just one crimp
- Accommodates multiple wire sizes in varying combinations
- Non-insulated barrel can be used to provide an economical termination when insulation is not required
- Barrel of terminal internally beveled to provide quick and easy wire insertion
- Maximum recommended operating temperature 302°F (150°C)

B2. Cable Accessories

B3. Stainless Steel Ties

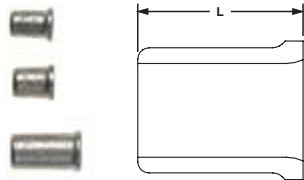

C1. Wiring Duct

C2. Surface Raceway

C3. Abrasion Protection



Heat Shrink, Butt Splices

Type BSH

- Designed to splice two solid or stranded wires together to repair or lengthen wires
- Butted configuration provides low profile for limited space applications
- Heat shrink polyolefin sleeve with hot melt adhesive protects against moisture
- After crimping, heat shrink insulation is completed with a standard heat gun
- Minimum continuous operating temperature -65°F (-55°C)
- Maximum continuous operation temperature 230°F (110°C)
- Shrink temperature 250°F (120°C)

C4. Cable Management

D1. Terminals



| Part Number | Wire Range | Color Code | Max. Ins. | Figure Dimensions (In.) | Wire Strip Length (In.) | Recommended Installation Tool | Std. Pkg. Qty.** | Std. Ctn. Qty. |
|----------------|-------------|------------|-----------|-------------------------|-------------------------|-------------------------------|------------------|----------------|
| | | | | L | | | | |
| BSH18-Q | 22 – 18 AWG | Red | .170 | 1.45 | 5/16 | CT-310 | 25 | 125 |
| BSH14-Q | 16 – 14 AWG | Blue | .190 | 1.45 | 5/16 | CT-310 | 25 | 125 |
| BSH10-E | 12 – 10 AWG | Yellow | .240 | 1.64 | 5/16 | CT-310 | 20 | 100 |

**To order in bulk, replace -Q in the part number with -D for a bulk package of 500 and replace -E with -T for a bulk package of 200.
For crimping tool information, see page D1.85.

D2. Power Connectors

D3. Grounding Connectors

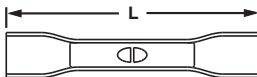

E1. Labeling Systems

Metric Butt Splice, Vinyl Insulated

Type BSMV

- Expanded wire entry designed to accommodate wire with a larger insulation thickness
- Designed to splice two solid or stranded wires together to repair or lengthen wires
- Brazed seam protects terminal barrel from splitting during the crimp process
- Internal wire stop assures proper length of insertion into terminal barrel

E2. Labels

E3. Pre-Printed & Write-On Markers



| Part Number | Wire Range (mm²) | Color Code | Max Ins. | Figure Dimensions (mm) | Recommended Installation Tool | Std. Pkg. Qty. | Std. Ctn. Qty. |
|-------------------------------|------------------|------------|----------|------------------------|-------------------------------|----------------|----------------|
| | | | | L | | | |
| BSMV1BX-CY[^] | .5 – 1.5 | Red | 4.3 | 26.4 | CT-1551 | 100 | 500 |
| BSMV2BX-C[^] | 1.5 – 2.5 | Blue | 5.1 | 26.4 | CT-1551 | 100 | 500 |
| BSMV6X-L[*] | 2.5 – 6.0 | Yellow | 6.4 | 30.0 | CT-1551 | 50 | 250 |

*Brazed seam.
**To order bulk, replace -C, or -CY in the part number with -M, or -MY for a bulk package of 1000 and replace -L with -D for bulk package of 500.
[^]Butted seam.
For crimping tool information, see page D1.84.

E4. Permanent Identification

E5. Lockout/Tagout & Safety Solutions

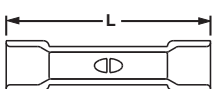

F. Index

Metric Butt Splice, Non-Insulated

Type BSM

- Designed to splice two solid or stranded wires together to repair or lengthen wires
- Butted configuration provides low profile for limited space applications
- Brazed seam protects terminal barrel from splitting during the crimp process
- Internal wire stop assures proper length of insertion into terminal barrel
- Maximum recommended operating temperature 302°F (150°C)
- Non-insulated barrel can be used to provide an economical termination when insulation is not required



| Part Number | Wire Range (mm²) | Figure Dimensions (mm) | Recommended Installation Tool | Std. Pkg. Qty. | Std. Ctn. Qty. |
|-------------|------------------|------------------------|-------------------------------|----------------|----------------|
| | | L | | | |
| BSM1-C | .5 – 1.5 | 15.7 | CT-1570, CT-2500 | 100 | 500 |
| BSM2-C | 1.5 – 2.5 | 15.7 | | 100 | 500 |
| BSM6-L | 2.5 – 6.0 | 18.2 | | 50 | 250 |

For crimping tool information, see pages D1.84 and D1.88.

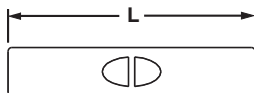

Metric Wire Joints, Nylon Insulated

Type JMN

- Large barrel, designed to accommodate from one to seven wires with just one crimp
- Accommodates multiple wire sizes in varying combinations
- Barrel of terminal internally beveled to provide quick and easy wire insertion



| Part Number | Wire Range (mm²) | Color Code | CMA Range Min. | CMA Range Max. | Figure Dimensions (mm) | Recommended Installation Tool | Std. Pkg. Qty. | Std. Ctn. Qty. |
|-------------|------------------|------------|----------------|----------------|------------------------|-------------------------------|----------------|----------------|
| | | | | | L | | | |
| JMN2-C | .5 – 2.5 | Clear | 1284 | 5160 | 19.9 | CT-1551 | 100 | 500 |
| JMN6-C | .75 – 6.0 | Clear | 6480 | 14750 | 23.9 | CT-1551 | 100 | 500 |

For crimping tool information, see page D1.84.

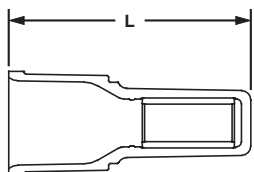

A.
System
Overview

B1.
Cable
Ties

B2.
Cable
Accessories

B3.
Stainless
Steel Ties

C1.
Wiring
Duct

C2.
Surface
Raceway

C3.
Abrasion
Protection

C4.
Cable
Management

D1.
Terminals

D2.
Power
Connectors

D3.
Grounding
Connectors

E1.
Labeling
Systems

E2.
Labels

E3.
Pre-Printed
& Write-On
Markers

E4.
Permanent
Identification

E5.
Lockout/
Tagout
& Safety
Solutions

F.
Index

A. System Overview

B1. Cable Ties

B2. Cable Accessories

B3. Stainless Steel Ties

C1. Wiring Duct

C2. Surface Raceway

C3. Abrasion Protection

C4. Cable Management

D1. Terminals

D2. Power Connectors

D3. Grounding Connectors

E1. Labeling Systems

E2. Labels

E3. Pre-Printed & Write-On Markers

E4. Permanent Identification

E5. Lockout/Tagout & Safety Solutions

F. Index

PAN-TERM® FERRULES

PANDUIT® PAN-TERM® Ferrule end sleeves terminate stranded wire into terminal blocks with superior termination performance. A wide assortment of ferrule styles and tool designs provide a proven way to make reliable connections, especially for limited space applications. Insulation flare allows for ease of wire insertion and eliminates loose strands of wire. Encapsulated crimp contains loose wires to eliminate stray wire breakage.



- Ideal for control panel and terminal block applications
- Insulated single wire range of #26 – 1 AWG, sizes meets French and DIN color code standards
- Insulated twin wire end sleeve range of #22 – 10 AWG, sizes meets DIN color code standard
- Non-insulated wire range of #24 – 1 AWG
- Insulated ferrules single wire range #20 – 14 AWG, available in strips of 50 for use with the semiautomatic ferrule crimping tool, CT-1000, for improved reliability and productivity
- Wide assortment of controlled cycle, crimping tools for reliable connections at the lowest installed cost

PANDUIT continually provides new designs to meet the application challenges encountered by our customers. PANDUIT offers a wide assortment of PAN-TERM® termination products to meet customer needs at the lowest installed cost.

Features and Benefits – PAN-TERM® Ferrules

PANDUIT ferrules are available for wiring applications from #26 – 1 AWG. Offerings include insulated and non-insulated ferrules, in single-wire or double-wire configurations. Insulated ferrules are color-coded to DIN or French standards. Crimped on the metal barrel these ferrules provide improved performance for terminal block and panel building applications.

| | |
|---|---|
| <p style="text-align: center;">Insulated Ferrules – Single Wire Type FSF and FSD</p> | <p style="text-align: center;">Insulated Ferrules – Twin Wire Type FTD</p> |
|---|---|

Non-Insulated Ferrules

Type F



PANDUIT provides a wide assortment of crimping tools for reliable connections at the lowest installed cost.

See page D1.85.



PANDUIT designs and manufactures a full line of labeling products, software, and printers to assist you with your labeling requirements.

See pages E1.1 – E2.30.

A.
System
Overview

B1.
Cable Ties

B2.
Cable
Accessories

B3.
Stainless
Steel Ties

C1.
Wiring
Duct

C2.
Surface
Raceway

C3.
Abrasion
Protection

C4.
Cable
Management

D1.
Terminals

D2.
Power
Connectors

D3.
Grounding
Connectors

E1.
Labeling
Systems

E2.
Labels

E3.
Pre-Printed
& Write-On
Markers

E4.
Permanent
Identification

E5.
Lockout/
Tagout
& Safety
Solutions

F.
Index

A.
System
Overview

Selection Guide – PAN-TERM® Ferrules

B1.
Cable Ties

B2.
Cable
Accessories

B3.
Stainless
Steel Ties

C1.
Wiring
Duct

C2.
Surface
Raceway

C3.
Abrasion
Protection

C4.
Cable
Management

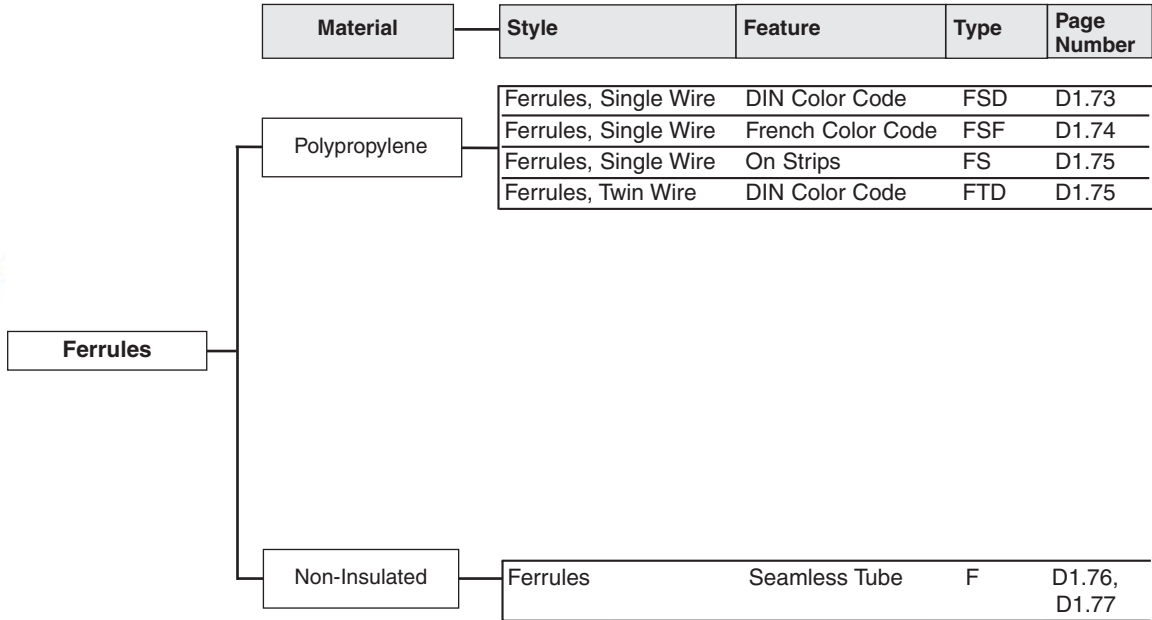

D1.
Terminals

Part Number System for PAN-TERM® Ferrules

D2.
Power
Connectors

D3.
Grounding
Connectors

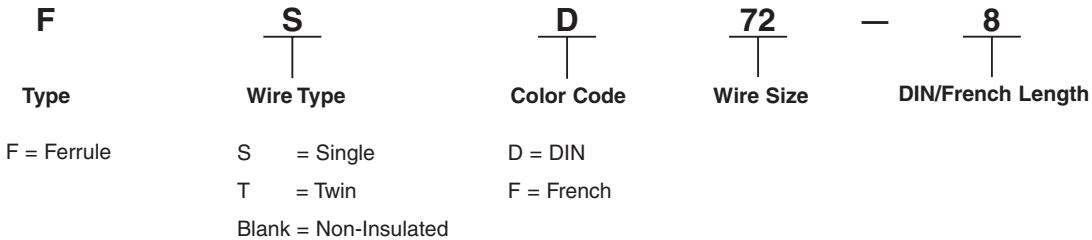

E1.
Labeling
Systems

E2.
Labels

E3.
Pre-Printed
& Write-On
Markers

E4.
Permanent
Identification

E5.
Lockout/
Tagout/
& Safety
Solutions

F.
Index

Insulated Ferrules – Single Wire DIN End Sleeve

Type FSD

- Polypropylene insulation housing conforms to DIN color requirements
- Meets DIN standards for single wire containment
- Funnel entry for faster insertion and lower installed cost
- Designed with a seamless barrel to contain loose wire strands for superior terminations
- Eases insertion of wire into terminal block
- Suitable for limited space panel applications
- Multiple pin lengths available for a variety of terminal blocks

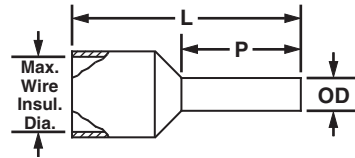

| Part Number | Wire Size | | Color Code | Max. Wire Insul. Dia. | | Figure Dimensions | | | | | | Wire Strip Length | | Recommended Installation Tool | Std. Pkg. Qty. | |
|-------------|-----------|-----------------|------------|-----------------------|------|-------------------|------|------|------|------|-------|-------------------|-------|-------------------------------|----------------|-----|
| | AWG | mm ² | | In. | mm | L | | P | | OD | | In. | mm | | | |
| FSD72-6-D | 26 AWG | .14 | Gray | .07 | 1.7 | .41 | 10.5 | .24 | 6.0 | .05 | 1.3 | 3/8 | 9.5 | CT-1002, CT-1123 | 500 | |
| FSD72-8-D | | | | .07 | 1.7 | .49 | 12.5 | .31 | 8.0 | .05 | 1.3 | 15/32 | 11.9 | | 500 | |
| FSD73-6-D | | | | .07 | 1.7 | .41 | 10.5 | .24 | 6.0 | .05 | 1.3 | 3/8 | 9.5 | | 500 | |
| FSD73-8-D | 24 AWG | .25 | Yellow | .07 | 1.7 | .49 | 12.5 | .31 | 8.0 | .05 | 1.3 | 15/32 | 11.9 | CT-1002, CT-1123 | 500 | |
| FSD74-6-D | | | Turquoise | .07 | 1.7 | .41 | 10.5 | .24 | 6.0 | .05 | 1.3 | 3/8 | 9.5 | | 500 | |
| FSD74-8-D | | | | .07 | 1.7 | .49 | 12.5 | .31 | 8.0 | .05 | 1.3 | 15/32 | 11.9 | | 500 | |
| FSD75-6-D | 22 AWG | .50 | White | .09 | 2.2 | .45 | 11.5 | .24 | 6.0 | .06 | 1.4 | 3/8 | 9.5 | CT-1002, CT-1003, CT-1123 | 500 | |
| FSD75-8-D | | | | | .09 | 2.2 | .53 | 13.5 | .31 | 8.0 | .06 | 1.4 | 15/32 | | 11.9 | 500 |
| FSD75-10-D | | | | | .09 | 2.2 | .61 | 15.5 | .39 | 10.0 | .06 | 1.4 | 17/32 | | 13.5 | 500 |
| FSD76-6-D | 20 AWG | .75 | Gray | .09 | 2.4 | .47 | 12.0 | .24 | 6.0 | .06 | 1.6 | 3/8 | 9.5 | CT-1002, CT-1003, CT-1123 | 500 | |
| FSD76-8-D | | | | | .09 | 2.4 | .55 | 14.0 | .31 | 8.0 | .06 | 1.6 | 15/32 | | 11.9 | 500 |
| FSD76-10-D | | | | | .09 | 2.4 | .63 | 16.0 | .39 | 10.0 | .06 | 1.6 | 17/32 | | 13.5 | 500 |
| FSD76-12-D | | | | | .09 | 2.4 | .71 | 18.0 | .47 | 12.0 | .06 | 1.6 | 5/8 | | 15.9 | 500 |
| FSD77-6-D | 18 AWG | 1.0 | Red | .11 | 2.7 | .49 | 12.5 | .24 | 6.0 | .07 | 1.8 | 3/8 | 9.5 | CT-1002, CT-1003, CT-1123 | 500 | |
| FSD77-8-D | | | | | .11 | 2.7 | .57 | 14.5 | .31 | 8.0 | .07 | 1.8 | 15/32 | | 11.9 | 500 |
| FSD77-10-D | | | | | .11 | 2.7 | .65 | 16.5 | .39 | 10.0 | .07 | 1.8 | 17/32 | | 13.5 | 500 |
| FSD77-12-D | | | | | .11 | 2.7 | .73 | 18.5 | .47 | 12.0 | .07 | 1.8 | 5/8 | | 15.9 | 500 |
| FSD78-6-D | 16 AWG | 1.5 | Black | .12 | 3.0 | .49 | 12.5 | .24 | 6.0 | .08 | 2.1 | 3/8 | 9.5 | CT-1002, CT-1003, CT-1123 | 500 | |
| FSD78-8-D | | | | | .12 | 3.0 | .57 | 14.5 | .31 | 8.0 | .08 | 2.1 | 15/32 | | 11.9 | 500 |
| FSD78-10-D | | | | | .12 | 3.0 | .65 | 16.5 | .39 | 10.0 | .08 | 2.1 | 17/32 | | 13.5 | 500 |
| FSD78-12-D | | | | | .12 | 3.0 | .73 | 18.5 | .47 | 12.0 | .08 | 2.1 | 5/8 | | 15.9 | 500 |
| FSD78-18-D | | | | .12 | 3.0 | .96 | 24.5 | .71 | 18.0 | .08 | 2.1 | 7/8 | 22.2 | | 500 | |
| FSD79-8-D | 14 AWG | 2.1 | Yellow | .13 | 3.2 | .57 | 14.5 | .31 | 8.0 | .09 | 2.4 | 15/32 | 11.9 | CT-1003, CT-1004, CT-1123 | 500 | |
| FSD80-8-D | | | .15 | 3.7 | .59 | 15.0 | .31 | 8.0 | .10 | 2.6 | 15/32 | 11.9 | 500 | | | |
| FSD80-12-D | | | .15 | 3.7 | .75 | 19.0 | .47 | 12.0 | .10 | 2.6 | 5/8 | 15.9 | 500 | | | |
| FSD80-18-D | | | | .15 | 3.7 | .98 | 25.0 | .71 | 18.0 | .10 | 2.6 | 7/8 | 22.2 | | 500 | |
| FSD81-10-D | 12 AWG | 4.0 | Gray | .17 | 4.3 | .69 | 17.5 | .39 | 10.0 | .13 | 3.3 | 17/32 | 13.5 | CT-1004 | 500 | |
| FSD81-12-C | | | | | .17 | 4.3 | .79 | 20.0 | .47 | 12.0 | .13 | 3.3 | 5/8 | | 15.9 | 100 |
| FSD81-18-C | | | | | .17 | 4.3 | 1.02 | 26.0 | .71 | 18.0 | .13 | 3.3 | 7/8 | | 22.2 | 100 |
| FSD82-12-C | 10 AWG | 6.0 | Yellow | .22 | 5.5 | .79 | 20.0 | .47 | 12.0 | .16 | 4.0 | 5/8 | 15.9 | CT-1005 | 100 | |
| FSD82-18-C | | | | | .22 | 5.5 | 1.02 | 26.0 | .71 | 18.0 | .16 | 4.0 | 7/8 | | 22.2 | 100 |
| FSD83-12-C | 8 AWG | 10.0 | Red | .27 | 6.8 | .83 | 21.0 | .47 | 12.0 | .20 | 5.0 | 5/8 | 15.9 | CT-1006 | 100 | |
| FSD83-18-C | | | | | .27 | 6.8 | 1.06 | 27.0 | .71 | 18.0 | .20 | 5.0 | 7/8 | | 22.2 | 100 |
| FSD84-12-C | 6 AWG | 16.0 | Blue | .32 | 8.2 | .91 | 23.0 | .47 | 12.0 | .25 | 6.4 | 5/8 | 15.9 | CT-1005 | 100 | |
| FSD84-18-C | | | | | .32 | 8.2 | 1.14 | 29.0 | .71 | 18.0 | .25 | 6.4 | 7/8 | | 22.2 | 100 |
| FSD85-16-L | 4 AWG | 25.0 | Yellow | .41 | 10.3 | 1.14 | 29.0 | .63 | 16.0 | .31 | 7.9 | 3/4 | 19.1 | CT-1005 | 50 | |
| FSD85-18-L | | | | | .41 | 10.3 | 1.22 | 31.0 | .71 | 18.0 | .31 | 7.9 | 7/8 | | 22.2 | 50 |
| FSD85-22-L | | | | .41 | 10.3 | 1.38 | 35.0 | .87 | 22.0 | .31 | 7.9 | 1 | 25.4 | | 50 | |
| FSD86-16-L | 2 AWG | 35.0 | Red | .45 | 11.5 | 1.18 | 30.0 | .63 | 16.0 | .35 | 8.9 | 3/4 | 19.1 | CT-1005 | 50 | |
| FSD86-18-L | | | | | .45 | 11.5 | 1.26 | 32.0 | .71 | 18.0 | .35 | 8.9 | 7/8 | | 22.2 | 50 |
| FSD86-25-L | | | | | .45 | 11.5 | 1.54 | 39.0 | .98 | 25.0 | .35 | 8.9 | 1 1/8 | | 28.6 | 50 |
| FSD87-20-L | 1 AWG | 50.0 | Blue | .54 | 13.7 | 1.42 | 36.0 | .79 | 20.0 | .44 | 11.1 | 15/16 | 23.8 | CT-1006 | 50 | |
| FSD87-25-Q | | | | | .54 | 13.7 | 1.61 | 41.0 | .98 | 25.0 | .44 | 11.1 | 1 1/8 | | 28.6 | 25 |

For crimping tool information, see page D1.85

A. System Overview

B1. Cable Ties

B2. Cable Accessories

B3. Stainless Steel Ties

C1. Wiring Duct

C2. Surface Raceway

C3. Abrasion Protection

C4. Cable Management

D1. Terminals

D2. Power Connectors

D3. Grounding Connectors

E1. Labeling Systems

E2. Labels

E3. Pre-Printed & Write-On Markers

E4. Permanent Identification

E5. Lockout/Tagout & Safety Solutions

F. Index

A. System Overview

Insulated Ferrules – Single Wire French End Sleeve Type FSF

B1. Cable Ties

- Polypropylene insulation housing conforms to French color requirements
- Meets DIN standards for single wire containment
- Funnel entry for faster insertion and lower installed cost

- Eases insertion of wire into terminal block
- Suitable for limited space panel applications
- Multiple pin lengths available for a variety of terminal blocks

B2. Cable Accessories

- Designed with a seamless barrel to contain loose wire strands for superior terminations



B3. Stainless Steel Ties

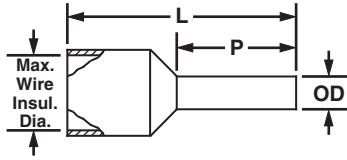

C1. Wiring Duct

C2. Surface Raceway

C3. Abrasion Protection

C4. Cable Management

D1. Terminals

D2. Power Connectors

D3. Grounding Connectors

E1. Labeling Systems

E2. Labels

E3. Pre-Printed & Write-On Markers

E4. Permanent Identification

E5. Lockout/Tagout & Safety Solutions

F. Index

| Part Number | Wire Size | | Color Code | Max. Wire Insul. Dia. | | Figure Dimensions | | | | | | Wire Strip Length | | Recommended Installation Tool | Std. Pkg. Qty. |
|------------------|-----------|-----------------|------------|-----------------------|------|-------------------|------|------|------|------|------|-------------------|------|-------------------------------|----------------|
| | AWG | mm ² | | In. | mm | L | | P | | OD | | In. | mm | | |
| FSF72-6-D | 26 AWG | .14 | Brown | .07 | 1.7 | .41 | 10.5 | .24 | 6.0 | .05 | 1.3 | 3/8 | 9.5 | CT-1002, CT-1123 | 500 |
| FSF72-8-D | | | | .07 | 1.7 | .49 | 12.5 | .31 | 8.0 | .05 | 1.3 | 15/32 | 11.9 | | 500 |
| FSF73-6-D | 24 AWG | .25 | Violet | .07 | 1.7 | .41 | 10.5 | .24 | 6.0 | .05 | 1.3 | 3/8 | 9.5 | | 500 |
| FSF73-8-D | | | | .07 | 1.7 | .49 | 12.5 | .31 | 8.0 | .05 | 1.3 | 15/32 | 11.9 | | 500 |
| FSF74-6-D | | .34 | Pink | .07 | 1.7 | .41 | 10.5 | .24 | 6.0 | .05 | 1.3 | 3/8 | 9.5 | | 500 |
| FSF74-8-D | | | | .07 | 1.7 | .49 | 12.5 | .31 | 8.0 | .05 | 1.3 | 15/32 | 11.9 | | 500 |
| FSF75-6-D | 22 AWG | .50 | White | .09 | 2.2 | .45 | 11.5 | .24 | 6.0 | .06 | 1.4 | 3/8 | 9.5 | 500 | |
| FSF75-8-D | | | | .09 | 2.2 | .53 | 13.5 | .31 | 8.0 | .06 | 1.4 | 15/32 | 11.9 | 500 | |
| FSF75-10-D | | | | .09 | 2.2 | .61 | 15.5 | .39 | 10.0 | .06 | 1.4 | 17/32 | 13.5 | 500 | |
| FSF76-6-D | 20 AWG | .75 | Blue | .09 | 2.4 | .47 | 12.0 | .24 | 6.0 | .06 | 1.6 | 3/8 | 9.5 | 500 | |
| FSF76-8-D | | | | .09 | 2.4 | .55 | 14.0 | .31 | 8.0 | .06 | 1.6 | 15/32 | 11.9 | 500 | |
| FSF76-10-D | | | | .09 | 2.4 | .63 | 16.0 | .39 | 10.0 | .06 | 1.6 | 17/32 | 13.5 | 500 | |
| FSF76-12-D | | | | .09 | 2.4 | .71 | 18.0 | .47 | 12.0 | .06 | 1.6 | 5/8 | 15.9 | 500 | |
| FSF77-6-D | 18 AWG | 1.0 | Red | .11 | 2.7 | .49 | 12.5 | .24 | 6.0 | .07 | 1.8 | 3/8 | 9.5 | 500 | |
| FSF77-8-D | | | | .11 | 2.7 | .57 | 14.5 | .31 | 8.0 | .07 | 1.8 | 15/32 | 11.9 | 500 | |
| FSF77-10-D | | | | .11 | 2.7 | .65 | 16.5 | .39 | 10.0 | .07 | 1.8 | 17/32 | 13.5 | 500 | |
| FSF77-12-D | 16 AWG | 1.5 | Black | .11 | 2.7 | .73 | 18.5 | .47 | 12.0 | .07 | 1.8 | 5/8 | 15.9 | 500 | |
| FSF78-6-D | | | | .12 | 3.0 | .49 | 12.5 | .24 | 6.0 | .08 | 2.1 | 3/8 | 9.5 | CT-1002, CT-1003, CT-1123 | 500 |
| FSF78-8-D | | | | .12 | 3.0 | .57 | 14.5 | .31 | 8.0 | .08 | 2.1 | 15/32 | 11.9 | | 500 |
| FSF78-10-D | | | | .12 | 3.0 | .65 | 16.5 | .39 | 10.0 | .08 | 2.1 | 17/32 | 13.5 | | 500 |
| FSF78-12-D | .12 | 3.0 | .73 | 18.5 | .47 | 12.0 | .08 | 2.1 | 5/8 | 15.9 | 500 | | | | |
| FSF78-18-D | 14 AWG | 2.1 | Yellow | .12 | 3.0 | .96 | 24.5 | .71 | 18.0 | .08 | 2.1 | 7/8 | 22.2 | 500 | |
| FSF79-8-D | | | | .13 | 3.2 | .57 | 14.5 | .31 | 8.0 | .09 | 2.4 | 15/32 | 11.9 | 500 | |
| FSF80-8-D | | | | .15 | 3.7 | .59 | 15.0 | .31 | 8.0 | .10 | 2.6 | 15/32 | 11.9 | 500 | |
| FSF80-12-D | 2.5 | Gray | .15 | 3.7 | .75 | 19.0 | .47 | 12.0 | .10 | 2.6 | 5/8 | 15.9 | 500 | | |
| FSF80-18-D | | | .15 | 3.7 | .98 | 25.0 | .71 | 18.0 | .10 | 2.6 | 7/8 | 22.2 | 500 | | |
| FSF81-10-D | 12 AWG | 4.0 | Orange | .17 | 4.3 | .69 | 17.5 | .39 | 10.0 | .13 | 3.3 | 17/32 | 13.5 | 500 | |
| FSF81-12-C | | | | .17 | 4.3 | .79 | 20.0 | .47 | 12.0 | .13 | 3.3 | 5/8 | 15.9 | 100 | |
| FSF81-18-C | | | | .17 | 4.3 | 1.02 | 26.0 | .71 | 18.0 | .13 | 3.3 | 7/8 | 22.2 | 100 | |
| FSF82-12-C | 10 AWG | 6.0 | Green | .22 | 5.5 | .79 | 20.0 | .47 | 12.0 | .16 | 4.0 | 5/8 | 15.9 | 100 | |
| FSF82-18-C | | | | .22 | 5.5 | 1.02 | 26.0 | .71 | 18.0 | .16 | 4.0 | 7/8 | 22.2 | 100 | |
| FSF83-12-C | 8 AWG | 10.0 | Brown | .27 | 6.8 | .83 | 21.0 | .47 | 12.0 | .20 | 5.0 | 5/8 | 15.9 | CT-1003, CT-1004, CT-1123 | 100 |
| FSF83-18-C | | | | .27 | 6.8 | 1.06 | 27.0 | .71 | 18.0 | .20 | 5.0 | 7/8 | 22.2 | | 100 |
| FSF84-12-C | 6 AWG | 16.0 | White | .32 | 8.2 | .91 | 23.0 | .47 | 12.0 | .25 | 6.4 | 5/8 | 15.9 | CT-1004 | 100 |
| FSF84-18-C | | | | .32 | 8.2 | 1.14 | 29.0 | .71 | 18.0 | .25 | 6.4 | 7/8 | 22.2 | | 100 |
| FSF85-16-L | 4 AWG | 25.0 | Black | .41 | 10.3 | 1.14 | 29.0 | .63 | 16.0 | .31 | 7.9 | 3/4 | 19.1 | 50 | |
| FSF85-18-L | | | | .41 | 10.3 | 1.22 | 31.0 | .71 | 18.0 | .31 | 7.9 | 7/8 | 22.2 | 50 | |
| FSF85-22-L | | | | .41 | 10.3 | 1.38 | 35.0 | .87 | 22.0 | .31 | 7.9 | 1 | 25.4 | 50 | |
| FSF86-16-L | 2 AWG | 35.0 | Red | .45 | 11.5 | 1.18 | 30.0 | .63 | 16.0 | .35 | 8.9 | 3/4 | 19.1 | 50 | |
| FSF86-18-L | | | | .45 | 11.5 | 1.26 | 32.0 | .71 | 18.0 | .35 | 8.9 | 7/8 | 22.2 | 50 | |
| FSF86-25-L | | | | .45 | 11.5 | 1.54 | 39.0 | .98 | 25.0 | .35 | 8.9 | 1 1/8 | 28.6 | 50 | |
| FSF87-20-L | 1 AWG | 50.0 | Blue | .54 | 13.7 | 1.42 | 36.0 | .79 | 20.0 | .44 | 11.1 | 15/16 | 23.8 | CT-1006 | 50 |
| FSF87-25-Q | | | | .54 | 13.7 | 1.61 | 41.0 | .98 | 25.0 | .44 | 11.1 | 1 1/8 | 28.6 | | 25 |

For crimping tool information, see page D1.85.

Insulated Ferrules – Twin Wire DIN End Sleeve

Type FTD

- Meets DIN standards for twin wire containment
- Polypropylene insulation housing conforms to DIN color requirements
- Funnel entry for faster insertion and lower installed cost
- Designed with a seamless barrel to contain loose wire strands for superior terminations

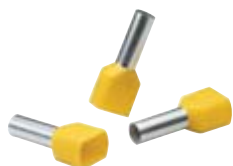

- Eases insertion of wire into terminal block
- Suitable for limited space panel applications
- Multiple pin lengths available for a variety of terminal blocks

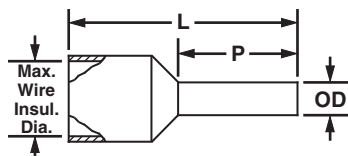

| Part Number | Wire Size | | Color Code | Max. Wire Insul. Dia. | | Figure Dimensions | | | | | | Wire Strip Length | Recommended Installation Tool | Std. Pkg. Qty. | |
|--------------------|-----------|-----|------------|-----------------------|-----|-------------------|------|-----|------|-----|-----|-------------------|-------------------------------|---------------------------|-----|
| | AWG | mm² | | In. | mm | L | | P | | OD | | | | | |
| FTD75-8-D | 22 AWG | .50 | White | .87 | 2.2 | .59 | 15.0 | .31 | 8.0 | .07 | 1.8 | 7/16 | 11.2 | CT-1002, CT-1003, CT-1123 | 500 |
| FTD76-8-D | 20 AWG | .75 | Gray | .09 | 2.4 | .59 | 15.0 | .31 | 8.0 | .08 | 2.1 | 7/16 | 11.2 | | 500 |
| FTD76-10-D | | | | .09 | 2.4 | .67 | 17.0 | .39 | 10.0 | .08 | 2.1 | 9/16 | 14.0 | | 500 |
| FTD77-8-D | 18 AWG | 1.0 | Red | .11 | 2.7 | .59 | 15.0 | .31 | 8.0 | .09 | 2.4 | 7/16 | 11.2 | | 500 |
| FTD77-10-D | | | | .11 | 2.7 | .67 | 17.0 | .39 | 10.0 | .09 | 2.4 | 9/16 | 14.0 | | 500 |
| FTD78-8-D | 16 AWG | 1.5 | Black | .12 | 3.0 | .63 | 16.0 | .31 | 8.0 | .10 | 2.6 | 7/16 | 11.2 | | 500 |
| FTD78-12-D | | | | .12 | 3.0 | .79 | 20.0 | .47 | 12.0 | .10 | 2.6 | 21/32 | 16.8 | | 500 |
| FTD80-10-TL | 14 AWG | 2.5 | Blue | .15 | 3.7 | .73 | 18.5 | .39 | 10.0 | .13 | 3.3 | 9/16 | 14.0 | | 250 |
| FTD80-13-TL | | | | .15 | 3.7 | .85 | 21.5 | .51 | 13.0 | .13 | 3.3 | 23/32 | 16.2 | | 250 |
| FTD81-12-C | 12 AWG | 4.0 | Gray | .17 | 4.3 | .91 | 23.0 | .47 | 12.0 | .17 | 4.2 | 21/32 | 16.8 | | 100 |
| FTD82-14-C | 10 AWG | 6.0 | Yellow | .19 | 4.8 | .98 | 25.0 | .55 | 14.0 | .20 | 5.0 | 25/32 | 19.6 | CT-1003, CT-1004 | 100 |

For crimping tool information, see page D1.85.

Insulated Ferrules on Strips – Single Wire

Type FS

- Polypropylene insulation housing available in DIN standard colors in strips of 50
- Continuously molded design provides consistent placement of ferrules in tool to ensure fast, reliable terminations

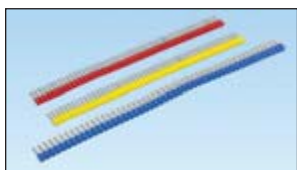

- Available in #20 – 14 AWG featuring a seamless barrel design to contain loose wire strands for superior terminations
- Designed for use with the Semiautomatic Ferrule Crimping Tool CT-1000 for medium volume applications

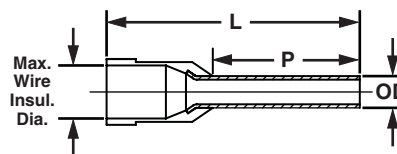

| Part Number | Wire Size | | Color Code | Max. Wire Insul. Dia. | | Figure Dimensions | | | | | | Wire Strip Length | Recommended Installation Tool | Std. Pkg. Qty. | |
|---------------------------------------|-----------|------|------------|-----------------------|-----|-------------------|------|------|-----|-----|-----|-------------------|-------------------------------|----------------|-----|
| | AWG | mm² | | In. | mm | L | | P | | OD | | | | | |
| DIN End Sleeves | | | | | | | | | | | | | | | |
| FSD75-8-DSL10 | 20 AWG | .50 | White | .10 | 2.6 | .60 | 15.2 | .31 | 8.0 | .05 | 1.4 | 13/32 | 10 | CT-1000 | 500 |
| FSD76-8-DSL8 | 18 AWG | .75 | Gray | .11 | 2.7 | .60 | 15.2 | .31 | 8.0 | .07 | 1.8 | 13/32 | 10 | | 500 |
| FSD77-8-DSL2 | | 1.00 | Red | .12 | 3.0 | .60 | 15.2 | .31 | 8.0 | .08 | 2.1 | 13/32 | 10 | | 500 |
| FSD78-8-DSL0 | 16 AWG | 1.50 | Black | .13 | 3.2 | .60 | 15.2 | .31 | 8.0 | .10 | 2.6 | 13/32 | 10 | | 500 |
| FSD80-8-DSL6 | 14 AWG | 2.50 | Blue | .16 | 4.0 | .60 | 15.2 | .31 | 8.0 | .10 | 2.6 | 13/32 | 10 | | 500 |
| Additional Colored End Sleeves | | | | | | | | | | | | | | | |
| FS75-8-DSL3 | 20 AWG | .50 | Orange | .10 | 2.6 | .60 | 15.2 | .31 | 8.0 | .05 | 1.4 | 13/32 | 10 | CT-1000 | 500 |
| FS76-8-DSL10 | 18 AWG | .75 | White | .11 | 2.7 | .60 | 15.2 | .31 | 8.0 | .06 | 1.6 | 13/32 | 10 | | 500 |
| FS76-8-DSL7 | | | Light Blue | .11 | 2.7 | .60 | 15.2 | .31 | 8.0 | .06 | 1.6 | 13/32 | 10 | | 500 |
| FS77-8-DSL4 | | | 1.00 | Yellow | .12 | 3.0 | .60 | 15.2 | .31 | 8.0 | .07 | 1.8 | 13/32 | | 10 |
| FS78-8-DSL2 | 16 AWG | 1.50 | Red | .13 | 3.2 | .60 | 15.2 | .31 | 8.0 | .08 | 2.1 | 13/32 | 10 | | 500 |
| FS80-8-DSL8 | 14 AWG | 2.50 | Gray | .16 | 4.0 | .60 | 15.2 | .31 | 8.0 | .10 | 2.6 | 13/32 | 10 | | 500 |

For crimping tool information, see page D1.86.

A. System Overview

B1. Cable Ties

B2. Cable Accessories

B3. Stainless Steel Ties

C1. Wiring Duct

C2. Surface Raceway

C3. Abrasion Protection

C4. Cable Management

D1. Terminals

D2. Power Connectors

D3. Grounding Connectors

E1. Labeling Systems

E2. Labels

E3. Pre-Printed & Write-On Markers

E4. Permanent Identification

E5. Lockout/Tagout & Safety Solutions

F. Index

A.
System
Overview

Ferrules, Non-Insulated

B1.
Cable Ties

Type F

B2.
Cable
Accessories

- Designed with a seamless barrel to contain loose wire strands for superior terminations
- Eases insertion of wire into terminal block

- Meets DIN standards for wire containment
- Suitable for limited space panel applications
- Multiple pin lengths available for a variety of terminal blocks

B3.
Stainless
Steel Ties

C1.
Wiring
Duct

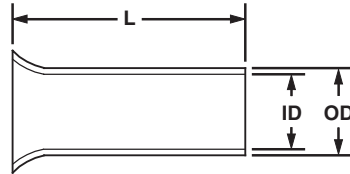

C2.
Surface
Raceway

C3.
Abrasion
Protection

C4.
Cable
Management

D1.
Terminals

D2.
Power
Connectors

D3.
Grounding
Connectors

E1.
Labeling
Systems

E2.
Labels

E3.
Pre-Printed
& Write-On
Markers

E4.
Permanent
Identification

E5.
Lockout/
Tagout/
& Safety
Solutions

F.
Index

| Part Number | Wire Size | | Figure Dimensions | | | | | | Wire Strip Length | | Recommended Installation Tool | Std. Pkg. Qty. |
|-------------|-----------|-----------------|-------------------|------|-----|-----|-----|-----|-------------------|------|---------------------------------|----------------|
| | | | L | | ID | | OD | | | | | |
| | AWG | mm ² | In. | mm | In. | mm | In. | mm | In. | mm | | |
| F73-5-M | 24 AWG | .25 | .20 | 5.0 | .03 | .80 | .04 | 1.1 | 7/32 | 5.0 | CT-1002, CT-1003 | 1000 |
| F73-7-M | | | .28 | 7.0 | .03 | .80 | .04 | 1.1 | 9/32 | 7.0 | | 1000 |
| F74-5-M | | .34 | .20 | 5.0 | .04 | .90 | .05 | 1.2 | 7/32 | 5.0 | | 1000 |
| F74-7-M | | | .28 | 7.0 | .04 | .90 | .05 | 1.2 | 9/32 | 7.0 | | 1000 |
| F75-6-M | 22 AWG | .50 | .24 | 6.0 | .04 | 1.0 | .05 | 1.3 | 1/4 | 6.0 | CT-1002, CT-1003, CT-1123 | 1000 |
| F75-8-M | | | .31 | 8.0 | .04 | 1.0 | .05 | 1.3 | 5/16 | 8.0 | | 1000 |
| F75-10-M | | | .39 | 10.0 | .04 | 1.0 | .05 | 1.3 | 13/32 | 10.0 | | 1000 |
| F76-6-M | 20 AWG | .75 | .24 | 6.0 | .05 | 1.2 | .06 | 1.5 | 1/4 | 6.0 | CT-1002, CT-1003, CT-1123 | 1000 |
| F76-8-M | | | .31 | 8.0 | .05 | 1.2 | .06 | 1.5 | 5/16 | 8.0 | | 1000 |
| F76-10-M | | | .39 | 10.0 | .05 | 1.2 | .06 | 1.5 | 13/32 | 10.0 | | 1000 |
| F76-12-M | | | .47 | 12.0 | .05 | 1.2 | .06 | 1.5 | 15/32 | 12.0 | | 1000 |
| F77-6-M | 18 AWG | 1.0 | .24 | 6.0 | .06 | 1.4 | .07 | 1.7 | 1/4 | 6.0 | CT-1002, CT-1003, CT-1123 | 1000 |
| F77-7-M | | | .28 | 7.0 | .06 | 1.4 | .07 | 1.7 | 9/32 | 7.0 | | 1000 |
| F77-8-M | | | .31 | 8.0 | .06 | 1.4 | .07 | 1.7 | 5/16 | 8.0 | | 1000 |
| F77-10-M | | | .39 | 10.0 | .06 | 1.4 | .07 | 1.7 | 13/32 | 10.0 | | 1000 |
| F77-12-M | 16 AWG | 1.5 | .47 | 12.0 | .06 | 1.4 | .07 | 1.7 | 15/32 | 12.0 | CT-1002, CT-1003, CT-1123 | 1000 |
| F78-7-M | | | .28 | 7.0 | .07 | 1.7 | .08 | 2.0 | 9/32 | 7.0 | | 1000 |
| F78-8-M | | | .31 | 8.0 | .07 | 1.7 | .08 | 2.0 | 5/16 | 8.0 | | 1000 |
| F78-10-M | | | .39 | 10.0 | .07 | 1.7 | .08 | 2.0 | 13/32 | 10.0 | | 1000 |
| F78-12-M | 1.5 | .75 | .47 | 12.0 | .07 | 1.7 | .08 | 2.0 | 15/32 | 12.0 | CT-1002, CT-1003, CT-1123 | 1000 |
| F78-15-M | | | .59 | 15.0 | .07 | 1.7 | .08 | 2.0 | 19/32 | 15.0 | | 1000 |
| F78-18-M | | | .71 | 18.0 | .07 | 1.7 | .08 | 2.0 | 23/32 | 18.0 | | 1000 |
| F78-20-M | | | .79 | 20.0 | .07 | 1.7 | .08 | 2.0 | 25/32 | 20.0 | | 1000 |
| F80-7-M | 14 AWG | 2.5 | .28 | 7.0 | .09 | 2.2 | .10 | 2.5 | 9/32 | 7.0 | CT-1002, CT-1003 | 1000 |
| F80-8-M | | | .31 | 8.0 | .09 | 2.2 | .10 | 2.5 | 5/16 | 8.0 | | 1000 |
| F80-10-M | | | .39 | 10.0 | .09 | 2.2 | .10 | 2.5 | 13/32 | 10.0 | | 1000 |
| F80-12-M | | | .47 | 12.0 | .09 | 2.2 | .10 | 2.5 | 15/32 | 12.0 | | 1000 |
| F80-15-M | | | .59 | 15.0 | .09 | 2.2 | .10 | 2.5 | 19/32 | 15.0 | | 1000 |
| F80-18-M | | | .71 | 18.0 | .09 | 2.2 | .10 | 2.5 | 23/32 | 18.0 | | 1000 |
| F80-20-M | | | .79 | 20.0 | .09 | 2.2 | .10 | 2.5 | 25/32 | 20.0 | | 1000 |

For crimping tool information, see page D1.85.

Ferrules, Non-Insulated (continued)

Type F

| Part Number | Wire Size | | Figure Dimensions | | | | | | Wire Strip Length | | Recommended Installation Tool | Std. Pkg. Qty. |
|-------------|-----------|-----------------|-------------------|------|-----|------|-----|------|-------------------|------|---------------------------------|----------------|
| | | | L | | ID | | OD | | | | | |
| | AWG | mm ² | In. | mm | In. | mm | In. | mm | In. | mm | | |
| F81-9-M | 12 AWG | 4.0 | .35 | 9.0 | .11 | 2.8 | .13 | 3.3 | 11/32 | 8.0 | CT-1002, CT-1003, CT-1123 | 1000 |
| F81-10-M | | | .39 | 10.0 | .11 | 2.8 | .13 | 3.3 | 13/32 | 10.0 | | 1000 |
| F81-12-M | | | .47 | 12.0 | .11 | 2.8 | .13 | 3.3 | 15/32 | 12.0 | | 1000 |
| F81-15-M | | | .59 | 15.0 | .11 | 2.8 | .13 | 3.3 | 19/32 | 15.0 | | 1000 |
| F81-18-M | | | .71 | 18.0 | .11 | 2.8 | .13 | 3.3 | 23/32 | 18.0 | | 1000 |
| F81-20-M | | | .79 | 20.0 | .11 | 2.8 | .13 | 3.3 | 25/32 | 20.0 | | 1000 |
| F82-10-M | 10 AWG | 6.0 | .39 | 10.0 | .14 | 3.5 | .15 | 3.9 | 13/32 | 10.0 | CT-1003, CT-1004, CT-1123 | 1000 |
| F82-12-M | | | .47 | 12.0 | .14 | 3.5 | .15 | 3.9 | 15/32 | 12.0 | | 1000 |
| F82-15-M | | | .59 | 15.0 | .14 | 3.5 | .15 | 3.9 | 19/32 | 15.0 | | 1000 |
| F82-18-M | | | .71 | 18.0 | .14 | 3.5 | .15 | 3.9 | 23/32 | 18.0 | | 1000 |
| F82-20-M | | | .79 | 20.0 | .14 | 3.5 | .15 | 3.9 | 25/32 | 20.0 | | 1000 |
| F83-12-D | 8 AWG | 10.0 | .47 | 12.0 | .18 | 4.5 | .19 | 4.9 | 15/32 | 12.0 | CT-1003, CT-1004, CT-1123 | 500 |
| F83-15-D | | | .59 | 15.0 | .18 | 4.5 | .19 | 4.9 | 19/32 | 15.0 | | 500 |
| F83-18-D | | | .71 | 18.0 | .18 | 4.5 | .19 | 4.9 | 23/32 | 18.0 | | 500 |
| F83-20-D | | | .79 | 20.0 | .18 | 4.5 | .19 | 4.9 | 25/32 | 20.0 | | 500 |
| F83-25-D | | | .98 | 25.0 | .18 | 4.5 | .19 | 4.9 | 31/32 | 25.0 | | 500 |
| F84-12-TL | 6 AWG | 16.0 | .47 | 12.0 | .23 | 5.8 | .24 | 6.2 | 15/32 | 12.0 | CT-1004 | 250 |
| F84-15-TL | | | .59 | 15.0 | .23 | 5.8 | .24 | 6.2 | 19/32 | 15.0 | | 250 |
| F84-18-TL | | | .71 | 18.0 | .23 | 5.8 | .24 | 6.2 | 23/32 | 18.0 | | 250 |
| F84-20-TL | | | .79 | 20.0 | .23 | 5.8 | .24 | 6.2 | 25/32 | 20.0 | | 250 |
| F84-25-TL | | | .98 | 25.0 | .23 | 5.8 | .24 | 6.2 | 31/32 | 25.0 | | 250 |
| F84-32-TL | | | 1.26 | 32.0 | .23 | 5.8 | .24 | 6.2 | 1 1/4 | 32.0 | | 250 |
| F85-12-C | 4 AWG | 25.0 | .47 | 12.0 | .29 | 7.3 | .30 | 7.7 | 15/32 | 12.0 | CT-1005 | 100 |
| F85-15-C | | | .59 | 15.0 | .29 | 7.3 | .30 | 7.7 | 19/32 | 15.0 | | 100 |
| F85-18-C | | | .71 | 18.0 | .29 | 7.3 | .30 | 7.7 | 23/32 | 18.0 | | 100 |
| F85-25-C | | | .98 | 25.0 | .29 | 7.3 | .30 | 7.7 | 31/32 | 25.0 | | 100 |
| F85-32-C | | | 1.26 | 32.0 | .29 | 7.3 | .30 | 7.7 | 1 1/4 | 32.0 | | 100 |
| F86-18-C | 2 AWG | 35.0 | .71 | 18.0 | .33 | 8.3 | .34 | 8.7 | 23/32 | 18.0 | CT-1006 | 100 |
| F86-20-C | | | .79 | 20.0 | .33 | 8.3 | .34 | 8.7 | 25/32 | 20.0 | | 100 |
| F86-25-C | | | .98 | 25.0 | .33 | 8.3 | .34 | 8.7 | 31/32 | 25.0 | | 100 |
| F86-32-C | | | 1.26 | 32.0 | .33 | 8.3 | .34 | 8.7 | 1 1/4 | 32.0 | | 100 |
| F87-18-C | 1 AWG | 50.0 | .71 | 18.0 | .41 | 10.3 | .43 | 10.9 | 23/32 | 18.0 | CT-1006 | 100 |
| F87-22-C | | | .87 | 22.0 | .41 | 10.3 | .43 | 10.9 | 7/8 | 22.0 | | 100 |
| F87-25-C | | | .98 | 25.0 | .41 | 10.3 | .43 | 10.9 | 31/32 | 25.0 | | 100 |
| F87-32-C | | | 1.26 | 32.0 | .41 | 10.3 | .43 | 10.9 | 1 1/4 | 32.0 | | 100 |

For crimping tool information, see page D1.85.

A.
System
Overview

B1.
Cable Ties

B2.
Cable
Accessories

B3.
Stainless
Steel Ties

C1.
Wiring
Duct

C2.
Surface
Raceway

C3.
Abrasion
Protection

C4.
Cable
Management

D1.
Terminals

D2.
Power
Connectors

D3.
Grounding
Connectors

E1.
Labeling
Systems

E2.
Labels

E3.
Pre-Printed
& Write-On
Markers

E4.
Permanent
Identification

E5.
Lockout/
Tagout
& Safety
Solutions

F.
Index

A.
System
Overview

Ferrule Assortment Kits

B1.
Cable Ties

- Large selection of ferrules in a convenient compact case
- Plastic case is both durable and reusable keeping ferrules organized and separated

B2.
Cable
Accessories



KP-FSD1, KP-FSD2,
and KP-FSD3

B3.
Stainless
Steel Ties

C1.
Wiring
Duct

C2.
Surface
Raceway



KP-F1 and KP-F2

C3.
Abrasion
Protection

C4.
Cable
Management

| Part Number | Part Description | Std. Pkg. Qty. |
|----------------|--|----------------|
| KP-FSD1 | Ferrule kit includes: #24 – 18 AWG insulated DIN ferrules. Case includes: 30 pieces each of FSD73-6, FSD74-6, FSD75-8, FSD76-8 and FSD77-8. | 1 |
| KP-FSD2 | Ferrule kit includes: #22 – 14 AWG insulated DIN ferrules. Case includes: 100 pieces each of FSD76-8, FSD77-8, FSD78-8 50 pieces each of FSD75-8 and FSD80-8. | 1 |
| KP-FSD3 | Ferrule kit includes: #12 – 6 AWG insulated DIN ferrules. Case includes: 50 pieces of FSD81-10 20 pieces each of FSD82-12 and FSD83-12 10 pieces of FSD84-12. | 1 |
| KP-F1 | Ferrule kit includes: #22 – 14 AWG non-insulated ferrules. Case includes: 500 pieces of F75-6 400 pieces each of F76-6 and F77-6 300 pieces of F78-7 200 pieces of F80-7. | 1 |
| KP-F2 | Ferrule kit includes: #12 – 6 AWG non-insulated ferrules. Case includes: 150 pieces of F81-9 100 pieces of F82-10 80 pieces of F83-12 40 pieces of F84-12. | 1 |

Ferrule kits do not include crimping tool.

D1.
Terminals

D2.
Power
Connectors

D3.
Grounding
Connectors

E1.
Labeling
Systems

E2.
Labels

E3.
Pre-Printed
& Write-On
Markers

E4.
Permanent
Identification

E5.
Lockout/
Tagout/
& Safety
Solutions

F.
Index

TERMINAL CRIMPING TOOLS

PANDUIT offers a wide assortment of tools to provide solutions for installing terminals, disconnects, splices, ferrules and lugs. PANDUIT installation tools provide quality performance and ease of installation at the lowest installed cost. The long-term reliability of PANDUIT installation tools provides the highest level of service to meet customer requirements.



- Ergonomic design to minimize operator effort
- Features crimping tools with a controlled cycle mechanism ensuring repeat reliability in every crimp
- Superior locator ensures proper location of the terminal barrel or insulated disconnect in the crimp pocket
- Battery powered, hydraulic tools with fingertip operation are available to meet a variety of installation needs
- UL Listed and CSA Certified tooling/product combinations, as noted

PANDUIT terminal crimping tools are available in an assortment of styles to meet a variety of installation needs. The installer can control the crimp with the plier type hand operated crimping tool. Hand operated *CONTOUR CRIMP™* Controlled Cycle Crimping Tools feature ergonomically designed cushioned grips with low handle effort. PANDUIT terminal crimping tools are designed for use with PANDUIT terminals, providing the right solution for your termination needs.

A.
System
Overview

B1.
Cable Ties

B2.
Cable
Accessories

B3.
Stainless
Steel Ties

C1.
Wiring
Duct

C2.
Surface
Raceway

C3.
Abrasion
Protection

C4.
Cable
Management

D1.
Terminals

D2.
Power
Connectors

D3.
Grounding
Connectors

E1.
Labeling
Systems

E2.
Labels

E3.
Pre-Printed
& Write-On
Markers

E4.
Permanent
Identification

E5.
Lockout/
Tagout/
& Safety
Solutions

F.
Index

A. System Overview

Crimping Guidelines for PANDUIT® PAN-TERM® Terminals, Disconnects, Splices and Wire Joints

B1. Cable Ties

1. Select the proper PANDUIT terminal for the application and wire size used

- Ring terminals are used for high vibration and grounding applications
- Fork terminals are used for static (non-vibration) applications
- Disconnects are used for applications that require quick connection of wires without the use of tools
- Splices and wire joints are used to join wires together



B2. Cable Accessories

B3. Stainless Steel Ties

2. Strip wire to the proper length as specified on:

- PANDUIT product packaging label
- Packaging instructions included with the PANDUIT product
- Or if no packaging instructions are available, plan your strip length so that 1/32" of wire can be seen protruding through the tongue end of the terminal barrel

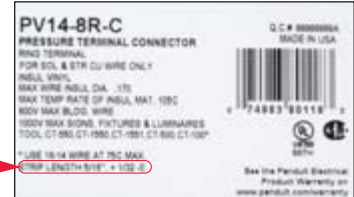

C1. Wiring Duct

C2. Surface Raceway

3. Select the proper crimp tool to be used

- Use crimping tools that provide a UL Listed and/or CSA Certified electrical termination, to assure a safe and reliable connection
- PANDUIT terminals are UL Listed and CSA Certified when crimped with PANDUIT plier type crimping tool or with the preferred **CONTOUR CRIMP™** Controlled Cycle Crimping Tool specified on the packaging label

C3. Abrasion Protection

C4. Cable Management

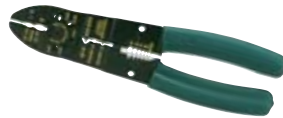

Plier Type Crimping Tool



CONTOUR CRIMP™ Controlled Cycle Crimping Tool

D1. Terminals

4. Select the proper crimp pocket for the terminals and wire size you are using

- PANDUIT crimping tools simplify this process with color-coded crimp pockets. The yellow, blue, and red pockets are specifically designed for the industry standard barrel sizes, each with a specific color code.

D2. Power Connectors

D3. Grounding Connectors



E1. Labeling Systems

5. Perform the electrical crimp for the plier type tool Insulated Terminals and Disconnects

- Locate terminal in appropriate size color-coded crimp die pocket with tool centered on insulation sleeve. (See Note 1, page D1.82)
- Rotate terminal so tongue is level with crimp die.
- Insert properly stripped wire into terminal until a minimum of 1/32" of wire extends beyond the terminal barrel.
- Squeeze tool handles firmly to perform the electrical crimp. (See Note 2, page D1.82)
- Provide second crimp on the flared portion of the insulation housing to close the insulation as shown. Caution: When using plier type crimping tools, do not squeeze as firmly as you did for the electrical crimp. (See Note 3, page D1.82)



Step A



Step B



Steps C and D



Step E



Complete Crimp

E2. Labels

E3. Pre-Printed & Write-On Markers

E4. Permanent Identification

E5. Lockout/Tagout & Safety Solutions

F. Index

Crimping Guidelines for PANDUIT® PAN-TERM® Terminals, Disconnects, Splices and Wire Joints (continued)

Non-Insulated Terminals and Disconnects

- Locate terminal in appropriate wire gauge crimp die pocket with indenter centered on barrel seam.
- Rotate terminal so tongue is level with crimp die.
- Insert properly stripped wire (based on recommendations on package label) into terminal until a minimum of 1/32" of wire extends beyond the terminal barrel.
- Squeeze tool handles firmly to perform the electrical crimp. (See Note 2, page D1.82)



Step A



Step B



Steps C and D



Complete Crimp

Insulated and Non-Insulated Parallel Splices

- Locate parallel splice in appropriate wire gauge crimp die pocket and position tool on the center of the splice.
- Rotate terminal so tongue is level with crimp die.
- Insert properly stripped wire (based on recommendations on package label) into each end of the parallel splice.
- Squeeze tool handles firmly. (See Note 2, page D1.82)
- An insulation crimp is not required on an insulated parallel splice.

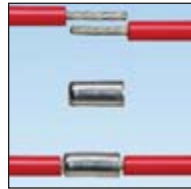

Steps A and B



Steps C and D



Complete Crimp

Insulated and Non-Insulated Butt Splices

- Locate butt splice in appropriate color-coded crimp die pocket and position crimp halfway between the wire stop (center of splice) and the end of the insulation crimp area. (See Note 4, page D1.82)
- Insert properly stripped wire (based on recommendations on package label) into one end of butt splice.
- Squeeze tool handles firmly to perform the electrical crimp (See Note 2, page D1.82)
- Provide second crimp on the flared portion of the insulation housing to close the insulation. Caution: When using plier type crimping tools, do not squeeze as firmly as you did for the electrical crimp. (See Note 3, page D1.82)
- Repeat steps 1 – 4 for opposite end of butt splice. (See Note 3, page D1.82)



Steps A and B



Step C

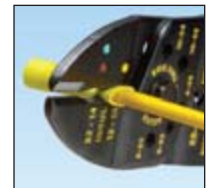

Steps D and E



Complete Crimp

A.
System
Overview

B1.
Cable
Ties

B2.
Cable
Accessories

B3.
Stainless
Steel Ties

C1.
Wiring
Duct

C2.
Surface
Raceway

C3.
Abrasion
Protection

C4.
Cable
Management

D1.
Terminals

D2.
Power
Connectors

D3.
Grounding
Connectors

E1.
Labeling
Systems

E2.
Labels

E3.
Pre-Printed
& Write-On
Markers

E4.
Permanent
Identification

E5.
Lockout/
Tagout
& Safety
Solutions

F.
Index

A.
System
Overview

B1.
Cable Ties

B2.
Cable
Accessories

B3.
Stainless
Steel Ties

C1.
Wiring
Duct

C2.
Surface
Raceway

C3.
Abrasion
Protection

C4.
Cable
Management

D1.
Terminals

D2.
Power
Connectors

D3.
Grounding
Connectors

E1.
Labeling
Systems

E2.
Labels

E3.
Pre-Printed
& Write-On
Markers

E4.
Permanent
Identification

E5.
Lockout/
Tagout/
& Safety
Solutions

F.
Index

Crimping Guidelines for PANDUIT® PAN-TERM® Terminals, Disconnects, Splices and Wire Joints (continued)

Insulated and Non-Insulated Wire Joints

- Properly strip wires per manufacturer's recommendations on product package label.
- Twist stripped wire ends together and insert wires into wire joint.
- Locate wire joint in appropriate wire gauge crimp die pocket and position crimp in the center of the metal insert.
- Squeeze tool handles firmly to perform the electrical crimp. (See Note 2 below)

Note: An insulation crimp is not required on an insulated wire joint.



Steps A and B



Steps C and D



Complete Crimp

NOTES for Crimping with the Preferred Hand Operated Controlled Cycle Crimping Tools:

- PANDUIT controlled cycle crimping tools properly locate rings, forks, and barrel insulated disconnects, pins, and blades. No further positioning is required.
- When using the preferred controlled cycle tool, once a crimp has been started, the ratchet device of controlled cycle tools will not release until the crimp is complete, independent of operator expertise.
- Controlled cycle tools provide the electrical crimp and the insulation closure in a single cycle of the tool.
- When using controlled cycle tooling, insulated butt splices must be inserted from the back of the tool to ensure that the electrical and insulation closure crimp pockets are properly aligned with the splice.

5. Perform the electrical crimp using the preferred controlled cycle tool

- Make sure the terminal barrel is centered correctly in the right die pocket by using the product locator on the backside of the tool.
- Determine the correct die pocket to use based on the color code of the terminal.
- Squeeze the handles of the tool until one click is heard; this click indicates the terminal is now held in place securely to insert the wire.
- Insert the wire and complete cycle to perform the electrical and insulation crimp simultaneously.
- Crimp is complete.



Step A



Step B



Step C



Step D



Complete Crimp

6. Inspect the crimp

Note: If your crimp looks like any of the examples shown below, cut off the terminal and recrimp. These crimps would provide a poor connection!



Bent Back Strands



Over Crimp



Rotated Crimp

Hand Operated Plier Type Tools

- Installer controlled crimp
- Available with wire stripping and cutting features
- Plier type crimp for #22 – 10 AWG insulated and non-insulated terminal products



CT-260



CT-200



CT-160



CT-100

| Part Number | Part Description | Std. Pkg. Qty. |
|-------------|---|----------------|
| CT-260 | Crimps most <i>PANDUIT</i> #22 – 10 AWG insulated and non-insulated terminals. Forged steel tool. Cuts wire. | 1 |
| CT-200 | Forged steel tool. Crimps most <i>PANDUIT</i> #22 – 10 AWG non-insulated terminals, disconnects, and splices. Cuts wire. | 1 |
| CT-160 | Crimps most <i>PANDUIT</i> #22 – 10 AWG insulated and non-insulated terminals disconnects, and splices. Cuts three U.S. and three metric screw sizes. Cuts and strips wire. Has insulation closure pocket. | 1 |
| CT-100 | Crimps most <i>PANDUIT</i> #22 – 10 AWG insulated and non-insulated terminals, disconnects, and splices. Cuts #4, #6, #8 and #10 screw sizes. Cuts and strips wire. Excellent all-around application tool of heat treated finished steel with comfortable cushioned plastic grip handles. | 1 |

Wire and Cable Stripping Tools

- Strips and cuts #20 – 10 AWG wire
- Lightweight and durable for comfortable long use
- Rust resistant coating included to improve durability of tool



| Part Number | Wire Range (O.D.) | Part Description | Std. Pkg. Qty. |
|-------------|-------------------|---------------------------|----------------|
| CST115 | #20 – 10 AWG | Plier nose wire stripper. | 1 |

A.
System
Overview

B1.
Cable Ties

B2.
Cable
Accessories

B3.
Stainless
Steel Ties

C1.
Wiring
Duct

C2.
Surface
Raceway

C3.
Abrasion
Protection

C4.
Cable
Management

D1.
Terminals

D2.
Power
Connectors

D3.
Grounding
Connectors

E1.
Labeling
Systems

E2.
Labels

E3.
Pre-Printed
& Write-On
Markers

E4.
Permanent
Identification

E5.
Lockout/
Tagout/
& Safety
Solutions

F.
Index

A.
System
Overview

CONTOUR CRIMP™ Controlled Cycle Tools

B1.
Cable Ties

- Specifically designed for the installation of *PAN-TERM*® terminals, disconnects, and splices

- Polypropylene handles provide chemical resistance and a cushioned, non-slip grip

B2.
Cable
Accessories

- Controlled cycle mechanism assures high quality, consistent terminations

- Multiple position locator facilitates a high quality repeatable crimp

- Ergonomic tool design assures operator comfort, safety, and performance

B3.
Stainless
Steel Ties



CT-1525

C1.
Wiring
Duct



CT-1550

C2.
Surface
Raceway



CT-1551

C3.
Abrasion
Protection



CT-1570

C4.
Cable
Management



CT-1700

D1.
Terminals



CT-1701

D2.
Power
Connectors



CT-1014

D3.
Grounding
Connectors



CT-1015

E1.
Labeling
Systems

E2.
Labels

E3.
Pre-Printed
& Write-On
Markers

E4.
Permanent
Identification

E5.
Lockout/
Tagout/
& Safety
Solutions

F.
Index

| Part Number | Part Description | Std. Pkg. Qty. |
|-------------|---|----------------|
| CT-1525 | Crimps <i>PANDUIT</i> #26 – 22 AWG insulated terminals and splices, #22 – 10 AWG fully insulated disconnects and insulated parallel splices. Crimps <i>PANDUIT</i> #22 – 14 AWG barrel insulated disconnects. | 1 |
| CT-1550 | Crimps most <i>PAN-TERM</i> ® #22 – 10 AWG nylon and vinyl insulated terminals, splices, and disconnects. The CT-1550 has the red/blue pocket closest to the pivot which provides a reduced crimp effort for those who make red/blue terminations. | 1 |
| CT-1551 | Crimps most <i>PAN-TERM</i> ® #22 – 10 AWG nylon and vinyl insulated terminals, splices, and disconnects. The CT-1551 has the yellow pocket closest to the pivot which provides a reduced crimp effort for those who make yellow terminations. | 1 |
| CT-1570 | Crimps most <i>PAN-TERM</i> ® #22 – 10 AWG and .5mm ² – 6.0mm ² non-insulated terminals and disconnects. Crimps <i>PANDUIT</i> #22 – 10 AWG and .5mm ² – 6.0mm ² non-insulated splices and #10 AWG compression lugs. | 1 |
| CT-1700 | Crimps <i>PANDUIT</i> #8 – 2 AWG non-insulated tubular terminals (S series), #8 – 1 AWG copper code conductor lugs and splices, #6 – 4 AWG dual rated aluminum lugs and splices and CTAPF10-16 to CTAPF3-12 copper taps. Includes 5-position, color-coded rotating die. | 1 |
| CT-1701 | Crimps <i>PANDUIT</i> #10 – 2 AWG non-insulated large gauge ring terminals (P series) and #12 – 4 AWG non-insulated heavy duty ring terminals (P series). Includes 5-position rotating die. | 1 |
| CT-1014 | Crimps <i>PANDUIT</i> #22 – 14 AWG loose piece <i>DISCO-LOK</i> ™ Disconnects. | 1 |
| CT-1015 | Crimps <i>PANDUIT</i> #22 – 14 AWG loose piece <i>SUPRA-GRIP</i> ™ Disconnects. | 1 |

For battery powered crimping tools, see compression connector tools selection guide on pages D3.30 – D3.32.

Controlled Cycle Crimping Tools

- Specialty crimping tools for fully insulated right angle disconnects and heat shrink insulated terminals, disconnects, and splices
- Controlled cycle mechanism assures high quality, consistent terminations



| Part Number | Part Description | Std. Pkg. Qty. |
|-------------|---|----------------|
| CT-300-1 | Crimps <i>PANDUIT</i> #22 – 14 AWG fully insulated right angle disconnects (DNFR-FIB series). | 1 |
| CT-310 | Crimps <i>PANDUIT</i> #22 – 10 AWG heat shrink insulated terminals, disconnects, and splices | 1 |

Controlled Cycle Crimping Tools – Ferrule End Sleeve

- Specifically designed for the installation of *PAN-TERM*® Ferrules
- Controlled cycle mechanism assures high quality, consistent terminations
- Ergonomic tool design assures operator comfort, safety, and performance
- Multi-position locator facilitates a high quality repeatable crimp



| Part Number | Part Description | Std. Pkg. Qty. |
|-------------|---|----------------|
| CT-1002 | Crimps <i>PANDUIT</i> #26 – 10 AWG single polypropylene insulated ferrules (DIN). #26 – 10 AWG single wire insulated ferrules (French). #22 – 12 AWG polypropylene insulated dual-wire ferrules (DIN). #24 – 10 AWG non-insulated ferrules. | 1 |
| CT-1003 | Crimps <i>PANDUIT</i> #22 – 8 AWG single wire insulated ferrules (DIN). #22 – 8 AWG single wire polypropylene insulated ferrules (French). #22 – 10 AWG polypropylene insulated dual-wire (DIN) ferrules. #22 – 10 AWG non-insulated ferrules. | 1 |
| CT-1004 | Crimps <i>PANDUIT</i> #8 – 6 AWG single wire polypropylene insulated ferrule (DIN). #8 – 6 AWG single wire polypropylene insulated ferrules (French). #10 AWG polypropylene insulated dual-wire (DIN) ferrule. #8 – 6 AWG non-insulated ferrules. | 1 |
| CT-1005 | Crimps <i>PANDUIT</i> #4 – 2 AWG single wire polypropylene insulated ferrule (DIN). #4 – 2 AWG single wire polypropylene insulated ferrules (French). #4 – 2 AWG non-insulated ferrules. | 1 |
| CT-1006 | Crimps <i>PANDUIT</i> #1 AWG single wire polypropylene insulated ferrule (DIN) and (French). #1 AWG non-insulated ferrules. | 1 |
| CT-1104 | Controlled cycle square crimp profile tool for #8 – 6 AWG (10mm ² – 16mm ²) insulated and non-insulated ferrules. | 1 |
| CT-1123 | Controlled cycle square crimp profile tool for #26 – 8 AWG (.14mm ² – 10mm ²) insulated and non-insulated ferrules). | 1 |

A. System Overview

B1. Cable Ties

B2. Cable Accessories

B3. Stainless Steel Ties

C1. Wiring Duct

C2. Surface Raceway

C3. Abrasion Protection

C4. Cable Management

D1. Terminals

D2. Power Connectors

D3. Grounding Connectors

E1. Labeling Systems

E2. Labels

E3. Pre-Printed & Write-On Markers

E4. Permanent Identification

E5. Lockout/Tagout & Safety Solutions

F. Index

A. System Overview



Semiautomatic Ferrule Crimping Tool CT-1000

B1. Cable Ties

- Innovative rapid load design utilizes continuously molded ferrules to significantly reduce installation time
- Adjustable die setting allows termination of all *PANDUIT* #14 – 20 AWG continuously molded ferrules with a single tool
- Controlled cycle tool cuts, strips, and crimps wire to maximize efficiency

B2. Cable Accessories

B3. Stainless Steel Ties



| Part Number | Part Description | Std. Pkg. Qty. |
|-------------|---|----------------|
| CT-1000 | Crimps <i>PANDUIT</i> #20 – 14 AWG continuously molded ferrules on strips. Also cuts and strips wire. | 1 |

C1. Wiring Duct

C2. Surface Raceway

Controlled Cycle Crimping Tools – In-Line

- Military specialty tools help meet military and nuclear test requirements for Class 2 applications
- Calibration-recalibration is possible for maintaining exact crimp dimensions
- In-line crimp action for greater dielectric strength with uniform insulation compression

C3. Abrasion Protection

C4. Cable Management



| Part Number | Part Description | Std. Pkg. Qty. |
|-------------|---|----------------|
| CT-400 | Crimps #22 – 14 <i>PANDUIT</i> insulated terminals, disconnects, and splices. Comes complete with tools for calibration. Has adjustable pre-load and emergency ratchet. Helps meet military and nuclear requirements. | 1 |
| CT-460 | Crimps #16 – 10 <i>PANDUIT</i> insulated terminals, disconnects, and splices. Has same features as CT-400 above. | 1 |

For proper crimp head selection, see the tooling selection guide for *PANDUIT* terminals, splices, and disconnects on pages D1.89 – D1.91, in this catalog.

D1. Terminals

D2. Power Connectors

Pneumatic Crimping Tool

- Quickly crimps a variety of loose piece terminals in a variety of wire sizes for medium volume production
- Portable — the small size, ease of bench mounting and quick pneumatic connection allow the tool to be moved from one work station to another or to the work itself
- Versatile interchangeable crimping heads let you switch terminal types quickly to meet changing production requirements; this tool, when used with only four crimp heads, can crimp a full range of #26 – 10 AWG insulated and non-insulated terminal products

D3. Grounding Connectors

E1. Labeling Systems



E2. Labels

E3. Pre-Printed & Write-On Markers

E4. Permanent Identification

E5. Lockout/Tagout & Safety Solutions

F. Index

| Part Number | Part Description | Std. Pkg. Qty. |
|-------------|---|----------------|
| CT-600-A | Pneumatic tool, 6' air hose and carrying case. Does not include crimping heads (ordered separately). | 1 |
| CT-500CH | Crimping head for most #22 – 14 insulated terminals, splices, and disconnects. | 1 |
| CT-520CH | Crimping head for most #22 – 14 insulated butted seam disconnects and #26 – 22 insulated terminals. | 1 |
| CT-550CH | Crimping head for most #22 – 10 insulated terminals and splices. | 1 |
| CT-570CH | Crimping head for #22 – 10 non-insulated terminals, splices, and disconnects. | 1 |
| PD-600-A | Positioning device (for bench mounting of CT-600-A). | 1 |
| FPC-600-A | Foot actuator operating air pressure: 80 – 100 psi .233 SCFM type of air: lubricated. Recommend using Norgren (Brand) #FLR222-012-043008 filter lubricator regulator. | 1 |
| K600-A | Update kit for foot pedal control and positioning device to work with new CT-600-A pneumatic crimping tool. | 1 |

For proper crimp head selection, see the tooling selection guide for *PANDUIT* terminals, splices, and disconnects on pages D1.89 – D1.91, in this catalog.

Die Type, Manual, Crimping Tool

- High quality, durable tool construction provides long term dependability
- Develops 6 tons of crimping force, crimps copper compression lugs and splices up to 500 kcmil and splices up to 500 kcmil
- Provides UL Listed and CSA Certified connections on *PANDUIT* copper and aluminum lugs, splices insulated terminals



| Part Number | Part Description | Std. Pkg. Qty. |
|-------------|---|----------------|
| CT-720 | Manual crimping tool for UL Listed or Recognized and CSA Certified terminations of <i>PANDUIT</i> ® <i>PAN-LUG</i> ™ copper compression lugs and splices for #8 AWG – 500 kcmil copper code conductor and aluminum compression lugs and splices for #6 AWG – 350 kcmil copper and aluminum code conductors. Provides UL Listed terminations of <i>PANDUIT</i> ® <i>PAN-TERM</i> ® #8 – 2 AWG vinyl insulated terminals. Color-coded CD-720 crimping dies, carrying/storage case, and controlled cycle mechanism must be purchased separately. Specifications: Output: 6 tons Weight: 7.7 lbs. Length: 26" Handle span: 58" (open), 2.5" (closed) Warranty: 90 days | 1 |
| CC-720 | Optional controlled cycle mechanism only. Total weight of tool with CC-720 is 8.25 lbs. | 1 |
| C-720 | Black steel carrying case for CT-720 crimping tool. | 1 |

For battery powered crimping tools, see compression connector tools selection guide on pages D3.30 – D3.32.

CD-720 Crimping Dies

- Color-coded for easy matching to color-coding marked on connectors
- Embosses die index number on connector barrels to provide post crimp inspection except CD-720PV8-2
- Part number permanently marked on crimping die for easy identification
- Provides 5-sided crimp results in terminations with premium electrical and mechanical performance



CD-720PV8-2

| Part Number | Used to Install <i>PANDUIT</i> Compression Lug and Splice Sizes | | | | Std. Pkg. Qty. |
|-------------|---|--|-------------------------|--|----------------|
| | Copper Conductor Size | Copper Die Color and Die No. | Aluminum Conductor Size | Aluminum Die Color and Die No. | |
| CD-720-1 | #8 – 2 AWG | Red P21 Blue P24 Gray P29 Brown P33 | #6 AWG | Gray P29 | 1 |
| CD-720-2 | #1 – 3/0 AWG | Green P37 Pink P42 Black P45 Orange P50 | #4 – 1/0 AWG | Green P37 Pink P42 Gold P45 Tan P50 | 1 |
| CD-720-3 | 4/0 AWG – 250 kcmil | Purple P54 Yellow P62 | 2/0 – 3/0 AWG | Olive P54 Ruby P62 | 1 |
| CD-720-4 | 300 kcmil | White P66 | 4/0 AWG | White P66 | 1 |
| CD-720-5 | 350 kcmil | Red P71 | 250 kcmil | Red P71 | 1 |
| CD-720-6 | 400 kcmil | Blue P76 | 300 kcmil | Blue P76 | 1 |
| CD-720-7 | 500 kcmil | Brown P87 | 350 kcmil | Brown P87 | 1 |
| CD-720PV8-2 | #8 – 2 AWG, Vinyl Insulated <i>PAN-TERM</i> ® Terminals | Red, Blue, Yellow | — | — | 1 |

See pages D3.30 – D3.32 for connector and tool selection information.

A. System Overview

B1. Cable Ties

B2. Cable Accessories

B3. Stainless Steel Ties

C1. Wiring Duct

C2. Surface Raceway

C3. Abrasion Protection

C4. Cable Management

D1. Terminals

D2. Power Connectors

D3. Grounding Connectors

E1. Labeling Systems

E2. Labels

E3. Pre-Printed & Write-On Markers

E4. Permanent Identification

E5. Lockout/ Tagout & Safety Solutions

F. Index

A.
System
Overview



CT-2500 Battery Powered Crimping Tool

B1.
Cable Ties

- Quick two-second crimping cycle results in less time to crimp terminals compared to conventional methods
- Interchangeable crimp heads for termination of all *PANDUIT* #22 – 10 AWG terminals, disconnects, and splices
- Lightweight 3.3 lb. design provides maximum productivity and ease of use in continuous workflow operations

B2.
Cable
Accessories

B3.
Stainless
Steel Ties



CT-2500CHR

C1.
Wiring
Duct

C2.
Surface
Raceway



CT-2500BC

C3.
Abrasion
Protection

C4.
Cable
Management



CT-2500CASE

D1.
Terminals

D2.
Power
Connectors

D3.
Grounding
Connectors



CT-2550CH

E1.
Labeling
Systems

E2.
Labels

E3.
Pre-Printed
& Write-On
Markers

E4.
Permanent
Identification

E5.
Lockout/
Tagout/
& Safety
Solutions

F.
Index

| Part Number | Part Description | Std. Pkg. Qty. |
|-----------------------|---|----------------|
| Crimping Tools | | |
| CT-2500 | Crimps <i>PANDUIT</i> #22 – 10 AWG insulated and non-insulated terminals, disconnects and splices. Includes tool, two batteries, a battery charger and carrying case. Crimp heads not included. Meets U.S. voltage requirements. | 1 |
| CT-2500/E | Crimps <i>PANDUIT</i> #22 – 10 AWG insulated and non-insulated terminals, disconnects, and splices. Includes tool, two batteries, a battery charger and carrying case. Crimp heads not included. Meets European voltage requirements. | 1 |
| Accessories | | |
| CT-2500CHR | U.S. compatible battery charger for use with the CT-2500. | 1 |
| CT-2500CHR/E | European compatible battery charger for use with the CT-2500/E. | 1 |
| CT-2500BC | Rechargeable tool battery for use with the CT-2500. | 1 |
| CT-2500CASE | Carrying case holds CT-2500 and accessories. | 1 |
| Crimp Heads | | |
| CT-2550CH | Crimps <i>PANDUIT</i> #22 – 10 AWG insulated terminals, disconnects, and splices. | 1 |
| CT-2525CH | Crimps <i>PANDUIT</i> #22 – 10 AWG fully insulated disconnects and insulated parallel splices. | 1 |
| CT-2570CH | Crimps <i>PANDUIT</i> #22 – 10 AWG non-insulated terminals, disconnects, and splices. | 1 |

A.
System
Overview

B1.
Cable Ties

B2.
Cable
Accessories

B3.
Stainless
Steel Ties

C1.
Wiring
Duct

C2.
Surface
Raceway

C3.
Abrasion
Protection

C4.
Cable
Management

D1.
Terminals

D2.
Power
Connectors

D3.
Grounding
Connectors

E1.
Labeling
Systems

E2.
Labels

E3.
Pre-Printed
& Write-On
Markers

E4.
Permanent
Identification

E5.
Lockout/
Tagout/
& Safety
Solutions

F.
Index

Tooling Selection Guide for PANDUIT Terminals, Splices, and Disconnects (continued)

| PANDUIT Terminal Series | Terminal Description | Std. Wire Range (AWG) | Wire Strip Length (In.) [+1/32;-0] | Plier Tools | | | | Controlled Cycle Hand Tools | | | | | | | | | | | | Crimp Heads for Pneumatic CT-600-A Tool | | | | Mechanical | |
|-------------------------|--|-----------------------|---------------------------------------|-------------|--------|--------|--------|-----------------------------|--------|--------|--------|---------|---------|---------|---------|---------|---------|---------|---------|---|----------|----------|----------|------------|---|
| | | | | CT-100 | CT-160 | CT-200 | CT-260 | CT-300-1 | CT-310 | CT-400 | CT-460 | CT-1014 | CT-1015 | CT-1525 | CT-1550 | CT-1551 | CT-1570 | CT-1701 | CT-2500 | CT-500CH | CT-520CH | CT-550CH | CT-570CH | CT-720 | |
| DNF-M | Nylon insulated, funnel entry, barrel insulated, male disconnects | 22 – 18 | 9/32 | X | X | | X | | | | | | | | | | | X | X | | | | | | |
| | | 16 – 14 | 9/32 | X | X | | X | | | | | | | | | | | X | X | | | | | | |
| | | 12 – 10 | 9/32 | X | X | | X | | | | | | | | | | | X | | | | | | | |
| DNFR-B | Nylon pre-insulated, right angle disconnects | 22 – 18 | 9/32 | X | | | | | | | | | X | | | | | | | | | | | | |
| | | 16 – 14 | 9/32 | X | | | | | | | | | X | | | | | | | | | | | | |
| DNFR-FIB | Nylon butted seam, right angle disconnects | 22 – 18 | 11/32 | | | | | X | | | | | | | | | | | | | | | | | |
| | | 16 – 14 | 11/32 | | | | | X | | | | | | | | | | | | | | | | | |
| DNG-FB | SUPRA GRIP™ nylon, fully insulated disc., (except DNG14-187FB and DNG14-188FB) | 22 – 18 | 1/4 | | | | | | | | | | X | | | | | | | | | | | | |
| | | 16 – 14 | 1/4 | | | | | | | | | | X | | | | | | | | | | | | |
| DNG-FL | DISCO-LOK™ nylon, fully insulated disconnects | 22 – 18 | 1/4 | | | | | | | | | | X | | | | | | | | | | | | |
| | | 16 – 14 | 1/4 | | | | | | | | | | X | | | | | | | | | | | | |
| DNH | Heat shrink disconnects | 22 – 18 | 5/16 | | | | | | | X | | | | | | | | | | | | | | | |
| | | 16 – 14 | 5/16 | | | | | | | X | | | | | | | | | | | | | | | |
| | | 12 – 10 | 5/16 | | | | | | | X | | | | | | | | | | | | | | | |
| DV | Vinyl barrel insulated sleeved disconnects | 22 – 18 | 9/32 | X | | | | | | | | | | | | | | X | X | | | | | X | |
| | | 16 – 14 | 9/32 | X | | | | | | | | | | | | | | X | | | | | | X | |
| DV-B | Vinyl insulated, butted seam disconnects | 22 – 18 | 1/4 | X | | | | | | | | | | X | | | | | X | | | | | X | |
| | | 16 – 14 | 1/4 | X | | | | | | | | | | X | | | | | X | | | | | X | |
| DV-M | Vinyl barrel insulated male blade adapters | 22 – 18 | 9/32 | X | X | | X | | | | | | | | | | | X | X | | | | | X | |
| | | 16 – 14 | 9/32 | X | X | | X | | | | | | | | | | | X | X | | | | | X | |
| DV-MB | Vinyl insulated butted seam male disconnects | 22 – 18 | 9/32 | X | | | X | | | | | | | | | | | | X | X | | | | X | |
| | | 16 – 14 | 9/32 | X | | | X | | | | | | | | | | | | X | X | | | | X | |
| DV-P | Vinyl insulated piggyback disconnects | 22 – 18 | 1/4 | X | X | | X | | | | | | | | | | | X | X | | | | | X | |
| | | 16 – 14 | 1/4 | X | X | | X | | | | | | | | | | | | X | X | | | | X | |
| DVF | Vinyl funnel entry barrel insulated female disconnect | 22 – 18 | 9/32 | | | | | | | | | | | | | | | X | X | | | | | X | |
| | | 16 – 14 | 9/32 | | | | | | | | | | | | | | | | X | X | | | | X | |
| J | Non-insulated wire joints | J214-312 | 14 – 12 | 1/2 | X | | X | | | | | | | | | | | | | | | | | | |
| | | J318-412 | 18 – 12 | 1/2 | X | | X | | | | | | | | | | | | | | | | | | |
| | | J216-410 | 16 – 10 | 3/4 | | | | X | | | | | | | | | | | | | | | | | |
| | | JN | | | | | | | | | | | | | | | | | | | | | | | |
| JN | Nylon insulated wire joints | JN224-318 | 24 – 16 | 7/16 | X | X | | X | | | | | | | | | | X | X | | | | | X | |
| | | JN218-216 | 22 – 16 | 7/16 | X | X | | | | | X | | | | | | | X | X | | | | | X | |
| | | JN418-212 | 18 – 12 | 1/2 | X | X | | | | | | X | | | | | | | X | X | | | | | X |
| | | JN314-412 | 14 – 12 | 5/8 | | X | | | | | | | | | | | | | | | | | | | |
| P-HDR | Non-insulated heavy duty rings | 22 – 18 | 9/32 | X | | X | X | | | | | | | | | | | X | X | X | | | | X | |
| | | 16 – 14 | 9/32 | X | X | X | X | | | | | | | | | | | X | | | | | | X | |
| | | 12 – 10 | 9/32 | X | X | X | X | | | | | | | | | | | X | X | X | | | | X | |
| P-R | Non-insulated large ring terminals | 8 | 3/8 | | | | | | | | | | | | | | | | X | | | | | | |
| | | 6 | 7/16 | | | | | | | | | | | | | | | | X | | | | | | |
| | | 4 | 1/2 | | | | | | | | | | | | | | | | X | | | | | | |
| | | 2 | 1/2 | | | | | | | | | | | | | | | | X | | | | | | |

A.
System
Overview

B1.
Cable Ties

B2.
Cable
Accessories

B3.
Stainless
Steel Ties

C1.
Wiring
Duct

C2.
Surface
Raceway

C3.
Abrasion
Protection

C4.
Cable
Management

D1.
Terminals

D2.
Power
Connectors

D3.
Grounding
Connectors

E1.
Labeling
Systems

E2.
Labels

E3.
Pre-Printed
& Write-On
Markers

E4.
Permanent
Identification

E5.
Lockout/
Tagout/
& Safety
Solutions

F.
Index

Tooling Selection Guide for *PANDUIT* Tubular Ring Terminals

| Tooling | CT-1700 | CT-720 | CT-930, CT-930CH, CT-920, CT-920CH, CT-2920, CT-940CH | CT-980, CT-980CH, CT-2950, CT-2980 | CT-2001 |
|-------------------------------|--|------------------------|---|---------------------------------------|---------------------------|
| <i>PANDUIT</i> Part Number | <i>PANDUIT</i> Die Part Number Die Index Number (Number of Crimps) | | | | |
| S8-10R-Q | P21 (2) | CD-720-1 P21 (1) | CD-920-8 P21 (1) | — | CD-2001-8 P21 (1) |
| S8-14R-Q | | | | | |
| S8-56R-Q | | | | | |
| S8-38R-Q | | | | | |
| S6-10R-E | P24 (2) | CD-720-1 P24 (1) | CD-920-6 P24 (1) | — | CD-2001-6 P24 (1) |
| S6-14R-E | | | | | |
| S6-56R-E | | | | | |
| S6-38R-E | | | | | |
| S4-10R-E | P29 (2) | CD-720-1 P29 (1) | CD-920-4 P28 (1) | STD (1) | CD-2001-4 P29 (1) |
| S4-14R-E | | | | | |
| S4-56R-E | | | | | |
| S4-38R-E | | | | | |
| S2-10R-X | P37 (3) | CD-720-2 P37 (1) | CD-920-1 P37 (1) | STD (1) | CD-2001-1 P37 (1) |
| S2-14R-X | | | | | |
| S2-56R-X | | | | | |
| S2-38R-X | | | | | |
| S2-12R-X | — | CD-720-2 P42 (1) | CD-920-1/0 P42 (1) | STD (1) | CD-2001-1/0 P42 (1) |
| S1/0-14R-X | | | | | |
| S1/0-56R-X | | | | | |
| S1/0-38R-X | | | | | |
| S1/0-12R-X | — | CD-720-2 P45 (2) | CD-920-2/0 P45 (1) | STD (1) | CD-2001-2/0 P45 (2) |
| S2/0-14R-X | | | | | |
| S2/0-56R-X | | | | | |
| S2/0-38R-X | | | | | |
| S2/0-76R-X | — | CD-720-2 P50 (2) | CD-920-3/0 P50 (1) | STD (1) | CD-2001-3/0 P50 (2) |
| S2/0-12R-X | | | | | |
| S3/0-14R-5 | | | | | |
| S3/0-56R-5 | | | | | |
| S3/0-38R-5 | — | CD-720-2 P54 (2) | CD-920-4/0 P54 (1) | STD (1) | CD-2001-4/0 P54 (2) |
| S3/0-76R-5 | | | | | |
| S3/0-12R-5 | | | | | |
| S4/0-38R-5 | | | | | |
| S4/0-76R-5 | — | CD-720-3 P62 (2) | CD-920-250 P62 (1) | STD (1) | CD-2001-250 P62 (2) |
| S4/012R-5 | | | | | |
| S250-56R-5 | | | | | |
| S250-38R-5 | | | | | |
| S250-76R-5 | — | CD-720-3 P62 (2) | CD-920-250 P62 (1) | STD (1) | CD-2001-250 P62 (2) |
| S250-12R-5 | | | | | |

Tooling Selection Guide for PANDUIT Ferrules

| PANDUIT Ferrule Series | Ferrule Description | Wire Range (AWG) | Wire Range (mm ²) | Wire Strip Length | Controlled Cycle Hand Tools | | | | | | | | | |
|---------------------------|--|------------------|-------------------------------|--|-----------------------------|---------|---------|---------|---------|---------|---------|---------|---|--|
| | | | | | CT-1000 | CT-1002 | CT-1003 | CT-1004 | CT-1005 | CT-1006 | CT-1104 | CT-1123 | | |
| F | Non-insulated ferrules | 24 | .25 | Please See Ferrule Tables – Pgs. D1.73 – D1.77 | | X | X | | | | | | | |
| | | 22 – 18 | .50 – 1.00 | | | X | X | | | | | | X | |
| | | 16 | 1.50 | | | X | X | | | | | | X | |
| | | 14 | 2.50 | | | X | X | | | | | | | |
| | | 12 | 4.00 | | | X | X | | | | | | X | |
| | | 10 | 6.00 | | | X | X | | | | | | X | |
| | | 8 | 10.0 | | | | X | X | | | | | X | |
| | | 6 | 16.0 | | | | | X | X | | | | X | |
| | | 4 – 2 | 25.0 – 35.0 | | | | | | | | X | | X | |
| | | 1 | 50.0 | | | | | | | | | X | | |
| FSD, FSF | Insulated single wire ferrules (DIN or French color code) | 26 – 18 | .41 – 1.00 | | | X | X | | | | | X | | |
| | | 16 – 14 | 1.50 – 2.00 | | | X | X | | | | | X | | |
| | | 12 – 10 | 4.00 – 6.00 | | | X | X | | | | | X | | |
| | | 8 | 10.0 | | | | X | X | | | X | X | | |
| | | 6 | 16.0 | | | | X | X | | | X | | | |
| | | 4 – 2 | 25.0 – 35.0 | | | | | | | X | | | | |
| FTD | Insulated twin wire ferrules | 22 – 18 | .50 – 1.00 | | | X | X | | | | | X | | |
| | | 16 – 14 | 1.50 – 2.00 | | | X | X | | | | | X | | |
| | | 12 | 4.00 | | | | X | X | | | | X | | |
| | | 10 | 6.00 | | | | X | X | | | X | | | |
| FSD-DSL FS-DSL | Insulated single wire ferrules on strips of 50 (DIN or other color code) | 20 – 14 | .50 – 2.50 | .31" (8mm) | X | | | | | | | | | |

A. System Overview

B1. Cable Ties

B2. Cable Accessories

B3. Stainless Steel Ties

C1. Wiring Duct

C2. Surface Raceway

C3. Abrasion Protection

C4. Cable Management

D1. Terminals

D2. Power Connectors

D3. Grounding Connectors

E1. Labeling Systems

E2. Labels

E3. Pre-Printed & Write-On Markers

E4. Permanent Identification

E5. Lockout/Tagout & Safety Solutions

F. Index

A.
System
Overview

Technical Specification and Selection Information

B1.
Cable Ties

The following pages provide information helpful in specifying *PANDUIT* terminals and selecting the appropriate terminal and tooling for your applications.

B2.
Cable
Accessories

PANDUIT Terminal Approvals



B3.
Stainless
Steel Ties

C1.
Wiring
Duct

C2.
Surface
Raceway

C3.
Abrasion
Protection

C4.
Cable
Management

D1.
Terminals

D2.
Power
Connectors

D3.
Grounding
Connectors

E1.
Labeling
Systems

E2.
Labels

E3.
Pre-Printed
& Write-On
Markers

E4.
Permanent
Identification

E5.
Lockout/
Tagout
& Safety
Solutions

F.
Index

| Logo (Symbol) | Agency | Spec/Approval | Requirement | Applicable Products |
|---------------|--|---|---|--|
| | Underwriters Laboratories, Inc. | #E52164 – UL 486A | Minimum tensile strength (pull out force for the crimp terminal) and test current for max. 50°C rise (amps) | All Ring and Fork Terminals |
| | | #E78522 – UL 310 | Minimum tensile strength (pull out force for the crimp terminal) and continuous test current for max. 30°C rise (amps) (for .187", .205", .250" tab widths) and (.110" tab width) | All Disconnects |
| | | #E52164 – UL 486C | Minimum tensile strength (pull out force for the crimp terminal) and test current for max. 50°C rise (amps) | All Splices |
| | Canadian Standards Association | #LR31212 – C22.2 No. 65 | Minimum tensile Strength (pull out force for the crimp terminal) and test current for max. 50°C rise (amps) | All Ring and Fork Terminals |
| | | #LR31212 – C22.2 No. 153 | | All Disconnects |
| | American Bureau of Shipping | ABS Rules, Steel Vessel Rules 1-1-4/7.7, 4-8-3/9.19, 4-8-4/21.28 | Passed extensive testing requirements to verify that product will perform reliably in marine and offshore environments | Fork Terminals: P-F, PN-F, PV-F, PN-LF, PNF-LF, PV-LF, P-LF Ring Terminals: P-R, PN-R, PNF-R, RV-R, S-R Wire Joints: JN224-318, JN218-216, JN418-212 Splices: BSN, BSV, BS Disconnects: DNF, DNF-FIB, DVF, D, DNF-FL, DNF-M, DNF18-250M, DNF14-250M, DNF18-250FIM, FIMB, FIB, 14-250FIM, FIMB, FIB |
| | U.S. Code, Title 10, Section 2533a | The Berry Amendment 252.225-7014 for Specialty Metals | Bans the use of various metals manufactured outside of the United States | All Ring, Fork, Pin and Blade Terminals, Splices, Ferrules, Wire Joints and Disconnects |
| | IEEE (Institute of Electrical and Electronics Engineers) | IEEE std 323-2003 for Qualifying Class 1E Eqpt. for Nuclear Power Generating Stations | Meets criteria for use in harsh, high radiation environments in nuclear power plants | ■KYNAR Ring Terminals |
| | Dept. of Defense | Mil Spec Qualification Test Ref #01017302.AB/08-31-2006 | Approved for listing on QPL AS 7928 Class I and Class II | Ring Terminals |

■KYNAR is a registered trademark of Atofina Chemicals, Inc.

Performance Requirements

| | Wire Size (AWG) | | | | | | | | |
|--|-----------------|-----|-----|-----|-----|-----|-----|-----|-----|
| | #26 | #24 | #22 | #20 | #18 | #16 | #14 | #12 | #10 |
| UL 486A (TERMINALS), UL 310 (MALE BLADE ADAPTERS) | | | | | | | | | |
| Test Current for Max. 50°C Rise (Amps) | 3.5 | 7 | 9 | 12 | 17 | 18 | 30 | 35 | 50 |
| Min. Tensile Strength* (Lbs.) | 3 | 5 | 8 | 13 | 20 | 30 | 50 | 70 | 80 |
| UL 486C (SPLICES) | | | | | | | | | |
| Test Current for Max. 50°C Rise (Amps) | 5.5 | 7 | 9 | 12 | 17 | 18 | 30 | 35 | 50 |
| Min. Tensile Strength* (Lbs.) | 3 | 5 | 8 | 10 | 10 | 15 | 25 | 35 | 40 |

*Pull-out force of the crimped terminal.

| | Wire Size (AWG) | | | | | | |
|---|-----------------|-----|-----|-----|----------------|-----|-----|
| | #22 | #20 | #18 | #16 | *#14 | #12 | #10 |
| UL 310 (DISCONNECTS) | | | | | | | |
| Continuous Test Current for Max. 30°C Rise (amps) (for 187", 205", 250" tab widths) | 3 | 4 | 7 | 10 | 15 | 20 | 24 |
| Continuous Test Current for Max. 30°C Rise (amps) (for .110", tab width) | 2 | 3 | 4 | 5 | Not Applicable | | |
| Min. Tensile Strength* (Lbs.) | 8 | 13 | 20 | 30 | 50 | 70 | 80 |

*Pull-out force of the crimped disconnect.

Applicable **PAN-TERM®** products meet or exceed the following test specifications:

- UL 486A (Terminals)
- UL 486C (Splices)
- UL 310 (Blade Adapters)
- CSA C22.2 No. 65 (all designs)

UL and CSA approved products are shown with the applicable logos in the product section. UL file #E52164, CSA File #LR31212.

Applicable **PAN-TERM®** products meet or exceed the following test specifications:

- UL 310 (Disconnects)
- CSA C22.2 No. 153 (all designs)

UL and CSA Listed products are shown with the applicable logos in the product section. UL file #E78522 and CSA file #LR31212.

PANDUIT® PAN-TERM® Terminal Military Cross Reference

| Current Mil. Std Part No., Class 1 | Ring Terminals Nylon Insulated |
|------------------------------------|--------------------------------|
| MS25036-101 | PN18-6RN |
| MS25036-102 | PN18-6R |
| MS25036-103 | PN18-10R |
| MS25036-104 | PN18-56R |
| MS25036-105 | PN18-38R |
| MS25036-106 | PN14-6RN |
| MS25036-107 | PN14-6R |
| MS25036-108 | PN14-10R |
| MS25036-109 | PN14-56R |
| MS25036-110 | PN14-38R |
| MS25036-111 | PN10-6R |
| MS25036-112 | PN10-10R |
| MS25036-113 | PN10-56R |
| MS25036-114 | PN10-38R |
| MS25036-148 | PN18-4RN |
| MS25036-149 | PN18-8R |
| MS25036-150 | PN18-14R |
| MS25036-152 | PN14-4R |
| MS25036-153 | PN14-8R |
| MS25036-154 | PN14-14R |
| MS25036-156 | PN10-8R |
| MS25036-157 | PN10-14R |

| Current Mil. Std. Part No., Class 2 | Ring Terminals, Nylon Insulated or Nylon Insulated with Funnel Entry |
|-------------------------------------|--|
| MS25036-101 | PN18-6RN or PNF18-6RN |
| MS25036-102 | PN18-6R or PNF18-6R |
| MS25036-103 | PN18-10R or PNF18-10R |
| MS25036-104 | PN18-56R or PNF18-56R |
| MS25036-105 | PN18-38R or PNF18-38R |
| MS25036-106 | PN14-6RN or PNF14-6RN |
| MS25036-107 | PN14-6R or PNF14-6R |
| MS25036-108 | PN14-10R or PNF14-10R |
| MS25036-109 | PN14-56R or PNF14-56R |
| MS25036-110 | PN14-38R or PNF14-38R |
| MS25036-111 | PN10-6R or PNF10-6R |
| MS25036-112 | PN10-10R or PNF10-10R |
| MS25036-113 | PN10-56R or PNF10-56R |
| MS25036-114 | PN10-38R or PNF10-38R |
| MS25036-148 | PN18-4RN or PNF18-4RN |
| MS25036-149 | PN18-8R or PNF18-8R |
| MS25036-150 | PN18-14R or PNF18-14R |
| MS25036-152 | PN14-4R or PNF14-4R |
| MS25036-153 | PN14-8R or PNF14-8R |
| MS25036-154 | PN14-14R or PNF14-14R |
| MS25036-156 | PN10-8R or PNF10-8R |
| MS25036-157 | PN10-14R or PNF10-14R |

Crimping Tools: CT-400 and CT-460

| Current Mil. Std. Part No., Class 1 | Ring Terminals Non-Insulated |
|-------------------------------------|------------------------------|
| MS20659-165 | P10-6R |
| MS20659-105 | P10-10R |
| MS20659-106 | P10-56R |
| MS20659-128 | P10-38R |

A. System Overview

B1. Cable Ties

B2. Cable Accessories

B3. Stainless Steel Ties

C1. Wiring Duct

C2. Surface Raceway

C3. Abrasion Protection

C4. Cable Management

D1. Terminals

D2. Power Connectors

D3. Grounding Connectors

E1. Labeling Systems

E2. Labels

E3. Pre-Printed & Write-On Markers

E4. Permanent Identification

E5. Lockout/Tagout & Safety Solutions

F. Index

A.
System
Overview

Stud Size Chart (Inches/Millimeters)

B1.
Cable Ties

B2.
Cable
Accessories

B3.
Stainless
Steel Ties

C1.
Wiring
Duct

C2.
Surface
Raceway

C3.
Abrasion
Protection

C4.
Cable
Management

D1.
Terminals

D2.
Power
Connectors

D3.
Grounding
Connectors

E1.
Labeling
Systems











E2.
Labels

E3.
Pre-Printed
& Write-On
Markers

E4.
Permanent
Identification

E5.
Lockout/
Tagout/
& Safety
Solutions

F.
Index

| |  |  |  |  |  |  |  |  |  |  |
|--|---|---|---|---|---|---|---|---|---|---|
| Standard Stud Size | #2 | #4 | #5 | #6 | #8 | #10 | 1/4" | 5/16" | 3/8" | 7/16" |
| Metric Stud Size (mm) | M2 | M2.5 | M3 | M.35 | M4 | M5 | M6 | M8 | M10 | M11 |
| Stud Size Decimal Equivalent | .086" | .112" | .127" | .138" | .164" | .190" | .250" | .312" | .375" | .438" |
| Metric Diameter (mm) | 2.18 | 2.84 | 3.18 | 3.51 | 4.17 | 4.83 | 6.35 | 7.92 | 9.53 | 11.13 |
| Terminal Hole Diameter | .090" | .118" | .130" | .147" | .173" | .204" | .270" | .343" | .392** | .456" |
| Terminal Hole Diameter Metric (mm) | 2.29 | 3.0 | 3.23 | 3.71 | 4.39 | 5.18 | 6.86 | 8.71 | 9.78 | 11.58 |
| Stud Size Designation in PANDUIT Part Number | 2 | 4 | 5 | 6 | 8 | 10 | 14 | 56 | 38 | 76 |

*Terminal stud.

**Power Connector stud.

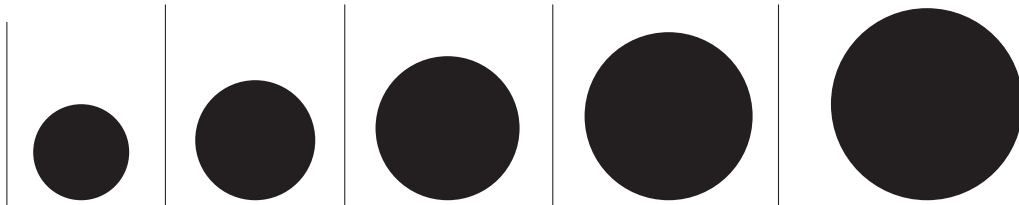

| | | | | | |
|--|-------|-------|-------|-------|--------|
| Standard Stud Size | 1/2" | 5/8" | 3/4" | 7/8" | 1" |
| Metric Stud Size (mm) | M12 | M16 | M18 | M20 | M25 |
| Stud Size Decimal Equivalent | .500" | .625" | .750" | .875" | 1.00" |
| Metric Diameter (mm) | 12.7 | 15.88 | 19.05 | 22.23 | 25.4 |
| Terminal Hole Diameter | .531" | .656" | .810" | .906" | 1.031" |
| Terminal Hole Diameter Metric (mm) | 13.49 | 16.66 | 20.57 | 23.01 | 26.19 |
| Stud Size Designation in PANDUIT Part Number | 12 | 58 | 34 | 78 | 1 |

Note: Stud hole diagrams are for U.S. reference only.

Equivalent Tables

Decimal/Inches/Millimeters

| | | | |
|---------------------|----------------------|----------------------|----------------------|
| 1/64 — .0156 0,396 | 17/64 — .2656 6,746 | 33/64 — .5156 13,100 | 49/64 — .7656 19,446 |
| 1/32 — 0.312 0,792 | 9/32 — .2812 7,143 | 17/32 — .5312 13,492 | 25/32 — .7812 14,842 |
| 3/64 — .0468 1,189 | 19/64 — .2968 7,541 | 35/64 — .5468 13,891 | 51/64 — .7968 20,241 |
| 1/16 — .0625 1,588 | 5/16 — .3125 7,938 | 9/16 — .5625 14,288 | 13/16 — .8125 20,637 |
| 5/64 — .0781 1,984 | 21/64 — .3281 8,337 | 37/64 — .5781 14,684 | 53/64 — .8281 21,034 |
| 3/32 — .0937 2,380 | 11/32 — .3437 8,730 | 19/32 — .5937 15,080 | 27/32 — .8437 21,480 |
| 7/64 — .1093 2,779 | 23/64 — .3593 9,129 | 39/64 — .6093 15,479 | 55/64 — .8593 21,828 |
| 1/8 — .125 3,175 | 3/8 — .375 9,525 | 5/8 — .625 15,875 | 7/8 — .875 22,225 |
| 9/64 — .1406 3,571 | 25/64 — .3906 9,921 | 41/64 — .6406 16,271 | 57/64 — .8906 22,620 |
| 5/32 — .1562 3,968 | 13/32 — .4062 10,317 | 21/32 — .6562 16,667 | 29/32 — .9062 23,017 |
| 11/64 — .1718 4,366 | 27/64 — .4218 10,716 | 43/64 — .6718 17,066 | 59/64 — .9218 23,416 |
| 3/16 — .1875 4,763 | 7/16 — .4375 11,113 | 11/16 — .6875 17,463 | 15/16 — .9375 23,810 |
| 13/64 — .2031 5,159 | 29/64 — .4531 11,509 | 45/64 — .7031 17,859 | 61/64 — .9531 24,208 |
| 7/32 — .2187 5,555 | 15/32 — .4687 11,905 | 23/32 — .7187 18,255 | 31/32 — .9687 24,605 |
| 15/64 — .2343 5,954 | 31/64 — .4843 12,304 | 47/64 — .7343 18,654 | 63/64 — .9843 25,001 |
| 1/4 — .25 6,350 | 1/2 — .5 12,700 | 3/4 — .75 19,050 | 1 — 1. 25,400 |

Common Conductor Size Chart (Stranded Wire)

| Size | No. of Strands | Individual Strand Size | | | Conductor Size | | | | |
|--------|----------------|------------------------|-------------|------------------------------------|----------------|-------------|------------------------------------|---------------|-----------------|
| | | Inches (mm) | Inches (mm) | Circle Mil Area (mm ²) | Inches (mm) | Inches (mm) | Circle Mil Area (mm ²) | | |
| 22 AWG | 7 | .0096 (0.24) | .029 (0.74) | 640 (0.324) | 1/0 AWG | 19 | .0745 (1.89) | .373 (9.47) | 105,600 (0.823) |
| 20 AWG | 10 | .0100 (0.25) | .038 (0.97) | 1020 (0.519) | 2/0 AWG | 19 | .0837 (2.13) | .418 (10.62) | 133,100 (67.43) |
| 18 AWG | 16 | .0100 (0.25) | .048 (1.22) | 1620 (0.823) | 3/0 AWG | 19 | .0940 (2.39) | .470 (11.94) | 167,800 (85.01) |
| 16 AWG | 26 | .0100 (0.25) | .060 (1.52) | 2580 (1.310) | 4/0 AWG | 19 | .1055 (2.68) | .528 (13.41) | 211,600 (107.2) |
| 14 AWG | 7 | .0242 (0.61) | .073 (1.85) | 4110 (2.080) | 250 kcmil | 37 | .0822 (2.09) | .575 (14.61) | 250,000 (127) |
| 12 AWG | 7 | .0305 (0.77) | .092 (2.34) | 6530 (3.310) | 300 kcmil | 37 | .0900 (2.29) | .630 (16.00) | 300,000 (152) |
| 10 AWG | 7 | .0385 (0.98) | .116 (2.95) | 10,380 (5.261) | 350 kcmil | 37 | .0973 (2.47) | .681 (17.29) | 350,000 (177) |
| 8 AWG | 7 | .0486 (1.23) | .146 (3.71) | 16,510 (8.367) | 400 kcmil | 37 | .1040 (2.64) | .728 (18.49) | 400,000 (203) |
| 6 AWG | 7 | .0612 (1.55) | .184 (4.67) | 26,240 (13.30) | 500 kcmil | 37 | .1162 (2.95) | .813 (20.65) | 500,000 (253) |
| 4 AWG | 7 | .0772 (1.96) | .232 (5.89) | 41,740 (21.15) | 600 kcmil | 61 | .0992 (2.52) | .893 (22.68) | 600,000 (304) |
| 2 AWG | 7 | .0974 (2.47) | .292 (7.42) | 66,360 (33.62) | 750 kcmil | 61 | .1109 (2.82) | .998 (25.35) | 750,000 (380) |
| 1 AWG | 19 | .0664 (1.69) | .332 (8.43) | 83,690 (42.41) | 800 kcmil | 61 | .1145 (2.91) | 1.031 (26.19) | 800,000 (405) |
| | | | | | 1000 kcmil | 61 | .1280 (3.25) | 1.152 (29.26) | 1,000,000 (507) |

A.
System
Overview

B1.
Cable Ties

Common Conductor Sizes and Strandings Reference Chart

B2.
Cable
Accessories

B3.
Stainless
Steel Ties

C1.
Wiring
Duct

C2.
Surface
Raceway

C3.
Abrasion
Protection

C4.
Cable
Management

D1.
Terminals

D2.
Power
Connectors

D3.
Grounding
Connectors

E1.
Labeling
Systems

E2.
Labels

E3.
Pre-Printed
& Write-On
Markers

E4.
Permanent
Identification

E5.
Lockout/
Tagout
& Safety
Solutions

F.
Index

| Conductor | | Individual Strands | | | Overall Conductor Size | | | Conductor | | Individual Strands | | | Overall Conductor Size | | |
|------------------------------------|------------------------|--------------------|----------|------|------------------------|-------|------------|-----------|------------------------|--------------------|----------|------|------------------------|------|------------|
| AWG | Metric mm ² | No. | Diameter | | Diameter | | Circ. MILS | AWG | Metric mm ² | No. | Diameter | | Diameter | | Circ. MILS |
| | | | mm | In. | mm | In. | | | | | mm | In. | mm | In. | |
| | .05 | 25 | .05 | .002 | .25 | .010 | 97 | | | 19 | 0.25 | .010 | 1.30 | .051 | 1841 |
| | .06 | 41 | .05 | .002 | .36 | .014 | 159 | | | 1 | 1.13 | .044 | 1.13 | .044 | 1979 |
| 26 | | 10 | .13 | .005 | .53 | .021 | 250 | 16 | | 32 | .20 | .008 | 1.30 | .051 | 1984 |
| | | 1 | .41 | .016 | .41 | .016 | 256 | | | 7 | .43 | .017 | 1.30 | .051 | 2006 |
| | | 7 | .16 | .006 | .48 | .019 | 278 | | | 19 | .29 | .011 | 1.47 | .058 | 2426 |
| | | 19 | .10 | .004 | .51 | .020 | 304 | | | 65 | .16 | .006 | 1.50 | .059 | 2580 |
| 24 | | 41 | .08 | .003 | .58 | .023 | 384 | | | *26 | .25 | .010 | 1.50 | .059 | 2600 |
| | | 10 | .16 | .006 | .58 | .023 | 397 | | | 1 | 1.30 | .051 | 1.30 | .051 | 2601 |
| | | 1 | .51 | .020 | .51 | .020 | 400 | | | 105 | .13 | .005 | 1.50 | .059 | 2625 |
| | | 7 | .20 | .008 | .61 | .024 | 448 | | | *7 | .51 | .020 | 1.52 | .060 | 2828 |
| | | 19 | .13 | .005 | .61 | .024 | 475 | | | 30 | .25 | .010 | 1.70 | .067 | 2906 |
| | | 65 | .07 | .003 | .65 | .026 | 484 | | | 21 | .30 | .012 | 1.60 | .063 | 2930 |
| | | 128 | .05 | .002 | .65 | .026 | 496 | | | 189 | .10 | .004 | 1.90 | .075 | 2930 |
| | | 32 | .10 | .004 | .65 | .026 | 496 | | | 7 | .52 | .020 | 1.60 | .063 | 2934 |
| | | 14 | .16 | .006 | .65 | .026 | 556 | | | 1 | 1.38 | .054 | 1.38 | .054 | 2952 |
| | | 1 | .64 | .025 | .64 | .025 | 625 | | | 45 | .16 | .006 | 1.85 | .073 | 3786 |
| | | 16 | .16 | .006 | .76 | .030 | 635 | | | 19 | .38 | .014 | 1.85 | .073 | 3831 |
| | | 26 | .13 | .005 | .76 | .030 | 650 | | | 1 | 1.63 | .064 | 1.63 | .064 | 4096 |
| 22 | | 7 | .25 | .010 | .76 | .030 | 700 | | | *41 | .25 | .010 | 1.85 | .073 | 4100 |
| | | 19 | .16 | .006 | .79 | .031 | 754 | | | *7 | .64 | .025 | 1.85 | .073 | 4481 |
| | | 48 | .10 | .004 | .80 | .031 | 744 | | | 50 | .25 | .010 | 2.20 | .087 | 4844 |
| | | 194 | .05 | .002 | .80 | .031 | 752 | | | 7 | .67 | .026 | 2.10 | .083 | 4871 |
| | | 100 | .07 | .003 | .80 | .031 | 760 | | | 35 | .30 | .012 | 2.20 | .087 | 4883 |
| | | 7 | .27 | .011 | .80 | .031 | 791 | | | 315 | .10 | .004 | 2.20 | .087 | 4883 |
| | | 12 | .21 | .008 | .80 | .031 | 820 | | | 1 | 1.78 | .070 | 1.78 | .070 | 4911 |
| | | 21 | .16 | .006 | .80 | .031 | 833 | | | 19 | .45 | .018 | 2.36 | .093 | 6088 |
| | | 7 | .30 | .012 | .90 | .035 | 977 | 12 | | *65 | .25 | .010 | 2.41 | .095 | 6500 |
| | | 16 | .20 | .008 | .90 | .035 | 992 | | | 165 | .16 | .006 | 2.41 | .095 | 6549 |
| | | 1 | .80 | .031 | .80 | .031 | 992 | | | 1 | 2.06 | .081 | 2.06 | .081 | 6561 |
| | | *10 | .25 | .010 | .89 | .035 | 1000 | | | *7 | .81 | .032 | 2.44 | .096 | 7168 |
| 20 | | 1 | .81 | .032 | .81 | .032 | 1024 | | | 56 | .30 | .012 | 3.10 | .122 | 7812 |
| | | 41 | .13 | .005 | .91 | .036 | 1025 | | | 1 | 2.26 | .089 | 2.26 | .089 | 7917 |
| | | 26 | .16 | .006 | .91 | .036 | 1032 | | | 511 | .10 | .004 | 3.00 | .118 | 7921 |
| | | *7 | .32 | .013 | .97 | .038 | 1111 | | | 19 | .52 | .020 | 2.70 | .106 | 7963 |
| | | 19 | .20 | .008 | .94 | .037 | 1216 | 10 | | 37 | .40 | .016 | 2.92 | .115 | 9354 |
| | | 7 | .37 | .015 | 1.10 | .043 | 1485 | | | 49 | .36 | .014 | 2.95 | .116 | 9880 |
| | | 24 | .20 | .008 | 1.20 | .047 | 1488 | | | *7 | .98 | .039 | 2.95 | .116 | 10376 |
| | | 1 | 1.00 | .039 | 1.00 | .039 | 1550 | | | 1 | 2.59 | .102 | 2.59 | .102 | 10404 |
| 18 | | *16 | .25 | .010 | 1.19 | 0.047 | 1600 | | | *105 | .25 | .010 | 2.95 | .116 | 10500 |
| | | 1 | 1.02 | .040 | 1.02 | .040 | 1600 | | | 84 | .30 | .012 | 3.50 | .138 | 11718 |
| | | 65 | .13 | .005 | 1.19 | .047 | 1625 | | | 756 | .10 | .004 | 3.70 | .146 | 11718 |
| | | 41 | .16 | .006 | 1.19 | .047 | 1627 | | | 1 | 2.76 | .109 | 2.76 | .109 | 11807 |
| E4. Permanent Identification | | *7 | .40 | .016 | 1.22 | .048 | 1770 | | | 7 | 1.05 | .041 | 3.20 | .126 | 11962 |
| | | 19 | .25 | .010 | 1.24 | .049 | 1900 | | | 19 | .64 | .025 | 3.30 | .130 | 12063 |

*Strandings required for UL and CSA certification testing.

This chart details the different conductors commonly used in the industry. For each size, either AWG or metric, various stranding options are listed. Typically the higher stranding is used in applications requiring greater conductor flexibility.

| AWG to Metric Wire Crosses | |
|----------------------------|---------------------------|
| AWG | Metric (mm ²) |
| 26 – 22 | 0.1 – 0.5 |
| 22 – 18 | 0.5 – 1.0 |
| 16 – 14 | 1.5 – 2.5 |
| 12 – 10 | 4.0 – 6.0 |

Common Conductor Sizes and Strandings Reference Chart (continued)

| Conductor | | Individual Strands | | | Overall Conductor Size | | | Conductor | | Individual Strands | | | Overall Conductor Size | | |
|-----------|------------------------|--------------------|----------|--------|------------------------|-------|--------|------------|-----------|--------------------|----------|--------|------------------------|-------|--------------|
| | | No. | Diameter | | Diameter | | Area | | | No. | Diameter | | Diameter | | Area |
| AWG | Metric mm ² | | | mm | In. | mm | In. | Circ. MILS | | | | | mm | In. | Circ. MILS |
| | 6 | 7 | 0.107 | 0.042 | 3.21 | 0.126 | 11840 | | 95 | 19 | 2.57 | 0.101 | 12.8 | 0.505 | 187500 |
| | | 1 | 2.77 | 0.109 | 2.77 | 0.109 | 11840 | | | 37 | 1.83 | 0.072 | 12.5 | 0.504 | 187500 |
| 9 | | 7 | 1.1 | 0.0432 | 3.3 | 0.13 | 13000 | 4/0 | | 19 | 2.89 | 0.1055 | 13.4 | 0.528 | 211600 |
| | | 1 | 2.91 | 0.1144 | 2.91 | 0.114 | 13090 | | 120 | 37 | 2.06 | 0.081 | 14.4 | 0.567 | 237.8 kcmil |
| 8 | | 1 | 3.26 | 0.1285 | 3.25 | 0.128 | 16510 | 250 kcmil | | 37 | 2.07 | 0.0822 | 14.6 | 0.575 | 250 kcmil |
| | | 7 | 1.23 | 0.0486 | 3.7 | 0.146 | 16510 | 300 kcmil | 150 | 37 | 2.29 | 0.09 | 16 | 0.63 | 300 kcmil |
| | 10 | 7 | 1.37 | 0.054 | 4.12 | 0.162 | 19740 | 350 kcmil | | 37 | 2.47 | 0.0973 | 17.3 | 0.681 | 350 kcmil |
| | | 1 | 3.58 | 0.141 | 3.58 | 0.141 | 19740 | | 185 | 37 | 2.54 | 0.1 | 17.8 | 0.7 | 365.1 kcmil |
| 7 | | 7 | 1.38 | 0.0545 | 4.15 | 0.164 | 20520 | 400 kcmil | | 37 | 2.64 | 0.104 | 18.5 | 0.728 | 400 kcmil |
| | | 1 | 3.67 | 0.1443 | 3.67 | 0.144 | 20520 | | 240 | 37 | 2.9 | 0.114 | 20.3 | 0.798 | 473.6 kcmil |
| 6 | | 7 | 1.55 | 0.0612 | 4.66 | 0.184 | 26240 | | | 61 | 2.26 | 0.089 | 20.3 | 0.801 | 473.6 kcmil |
| | | 1 | 4.11 | 0.162 | 4.11 | 0.162 | 26240 | 500 kcmil | | 37 | 2.95 | 0.1162 | 20.7 | 0.813 | 500 kcmil |
| | 16 | 7 | 1.73 | 0.008 | 5.13 | 0.204 | 31580 | | | 61 | 2.3 | 0.0905 | 20.7 | 0.814 | 500 kcmil |
| 5 | | 7 | 1.75 | 0.0688 | 5.24 | 0.206 | 33090 | | 300 kcmil | 61 | 2.51 | 0.099 | 22.6 | 0.891 | 592.1 kcmil |
| 4 | | 7 | 1.96 | 0.0772 | 5.88 | 0.232 | 41740 | 600 kcmil | | 61 | 2.52 | 0.0992 | 22.7 | 0.893 | 600 kcmil |
| | 25 | 7 | 2.16 | 0.085 | 6.48 | 0.255 | 49340 | 700 kcmil | | 61 | 2.72 | 0.1071 | 24.5 | 0.964 | 700 kcmil |
| | | 19 | 1.32 | 0.052 | 6.6 | 0.26 | 49340 | 750 kcmil | | 61 | 2.82 | 0.1109 | 25.4 | 0.998 | 750 kcmil |
| 3 | | 7 | 2.2 | 0.0867 | 6.61 | 0.26 | 52620 | | | 91 | 2.31 | 0.0908 | 25.4 | 0.998 | 750 kcmil |
| 2 | | 7 | 2.47 | 0.0974 | 7.42 | 0.292 | 66300 | | 400 | 61 | 2.9 | 0.114 | 26.1 | 1.026 | 798.4 kcmil |
| | 35 | 7 | 2.54 | 0.1 | 7.62 | 0.300 | 69070 | 800 kcmil | | 61 | 2.91 | 0.1145 | 26.2 | 1.031 | 800 kcmil |
| | | 19 | 1.55 | 0.001 | 7.75 | 0.305 | 69070 | | | 91 | 2.38 | 0.0938 | 26.2 | 1.032 | 800 kcmil |
| 1 | | 19 | 1.5 | 0.0064 | 8.43 | 0.332 | 83690 | 1000 kcmil | 500 | 61 | 3.25 | 0.128 | 28.3 | 1.152 | 986.8 kcmil |
| | 50 | 19 | 1.85 | 0.073 | 9.27 | 0.365 | 98680 | | | 91 | 2.66 | 0.1048 | 29.3 | 1.153 | 1000 kcmil |
| 1/0 | | 19 | 1.59 | 0.0745 | 9.46 | 0.373 | 10500 | | 625 | 91 | 2.97 | 0.117 | 32.7 | 1.287 | 1233.7 kcmil |
| 2/0 | | 19 | 2.13 | 0.0837 | 10.6 | 0.419 | 133100 | | | | | | | | |
| 3/0 | 70 | 19 | 2.18 | 0.086 | 10.9 | 0.43 | 138100 | | | | | | | | |
| | | 19 | 2.59 | 0.094 | 11.9 | 0.47 | 167800 | | | | | | | | |
| | | 36 | 1.71 | 0.0673 | 12 | 0.471 | 167800 | | | | | | | | |

This chart details the different conductors commonly used in the industry. For each size, either AWG or metric, various stranding options are listed. Typically the higher stranding is used in applications requiring greater conductor flexibility.

| AWG to Metric Wire Crosses | |
|----------------------------|---------------------------|
| AWG | Metric (mm ²) |
| 26 – 22 | 0.1 – 0.5 |
| 22 – 18 | 0.5 – 1.0 |
| 16 – 14 | 1.5 – 2.5 |
| 12 – 10 | 4.0 – 6.0 |

A.
System
Overview

B1.
Cable Ties

B2.
Cable
Accessories

B3.
Stainless
Steel Ties

C1.
Wiring
Duct

C2.
Surface
Raceway

C3.
Abrasion
Protection

C4.
Cable
Management

D1.
Terminals

D2.
Power
Connectors

D3.
Grounding
Connectors

E1.
Labeling
Systems

E2.
Labels

E3.
Pre-Printed
& Write-On
Markers

E4.
Permanent
Identification

E5.
Lockout/
Tagout/
& Safety
Solutions

F.
Index

NOTES

REEL SMART™ SYSTEM



The PANDUIT® REEL SMART™ System provides the best solution for quality, high volume terminations designed to dramatically reduce set-up time and production downtime. This increased efficiency translates into real cost savings throughout the termination process from start to finish.

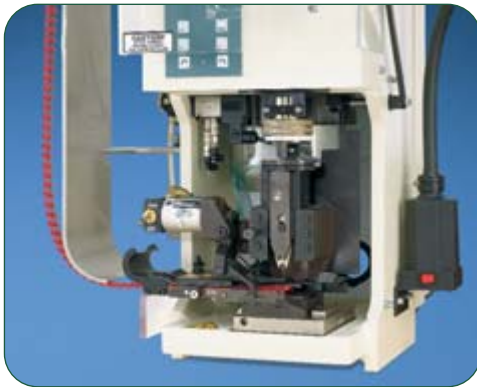

NEW!

- One applicator system terminates over 400 continuously molded terminals, reducing cost of ownership
- Continuously molded integrated carrier guarantees alignment of terminal; front-to-back and side-to-side to eliminate skewing of product resulting in consistent, high quality low cost termination
- Available in large reels requiring less product changeover, resulting in less downtime
- Applicable sizes are UL Listed and CSA Certified, as noted
- PANDUIT® CA9 EZAIR™ Universal Applicator works with REEL SMART™ reel-fed terminals to deliver the ultimate fully automatic, high-capacity termination performance
- New PANDUIT reel and strip ferrules combine with tooling options to support wire harness, control panel, and automatic wire processing applications

PANDUIT continually provides new designs with innovative features to meet the application challenges encountered by customers, while providing the lowest installed cost.

A.
System
Overview

B1.
Cable Ties

B2.
Cable
Accessories

B3.
Stainless
Steel Ties

C1.
Wiring
Duct

C2.
Surface
Raceway

C3.
Abrasion
Protection

C4.
Cable
Management

D1.
Terminals

D2.
Power
Connectors

D3.
Grounding
Connectors

E1.
Labeling
Systems

E2.
Labels

E3.
Pre-Printed
& Write-On
Markers

E4.
Permanent
Identification

E5.
Lockout/
Tagout
& Safety
Solutions

F.
Index

A. System Overview

Features and Benefits – REEL SMART™ Termination System

The PANDUIT continuously molded REEL SMART™ products are designed such that the terminal, disconnect, and butt splice housings are connected by an integral molded carrier in the barrel crimp zone, producing a continuous length of product. Plated metal terminals, disconnects, and splices are then assembled into the housings. During termination, the continuously molded components are fed into a universal applicator. This process produces a reel-fed solution that eliminates a variety of problems associated with other reel-fed designs and provides high quality, high capacity product on reels for longer, uninterrupted production runs – resulting in the lowest installed cost.

B1. Cable Ties

B2. Cable Accessories

B3. Stainless Steel Ties

C1. Wiring Duct

C2. Surface Raceway

C3. Abrasion Protection

C4. Cable Management

D1. Terminals

D2. Power Connectors

D3. Grounding Connectors

E1. Labeling Systems

E2. Labels

E3. Pre-Printed & Write-On Markers

E4. Permanent Identification

E5. Lockout/Tagout & Safety Solutions

F. Index

Pre-insulated design eliminates the need for post-insulation – resulting in labor savings

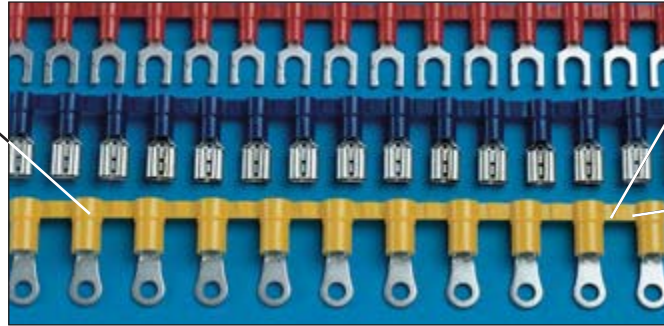

Continuously molded design always aligns product with the carrier strip – resulting in trouble free tool operation

Plastic carrier strip eliminates sharp, unplated edges as found on metal strip-fed carriers – providing better corrosion resistance

REEL SMART™ CA9 EZAIR™ Universal Applicator

The PANDUIT® CA9 EZAIR™ applicator automatically adjusts feed stroke to the correct pitch and length for the entire product line of continuously molded products. The need for multiple applicators is eliminated. The applicator, in conjunction with the precision, continuously molded product provides perfect front-to-back and side-to-side alignment in the die pocket for a high quality termination every time – resulting in the most optimum system to terminate terminals.

Automatic, self-adjusting feed stroke – resulting in correct pitch and length

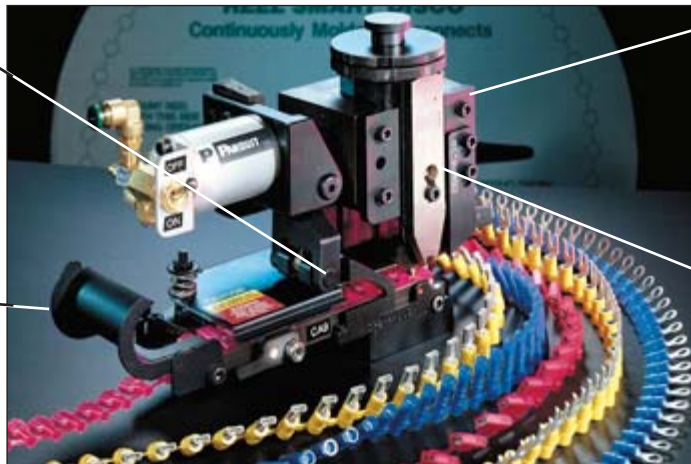

Universal applicator installs entire REEL SMART™ product line – resulting in lower tooling inventory costs

Versatile applicator design – allows for use in bench presses, and most automatic wire processing systems

Quick change dies – provide fast product change-over and reduction in set-up time

Nylon Insulated Terminals with Insulation Grip Sleeve (Funnel and Non-Funnel Entry Types)

The three-piece design terminal provides a permanently attached tin-plated brass sleeve for insulation grip in funnel and straight entry sleeve designs. This product feature offers the highest quality reliable terminations. Nylon insulation is rated up to 600 V maximum and designed for up to 221°F (105°C) operating temperature maximum. Supplied on rings, forks, locking forks, short locking forks and flanged forks in wire sizes #22 – 10.



- Sleeved barrel – assures crimp reliability
- PNF – funnel-entry styles available
- Metal insulation crimp – provides DOUBLE CRIMP wire insulation grip sleeve for high vibration or conductor strain environments

- Internal wire barrel serrations – assure good wired contact and maximum tensile strength
- Product markings – UL and CSA rated – up to 600 V, maximum operating temperature 221°F(105°C)

Part Number System for REEL SMART™ Terminals

| P | NF | 14 | 6 | R | N | 3K |
|----------------------------------|---|--|--|--|---|------------------------------------|
| Type | Insulation | Wire Range | Stud Size | Tongue Configuration | Special Configuration | Std. Pkg. Size |
| P = Terminal BS = Butt Splice | N = Nylon Insulated NF = Nylon Insulated Funnel Entry V = Vinyl Insulated | 18 = #22 – 18 14 = #16 – 14 12 = #16 – 12 10 = #12 – 10 | 4 = #4 5 = #5 6 = #6 8 = #8 10 = #10 14 = 1/4" 56 = 5/16" 38 = 3/8" | R = Ring HDR = Heavy Duty Ring F = Fork FF = Fanged Fork LF = Locking Fork SLF = Short Locking Fork | N = Narrow Tongue W = Wide Tongue B = Butted Seam = Standard (leave blank) | 2K = 2,000 pcs. 3K = 3,000 pcs. |



Ring Terminals, Nylon Insulated – Non-Funnel Entry

Type PN-R

- Continuously molded design provides reliable, consistent performance through the applicator for a high quality termination every time
- Ring tongue design assures a secure connection in high vibration applications
- Metal insulation grip sleeve crimps to wire insulation, providing protection to the crimp joint during high vibration applications

- Internal barrel serrations assure good wire contact and maximum tensile strength
- UL Flammability UL 94V-2/HB, maximum insulation temperature 221°F (105°C)
- UL and CSA rated up to 600 V per UL 486

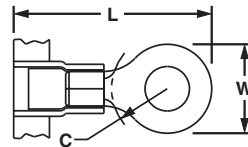

| Part Number | Wire Range | Color Code | Stock Thickness | Max. Ins. | Stud Size | Figure Dimension (In.) | | | CA9 Series Crimp Die | CA-800 Series Crimp Die | Pieces Per Reel |
|-------------|-------------|------------|-----------------|-----------|-----------|------------------------|-----|-----|----------------------|-------------------------|-----------------|
| | | | | | | L | W | C | | | |
| PN18-4R-3K | 22 – 18 AWG | Red | .03 | .145 | #4 | .80 | .25 | .22 | CD9-1A | CD-800-1 | 3000 |
| PN18-6RN-3K | | | | | #6 | .74 | .22 | .18 | | | 3000 |
| PN18-6R-3K | | | | | #6 | .78 | .25 | .22 | | | 3000 |
| PN18-8R-3K | | | | | #8 | .86 | .31 | .25 | | | 3000 |
| PN18-10R-3K | | | | | #10 | .86 | .31 | .25 | | | 3000 |
| PN18-14R-3K | | | | | 1/4" | 1.05 | .45 | .38 | | | 3000 |
| PN14-4R-3K | 16 – 14 AWG | Blue | .03 | .162 | #4 | .76 | .25 | .22 | CD9-2A | CD-800-2 | 3000 |
| PN14-6RN-3K | | | | | #6 | .76 | .25 | .22 | | | 3000 |
| PN14-6R-3K | | | | | #6 | .86 | .31 | .25 | | | 3000 |
| PN14-8R-3K | | | | | #8 | .86 | .31 | .25 | | | 3000 |
| PN14-10R-3K | | | | | #10 | .86 | .31 | .25 | | | 3000 |
| PN14-14R-3K | | | | | 1/4" | 1.06 | .44 | .38 | | | 3000 |
| PN10-6R-2K | 12 – 10 AWG | Yellow | .04 | .225 | #6 | 1.06 | .38 | .31 | CD9-3B | CD-800-3 | 2000 |
| PN10-8R-2K | | | | | #8 | 1.06 | .38 | .31 | | | 2000 |
| PN10-10R-2K | | | | | #10 | 1.06 | .38 | .31 | | | 2000 |
| PN10-14R-2K | | | | | 1/4" | 1.21 | .52 | .38 | | | 2000 |
| PN10-56R-2K | | | | | 5/16" | 1.21 | .52 | .38 | | | 2000 |
| PN10-38R-2K | | | | | 3/8" | 1.29 | .58 | .43 | | | 2000 |

For applicator information, see page D1.143.

A. System Overview

B1. Cable Ties

B2. Cable Accessories

B3. Stainless Steel Ties

C1. Wiring Duct

C2. Surface Raceway

C3. Abrasion Protection

C4. Cable Management

D1. Terminals

D2. Power Connectors

D3. Grounding Connectors

E1. Labeling Systems

E2. Labels

E3. Pre-Printed & Write-On Markers

E4. Permanent Identification

E5. Lockout/Tagout & Safety Solutions

F. Index

A.
System
Overview



Ring Terminals, Nylon Insulated – Funnel Entry

B1.
Cable Ties

Type PNF-R

- Continuously molded design provides reliable, consistent performance through the applicator for a high quality termination every time
- Ring tongue design assures a secure connection in high vibration applications
- Metal insulation grip sleeve crimps to wire insulation, providing protection to the crimp joint during high vibration applications

- Internal barrel serrations assure good wire contact and maximum tensile strength
- UL Flammability UL 94V-2/HB, maximum insulation temperature 221°F (105°C)
- UL and CSA rated up to 600 V per UL 486

B2.
Cable
Accessories

B3.
Stainless
Steel Ties

C1.
Wiring
Duct

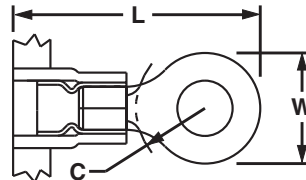

C2.
Surface
Raceway

C3.
Abrasion
Protection

C4.
Cable
Management

D1.
Terminals

D2.
Power
Connectors

D3.
Grounding
Connectors

E1.
Labeling
Systems

E2.
Labels

E3.
Pre-Printed
& Write-On
Markers

E4.
Permanent
Identification

E5.
Lockout/
Tagout/
& Safety
Solutions

F.
Index

| Part Number | Wire Range | Color Code | Stock Thickness | Max. Ins. | Stud Size | Figure Dimensions (In.) | | | CA9 Series Crimp Die | CA-800 Series Crimp Die | Pieces Per Reel |
|---------------------|-------------|------------|-----------------|-----------|-------------|-------------------------|-----|------|----------------------|-------------------------|-----------------|
| | | | | | | L | W | C | | | |
| PNF18-4RN-3K | 22 – 18 AWG | Red | .03 | .145 | #4 | .74 | .22 | .19 | CD9-1A | CD-800-1 | 3000 |
| PNF18-4R-3K | | | | | #4 | .78 | .25 | .21 | | | 3000 |
| PNF18-6RN-3K | | | | | #6 | .74 | .22 | .16 | | | 3000 |
| PNF18-6R-3K | | | | | #6 | .78 | .25 | .21 | | | 3000 |
| PNF18-8R-3K | | | | | #8 | .86 | .31 | .25 | | | 3000 |
| PNF18-10R-3K | | | | | #10 | .86 | .31 | .25 | | | 3000 |
| PNF18-14R-3K | | | | | 1/4" | 1.06 | .46 | .38 | | | 3000 |
| PNF14-4R-3K | 16 – 14 AWG | Blue | .03 | .162 | #4 | .78 | .25 | .18 | CD9-2A | CD-800-2 | 3000 |
| PNF14-6RN-3K | | | | | #6 | .78 | .25 | .18 | | | 3000 |
| PNF14-6R-3K | | | | | #6 | .87 | .31 | .24 | | | 3000 |
| PNF14-8R-3K | | | | | #8 | .87 | .31 | .25 | | | 3000 |
| PNF14-10R-3K | | | | | #10 | .85 | .31 | .29 | | | 3000 |
| PNF14-14R-3K | | | | | 1/4" | 1.06 | .46 | .40 | | | 3000 |
| PNF10-6R-2K | | | | | 12 – 10 AWG | Yellow | .04 | .225 | | | #6 |
| PNF10-8R-2K | #8 | 1.06 | .38 | .31 | | | | | 2000 | | |
| PNF10-10R-2K | #10 | 1.06 | .38 | .31 | | | | | 2000 | | |
| PNF10-14R-2K | 1/4" | 1.21 | .52 | .38 | | | | | 2000 | | |
| PNF10-56R-2K | 5/16" | 1.21 | .52 | .38 | | | | | 2000 | | |
| PNF10-38R-2K | 3/8" | 1.29 | .58 | .43 | | | | | 2000 | | |

For applicator information, see page D1.143.

UL LISTED CERTIFIED Ring Terminals, Vinyl Insulated – Funnel Entry

Type PV-RB

- Continuously molded design provides reliable, consistent performance through the applicator for a high quality termination every time
- Ring tongue design assures a secure connection in high vibration applications



- Insulation support helps to prevent wire damage in bending applications
- Maximum insulation temperature 221°F (105°C)
- UL and CSA rated up to 600 V per UL 486

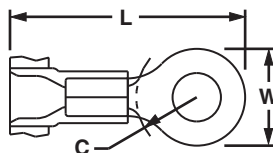

| Part Number | Wire Range | Color Code | Stock Thickness | Max. Ins. | Stud Size | Figure Dimensions (In.) | | | CA9 Series Crimp Die | CA-800 Series Crimp Die | Pieces Per Reel | | | | | | |
|--------------|-------------|------------|-----------------|-----------|-------------|-------------------------|-----|------|----------------------|-------------------------|-----------------|-----|--------|----------|--------|----------|------|
| | | | | | | L | W | C | | | | | | | | | |
| PV18-4RNB-3K | 22 – 18 AWG | Red | .03 | .150 | #4 | .74 | .21 | .19 | CD9-1A | CD-800-1 | 3000 | | | | | | |
| PV18-4RB-3K | | | | | #4 | .78 | .25 | .20 | | | 3000 | | | | | | |
| PV18-6RNB-3K | | | | | #6 | .75 | .23 | .19 | | | 3000 | | | | | | |
| PV18-6RB-3K | | | | | #6 | .78 | .25 | .20 | | | 3000 | | | | | | |
| PV18-8RB-3K | | | | | #8 | .86 | .31 | .25 | | | 3000 | | | | | | |
| PV18-10RB-3K | | | | | #10 | .86 | .31 | .25 | | | 3000 | | | | | | |
| PV18-14RB-3K | | | | | 1/4" | 1.06 | .45 | .38 | | | 3000 | | | | | | |
| PV18-56RB-2K | | | | | 5/16" | 1.06 | .46 | .38 | | | 2000 | | | | | | |
| PV18-38RB-2K | | | | | 3/8" | 1.15 | .53 | .43 | | | 2000 | | | | | | |
| PV14-4RB-3K | | | | | 16 – 14 AWG | Blue | .03 | .170 | | | #4 | .76 | .25 | .22 | CD9-2A | CD-800-2 | 3000 |
| PV14-6RNB-3K | #6 | .76 | .25 | .22 | | | | | 3000 | | | | | | | | |
| PV14-6RB-3K | #6 | .86 | .31 | .25 | | | | | 3000 | | | | | | | | |
| PV14-8RB-3K | #8 | .86 | .31 | .25 | | | | | 3000 | | | | | | | | |
| PV14-10RB-3K | #10 | .86 | .31 | .25 | | | | | 3000 | | | | | | | | |
| PV14-14RB-3K | 1/4" | 1.05 | .45 | .38 | | | | | 3000 | | | | | | | | |
| PV14-56RB-2K | 5/16" | 1.06 | .46 | .38 | | | | | 2000 | | | | | | | | |
| PV14-38RB-2K | 3/8" | 1.15 | .53 | .43 | | | | | 2000 | | | | | | | | |
| PV10-6RB-2K | 12 – 10 AWG | Yellow | .04 | .225 | | | | | #6 | 1.02 | .31 | .31 | CD9-3B | CD-800-3 | | | 2000 |
| PV10-8RB-2K | | | | | | | | | #8 | 1.02 | .31 | .31 | | | | | 2000 |
| PV10-10RB-2K | | | | | #10 | 1.02 | .31 | .31 | 2000 | | | | | | | | |
| PV10-14RB-2K | | | | | 1/4" | 1.20 | .52 | .38 | 2000 | | | | | | | | |
| PV10-56RB-2K | | | | | 5/16" | 1.20 | .52 | .38 | 2000 | | | | | | | | |
| PV10-38RB-2K | | | | | 3/8" | 1.23 | .58 | .38 | 2000 | | | | | | | | |

For applicator information, see page D1.143.

UL LISTED CERTIFIED Multiple Stud Ring Terminals, Vinyl Insulated – Funnel Entry

Type PV-610RB

- Continuously molded design provides reliable, consistent performance through the applicator for a high quality termination every time
- Teardrop shaped mounting hole of multiple stud terminals permits use with #6, #8, or #10 size studs
- Ring tongue design assures a secure connection in high vibration applications



- Insulation support helps to prevent wire damage in bending applications
- Maximum insulation temperature 221°F (105°C)
- UL and CSA rated up to 600 V per UL 486

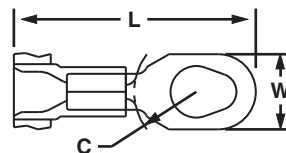

| Part Number | Wire Range | Color Code | Stock Thickness | Max. Ins. | Stud Size | Figure Dimensions (In.) | | | CA9 Series Crimp Die | CA-800 Series Crimp Die | Pieces Per Reel |
|---------------|-------------|------------|-----------------|-----------|-------------|-------------------------|-----|-----|----------------------|-------------------------|-----------------|
| | | | | | | L | W | C | | | |
| PV18-610RB-3K | 22 – 18 AWG | Red | .03 | .150 | #6, #8, #10 | .95 | .31 | .25 | CD9-1A | CD-800-1 | 3000 |
| PV14-610RB-3K | 16 – 14 AWG | Blue | .03 | .170 | | .95 | .31 | .25 | CD9-2A | CD-800-2 | 3000 |
| PV10-610RB-2K | 12 – 10 AWG | Yellow | .04 | .225 | | 1.17 | .37 | .31 | CD9-3B | CD-800-3 | 2000 |

For applicator information, see page D1.143.

A. System Overview

B1. Cable Ties

B2. Cable Accessories

B3. Stainless Steel Ties

C1. Wiring Duct

C2. Surface Raceway

C3. Abrasion Protection

C4. Cable Management

D1. Terminals

D2. Power Connectors

D3. Grounding Connectors

E1. Labeling Systems

E2. Labels

E3. Pre-Printed & Write-On Markers

E4. Permanent Identification

E5. Lockout/Tagout & Safety Solutions

F. Index

A. System Overview



Ring Terminals, Nylon Insulated – Heavy Duty

Type PN-HDR

- Continuously molded design provides reliable, consistent performance through the applicator for a high quality termination every time
- Manufactured from stock 56% thicker than a standard #16 – 14 AWG terminal for use in heavy duty applications
- Insulation housing is marked with “HDR” to signify heavy duty ring
- Metal insulation grip sleeve crimps to wire insulation, providing protection to the crimp joint during high vibration applications
- Internal barrel serrations assure good wire contact and maximum tensile strength
- UL Flammability UL 94V-2/HB, maximum insulation temperature 221°F (105°C)
- UL and CSA rated up to 600 V per UL 486

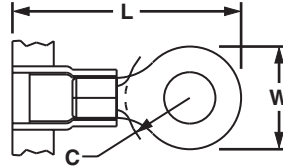

B1. Cable Ties

B2. Cable Accessories

B3. Stainless Steel Ties

C1. Wiring Duct

C2. Surface Raceway

C3. Abrasion Protection

C4. Cable Management

| Part Number | Wire Range | Color Code | Stock Thickness | Max. Ins. | Stud Size | Figure Dimensions (In.) | | | CA9 Series Crimp Die | CA-800 Series Crimp Die | Pieces Per Reel |
|---------------|-------------|------------|-----------------|-----------|-----------|-------------------------|-----|-----|----------------------|-------------------------|-----------------|
| | | | | | | L | W | C | | | |
| PN12-6HDR-2K | 16 – 12 AWG | Yellow | .05 | .225 | #6 | 1.02 | .31 | .31 | CD9-3B | CD-800-3 | 2000 |
| PN12-8HDR-2K | | | | | #8 | 1.02 | .31 | .31 | | | 2000 |
| PN12-10HDR-2K | | | | | #10 | 1.05 | .38 | .31 | | | 2000 |
| PN12-14HDR-2K | | | | | 1/4" | 1.20 | .52 | .38 | | | 2000 |
| PN12-56HDR-2K | | | | | 5/16" | 1.20 | .52 | .38 | | | 2000 |
| PN12-38HDR-2K | | | | | 3/8" | 1.28 | .58 | .38 | | | 2000 |

For applicator information, see page D1.143.

D1. Terminals



Ring Terminals, Vinyl Insulated – Heavy Duty

Type PV-HDRB

- Continuously molded design provides reliable, consistent performance through the applicator for a high quality termination every time
- Manufactured from stock 56% thicker than a standard #16 – 14 AWG terminal for use in heavy duty applications
- Insulation housing is marked with “HDR” to signify heavy duty ring
- Insulation support helps to prevent wire damage in bending applications
- Maximum insulation temperature 221°F (105°C)
- UL and CSA rated up to 600 V per UL 486

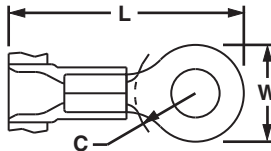

D2. Power Connectors

D3. Grounding Connectors

E1. Labeling Systems

E2. Labels

E3. Pre-Printed & Write-On Markers

E4. Permanent Identification

E5. Lockout/Tagout & Safety Solutions

| Part Number | Wire Range | Color Code | Stock Thickness | Max. Ins. | Stud Size | Figure Dimensions (In.) | | | CA9 Series Crimp Die | CA-800 Series Crimp Die | Pieces Per Reel |
|-----------------------|-------------|------------|-----------------|-----------|-----------|-------------------------|-----|-----|----------------------|-------------------------|-----------------|
| | | | | | | L | W | C | | | |
| PV12-6HDRB-2K | 16 – 12 AWG | Yellow | .05 | .225 | #6 | 1.03 | .31 | .36 | CD9-3B | CD-800-3 | 2000 |
| PV12-8HDRB-2K | | | | | #8 | 1.03 | .31 | .36 | | | 2000 |
| PV12-10HDRB-2K | | | | | #10 | 1.06 | .37 | .36 | | | 2000 |
| PV12-14HDRB-2K | | | | | 1/4" | 1.23 | .52 | .43 | | | 2000 |
| PV12-56HDRB-2K | | | | | 5/16" | 1.23 | .52 | .43 | | | 2000 |
| PV12-38HDRB-2K | | | | | 3/8" | 1.30 | .58 | .48 | | | 2000 |

For applicator information, see page D1.143.

F. Index



Fork Terminals, Nylon Insulated – Non-Funnel Entry

Type PN-F

- Continuously molded design provides reliable, consistent performance through the applicator for a high quality termination every time
- Fork design provides for fast and easy installation, without the need to remove fastener
- Metal insulation grip sleeve crimps to wire insulation, providing protection to the crimp joint during high vibration applications
- Internal barrel serrations assure good wire contact and maximum tensile strength
- UL Flammability UL 94V-2/HB, maximum insulation temperature 221°F (105°C)
- UL and CSA rated up to 600 V per UL 486

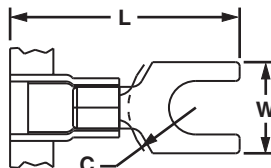

| Part Number | Wire Range | Color Code | Stock Thickness | Max. Ins. | Stud Size | Figure Dimensions (In.) | | | CA9 Series Crimp Die | CA-800 Series Crimp Die | Pieces Per Reel |
|--------------|-------------|------------|-----------------|-----------|-----------|-------------------------|-----|-----|----------------------|-------------------------|-----------------|
| | | | | | | L | W | C | | | |
| PN18-6FN-3K | 22 – 18 AWG | Red | .03 | .145 | #6 | .78 | .25 | .20 | CD9-1A | CD-800-1 | 3000 |
| PN18-6F-3K | | | | | #6 | .78 | .30 | .20 | | | 3000 |
| PN18-8F-3K | | | | | #8 | .84 | .32 | .23 | | | 3000 |
| PN18-10FN-3K | | | | | #10 | .86 | .31 | .25 | | | 3000 |
| PN18-10F-3K | | | | | #10 | .86 | .35 | .25 | | | 3000 |
| PN18-14F-3K | | | | | 1/4" | 1.03 | .44 | .33 | | | 3000 |
| PN14-6FN-3K | 16 – 14 AWG | Blue | .03 | .162 | #6 | .78 | .24 | .19 | CD9-2A | CD-800-2 | 3000 |
| PN14-6F-3K | | | | | #6 | .78 | .28 | .19 | | | 3000 |
| PN14-8F-3K | | | | | #8 | .84 | .31 | .23 | | | 3000 |
| PN14-10FN-3K | | | | | #10 | .86 | .31 | .24 | | | 3000 |
| PN14-10F-3K | | | | | #10 | .86 | .34 | .24 | | | 3000 |
| PN14-14F-3K | | | | | 1/4" | 1.03 | .44 | .32 | | | 3000 |
| PN10-6F-2K | 12 – 10 AWG | Yellow | .04 | .225 | #6 | 1.00 | .31 | .24 | CD9-3B | CD-800-3 | 2000 |
| PN10-8F-2K | | | | | #8 | 1.03 | .37 | .24 | | | 2000 |
| PN10-10F-2K | | | | | #10 | 1.04 | .37 | .24 | | | 2000 |
| PN10-14F-2K | | | | | 1/4" | 1.14 | .49 | .32 | | | 2000 |

For applicator information, see page D1.143.

A. System Overview

B1. Cable Ties

B2. Cable Accessories

B3. Stainless Steel Ties

C1. Wiring Duct

C2. Surface Raceway

C3. Abrasion Protection

C4. Cable Management

D1. Terminals

D2. Power Connectors

D3. Grounding Connectors

E1. Labeling Systems

E2. Labels

E3. Pre-Printed & Write-On Markers

E4. Permanent Identification

E5. Lockout/Tagout & Safety Solutions

F. Index

A.
System
Overview



Fork Terminals, Nylon Insulated – Funnel Entry

B1.
Cable Ties

Type PNF-F

- Continuously molded design provides reliable, consistent performance through the applicator for a high quality termination every time
- Fork design provides for fast and easy installation, without the need to remove fastener
- Metal insulation grip sleeve crimps to wire insulation, providing protection to the crimp joint during high vibration applications

- Internal barrel serrations assure good wire contact and maximum tensile strength
- UL Flammability UL 94V-2/HB, maximum insulation temperature 221°F (105°C)
- UL and CSA rated up to 600 V per UL 486

B2.
Cable
Accessories

B3.
Stainless
Steel Ties

C1.
Wiring
Duct

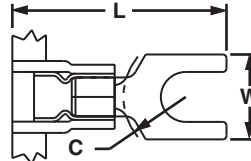

C2.
Surface
Raceway

C3.
Abrasion
Protection

C4.
Cable
Management

D1.
Terminals

D2.
Power
Connectors

D3.
Grounding
Connectors

| Part Number | Wire Range | Color Code | Stock Thickness | Max. Ins. | Stud Size | Figure Dimensions (In.) | | | CA9 Series Crimp Die | CA-800 Series Crimp Die | Pieces Per Reel |
|--------------------|-------------|------------|-----------------|-----------|-----------|-------------------------|-----|-----|----------------------|-------------------------|-----------------|
| | | | | | | L | W | C | | | |
| PNF18-6F-3K | 22 – 18 AWG | Red | .03 | .145 | #6 | .77 | .24 | .19 | CD9-1A | CD-800-1 | 3000 |
| PNF18-6FN-3K | | | | | #6 | .78 | .30 | .19 | | | 3000 |
| PNF18-8F-3K | | | | | #8 | .83 | .32 | .22 | | | 3000 |
| PNF18-10F-3K | | | | | #10 | .85 | .35 | .24 | | | 3000 |
| PNF18-14F-3K | | | | | 1/4" | 1.02 | .44 | .33 | | | 3000 |
| PNF14-6FN-3K* | 16 – 14 AWG | Blue | .03 | .162 | #6 | .78 | .24 | .19 | CD9-2A | CD-800-2 | 3000 |
| PNF14-6F-3K | | | | | #6 | .78 | .28 | .19 | | | 3000 |
| PNF14-8F-3K | | | | | #8 | .84 | .31 | .23 | | | 3000 |
| PNF14-10F-3K | | | | | #10 | .86 | .34 | .24 | | | 3000 |
| PNF14-14F-3K | | | | | 1/4" | 1.03 | .44 | .32 | | | 3000 |
| PNF10-6F-2K | 12 – 10 AWG | Yellow | .04 | .225 | #6 | 1.01 | .31 | .24 | CD9-3B | CD-800-3 | 2000 |
| PNF10-8F-2K | | | | | #8 | 1.02 | .37 | .24 | | | 2000 |
| PNF10-10F-2K | | | | | #10 | 1.02 | .37 | .22 | | | 2000 |
| PNF10-14F-2K | | | | | 1/4" | 1.13 | .49 | .32 | | | 2000 |

*Not UL Listed or CSA Certified.
For applicator information, see page D1.143.

E1.
Labeling
Systems

E2.
Labels

E3.
Pre-Printed
& Write-On
Markers

E4.
Permanent
Identification

E5.
Lockout/
Tagout/
& Safety
Solutions

F.
Index



Fork Terminals, Vinyl Insulated – Funnel Entry

Type PV-FB

- Continuously molded design provides reliable, consistent performance through the applicator for a high quality termination every time
- Fork design provides for fast and easy installation, without the need to remove fastener
- Insulation support helps to prevent wire damage in bending applications
- Maximum insulation temperature 221°F (105°C)
- UL and CSA rated up to 600 V per UL 486

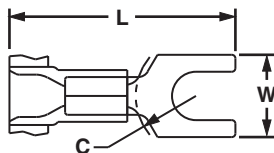

| Part Number | Wire Range | Color Code | Stock Thickness | Max. Ins. | Stud Size | Figure Dimensions (In.) | | | CA9 Series Crimp Die | CA-800 Series Crimp Die | Pieces Per Reel |
|-----------------------|-------------|------------|-----------------|-----------|-----------|-------------------------|-----|-----|----------------------|-------------------------|-----------------|
| | | | | | | L | W | C | | | |
| PV18-6FB-3K | 22 – 18 AWG | Red | .03 | .150 | #6 | .78 | .25 | .20 | CD9-1A | CD-800-1 | 3000 |
| PV18-6FNB-3K | | | | | #6 | .78 | .30 | .20 | | | 3000 |
| PV18-8FB-3K | | | | | #8 | .84 | .32 | .23 | | | 3000 |
| PV18-10FB-3K | | | | | #10 | .86 | .35 | .25 | | | 3000 |
| PV18-14FB-3K | | | | | 1/4" | 1.03 | .44 | .33 | | | 3000 |
| PV14-6FB-3K | 16 – 14 AWG | Blue | .03 | .170 | #6 | .78 | .24 | .19 | CD9-2A | CD-800-2 | 3000 |
| PV14-6FNB-3K* | | | | | #6 | .78 | .28 | .19 | | | 3000 |
| PV14-8FB-3K | | | | | #8 | .84 | .31 | .23 | | | 3000 |
| PV14-10FB-3K | | | | | #10 | .86 | .31 | .24 | | | 3000 |
| PV14-10FNB-3K* | | | | | #10 | .86 | .34 | .24 | | | 3000 |
| PV14-14FB-3K | 1/4" | 1.03 | .44 | .32 | 3000 | | | | | | |
| PV10-6FB-2K | 12 – 10 AWG | Yellow | .04 | .225 | #6 | .99 | .31 | .22 | CD9-3B | CD-800-3 | 2000 |
| PV10-8FB-2K | | | | | #8 | 1.00 | .38 | .22 | | | 2000 |
| PV10-10FB-2K | | | | | #10 | 1.04 | .38 | .22 | | | 2000 |
| PV10-14FB-2K | | | | | 1/4" | 1.13 | .49 | .32 | | | 2000 |

*CSA Certified only.

For applicator information, see page D1.143.

A. System Overview

B1. Cable Ties

B2. Cable Accessories

B3. Stainless Steel Ties

C1. Wiring Duct

C2. Surface Raceway

C3. Abrasion Protection

C4. Cable Management

D1. Terminals

D2. Power Connectors

D3. Grounding Connectors

E1. Labeling Systems

E2. Labels

E3. Pre-Printed & Write-On Markers

E4. Permanent Identification

E5. Lockout/Tagout & Safety Solutions

F. Index

A. System Overview



Locking Fork Terminals, Nylon Insulated – Non-Funnel Entry

Type PN-LF

- Continuously molded design provides reliable, consistent performance through the applicator for a high quality termination every time
- Lock in place for secure connection
- Fork design provides for fast and easy installation, without the need to remove fastener
- Metal insulation grip sleeve crimps to wire insulation, providing protection to the crimp joint during high vibration applications

- Internal barrel serrations assure good wire contact and maximum tensile strength
- UL Flammability UL 94V-2/HB, maximum insulation temperature 221°F (105°C)
- UL and CSA rated up to 600 V per UL 486

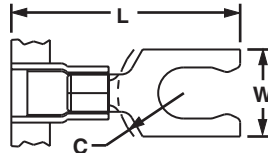

B1. Cable Ties

B2. Cable Accessories

B3. Stainless Steel Ties

C1. Wiring Duct

C2. Surface Raceway

C3. Abrasion Protection

C4. Cable Management

| Part Number | Wire Range | Color Code | Stock Thickness | Max. Ins. | Stud Size | Figure Dimensions (In.) | | | CA9 Series Crimp Die | CA-800 Series Crimp Die | Pieces Per Reel |
|--------------|-------------|------------|-----------------|-----------|-----------|-------------------------|-----|-----|----------------------|-------------------------|-----------------|
| | | | | | | L | W | C | | | |
| PN18-6LF-3K | 22 – 18 AWG | Red | .03 | .145 | #6 | .82 | .24 | .19 | CD9-1A | CD-800-1 | 3000 |
| PN18-8LF-3K | | | | | #8 | .89 | .29 | .23 | | | 3000 |
| PN18-10LF-3K | | | | | #10 | .89 | .33 | .23 | | | 3000 |
| PN14-6LF-3K | 16 – 14 AWG | Blue | .03 | .162 | #6 | .85 | .25 | .18 | CD9-2A | CD-800-2 | 3000 |
| PN14-8LF-3K | | | | | #8 | .92 | .29 | .23 | | | 3000 |
| PN14-10LF-3K | | | | | #10 | .92 | .33 | .23 | | | 3000 |
| PN10-6LF-2K | 12 – 10 AWG | Yellow | .04 | .225 | #6 | 1.02 | .30 | .21 | CD9-3B | CD-800-3 | 2000 |
| PN10-8LF-2K | | | | | #8 | 1.05 | .30 | .21 | | | 2000 |
| PN10-10LF-2K | | | | | #10 | 1.05 | .34 | .21 | | | 2000 |

For applicator information, see page D1.143.

D1. Terminals



Locking Fork Terminals, Nylon Insulated – Funnel Entry

Type PNF-LF

- Continuously molded design provides reliable, consistent performance through the applicator for a high quality termination every time
- Lock in place for secure connection
- Fork design provides for fast and easy installation, without the need to remove fastener
- Metal insulation grip sleeve crimps to wire insulation, providing protection to the crimp joint during high vibration applications

- Internal barrel serrations assure good wire contact and maximum tensile strength
- UL Flammability UL 94V-2/HB, maximum insulation temperature 221°F (105°C)
- UL and CSA rated up to 600 V per UL 486

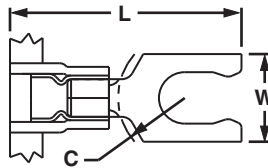

E1. Labeling Systems

E2. Labels

E3. Pre-Printed & Write-On Markers

E4. Permanent Identification

E5. Lockout/Tagout & Safety Solutions

F. Index

| Part Number | Wire Range | Color Code | Stock Thickness | Max. Ins. | Stud Size | Figure Dimensions (In.) | | | CA9 Series Crimp Die | CA-800 Series Crimp Die | Pieces Per Reel |
|----------------|-------------|------------|-----------------|-----------|-----------|-------------------------|-----|-----|----------------------|-------------------------|-----------------|
| | | | | | | L | W | C | | | |
| PNF18-6LF-3K | 22 – 18 AWG | Red | .03 | .145 | #6 | .85 | .27 | .19 | CD9-1A | CD-800-1 | 3000 |
| PNF18-6LFW-3K | | | | | #6 | .85 | .29 | .19 | | | 3000 |
| PNF18-8LF-3K | | | | | #8 | .89 | .29 | .23 | | | 3000 |
| PNF18-10LF-3K | 16 – 14 AWG | Blue | .03 | .162 | #10 | .89 | .33 | .23 | CD9-2A | CD-800-2 | 3000 |
| PNF14-6LF-3K | | | | | #6 | .85 | .25 | .18 | | | 3000 |
| PNF14-8LF-3K | | | | | #8 | .92 | .29 | .23 | | | 3000 |
| PNF14-10LFN-3K | 16 – 14 AWG | Blue | .03 | .162 | #10 | .92 | .28 | .23 | CD9-2A | CD-800-2 | 3000 |
| PNF14-10LF-3K | | | | | #10 | .92 | .33 | .23 | | | 3000 |
| PNF10-6LF-2K | 12 – 10 AWG | Yellow | .04 | .225 | #6 | 1.02 | .30 | .21 | CD9-3B | CD-800-3 | 2000 |
| PNF10-8LF-2K | | | | | #8 | 1.05 | .30 | .21 | | | 2000 |
| PNF10-10LF-2K | | | | | #10 | 1.05 | .34 | .21 | | | 2000 |
| PNF10-14LF-2K | 12 – 10 AWG | Yellow | .04 | .225 | 1/4" | 1.19 | .46 | .32 | CD9-3B | CD-800-3 | 2000 |

For applicator information, see page D1.143.



Locking Fork Terminals, Vinyl Insulated – Funnel Entry

Type PV-LFB

- Continuously molded design provides reliable, consistent performance through the applicator for a high quality termination every time
- Lock in place for secure connection
- Fork design provides for fast and easy installation, without the need to remove fastener
- Insulation support helps to prevent wire damage in bending applications
- Maximum insulation temperature 221°F (105°C)
- UL and CSA rated to 600 V per UL 486

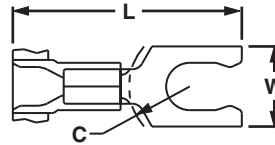

| Part Number | Wire Range | Color Code | Stock Thickness | Max. Ins. | Stud Size | Figure Dimensions (In.) | | | CA9 Series Crimp Die | CA-800 Series Crimp Die | Pieces Per Reel |
|------------------------|-------------|------------|-----------------|-----------|-----------|-------------------------|-----|-----|----------------------|-------------------------|-----------------|
| | | | | | | L | W | C | | | |
| PV18-6LFB-3K | 22 – 18 AWG | Red | .03 | .150 | #6 | .80 | .27 | .19 | CD9-1A | CD-800-1 | 3000 |
| PV18-6LFWB-3K | | | | | #6 | .83 | .29 | .19 | | | 3000 |
| PV18-8LFB-3K | | | | | #8 | .87 | .29 | .23 | | | 3000 |
| PV18-10LFNB-3K* | | | | | #10 | .87 | .29 | .23 | | | 3000 |
| PV18-10LFB-3K | | | | | #10 | .87 | .33 | .23 | | | 3000 |
| PV14-6LFB-3K | 16 – 14 AWG | Blue | .03 | .170 | #6 | .85 | .25 | .18 | CD9-2A | CD-800-2 | 3000 |
| PV14-6LFWB-3K | | | | | #6 | .85 | .29 | .18 | | | 3000 |
| PV14-8LFB-3K | | | | | #8 | .92 | .29 | .23 | | | 3000 |
| PV14-10LFB-3K | | | | | #10 | .92 | .33 | .23 | | | 3000 |
| PV10-6LFB-2K | 12 – 10 AWG | Yellow | .04 | .225 | #6 | 1.02 | .30 | .21 | CD9-3B | CD-800-3 | 2000 |
| PV10-8LFB-2K | | | | | #8 | 1.04 | .30 | .21 | | | 2000 |
| PV10-10LFB-2K | | | | | #10 | 1.04 | .34 | .21 | | | 2000 |
| PV10-14LFB-2K | | | | | 1/4" | 1.16 | .46 | .32 | | | 2000 |

*Not UL Listed or CSA Certified.
For applicator information, see page D1.143.

A. System Overview

B1. Cable Ties

B2. Cable Accessories

B3. Stainless Steel Ties

C1. Wiring Duct

C2. Surface Raceway

C3. Abrasion Protection

C4. Cable Management

D1. Terminals

D2. Power Connectors

D3. Grounding Connectors

E1. Labeling Systems

E2. Labels

E3. Pre-Printed & Write-On Markers

E4. Permanent Identification

E5. Lockout/Tagout & Safety Solutions

F. Index

A. System Overview



Short Locking Fork Terminals, Nylon Insulated – Non-Funnel Entry

Type PN-SLF

- Continuously molded design provides reliable, consistent performance through the applicator for a high quality termination every time
- Lock in place for a secure connection in limited spaces
- Fork design provides for fast and easy installation, without the need to remove fastener
- Metal insulation grip sleeve crimps to wire insulation, providing protection to the crimp joint during high vibration applications

- Internal barrel serrations assure good wire contact and maximum tensile strength
- UL Flammability UL 94V-2/HB, maximum insulation temperature 221°F (105°C)
- UL and CSA rated up to 600 V per UL 486

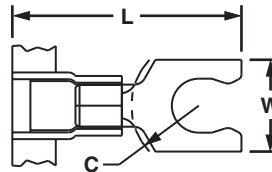

B1. Cable Ties

B2. Cable Accessories

B3. Stainless Steel Ties

C1. Wiring Duct

C2. Surface Raceway

C3. Abrasion Protection

C4. Cable Management

| Part Number | Wire Range | Color Code | Stock Thickness | Max. Ins. | Stud Size | Figure Dimensions (In.) | | | CA9 Series Crimp Die | CA-800 Series Crimp Die | Pieces Per Reel |
|---------------|-------------|------------|-----------------|-----------|-----------|-------------------------|-----|-----|----------------------|-------------------------|-----------------|
| | | | | | | L | W | C | | | |
| PN18-5SLF-3K | 22 – 18 AWG | Red | .03 | .145 | #5 | .75 | .26 | .19 | CD9-1A | CD-800-1 | 3000 |
| PN18-6SLF-3K | | | | | #6 | .75 | .27 | .19 | | | 3000 |
| PN18-8SLF-3K | | | | | #8 | .79 | .29 | .23 | | | 3000 |
| PN18-10SLF-3K | | | | | #10 | .80 | .33 | .23 | | | 3000 |
| PN14-5SLF-3K | 16 – 14 AWG | Blue | .03 | .162 | #5 | .75 | .25 | .19 | CD9-2A | CD-800-2 | 3000 |
| PN14-6SLF-3K | | | | | #6 | .75 | .25 | .19 | | | 3000 |
| PN14-8SLF-3K | | | | | #8 | .80 | .29 | .23 | | | 3000 |
| PN14-10SLF-3K | | | | | #10 | .81 | .33 | .23 | | | 3000 |
| PN10-8SLF-2K | 12 – 10 AWG | Yellow | .04 | .225 | #8 | .92 | .29 | .22 | CD9-3B | CD-800-3 | 2000 |
| PN10-10SLF-2K | | | | | #10 | .92 | .33 | .22 | | | 2000 |

For applicator information, see page D1.143.

D1. Terminals



Short Locking Fork Terminals, Nylon Insulated – Funnel Entry

Type PNF-SLF

- Continuously molded design provides reliable, consistent performance through the applicator for a high quality termination every time
- Lock in place for a secure connection in limited spaces
- Fork design provides for fast and easy installation, without the need to remove fastener
- Metal insulation grip sleeve crimps to wire insulation, providing protection to the crimp joint during high vibration applications

- Internal barrel serrations assure good wire contact and maximum tensile strength
- UL Flammability UL 94V-2/HB, maximum insulation temperature 221°F (105°C)
- UL and CSA rated up to 600 V per UL 486

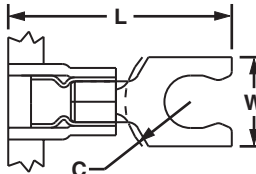

D2. Power Connectors

D3. Grounding Connectors

E1. Labeling Systems

E2. Labels

E3. Pre-Printed & Write-On Markers

E4. Permanent Identification

E5. Lockout/Tagout & Safety Solutions

F. Index

| Part Number | Wire Range | Color Code | Stock Thickness | Max. Ins. | Stud Size | Figure Dimensions (In.) | | | CA9 Series Crimp Die | CA-800 Series Crimp Die | Pieces Per Reel |
|----------------------|-------------|------------|-----------------|-----------|-----------|-------------------------|-----|-----|----------------------|-------------------------|-----------------|
| | | | | | | L | W | C | | | |
| PNF18-5SLF-3K | 22 – 18 AWG | Red | .03 | .145 | #5 | .73 | .26 | .19 | CD9-1A | CD-800-1 | 3000 |
| PNF18-6SLF-3K | | | | | #6 | .74 | .27 | .19 | | | 3000 |
| PNF18-8SLF-3K | | | | | #8 | .80 | .29 | .23 | | | 3000 |
| PNF18-10SLF-3K | | | | | #10 | .80 | .33 | .23 | | | 3000 |
| PNF14-6SLF-3K | 16 – 14 AWG | Blue | .03 | .162 | #6 | .75 | .25 | .19 | CD9-2A | CD-800-2 | 3000 |
| PNF14-10SLF-3K | | | | | #10 | .81 | .33 | .23 | | | 3000 |
| PNF10-6SLF-2K | 12 – 10 AWG | Yellow | .04 | .225 | #6 | .91 | .25 | .17 | CD9-3B | CD-800-3 | 2000 |
| PNF10-8SLF-2K | | | | | #8 | .92 | .29 | .22 | | | 2000 |
| PNF10-10SLF-2K | | | | | #10 | .93 | .33 | .22 | | | 2000 |

For applicator information, see page D1.143.



Short Locking Fork Terminals, Vinyl Insulated – Funnel Entry

Type PV-SLFB

- Continuously molded design provides reliable, consistent performance through the applicator for a high quality termination every time
- Lock in place for a secure connection in limited spaces
- Fork design provides for fast and easy installation, without the need to remove fastener

- Insulation support helps to prevent wire damage in bending applications
- Maximum insulation temperature 221°F (105°C)
- UL and CSA rated up to 600 V per UL 486

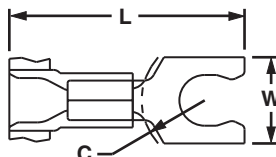

| Part Number | Wire Range | Color Code | Stock Thickness | Max. Ins. | Stud Size | Figure Dimensions (In.) | | | CA9 Series Crimp Die | CA-800 Series Crimp Die | Pieces Per Reel |
|----------------|-------------|------------|-----------------|-----------|-----------|-------------------------|-----|-----|----------------------|-------------------------|-----------------|
| | | | | | | L | W | C | | | |
| PV18-5SLFB-3K | 22 – 18 AWG | Red | .03 | .150 | #5 | .72 | .26 | .19 | CD9-1A | CD-800-1 | 3000 |
| PV18-6SLFB-3K | | | | | #6 | .72 | .27 | .19 | | | 3000 |
| PV18-8SLFB-3K | | | | | #8 | .77 | .29 | .23 | | | 3000 |
| PV18-10SLFB-3K | | | | | #10 | .78 | .33 | .23 | | | 3000 |
| PV14-6SLFB-3K | 16 – 14 AWG | Blue | .03 | .170 | #6 | .75 | .25 | .19 | CD9-2A | CD-800-2 | 3000 |
| PV14-8SLFB-3K | | | | | #8 | .80 | .29 | .23 | | | 3000 |
| PV14-10SLFB-3K | | | | | #10 | .81 | .33 | .23 | | | 3000 |
| PV14-14SLFB-3K | | | | | 1/4" | .90 | .44 | .29 | | | 3000 |
| PV10-6SLFB-2K | 12 – 10 AWG | Yellow | .04 | .225 | #6 | .84 | .25 | .17 | CD9-3B | CD-800-3 | 2000 |
| PV10-8SLFB-2K | | | | | #8 | .90 | .29 | .22 | | | 2000 |
| PV10-10SLFB-2K | | | | | #10 | .91 | .33 | .22 | | | 2000 |

For applicator information, see page D1.143.



Flanged Fork Terminals, Nylon Insulated – Non-Funnel Entry

Type PN-FF

- Continuously molded design provides reliable, consistent performance through the applicator for a high quality termination every time
- Flange design provides extra secure connection on a variety of applications
- Metal insulation grip sleeve crimps to wire insulation, providing protection to the crimp joint during high vibration applications

- Internal barrel serrations assure good wire contact and maximum tensile strength
- UL Flammability UL 94V-2/HB, maximum insulation temperature 221°F (105°C)
- UL and CSA rated up to 600 V per UL 486

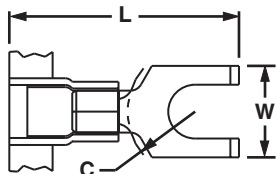

| Part Number | Wire Range | Color Code | Stock Thickness | Max. Ins. | Stud Size | Figure Dimensions (In.) | | | CA9 Series Crimp Die | CA-800 Series Crimp Die | Pieces Per Reel |
|--------------|-------------|------------|-----------------|-----------|-----------|-------------------------|-----|-----|----------------------|-------------------------|-----------------|
| | | | | | | L | W | C | | | |
| PN18-6FF-3K | 22 – 18 AWG | Red | .03 | .136 | #6 | .80 | .28 | .19 | CD9-1A | CD-800-1 | 3000 |
| PN18-8FF-3K | | | | | #8 | .87 | .31 | .23 | | | 3000 |
| PN18-10FF-3K | | | | | #10 | .87 | .35 | .23 | | | 3000 |
| PN14-6FF-3K | 16 – 14 AWG | Blue | .03 | .162 | #6 | .80 | .28 | .19 | CD9-2A | CD-800-2 | 3000 |
| PN14-8FF-3K | | | | | #8 | .87 | .31 | .23 | | | 3000 |
| PN14-10FF-3K | | | | | #10 | .87 | .35 | .23 | | | 3000 |
| PN10-8FF-2K | 12 – 10 AWG | Yellow | .04 | .225 | #8 | 1.05 | .38 | .22 | CD9-3B | CD-800-3 | 2000 |
| PN10-10FF-2K | | | | | #10 | 1.05 | .38 | .22 | | | 2000 |

For applicator information, see page D1.143.

A. System Overview

B1. Cable Ties

B2. Cable Accessories

B3. Stainless Steel Ties

C1. Wiring Duct

C2. Surface Raceway

C3. Abrasion Protection

C4. Cable Management

D1. Terminals

D2. Power Connectors

D3. Grounding Connectors

E1. Labeling Systems

E2. Labels

E3. Pre-Printed & Write-On Markers

E4. Permanent Identification

E5. Lockout/Tagout & Safety Solutions

F. Index

A. System Overview

UL **SR** LISTED CERTIFIED **Flanged Fork Terminals, Nylon Insulated – Funnel Entry**

Type PNF-FF

- Continuously molded design provides reliable, consistent performance through the applicator for a high quality termination every time
- Flange design provides extra secure connection on a variety of applications
- Metal insulation grip sleeve crimps to wire insulation, providing protection to the crimp joint during high vibration applications

- Internal barrel serrations assure good wire contact and maximum tensile strength
- UL Flammability UL 94V-2/HB, maximum insulation temperature 221°F (105°C)
- UL and CSA rated up to 600 V per UL 486

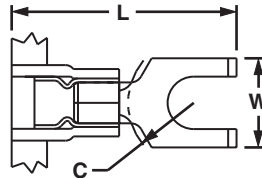

| Part Number | Wire Range | Color Code | Stock Thickness | Max. Ins. | Stud Size | Figure Dimensions (In.) | | | CA9 Series Crimp Die | CA-800 Series Crimp Die | Pieces Per Reel |
|---------------------|-------------|------------|-----------------|-----------|-----------|-------------------------|-----|-----|----------------------|-------------------------|-----------------|
| | | | | | | L | W | C | | | |
| PNF18-6FF-3K | 22 – 18 AWG | Red | .03 | .145 | #6 | .80 | .28 | .19 | CD9-1A | CD-800-1 | 3000 |
| PNF18-8FF-3K | | | | | #8 | .87 | .31 | .23 | | | 3000 |
| PNF18-10FF-3K | | | | | #10 | .86 | .35 | .23 | | | 3000 |
| PNF14-6FF-3K | 16 – 14 AWG | Blue | .03 | .162 | #6 | .80 | .28 | .19 | CD9-2A | CD-800-2 | 3000 |
| PNF14-8FF-3K | | | | | #8 | .87 | .31 | .23 | | | 3000 |
| PNF14-10FF-3K | | | | | #10 | .87 | .35 | .23 | | | 3000 |
| PNF10-8FF-2K | 12 – 10 AWG | Yellow | .04 | .225 | #8 | 1.05 | .38 | .24 | CD9-3B | CD-800-3 | 2000 |
| PNF10-10FF-2K | | | | | #10 | 1.05 | .38 | .24 | | | 2000 |

For applicator information, see page D1.143.

D1. Terminals

UL **SR** LISTED CERTIFIED **Flanged Fork Terminals, Vinyl Insulated – Funnel Entry**

Type PV-FFB

- Continuously molded design provides reliable, consistent performance through the applicator for a high quality termination every time
- Flange design provides extra secure connection on a variety of applications

- Insulation support helps to prevent wire damage in bending applications
- Maximum insulation temperature 221°F (105°C)
- UL and CSA rated up to 600 V per UL 486

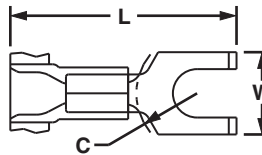

| Part Number | Wire Range | Color Code | Stock Thickness | Max. Ins. | Stud Size | Figure Dimensions (In.) | | | CA9 Series Crimp Die | CA-800 Series Crimp Die | Pieces Per Reel |
|----------------------|-------------|------------|-----------------|-----------|-----------|-------------------------|-----|-----|----------------------|-------------------------|-----------------|
| | | | | | | L | W | C | | | |
| PV18-6FFB-3K | 22 – 18 AWG | Red | .03 | .150 | #6 | .80 | .28 | .19 | CD9-1A | CD-800-1 | 3000 |
| PV18-8FFB-3K | | | | | #8 | .87 | .31 | .23 | | | 3000 |
| PV18-10FFB-3K | | | | | #10 | .86 | .35 | .23 | | | 3000 |
| PV14-6FFB-3K | 16 – 14 AWG | Blue | .03 | .170 | #6 | .80 | .28 | .19 | CD9-2A | CD-800-2 | 3000 |
| PV14-8FFB-3K | | | | | #8 | .86 | .31 | .23 | | | 3000 |
| PV14-10FFB-3K | | | | | #10 | .86 | .35 | .23 | | | 3000 |
| PV10-8FFB-2K | 12 – 10 AWG | Yellow | .04 | .225 | #8 | 1.03 | .37 | .22 | CD9-3B | CD-800-3 | 2000 |
| PV10-10FFB-2K | | | | | #10 | 1.03 | .37 | .22 | | | 2000 |

For applicator information, see page D1.143.

Features and Benefits – REEL SMART™ Metric Terminals

Metric Nylon Insulated Funnel Terminals with Insulation Grip Sleeve Type PMN or PMNF

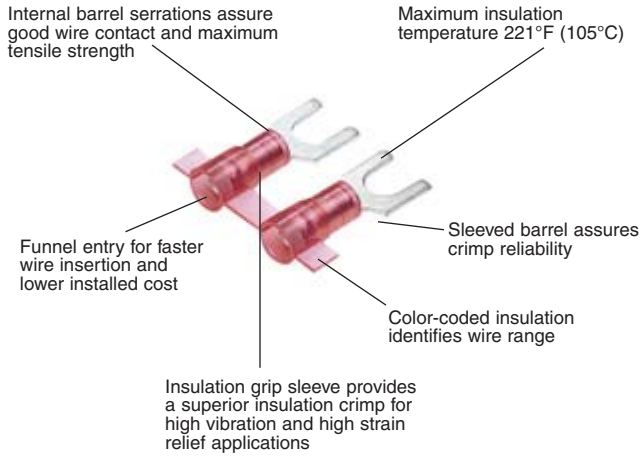

Flammability UL 94V-2/HB

Metric Nylon Insulated Funnel Terminals with Insulation Support Type PMV

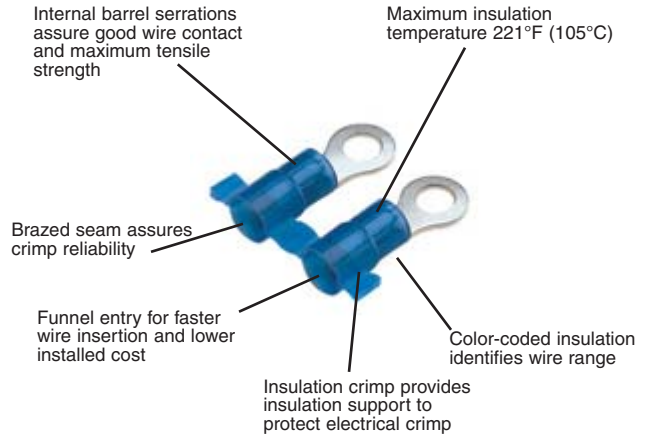

Flammability UL 94V-0

Part Number System for REEL SMART™ Metric Terminals

| PM | V | 1 | — | 3 | R | B | 3K |
|-----------------------|---|--|---|----------------------|---|------------------------------------|----|
| Type | Insulation | Wire Range | Stud Size | Tongue Configuration | Special Configuration | Std. Pkg. Size | |
| PM = PAN-TERM® Metric | N = Nylon NF = Nylon Funnel Entry V = Vinyl | 1 = .5 – 1.0mm ² or .5 – 1.5mm ² 2 = 1.5 – 2.5mm ² 6 = 2.5 – 6.0mm ² or 4.0 – 6.0mm ² | 3 = M3 (#5) 35 = M3.5 (#6) 4 = M4 (#8) 5 = M5 (#10) 6 = M6 (1/4") 8 = M8 (5/16") | R = Ring F = Fork | B = Butted Seam = Standard (leave blank) | 2K = 2,000 pcs. 3K = 3,000 pcs. | |

A. System Overview

B1. Cable Ties

B2. Cable Accessories

B3. Stainless Steel Ties

C1. Wiring Duct

C2. Surface Raceway

C3. Abrasion Protection

C4. Cable Management

D1. Terminals

D2. Power Connectors

D3. Grounding Connectors

E1. Labeling Systems

E2. Labels

E3. Pre-Printed & Write-On Markers

E4. Permanent Identification

E5. Lockout/Tagout & Safety Solutions

F. Index



Metric Ring Terminals, Nylon Insulated – Non-Funnel Entry

Type PMN-R

- Continuously molded design provides reliable, consistent performance through the applicator for a high quality termination every time
- Ring tongue design assures a secure connection in high vibration applications

- Metal insulation grip sleeve crimps to wire insulation, providing protection to the crimp joint during high vibration applications
- Internal barrel serrations assure good wire contact and maximum tensile strength

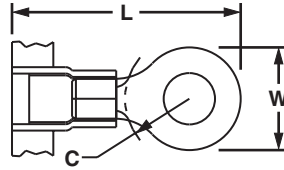

| Part Number | Wire Range (mm ²) | Color Code | Max. Ins. | Stud Size (mm) | Figure Dimensions (mm) | | | CA9 Series Crimp Die | CA-800 Series Crimp Die | Pieces Per Reel |
|-------------|-------------------------------|------------|-----------|----------------|------------------------|------|-----|----------------------|-------------------------|-----------------|
| | | | | | L | W | C | | | |
| PMN1-3R-3K | .5 – 1.5 | Red | 3.7 | M3 | 19.3 | 5.8 | 5.2 | CD9-1A | CD-800-1 | 3000 |
| PMN1-35R-3K | | | | M3.5 | 19.3 | 5.8 | 5.2 | | | 3000 |
| PMN1-4R-3K | | | | M4 | 21.9 | 7.9 | 6.4 | | | 3000 |
| PMN1-5R-3K | | | | M5 | 22.4 | 8.9 | 6.4 | | | 3000 |
| PMN1-6R-3K | | | | M6 | 26.7 | 10.9 | 9.7 | | | 3000 |
| PMN2-3R-3K | 1.5 – 2.5 | Blue | 4.1 | M3 | 21.6 | 5.8 | 5.1 | CD9-2A | CD-800-2 | 3000 |
| PMN2-35R-3K | | | | M3.5 | 21.6 | 5.8 | 5.1 | | | 3000 |
| PMN2-4R-3K | | | | M4 | 24.1 | 7.9 | 6.5 | | | 3000 |
| PMN2-5R-3K | | | | M5 | 24.6 | 8.9 | 6.5 | | | 3000 |
| PMN2-6R-3K | | | | M6 | 26.7 | 10.9 | 9.7 | | | 3000 |
| PMN6-3R-2K | 2.5 – 6.0 | Yellow | 5.7 | M3 | 24.7 | 5.8 | 7.9 | CD9-3B | CD-800-3 | 2000 |
| PMN6-35R-2K | | | | M3.5 | 24.7 | 5.8 | 7.9 | | | 2000 |
| PMN6-4R-2K | | | | M4 | 25.7 | 7.9 | 7.9 | | | 2000 |
| PMN6-5R-2K | | | | M5 | 26.4 | 9.7 | 7.9 | | | 2000 |
| PMN6-6R-2K | | | | M6 | 29.0 | 10.9 | 9.7 | | | 2000 |
| PMN6-8R-2K | | | | M8 | 30.0 | 13.2 | 9.7 | | | 2000 |

For applicator information, see page D1.143.



Metric Ring Terminals, Nylon Insulated – Funnel Entry



Type PMNF-R

- Continuously molded design provides reliable, consistent performance through the applicator for a high quality termination every time
- Ring tongue design assures a secure connection in high vibration applications
- Metal insulation grip sleeve crimps to wire insulation, providing protection to the crimp joint during high vibration applications
- Internal barrel serrations assure good wire contact and maximum tensile strength

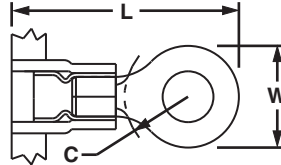

| Part Number | Wire Range (mm ²) | Color Code | Max. Ins. | Stud Size (mm) | Figure Dimensions (mm) | | | CA9 Series Crimp Die | CA-800 Series Crimp Die | Pieces Per Reel |
|--------------|-------------------------------|------------|-----------|----------------|------------------------|------|-----|----------------------|-------------------------|-----------------|
| | | | | | L | W | C | | | |
| PMNF1-3R-3K | .5 – 1.5 | Red | 3.7 | M3 | 19.3 | 5.8 | 5.2 | CD9-1A | CD-800-1 | 3000 |
| PMNF1-35R-3K | | | | M3.5 | 19.3 | 5.8 | 5.2 | | | 3000 |
| PMNF1-4R-3K | | | | M4 | 21.9 | 7.9 | 6.4 | | | 3000 |
| PMNF1-5R-3K | | | | M5 | 22.4 | 8.9 | 6.4 | | | 3000 |
| PMNF1-6R-3K | | | | M6 | 26.7 | 10.9 | 9.7 | | | 3000 |
| PMNF2-3R-3K | | | | 1.5 – 2.5 | Blue | 4.1 | M3 | | | 19.4 |
| PMNF2-35R-3K | M3.5 | 19.4 | 5.8 | | | | 5.1 | 3000 | | |
| PMNF2-4R-3K | M4 | 21.8 | 7.9 | | | | 6.5 | 3000 | | |
| PMNF2-5R-3K | M5 | 22.4 | 8.9 | | | | 6.5 | 3000 | | |
| PMNF2-6R-3K | M6 | 26.5 | 10.9 | | | | 9.7 | 3000 | | |
| PMNF6-3R-2K | 2.5 – 6.0 | Yellow | 5.7 | | | | M3 | 24.7 | 5.8 | 7.9 |
| PMNF6-35R-2K | | | | M3.5 | 24.7 | 5.8 | 7.9 | 2000 | | |
| PMNF6-4R-2K | | | | M4 | 25.7 | 7.9 | 7.9 | 2000 | | |
| PMNF6-5R-2K | | | | M5 | 26.4 | 9.7 | 7.9 | 2000 | | |
| PMNF6-6R-2K | | | | M6 | 29.0 | 10.9 | 9.7 | 2000 | | |
| PMNF6-8R-2K | | | | M8 | 30.0 | 13.2 | 9.7 | 2000 | | |

For applicator information, see page D1.143.

A. System Overview

B1. Cable Ties

B2. Cable Accessories

B3. Stainless Steel Ties

C1. Wiring Duct

C2. Surface Raceway

C3. Abrasion Protection

C4. Cable Management

D1. Terminals

D2. Power Connectors

D3. Grounding Connectors

E1. Labeling Systems

E2. Labels

E3. Pre-Printed & Write-On Markers

E4. Permanent Identification

E5. Lockout/Tagout & Safety Solutions

F. Index

A.
System
Overview



Metric Ring Terminals, Vinyl Insulated – Funnel Entry

B1.
Cable Ties

Type PMV-RB

- Continuously molded design provides reliable, consistent performance through the applicator for a high quality termination every time
- Insulation support helps to prevent wire damage in bending applications
- Ring tongue design assures a secure connection in high vibration applications
- Maximum insulation temperature 221°F (105°C)

B2.
Cable
Accessories

B3.
Stainless
Steel Ties



C1.
Wiring
Duct

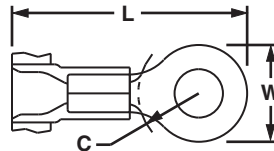

C2.
Surface
Raceway

C3.
Abrasion
Protection

C4.
Cable
Management

D1.
Terminals

D2.
Power
Connectors

D3.
Grounding
Connectors

| Part Number | Wire Range (mm ²) | Color Code | Max. Ins. | Stud Size (mm) | Figure Dimensions (mm) | | | CA9 Series Crimp Die | CA-800 Series Crimp Die | Pieces Per Reel |
|--------------|-------------------------------|------------|-----------|----------------|------------------------|------|-----|----------------------|-------------------------|-----------------|
| | | | | | L | W | C | | | |
| PMV1-3RB-3K | .5 – 1.5 | Red | 3.7 | M3 | 19.3 | 5.8 | 5.2 | CD9-1A | CD-800-1 | 3000 |
| PMV1-35RB-3K | | | | M3.5 | 19.3 | 5.8 | 5.2 | | | 3000 |
| PMV1-4RB-3K | | | | M4 | 21.8 | 7.9 | 6.4 | | | 3000 |
| PMV1-5RB-3K | | | | M5 | 22.4 | 8.9 | 6.4 | | | 3000 |
| PMV1-6RB-3K | | | | M6 | 26.4 | 10.9 | 9.7 | | | 3000 |
| PMV2-3RB-3K | 1.5 – 2.5 | Blue | 4.3 | M3 | 21.3 | 5.8 | 5.1 | CD9-2A | CD-800-2 | 3000 |
| PMV2-35RB-3K | | | | M3.5 | 21.3 | 5.8 | 5.1 | | | 3000 |
| PMV2-4RB-3K | | | | M4 | 23.9 | 7.9 | 6.5 | | | 3000 |
| PMV2-5RB-3K | | | | M5 | 24.4 | 8.9 | 6.5 | | | 3000 |
| PMV2-6RB-3K | | | | M6 | 26.7 | 10.9 | 9.7 | | | 3000 |
| PMV6-3RB-2K | 4.0 – 6.0 | Yellow | 5.7 | M3 | 24.9 | 6.1 | 7.9 | CD9-3B | CD-800-3 | 2000 |
| PMV6-35RB-2K | | | | M3.5 | 24.9 | 6.1 | 7.9 | | | 2000 |
| PMV6-4RB-2K | | | | M4 | 25.9 | 7.9 | 7.9 | | | 2000 |
| PMV6-5RB-2K | | | | M5 | 26.7 | 9.4 | 7.9 | | | 2000 |
| PMV6-6RB-2K | | | | M6 | 29.2 | 10.9 | 9.7 | | | 2000 |
| PMV6-8RB-2K | M8 | 30.5 | 13.2 | 9.7 | 2000 | | | | | |

For applicator information, see page D1.143.

E1.
Labeling
Systems

E2.
Labels

E3.
Pre-Printed
& Write-On
Markers

E4.
Permanent
Identification

E5.
Lockout/
Tagout/
& Safety
Solutions

F.
Index



Metric Fork Terminals, Nylon Insulated – Non-Funnel Entry



Type PMN-F

- Continuously molded design provides reliable, consistent performance through the applicator for a high quality termination every time
- Fork design provides for fast and easy installation, without the need to remove fastener

- Metal insulation grip sleeve crimps to wire insulation, providing protection to the crimp joint during high vibration applications
- Internal barrel serrations assure good wire contact and maximum tensile strength

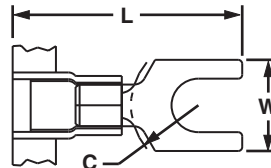

| Part Number | Wire Range (mm ²) | Color Code | Max. Ins. | Stud Size (mm) | Figure Dimensions (mm) | | | CA9 Series Crimp Die | CA-800 Series Crimp Die | Pieces Per Reel |
|-------------|-------------------------------|------------|-----------|----------------|------------------------|------|-----|----------------------|-------------------------|-----------------|
| | | | | | L | W | C | | | |
| PMN1-3F-3K | .5 – 1.5 | Red | 3.7 | M3 | 19.9 | 5.9 | 5.0 | CD9-1A | CD-800-1 | 3000 |
| PMN1-4F-3K | | | | M4 | 21.6 | 8.2 | 5.8 | | | 3000 |
| PMN1-5F-3K | | | | M5 | 21.8 | 8.9 | 6.3 | | | 3000 |
| PMN1-6F-3K | | | | M6 | 26.4 | 11.2 | 8.4 | | | 3000 |
| PMN2-3F-3K | 1.5 – 2.5 | Blue | 4.1 | M3 | 19.8 | 5.9 | 5.1 | CD9-2A | CD-800-2 | 3000 |
| PMN2-4F-3K | | | | M4 | 21.3 | 7.9 | 5.9 | | | 3000 |
| PMN2-5F-3K | | | | M5 | 21.9 | 8.6 | 6.4 | | | 3000 |
| PMN2-6F-3K | | | | M6 | 26.2 | 11.2 | 8.5 | | | 3000 |
| PMN6-4F-2K | 2.5 – 6.0 | Yellow | 5.7 | M4 | 25.7 | 7.9 | 6.1 | CD9-3B | CD-800-3 | 2000 |
| PMN6-5F-2K | | | | M5 | 25.7 | 9.5 | 6.1 | | | 2000 |
| PMN6-6F-2K | | | | M6 | 28.5 | 11.0 | 8.2 | | | 2000 |

For applicator information, see page D1.143.



Metric Fork Terminals, Nylon Insulated – Funnel Entry



Type PMNF-F

- Continuously molded design provides reliable, consistent performance through the applicator for a high quality termination every time
- Flange design provides extra secure connection on a variety of applications

- Metal insulation grip sleeve crimps to wire insulation, providing protection to the crimp joint during high vibration applications
- Internal barrel serrations assure good wire contact and maximum tensile strength

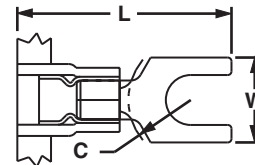

| Part Number | Wire Range (mm ²) | Color Code | Max. Ins. | Stud Size (mm) | Figure Dimensions (mm) | | | CA9 Series Crimp Die | CA-800 Series Crimp Die | Pieces Per Reel |
|-------------|-------------------------------|------------|-----------|----------------|------------------------|------|-----|----------------------|-------------------------|-----------------|
| | | | | | L | W | C | | | |
| PMNF1-3F-3K | .5 – 1.5 | Red | 3.7 | M3 | 20.0 | 5.9 | 5.0 | CD9-1A | CD-800-1 | 3000 |
| PMNF1-4F-3K | | | | M4 | 21.6 | 8.2 | 5.8 | | | 3000 |
| PMNF1-5F-3K | | | | M5 | 21.8 | 8.9 | 6.3 | | | 3000 |
| PMNF1-6F-3K | | | | M6 | 26.4 | 11.2 | 8.4 | | | 3000 |
| PMNF2-3F-3K | 1.5 – 2.5 | Blue | 4.1 | M3 | 19.8 | 5.9 | 5.1 | CD9-2A | CD-800-2 | 3000 |
| PMNF2-4F-3K | | | | M4 | 21.3 | 7.9 | 5.9 | | | 3000 |
| PMNF2-5F-3K | | | | M5 | 21.9 | 8.6 | 6.4 | | | 3000 |
| PMNF2-6F-3K | | | | M6 | 26.2 | 11.2 | 8.5 | | | 3000 |
| PMNF6-4F-2K | 2.5 – 6.0 | Yellow | 5.7 | M4 | 25.7 | 7.9 | 6.1 | CD9-3B | CD-800-3 | 2000 |
| PMNF6-5F-2K | | | | M5 | 25.7 | 9.5 | 6.1 | | | 2000 |
| PMNF6-6F-2K | | | | M6 | 28.5 | 11.0 | 8.2 | | | 2000 |

For applicator information, see page D1.143.

A. System Overview

B1. Cable Ties

B2. Cable Accessories

B3. Stainless Steel Ties

C1. Wiring Duct

C2. Surface Raceway

C3. Abrasion Protection

C4. Cable Management

D1. Terminals

D2. Power Connectors

D3. Grounding Connectors

E1. Labeling Systems

E2. Labels

E3. Pre-Printed & Write-On Markers

E4. Permanent Identification

E5. Lockout/Tagout & Safety Solutions

F. Index

A.
System
Overview



Metric Fork Terminals, Vinyl Insulated – Funnel Entry

B1.
Cable Ties

Type PMV-FB

- Continuously molded design provides reliable, consistent performance through the applicator for a high quality termination every time
- Fork design provides for fast and easy installation, without the need to remove fastener
- Insulation support helps to prevent wire damage in bending applications
- Maximum insulation temperature 221°F (105°C)

B2.
Cable
Accessories

B3.
Stainless
Steel Ties

C1.
Wiring
Duct

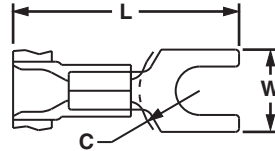

C2.
Surface
Raceway

C3.
Abrasion
Protection

C4.
Cable
Management

| Part Number | Wire Range (mm ²) | Color Code | Max. Ins. | Stud Size (mm) | Figure Dimensions (mm) | | | CA9 Series Crimp Die | CA-800 Series Crimp Die | Pieces Per Reel |
|-------------|-------------------------------|------------|-----------|----------------|------------------------|------|-----|----------------------|-------------------------|-----------------|
| | | | | | L | W | C | | | |
| PMV1-3FB-3K | .5 – 1.5 | Red | 3.7 | M3 | 19.8 | 5.8 | 5.1 | CD9-1A | CD-800-1 | 3000 |
| PMV1-4FB-3K | | | | M4 | 21.3 | 8.1 | 5.8 | | | 3000 |
| PMV1-5FB-3K | | | | M5 | 21.8 | 9.0 | 6.4 | | | 3000 |
| PMV1-6FB-3K | | | | M6 | 26.2 | 11.2 | 8.4 | | | 3000 |
| PMV2-3FB-3K | 1.5 – 2.5 | Blue | 4.3 | M3 | 19.8 | 5.9 | 5.1 | CD9-2A | CD-800-2 | 3000 |
| PMV2-4FB-3K | | | | M4 | 21.3 | 7.9 | 5.8 | | | 3000 |
| PMV2-5FB-3K | | | | M5 | 21.8 | 8.6 | 6.4 | | | 3000 |
| PMV2-6FB-3K | | | | M6 | 26.2 | 11.2 | 8.5 | | | 3000 |
| PMV6-4FB-2K | 2.5 – 6.0 | Yellow | 5.7 | M4 | 25.9 | 7.9 | 6.2 | CD9-3B | CD-800-3 | 2000 |
| PMV6-5FB-2K | | | | M5 | 25.9 | 9.7 | 6.2 | | | 2000 |
| PMV6-6FB-2K | | | | M6 | 28.7 | 11.0 | 8.2 | | | 2000 |

For applicator information, see page D1.143.

D2.
Power
Connectors

D3.
Grounding
Connectors

E1.
Labeling
Systems

E2.
Labels

E3.
Pre-Printed
& Write-On
Markers

E4.
Permanent
Identification

E5.
Lockout/
Tagout/
& Safety
Solutions

F.
Index

Features and Benefits – REEL SMART™ Disconnects

SUPRA-GRIP™ Nylon Fully Insulated Funnel Entry, Female Receptacle Type DNG-FB

Available in tab sizes to accommodate .187" or .250" tabs

Fully insulated design provides protection from electrical shorts

Maximum insulation temperature 221°F (105°C)

Fully integrated metal insulation grip for high vibration, high strain relief, and double crimp requirements

Continuously molded design provides reliable, consistent performance through applicator

Funnel entry for faster wire insertion and lower installed cost



UL and CSA Rated up to 600 V per UL 310.

DISCO-LOK™ Nylon Fully Insulated, Funnel Entry, Female Receptacle Type DNG-FL

Available in tab sizes to accommodate .250" tabs

Unique locking mechanism allows for low insertion (mating) and positive locking for secure connections

Maximum insulation temperature 221°F (105°C)

Continuously molded design provides reliable, consistent performance through applicator

Insulation grip sleeve provides a superior insulation crimp for high vibration and high strain relief applications

Funnel entry for faster wire insertion and lower installed cost



UL and CSA rated up to 300 V.

Standard and Premium Nylon Fully Insulated, Funnel Entry, Females Receptacles and Male Tabs Type DNF and DPF

Available in tab sizes to accommodate .110", .187", .205" or .250" tabs

Fully insulated design provides protection from electrical shorts

Maximum insulation temperature 257°F (125°C)

Insulation support restricts excessive wire movement to minimize stress on crimp joint

Continuously molded design provides reliable, consistent performance through applicator

Expanded wire entry (on select sizes) accommodates large insulation or multiple wires

Funnel entry for faster wire insertion and lower installed cost

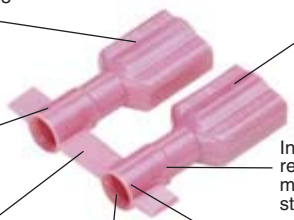

UL and CSA Rated up to 600 V per UL 310.

Vinyl Barrel Insulated Funnel Entry, Female Receptacles and Male Tabs Type DV

Available in tab sizes to accommodate .187", .205", or .250" tabs

Continuously molded design provides reliable, consistent performance through applicator

Insulation grip sleeve provides a superior insulation crimp for high vibration and high strain relief applications

Insulation support to protect electrical crimp



UL and CSA Rated up to 600 V.



High speed electric presses provide for fast terminations. See page D1.144.



Fully Automatic Cable Tie Installation Systems offer an efficient solution for high volume harnessing, assembly, fastening and packaging applications. See pages B1.113 – B1.120.

A. System Overview

B1. Cable Ties

B2. Cable Accessories

B3. Stainless Steel Ties

C1. Wiring Duct

C2. Surface Raceway

C3. Abrasion Protection

C4. Cable Management

D1. Terminals

D2. Power Connectors

D3. Grounding Connectors

E1. Labeling Systems

E2. Labels

E3. Pre-Printed & Write-On Markers

E4. Permanent Identification

E5. Lockout/Tagout & Safety Solutions

F. Index

A. System Overview

Part Number System for REEL SMART™ Disconnects

B1. Cable Ties

B2. Cable Accessories

B3. Stainless Steel Ties

C1. Wiring Duct

C2. Surface Raceway

C3. Abrasion Protection

C4. Cable Management

D1. Terminals

D2. Power Connectors

D3. Grounding Connectors

E1. Labeling Systems

E2. Labels

E3. Pre-Printed & Write-On Markers

E4. Permanent Identification

E5. Lockout/Tagout & Safety Solutions

F. Index

| D | NF | 14 | — | 250 | FIB | 3K |
|-----------------|--|---|---|---|---|---|
| Type | Insulation | Wire Range | | Size and Type | Special Configuration | Std. Pkg. Size |
| D = Disconnects | NF = Nylon Funnel Entry NG = Nylon Funnel Entry Metal Insulation Grip NFR = Nylon Funnel Entry Right Angle PF = Premium Grade Nylon (Double Crimp) V = Vinyl | 18 = #22 – 18 14 = #16 – 14 10 = #12 – 10 | | 110 = .110 x .032 tab size 111 = .110 x .020 tab size 145 = .145 x .032 tab size 187 = .187 x .032 tab size 188 = .187 x .020 tab size 205 = .187/.205 x .032 tab size 206 = .187/.205 x .020 tab size 250 = .250 x .032 tab size .187/.205: Expandable receptacle will accept male tabs from .187" to .205" widths in .032" or .020" thick styles. Fully reliable connection through all widths. | B = Butted seam C = Compression Tab FB = Metal Insulation Grip, Female FL = Fully Insulated Positive Locking Female FIB = Fully Insulated, Butted Seam, Female FIBX = Fully Insulated, Butted Seam, Female, Expanded Wire Entry FIM = Fully Insulated Male FIMB = Fully Insulated, Male, Oversized Housing FIMX = Fully Insulated, Male, Expanded Wire Entry M = Male MB = Male Butted Seam | K = 1,000 KD = 1,500 2K = 2,000 3K = 3,000 |

UL LISTED SUPRA-GRIP™ Female Disconnects, Nylon Fully Insulated – Funnel Entry

Type DNG-FB

- Continuously molded design provides reliable, consistent performance through the applicator for a high quality termination every time
- Disconnect can be inserted and removed from the male tab without the use of tools for lower installed cost
- Flared barrel extension integrated into stamping to provide insulation grip for double crimp requirements
- Internal barrel serrations assure good wire contact and maximum tensile strength
- Internal wire stop assures proper length of insertion into terminal barrel, providing a higher quality connection
- Mates with DNF-FIMB family

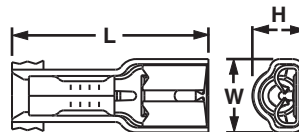

| Part Number | Wire Range | Color Code | Max. Ins. | Figure Dimensions (In.) | | | Tab Size | | CA9 Series Crimp Die | CA-800 Series Crimp Die | Pieces Per Reel |
|-----------------|-------------|------------|-----------|-------------------------|-----|-----|-------------|----------|----------------------|-------------------------|-----------------|
| | | | | L | W | H | In. | mm | | | |
| DNG18-187FB-3K | 22 – 18 AWG | Red | .126 | .89 | .29 | .22 | .187 x .032 | 4.8 x .8 | CD9-15A | CD-800-15 | 3000 |
| DNG18-188FB-3K | | | | .89 | .29 | .22 | .187 x .020 | 4.8 x .5 | | | 3000 |
| DNG18-250FB-3K | | | | .93 | .35 | .23 | .250 x .032 | 6.3 x .8 | | | 3000 |
| DNG14-187FB-3K* | 16 – 14 AWG | Blue | .153 | .89 | .29 | .25 | .187 x .032 | 4.8 x .8 | CD9-16A | CD-800-16 | 3000 |
| DNG14-188FB-3K | | | | .89 | .29 | .25 | .187 x .020 | 4.8 x .5 | | | 3000 |
| DNG14-250FB-3K | | | | .93 | .35 | .25 | .250 x .032 | 6.3 x .8 | | | 3000 |

*UL Recognized for copper alloy tabs only.
For applicator information, see page D1.143.

Disco-Lok™ Female Disconnects, Nylon Fully Insulated – Funnel Entry

Type DNG-FL

- Continuously molded design provides reliable, consistent performance through the applicator for a high quality termination every time
- Disconnect can be inserted and removed from the male tab without the use of tools for lower installed cost
- Unique locking mechanism design allows for low insertion forces (mating) and positive lock for high vibration applications where a secure connection is mandatory



- Fully insulated design provides protection from electrical shorts
- Flared barrel extension integrated into stamping to provide insulation grip for double crimp requirements
- Insulation housing moves back and forth to engage and disengage locking mechanism for repeated use
- Specialty tool required to install this disconnect (CT-1014)
- Mates with DNF-FIMB family

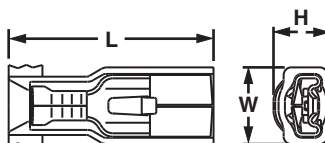

| Part Number | Wire Range | Color Code | Max. Ins. | Figure Dimensions (In.) | | | Tab Size | | CA9 Series Crimp Die | CA-800 Series Crimp Die | Pieces Per Reel |
|-----------------------|-------------|------------|-----------|-------------------------|-----|-----|-------------|----------|----------------------|-------------------------|-----------------|
| | | | | L | W | H | In. | mm | | | |
| DNG18-250FL-3K | 22 – 18 AWG | Red | .126 | .97 | .36 | .24 | .250 x .032 | 6.3 x .8 | CD9-14A | CD-800-14 | 3000 |
| DNG14-250FL-3K | 16 – 14 AWG | Blue | .150 | .97 | .36 | .25 | .250 x .032 | 6.3 x .8 | CD9-14A | CD-800-14 | 3000 |

For applicator information, see page D1.143.

Female Disconnects, Nylon Fully Insulated – Funnel Entry

Type DNF-FIB

- Continuously molded design provides reliable, consistent performance through the applicator for a high quality termination every time
- Disconnect can be inserted and removed from the male tab without the use of tools for lower installed cost
- Fully insulated design provides protection from electrical shorts



- Disconnects available in common industry tab sizes
- Internal wire stop assures proper length of insertion into terminal barrel, providing a higher quality connection
- UL and CSA rated up to 600 V per UL 310

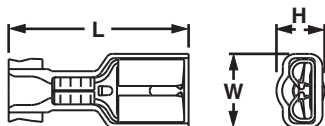

| Part Number | Wire Range | Color Code | Max. Ins. | Figure Dimensions (In.) | | | Tab Size | | CA9 Series Crimp Die | CA-800 Series Crimp Die | Pieces Per Reel |
|--------------------------|-------------|------------|-----------|-------------------------|-----|-------------|------------------|--------------|----------------------|-------------------------|-----------------|
| | | | | L | W | H | In. | mm | | | |
| DNF18-110FIB-3K | 22 – 18 AWG | Red | .120 | .71 | .19 | .15 | .110 x .032 | 2.8 x .8 | CD9-7A | CD-800-7 | 3000 |
| DNF18-111FIB-3K | | Red | .120 | .71 | .19 | .15 | .110 x .020 | 2.8 x .5 | CD9-7A | CD-800-7 | 3000 |
| DNF18-112FIB-3K* | | Natural | .120 | .71 | .19 | .15 | .110 x .010 | 2.8 x .3 | CD9-7A | CD-800-7 | 3000 |
| DNF18-187FIB-3K | | Red | .136 | .78 | .29 | .16 | .187 x .032 | 4.8 x .8 | CD9-4A | CD-800-4 | 3000 |
| DNF18-188FIB-3K | | Red | .136 | .78 | .29 | .16 | .187 x .020 | 4.8 x .5 | CD9-4A | CD-800-4 | 3000 |
| DNF18-205FIB-3K | | Red | .136 | .78 | .31 | .22 | .187/.205 x .032 | 4.8/5.2 x .8 | CD9-4A | CD-800-4 | 3000 |
| DNF18-206FIB-3K | | Red | .136 | .78 | .31 | .22 | .187/.205 x .020 | 4.8/5.2 x .5 | CD9-4A | CD-800-4 | 3000 |
| DNF18-250FIB-3K** | Red | .136 | .84 | .35 | .22 | .250 x .032 | 6.3 x .8 | CD9-4A | CD-800-4 | 3000 | |
| DNF14-187FIB-3K | 16 – 14 AWG | Blue | .160 | .78 | .29 | .18 | .187 x .032 | 4.8 x .8 | CD9-5A | CD-800-5 | 3000 |
| DNF14-188FIB-3K | | | .160 | .78 | .29 | .18 | .187 x .020 | 4.8 x .5 | CD9-5A | CD-800-5 | 3000 |
| DNF14-205FIB-3K | | | .160 | .78 | .31 | .22 | .187/.205 x .032 | 4.8/5.2 x .8 | CD9-5A | CD-800-5 | 3000 |
| DNF14-206FIB-3K | | | .160 | .78 | .31 | .22 | .187/.205 x .020 | 4.8/5.2 x .5 | CD9-5A | CD-800-5 | 3000 |
| DNF14-250FIB-3K | | | .160 | .84 | .35 | .22 | .250 x .032 | 6.3 x .8 | CD9-5A | CD-800-5 | 3000 |
| DNF10-250FIB-2K | 12 – 10 AWG | Yellow | .220 | .96 | .35 | .23 | .250 x .032 | 6.3 x .8 | CD9-13B | CD-800-13 | 2000 |
| DNF10250FIBC-2K‡ | | | .220 | .96 | .35 | .23 | .250 x .032 | 6.4 x .8 | CD9-13B | CD-800-13 | 2000 |

*UL/CSA standards do not exist for .110" x .010" receptacles.

**UL with 17 AWG wire.

‡Compressor tab disconnect to fit .250" tabs with a post style support.

For applicator information, see page D1.143.

A. System Overview

B1. Cable Ties

B2. Cable Accessories

B3. Stainless Steel Ties

C1. Wiring Duct

C2. Surface Raceway

C3. Abrasion Protection

C4. Cable Management

D1. Terminals

D2. Power Connectors

D3. Grounding Connectors

E1. Labeling Systems

E2. Labels

E3. Pre-Printed & Write-On Markers

E4. Permanent Identification

E5. Lockout/Tagout & Safety Solutions

F. Index

A. System Overview



Disco™ Female Disconnects, Nylon Fully Insulated – Expanded Wire Entry

Type DNF-FIBX

- Continuously molded design provides reliable, consistent performance through the applicator for a high quality termination every time
- Expanded wire entry designed to accommodate wire with a larger insulation thickness
- Disconnect can be inserted and removed from the male tab without the use of tools for lower installed cost

- Fully insulated design provides protection from electrical shorts
- Disconnects available in common industry tab sizes
- Internal wire stop assures proper length of insertion into terminal barrel, providing a higher quality connection
- UL and CSA rated up to 600 V per UL 310

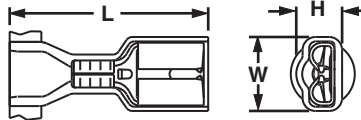

B1. Cable Ties

B2. Cable Accessories

B3. Stainless Steel Ties

C1. Wiring Duct

C2. Surface Raceway

C3. Abrasion Protection

C4. Cable Management

| Part Number | Wire Range | Color Code | Max. Ins. | Figure Dimensions (In.) | | | | Tab Size | | CA9 Series Crimp Die | CA-800 Series Crimp Die | Pieces Per Reel |
|------------------------|-------------|------------|-----------|-------------------------|-----|-----|------------------|--------------|--------|----------------------|-------------------------|-----------------|
| | | | | L | W | H | D | In. | mm | | | |
| DNF18205FIBX-2K | 22 – 18 AWG | Red | .210 | .87 | .31 | .22 | .187/.205 x .032 | 4.8/5.2 x .8 | CD9-6B | CD-800-6 | 2000 | |
| DNF18206FIBX-2K | | | | .87 | .31 | .22 | .187/.205 x .020 | 4.8/5.2 x .5 | | | 2000 | |
| DNF18250FIBX-2K | | | | .93 | .35 | .22 | .250 x .032 | 6.3 x .8 | | | 2000 | |
| DNF14205FIBX-2K | 16 – 14 AWG | Blue | .240 | .87 | .31 | .22 | .187/.205 x .032 | 4.8/5.2 x .8 | CD9-8B | CD-800-8 | 2000 | |
| DNF14206FIBX-2K | | | | .87 | .31 | .22 | .187/.205 x .020 | 4.8/5.2 x .5 | | | 2000 | |
| DNF14250FIBX-2K | | | | .93 | .35 | .22 | .250 x .032 | 6.3 x .8 | | | 2000 | |

For applicator information, see page D1.143.

D1. Terminals



Disco™ Female Disconnects, Nylon Fully Insulated – Right Angle

Type DNFR-FIB

- Continuously molded design provides reliable, consistent performance through the applicator for a high quality termination every time
- Right angle design for use in limited space applications
- Fully insulated design provides protection from electrical shorts

- Internal wire stop assures proper length of insertion into terminal barrel, providing a higher quality connection
- Disconnect can be inserted and removed from the male tab without the use of tools for lower installed cost
- Disconnects available in common industry tab sizes

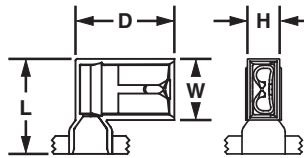

E1. Labeling Systems

E2. Labels

E3. Pre-Printed & Write-On Markers

E4. Permanent Identification

E5. Lockout/Tagout & Safety Solutions

F. Index

| Part Number | Wire Range | Color Code | Max. Ins. | Figure Dimensions (In.) | | | | Tab Size | | CA9 Series Crimp Die | CA-800 Series Crimp Die | Pieces Per Reel |
|------------------------|-------------|------------|-----------|-------------------------|-----|-----|-----|------------------|--------------|----------------------|-------------------------|-----------------|
| | | | | L | W | H | D | In. | mm | | | |
| DNFR18205FIB-KD | 22 – 18 AWG | Red | .178 | .57 | .37 | .21 | .60 | .187/.205 x .032 | 4.8/5.2 x .8 | CD9-9C | CD-800-9 | 1500 |
| DNFR18206FIB-KD | | | | .57 | .37 | .21 | .60 | .187/.205 x .020 | 4.8/5.2 x .5 | | | 1500 |
| DNFR18250FIB-KD | | | | .57 | .37 | .21 | .60 | .250 x .032 | 6.3 x .8 | | | 1500 |
| DNFR14205FIB-KD | 16 – 14 AWG | Blue | .178 | .57 | .37 | .21 | .60 | .187/.205 x .032 | 4.8/5.2 x .8 | CD9-9C | CD-800-9 | 1500 |
| DNFR14206FIB-KD | | | | .57 | .37 | .21 | .60 | .187/.205 x .020 | 4.8/5.2 x .5 | | | 1500 |
| DNFR14250FIB-KD | | | | .57 | .37 | .21 | .60 | .250 x .032 | 6.3 x .8 | | | 1500 |

For applicator information, see page D1.143.



Disco™ Female Disconnects, Vinyl Barrel Insulated – Funnel Entry

Type DV-B

- Continuously molded design provides reliable, consistent performance through the applicator for a high quality termination every time
- Disconnect can be inserted and removed from the male tab without the use of tools for lower installed cost
- Metal insulation grip sleeve crimps to wire insulation, providing protection to the crimp joint during high vibration applications
- Internal barrel serrations assure good wire contact and maximum tensile strength
- Internal wire stop assures proper length of insertion into terminal barrel, providing a higher quality connection
- UL Flammability UL 94V-0, maximum insulation temperature 221°F (105°C)

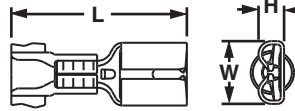

| Part Number | Wire Range | Color Code | Max. Ins. | Figure Dimensions (In.) | | | Tab Size | | CA9 Series Crimp Die | CA-800 Series Crimp Die | Pieces Per Reel |
|-----------------|-------------|------------|-----------|-------------------------|-----|-----|------------------|--------------|----------------------|-------------------------|-----------------|
| | | | | L | W | H | In. | mm | | | |
| DV18-187B-3K | 22 – 18 AWG | Red | .150 | .77 | .23 | .10 | .187 x .032 | 4.8 x .8 | CD9-1A | CD-800-1 | 3000 |
| DV18-188B-3K | | | .150 | .77 | .23 | .09 | .187 x .020 | 4.8 x .5 | | | 3000 |
| DV18-205B-3K | | | .150 | .77 | .25 | .12 | .187/.205 x .032 | 4.8/5.2 x .8 | | | 3000 |
| DV18-206B-3K | | | .150 | .77 | .25 | .11 | .187/.205 x .020 | 4.8/5.2 x .5 | | | 3000 |
| DV18-250B-3K | | | .150 | .83 | .29 | .12 | .250 x .032 | 6.3 x .8 | | | 3000 |
| DV14-187B-3K | 16 – 14 AWG | Blue | .170 | .77 | .23 | .10 | .187 x .032 | 4.8 x .8 | CD9-2A | CD-800-2 | 3000 |
| DV14-188B-3K | | | .170 | .77 | .23 | .09 | .187 x .020 | 4.8 x .5 | | | 3000 |
| DV14-205B-3K | | | .170 | .77 | .25 | .12 | .187/.205 x .032 | 4.8/5.2 x .8 | | | 3000 |
| DV14-206B-3K | | | .170 | .77 | .25 | .11 | .187/.205 x .020 | 4.5/5.2 x .5 | | | 3000 |
| DV14-250B-3K | | | .170 | .83 | .29 | .12 | .250 x .032 | 6.3 x .8 | | | 3000 |
| DV10-250-2K* | 12 – 10 AWG | Yellow | .230 | .95 | .29 | .12 | .250 x .032 | 6.3 x .8 | CD9-3B | CD-800-3 | 2000 |
| DV10-250C-2K†** | | | .230 | .95 | .29 | .12 | .250 x .032 | 6.4 x .8 | | | 2000 |

*Not UL Listed or CSA Certified.

**UL Recognized and CSA Certified.

‡Compression tab disconnect to fit .250" tabs with a post style support.

For applicator information, see page D1.143.

A. System Overview

B1. Cable Ties

B2. Cable Accessories

B3. Stainless Steel Ties

C1. Wiring Duct

C2. Surface Raceway

C3. Abrasion Protection

C4. Cable Management

D1. Terminals

D2. Power Connectors

D3. Grounding Connectors

E1. Labeling Systems

E2. Labels

E3. Pre-Printed & Write-On Markers

E4. Permanent Identification

E5. Lockout/Tagout & Safety Solutions

F. Index

A. System Overview



DISCOGRIP™ Female Disconnects, Fully Insulated

B1. Cable Ties

Type DPF-FIB

- Continuously molded design provides reliable, consistent performance through the applicator for a high quality termination every time
- Disconnect can be inserted and removed from the male tab without the use of tools for lower installed cost
- Premium nylon insulation retains its shape when crimped and provides a tight grip around the wire insulation for maximum strain relief
- Fully insulated design provides protection from electrical shorts
- Internal wire stop assures proper length of insertion into terminal barrel, providing a higher quality connection
- Disconnects available in common industry tab sizes
- UL and CSA rated up to 600 V per UL 310

B2. Cable Accessories

B3. Stainless Steel Ties

C1. Wiring Duct

C2. Surface Raceway

C3. Abrasion Protection

C4. Cable Management

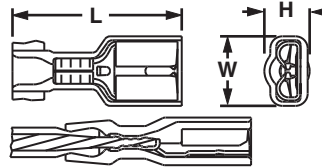

Cross section of DISCOGRIP™ Crimp showing insulation crimp of the wire insulation.

D1. Terminals

D2. Power Connectors

D3. Grounding Connectors

| Part Number | Wire Range | Color Code | Max. Ins. | Figure Dimensions (In.) | | | Tab Size | | CA9 Series Crimp Die | CA-800 Series Crimp Die | Pieces Per Reel |
|------------------------|-------------|------------|-------------|-------------------------|------|-----|------------------|--------------|----------------------|-------------------------|-----------------|
| | | | | L | W | H | In. | mm | | | |
| DPF18-110FIB-3K | 22 – 18 AWG | Red | .132 | .71 | .19 | .17 | .110 x .032 | 2.8 x .8 | CD9-12A | CD-800-12 | 3000 |
| DPF18-111FIB-3K | | | .132 | .71 | .19 | .17 | .110 x .020 | 2.8 x .5 | | | 3000 |
| DPF18-187FIB-3K | | | .136 | .78 | .29 | .16 | .187 x .032 | 4.8 x .8 | CD9-10A | CD-800-10 | 3000 |
| DPF18-188FIB-3K | | | .136 | .78 | .29 | .16 | .187 x .020 | 4.8 x .5 | | | 3000 |
| DPF18-205FIB-3K | | | .136 | .78 | .31 | .22 | .187/.205 x .032 | 4.8/5.2 x .8 | | | 3000 |
| DPF18-206FIB-3K | | | .136 | .78 | .31 | .22 | .187/.205 x .020 | 4.8/5.2 x .5 | | | 3000 |
| DPF18-250FIB-3K | 16 – 14 AWG | Blue | .136 | .84 | .35 | .22 | .250 x .032 | 6.3 x .8 | CD9-11A | CD-800-11 | 3000 |
| DPF14-187FIB-3K | | | .160 | .78 | .29 | .18 | .187 x .032 | 4.8 x .8 | | | 3000 |
| DPF14-205FIB-3K | | | .160 | .78 | .31 | .22 | .187/.205 x .032 | 4.8/5.2 x .8 | CD9-13B | CD-800-13 | 3000 |
| DPF14-206FIB-3K | | | .160 | .78 | .31 | .22 | .187/.205 x .020 | 4.8/5.2 x .5 | | | 3000 |
| DPF14-250FIB-3K | | | .160 | .84 | .35 | .22 | .250 x .032 | 6.3 x .8 | 3000 | | |
| DPF10-250FIB-2K | | | 12 – 10 AWG | Yellow | .220 | .96 | .35 | .23 | .250 x .032 | 6.3 x .8 | |

For applicator information, see page D1.143.

E1. Labeling Systems

E2. Labels

E3. Pre-Printed & Write-On Markers

E4. Permanent Identification

E5. Lockout/Tagout & Safety Solutions

F. Index

UL LISTED **SR CERTIFIED** **DISCOGRIP™ Male Disconnects, Fully Insulated**

Type DPF-FIM

- Continuously molded design provides reliable, consistent performance through the applicator for a high quality termination every time
- Disconnect can be inserted and removed from the male tab without the use of tools for lower installed cost
- Fully insulated design provides protection from electrical shorts
- Premium nylon insulation retains its shape when crimped and provides a tight grip around the wire insulation for maximum strain relief

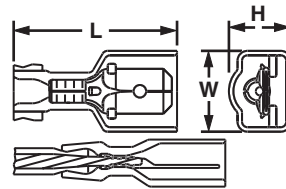

Cross section of DISCOGRIP™ Crimp showing insulation crimp of the wire insulation.

- Oversized housing designed for maximum versatility to mate with most commercially available fully insulated female disconnects
- Internal wire stop assures proper length of insertion into terminal barrel, providing a higher quality connection
- UL and CSA rated up to 600 V per UL 310

| Part Number | Wire Range | Color Code | Max. Ins. | Figure Dimensions (In.) | | | Tab Size | | CA9 Series Crimp Die | CA-800 Series Crimp Die | Pieces Per Reel |
|--------------------------|-------------|------------|-----------|-------------------------|-----|-----|-------------|----------|----------------------|-------------------------|-----------------|
| | | | | L | W | H | In. | mm | | | |
| Standard Housing | | | | | | | | | | | |
| DPF18-250FIM-2K | 22 – 18 AWG | Red | .133 | .90 | .41 | .29 | .250 x .032 | 6.3 x .8 | CD9-10B | CD-800-10 | 2000 |
| DPF14-250FIM-2K | 16 – 14 AWG | Blue | .156 | | | | | | CD9-11B | CD-800-11 | 2000 |
| Oversized Housing | | | | | | | | | | | |
| DPF18-250FIMB-K* | 22 – 18 AWG | Red | .133 | .92 | .46 | .34 | .250 x .032 | 6.3 x .8 | CD9-10B | CD-800-10 | 1000 |
| DPF14-250FIMB-K* | 16 – 14 AWG | Blue | .156 | | | | | | CD9-11B | CD-800-11 | 1000 |

*To mate with other manufacturers fully insulated .250 x .032 female receptacles. For applicator information, see page D1.143.

A. System Overview

B1. Cable Ties

B2. Cable Accessories

B3. Stainless Steel Ties

C1. Wiring Duct

C2. Surface Raceway

C3. Abrasion Protection

C4. Cable Management

D1. Terminals

D2. Power Connectors

D3. Grounding Connectors

E1. Labeling Systems

E2. Labels

E3. Pre-Printed & Write-On Markers

E4. Permanent Identification

E5. Lockout/Tagout & Safety Solutions

F. Index

A. System Overview



Disco™ Male Disconnects, Nylon Fully Insulated – Funnel Entry

Type DNF-FIM

- Continuously molded design provides reliable, consistent performance through the applicator for a high quality termination every time
- Male tab couples with (all .250 x .032) female disconnects

- Fully insulated design provides protection from electrical shorts
- Male tab can be inserted and removed from the female disconnect without the use of tools for lower installed cost

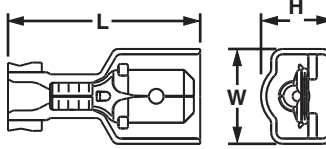

B1. Cable Ties

B2. Cable Accessories

B3. Stainless Steel Ties

C1. Wiring Duct

C2. Surface Raceway

C3. Abrasion Protection

C4. Cable Management

| Part Number | Wire Range | Color Code | Max. Ins. | Figure Dimensions (In.) | | | Tab Size | | CA9 Series Crimp Die | CA-800 Series Crimp Die | Pieces Per Reel |
|--------------------------|-------------|------------|-----------|-------------------------|-----|-----|-------------|----------|----------------------|-------------------------|-----------------|
| | | | | L | W | H | In. | mm | | | |
| Standard Housing | | | | | | | | | | | |
| DNF18-250FIM-2K | 22 – 18 AWG | Red | .133 | .90 | .42 | .30 | .250 x .032 | 6.3 x .8 | CD9-4B | CD-800-4 | 2000 |
| DNF14-250FIM-2K | 16 – 14 AWG | Blue | .158 | .90 | .42 | .30 | .250 x .032 | 6.3 x .8 | CD9-5B | CD-800-5 | 2000 |
| Oversized Housing | | | | | | | | | | | |
| DNF18-250FIMB-K* | 22 – 18 AWG | Red | .135 | .91 | .45 | .34 | .250 x .032 | 6.3 x .8 | CD9-4B | CD-800-4 | 1000 |
| DNF14-250FIMB-K* | 16 – 14 AWG | Blue | .160 | .91 | .46 | .34 | .250 x .032 | 6.3 x .8 | CD9-5B | CD-800-5 | 1000 |
| DNF10-250FIMB-K | 12 – 10 AWG | Yellow | .220 | .96 | .45 | .36 | .250 x .032 | 6.3 x .8 | CD9-18B | CD-800-18 | 1000 |

*To mate with other manufacturers' fully insulated .250 x .032 female receptacles. For applicator information, see page D1.143.

D1. Terminals



Disco™ Male Disconnects, Nylon Fully Insulated – Expanded Wire Entry

Type DNF-FIMX

- Continuously molded design provides reliable, consistent performance through the applicator for a high quality termination every time
- Expanded wire entry designed to accommodate wire with a larger insulation thickness
- Male tab couples with (all .250 x .032) female disconnects
- Fully insulated design provides protection from electrical shorts

- Male tab can be inserted and removed from the female disconnect without the use of tools for lower installed cost
- Internal barrel serrations assure good wire contact and maximum tensile strength

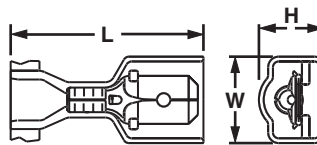

D2. Power Connectors

D3. Grounding Connectors

E1. Labeling Systems

E2. Labels

E3. Pre-Printed & Write-On Markers

E4. Permanent Identification

E5. Lockout/Tagout & Safety Solutions

| Part Number | Wire Range | Color Code | Max. Ins. | Figure Dimensions (In.) | | | Tab Size | | CA9 Series Crimp Die | CA-800 Series Crimp Die | Pieces Per Reel |
|--------------------------|-------------|------------|-----------|-------------------------|-----|-----|-------------|----------|----------------------|-------------------------|-----------------|
| | | | | L | W | H | In. | mm | | | |
| DNF18250FIMX-2K* | 22 – 18 AWG | Red | .244 | .97 | .41 | .29 | .250 x .032 | 6.3 x .8 | CD9-8B | CD-800-8 | 2000 |
| DNF14250FIMX-2K** | 16 – 14 AWG | Blue | | | | | | | | | 2000 |

*CSA Certified for use with (2) #18 AWG, (2) #20 AWG, or (2) #22 AWG wires.
 **CSA Certified for use with (2) #16 AWG or (2) #18 AWG wires.
 For applicator information, see page D1.143.

F. Index

Disco™ Male Disconnects, Nylon Barrel Insulated – Funnel Entry

CERTIFIED

Type DNF-M

- Continuously molded design provides reliable, consistent performance through the applicator for a high quality termination every time
- Male tab couples with (all .250 x .032) female disconnects
- Male tab can be inserted and removed from the female disconnect without the use of tools for lower installed cost
- Metal insulation grip sleeve crimps to wire insulation, providing protection to the crimp joint during high vibration applications
- Internal barrel serrations assure good wire contact and maximum tensile strength
- Maximum insulation temperature 221°F (105°C)

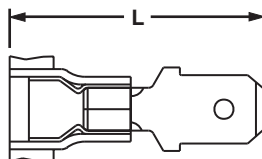

| Part Number | Wire Range | Color Code | Max. Ins. | Figure Dimensions (In.) | | Tab Size | | CA9 Series Crimp Die | CA-800 Series Crimp Die | Pieces Per Reel |
|----------------|-------------|------------|-----------|-------------------------|-------------|----------|--------|----------------------|-------------------------|-----------------|
| | | | | L | In. | mm | | | | |
| DNF18-250M-3K | 22 – 18 AWG | Red | .145 | .90 | .250 x .032 | 6.3 x .8 | CD9-1A | CD-800-1 | 3000 | |
| DNF14-250M-3K | 16 – 14 AWG | Blue | .162 | .90 | .250 x .032 | 6.3 x .8 | CD9-2A | CD-800-2 | 3000 | |
| DNF10-250M-2K* | 12 – 10 AWG | Yellow | .225 | .95 | .250 x .032 | 6.3 x .8 | CD9-3B | CD-800-3 | 2000 | |

*Not CSA Certified.

For applicator information, see page D1.143.

Disco™ Male Disconnects, Vinyl Barrel Insulated – Funnel Entry

LISTED CERTIFIED

Type DV-MB

- Continuously molded design provides reliable, consistent performance through the applicator for a high quality termination every time
- Male tab couples with (all .250 x .032) female disconnects
- Insulation support helps to prevent wire damage in bending applications
- Male tab can be inserted and removed from the female disconnect without the use of tools for lower installed cost
- UL and CSA rated up to 600 V per UL 310

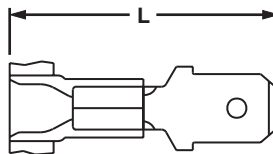

| Part Number | Wire Range | Color Code | Max. Ins. | Figure Dimensions (In.) | | Tab Size | | CA9 Series Crimp Die | CA-800 Series Crimp Die | Pieces Per Reel |
|---------------|-------------|------------|-----------|-------------------------|-------------|----------|--------|----------------------|-------------------------|-----------------|
| | | | | L | In. | mm | | | | |
| DV18-250MB-3K | 22 – 18 AWG | Red | .155 | .90 | .250 x .032 | 6.3 x .8 | CD9-1A | CD800-1 | 3000 | |
| DV14-250MB-3K | 16 – 14 AWG | Blue | .175 | | | | CD9-2A | CD-800-2 | 3000 | |
| DV10-250M-2K | 12 – 10 AWG | Yellow | .225 | | | | CD9-3B | CD-800-3 | 2000 | |

For applicator information, see page D1.143.

A. System Overview

B1. Cable Ties

B2. Cable Accessories

B3. Stainless Steel Ties

C1. Wiring Duct

C2. Surface Raceway

C3. Abrasion Protection

C4. Cable Management

D1. Terminals

D2. Power Connectors

D3. Grounding Connectors

E1. Labeling Systems

E2. Labels

E3. Pre-Printed & Write-On Markers

E4. Permanent Identification

E5. Lockout/Tagout & Safety Solutions

F. Index

A. System Overview

Pin Terminals, Vinyl Insulated – Funnel Entry

Type PV-PB

B1. Cable Ties

- Continuously molded design provides reliable, consistent performance through the applicator for a high quality termination every time
- Solid pin designed to prevent damage to the wire from over tightening, resulting in a reliable electrical connection

B2. Cable Accessories

B3. Stainless Steel Ties



- For use with pin-type terminal blocks
- Insulation support helps to prevent wire damage in bending applications
- UL rated up to 600 V per UL 486

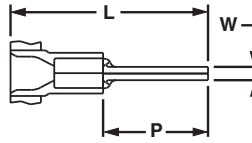

C1. Wiring Duct

| Part Number | Wire Range | Color Code | Max. Ins. | Figure Dimensions (In.) | | | CA9 Series Crimp Die | CA-800 Series Crimp Die | Pieces Per Reel |
|---------------------|-------------|------------|-----------|-------------------------|-----|-----|----------------------|-------------------------|-----------------|
| | | | | L | W | P | | | |
| PV18-P47B-3K | 22 – 18 AWG | Red | .150 | .90 | .07 | .49 | CD9-1A | CD-800-1 | 3000 |
| PV14-P47B-3K | 16 – 14 AWG | Blue | .170 | .90 | .07 | .49 | CD9-2A | CD-800-2 | 3000 |

For applicator information, see page D1.143.

C2. Surface Raceway

Male Blade Adapters, Vinyl Insulated – Funnel Entry

Type DV-MB

C3. Abrasion Protection

- Continuously molded design provides reliable, consistent performance through the applicator for a high quality termination every time
- Flat blade design to prevent damage to the wire from over tightening, resulting in a reliable electrical connection

C4. Cable Management



- For use with blade-type terminal blocks
- Insulation support helps to prevent wire damage in bending applications
- Brazed seam protects terminal barrel from splitting during the crimp process

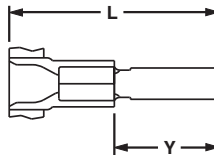

D1. Terminals

| Part Number | Wire Range | Color Code | Max. Ins. | Figure Dimensions (In.) | | Tab Size (In.) | CA9 Series Crimp Die | CA-800 Series Crimp Die | Pieces Per Reel |
|----------------------|-------------|------------|-----------|-------------------------|-----|----------------|----------------------|-------------------------|-----------------|
| | | | | L | Y | | | | |
| DV18-145MB-3K | 22 – 18 AWG | Red | .155 | .90 | .42 | .145 x .032 | CD9-1A | CD-800-1 | 3000 |
| DV14-145MB-3K | 16 – 14 AWG | Blue | .175 | .90 | .42 | .145 x .032 | CD9-2A | CD-800-2 | 3000 |

For applicator information, see page D1.143.

D2. Power Connectors

D3. Grounding Connectors

Butted Splices Nylon Insulated and Premium Grade Nylon

Type BSN, BSP

E1. Labeling Systems

- Continuously molded design provides reliable, consistent performance through the applicator for a high quality termination every time
- Designed to splice two solid or stranded wires together to repair or lengthen wires
- Butted configuration provides low profile for limited space applications

E2. Labels

E3. Pre-Printed & Write-On Markers



E4. Permanent Identification

- Brazed seam protects terminal barrel from splitting during the crimp process
- Internal wire stop assures proper length of insertion into terminal barrel
- Premium grade nylon insulation available for applications requiring a tighter grip around the wire insulation for maximum strain relief

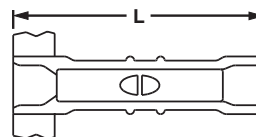

E5. Lockout/Tagout & Safety Solutions

| Part Number | Wire Range | Color Code | Max. Ins. | Figure Dimensions (In.) | CA9 Series Crimp Die | CA-800 Series Crimp Die | Pieces Per Reel |
|-----------------|-------------|------------|-----------|-------------------------|----------------------|-------------------------|-----------------|
| | | | | L | | | |
| BSN18-3K | 22 – 16 AWG | Red | .150 | .95 | CD9-1A | CD-800-1 | 3000 |
| BSN14-3K | 18 – 14 AWG | Blue | .170 | .95 | CD9-2A | CD-800-2 | 3000 |
| BSN10-2K | 12 – 10 AWG | Yellow | .230 | .95 | CD9-17B | CD-800-17 | 2000 |
| BSP18-3K | 22 – 16 AWG | Red | .150 | .96 | CD9-1A | CD-800-1 | 3000 |
| BSP14-3K | 18 – 14 AWG | Blue | .170 | .96 | CD9-2A | CD-800-2 | 3000 |

For applicator information, see page D1.143.

F. Index

Features and Benefits – REEL SMART™ Metric Disconnects

Metric SUPRA-GRIP™ Nylon Fully Insulated Female Disconnects Type DMNG-FB



Fully insulated design provides protection from electrical shorts

Available in tab sizes to accommodate 4.8mm and 6.3mm tabs

Maximum insulation temperature 221°F (105°C)

Funnel entry for faster wire insertion and lower installed cost

Fully integrated metal insulation grip for high vibration, high strain relief, and double crimp requirements

Rated at 600 V.

Metric DISCO-LOK™ Nylon Fully Insulated, Funnel Entry, Female Receptacle Type DMNG-FL

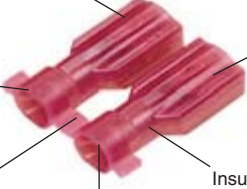

Available in tab sizes to accommodate 6.3mm tabs

Unique locking mechanism allows for low insertion (mating) and positive locking for secure connections

Maximum insulation temperature 221°F (105°C)

Funnel entry for faster wire insertion and lower installed cost

Continuously molded design provides reliable, consistent performance through applicator

Insulation grip sleeve provides a superior insulation crimp for high vibration and high strain relief applications

UL and CSA rated up to 300 V.

Metric Standard and Premium Nylon Fully Insulated, Funnel Entry, Female Receptacles and Male Tabs Type DMNF and DMPF

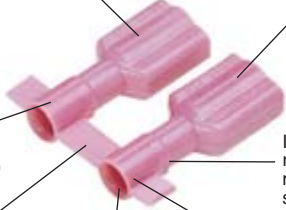

Fully insulated design provides protection from electrical shorts

Available in tab sizes to accommodate 2.8, 4.8, and 6.3 tabs

Maximum insulation temperature 257°F (125°C)

Insulation support restricts excessive wire movement to minimize stress on crimp joint

Continuously molded design provides reliable, consistent performance through applicator

Expanded wire entry (on select sizes) accommodates large insulation or multiple wires

Funnel entry for faster wire insertion and lower installed cost

Rated at 600 V.

Metric Vinyl Barrel Insulated Funnel Entry, Female Receptacles and Male Tabs Type DMV

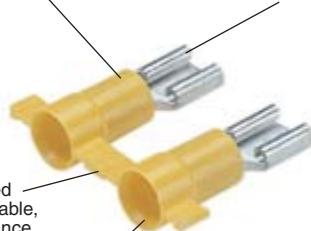

Insulation support to protect electrical crimp

Available in tab sizes to accommodate 2.8, 4.8, and 6.3 tabs

Continuously molded design provides reliable, consistent performance through applicator

Insulation grip sleeve provides a superior insulation crimp for high vibration and high strain relief applications

Rated at 600 V.

A. System Overview

B1. Cable Ties

B2. Cable Accessories

B3. Stainless Steel Ties

C1. Wiring Duct

C2. Surface Raceway

C3. Abrasion Protection

C4. Cable Management

D1. Terminals

D2. Power Connectors

D3. Grounding Connectors

E1. Labeling Systems

E2. Labels

E3. Pre-Printed & Write-On Markers

E4. Permanent Identification

E5. Lockout/Tagout & Safety Solutions

F. Index

Part Number System for REEL SMART™ Metric Disconnects

| | DM | NF | 1 | — | 285 | FIB | 3K |
|--------------------------|-----------------------|---|--|----------|--|---|---|
| | Type | Insulation | Wire Range | | Size and Type | Special Configuration | Std. Pkg. Size |
| A. System Overview | D = Disconnect Metric | N = Nylon NF = Nylon Funnel Entry V = Vinyl | 1 = .5 – 1.0mm ² or .5 – 1.5mm ² 2 = 1.5 – 2.5mm ² 6 = 2.5 – 6.0mm ² or 4.0 – 6.0mm ² | | 283 = 2.8mm x .3mm Tab Size 285 = 2.8mm x .5mm Tab Size 288 = .2.8mm x .8mm Tab Size 485 = 4.8mm x .5mm Tab Size 488 = 4.8mm x .8mm Tab Size 63 = 6.3mm x .8mm Tab Size | B = Butted Seam FB = Metal Insulation Grip, Female FL = Fully Insulated Positive Locking Female FIB = Fully Insulated, Butted Seam, Female FIBX = Fully Insulated, Butted Seam, Female, Expanded Wire Entry FIM = Fully Insulated Male FIMB = Fully Insulated, Male, Oversized Housing FIMX = Fully Insulated, Male, Expanded Wire Entry | K = 1,000 KD = 1,500 2K = 2,000 3K = 3,000 |
| B1. Cable Ties | | | | | | | |
| B2. Cable Accessories | | | | | | | |
| B3. Stainless Steel Ties | | | | | | | |
| C1. Wiring Duct | | | | | | | |
| C2. Surface Raceway | | | | | | | |
| C3. Abrasion Protection | | | | | | | |
| C4. Cable Management | | | | | | M = Male MB = Male Butted Seam | |

NEW!  **Metric SUPRA-GRIP™ Female Disconnects, Nylon Fully Insulated – Funnel Entry**

Type DMNG-FB

- Continuously molded design provides reliable, consistent performance through the applicator for a high quality termination every time
- Disconnect can be inserted and removed from the male tab without the use of tools for lower installed cost
- Flared barrel extension integrated into stamping to provide insulation grip for double crimp requirements
- Internal barrel serrations assure good wire contact and maximum tensile strength
- Internal wire stop assures proper length of insertion into terminal barrel, providing a higher quality connection
- Mates with DNF-FIMB family

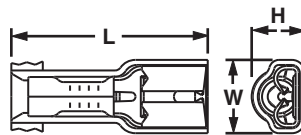

| Part Number | Wire Range (mm ²) | Color Code | Max. Ins. | Figure Dimensions (mm) | | | Tab Size (mm) | CA9 Series Crimp Die | CA-800 Series Crimp Die | Pieces Per Reel |
|-----------------|-------------------------------|------------|-----------|------------------------|-----|-----|---------------|----------------------|-------------------------|-----------------|
| | | | | L | W | H | | | | |
| DMNG1-485FB-3K | .5 – 1.0 | Red | 3.2 | 22.6 | 7.4 | 6.1 | 4.8 x .5 | CD9-15A | CD-800-15 | 3000 |
| DMNG1-488FB-3K | | | 3.2 | 22.6 | 7.4 | 6.1 | 4.8 x .8 | | | 3000 |
| DMNG1-63FB-3K | | | 3.2 | 23.6 | 8.9 | 6.1 | 6.3 x .8 | | | 3000 |
| DMNG2-485FB-3K* | 1.5 – 2.5 | Blue | 3.9 | 22.6 | 7.4 | 6.1 | 4.8 x .5 | CD9-16A | CD-800-16 | 3000 |
| DMNG2-488FB-3K | | | 3.9 | 22.6 | 7.4 | 6.1 | 4.8 x .8 | | | 3000 |
| DMNG2-63FB-3K | | | 3.9 | 23.6 | 8.9 | 6.1 | 6.3 x .8 | | | 3000 |

*For #14 AWG wire applications, part to be used with copper alloy tabs only and is UL Recognized. For applicator information, see page D1.143.

® Metric Disco-Lok™ Female Disconnects, Nylon Fully Insulated – Funnel Entry



Type DMNG-FL

- Continuously molded design provides reliable, consistent performance through the applicator for a high quality termination every time
- Disconnect can be inserted and removed from the male tab without the use of tools for lower installed cost
- Unique locking mechanism design allows for low insertion forces (mating) and positive lock for high vibration applications where a secure connection is mandatory

- Fully insulated design provides protection from electrical shorts
- Flared barrel extension integrated into stamping to provide insulation grip for double crimp requirements
- Insulation housing moves back and forth to engage and disengage locking mechanism for repeated use
- Specialty tool required to install this disconnect (CT-1014)
- Mates with DNF-FIMB family

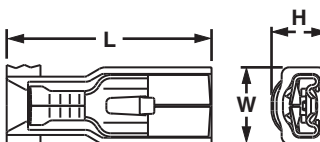

| Part Number | Wire Range (mm ²) | Color Code | Max. Ins. | Figure Dimensions (mm) | | | Tab Size (mm) | CA9 Series Crimp Die | CA-800 Series Crimp Die | Pieces Per Reel |
|---------------|-------------------------------|------------|-----------|------------------------|-----|-----|---------------|----------------------|-------------------------|-----------------|
| | | | | L | W | H | | | | |
| DMNG1-63FL-3K | .5 – 1.5 | Red | 3.2 | 24.6 | 9.1 | 6.1 | 6.3 x .8 | CD9-14A | CD-800-14 | 3000 |
| DMNG2-63FL-3K | 1.5 – 2.5 | Blue | 3.8 | 24.6 | 9.1 | 6.4 | 6.3 x .8 | CD9-14A | CD-800-14 | 3000 |

For applicator information, see page D1.143.



® Metric Female Disconnects, Nylon Fully Insulated – Funnel Entry



Type DMNF-FIB

- Continuously molded design provides reliable, consistent performance through the applicator for a high quality termination every time
- Disconnect can be inserted and removed from the male tab without the use of tools for lower installed cost

- Fully insulated design provides protection from electrical shorts
- Disconnects available in common industry tab sizes
- Internal wire stop assures proper length of insertion into terminal barrel, providing a higher quality connection

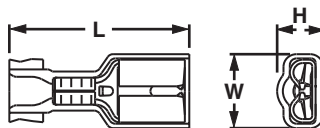

| Part Number | Wire Range (mm ²) | Color Code | Max. Ins. | Figure Dimensions (mm) | | | Tab Size (mm) | CA9 Series Crimp Die | CA-800 Series Crimp Die | Pieces Per Reel | |
|------------------|-------------------------------|------------|-----------|------------------------|------|------|---------------|----------------------|-------------------------|-----------------|----------|
| | | | | L | W | H | | | | | |
| DMNF1-283FIB-3K* | .5 – 1.0 | Natural | 3.0 | 18.0 | 4.8 | 3.8 | 2.8 x .3 | CD9-7A | CD-800-7 | 3000 | |
| DMNF1-285FIB-3K | | | 3.0 | 18.0 | 4.8 | 3.8 | 2.8 x .5 | | | 3000 | |
| DMNF1-288FIB-3K | | | 3.0 | 18.0 | 4.8 | 3.8 | 2.8 x .8 | | | 3000 | |
| DMNF1-485FIB-3K | | | Red | 3.4 | 19.8 | 7.4 | 4.1 | 4.8 x .5 | CD9-4A | CD-800-4 | 3000 |
| DMNF1-488FIB-3K | | | | 3.4 | 19.8 | 7.4 | 4.1 | 4.8 x .8 | | | 3000 |
| DMNF1-63FIB-3K | | | | 3.4 | 21.3 | 8.9 | 5.6 | 6.3 x .8 | | | 3000 |
| DMNF2-485FIB-3K | 1.5 – 2.5 | Blue | 4.0 | 19.8 | 7.4 | 4.6 | 4.8 x .5 | CD9-5A | CD-800-5 | 3000 | |
| DMNF2-488FIB-3K | | | 4.0 | 19.8 | 7.4 | 4.6 | 4.8 x .8 | | | 3000 | |
| DMNF2-63FIB-3K | | | 4.1 | 21.3 | 8.9 | 5.6 | 6.3 x .8 | | | 3000 | |
| DMNF6-63FIB-2K | | | 4.0 – 6.0 | Yellow | 5.6 | 24.4 | 8.9 | | | 5.8 | 6.3 x .8 |

*UL/CSA standards do not exist for 2.8mm x 0.3mm (.110" x .010") receptacles. For applicator information, see page D1.143.

- A. System Overview
- B1. Cable Ties
- B2. Cable Accessories
- B3. Stainless Steel Ties
- C1. Wiring Duct
- C2. Surface Raceway
- C3. Abrasion Protection
- C4. Cable Management
- D1. Terminals
- D2. Power Connectors
- D3. Grounding Connectors
- E1. Labeling Systems
- E2. Labels
- E3. Pre-Printed & Write-On Markers
- E4. Permanent Identification
- E5. Lockout/Tagout & Safety Solutions
- F. Index

A. System Overview



Metric Disco™ Female Disconnects, Nylon Fully Insulated – Expanded Wire Entry

B1. Cable Ties

Type DMNF-FIBX

- Continuously molded design provides reliable, consistent performance through the applicator for a high quality termination every time
- Expanded wire entry designed to accommodate wire with a larger insulation thickness
- Disconnect can be inserted and removed from the male tab without the use of tools for lower installed cost
- Fully insulated design provides protection from electrical shorts
- Disconnects available in common industry tab sizes
- Internal wire stop assures proper length of insertion into terminal barrel, providing a higher quality connection

B2. Cable Accessories

B3. Stainless Steel Ties

C1. Wiring Duct

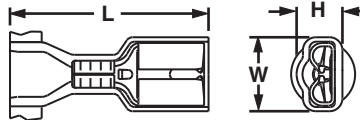

C2. Surface Raceway

C3. Abrasion Protection

C4. Cable Management

| Part Number | Wire Range (mm ²) | Color Code | Max. Ins. | Figure Dimensions (mm) | | | Tab Size (mm) | CA9 Series Crimp Die | CA-800 Series Crimp Die | Pieces Per Reel |
|-----------------|-------------------------------|------------|-----------|------------------------|-----|-----|---------------|----------------------|-------------------------|-----------------|
| | | | | L | W | H | | | | |
| DMNF1485FIBX-2K | .5 – 1.0 | Red | 5.3 | 22.1 | 7.9 | 5.5 | 5.2/4.8 x .5 | CD9-6B | CD-800-6 | 2000 |
| DMNF1488FIBX-2K | | | 5.3 | 22.1 | 7.9 | 5.5 | 5.2/4.8 x .8 | | | 2000 |
| DMNF1-63FIBX-2K | | | 5.3 | 23.6 | 8.9 | 5.5 | 6.3 x .8 | | | 2000 |
| DMNF2485FIBX-2K | 1.5 – 2.5 | Blue | 6.1 | 22.1 | 7.9 | 5.5 | 5.2/4.8 x .5 | CD9-8B | CD-800-8 | 2000 |
| DMNF2488FIBX-2K | | | 6.1 | 22.1 | 7.9 | 5.5 | 5.2/4.8 x .8 | | | 2000 |
| DMNF2-63FIBX-2K | | | 6.1 | 23.6 | 8.9 | 5.5 | 6.3 x .8 | | | 2000 |

For applicator information, see page D1.143.

D1. Terminals



Metric Disco™ Female Disconnects, Nylon Fully Insulated – Right Angle

D2. Power Connectors

Type DMNFR-FIB

- Continuously molded design provides reliable, consistent performance through the applicator for a high quality termination every time
- Right angle design for use in limited space applications
- Fully insulated design provides protection from electrical shorts
- Internal wire stop assures proper length of insertion into terminal barrel, providing a higher quality connection
- Disconnect can be inserted and removed from the male tab without the use of tools for lower installed cost
- Disconnects available in common industry tab sizes

D3. Grounding Connectors

E1. Labeling Systems

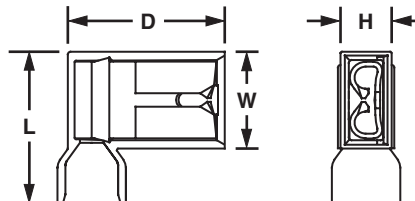

E2. Labels

E3. Pre-Printed & Write-On Markers

E4. Permanent Identification

E5. Lockout/Tagout & Safety Solutions

| Part Number | Wire Range (mm ²) | Color Code | Max. Ins. | Figure Dimension (mm) | | | | Tab Size (mm) | CA9 Series Crimp Die | CA-800 Series Crimp Die | Pieces Per Reel |
|-----------------|-------------------------------|------------|-----------|-----------------------|------|-----|-----|---------------|----------------------|-------------------------|-----------------|
| | | | | D | L | W | H | | | | |
| DMNFR1485FIB-KD | .5 – 1.0 | Red | 4.5 | 15.2 | 14.5 | 9.4 | 2.8 | 5.2/4.8 x .5 | CD9-9C | CD-800-9 | 1500 |
| DMNFR1488FIB-KD | | | 4.5 | 15.2 | 14.5 | 9.4 | 3.1 | 5.2/4.8 x .8 | | | 1500 |
| DMNFR163FIB-KD | | | 4.5 | 15.2 | 14.5 | 9.4 | 3.1 | 6.3 x .8 | | | 1500 |
| DMNFR2485FIB-KD | 1.5 – 2.5 | Blue | 4.5 | 15.2 | 14.5 | 9.4 | 2.8 | 5.2/4.8 x .5 | CD9-9C | CD-800-9 | 1500 |
| DMNFR2488FIB-KD | | | 4.5 | 15.2 | 14.5 | 9.4 | 3.1 | 5.2/4.8 x .8 | | | 1500 |
| DMNFR263FIB-KD | | | 4.5 | 15.2 | 14.5 | 9.4 | 3.1 | 6.3 x .8 | | | 1500 |

For applicator information, see page D1.143.

F. Index



Metric *Disco*™ Female Disconnects, Vinyl Barrel Insulated – Funnel Entry



Type DMV-B

- Continuously molded design provides reliable, consistent performance through the applicator for a high quality termination every time
- Disconnect can be inserted and removed from the male tab without the use of tools for lower installed cost
- Metal insulation grip sleeve crimps to wire insulation, providing protection to the crimp joint during high vibration applications
- Internal barrel serrations assure good wire contact and maximum tensile strength
- Internal wire stop assures proper length of insertion into terminal barrel, providing a higher quality connection

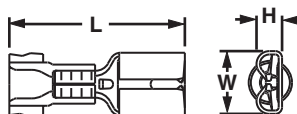

| Part Number | Wire Range (mm²) | Color Code | Max. Ins. | Figure Dimension (mm) | | | Tab Size (mm) | CA9 Series Crimp Die | CA-800 Series Crimp Die | Pieces Per Reel |
|--------------|------------------|------------|-----------|-----------------------|-----|-----|---------------|----------------------|-------------------------|-----------------|
| | | | | L | W | H | | | | |
| DMV1-485B-3K | .5 – 1.0 | Red | 4.06 | 19.3 | 5.8 | 2.5 | 4.8 x .5 | CD9-1A | CD-800-1 | 3000 |
| DMV1-488B-3K | | | 4.06 | 18.8 | 5.8 | 2.5 | 4.8 x .8 | CD9-2A | CD-800-2 | 3000 |
| DMV1-63B-3K | | | 4.06 | 21.1 | 7.4 | 3.0 | 6.3 x .8 | CD9-2A | CD-800-2 | 3000 |
| DMV2-485B-3K | 1.5 – 2.5 | Blue | 4.52 | 19.6 | 5.3 | 2.5 | 4.8 x .5 | CD9-2A | CD-800-2 | 3000 |
| DMV2-488B-3K | | | 4.52 | 19.6 | 5.3 | 2.5 | 4.8 x .8 | CD9-1A | CD-800-1 | 3000 |
| DMV2-63B-3K | | | 4.52 | 21.1 | 7.4 | 3.0 | 6.3 x .8 | CD9-2A | CD-800-2 | 3000 |
| DMV6-63-2K* | 4.0 – 6.0 | Yellow | 5.84 | 24.1 | 7.4 | 3.0 | 6.3 x .8 | CD9-3B | CD-800-8 | 2000 |

*Not UL Listed or CSA Certified.
For applicator information, see page D1.143.



Metric *DiscoGRIP*™ Female Disconnects, Fully Insulated – Funnel Entry



Type DMPF-FIB

- Continuously molded design provides reliable, consistent performance through the applicator for a high quality termination every time
- Disconnect can be inserted and removed from the male tab without the use of tools for lower installed cost
- Premium nylon insulation retains its shape when crimped and provides a tight grip around the wire insulation for maximum strain relief
- Fully insulated design provides protection from electrical shorts
- Internal wire stop assures proper length of insertion into terminal barrel, providing a higher quality connection
- Disconnects available in common industry tab sizes

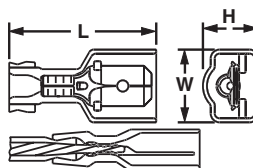

Cross section of *DiscoGRIP*™ Crimp showing insulation crimp of the wire insulation.

| Part Number | Wire Range (mm²) | Color Code | Max. Ins. | Figure Dimensions (mm) | | | Tab Size (mm) | CA9 Series Crimp Die | CA-800 Series Crimp Die | Pieces Per Reel |
|-----------------|------------------|------------|-----------|------------------------|-----|-----|---------------|----------------------|-------------------------|-----------------|
| | | | | L | W | H | | | | |
| DMPF1-285FIB-3K | .5 – 1.0 | Red | 3.4 | 18.0 | 4.8 | 4.3 | 2.8 x .5 | CD9-12A | CD-800-12 | 3000 |
| DMPF1-288FIB-3K | | | 3.4 | 18.0 | 4.8 | 4.3 | 2.8 x .8 | CD9-12A | CD-800-12 | 3000 |
| DMPF1-485FIB-3K | | | 3.4 | 19.8 | 7.9 | 4.3 | 4.8 x .5 | CD9-10A | CD-800-10 | 3000 |
| DMPF1-488FIB-3K | .5 – 1.5 | Red | 3.4 | 19.8 | 7.9 | 4.3 | 4.8 x .8 | CD9-10A | CD-800-10 | 3000 |
| DMPF1-63FIB-3K | | | 3.4 | 21.3 | 8.9 | 5.6 | 6.3 x .8 | CD9-13A | CD-800-13 | 3000 |
| DMPF2-485FIB-3K | 1.5 – 2.5 | Blue | 4.0 | 19.8 | 7.9 | 4.8 | 4.8 x .5 | CD9-11A | CD-800-11 | 3000 |
| DMPF2-488FIB-3K | | | 4.0 | 19.8 | 7.9 | 4.8 | 4.8 x .8 | CD9-11A | CD-800-11 | 3000 |
| DMPF2-63FIB-3K | | | 4.0 | 21.3 | 8.9 | 5.6 | 6.3 x .8 | CD9-11A | CD-800-11 | 3000 |
| DMPF6-63FIB-2K* | 4.0 – 6.0 | Yellow | 5.5 | 24.4 | 8.9 | 5.8 | 6.3 x .8 | CD9-13A | CD-800-13 | 2000 |

*Also approved for use with (2) 1.5 (#16) wires.
For applicator information, see page D1.143.

A. System Overview

B1. Cable Ties

B2. Cable Accessories

B3. Stainless Steel Ties

C1. Wiring Duct

C2. Surface Raceway

C3. Abrasion Protection

C4. Cable Management

D1. Terminals

D2. Power Connectors

D3. Grounding Connectors

E1. Labeling Systems

E2. Labels

E3. Pre-Printed & Write-On Markers

E4. Permanent Identification

E5. Lockout/Tagout & Safety Solutions

F. Index

A. System Overview



Metric *DISCOGRIP*™ Male Disconnects, Fully Insulated – Funnel Entry

B1. Cable Ties

Type DMPF-FIM

- Continuously molded design provides reliable, consistent performance through the applicator for a high quality termination every time
- Disconnect can be inserted and removed from the male tab without the use of tools for lower installed cost
- Fully insulated design provides protection from electrical shorts
- Premium nylon insulation retains its shape when crimped and provides a tight grip around the wire insulation for maximum strain relief

- Oversized housing designed for maximum versatility to mate with most commercially available fully insulated female disconnects
- Internal wire stop assures proper length of insertion into terminal barrel, providing a higher quality connection

B2. Cable Accessories

B3. Stainless Steel Ties

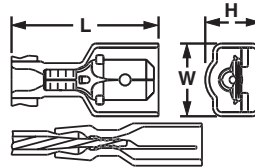

Cross section of *DISCOGRIP*™ Crimp showing insulation crimp of the wire insulation.

C1. Wiring Duct

C2. Surface Raceway

C3. Abrasion Protection

| Part Number | Wire Range (mm ²) | Color Code | Max. Ins. | Figure Dimensions (mm) | | | Tab Size (mm) | CA9 Series Crimp Die | CA-800 Series Crimp Die | Pieces Per Reel |
|-------------|-------------------------------|------------|-----------|------------------------|---|---|---------------|----------------------|-------------------------|-----------------|
| | | | | L | W | H | | | | |

Standard Housing

| | | | | | | | | | | |
|----------------|-----------|------|-----|------|------|-----|----------|---------|-----------|------|
| DMPF1-63FIM-2K | .5 – 1.5 | Red | 3.4 | 22.9 | 10.4 | 7.4 | 6.3 x .8 | CD9-10B | CD-800-10 | 2000 |
| DMPF2-63FIM-2K | 1.5 – 2.5 | Blue | 4.0 | 22.9 | 10.4 | 7.4 | 6.3 x .8 | CD9-11B | CD-800-11 | 2000 |

Oversized Housing

| | | | | | | | | | | |
|-----------------|-----------|------|-----|------|------|-----|----------|---------|-----------|------|
| DMPF1-63FIMB-K* | .5 – 1.5 | Red | 3.4 | 23.4 | 11.7 | 8.6 | 6.3 x .8 | CD9-10B | CD-800-10 | 1000 |
| DMPF2-63FIMB-K* | 1.5 – 2.5 | Blue | 4.1 | 23.4 | 11.7 | 8.6 | 6.3 x .8 | CD9-11B | CD-800-11 | 1000 |

*To mate with other manufacturers' fully insulated .250 x .032 female receptacles. For applicator information, see page D1.143.

C4. Cable Management

D1. Terminals

D2. Power Connectors



Metric *Disco*™ Male Disconnects, Nylon Fully Insulated – Funnel Entry

D3. Grounding Connectors

Type DMNF-FIM

- Continuously molded design provides reliable, consistent performance through the applicator for a high quality termination every time
- Male tab couples with (all .250 x .032) female disconnects
- Fully insulated design provides protection from electrical shorts

- Male tab can be inserted and removed from the female disconnect without the use of tools for lower installed cost
- Internal barrel serrations assure good wire contact and maximum tensile strength

E1. Labeling Systems

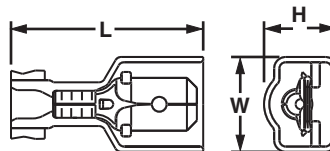

E2. Labels

E3. Pre-Printed & Write-On Markers

| Part Number | Wire Range (mm ²) | Color Code | Max. Ins. | Figure Dimensions (mm) | | | Tab Size (mm) | CA9 Series Crimp Die | CA-800 Series Crimp Die | Pieces Per Reel |
|-------------|-------------------------------|------------|-----------|------------------------|---|---|---------------|----------------------|-------------------------|-----------------|
| | | | | L | W | H | | | | |

Standard Housing

| | | | | | | | | | | |
|----------------|-----------|------|-----|------|------|-----|----------|--------|----------|------|
| DMNF1-63FIM-2K | .5 – 1.5 | Red | 3.4 | 22.9 | 10.7 | 7.5 | 6.3 x .8 | CD9-4B | CD-800-4 | 2000 |
| DMNF2-63FIM-2K | 1.5 – 2.5 | Blue | 4.0 | 22.9 | 10.7 | 7.5 | 6.3 x .8 | CD9-5B | CD-800-5 | 2000 |

Oversized Housing

| | | | | | | | | | | |
|-----------------|-----------|------|-----|------|------|-----|----------|--------|----------|------|
| DMNF1-63FIMB-K* | .5 – 1.0 | Red | 3.4 | 23.1 | 11.4 | 8.6 | 6.3 x .8 | CD9-4B | CD-800-4 | 1000 |
| DMNF2-63FIMB-K* | 1.5 – 2.5 | Blue | 4.1 | 23.1 | 11.7 | 8.4 | 6.3 x .8 | CD9-5B | CD-800-5 | 1000 |

*To mate with other manufacturers' fully insulated .250 x .032 female receptacles. For applicator information, see page D1.143.

E4. Permanent Identification

E5. Lockout/Tagout & Safety Solutions

F. Index



Metric *Disco*™ Male Disconnects, Nylon Fully Insulated – Expanded Wire Entry



Type DMNF-FIMX

- Continuously molded design provides reliable, consistent performance through the applicator for a high quality termination every time
- Expanded wire entry designed to accommodate wire with a larger insulation thickness
- Male tab couples with (all .250 x .032) female disconnects

- Fully insulated design provides protection from electrical shorts
- Male tab can be inserted and removed from the female disconnect without the use of tools for lower installed cost
- Internal barrel serrations assure good wire contact and maximum tensile strength

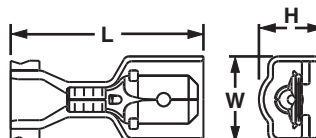

| Part Number | Wire Range (mm ²) | Color Code | Max. Ins. | Figure Dimensions (mm) | | | Tab Size (mm) | CA9 Series Crimp Die | CA-800 Series Crimp Die | Pieces Per Reel |
|-------------------|-------------------------------|------------|-----------|------------------------|------|-----|---------------|----------------------|-------------------------|-----------------|
| | | | | L | W | H | | | | |
| DMNF1-63FIMX-2K* | .5 – 1.0 | Red | 6.2 | 24.6 | 10.4 | 7.4 | 6.3 x .8 | CD9-8B | CD-800-8 | 2000 |
| DMNF2-63FIMX-2K** | 1.5 – 2.5 | Blue | 6.2 | 24.6 | 10.4 | 7.4 | 6.3 x .8 | CD9-8B | CD-800-8 | 2000 |

*CSA Certified for use with (2) #16 AWG or (2) #18 AWG wires.
 **CSA Certified for use with (2) #18 AWG, (2) #20 AWG, or (2) #22 AWG wires.
 For applicator information, see page D1.143.

Metric *Disco*™ Male Disconnects, Nylon Barrel Insulated – Funnel Entry



Type DMNF-M

- Continuously molded design provides reliable, consistent performance through the applicator for a high quality termination every time
- Male tab couples with (all .250 x .032) female disconnects
- Male tab can be inserted and removed from the female disconnect without the use of tools for lower installed cost

- Metal insulation grip sleeve crimps to wire insulation, providing protection to the crimp joint during high vibration applications
- Internal barrel serrations assure good wire contact and maximum tensile strength
- Maximum insulation temperature 221°F (105°C)

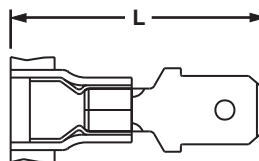

| Part Number | Wire Range (mm ²) | Color Code | Max. Ins. | Figure Dimensions (mm) | Tab Size (mm) | CA9 Series Crimp Die | CA-800 Series Crimp Die | Pieces Per Reel |
|---------------|-------------------------------|------------|-----------|------------------------|---------------|----------------------|-------------------------|-----------------|
| | | | | L | | | | |
| DMNF1-63M-3K | .5 – 1.0 | Red | 3.7 | 22.9 | 6.3 x .8 | CD9-1A | CD-800-1 | 3000 |
| DMNF2-63M-3K | 1.5 – 2.5 | Blue | 4.1 | 22.9 | 6.3 x .8 | CD9-2A | CD-800-2 | 3000 |
| DMNF6-63M-2K* | 4.0 – 6.0 | Yellow | 5.7 | 24.1 | 6.3 x .8 | CD9-3B | CD-800-3 | 2000 |

*Not CSA Certified.
 For applicator information, see page D1.143.

A. System Overview

B1. Cable Ties

B2. Cable Accessories

B3. Stainless Steel Ties

C1. Wiring Duct

C2. Surface Raceway

C3. Abrasion Protection

C4. Cable Management

D1. Terminals

D2. Power Connectors

D3. Grounding Connectors

E1. Labeling Systems

E2. Labels

E3. Pre-Printed & Write-On Markers

E4. Permanent Identification

E5. Lockout/Tagout & Safety Solutions

F. Index

A. System Overview



Metric Disco™ Male Disconnects, Vinyl Barrel Insulated – Funnel Entry

B1. Cable Ties

Type DMV-MB

- Continuously molded design provides reliable, consistent performance through the applicator for a high quality termination every time
- Male tab couples with (all .250 x .032) female disconnects
- Insulation support helps to prevent wire damage in bending applications
- Male tab can be inserted and removed from the female disconnect without the use of tools for lower installed cost

B2. Cable Accessories

B3. Stainless Steel Ties

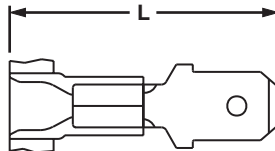

C1. Wiring Duct

C2. Surface Raceway

C3. Abrasion Protection

| Part Number | Wire Range (mm ²) | Color Code | Max. Ins. | Figure Dimension (mm) | | | CA9 Series Crimp Die | CA-800 Series Crimp Die | Pieces Per Reel |
|--------------|-------------------------------|------------|-----------|-----------------------|---------------|--|----------------------|-------------------------|-----------------|
| | | | | L | Tab Size (mm) | | | | |
| DMV1-63MB-3K | .5 – 1.5 | Red | 3.9 | 22.9 | 6.3 x .8 | | CD9-1A | CD-800-1 | 3000 |
| DMV2-63MB-3K | 1.5 – 2.5 | Blue | 4.5 | 22.9 | 6.3 x .8 | | CD9-2A | CD-800-2 | 3000 |
| DMV6-63M-2K* | 4.0 – 6.0 | Yellow | 6.1 | 24.4 | 6.3 x .8 | | CD9-3B | CD-800-3 | 2000 |

*DMV6-63M-2K is not CSA Certified.
For applicator information, see page D1.143.

C4. Cable Management

D1. Terminals



Metric Pin Terminals, Vinyl Insulated – Funnel Entry

D2. Power Connectors

Type PMV-P

- Continuously molded design provides reliable, consistent performance through the applicator for a high quality termination every time
- Solid pin designed to prevent damage to the wire from over tightening, resulting in a reliable electrical connection
- Insulation support helps to prevent wire damage in bending applications
- For use with pin-type terminal blocks

D3. Grounding Connectors

E1. Labeling Systems

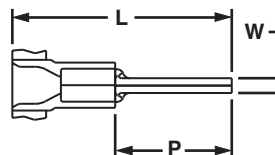

E2. Labels

E3. Pre-Printed & Write-On Markers

| Part Number | Wire Range (mm ²) | Color Code | Max. Ins. | Figure Dimensions (mm) | | | CA9 Series Crimp Die | CA-800 Series Crimp Die | Pieces Per Reel |
|--------------|-------------------------------|------------|-----------|------------------------|-----|------|----------------------|-------------------------|-----------------|
| | | | | L | W | P | | | |
| PMV1-P12B-3K | .5 – 1.5 | Red | 3.8 | 22.6 | 2.0 | 10.0 | CD9-1A | CD-800-1 | 3000 |
| PMV2-P12B-3K | 1.5 – 2.5 | Blue | 4.3 | 22.6 | 2.0 | 10.0 | CD9-2A | CD-800-2 | 3000 |

For applicator information, see page D1.143.

E4. Permanent Identification

E5. Lockout/Tagout & Safety Solutions

F. Index

Metric Male Blade Adapters, Vinyl Insulated – Funnel Entry



Type DMV-MB

- Continuously molded design provides reliable, consistent performance through the applicator for a high quality termination every time
- Flat blade design to prevent damage to the wire from over tightening, resulting in a reliable electrical connection

- For use with blade-type terminal blocks
- Insulation support helps to prevent wire damage in bending applications
- Brazed seam protects terminal barrel from splitting during the crimp process

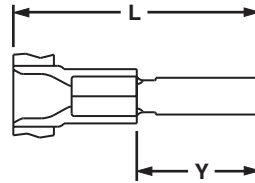

| Part Number | Wire Range (mm ²) | Color Code | Max. Ins. | Figure Dimensions (mm) | | Tab Size (mm) | CA9 Series Crimp Die | CA-800 Series Crimp Die | Pieces Per Reel |
|--------------|-------------------------------|------------|-----------|------------------------|------|---------------|----------------------|-------------------------|-----------------|
| | | | | L | Y | | | | |
| DMV1-37MB-3K | .5 – 1.5 | Red | 3.9 | 22.9 | 10.5 | 3.7 x 0.8 | CD9-1A | CD-800-1 | 3000 |
| DMV2-37MB-3K | 1.5 – 2.5 | Blue | 4.5 | 22.9 | 10.5 | 3.7 x 0.8 | CD9-2A | CD-800-2 | 3000 |

For applicator information, see page D1.143.

Metric Butt Splices, Nylon Insulated

Type BSMN, BSMP

- One-side machine applied termination replaces manual crimping
- Funnel entry on machine termination side to increase productivity
- Also hand crimped with *PANDUIT* CT-100, CT-1550, or CT-1551 crimping tools

- Barrel locating ribs provide for accurate hand tool placement
- Available with insulation crimp premium grade nylon
- Brazed seam with center wire stop for increased performance and productivity

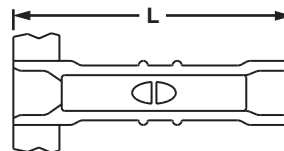

| Part Number | Wire Range (mm ²) | Color Code | Max. Ins. | Figure Dimension (mm) | CA9 Series Crimp Die | CA-800 Series Crimp Die | Pieces Per Reel |
|-------------|-------------------------------|------------|-----------|-----------------------|----------------------|-------------------------|-----------------|
| | | | | L | | | |
| BSMN1-3K | .5 – 1.5 | Red | 3.8 | 24.1 | CD9-1A | CD-800-1 | 3000 |
| BSMN2-3K | 1.5 – 2.5 | Blue | 4.3 | 24.1 | CD9-2A | CD-800-2 | 3000 |
| BSMN6-2K | 4.0 – 6.0 | Yellow | 5.8 | 24.1 | CD9-3B | CD-800-3 | 2000 |
| BSMP1-3K | .5 – 1.5 | Red | 3.8 | 24.1 | CD9-1A | CD-800-1 | 3000 |
| BSMP2-3K | 1.5 – 2.5 | Blue | 4.3 | 24.1 | CD9-2A | CD-800-2 | 3000 |

For applicator information, see page D1.143.



A. System Overview

B1. Cable Ties

B2. Cable Accessories

B3. Stainless Steel Ties

C1. Wiring Duct

C2. Surface Raceway

C3. Abrasion Protection

C4. Cable Management

D1. Terminals

D2. Power Connectors

D3. Grounding Connectors

E1. Labeling Systems

E2. Labels

E3. Pre-Printed & Write-On Markers

E4. Permanent Identification

E5. Lockout/Tagout & Safety Solutions

F. Index

A.
System
Overview

Features and Benefits – REEL SMART™ Ferrules

B1.
Cable Ties

PANDUIT ferrules are available in strips and reels for wiring applications from #20 – 14 AWG. Offerings include insulated ferrules in single wire configurations. These insulated ferrules are color-coded to DIN standards.

B2.
Cable
Accessories

Insulated Ferrules – Single Wire Type FS and FSD

B3.
Stainless
Steel Ties

Seamless tubular barrel provides consistent quality crimps

Maximum insulation temperature 192°F (89°C)

C1.
Wiring
Duct



Color-coded polypropylene identifies wire range

C2.
Surface
Raceway

C3.
Abrasion
Protection

C4.
Cable
Management

Part Number System for REEL SMART® Ferrules

D1.
Terminals

D2.
Power
Connectors

D3.
Grounding
Connectors

| | | | | | | | |
|-------------|------------|-----------------------|------------------------------|---|------------|--------------------------------------|--|
| F | S | D | 75 | — | 8 | 5K or DSL | 10 |
| Type | Wire Type | Color Code | Wire Size (mm ²) | | DIN Length | Std. Pkg. Size | Color-Code Number |
| F = Ferrule | S = Single | D = DIN = Standard | | | | 3K = 3,000 5K = 5,000 DSL = 50 | 0 = Black 2 = Red 3 = Orange 4 = Yellow 6 = Blue 7 = Light Blue 8 = Gray 10 = White |

E1.
Labeling
Systems

E2.
Labels

E3.
Pre-Printed
& Write-On
Markers

E4.
Permanent
Identification

E5.
Lockout/
Tagout/
& Safety
Solutions

F.
Index



Insulated Ferrules on Strips – Single Wire

Type FS

- Polypropylene insulation housing available in DIN standard colors in strips of 50
- Continuously molded design provides consistent placement of ferrules in tool to ensure fast, reliable terminations

- Available in #20 – 14 AWG featuring a seamless barrel design to contain loose wire strands for superior terminations
- Designed for use with the Semiautomatic Ferrule Crimping Tool CT-1000 for medium volume applications

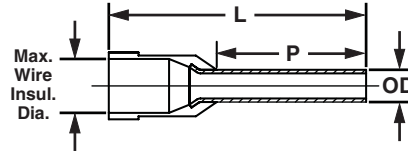
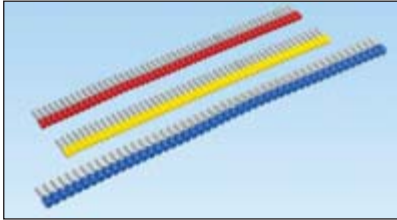

| Part Number | Wire Size | | Color Code | Max. Wire Insul. Dia. | | Figure Dimensions | | | | | | Wire Strip Length | | Recommended Installation Tool | Std. Pkg. Qty. | |
|---------------------------------------|-----------|-----------------|------------|-----------------------|-----|-------------------|------|-----|-----|-----|-----|-------------------|----|-------------------------------|----------------|--|
| | AWG | mm ² | | In. | mm | L | | P | | OD | | In. | mm | | | |
| DIN End Sleeves | | | | | | | | | | | | | | | | |
| FSD75-8-DSL10 | 20 AWG | .50 | White | .10 | 2.6 | .60 | 15.2 | .31 | 8.0 | .05 | 1.4 | 13/32 | 10 | CT-1000 | 500 | |
| FSD76-8-DSL8 | 18 AWG | .75 | Gray | .11 | 2.7 | .60 | 15.2 | .31 | 8.0 | .07 | 1.8 | 13/32 | 10 | | 500 | |
| FSD77-8-DSL2 | | 1.00 | Red | .12 | 3.0 | .60 | 15.2 | .31 | 8.0 | .08 | 2.1 | 13/32 | 10 | | 500 | |
| FSD78-8-DSL0 | 16 AWG | 1.50 | Black | .13 | 3.2 | .60 | 15.2 | .31 | 8.0 | .10 | 2.6 | 13/32 | 10 | | 500 | |
| FSD80-8-DSL6 | 14 AWG | 2.50 | Blue | .16 | 4.0 | .60 | 15.2 | .31 | 8.0 | .10 | 2.6 | 13/32 | 10 | | 500 | |
| Additional Colored End Sleeves | | | | | | | | | | | | | | | | |
| FS75-8-DSL3 | 20 AWG | .50 | Orange | .10 | 2.6 | .60 | 15.2 | .31 | 8.0 | .05 | 1.4 | 13/32 | 10 | CT-1000 | 500 | |
| FS76-8-DSL10 | 18 AWG | .75 | White | .11 | 2.7 | .60 | 15.2 | .31 | 8.0 | .06 | 1.6 | 13/32 | 10 | | 500 | |
| FS76-8-DSL7 | | | Light Blue | .11 | 2.7 | .60 | 15.2 | .31 | 8.0 | .06 | 1.6 | 13/32 | 10 | | 500 | |
| FS77-8-DSL4 | | 1.00 | Yellow | .12 | 3.0 | .60 | 15.2 | .31 | 8.0 | .07 | 1.8 | 13/32 | 10 | | 500 | |
| FS78-8-DSL2 | 16 AWG | 1.50 | Red | .13 | 3.2 | .60 | 15.2 | .31 | 8.0 | .08 | 2.1 | 13/32 | 10 | | 500 | |
| FS80-8-DSL8 | 14 AWG | 2.50 | Gray | .16 | 4.0 | .60 | 15.2 | .31 | 8.0 | .10 | 2.6 | 13/32 | 10 | | 500 | |

A. System Overview

B1. Cable Ties

B2. Cable Accessories

B3. Stainless Steel Ties

C1. Wiring Duct

C2. Surface Raceway

C3. Abrasion Protection

C4. Cable Management

D1. Terminals

D2. Power Connectors

D3. Grounding Connectors

E1. Labeling Systems

E2. Labels

E3. Pre-Printed & Write-On Markers

E4. Permanent Identification

E5. Lockout/Tagout & Safety Solutions

F. Index

A. System Overview



Semiautomatic Ferrule Crimping Tool – CT-1000

B1. Cable Ties

- Innovative rapid load design utilizes continuously molded ferrules to significantly reduce installation time
- Adjustable die setting allows termination of all *PANDUIT* #20 – 14 AWG continuously molded ferrules with a single tool
- Controlled cycle tool cuts, strips, and crimps wire to maximize efficiency

B2. Cable Accessories



| Part Number | Part Description | Std. Pkg. Qty. |
|----------------|---|----------------|
| CT-1000 | Crimps <i>PANDUIT</i> #20 – 14 AWG continuously molded ferrules on strips. Also cuts and strips wire. | 1 |

B3. Stainless Steel Ties

C1. Wiring Duct

C2. Surface Raceway



Insulated Ferrules on Reels – Single Wire

Type FS

C3. Abrasion Protection

- Polypropylene insulation housing available in DIN standard colors in reels of 3000 and 5000
- Continuously molded design provides consistent placement of ferrules in applicator to ensure fast, reliable terminations
- Designed specifically for use with the Ferrule Applicator (CA10) for high volume applications
- Available in #20 – 14 AWG featuring a seamless barrel design to contain loose wire strands for superior terminations

C4. Cable Management

D1. Terminals

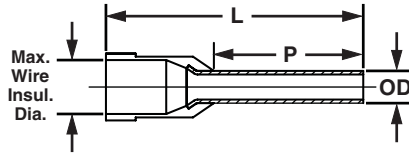

D2. Power Connectors

D3. Grounding Connectors

| Part Number | Wire Size | | Color Code | Max. Wire Insul. Dia. | | Figure Dimensions | | | | | | Wire Strip Length | | CA10 Series Dies | Pieces Per Reel |
|-------------|-----------|-----------------|------------|-----------------------|----|-------------------|--|---|--|----|--|-------------------|----|------------------|-----------------|
| | AWG | mm ² | | In. | mm | L | | P | | OD | | In. | mm | | |

DIN End Sleeves

| | | | | | | | | | | | | | | | |
|---------------------|--------|------|-------|-----|-----|-----|------|-----|-----|-----|-----|-------|----|--------|------|
| FSD75-8-5K10 | 20 AWG | .50 | White | .10 | 2.6 | .57 | 14.5 | .31 | 8.0 | .05 | 1.4 | 13/32 | 10 | CD10-1 | 5000 |
| FSD76-8-5K8 | 18 AWG | .75 | Gray | .11 | 2.7 | .57 | 14.5 | .31 | 8.0 | .06 | 1.6 | 13/32 | 10 | | 5000 |
| FSD77-8-5K2 | 18 AWG | 1.00 | Red | .12 | 3.0 | .57 | 14.5 | .31 | 8.0 | .07 | 1.8 | 13/32 | 10 | CD10-2 | 5000 |
| FSD78-8-5K0 | 16 AWG | 1.50 | Black | .13 | 3.2 | .57 | 14.5 | .31 | 8.0 | .08 | 2.1 | 13/32 | 10 | | 5000 |
| FSD80-8-3K6 | 14 AWG | 2.50 | Blue | .16 | 4.0 | .57 | 14.5 | .31 | 8.0 | .10 | 2.6 | 13/32 | 10 | CD10-3 | 3000 |

Additional Colored End Sleeves

| | | | | | | | | | | | | | | | |
|--------------------|--------|------|------------|-----|-----|-----|------|-----|-----|-----|-----|-------|----|--------|------|
| FS75-8-5K3 | 20 AWG | .50 | Orange | .10 | 2.6 | .57 | 14.5 | .31 | 8.0 | .05 | 1.4 | 13/32 | 10 | CD10-1 | 5000 |
| FS76-8-5K10 | 18 AWG | .75 | White | .11 | 2.7 | .57 | 14.5 | .31 | 8.0 | .06 | 1.6 | 13/32 | 10 | | 5000 |
| FS76-8-5K7 | 18 AWG | .75 | Light Blue | .11 | 2.7 | .57 | 14.5 | .31 | 8.0 | .06 | 1.6 | 13/32 | 10 | | 5000 |
| FS77-8-5K4 | 18 AWG | 1.00 | Yellow | .12 | 3.0 | .57 | 14.5 | .31 | 8.0 | .07 | 1.8 | 13/32 | 10 | CD10-2 | 5000 |
| FS78-8-5K2 | 16 AWG | 1.50 | Red | .13 | 3.2 | .57 | 14.5 | .31 | 8.0 | .08 | 2.1 | 13/32 | 10 | | 5000 |
| FS80-8-3K8 | 14 AWG | 2.50 | Gray | .16 | 4.0 | .57 | 14.5 | .31 | 8.0 | .10 | 2.6 | 13/32 | 10 | CD10-3 | 3000 |

E1. Labeling Systems

E2. Labels

E3. Pre-Printed & Write-On Markers

E4. Permanent Identification

E5. Lockout/Tagout & Safety Solutions

F. Index



REEL SMART™ Ferrule Applicator – CA10

- Designed for use with continuously molded ferrules in reels of 3,000 or 5,000 for high volume applications
- Precision ferrule indexing through applicator for optimum reliability and productivity
- Universal base plate allows compatibility with the *PANDUIT* CP-871 electric press, and other commercially available bench presses and automatic wire processing (AWP) machines

- Quick change die sets terminate the entire ferrule line to provide fast product change over and reduction in setup time; dies sold separately



| Part Number | Part Description | Std. Pkg. Qty. |
|-------------|--|----------------|
| CA10 | Applicator used to terminate entire line of <i>REEL SMART™</i> Continuously Molded Ferrules on reels. For use with CP-871 Electric Press and CD10 series die sets. | 1 |
| CD10-1 | Die insert to be used with the CA10 applicator to terminate FS75, FSD75, FS76 and FSD76 <i>REEL SMART™</i> Continuously Molded Ferrules. | 1 |
| CD10-2 | Die insert to be used with the CA10 applicator to terminate FS77, FSD77, FS78 and FSD78 <i>REEL SMART™</i> Continuously Molded Ferrules. | 1 |
| CD10-3 | Die insert to be used with the CA10 applicator to terminate FS80 and FSD80 <i>REEL SMART™</i> Continuously Molded Ferrules. | 1 |

CA9 EZAIR™ and CA-800EZ Applicators

- Designed to terminate all continuously molded terminals, disconnects, and splices in reels of 3,000 or 5,000 for high volume applications
- Precision terminal indexing through applicator for optimum reliability and productivity

- Universal base plate allows compatibility with the *PANDUIT* CP-871 electric press, and other commercially available bench presses and automatic wire processing (AWP) machines
- Quick change die sets allow for fast product change over and reduction in setup time; dies sold separately



| Part Number | Part Description | Std. Pkg. Qty. |
|-------------|---|----------------|
| CA-800EZ* | Applicator: runs in the AMP* Model T and K bench presses. True "quick change" applicator — no additional plates are necessary. Slide right into the press for easy changeover. Uses CD-800 series die inserts. | 1 |
| CA9 | <i>CA9 EZAIR™</i> Applicator: terminates the entire <i>REEL SMART™</i> product line. This greatly reduces set up and maintenance time and increases productivity. This patented applicator is so smart it automatically adjusts feed stroke to the correct pitch and length for the entire product line. Crimp die changeover in less than 1 minute, minimizes downtime and increases productivity. Fast, easy loading of terminal parts without special instructions or setup personnel. Simply feed the parts strip into the applicator. All the necessary adjustments are made by the dies and the automatic feed stroke. Used in CP-871 electric press. Safety lockout guard ensures operator safety. Positive stop adjustment rings allow for electrical and insulation crimp adjustments as desired. | 1 |

*AMP is a registered trademark of Tyco Electronics.
For crimp die information, refer to pages D1.145 and D1.146.

A.
System
Overview

B1.
Cable Ties

B2.
Cable
Accessories

B3.
Stainless
Steel Ties

C1.
Wiring
Duct

C2.
Surface
Raceway

C3.
Abrasion
Protection

C4.
Cable
Management

D1.
Terminals

D2.
Power
Connectors

D3.
Grounding
Connectors

E1.
Labeling
Systems

E2.
Labels

E3.
Pre-Printed
& Write-On
Markers

E4.
Permanent
Identification

E5.
Lockout/
Tagout
& Safety
Solutions

F.
Index

A.
System
Overview



Electric Bench Press

B1.
Cable Ties

- For use with *PANDUIT* Universal Applicators and *REEL SMART™* Continuously Molded Terminals and Ferrules to provide a superior solution for quality, high volume terminations

- Tool crimp height adjustment feature allows user to easily set and maintain desired crimp height for consistent performance

B2.
Cable
Accessories

- CP-871 press has a microprocessor based controller and LCD that displays text messages and cycle count with multi-language capability

- Applicator can be changed without the use of tools to facilitate faster changeover for lower cost of ownership

B3.
Stainless
Steel Ties



C1.
Wiring
Duct

| Part Number | Part Description | Std. Pkg. Qty. |
|---------------|--|----------------|
| CP-871 | Electric press: 4000+ terminations per hour. Operates on 110 VAC current/60 Hz, 220 VAC current/50 Hz (field convertible). Overall size (without reel): 13" x 33" x 16". Total weight (without reel): 176 lbs. Includes foot pedal. | 1 |

C2.
Surface
Raceway

C3.
Abrasion
Protection

C4.
Cable
Management

Die Sharpening Kits

- Used to resharpen cutting edges and maintain reliability of CD-800 and CD9 series cutter dies

D1.
Terminals

| Part Number | Part Description | Std. Pkg. Qty. |
|---------------|---|----------------|
| DSF-RS | For use with black oxide cutter dies. | 1 |
| DSF-NP | For use with nickel-plated cutter dies. | 1 |

D2.
Power
Connectors

D3.
Grounding
Connectors

E1.
Labeling
Systems

E2.
Labels

E3.
Pre-Printed
& Write-On
Markers

E4.
Permanent
Identification

E5.
Lockout/
Tagout/
& Safety
Solutions

F.
Index

Die Information

| Part Number | AWG Wire Range | Color Code | (1) Wire Insulation Strain Relief | Part No. Prefix | 60/40 Solder Slug Dia. | | Spare Part Number | | |
|--------------|---|-----------------------|--|--|------------------------|------|--------------------------------|------------------------------|-------------------------|
| | | | | | In. | mm | Crimp Die | Cutter Die | Lower Die |
| CD-800-1 | 22 – 18/ 22 – 16/ 22 – 18/ 22 – 16 | Red | Plastic Ins. Crimp/ Insulation Support/ Metal Ins. Crimp/ Plastic Ins. Crimp | PV, DV-MB, DV-B/BSN/ PN, PNF, DNF-M/ BSP (Premium Nylon) | | | TD13471C06 CD-800 -1 | TD13483C02 CD-800 C-1 | TD17755B01 CD-1 |
| CD-800-1D*** | 22 – 18 | | | | | | | | |
| CD-800-2 | 16 – 14/ 18 – 14/ 16 – 14/ 18 – 14 | Blue | Plastic Ins. Crimp/ Insulation Support/ Metal Ins. Crimp/ Plastic Ins. Crimp | PV, DV-MB, DV-B/BSN/ PN, PNF, DNF-M/ BSP (Premium Nylon) | | | TD13473C05 CD-800 -2 | TD13486C03 CD-800 C-2 | TD17756B01 C-2 |
| CD-800-2D*** | 16 – 14 | | | | | | | | |
| CD-800-3 | 12 – 10/ 14 – 10/ 16 – 12/ 16 – 12/ 12 – 10 | Yellow | Plastic Ins. Crimp/ Plastic Ins. Crimp/ Metal Ins. Crimp/ Plastic Ins. Crimp/ Metal Ins. Crimp | PV, PV12, DV/ DV-C/PN12/PV12/ DV-M, PN, PNF, DNF-M | .188 | 4.78 | TD13475C06 CD-800 -3 | TD13489C02 CD-800 C-3 | TD17757B01 C-3 |
| CD-800-4 | 12 – 18 | Red | Insulation Support | DNF-FIB, DNF-FIM, DNF-FIMB, DNF-LPB | | | TD13833C06 CD-800 -4, 10 | TD13505C02 CD-800 C-4 | TD17758B01 C-4, 10 |
| CD-800-5 | 16 – 14 | Blue | Insulation Support | DNF-FIB, DNF-FIM, DNF-FIMB, DNF-LPB | | | TD13634C05 CD-800 -5, 11 | TD13508C02 CD-800 C-5 | TD17759B01 C-5, 11 |
| CD-800-6 | 22 – 18 | Red | Insulation Support | DNF-FIBX | | | TD13652C04 CD-800 -6 | TD13499C02 CD-800 C-6 | TD17760B01 C-6 |
| CD-800-7 | 22 – 18 | Red | Insulation Support | DNF-110FIB, DNF-111FIB, DNF-112FIB | .125 | 3.18 | TD13477C05 CD-800 -7, 12 | TD13492C03 CD-800 C-7 | TD17761B01 C-7, 12 |
| CD-800-8 | 16 – 14/ 22 – 18/ 16 – 14 | Blue/ Red/ Blue | Insulation Support | DNF-FIBX/DNF-FIMX/ DNF-FIMX | .188 | 4.78 | TD13481C06 CD-800 -8 | TD13502C03 CD-800 C-8 | TD17762B01 C-8 |
| CD-800-9 | 22 – 14 | Red/ Blue | Insulation Support | DNFR-FIB | .125 | 3.18 | TD13479C05 CD-800 -9 | TD13495C02 CD-800 C-9 | TD17763B01 C-9 |
| CD-800-10 | 22 – 18 | Red | <i>DISCOGRIP</i> ™ Insulation Crimp | DPF-FIB, DPF-FIM, DPF-FIMB, DPF-LPB | .188 | 4.78 | TD13633C06 CD-800 -4, 10 | TD16233C02 CD-800 C-10 | TD17758B01 C-4, 10 |
| CD-800-11 | 16 – 14 | Blue | <i>DISCOGRIP</i> ™ Insulation Crimp | DPF-FIM, DPF-FIMB/ DPF-FIB, DPF-LPB | | | TD13634C05 CD-800 -5, 10 | TD16243C01 CD-800 C-11 | TD17759B01 CD-5, 11 |
| CD-800-12 | 22 – 18 | Red | <i>DISCOGRIP</i> ™ Insulation Crimp | DPF-110FIB, DPF-111FIB | .125 | 3.18 | TD13477C05 CD-800 -7, 12 | TD16235C02 CD-800 C-12 | TD17761B01 C-7, 12 |
| CD-800-13 | 12 – 10 | Yellow | Insulation Support/ <i>DISCOGRIP</i> ™ Insulation Crimp | DNF-FIB/DPF-FIB | .188 | 4.78 | TD19116C03 CD-800 -13 | TD19115C05 CD-800 C-13 | TD19424B01 C-13 |
| CD-800-14 | 22 – 18/ 16 – 14 | Red/ Blue | Metal Insulation Crimp | DNG-FL | .125 | 3.18 | TD22943C01 CD-800 -14 | TD22944C01 CD-800 C-14 | TD22960B01 C-14 |
| CD-800-15 | 22 – 18 | Red | Metal Insulation Crimp | DNG-FB | .188 | 4.78 | TD22945C01 CD-800 -15 | TD22946C01 CD-800 C-15 | TD22961B01 C-15 |
| CD-800-16 | 16 – 14 | Blue | Metal Insulation Crimp | DNG-FB | | | TD22947C01 CD-800 -16 | TD22948C01 CD-800 C-16 | TD22962B01 C-16 |
| CD-800-17 | 12 – 10 | Yellow | Insulation Support | BSN | | | TD23601C01 CD-800-17 | TD23600C01 CD-800-17 | TD23612B01 CD-800-17 |
| CD-800-18 | 12 – 10 | Yellow | Plastic Insulation Crimp | DNF-FIMB | | | TD13475C06 CD-800-18 | TD23773C01 CD-800-18 | TD17757B01 CD-800-18 |

TA13721A01 = 60/40 Solder Slug with 1/8" (.125) outer diameter.

TA13722A01 = 60/40 Solder Slug with 3/16" (.188) outer diameter.

(1) Insulation Support: Minimum wire insulation strain relief for normal applications.

Plastic and *DISCOGRIP*™ Insulation Crimp: Secondary wire insulation strain relief for high vibration or conductor strain applications.

Metal Insulation Grip: Maximum wire insulation strain relief for high vibration or conductor strain applications.

***Modified lower die for barrel insulated disconnects DV-B series. Available as a complete die set or just lower die assembly.

Table continues on page D1.146.

A. System Overview

Die Information (continued)

| Part Number | Color Code | AWG Wire Range | Wire Insulation Strain Relief | Part No. Prefix | 60/40 Solder Slug Dia. | | Spare Part Number | | |
|-------------------|-----------------------|---|---|--|------------------------|------|-------------------|------------|--------------------------|
| | | | | | In. | mm | Crimp Die | Cutter Die | Lower Die |
| CD9-1A | Red | 22 – 16/ 22 – 16/ 22 – 18/ 22 – 18 | Insulation Support/ Plastic Ins. Crimp/ Plastic Ins. Crimp/ Metal Ins. Grip | BSN/BSP/PV, DV-B,DV-MB/PN, PNF, DNF-M | .188 | 4.78 | TD24129C01 | TD24139C01 | TD24149C01 |
| CD9-1AD*** | | 22–18 | Plastic Insulation Crimp Metal Insulation Grip | PV, DV-B, DV-MB, PN, PNF, DNF-M | .188 | 4.78 | | | |
| CD9-1B | | 22 – 18 | Plastic Insulation Crimp | PV-56R, PV-38R | .188 | 4.78 | | | |
| CD9-2A | Blue | 18 – 14/ 18 – 14/ 16 – 14/ 16 – 14/ 16 – 14 | Insulation Support/ Plastic Ins. Crimp/ Insulation Support/ Plastic Ins. Crimp/ Metal Ins. Grip | BSN/BSP/BSN/PV, DV-B, DV-MB/PN, PNF, DNF-M | .188 | 4.78 | TD24130C01 | TD24140C01 | TD23712C01 |
| CD9-2AD*** | | 16–14 | Insulation Support Plastic Insulation Crimp Metal Insulation Grip | BSN, PV, DV-B, DV-MB, PN, PNF, DNF-M | .188 | 4.78 | | | |
| CD9-2B | | 16 – 14 | Plastic Insulation Crimp | PV-56R, PV-38R | .188 | 4.78 | | | |
| CD9-3B | Yellow | 12 – 10/ 12 – 10/ 16 – 12 | Plastic Ins. Crimp/ Metal Ins. Grip/ Plastic Ins. Crimp | PV, DV, DV-M/PN, PNF, DNF-M/PV12, PN12 | .188 | 4.78 | TD24131C01 | TD24141C01 | TD23713C01 |
| CD9-4A | Red | 22 – 18 | Insulation Support | DNF-FIB, DNF-LPB | .188 | 4.78 | TD24132C01 | TD24142C01 | TD24150C01 |
| CD9-4B | | 22 – 18 | Insulation Support | DNF-FIM, DNF-FIMB | .188 | 4.78 | | | |
| CD9-5A | Blue | 16 – 14 | Insulation Support | DNF-FIB, DNF-LPB | .188 | 4.78 | TD24133C01 | TD24143C01 | TD24151C01 |
| CD9-5B | | 16 – 14 | Insulation Support | DNF-FIM, DNF-FIMB | .188 | 4.78 | | | |
| CD9-6B | Red | 22 – 18 | Insulation Support | DNF-FIBX | .188 | 4.78 | TD23700C01 | TD23683C01 | TD23716C01 |
| CD9-7A | Red | 22 – 18 | Insulation Support | DNF-110/111/112FIB | .125 | 3.18 | TD23701C02 | TD23684C01 | TD23717C01 |
| CD9-8B | Blue/ Red/ Blue | 16 – 14/ 22 – 14 | Insulation Support/ Insulation Support | DNF-FIBX/ DNF-FIMX | .188 | 4.78 | TD23702C01 | TD23685C01 | TD23718C01 |
| CD9-9C | Red/ Blue | 22 – 14 | Insulation Support | DNFR-FIB | .125 | 3.18 | TD23703C01 | TD23686C01 | TD23719C01 |
| CD9-10A | Red | 22 – 18 | <i>DISCOGRIP™</i> Insulation Crimp | DPF-FIB, DPF-LPB | .188 | 4.78 | TD24132C01 | TD24144C01 | TD24150C01 |
| CD9-10B | Red | 22 – 18 | <i>DISCOGRIP™</i> Insulation Crimp | DPF-FIM, DPF-FIMB | .188 | 4.78 | | | |
| CD9-11A | Blue | 16 – 14 | <i>DISCOGRIP™</i> Insulation Crimp | DPF-FIB, DPF-LPB | .188 | 4.78 | TD24133C01 | TD23688C01 | TD24151C01 |
| CD9-11B | Blue | 16 – 14 | <i>DISCOGRIP™</i> Insulation Crimp | DPF-FIM, DPF-FIMB | .188 | 4.78 | | | |
| CD9-12A | Red | 22 – 18 | <i>DISCOGRIP™</i> Insulation Crimp | DPF-110FIB, DFP-111FIB | .125 | 3.18 | TD23701C02 | TD23689C01 | TD23717C01 |
| CD9-13B | Yellow | 12 – 10 | Insulation Support/ <i>DISCOGRIP™</i> Insulation Crimp | DNF-FIB/DPF-FIB | .188 | 4.78 | TD24134C01 | TD24145C01 | TD24152C01 |
| CD9-14A | Red/ Blue | 22 – 18/ 16 – 14 | Metal Insulation Grip | DNG-FL | .125 | 3.18 | TD23705C01 | TD23691C01 | TD23721C01 |
| CD9-15A | Red | 22 – 18 | Metal Insulation Grip | DNG-FB | .188 | 4.78 | TD24135C01 | TD24146C01 | TD24153C01 |
| CD9-16A | Blue | 16 – 14 | Metal Insulation Grip | DNG-FB | .188 | 4.78 | TD24136C01 | TD24147C01 | TD24154C01 |
| CD9-17B | Yellow | 12 – 10 | Insulation Support | BSN | .188 | 4.78 | TD24110C01 | TD24109C01 | TD24111C01 TD24112C01 |
| CD9-18B | Yellow | 12 – 10 | Insulation Support | DNF-FIMB | .188 | 4.78 | TD24131C01 | TD23766C01 | TD23713C01 |
| CD10-1 | — | 20 – 18 | Insulation Support | FS75, FSD75, FS76, FSD76 | — | — | — | — | — |
| CD10-2 | — | 18 – 16 | Insulation Support | FS77, FSD77, FS78, FSD78 | — | — | — | — | — |
| CD10-3 | — | 14 | Insulation Support | FS80, FSD80 | — | — | — | — | — |

TA13721A01 = 60/40 Solder Slug with 1/8" (.125) outer diameter.

TA13722A01 = 60/40 Solder Slug with 3/16" (.188) outer diameter.

(1) Insulation Support: Minimum wire insulation strain relief for normal applications.

Plastic and *DISCOGRIP™* Insulation Crimp: Secondary wire insulation strain relief for high vibration or conductor strain applications.

Metal Insulation Grip: Maximum wire insulation strain relief for high vibration or conductor strain applications.

***Modified lower die for barrel insulated disconnects DV-B series. Available as a complete die set or just lower die assembly.

CA10, CA9 EZAIR™, CA-800EZ and CA-800 Applicators Wire Processing Machine Manufacturer/Press Compatibility

| Manufacturer | Wire Processing Machine with (WPM) or Bench Press Only | CA10 | PANDUIT Applicators | | |
|------------------------|--|------------------|--|--|---------|
| | | | CA9 EZAIR™ | CA-800EZ* | CA-800* |
| PANDUIT | CP-851 bench press only CP-861 bench press only CP-862 bench press only CP-871 bench press only | A | A ¹ A ¹ | A A | A A |
| AMP | CLS III G with G press (AWP) CLS IV with G press (AWP) CLS IV G plus with G press (AWP) G bench press only CLS II with T press (AWP) CLS III with T press (AWP) T bench press only K bench press only | A A A A | A ¹ A ¹ A ¹ A ¹ A ¹ A ¹ A ³ | A A | |
| ARTOS | CS-600 with AMP G press (AWP) CS-600 with TU7M press (AWP) CS-600 with TU-10 press (AWP) MTX Series 5 with TU-10 press (AWP) | A | A ¹ A ¹ A ¹ | A | |
| GAMMA MECCANICA | T20P-110V bench press only | | A ¹ | | |
| KODERA | Series C451/C450 (AWP) Series C551/C550 (AWP) | A | A ¹ A ¹ | | |
| KOMAX | Gamma 311 with Mecal K300 press (AWP) Gamma 333 with mci 711 press (AWP) Alpha 411 with Mecal PE7 or P107 press (AWP) Alpha 433 with Mecal PE7 or P107 press (AWP) 40T with Mecal PE7 press (AWP) 40T with PANDUIT CP-861 press (AWP) bt711 bench press only | A | A ¹ A ¹ A ¹ A ¹ A ¹ | A ² A ² A ⁴ | A |
| MEGOMAT | AMS 3001A / APE 300 press (AWP) Contact (AWP) Primo with MP-3.0 press (AWP) | | A ¹ A ¹ A ¹ | | |
| MOLEX | EP-20 bench press only TM-2000 bench press only | | | A A | |
| SCHLEUNIGER | Crimp center 12 with ACP01 press (AWP) Crimp center 64 (AWP) UC-200 bench press | A A | A ¹ A ¹ A ¹ | A | |
| SHINMAYWA | TR101 (AWP) TRD111 / TR111 (AWP) | | A ¹ | A A | |

A = Compatible with Press.

- Special Requirements:
- *Refer to the specific applicator operation manual for installation instructions.
 - ¹ See specific section of installation manual for details.
 - ² Komax press shim is required to operate CA-800EZ Applicator.
 - ³ Bench press air feed capability is required.
 - ⁴ Remove press wire stripper.

A.
System
Overview

B1.
Cable Ties

B2.
Cable
Accessories

B3.
Stainless
Steel Ties

C1.
Wiring
Duct

C2.
Surface
Raceway

C3.
Abrasion
Protection

C4.
Cable
Management

D1.
Terminals

D2.
Power
Connectors

D3.
Grounding
Connectors

E1.
Labeling
Systems

E2.
Labels

E3.
Pre-Printed
& Write-On
Markers

E4.
Permanent
Identification

E5.
Lockout/
Tagout
& Safety
Solutions

F.
Index

A.
System
Overview

Performance Requirements

B1.
Cable Ties

| | Wire Size (AWG) | | | | | | | |
|--|-----------------|-----|-----|-----|-----|-----|-----|-----|
| | #26 | #24 | #22 | #20 | #18 | #16 | #14 | #12 |

UL 486A (Terminals), UL 310 (Male Blade Adapters)

| | | | | | | | | | |
|---------------------------------------|-----|---|---|----|----|----|----|----|----|
| Test current for max. 50° rise (amps) | 3.5 | 7 | 9 | 12 | 17 | 18 | 30 | 35 | 50 |
| Min. tensile strength* (lbs.) | 3 | 5 | 8 | 13 | 20 | 30 | 50 | 70 | 80 |

UL 486C (Splices)

| | | | | | | | | | |
|--|-----|---|---|----|----|----|----|----|----|
| Test current for max. 50°C rise (amps) | 5.5 | 7 | 9 | 12 | 17 | 18 | 30 | 35 | 50 |
| Min. tensile strength* (lbs.) | 3 | 5 | 8 | 10 | 10 | 15 | 25 | 35 | 40 |

*Pull-out force of the crimped terminal.

C1.
Wiring
Duct

C2.
Surface
Raceway

| | Wire Size (AWG) | | | | | | |
|--|-----------------|-----|-----|-----|-----|-----|-----|
| | #22 | #20 | #18 | #16 | #14 | #12 | #10 |

UL 310 (Disconnects)

| | | | | | | | |
|--|---|---|---|----|----|----|----|
| Continuous test current for max. 30°C rise (amps) (for .187", .205", .250" tab widths) | 3 | 4 | 7 | 10 | 15 | 20 | 24 |
|--|---|---|---|----|----|----|----|

| | | | | | | | |
|---|---|---|---|---|----------------|--|--|
| Continuous test current for max. 30°C rise (amps) (for .110" tab width) | 2 | 3 | 4 | 5 | Not Applicable | | |
|---|---|---|---|---|----------------|--|--|

| | | | | | | | |
|-------------------------------|---|----|----|----|----|----|----|
| Min. tensile strength* (lbs.) | 8 | 13 | 20 | 30 | 50 | 70 | 80 |
|-------------------------------|---|----|----|----|----|----|----|

*Pull-out force of the crimped disconnect.

C4.
Cable
Management

D1.
Terminals

D2.
Power
Connectors

D3.
Grounding
Connectors

E1.
Labeling
Systems

E2.
Labels

E3.
Pre-Printed
& Write-On
Markers

E4.
Permanent
Identification

E5.
Lockout/
Tagout/
& Safety
Solutions

F.
Index

Applicable *PAN-TERM*® products meet or exceed the following test specifications:

- UL 486A (Terminals)
 - UL 486C (Splices)
 - UL 310 (Blade Adapters)
 - CSA C22.2 No. 65 (all designs)
- UL and CSA approved products are shown with the applicable logos in the product section
UL file #E52164, CSA File #LR31212

Applicable *REEL SMART*™ products meet or exceed the following test specifications:

- Listed per Underwriters Laboratories, Inc. Standard UL 310 (Disconnects)
 - Recognized under the Component Recognition Program of Underwriters Laboratories Inc.
 - Certified by Canadian Standards Association (Disconnects)
- UL and CSA listed products are shown with the applicable logos in the product section
UL file #E78526, CSA file #LR31212

NOTES

A.
System
Overview

B1.
Cable Ties

B2.
Cable
Accessories

B3.
Stainless
Steel Ties

C1.
Wiring
Duct

C2.
Surface
Raceway

C3.
Abrasion
Protection

C4.
Cable
Management

D1.
Terminals

D2.
Power
Connectors

D3.
Grounding
Connectors

E1.
Labeling
Systems

E2.
Labels

E3.
Pre-Printed
& Write-On
Markers

E4.
Permanent
Identification

E5.
Lockout/
Tagout/
& Safety
Solutions

F.
Index

A. System Overview

Compression Connector Reference Information

B1. Cable Ties

B2. Cable Accessories

B3. Stainless Steel Ties

C1. Wiring Duct

C2. Surface Raceway

C3. Abrasion Protection

C4. Cable Management

D1. Terminals

D2. Power Connectors

D3. Grounding Connectors

E1. Labeling Systems

E2. Labels

E3. Pre-Printed & Write-On Markers

E4. Permanent Identification

E5. Lockout/Tagout & Safety Solutions

F. Index

Selection Guide

- Provides a quick and easy method to select the proper connector to meet the specific application requirements

Conductor Type

Stud Hole Configuration

Barrel Style

Product Type and Page Number

Product Page

- Includes all necessary information for part identification and selection

Agency Listings

Features and Benefits

Full Color Photo and 2-View Drawing

PANDUIT and Competitor Die Information

Page Reference for PANDUIT and Competitor Installation Tooling and Die Selection Charts

Installation Tooling and Die Selection Chart

- Contains comprehensive tool and die installation information for PANDUIT compression connectors with both PANDUIT and competitor tools

Page Reference to Compression Connector Tools Selection Guide for Detailed Information on PANDUIT Tools

PANDUIT and Competitor Tools

Product Type Listed by Conductor Size

Die Part Number, Color Code, Die Index Number and Number of Crimps for Each Product Type and Tool Combination

PAN-LUG™ COMPRESSION CONNECTORS

PANDUIT® PAN-LUG™ Compression Connectors provide permanent terminations for a variety of power and grounding applications, with innovation, highest reliability, and lowest installed cost. PANDUIT offers the first and only copper compression lugs and splices that meet Network Equipment-Building Systems (NEBS) Level 3 requirements as tested by Telcordia Technologies. NEBS Level 3 assures that product performance is suitable for equipment applications that demand minimal service interruptions over the life span of the equipment.

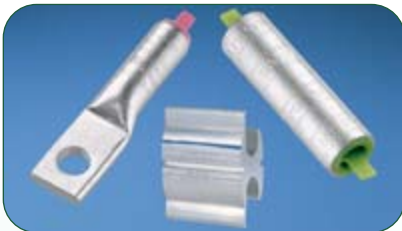

- Functional product information is marked directly on the connector, facilitating the identification, ordering, and usage of the compression connector
- Color-coded to facilitate quick identification of the proper crimping die
- Made from high strength, high conductivity electrolytic copper and aluminum alloy materials to provide optimum connectivity for power and grounding applications
- UL Listed or Recognized, CSA Certified, ABS Type Approved and tested by Telcordia – meets NEBS Level 3, as noted
- Terminations using PANDUIT® PAN-LUG™ Compression Connectors are also UL Listed and CSA Certified with specified competitor tools
- Wide assortment of manual, controlled cycle, battery operated hydraulic and pneumatic crimping tools for reliable connections at the lowest installed cost

PANDUIT® PAN-LUG™ Compression Connectors are designed for use with many different code and flex conductor types and are available in a broad range of styles and sizes including copper one-hole, two-hole, and blank tongue lugs and splices; aluminum one-hole and two-hole lugs and splices; and copper in-line reducing splices. PANDUIT offers a wide assortment of PAN-LUG™ Power Connectors to meet customer needs and today's application requirements.

A.
System
Overview

B1.
Cable Ties

B2.
Cable
Accessories

B3.
Stainless
Steel Ties

C1.
Wiring
Duct

C2.
Surface
Raceway

C3.
Abrasion
Protection

C4.
Cable
Management

D1.
Terminals

D2.
Power
Connectors

D3.
Grounding
Connectors

E1.
Labeling
Systems

E2.
Labels

E3.
Pre-Printed
& Write-On
Markers

E4.
Permanent
Identification

E5.
Lockout/
Tagout
& Safety
Solutions

F.
Index

A. System Overview

Features and Benefits – PAN-LUG™ Compression Connectors

B1. Cable Ties

Bolded features are unique to PANDUIT.

B2. Cable Accessories

B3. Stainless Steel Ties

C1. Wiring Duct

C2. Surface Raceway

C3. Abrasion Protection

C4. Cable Management

D1. Terminals

D2. Power Connectors

D3. Grounding Connectors

E1. Labeling Systems

E2. Labels

E3. Pre-Printed & Write-On Markers

E4. Permanent Identification

E5. Lockout/Tagout & Safety Solutions

F. Index

Copper Lugs

Color-coded bands for proper die selection and crimp placement

Internally beveled barrel end for easy conductor insertion (types LCCF and LCAF available with flared entry for flex conductor)

Inspection windows available to assure complete conductor insertion

Easy-to-read, Color-coded die index numbers for PANDUIT and specified competitor crimping dies for selection

Made from seamless, high conductivity copper tubing and electro tin-plated and burnished to inhibit corrosion

Part number, stud size, and conductor size marked on part for easy identification



Flex Lugs

Inspection window to assure complete conductor insertion

Tin-plated to inhibit corrosion

Color-coded with PANDUIT and specified competitor tools for safe and reliable terminations

Product information marked on part for easy identification

Can be used with code conductor and flex conductor class: G, H, I, K, M and Diesel Locomotive

Narrow Tongues

Inspection window to assure complete conductor insertion

Narrow tongue width for limited space applications

Color-coded with PANDUIT and specified competitor tools for safe and reliable terminations

Tin-plated to inhibit corrosion

Product information marked on part for easy identification

Copper Metric Lugs

Internally beveled barrel ends for easy conductor insertion

Product information marked on part for easy identification

Made from 99.9% pure copper for high quality connection and tin-plated to inhibit corrosion

Inspection window to assure complete conductor insertion



Copper Parallel Splice

Chamfered on both ends for fast and easy conductor insertion

Made from seamless, high conductivity copper tubing and electro tin-plated and burnished to inhibit corrosion

Intuitive part numbering for fast and accurate part selection in the field

Industry recognized color-coding for selection

Large part making in the industry – easier to read in low light conditions



Aluminum Lugs

Color-coded end plugs for proper die selection

Easy-to-read die index numbers for PANDUIT and specified competitor crimping dies for selection

Crimping areas marked on part for proper crimp placement

Part number and conductor size marked on part for easy identification

Factory pre-filled with oxide inhibitor to prevent oxidation

Made from seamless wrought aluminum and electro tin-plated to inhibit corrosion



Compression connector crimping tools speed installation and reduce total installed cost. See pages B3.27 – B3.90.











PANDUIT designs and manufactures a full line of labeling products, software and printers to assist you with your labeling requirements. See pages E1.1 – E2.30.



Heat shrink tubing provides an economical and easy way to insulate, protect, harness and color code electrical and electronic components. See pages C3.16 – C3.39.

Selection Guide – PAN-LUG™ Copper Compression Connectors for Copper Code Conductor



| Connector | Barrel Style | Type | Page Number |
|---|--|--------------------------------|---------------------|
|  | Short Barrel with Inspection Window | LCAS | D2.7, D2.8 |
| | | LCAS-H 45° bent | D2.9, D2.10 |
| | | LCAS-F 90° bent | D2.11, D2.12 |
| | Standard Barrel with Inspection Window | LCA | D2.13, D2.14 |
| | | LCA-H 45° bent | D2.15, D2.16 |
| | | LCA-F 90° bent | D2.17, D2.18 |
| | | LCAN narrow tongue | D2.19, D2.20 |
| | | LCA-00 blank tongue | D2.21 |
| | Long Barrel no Inspection Window | LCB | D2.22, D2.23 |
| | | LCB-H 45° bent | D2.24, D2.25 |
| | | LCB-F 90° bent | D2.26, D2.27 |
| | Long Barrel with Inspection Window | LCBH with corona relief taper | D2.30 |
| LCB-W | | D2.28 | |
| LCB-WH 45° bent | | D2.29 | |
|  | Standard Barrel with Inspection Window | LCD | D2.31, D2.32 |
| | | LCD-H 45° bent | D2.33, D2.34 |
| | | LCD-F 90° bent | D2.35, D2.36 |
| | | LCDN narrow tongue | D2.37 |
| | | LCDN-H 45° bent narrow tongue | D2.38 |
| | Long Barrel no Inspection Window | LCC | D2.41, D2.42 |
| | | LCC-H 45° bent | D2.43, D2.44 |
| | | LCC-F 90° bent | D2.45, D2.46 |
| | Long Barrel with Inspection Window | LCCH with corona relief taper | D2.56 |
| | | LCC-00 blank tongue | D2.57 |
| | | LCC-W | D2.47, D2.48, D2.49 |
| | | LCC-WH 45° bent | D2.50, D2.51, D2.52 |
|  | Long Barrel with Inspection Window | LCC-WF 90° bent | D2.53, D2.54, D2.55 |
| | | LCCN-W narrow tongue | D2.55 |
| | | LCC-00W blank tongue | D2.58 |
| | Short Barrel | SCSS | D2.59 |
| | Standard Barrel | SCS | D2.60 |
|  | Long Barrel | SCL | D2.61 |
| | | SCH with corona relief chamfer | D2.62 |
|  | | SCT | D2.63 |
| | | PSC | D2.64 |
|  | | LCMA | D2.108, D2.109 |
|  | | LCMD | D2.110, D2.111 |
|  | | SCMS | D2.112 |

- A. System Overview
- B1. Cable Ties
- B2. Cable Accessories
- B3. Stainless Steel Ties
- C1. Wiring Duct
- C2. Surface Raceway
- C3. Abrasion Protection
- C4. Cable Management
- D1. Terminals
- D2. Power Connectors
- D3. Grounding Connectors
- E1. Labeling Systems
- E2. Labels
- E3. Pre-Printed & Write-On Markers
- E4. Permanent Identification
- E5. Lockout/Tagout & Safety Solutions
- F. Index

A. System Overview

B1. Cable Ties

Selection Guide – PAN-LUG™ Copper Compression Connectors for Copper Code and/or Flex Conductor

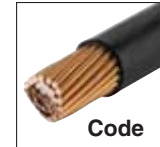

B2. Cable Accessories

| Connector | Barrel Style | Type | Page Number |
|-----------|--------------|------|-------------|
|-----------|--------------|------|-------------|

B3. Stainless Steel Ties

C1. Wiring Duct

C2. Surface Raceway

C3. Abrasion Protection

C4. Cable Management



| Connector | Barrel Style | Type | Page Number |
|--|--|--------------------------------|--------------|
| One-Hole Lugs | Standard Barrel with Inspection Window Code and Flex | LCAX | D2.66, D2.67 |
| | | LCAX-H 45° bent | D2.68, D2.69 |
| | | LCAX-F 90° bent | D2.70, D2.71 |
| | Standard Barrel with Inspection Window and Flared Entry Flex | LCAXN narrow tongue | D2.72 |
| | | LCAXN-H 45° bent narrow tongue | D2.72 |
| | | LCAXN-F 90° bent narrow tongue | D2.73 |
| | Long Barrel with Inspection Window Code and Flex | LCBF | D2.74, D2.75 |
| | | LCBF-H 45° bent | D2.76, D2.77 |
| | | LCBF-F 90° bent | D2.78, D2.79 |
| Long Barrel with Inspection Window Code and Flex | LCBX | D2.80 | |
| | LCBX-H 45° bent | D2.81 | |
| | LCBX-F 90° bent | D2.82 | |

D1. Terminals

D2. Power Connectors

D3. Grounding Connectors



| Connector | Barrel Style | Type | Page Number |
|--|--|--------------------------------|----------------|
| Two-Hole Lugs | Standard Barrel with Inspection Window Code and Flex | LCDX | D2.83, D2.84 |
| | | LCDX-H 45° bent | D2.85, D2.86 |
| | | LCDX-F 90° bent | D2.87, D2.88 |
| | Long Barrel no Inspection Window Flared Entry Flex | LCDXN narrow tongue | D2.89 |
| | | LCDXN-H 45° bent narrow tongue | D2.90 |
| | | LCDXN-F 90° bent narrow tongue | D2.90 |
| | Long Barrel with Inspection Window Code and Flex | LCCF | D2.97, D2.98 |
| | | LCCF-H 45° bent | D2.99, D2.100 |
| | | LCCF-F 90° bent | D2.101, D2.102 |
| Long Barrel with Inspection Window Code and Flex | LCCX | D2.91, D2.92 | |
| | LCCX-H 45° bent | D2.93, D2.94 | |
| | LCCX-F 90° bent | D2.95, D2.96 | |

E2. Labels

E3. Pre-Printed & Write-On Markers



| Connector | Barrel Style | Type | Page Number |
|--|--------------|------|-------------|
| Butt Splices with Flared Entry for Flex | | SCSF | D2.103 |

E4. Permanent Identification

E5. Lockout/Tagout & Safety Solutions



| Connector | Barrel Style | Type | Page Number |
|--|--------------|--|----------------|
| Reducing Splices with Inspection Window Code and for Flex | | RSCK kits with reducing splice and clear heat shrink | D2.104, D2.105 |
| | | RSC reducing splices | D2.106, D2.107 |

F. Index

Selection Guide – *PAN-LUG™* Aluminum Compression Connectors for Aluminum or Copper Code Conductor

A.
System
Overview

B1.
Cable Ties

B2.
Cable
Accessories

B3.
Stainless
Steel Ties

C1.
Wiring
Duct

C2.
Surface
Raceway

C3.
Abrasion
Protection

C4.
Cable
Management

D1.
Terminals

D2.
Power
Connectors

D3.
Grounding
Connectors

E1.
Labeling
Systems

E2.
Labels

E3.
Pre-Printed
& Write-On
Markers

E4.
Permanent
Identification

E5.
Lockout/
Tagout/
& Safety
Solutions

F.
Index

| Connector | Type | Page Number |
|-----------|------|-------------|
|-----------|------|-------------|



| | | |
|---------------|-----|--------|
| One-Hole Lugs | LAA | D2.116 |
|---------------|-----|--------|



| | | |
|---------------|-----|--------|
| Two-Hole Lugs | LAB | D2.117 |
|---------------|-----|--------|



| | | |
|--------------|----|--------|
| Butt Splices | SA | D2.119 |
|--------------|----|--------|



| | | |
|------------------|-----|--------|
| Reducing Splices | SAR | D2.120 |
|------------------|-----|--------|



| | | |
|---|-----|--------|
| Bi-Metallic Pin Connectors for Aluminum Conductors Only | BPC | D2.121 |
|---|-----|--------|



| | | |
|-----------|---------------------------------|--------|
| HTAP Taps | HTAP | D2.122 |
| | TAPC black covers for HTAP taps | D2.108 |



| | | |
|--------------------|----|----------------|
| Belleville Washers | CW | D2.118, D2.161 |
|--------------------|----|----------------|



| | | |
|-----------------|-----|----------------|
| Joint Compounds | CMP | D2.123, D2.161 |
|-----------------|-----|----------------|

A.
System
Overview

Part Number System for Lugs

B1.
Cable Ties

B2.
Cable
Accessories

B3.
Stainless
Steel Ties

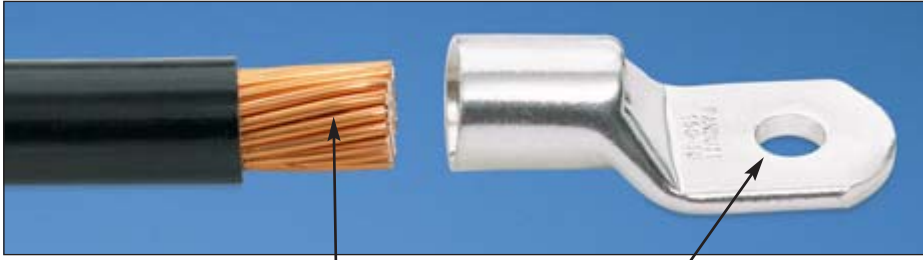

LCD

150
150 = 150mm²

10
10 = 10mm∅

X
1 = 1 X = 10 C = 100
5 = 5 L = 50

C1.
Wiring
Duct

Part Number System for *PAN-LUG™* Compression AWG Lugs

C2.
Surface
Raceway

C3.
Abrasion
Protection

| LCD | 2/0 | — | 38 | D | F | — | X |
|--|----------------|---|--------------------|-----------------------|----------------------|---|-----------------------|
| Type | Conductor Size | | Stud Hole Size | Two Stud Hole Spacing | Tongue Angle | | Standard Package Size |
| Ex: LCD Lug, Copper Two-Hole Standard Barrel | | | 10 = #10 | A = .625" | H = 45° Angle | | 1 = 1 |
| | | | 14 = 1/4" | B = .750" | F = 90° Angle | | 2 = 2 |
| | | | 56 = 5/16" | C = .875" | No Letter = Straight | | 3 = 3 |
| | | | 38 = 3/8" | D = 1.0" | | | 5 = 5 |
| | | | 12 = 1/2" | E = 1.25" | | | 6 = 6 |
| | | | 58 = 5/8" | G = 1.5" | | | X = 10 |
| | | | 34 = 3/4" | J = .5" | | | E = 20 |
| | | | 78 = 7/8" | K = 2" | | | Q = 25 |
| | | | 00 = Blank Tongue* | M = 1.375" | | | L = 50 |
| | | | | P = .688" | | | |
| | | | Q = 1.125" | | | | |
| | | | No Letter = 1.75" | | | | |

* LCA, LCC
and LCD
styles only

C4.
Cable
Management

D1.
Terminals

D2.
Power
Connectors

D3.
Grounding
Connectors

E1.
Labeling
Systems

E2.
Labels

E3.
Pre-Printed
& Write-On
Markers

E4.
Permanent
Identification

E5.
Lockout/
Tagout/
& Safety
Solutions

F.
Index



Code Conductor, One-Hole, Short Barrel with Window Lug

For Use with Stranded Copper Conductors

Type LCAS

- Short barrel for limited space applications
- Color-coded barrels marked with *PANDUIT* and specified competitor die index numbers for proper crimp die selection
- Inspection window to visually assure full conductor insertion
- Tin-plated to inhibit corrosion
- UL Listed and CSA Certified to 35 KV** and temperature rated to 90°C when crimped with *PANDUIT* and specified competitor crimping tools and dies
- Tested by Telcordia – meets NEBS Level 3
- American Bureau of Shipping approved

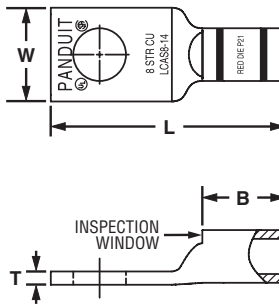

| Part Number | Copper Conductor Size | Stud Hole Size (In.) | Figure Dimensions (In.) | | | | PANDUIT Color Code | PANDUIT Die Index No.‡ | Burndy Die Index No.‡ | T&B Die Index No.‡ | Wire Strip Length (In.) | Std. Pkg. Qty. |
|--------------|-----------------------|----------------------|-------------------------|-----|-----|------|--------------------|------------------------|-----------------------|--------------------|-------------------------|----------------|
| | | | W | B | T | L | | | | | | |
| LCAS8-10-L | #8 AWG | #10 | .41 | .42 | .08 | 1.11 | Red | P21 | 49 | 21 | 1/2 | 50 |
| LCAS8-14-L | | 1/4 | .48 | .42 | .07 | 1.20 | Red | P21 | 49 | 21 | 1/2 | 50 |
| LCAS8-56-L | | 5/16 | .56 | .42 | .05 | 1.32 | Red | P21 | 49 | 21 | 1/2 | 50 |
| LCAS8-38-L | | 3/8 | .60 | .42 | .05 | 1.42 | Red | P21 | 49 | 21 | 1/2 | 50 |
| LCAS6-10-L | #6 AWG | #10 | .45 | .48 | .09 | 1.19 | Blue | P24 | 7 | 24 | 9/16 | 50 |
| LCAS6-14-L | | 1/4 | .48 | .48 | .08 | 1.28 | Blue | P24 | 7 | 24 | 9/16 | 50 |
| LCAS6-56-L | | 5/16 | .56 | .48 | .07 | 1.40 | Blue | P24 | 7 | 24 | 9/16 | 50 |
| LCAS6-38-L | | 3/8 | .62 | .48 | .06 | 1.50 | Blue | P24 | 7 | 24 | 9/16 | 50 |
| LCAS4-10-L | #4 AWG | #10 | .55 | .53 | .09 | 1.26 | Gray | P29 | 8 | 29 | 5/8 | 50 |
| LCAS4-14-L | | 1/4 | .55 | .53 | .09 | 1.35 | Gray | P29 | 8 | 29 | 5/8 | 50 |
| LCAS4-56-L | | 5/16 | .55 | .53 | .09 | 1.47 | Gray | P29 | 8 | 29 | 5/8 | 50 |
| LCAS4-38-L | | 3/8 | .62 | .53 | .07 | 1.57 | Gray | P29 | 8 | 29 | 5/8 | 50 |
| LCAS2-14-Q | #2 AWG | 1/4 | .60 | .57 | .10 | 1.46 | Brown | P33 | 10 | 33 | 5/8 | 25 |
| LCAS2-56-Q | | 5/16 | .66 | .57 | .10 | 1.58 | Brown | P33 | 10 | 33 | 5/8 | 25 |
| LCAS2-38-Q | | 3/8 | .66 | .57 | .10 | 1.66 | Brown | P33 | 10 | 33 | 5/8 | 25 |
| LCAS2-12-Q | | 1/2 | .75 | .57 | .08 | 1.89 | Brown | P33 | 10 | 33 | 5/8 | 25 |
| LCAS1-14-E | #1 AWG | 1/4 | .70 | .59 | .11 | 1.50 | Green | P37 | 11 | 37 | 11/16 | 20 |
| LCAS1-56-E | | 5/16 | .70 | .59 | .11 | 1.63 | Green | P37 | 11 | 37 | 11/16 | 20 |
| LCAS1-38-E | | 3/8 | .70 | .59 | .11 | 1.70 | Green | P37 | 11 | 37 | 11/16 | 20 |
| LCAS1-12-E | | 1/2 | .75 | .59 | .09 | 1.94 | Green | P37 | 11 | 37 | 11/16 | 20 |
| LCAS1/0-14-X | 1/0 AWG | 1/4 | .76 | .66 | .12 | 1.67 | Pink | P42 | 12 | 42 | 3/4 | 10 |
| LCAS1/0-56-X | | 5/16 | .76 | .66 | .12 | 1.72 | Pink | P42 | 12 | 42 | 3/4 | 10 |
| LCAS1/0-38-X | | 3/8 | .76 | .66 | .12 | 1.80 | Pink | P42 | 12 | 42 | 3/4 | 10 |
| LCAS1/0-12-X | | 1/2 | .80 | .66 | .12 | 2.03 | Pink | P42 | 12 | 42 | 3/4 | 10 |
| LCAS2/0-14-X | 2/0 AWG | 1/4 | .85 | .72 | .13 | 1.82 | Black | P45 | 13 | 45 | 3/4 | 10 |
| LCAS2/0-56-X | | 5/16 | .85 | .72 | .13 | 1.82 | Black | P45 | 13 | 45 | 3/4 | 10 |
| LCAS2/0-38-X | | 3/8 | .85 | .72 | .13 | 1.89 | Black | P45 | 13 | 45 | 3/4 | 10 |
| LCAS2/0-12-X | | 1/2 | .85 | .72 | .13 | 2.14 | Black | P45 | 13 | 45 | 3/4 | 10 |

‡See pages D3.52, D3.53 for tool and die information.

**Consult cable manufacturer for voltage stress relief instructions with applications greater than 2000 V.

Table continues on pages D2.8

A. System Overview

B1. Cable Ties

B2. Cable Accessories

B3. Stainless Steel Ties

C1. Wiring Duct

C2. Surface Raceway

C3. Abrasion Protection

C4. Cable Management

D1. Terminals

D2. Power Connectors

D3. Grounding Connectors

E1. Labeling Systems

E2. Labels

E3. Pre-Printed & Write-On Markers

E4. Permanent Identification

E5. Lockout/Tagout & Safety Solutions

F. Index

A.
System
Overview

B1.
Cable Ties

B2.
Cable
Accessories

B3.
Stainless
Steel Ties

C1.
Wiring
Duct

C2.
Surface
Raceway

C3.
Abrasion
Protection

C4.
Cable
Management

D1.
Terminals

D2.
Power
Connectors

D3.
Grounding
Connectors

E1.
Labeling
Systems

E2.
Labels

E3.
Pre-Printed
& Write-On
Markers

E4.
Permanent
Identification

E5.
Lockout/
Tagout/
& Safety
Solutions

F.
Index



Code Conductor, One-Hole, Short Barrel with Window Lug (continued)

| Part Number | Copper Conductor Size | Stud Hole Size (In.) | Figure Dimensions (In.) | | | | PANDUIT Color Code | PANDUIT Die Index No.‡ | Burndy Die Index No.‡ | T&B Die Index No.‡ | Wire Strip Length (In.) | Std. Pkg. Qty. |
|---------------------|-----------------------|----------------------|-------------------------|------|-----|------|--------------------|------------------------|-----------------------|--------------------|-------------------------|----------------|
| | | | W | B | T | L | | | | | | |
| LCAS3/0-14-X | 3/0 AWG | 1/4 | .96 | .83 | .13 | 1.97 | Orange | P50 | 14 | 50 | 7/8 | 10 |
| LCAS3/0-56-X | | 5/16 | .96 | .83 | .13 | 1.97 | Orange | P50 | 14 | 50 | 7/8 | 10 |
| LCAS3/0-38-X | | 3/8 | .96 | .83 | .13 | 2.03 | Orange | P50 | 14 | 50 | 7/8 | 10 |
| LCAS3/0-12-X | | 1/2 | .96 | .83 | .13 | 2.28 | Orange | P50 | 14 | 50 | 7/8 | 10 |
| LCAS4/0-14-X | 4/0 AWG | 1/4 | 1.06 | .91 | .14 | 2.08 | Purple | P54 | 15 | 54 | 1 | 10 |
| LCAS4/0-56-X | | 5/16 | 1.06 | .91 | .14 | 2.10 | Purple | P54 | 15 | 54 | 1 | 10 |
| LCAS4/0-38-X | | 3/8 | 1.06 | .91 | .14 | 2.17 | Purple | P54 | 15 | 54 | 1 | 10 |
| LCAS4/0-12-X | | 1/2 | 1.06 | .91 | .14 | 2.40 | Purple | P54 | 15 | 54 | 1 | 10 |
| LCAS250-14-X | 250 kcmil | 1/4 | 1.17 | 1.03 | .14 | 2.25 | Yellow | P62 | 16 | 62 | 1 1/8 | 10 |
| LCAS250-56-X | | 5/16 | 1.17 | 1.03 | .14 | 2.25 | Yellow | P62 | 16 | 62 | 1 1/8 | 10 |
| LCAS250-38-X | | 3/8 | 1.17 | 1.03 | .14 | 2.32 | Yellow | P62 | 16 | 62 | 1 1/8 | 10 |
| LCAS250-12-X | | 1/2 | 1.17 | 1.03 | .14 | 2.56 | Yellow | P62 | 16 | 62 | 1 1/8 | 10 |

‡See pages D3.52, D3.53 for tool and die information.

**Consult cable manufacturer for voltage stress relief instructions with applications greater than 2000 V.



Code Conductor, One-Hole, Short Barrel with Window Lug, 45° Angle

For Use with Stranded Copper Conductors

Type LCAS-H

- Short barrel for limited space applications
- Color-coded barrels marked with *PANDUIT* and specified competitor die index numbers for proper crimp die selection
- Inspection window to visually assure full conductor insertion
- Tin-plated to inhibit corrosion

- UL Listed and CSA Certified to 35 KV** and temperature rated to 90°C when crimped with *PANDUIT* and specified competitor crimping tools and dies
- **Tested by Telcordia – meets NEBS Level 3**
- American Bureau of Shipping approved

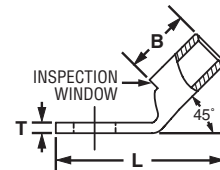
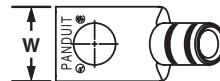

| Part Number | Copper Conductor Size | Stud Hole Size (In.) | Figure Dimensions (In.) | | | | PANDUIT Color Code | PANDUIT Die Index No.‡ | Burndy Die Index No.‡ | T&B Die Index No.‡ | Wire Strip Length (In.) | Std. Pkg. Qty. |
|---------------|-----------------------|----------------------|-------------------------|-----|-----|------|--------------------|------------------------|-----------------------|--------------------|-------------------------|----------------|
| | | | W | B | T | L | | | | | | |
| LCAS8-10H-L | #8 AWG | #10 | .41 | .42 | .08 | 1.00 | Red | P21 | 49 | 21 | 1/2 | 50 |
| LCAS8-14H-L | | 1/4 | .48 | .42 | .07 | 1.09 | Red | P21 | 49 | 21 | 1/2 | 50 |
| LCAS8-56H-L | | 5/16 | .56 | .42 | .05 | 1.20 | Red | P21 | 49 | 21 | 1/2 | 50 |
| LCAS8-38H-L | | 3/8 | .60 | .42 | .05 | 1.30 | Red | P21 | 49 | 21 | 1/2 | 50 |
| LCAS6-10H-L | #6 AWG | #10 | .45 | .48 | .09 | 1.06 | Blue | P24 | 7 | 24 | 9/16 | 50 |
| LCAS6-14H-L | | 1/4 | .48 | .48 | .08 | 1.14 | Blue | P24 | 7 | 24 | 9/16 | 50 |
| LCAS6-56H-L | | 5/16 | .56 | .48 | .07 | 1.26 | Blue | P24 | 7 | 24 | 9/16 | 50 |
| LCAS6-38H-L | | 3/8 | .62 | .48 | .06 | 1.35 | Blue | P24 | 7 | 24 | 9/16 | 50 |
| LCAS4-10H-L | #4 AWG | #10 | .55 | .53 | .09 | 1.12 | Gray | P29 | 8 | 29 | 5/8 | 50 |
| LCAS4-14H-L | | 1/4 | .55 | .53 | .09 | 1.21 | Gray | P29 | 8 | 29 | 5/8 | 50 |
| LCAS4-56H-L | | 5/16 | .55 | .53 | .09 | 1.33 | Gray | P29 | 8 | 29 | 5/8 | 50 |
| LCAS4-38H-L | | 3/8 | .62 | .53 | .07 | 1.42 | Gray | P29 | 8 | 29 | 5/8 | 50 |
| LCAS2-14H-Q | #2 AWG | 1/4 | .60 | .57 | .10 | 1.27 | Brown | P33 | 10 | 33 | 5/8 | 25 |
| LCAS2-56H-Q | | 5/16 | .66 | .57 | .10 | 1.39 | Brown | P33 | 10 | 33 | 5/8 | 25 |
| LCAS2-38H-Q | | 3/8 | .66 | .57 | .10 | 1.46 | Brown | P33 | 10 | 33 | 5/8 | 25 |
| LCAS2-12H-Q | | 1/2 | .75 | .57 | .08 | 1.68 | Brown | P33 | 10 | 33 | 5/8 | 25 |
| LCAS1-14H-E | #1 AWG | 1/4 | .70 | .59 | .11 | 1.29 | Green | P37 | 11 | 37 | 11/16 | 20 |
| LCAS1-56H-E | | 5/16 | .70 | .59 | .11 | 1.42 | Green | P37 | 11 | 37 | 11/16 | 20 |
| LCAS1-38H-E | | 3/8 | .70 | .59 | .11 | 1.49 | Green | P37 | 11 | 37 | 11/16 | 20 |
| LCAS1-12H-E | | 1/2 | .75 | .59 | .09 | 1.73 | Green | P37 | 11 | 37 | 11/16 | 20 |
| LCAS1/0-14H-X | 1/0 AWG | 1/4 | .76 | .66 | .12 | 1.43 | Pink | P42 | 12 | 42 | 3/4 | 10 |
| LCAS1/0-56H-X | | 5/16 | .76 | .66 | .12 | 1.49 | Pink | P42 | 12 | 42 | 3/4 | 10 |
| LCAS1/0-38H-X | | 3/8 | .76 | .66 | .12 | 1.56 | Pink | P42 | 12 | 42 | 3/4 | 10 |
| LCAS1/0-12H-X | | 1/2 | .80 | .66 | .12 | 1.79 | Pink | P42 | 12 | 42 | 3/4 | 10 |
| LCAS2/0-14H-X | 2/0 AWG | 1/4 | .85 | .72 | .13 | 1.58 | Black | P45 | 13 | 45 | 3/4 | 10 |
| LCAS2/0-56H-X | | 5/16 | .85 | .72 | .13 | 1.58 | Black | P45 | 13 | 45 | 3/4 | 10 |
| LCAS2/0-38H-X | | 3/8 | .85 | .72 | .13 | 1.64 | Black | P45 | 13 | 45 | 3/4 | 10 |
| LCAS2/0-12H-X | | 1/2 | .85 | .72 | .13 | 1.89 | Black | P45 | 13 | 45 | 3/4 | 10 |

‡See pages D3.52, D3.53 for tool and die information.

**Consult cable manufacturer for voltage stress relief instructions with applications greater than 2000 V.

Table continues on pages D2.10

A. System Overview

B1. Cable Ties

B2. Cable Accessories

B3. Stainless Steel Ties

C1. Wiring Duct

C2. Surface Raceway

C3. Abrasion Protection

C4. Cable Management

D1. Terminals

D2. Power Connectors

D3. Grounding Connectors

E1. Labeling Systems

E2. Labels

E3. Pre-Printed & Write-On Markers

E4. Permanent Identification

E5. Lockout/Tagout & Safety Solutions

F. Index

A.
System
Overview

B1.
Cable Ties



Code Conductor, One-Hole, Short Barrel with Window Lug, 45° Angle (continued)

B2.
Cable
Accessories

B3.
Stainless
Steel Ties

C1.
Wiring
Duct

C2.
Surface
Raceway

C3.
Abrasion
Protection

C4.
Cable
Management

D1.
Terminals

D2.
Power
Connectors

D3.
Grounding
Connectors

E1.
Labeling
Systems

E2.
Labels

E3.
Pre-Printed
& Write-On
Markers

E4.
Permanent
Identification

E5.
Lockout/
Tagout
& Safety
Solutions

F.
Index

| Part Number | Copper Conductor Size | Stud Hole Size (In.) | Figure Dimensions (In.) | | | | PANDUIT Color Code | PANDUIT Die Index No.‡ | Burndy Die Index No.‡ | T&B Die Index No.‡ | Wire Strip Length (In.) | Std. Pkg. Qty. |
|---------------|-----------------------|----------------------|-------------------------|------|-----|------|--------------------|------------------------|-----------------------|--------------------|-------------------------|----------------|
| | | | W | B | T | L | | | | | | |
| LCAS3/0-14H-X | 3/0 AWG | 1/4 | .96 | .83 | .13 | 1.68 | Orange | P50 | 14 | 50 | 7/8 | 10 |
| LCAS3/0-56H-X | | 5/16 | .96 | .83 | .13 | 1.68 | Orange | P50 | 14 | 50 | 7/8 | 10 |
| LCAS3/0-38H-X | | 3/8 | .96 | .83 | .13 | 1.74 | Orange | P50 | 14 | 50 | 7/8 | 10 |
| LCAS3/0-12H-X | | 1/2 | .96 | .83 | .13 | 1.99 | Orange | P50 | 14 | 50 | 7/8 | 10 |
| LCAS4/0-14H-X | 4/0 AWG | 1/4 | 1.06 | .91 | .14 | 1.77 | Purple | P54 | 15 | 54 | 1 | 10 |
| LCAS4/0-56H-X | | 5/16 | 1.06 | .91 | .14 | 1.78 | Purple | P54 | 15 | 54 | 1 | 10 |
| LCAS4/0-38H-X | | 3/8 | 1.06 | .91 | .14 | 1.85 | Purple | P54 | 15 | 54 | 1 | 10 |
| LCAS4/0-12H-X | | 1/2 | 1.06 | .91 | .14 | 2.08 | Purple | P54 | 15 | 54 | 1 | 10 |
| LCAS250-14H-X | 250 kcmil | 1/4 | 1.17 | 1.03 | .14 | 1.89 | Yellow | P62 | 16 | 62 | 1 1/8 | 10 |
| LCAS250-56H-X | | 5/16 | 1.17 | 1.03 | .14 | 1.90 | Yellow | P62 | 16 | 62 | 1 1/8 | 10 |
| LCAS250-38H-X | | 3/8 | 1.17 | 1.03 | .14 | 1.97 | Yellow | P62 | 16 | 62 | 1 1/8 | 10 |
| LCAS250-12H-X | | 1/2 | 1.17 | 1.03 | .14 | 2.20 | Yellow | P62 | 16 | 62 | 1 1/8 | 10 |

‡See pages D3.52, D3.53 for tool and die information.

**Consult cable manufacturer for voltage stress relief instructions with applications greater than 2000 V.



Code Conductor, One-Hole, Short Barrel with Window Lug, 90° Angle

For Use with Stranded Copper Conductors

Type LCAS-F

- Short barrel for limited space applications
- Color-coded barrels marked with *PANDUIT* and specified competitor die index numbers for proper crimp die selection
- Inspection window to visually assure full conductor insertion
- Tin-plated to inhibit corrosion
- UL Listed and CSA Certified to 35 KV** and temperature rated to 90°C when crimped with *PANDUIT* and specified competitor crimping tools and dies
- Tested by Telcordia – meets NEBS Level 3
- American Bureau of Shipping approved

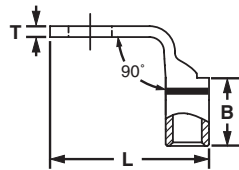
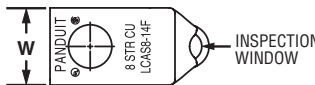

| Part Number | Copper Conductor Size | Stud Hole Size (In.) | Figure Dimensions (In.) | | | | PANDUIT Color Code | PANDUIT Die Index No.‡ | Burndy Die Index No.‡ | T&B Die Index No.‡ | Wire Strip Length (In.) | Std. Pkg. Qty. |
|---------------|-----------------------|----------------------|-------------------------|-----|-----|------|--------------------|------------------------|-----------------------|--------------------|-------------------------|----------------|
| | | | W | B | T | L | | | | | | |
| LCAS8-10F-L | #8 AWG | #10 | .41 | .42 | .08 | .90 | Red | P21 | 49 | 21 | 1/2 | 50 |
| LCAS8-14F-L | | 1/4 | .48 | .42 | .07 | .99 | Red | P21 | 49 | 21 | 1/2 | 50 |
| LCAS8-56F-L | | 5/16 | .56 | .42 | .05 | 1.11 | Red | P21 | 49 | 21 | 1/2 | 50 |
| LCAS8-38F-L | | 3/8 | .60 | .42 | .05 | 1.21 | Red | P21 | 49 | 21 | 1/2 | 50 |
| LCAS6-10F-L | #6 AWG | #10 | .45 | .48 | .09 | .94 | Blue | P24 | 7 | 24 | 9/16 | 50 |
| LCAS6-14F-L | | 1/4 | .48 | .48 | .08 | 1.03 | Blue | P24 | 7 | 24 | 9/16 | 50 |
| LCAS6-56F-L | | 5/16 | .56 | .48 | .07 | 1.15 | Blue | P24 | 7 | 24 | 9/16 | 50 |
| LCAS6-38F-L | | 3/8 | .62 | .48 | .06 | 1.25 | Blue | P24 | 7 | 24 | 9/16 | 50 |
| LCAS4-10F-L | #4 AWG | #10 | .55 | .53 | .09 | 1.03 | Gray | P29 | 8 | 29 | 5/8 | 50 |
| LCAS4-14F-L | | 1/4 | .55 | .53 | .09 | 1.12 | Gray | P29 | 8 | 29 | 5/8 | 50 |
| LCAS4-56F-L | | 5/16 | .55 | .53 | .09 | 1.24 | Gray | P29 | 8 | 29 | 5/8 | 50 |
| LCAS4-38F-L | | 3/8 | .62 | .53 | .07 | 1.34 | Gray | P29 | 8 | 29 | 5/8 | 50 |
| LCAS2-14F-Q | #2 AWG | 1/4 | .60 | .57 | .10 | 1.24 | Brown | P33 | 10 | 33 | 5/8 | 25 |
| LCAS2-56F-Q | | 5/16 | .66 | .57 | .10 | 1.36 | Brown | P33 | 10 | 33 | 5/8 | 25 |
| LCAS2-38F-Q | | 3/8 | .66 | .57 | .10 | 1.44 | Brown | P33 | 10 | 33 | 5/8 | 25 |
| LCAS2-12F-Q | | 1/2 | .75 | .57 | .08 | 1.67 | Brown | P33 | 10 | 33 | 5/8 | 25 |
| LCAS1-14F-E | #1 AWG | 1/4 | .70 | .59 | .11 | 1.31 | Green | P37 | 11 | 37 | 11/16 | 20 |
| LCAS1-56F-E | | 5/16 | .70 | .59 | .11 | 1.44 | Green | P37 | 11 | 37 | 11/16 | 20 |
| LCAS1-38F-E | | 3/8 | .70 | .59 | .11 | 1.51 | Green | P37 | 11 | 37 | 11/16 | 20 |
| LCAS1-12F-E | | 1/2 | .75 | .59 | .09 | 1.75 | Green | P37 | 11 | 37 | 11/16 | 20 |
| LCAS1/0-14F-X | 1/0 AWG | 1/4 | .76 | .66 | .12 | 1.45 | Pink | P42 | 12 | 42 | 3/4 | 10 |
| LCAS1/0-56F-X | | 5/16 | .76 | .66 | .12 | 1.51 | Pink | P42 | 12 | 42 | 3/4 | 10 |
| LCAS1/0-38F-X | | 3/8 | .76 | .66 | .12 | 1.58 | Pink | P42 | 12 | 42 | 3/4 | 10 |
| LCAS1/0-12F-X | | 1/2 | .80 | .66 | .12 | 1.82 | Pink | P42 | 12 | 42 | 3/4 | 10 |
| LCAS2/0-14F-X | 2/0 AWG | 1/4 | .85 | .72 | .13 | 1.59 | Black | P45 | 13 | 45 | 3/4 | 10 |
| LCAS2/0-56F-X | | 5/16 | .85 | .72 | .13 | 1.59 | Black | P45 | 13 | 45 | 3/4 | 10 |
| LCAS2/0-38F-X | | 3/8 | .85 | .72 | .13 | 1.66 | Black | P45 | 13 | 45 | 3/4 | 10 |
| LCAS2/0-12F-X | | 1/2 | .85 | .72 | .13 | 1.91 | Black | P45 | 13 | 45 | 3/4 | 10 |

‡See pages D3.52, D3.53 for tool and die information.

**Consult cable manufacturer for voltage stress relief instructions with applications greater than 2000 V.

Table continues on pages D2.12

A. System Overview

B1. Cable Ties

B2. Cable Accessories

B3. Stainless Steel Ties

C1. Wiring Duct

C2. Surface Raceway

C3. Abrasion Protection

C4. Cable Management

D1. Terminals

D2. Power Connectors

D3. Grounding Connectors

E1. Labeling Systems

E2. Labels

E3. Pre-Printed & Write-On Markers

E4. Permanent Identification

E5. Lockout/Tagout & Safety Solutions

F. Index

A.
System
Overview

B1.
Cable Ties



Code Conductor, One-Hole, Short Barrel with Window Lug, 90° Angle (continued)

B2.
Cable
Accessories

B3.
Stainless
Steel Ties

C1.
Wiring
Duct

C2.
Surface
Raceway

C3.
Abrasion
Protection

C4.
Cable
Management

D1.
Terminals

D2.
Power
Connectors

D3.
Grounding
Connectors

E1.
Labeling
Systems

E2.
Labels

E3.
Pre-Printed
& Write-On
Markers

E4.
Permanent
Identification

E5.
Lockout/
Tagout/
& Safety
Solutions

F.
Index

| Part Number | Copper Conductor Size | Stud Hole Size (In.) | Figure Dimensions (In.) | | | | PANDUIT Color Code | PANDUIT Die Index No.‡ | Burndy Die Index No.‡ | T&B Die Index No.‡ | Wire Strip Length (In.) | Std. Pkg. Qty. |
|---------------|-----------------------|----------------------|-------------------------|------|-----|------|--------------------|------------------------|-----------------------|--------------------|-------------------------|----------------|
| | | | W | B | T | L | | | | | | |
| LCAS3/0-14F-X | 3/0 AWG | 1/4 | .96 | .83 | .13 | 1.67 | Orange | P50 | 14 | 50 | 7/8 | 10 |
| LCAS3/0-56F-X | | 5/16 | .96 | .83 | .13 | 1.67 | Orange | P50 | 14 | 50 | 7/8 | 10 |
| LCAS3/0-38F-X | | 3/8 | .96 | .83 | .13 | 1.73 | Orange | P50 | 14 | 50 | 7/8 | 10 |
| LCAS3/0-12F-X | | 1/2 | .96 | .83 | .13 | 1.98 | Orange | P50 | 14 | 50 | 7/8 | 10 |
| LCAS4/0-14F-X | 4/0 AWG | 1/4 | 1.06 | .91 | .14 | 1.75 | Purple | P54 | 15 | 54 | 1 | 10 |
| LCAS4/0-56F-X | | 5/16 | 1.06 | .91 | .14 | 1.77 | Purple | P54 | 15 | 54 | 1 | 10 |
| LCAS4/0-38F-X | | 3/8 | 1.06 | .91 | .14 | 1.84 | Purple | P54 | 15 | 54 | 1 | 10 |
| LCAS4/0-12F-X | | 1/2 | 1.06 | .91 | .14 | 2.07 | Purple | P54 | 15 | 54 | 1 | 10 |
| LCAS250-14F-X | 250 kcmil | 1/4 | 1.17 | 1.03 | .14 | 1.82 | Yellow | P62 | 16 | 62 | 1 1/8 | 10 |
| LCAS250-56F-X | | 5/16 | 1.17 | 1.03 | .14 | 1.83 | Yellow | P62 | 16 | 62 | 1 1/8 | 10 |
| LCAS250-38F-X | | 3/8 | 1.17 | 1.03 | .14 | 1.90 | Yellow | P62 | 16 | 62 | 1 1/8 | 10 |
| LCAS250-12F-X | | 1/2 | 1.17 | 1.03 | .14 | 2.13 | Yellow | P62 | 16 | 62 | 1 1/8 | 10 |

‡See pages D3.52, D3.53 for tool and die information.

**Consult cable manufacturer for voltage stress relief instructions with applications greater than 2000 V.



Code Conductor, One-Hole, Standard Barrel with Window Lug

For Use with Stranded Copper Conductors

Type LCA

- Color-coded barrels marked with *PANDUIT* and specified competitor die index numbers for proper crimp die selection
- Inspection window to visually assure full conductor insertion
- Tin-plated to inhibit corrosion
- UL Listed and CSA Certified to 35 KV** and temperature rated to 90°C when crimped with *PANDUIT* and specified competitor crimping tools and dies

- UL Listed and CSA Certified for wide wire range-taking capability when crimped with *PANDUIT*® *UNI-DIE*™ Dieless Crimping Tools‡
- **Tested by Telcordia – meets NEBS Level 3**
- American Bureau of Shipping Approved

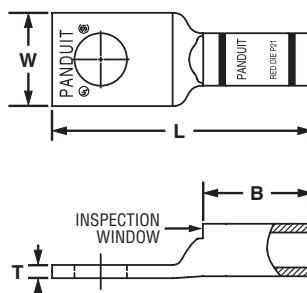

| Part Number | Copper Conductor Size | Stud Hole Size (In.) | Figure Dimensions (In.) | | | | PANDUIT Color Code | PANDUIT Die Index No.‡ | Burdny Die Index No.‡ | T&B Die Index No.‡ | Wire Strip Length (In.) | Std. Pkg. Qty. |
|-------------|-----------------------|----------------------|-------------------------|-----|-----|------|--------------------|------------------------|-----------------------|--------------------|-------------------------|----------------|
| | | | W | B | T | L | | | | | | |
| LCA10-10-L* | #14 – #10 AWG STR, | #10 | .38 | .38 | .06 | 1.07 | — | — | — | — | 7/16 | 50 |
| LCA10-14-L* | #12 – #10 AWG SOL | 1/4 | .42 | .38 | .05 | 1.16 | — | — | — | — | 7/16 | 50 |
| LCA10-56-L* | | 5/16 | .54 | .38 | .04 | 1.28 | — | — | — | — | 7/16 | 50 |
| LCA10-38-L* | | 3/8 | .56 | .38 | .04 | 1.38 | — | — | — | — | 7/16 | 50 |
| LCA8-10-L | #8 AWG | #10 | .41 | .56 | .08 | 1.25 | Red | P21 | 49 | 21 | 5/8 | 50 |
| LCA8-14-L | | 1/4 | .48 | .56 | .07 | 1.34 | Red | P21 | 49 | 21 | 5/8 | 50 |
| LCA8-56-L | | 5/16 | .56 | .56 | .05 | 1.46 | Red | P21 | 49 | 21 | 5/8 | 50 |
| LCA8-38-L | | 3/8 | .60 | .56 | .05 | 1.56 | Red | P21 | 49 | 21 | 5/8 | 50 |
| LCA6-10-L | #6 AWG | #10 | .45 | .81 | .09 | 1.52 | Blue | P24 | 7 | 24 | 7/8 | 50 |
| LCA6-14-L | | 1/4 | .48 | .81 | .08 | 1.61 | Blue | P24 | 7 | 24 | 7/8 | 50 |
| LCA6-56-L | | 5/16 | .56 | .81 | .07 | 1.73 | Blue | P24 | 7 | 24 | 7/8 | 50 |
| LCA6-38-L | | 3/8 | .62 | .81 | .06 | 1.83 | Blue | P24 | 7 | 24 | 7/8 | 50 |
| LCA4-10-L | #4 – #3 AWG STR, | #10 | .55 | .81 | .09 | 1.54 | Gray | P29 | 8 | 29 | 7/8 | 50 |
| LCA4-14-L | #2 AWG SOL | 1/4 | .55 | .81 | .09 | 1.63 | Gray | P29 | 8 | 29 | 7/8 | 50 |
| LCA4-56-L | | 5/16 | .55 | .81 | .09 | 1.75 | Gray | P29 | 8 | 29 | 7/8 | 50 |
| LCA4-38-L | | 3/8 | .62 | .81 | .07 | 1.85 | Gray | P29 | 8 | 29 | 7/8 | 50 |
| LCA2-14-Q | #2 AWG | 1/4 | .60 | .88 | .10 | 1.77 | Brown | P33 | 10 | 33 | 15/16 | 25 |
| LCA2-56-Q | | 5/16 | .66 | .88 | .10 | 1.90 | Brown | P33 | 10 | 33 | 15/16 | 25 |
| LCA2-38-Q | | 3/8 | .66 | .88 | .10 | 1.97 | Brown | P33 | 10 | 33 | 15/16 | 25 |
| LCA2-12-Q | | 1/2 | .75 | .88 | .08 | 2.21 | Brown | P33 | 10 | 33 | 15/16 | 25 |
| LCA1-14-E | #1 AWG | 1/4 | .70 | .88 | .11 | 1.79 | Green | P37 | 11 | 37 | 15/16 | 20 |
| LCA1-56-E | | 5/16 | .70 | .88 | .11 | 1.92 | Green | P37 | 11 | 37 | 15/16 | 20 |
| LCA1-38-E | | 3/8 | .70 | .88 | .11 | 1.99 | Green | P37 | 11 | 37 | 15/16 | 20 |
| LCA1-12-E | | 1/2 | .75 | .88 | .09 | 2.23 | Green | P37 | 11 | 37 | 15/16 | 20 |

‡See pages D3.54 – D3.57 for tool and die information.

*Not tested to NEBS Level 3 requirements.

**Consult cable manufacturer for voltage stress relief instructions with applications greater than 2000 V.

Table continues on pages D2.14

A. System Overview

B1. Cable Ties

B2. Cable Accessories

B3. Stainless Steel Ties

C1. Wiring Duct

C2. Surface Raceway

C3. Abrasion Protection

C4. Cable Management

D1. Terminals

D2. Power Connectors

D3. Grounding Connectors

E1. Labeling Systems

E2. Labels

E3. Pre-Printed & Write-On Markers

E4. Permanent Identification

E5. Lockout/Tagout & Safety Solutions

F. Index

A.
System
Overview

B1.
Cable Ties

B2.
Cable
Accessories

B3.
Stainless
Steel Ties

C1.
Wiring
Duct

C2.
Surface
Raceway

C3.
Abrasion
Protection

C4.
Cable
Management

D1.
Terminals

D2.
Power
Connectors

D3.
Grounding
Connectors

E1.
Labeling
Systems

E2.
Labels

E3.
Pre-Printed
& Write-On
Markers

E4.
Permanent
Identification

E5.
Lockout/
Tagout
& Safety
Solutions

F.
Index



Code Conductor, One-Hole, Standard Barrel with Window Lug (continued)

| Part Number | Copper Conductor Size | Stud Hole Size (In.) | Figure Dimensions (In.) | | | | PANDUIT Color Code | PANDUIT Die Index No.‡ | Burndy Die Index No.‡ | T&B Die Index No.‡ | Wire Strip Length (In.) | Std. Pkg. Qty. |
|--------------------|-----------------------|----------------------|-------------------------|------|-----|------|--------------------|------------------------|-----------------------|--------------------|-------------------------|----------------|
| | | | W | B | T | L | | | | | | |
| LCA1/0-14-X | 1/0 AWG | 1/4 | .76 | .94 | .12 | 1.95 | Pink | P42 | 12 | 42 | 1 | 10 |
| LCA1/0-56-X | | 5/16 | .76 | .94 | .12 | 2.00 | Pink | P42 | 12 | 42 | 1 | 10 |
| LCA1/0-38-X | | 3/8 | .76 | .94 | .12 | 2.08 | Pink | P42 | 12 | 42 | 1 | 10 |
| LCA1/0-12-X | 2/0 AWG | 1/2 | .80 | .94 | .12 | 2.31 | Pink | P42 | 12 | 42 | 1 | 10 |
| LCA2/0-14-X | | 1/4 | .85 | .98 | .13 | 2.09 | Black | P45 | 13 | 45 | 1 1/16 | 10 |
| LCA2/0-56-X | | 5/16 | .85 | .98 | .13 | 2.09 | Black | P45 | 13 | 45 | 1 1/16 | 10 |
| LCA2/0-38-X | 3/0 AWG | 3/8 | .85 | .98 | .13 | 2.15 | Black | P45 | 13 | 45 | 1 1/16 | 10 |
| LCA2/0-12-X | | 1/2 | .85 | .98 | .13 | 2.40 | Black | P45 | 13 | 45 | 1 1/16 | 10 |
| LCA3/0-14-X | | 1/4 | .96 | 1.14 | .13 | 2.28 | Orange | P50 | 14 | 50 | 1 3/16 | 10 |
| LCA3/0-56-X | 4/0 AWG | 5/16 | .96 | 1.14 | .13 | 2.28 | Orange | P50 | 14 | 50 | 1 3/16 | 10 |
| LCA3/0-38-X | | 3/8 | .96 | 1.14 | .13 | 2.34 | Orange | P50 | 14 | 50 | 1 3/16 | 10 |
| LCA3/0-12-X | | 1/2 | .96 | 1.14 | .13 | 2.59 | Orange | P50 | 14 | 50 | 1 3/16 | 10 |
| LCA4/0-14-X | 250 kcmil | 1/4 | 1.06 | 1.19 | .14 | 2.36 | Purple | P54 | 15 | 54 | 1 1/4 | 10 |
| LCA4/0-56-X | | 5/16 | 1.06 | 1.19 | .14 | 2.38 | Purple | P54 | 15 | 54 | 1 1/4 | 10 |
| LCA4/0-38-X | | 3/8 | 1.06 | 1.19 | .14 | 2.45 | Purple | P54 | 15 | 54 | 1 1/4 | 10 |
| LCA4/0-12-X | 300 kcmil | 1/2 | 1.06 | 1.19 | .14 | 2.68 | Purple | P54 | 15 | 54 | 1 1/4 | 10 |
| LCA250-14-X | | 1/4 | 1.17 | 1.25 | .14 | 2.47 | Yellow | P62 | 16 | 62 | 1 5/16 | 10 |
| LCA250-56-X | | 5/16 | 1.17 | 1.25 | .14 | 2.48 | Yellow | P62 | 16 | 62 | 1 5/16 | 10 |
| LCA250-38-X | 350 kcmil | 3/8 | 1.17 | 1.25 | .14 | 2.55 | Yellow | P62 | 16 | 62 | 1 5/16 | 10 |
| LCA250-12-X | | 1/2 | 1.17 | 1.25 | .14 | 2.78 | Yellow | P62 | 16 | 62 | 1 5/16 | 10 |
| LCA300-56-X | | 5/16 | 1.19 | 1.44 | .16 | 2.94 | White | P66 | 17 | 66 | 1 1/2 | 10 |
| LCA300-38-X | 400 kcmil | 3/8 | 1.19 | 1.44 | .16 | 2.94 | White | P66 | 17 | 66 | 1 1/2 | 10 |
| LCA300-12-X | | 1/2 | 1.19 | 1.44 | .16 | 3.05 | White | P66 | 17 | 66 | 1 1/2 | 10 |
| LCA300-58-X | | 5/8 | 1.19 | 1.44 | .16 | 3.26 | White | P66 | 17 | 66 | 1 1/2 | 10 |
| LCA300-78-X | 500 kcmil | 7/8 | 1.19 | 1.44 | .16 | 3.70 | White | P66 | 17 | 66 | 1 1/2 | 10 |
| LCA350-38-X | | 3/8 | 1.28 | 1.44 | .17 | 2.98 | Red | P71 | 18 | 71 | 1 1/2 | 10 |
| LCA350-12-X | | 1/2 | 1.28 | 1.44 | .17 | 3.09 | Red | P71 | 18 | 71 | 1 1/2 | 10 |
| LCA350-58-X | 600 kcmil | 5/8 | 1.28 | 1.44 | .17 | 3.30 | Red | P71 | 18 | 71 | 1 1/2 | 10 |
| LCA350-78-X | | 7/8 | 1.28 | 1.44 | .17 | 3.74 | Red | P71 | 18 | 71 | 1 1/2 | 10 |
| LCA400-38-6 | | 3/8 | 1.39 | 1.50 | .18 | 3.22 | Blue | P76 | 19 | 76 | 1 9/16 | 6 |
| LCA400-12-6 | 750 kcmil | 1/2 | 1.39 | 1.50 | .18 | 3.22 | Blue | P76 | 19 | 76 | 1 9/16 | 6 |
| LCA400-58-6 | | 5/8 | 1.39 | 1.50 | .18 | 3.43 | Blue | P76 | 19 | 76 | 1 9/16 | 6 |
| LCA400-78-6 | | 7/8 | 1.39 | 1.50 | .18 | 3.82 | Blue | P76 | 19 | 76 | 1 9/16 | 6 |
| LCA500-38-6 | E1, E2, E3, E4, E5 | 3/8 | 1.54 | 1.75 | .22 | 3.39 | Brown | P87 | 20 | 87 | 1 13/16 | 6 |
| LCA500-12-6 | | 1/2 | 1.54 | 1.75 | .22 | 3.55 | Brown | P87 | 20 | 87 | 1 13/16 | 6 |
| LCA500-58-6 | | 5/8 | 1.54 | 1.75 | .22 | 3.76 | Brown | P87 | 20 | 87 | 1 13/16 | 6 |
| LCA500-34-6 | E1, E2, E3, E4, E5 | 3/4 | 1.54 | 1.75 | .22 | 3.90 | Brown | P87 | 20 | 87 | 1 13/16 | 6 |
| LCA500-78-6 | | 7/8 | 1.54 | 1.75 | .22 | 4.15 | Brown | P87 | 20 | 87 | 1 13/16 | 6 |
| LCA500-1-6 | | 1 | 1.54 | 1.75 | .22 | 4.27 | Brown | P87 | 20 | 87 | 1 13/16 | 6 |
| LCA600-12-6 | E1, E2, E3, E4, E5 | 1/2 | 1.70 | 1.75 | .26 | 4.20 | Green | P94 | 22 | 94 | 1 13/16 | 6 |
| LCA600-58-6 | | 5/8 | 1.70 | 1.75 | .26 | 4.20 | Green | P94 | 22 | 94 | 1 13/16 | 6 |
| LCA600-78-6 | | 7/8 | 1.70 | 1.75 | .26 | 4.20 | Green | P94 | 22 | 94 | 1 13/16 | 6 |
| LCA750-58-6 | E1, E2, E3, E4, E5 | 5/8 | 1.89 | 1.88 | .26 | 4.59 | Black | P106 | 24 | 106 | 1 15/16 | 6 |

‡See pages D3.54 – D3.57 for tool and die information.

*Not tested to NEBS Level 3 requirements.

**Consult cable manufacturer for voltage stress relief instructions with applications greater than 2000 V.



Code Conductor, One-Hole, Standard Barrel with Window Lug, 45° Angle

For Use with Stranded Copper Conductors

Type LCA-H

- Color-coded barrels marked with *PANDUIT* and specified competitor die index numbers for proper crimp die selection
- Inspection window to visually assure full conductor insertion
- Tin-plated to inhibit corrosion
- UL Listed and CSA Certified to 35 KV** and temperature rated to 90°C when crimped with *PANDUIT* and specified competitor crimping tools and dies

- UL Listed and CSA Certified for wide wire range-taking capability when crimped with *PANDUIT*® *UNI-DIE*™ Dieless Crimping Tools‡
- **Tested by Telcordia – meets NEBS Level 3**
- American Bureau of Shipping approved

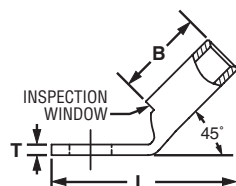
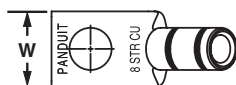

| Part Number | Copper Conductor Size | Stud Hole Size (In.) | Figure Dimensions (In.) | | | | PANDUIT Color Code | PANDUIT Die Index No.‡ | Burndy Die Index No.‡ | T&B Die Index No.‡ | Wire Strip Length (In.) | Std. Pkg. Qty. |
|--------------|------------------------------------|----------------------|-------------------------|-----|-----|------|--------------------|------------------------|-----------------------|--------------------|-------------------------|----------------|
| | | | W | B | T | L | | | | | | |
| LCA10-14H-L* | #14 – 10 AWG STR, #12 – 10 AWG SOL | 1/4 | .42 | .38 | .05 | 1.05 | — | — | — | — | 7/16 | 50 |
| LCA8-10H-L | #8 AWG | #10 | .41 | .56 | .08 | 1.10 | Red | P21 | 49 | 21 | 5/8 | 50 |
| LCA8-14H-L | | 1/4 | .48 | .56 | .07 | 1.19 | Red | P21 | 49 | 21 | 5/8 | 50 |
| LCA8-56H-L | | 5/16 | .56 | .56 | .05 | 1.30 | Red | P21 | 49 | 21 | 5/8 | 50 |
| LCA8-38H-L | | 3/8 | .60 | .56 | .05 | 1.40 | Red | P21 | 49 | 21 | 5/8 | 50 |
| LCA6-10H-L | #6 AWG | #10 | .45 | .81 | .09 | 1.29 | Blue | P24 | 7 | 24 | 7/8 | 50 |
| LCA6-14H-L | | 1/4 | .48 | .81 | .08 | 1.38 | Blue | P24 | 7 | 24 | 7/8 | 50 |
| LCA6-56H-L | | 5/16 | .56 | .81 | .07 | 1.49 | Blue | P24 | 7 | 24 | 7/8 | 50 |
| LCA6-38H-L | | 3/8 | .62 | .81 | .06 | 1.59 | Blue | P24 | 7 | 24 | 7/8 | 50 |
| LCA4-10H-L | #4 – 3 AWG STR, #2 AWG SOL | #10 | .55 | .81 | .09 | 1.31 | Gray | P29 | 8 | 29 | 7/8 | 50 |
| LCA4-14H-L | | 1/4 | .55 | .81 | .09 | 1.40 | Gray | P29 | 8 | 29 | 7/8 | 50 |
| LCA4-56H-L | | 5/16 | .55 | .81 | .09 | 1.52 | Gray | P29 | 8 | 29 | 7/8 | 50 |
| LCA4-38H-L | | 3/8 | .62 | .81 | .07 | 1.61 | Gray | P29 | 8 | 29 | 7/8 | 50 |
| LCA2-14H-Q | #2 AWG | 1/4 | .60 | .88 | .10 | 1.49 | Brown | P33 | 10 | 33 | 15/16 | 25 |
| LCA2-56H-Q | | 5/16 | .66 | .88 | .10 | 1.61 | Brown | P33 | 10 | 33 | 15/16 | 25 |
| LCA2-38H-Q | | 3/8 | .66 | .88 | .10 | 1.68 | Brown | P33 | 10 | 33 | 15/16 | 25 |
| LCA2-12H-Q | | 1/2 | .75 | .88 | .08 | 1.90 | Brown | P33 | 10 | 33 | 15/16 | 25 |

‡See pages D3.54 – D3.57 for tool and die information.

*Not tested to NEBS Level 3 requirements.

**Consult cable manufacturer for voltage stress relief instructions with applications greater than 2000 V.

Table continues on pages D2.16

A. System Overview

B1. Cable Ties

B2. Cable Accessories

B3. Stainless Steel Ties

C1. Wiring Duct

C2. Surface Raceway

C3. Abrasion Protection

C4. Cable Management

D1. Terminals

D2. Power Connectors

D3. Grounding Connectors

E1. Labeling Systems

E2. Labels

E3. Pre-Printed & Write-On Markers

E4. Permanent Identification

E5. Lockout/Tagout & Safety Solutions

F. Index

A.
System
Overview



Code Conductor, One-Hole, Standard Barrel with Window Lug, 45° Angle (continued)

B1.
Cable Ties

B2.
Cable
Accessories

B3.
Stainless
Steel Ties

C1.
Wiring
Duct

C2.
Surface
Raceway

C3.
Abrasion
Protection

C4.
Cable
Management

D1.
Terminals

D2.
Power
Connectors

D3.
Grounding
Connectors

E1.
Labeling
Systems

E2.
Labels

E3.
Pre-Printed
& Write-On
Markers

E4.
Permanent
Identification

E5.
Lockout/
Tagout
& Safety
Solutions

F.
Index

| Part Number | Copper Conductor Size | Stud Hole Size (In.) | Figure Dimensions (In.) | | | | PANDUIT Color Code | PANDUIT Die Index No.‡ | Burndy Die Index No.‡ | T&B Die Index No.‡ | Wire Strip Length (In.) | Std. Pkg. Qty. |
|---------------------|-----------------------|----------------------|-------------------------|------|-----|------|--------------------|------------------------|-----------------------|--------------------|-------------------------|----------------|
| | | | W | B | T | L | | | | | | |
| LCA1-14H-E | #1 AWG | 1/4 | .70 | .88 | .11 | 1.50 | Green | P37 | 11 | 37 | 15/16 | 20 |
| LCA1-56H-E | | 5/16 | .70 | .88 | .11 | 1.62 | Green | P37 | 11 | 37 | 15/16 | 20 |
| LCA1-38H-E | | 3/8 | .70 | .88 | .11 | 1.70 | Green | P37 | 11 | 37 | 15/16 | 20 |
| LCA1-12H-E | | 1/2 | .75 | .88 | .09 | 1.93 | Green | P37 | 11 | 37 | 15/16 | 20 |
| LCA1/0-14H-X | 1/0 AWG | 1/4 | .76 | .94 | .12 | 1.63 | Pink | P42 | 12 | 42 | 1 | 10 |
| LCA1/0-56H-X | | 5/16 | .76 | .94 | .12 | 1.69 | Pink | P42 | 12 | 42 | 1 | 10 |
| LCA1/0-38H-X | | 3/8 | .76 | .94 | .12 | 1.76 | Pink | P42 | 12 | 42 | 1 | 10 |
| LCA1/0-12H-X | | 1/2 | .80 | .94 | .12 | 1.99 | Pink | P42 | 12 | 42 | 1 | 10 |
| LCA2/0-14H-X | 2/0 AWG | 1/4 | .85 | .98 | .13 | 1.77 | Black | P45 | 13 | 45 | 1 1/16 | 10 |
| LCA2/0-56H-X | | 5/16 | .85 | .98 | .13 | 1.77 | Black | P45 | 13 | 45 | 1 1/16 | 10 |
| LCA2/0-38H-X | | 3/8 | .85 | .98 | .13 | 1.83 | Black | P45 | 13 | 45 | 1 1/16 | 10 |
| LCA2/0-12H-X | | 1/2 | .85 | .98 | .13 | 2.08 | Black | P45 | 13 | 45 | 1 1/16 | 10 |
| LCA2/0-34H-X | | 3/4 | 1.06 | .98 | .09 | 2.66 | Black | P45 | 13 | 45 | 1 1/16 | 10 |
| LCA3/0-14H-X | 3/0 AWG | 1/4 | .96 | 1.14 | .13 | 1.90 | Orange | P50 | 14 | 50 | 1 3/16 | 10 |
| LCA3/0-56H-X | | 5/16 | .96 | 1.14 | .13 | 1.90 | Orange | P50 | 14 | 50 | 1 3/16 | 10 |
| LCA3/0-38H-X | | 3/8 | .96 | 1.14 | .13 | 1.96 | Orange | P50 | 14 | 50 | 1 3/16 | 10 |
| LCA3/0-12H-X | | 1/2 | .96 | 1.14 | .13 | 2.21 | Orange | P50 | 14 | 50 | 1 3/16 | 10 |
| LCA4/0-14H-X | 4/0 AWG | 1/4 | 1.06 | 1.19 | .14 | 1.97 | Purple | P54 | 15 | 54 | 1 1/4 | 10 |
| LCA4/0-56H-X | | 5/16 | 1.06 | 1.19 | .14 | 1.98 | Purple | P54 | 15 | 54 | 1 1/4 | 10 |
| LCA4/0-38H-X | | 3/8 | 1.06 | 1.19 | .14 | 2.05 | Purple | P54 | 15 | 54 | 1 1/4 | 10 |
| LCA4/0-12H-X | | 1/2 | 1.06 | 1.19 | .14 | 2.28 | Purple | P54 | 15 | 54 | 1 1/4 | 10 |
| LCA250-14H-X | 250 kcmil | 1/4 | 1.17 | 1.25 | .14 | 2.05 | Yellow | P62 | 16 | 62 | 1 5/16 | 10 |
| LCA250-56H-X | | 5/16 | 1.17 | 1.25 | .14 | 2.06 | Yellow | P62 | 16 | 62 | 1 5/16 | 10 |
| LCA250-38H-X | | 3/8 | 1.17 | 1.25 | .14 | 2.13 | Yellow | P62 | 16 | 62 | 1 5/16 | 10 |
| LCA250-12H-X | | 1/2 | 1.17 | 1.25 | .14 | 2.36 | Yellow | P62 | 16 | 62 | 1 5/16 | 10 |
| LCA300-56H-X | 300 kcmil | 5/16 | 1.19 | 1.44 | .16 | 2.55 | White | P66 | 17 | 66 | 1 1/2 | 10 |
| LCA300-38H-X | | 3/8 | 1.19 | 1.44 | .16 | 2.55 | White | P66 | 17 | 66 | 1 1/2 | 10 |
| LCA300-12H-X | | 1/2 | 1.19 | 1.44 | .16 | 2.66 | White | P66 | 17 | 66 | 1 1/2 | 10 |
| LCA300-58H-X | | 5/8 | 1.19 | 1.44 | .16 | 2.87 | White | P66 | 17 | 66 | 1 1/2 | 10 |
| LCA300-78H-X | | 7/8 | 1.19 | 1.44 | .16 | 3.31 | White | P66 | 17 | 66 | 1 1/2 | 10 |
| LCA350-38H-X | 350 kcmil | 3/8 | 1.28 | 1.44 | .17 | 2.59 | Red | P71 | 18 | 71 | 1 1/2 | 10 |
| LCA350-12H-X | | 1/2 | 1.28 | 1.44 | .17 | 2.70 | Red | P71 | 18 | 71 | 1 1/2 | 10 |
| LCA350-58H-X | | 5/8 | 1.28 | 1.44 | .17 | 2.91 | Red | P71 | 18 | 71 | 1 1/2 | 10 |
| LCA350-78H-X | | 7/8 | 1.28 | 1.44 | .17 | 3.35 | Red | P71 | 18 | 71 | 1 1/2 | 10 |
| LCA400-38H-6 | 400 kcmil | 3/8 | 1.39 | 1.50 | .18 | 2.85 | Blue | P76 | 19 | 76 | 1 9/16 | 6 |
| LCA400-12H-6 | | 1/2 | 1.39 | 1.50 | .18 | 2.85 | Blue | P76 | 19 | 76 | 1 9/16 | 6 |
| LCA400-58H-6 | | 5/8 | 1.39 | 1.50 | .18 | 3.06 | Blue | P76 | 19 | 76 | 1 9/16 | 6 |
| LCA400-78H-6 | | 7/8 | 1.39 | 1.50 | .18 | 3.45 | Blue | P76 | 19 | 76 | 1 9/16 | 6 |
| LCA500-38H-6 | 500 kcmil | 3/8 | 1.54 | 1.75 | .22 | 2.94 | Brown | P87 | 20 | 87 | 1 13/16 | 6 |
| LCA500-12H-6 | | 1/2 | 1.54 | 1.75 | .22 | 3.10 | Brown | P87 | 20 | 87 | 1 13/16 | 6 |
| LCA500-58H-6 | | 5/8 | 1.54 | 1.75 | .22 | 3.31 | Brown | P87 | 20 | 87 | 1 13/16 | 6 |
| LCA500-34H-6 | | 3/4 | 1.54 | 1.75 | .22 | 3.45 | Brown | P87 | 20 | 87 | 1 13/16 | 6 |
| LCA500-78H-6 | | 7/8 | 1.54 | 1.75 | .22 | 3.70 | Brown | P87 | 20 | 87 | 1 13/16 | 6 |
| LCA500-1H-6 | | 1 | 1.54 | 1.75 | .22 | 3.82 | Brown | P87 | 20 | 87 | 1 13/16 | 6 |
| LCA600-12H-6 | 600 kcmil | 1/2 | 1.70 | 1.75 | .26 | 3.76 | Green | P94 | 22 | 94 | 1 13/16 | 6 |
| LCA600-58H-6 | | 5/8 | 1.70 | 1.75 | .26 | 3.76 | Green | P94 | 22 | 94 | 1 13/16 | 6 |
| LCA600-78H-6 | | 7/8 | 1.70 | 1.75 | .26 | 3.76 | Green | P94 | 22 | 94 | 1 13/16 | 6 |

‡See pages D3.54 – D3.57 for tool and die information.

**Consult cable manufacturer for voltage stress relief instructions with applications greater than 2000 V.



Code Conductor, One-Hole, Standard Barrel with Window Lug, 90° Angle

For Use with Stranded Copper Conductors

Type LCA-F

- Color-coded barrels marked with *PANDUIT* and specified competitor die index numbers for proper crimp die selection
- Inspection window to visually assure full conductor insertion
- Tin-plated to inhibit corrosion
- UL Listed and CSA Certified to 35 KV** and temperature rated to 90°C when crimped with *PANDUIT* and specified competitor crimping tools and dies



- UL Listed and CSA Certified for wide wire range-taking capability when crimped with *PANDUIT*® *UNI-DIE*™ Dieless Crimping Tools‡
- **Tested by Telcordia – meets NEBS Level 3**
- American Bureau of Shipping Approved

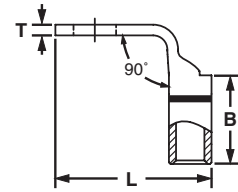
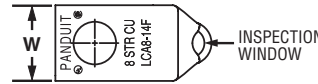

| Part Number | Copper Conductor Size | Stud Hole Size (In.) | Figure Dimensions (In.) | | | | PANDUIT Color Code | PANDUIT Die Index No.‡ | Burdny Die Index No.‡ | T&B Die Index No.‡ | Wire Strip Length (In.) | Std. Pkg. Qty. |
|--------------|------------------------------------|----------------------|-------------------------|-----|-----|------|--------------------|------------------------|-----------------------|--------------------|-------------------------|----------------|
| | | | W | B | T | L | | | | | | |
| LCA10-14F-L* | #14 – 10 AWG STR, #12 – 10 AWG SOL | 1/4 | .42 | .38 | .05 | .94 | — | — | — | — | 7/16 | 50 |
| LCA8-10F-L | #8 AWG | #10 | .41 | .56 | .08 | .90 | Red | P21 | 49 | 21 | 5/8 | 50 |
| LCA8-14F-L | | 1/4 | .48 | .56 | .07 | .99 | Red | P21 | 49 | 21 | 5/8 | 50 |
| LCA8-56F-L | | 5/16 | .56 | .56 | .05 | 1.11 | Red | P21 | 49 | 21 | 5/8 | 50 |
| LCA8-38F-L | | 3/8 | .60 | .56 | .05 | 1.21 | Red | P21 | 49 | 21 | 5/8 | 50 |
| LCA6-10F-L | #6 AWG | #10 | .45 | .81 | .09 | .94 | Blue | P24 | 7 | 24 | 7/8 | 50 |
| LCA6-14F-L | | 1/4 | .48 | .81 | .08 | 1.03 | Blue | P24 | 7 | 24 | 7/8 | 50 |
| LCA6-56F-L | | 5/16 | .56 | .81 | .07 | 1.15 | Blue | P24 | 7 | 24 | 7/8 | 50 |
| LCA6-38F-L | | 3/8 | .62 | .81 | .06 | 1.25 | Blue | P24 | 7 | 24 | 7/8 | 50 |
| LCA4-10F-L | #4 – 3 AWG STR, #2 AWG SOL | #10 | .55 | .81 | .09 | 1.03 | Gray | P29 | 8 | 29 | 7/8 | 50 |
| LCA4-14F-L | | 1/4 | .55 | .81 | .09 | 1.12 | Gray | P29 | 8 | 29 | 7/8 | 50 |
| LCA4-56F-L | | 5/16 | .55 | .81 | .09 | 1.24 | Gray | P29 | 8 | 29 | 7/8 | 50 |
| LCA4-38F-L | | 3/8 | .62 | .81 | .07 | 1.34 | Gray | P29 | 8 | 29 | 7/8 | 50 |
| LCA2-14F-Q | #2 AWG | 1/4 | .60 | .88 | .10 | 1.24 | Brown | P33 | 10 | 33 | 15/16 | 25 |
| LCA2-56F-Q | | 5/16 | .66 | .88 | .10 | 1.36 | Brown | P33 | 10 | 33 | 15/16 | 25 |
| LCA2-38F-Q | | 3/8 | .66 | .88 | .10 | 1.44 | Brown | P33 | 10 | 33 | 15/16 | 25 |
| LCA2-12F-Q | | 1/2 | .75 | .88 | .08 | 1.67 | Brown | P33 | 10 | 33 | 15/16 | 25 |
| LCA1-14F-E | #1 AWG | 1/4 | .70 | .88 | .11 | 1.31 | Green | P37 | 11 | 37 | 15/16 | 20 |
| LCA1-56F-E | | 5/16 | .70 | .88 | .11 | 1.44 | Green | P37 | 11 | 37 | 15/16 | 20 |
| LCA1-38F-E | | 3/8 | .70 | .88 | .11 | 1.51 | Green | P37 | 11 | 37 | 15/16 | 20 |
| LCA1-12F-E | | 1/2 | .75 | .88 | .09 | 1.75 | Green | P37 | 11 | 37 | 15/16 | 20 |
| LCA1/0-14F-X | 1/0 AWG | 1/4 | .76 | .94 | .12 | 1.45 | Pink | P42 | 12 | 42 | 1 | 10 |
| LCA1/0-56F-X | | 5/16 | .76 | .94 | .12 | 1.51 | Pink | P42 | 12 | 42 | 1 | 10 |
| LCA1/0-38F-X | | 3/8 | .76 | .94 | .12 | 1.58 | Pink | P42 | 12 | 42 | 1 | 10 |
| LCA1/0-12F-X | | 1/2 | .80 | .94 | .12 | 1.82 | Pink | P42 | 12 | 42 | 1 | 10 |
| LCA2/0-14F-X | 2/0 AWG | 1/4 | .85 | .98 | .13 | 1.61 | Black | P45 | 13 | 45 | 1 1/16 | 10 |
| LCA2/0-56F-X | | 5/16 | .85 | .98 | .13 | 1.59 | Black | P45 | 13 | 45 | 1 1/16 | 10 |
| LCA2/0-38F-X | | 3/8 | .85 | .98 | .13 | 1.66 | Black | P45 | 13 | 45 | 1 1/16 | 10 |
| LCA2/0-12F-X | | 1/2 | .85 | .98 | .13 | 1.91 | Black | P45 | 13 | 45 | 1 1/16 | 10 |

‡See pages D3.54 – D3.57 for tool and die information.

*Not tested to NEBS Level 3 requirements.

**Consult cable manufacturer for voltage stress relief instructions with applications greater than 2000 V.

Table continues on pages D2.18

A. System Overview

B1. Cable Ties

B2. Cable Accessories

B3. Stainless Steel Ties

C1. Wiring Duct

C2. Surface Raceway

C3. Abrasion Protection

C4. Cable Management

D1. Terminals

D2. Power Connectors

D3. Grounding Connectors

E1. Labeling Systems

E2. Labels

E3. Pre-Printed & Write-On Markers

E4. Permanent Identification

E5. Lockout/Tagout & Safety Solutions

F. Index

A.
System
Overview



Code Conductor, One-Hole, Standard Barrel with Window Lug, 90° Angle (continued)

B1.
Cable Ties

B2.
Cable
Accessories

B3.
Stainless
Steel Ties

C1.
Wiring
Duct

C2.
Surface
Raceway

C3.
Abrasion
Protection

C4.
Cable
Management

D1.
Terminals

D2.
Power
Connectors

D3.
Grounding
Connectors

E1.
Labeling
Systems

E2.
Labels

E3.
Pre-Printed
& Write-On
Markers

E4.
Permanent
Identification

E5.
Lockout/
Tagout
& Safety
Solutions

F.
Index

| Part Number | Copper Conductor Size | Stud Hole Size (In.) | Figure Dimensions (In.) | | | | PANDUIT Color Code | PANDUIT Die Index No.‡ | Burdny Die Index No.‡ | T&B Die Index No.‡ | Wire Strip Length (In.) | Std. Pkg. Qty. |
|---------------------|-----------------------|----------------------|-------------------------|------|-----|------|--------------------|------------------------|-----------------------|--------------------|-------------------------|----------------|
| | | | W | B | T | L | | | | | | |
| LCA3/0-14F-X | 3/0 AWG | 1/4 | .96 | 1.14 | .13 | 1.67 | Orange | P50 | 14 | 50 | 1 3/16 | 10 |
| LCA3/0-56F-X | | 5/16 | .96 | 1.14 | .13 | 1.67 | Orange | P50 | 14 | 50 | 1 3/16 | 10 |
| LCA3/0-38F-X | | 3/8 | .96 | 1.14 | .13 | 1.73 | Orange | P50 | 14 | 50 | 1 3/16 | 10 |
| LCA3/0-12F-X | | 1/2 | .96 | 1.14 | .13 | 1.98 | Orange | P50 | 14 | 50 | 1 3/16 | 10 |
| LCA4/0-14F-X | 4/0 AWG | 1/4 | 1.06 | 1.19 | .14 | 1.75 | Purple | P54 | 15 | 54 | 1 1/4 | 10 |
| LCA4/0-56F-X | | 5/16 | 1.06 | 1.19 | .14 | 1.77 | Purple | P54 | 15 | 54 | 1 1/4 | 10 |
| LCA4/0-38F-X | | 3/8 | 1.06 | 1.19 | .14 | 1.84 | Purple | P54 | 15 | 54 | 1 1/4 | 10 |
| LCA4/0-12F-X | | 1/2 | 1.06 | 1.19 | .14 | 2.07 | Purple | P54 | 15 | 54 | 1 1/4 | 10 |
| LCA250-14F-X | 250 kcmil | 1/4 | 1.17 | 1.25 | .14 | 1.82 | Yellow | P62 | 16 | 62 | 1 5/16 | 10 |
| LCA250-56F-X | | 5/16 | 1.17 | 1.25 | .14 | 1.83 | Yellow | P62 | 16 | 62 | 1 5/16 | 10 |
| LCA250-38F-X | | 3/8 | 1.17 | 1.25 | .14 | 1.90 | Yellow | P62 | 16 | 62 | 1 5/16 | 10 |
| LCA250-12F-X | | 1/2 | 1.17 | 1.25 | .14 | 2.13 | Yellow | P62 | 16 | 62 | 1 5/16 | 10 |
| LCA300-56F-X | 300 kcmil | 5/16 | 1.19 | 1.44 | .16 | 2.07 | White | P66 | 17 | 66 | 1 1/2 | 10 |
| LCA300-38F-X | | 3/8 | 1.19 | 1.44 | .16 | 2.07 | White | P66 | 17 | 66 | 1 1/2 | 10 |
| LCA300-12F-X | | 1/2 | 1.19 | 1.44 | .16 | 2.18 | White | P66 | 17 | 66 | 1 1/2 | 10 |
| LCA300-58F-X | | 5/8 | 1.19 | 1.44 | .16 | 2.39 | White | P66 | 17 | 66 | 1 1/2 | 10 |
| LCA300-78F-X | | 7/8 | 1.19 | 1.44 | .16 | 2.83 | White | P66 | 17 | 66 | 1 1/2 | 10 |
| LCA350-38F-X | 350 kcmil | 3/8 | 1.28 | 1.44 | .17 | 2.13 | Red | P71 | 18 | 71 | 1 1/2 | 10 |
| LCA350-12F-X | | 1/2 | 1.28 | 1.44 | .17 | 2.24 | Red | P71 | 18 | 71 | 1 1/2 | 10 |
| LCA350-58F-X | | 5/8 | 1.28 | 1.44 | .17 | 2.45 | Red | P71 | 18 | 71 | 1 1/2 | 10 |
| LCA350-78F-X | | 7/8 | 1.28 | 1.44 | .17 | 2.89 | Red | P71 | 18 | 71 | 1 1/2 | 10 |
| LCA400-38F-6 | 400 kcmil | 3/8 | 1.39 | 1.50 | .18 | 2.37 | Blue | P76 | 19 | 76 | 1 9/16 | 6 |
| LCA400-12F-6 | | 1/2 | 1.39 | 1.50 | .18 | 2.37 | Blue | P76 | 19 | 76 | 1 9/16 | 6 |
| LCA400-58F-6 | | 5/8 | 1.39 | 1.50 | .18 | 2.58 | Blue | P76 | 19 | 76 | 1 9/16 | 6 |
| LCA400-78F-6 | | 7/8 | 1.39 | 1.50 | .18 | 2.97 | Blue | P76 | 19 | 76 | 1 9/16 | 6 |
| LCA500-38F-6 | 500 kcmil | 3/8 | 1.54 | 1.75 | .22 | 2.32 | Brown | P87 | 20 | 87 | 1 13/16 | 6 |
| LCA500-12F-6 | | 1/2 | 1.54 | 1.75 | .22 | 2.48 | Brown | P87 | 20 | 87 | 1 13/16 | 6 |
| LCA500-58F-6 | | 5/8 | 1.54 | 1.75 | .22 | 2.69 | Brown | P87 | 20 | 87 | 1 13/16 | 6 |
| LCA500-34F-6 | | 3/4 | 1.54 | 1.75 | .22 | 2.83 | Brown | P87 | 20 | 87 | 1 13/16 | 6 |
| LCA500-78F-6 | | 7/8 | 1.54 | 1.75 | .22 | 3.08 | Brown | P87 | 20 | 87 | 1 13/16 | 6 |
| LCA500-1F-6 | | 1 | 1.54 | 1.75 | .22 | 3.20 | Brown | P87 | 20 | 87 | 1 13/16 | 6 |
| LCA600-12F-6 | 600 kcmil | 1/2 | 1.70 | 1.75 | .26 | 3.21 | Green | P94 | 22 | 94 | 1 13/16 | 6 |
| LCA600-58F-6 | | 5/8 | 1.70 | 1.75 | .26 | 3.21 | Green | P94 | 22 | 94 | 1 13/16 | 6 |
| LCA600-78F-6 | | 7/8 | 1.70 | 1.75 | .26 | 3.21 | Green | P94 | 22 | 94 | 1 13/16 | 6 |

‡See pages D3.54 – D3.57 for tool and die information.

**Consult cable manufacturer for voltage stress relief instructions with applications greater than 2000 V.



Code Conductor, One-Hole, Standard Barrel with Window, Narrow Tongue Lug

For Use with Stranded Copper Conductors

Type LKAN

- Narrow tongue width for limited space applications
- Color-coded barrels marked with *PANDUIT* and specified competitor die index numbers for proper crimp die selection
- Inspection window to visually assure full conductor insertion
- Tin-plated to inhibit corrosion
- UL Listed and CSA Certified to 35 KV** and temperature rated to 90°C when crimped with *PANDUIT* and specified competitor crimping tools and dies
- UL Listed and CSA Certified for wide wire range-taking capability when crimped with *PANDUIT*® *UNI-DIE*™ Dieless Crimping Tools‡

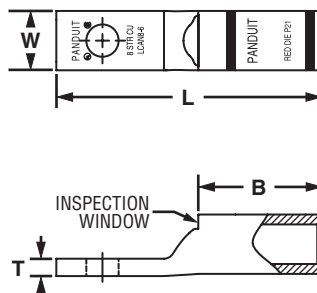

| Part Number | Copper Conductor Size | Stud Hole Size (In.) | Figure Dimensions (In.) | | | | PANDUIT Color Code | PANDUIT Die Index No.‡ | Burndy Die Index No.‡ | T&B Die Index No.‡ | Wire Strip Length (In.) | Std. Pkg. Qty. |
|--------------|------------------------|----------------------|-------------------------|------|------|-------|--------------------|------------------------|-----------------------|--------------------|-------------------------|----------------|
| | | | W | B | T | L | | | | | | |
| LCAN8-6-L | #8 AWG | #6 | .27 | .56 | .09 | 1.24 | Red | P21 | 49 | 21 | 5/8 | 50 |
| LCAN6-6-L | #6 AWG | #6 | .31 | .81 | .09 | 1.51 | Blue | P24 | 7 | 24 | 7/8 | 50 |
| LCAN4-10-L | #4 – 3 AWG, #2 AWG SOL | #10 | .38 | .81 | .10 | 1.54 | Gray | P29 | 8 | 29 | 7/8 | 50 |
| LCAN4-14-L | | 1/4 | .38 | .81 | .10 | 1.63 | Gray | P29 | 8 | 29 | 7/8 | 50 |
| LCAN2-10-Q | #3 – 2 AWG | #10 | .42 | .88 | .11 | 1.67 | Brown | P33 | 10 | 33 | 15/16 | 25 |
| LCAN2-14-Q | | 1/4 | .42 | .88 | .11 | 1.77 | Brown | P33 | 10 | 33 | 15/16 | 25 |
| LCAN1-10-E | #1 AWG | #10 | .47 | .88 | .11 | 1.69 | Green | P37 | 11 | 37 | 15/16 | 20 |
| LCAN1-14-E | | 1/4 | .47 | .88 | .11 | 1.79 | Green | P37 | 11 | 37 | 15/16 | 20 |
| LCAN1/0-10-X | 1/0 AWG | #10 | .52 | .94 | .13 | 1.78 | Pink | P42 | 12 | 42 | 1 | 10 |
| LCAN1/0-14-X | | 1/4 | .52 | .94 | .13 | 1.95 | Pink | P42 | 12 | 42 | 1 | 10 |
| LCAN1/0-56-X | | 5/16 | .52 | .94 | .13 | 2.00 | Pink | P42 | 12 | 42 | 1 | 10 |
| LCAN2/0-10-X | 2/0 AWG | #10 | .58 | .98 | .13 | 1.84 | Black | P45 | 13 | 45 | 1 1/16 | 10 |
| LCAN2/0-14-X | | 1/4 | .58 | .98 | .13 | 2.09 | Black | P45 | 13 | 45 | 1 1/16 | 10 |
| LCAN2/0-56-X | | 5/16 | .58 | .98 | .13 | 2.09 | Black | P45 | 13 | 45 | 1 1/16 | 10 |
| LCAN2/0-38-X | 3/8 | .58 | .98 | .13 | 2.15 | Black | P45 | 13 | 45 | 1 1/16 | 10 | |
| LCAN3/0-14-X | 3/0 AWG | 1/4 | .64 | 1.14 | .13 | 2.28 | Orange | P50 | 14 | 50 | 1 3/16 | 10 |
| LCAN3/0-56-X | | 5/16 | .64 | 1.14 | .13 | 2.28 | Orange | P50 | 14 | 50 | 1 3/16 | 10 |
| LCAN3/0-38-X | | 3/8 | .64 | 1.14 | .13 | 2.34 | Orange | P50 | 14 | 50 | 1 3/16 | 10 |
| LCAN4/0-14-X | 4/0 AWG | 1/4 | .71 | 1.19 | .14 | 2.36 | Purple | P54 | 15 | 54 | 1 1/4 | 10 |
| LCAN4/0-56-X | | 5/16 | .71 | 1.19 | .14 | 2.38 | Purple | P54 | 15 | 54 | 1 1/4 | 10 |
| LCAN4/0-38-X | | 3/8 | .71 | 1.19 | .14 | 2.45 | Purple | P54 | 15 | 54 | 1 1/4 | 10 |

‡See pages D3.54 – D3.57 for tool and die information.

**Consult cable manufacturer for voltage stress relief instructions with applications greater than 2000 V.

Table continues on page D2.20

- A. System Overview
- B1. Cable Ties
- B2. Cable Accessories
- B3. Stainless Steel Ties
- C1. Wiring Duct
- C2. Surface Raceway
- C3. Abrasion Protection
- C4. Cable Management
- D1. Terminals
- D2. Power Connectors
- D3. Grounding Connectors
- E1. Labeling Systems
- E2. Labels
- E3. Pre-Printed & Write-On Markers
- E4. Permanent Identification
- E5. Lockout/Tagout & Safety Solutions
- F. Index

A.
System
Overview



Code Conductor, One-Hole, Standard Barrel with Window, Narrow Tongue Lug (continued)

B1.
Cable Ties

| Part Number | Copper Conductor Size | Stud Hole Size (In.) | Figure Dimensions (In.) | | | | PANDUIT Color Code | PANDUIT Die Index No.‡ | Burndy Die Index No.‡ | T&B Die Index No.‡ | Wire Strip Length (In.) | Std. Pkg. Qty. |
|---------------------|-----------------------|----------------------|-------------------------|------|-----|------|--------------------|------------------------|-----------------------|--------------------|-------------------------|----------------|
| | | | W | B | T | L | | | | | | |
| LCAN250-14-X | 250 kcmil | 1/4 | .77 | 1.25 | .14 | 2.47 | Yellow | P62 | 16 | 62 | 1 5/16 | 10 |
| LCAN250-38-X | | 3/8 | .77 | 1.25 | .14 | 2.55 | Yellow | P62 | 16 | 62 | 1 5/16 | 10 |
| LCAN300-14-X | 300 kcmil | 1/4 | .81 | 1.44 | .16 | 2.90 | White | P66 | 17 | 66 | 1 1/2 | 10 |
| LCAN300-38-X | | 3/8 | .81 | 1.44 | .16 | 2.94 | White | P66 | 17 | 66 | 1 1/2 | 10 |
| LCAN350-38-X | 350 kcmil | 3/8 | .88 | 1.44 | .17 | 2.98 | Red | P71 | 18 | 71 | 1 1/2 | 10 |
| LCAN350-12-X | | 1/2 | .88 | 1.44 | .17 | 3.09 | Red | P71 | 18 | 71 | 1 1/2 | 10 |
| LCAN400-38-6 | 400 kcmil | 3/8 | .95 | 1.50 | .18 | 3.22 | Blue | P76 | 19 | 76 | 1 9/16 | 6 |
| LCAN400-12-6 | | 1/2 | .95 | 1.50 | .18 | 3.22 | Blue | P76 | 19 | 76 | 1 9/16 | 6 |
| LCAN500-38-6 | 500 kcmil | 3/8 | 1.06 | 1.75 | .22 | 3.39 | Brown | P87 | 20 | 87 | 1 13/16 | 6 |
| LCAN500-12-6 | | 1/2 | 1.06 | 1.75 | .22 | 3.55 | Brown | P87 | 20 | 87 | 1 13/16 | 6 |
| LCAN600-38-6 | 600 kcmil | 3/8 | 1.19 | 1.75 | .27 | 3.44 | Green | P94 | 22 | 94 | 1 13/16 | 6 |
| LCAN600-12-6 | | 1/2 | 1.19 | 1.75 | .27 | 4.20 | Green | P94 | 22 | 94 | 1 13/16 | 6 |
| LCAN750-38-6 | 750 kcmil | 3/8 | 1.30 | 1.88 | .28 | 3.84 | Black | P106 | 24 | 106 | 1 15/16 | 6 |
| LCAN750-12-6 | | 1/2 | 1.30 | 1.88 | .28 | 4.03 | Black | P106 | 24 | 106 | 1 15/16 | 6 |
| LCAN750-58-6 | | 5/8 | 1.30 | 1.88 | .28 | 4.59 | Black | P106 | 24 | 106 | 1 15/16 | 6 |

B2.
Cable
Accessories

B3.
Stainless
Steel Ties

C1.
Wiring
Duct

C2.
Surface
Raceway

C3.
Abrasion
Protection

C4.
Cable
Management

D1.
Terminals

D2.
Power
Connectors

D3.
Grounding
Connectors

E1.
Labeling
Systems

E2.
Labels

E3.
Pre-Printed
& Write-On
Markers

E4.
Permanent
Identification

E5.
Lockout/
Tagout/
& Safety
Solutions

F.
Index

‡See pages D3.54 – D3.57 for tool and die information.
**Consult cable manufacturer for voltage stress relief instructions with applications greater than 2000 V.

UL® **CERTIFIED** Code Conductor, Short Blank Tongue, Standard Barrel with Window Lug

For Use with Stranded Copper Conductors

Type LCA-00

- Color-coded barrels marked with *PANDUIT* and specified competitor die index numbers for proper crimp die selection
- Inspection window to visually assure full conductor insertion

- Tin-plated to inhibit corrosion
- UL Recognized and CSA Certified to 35 KV** and temperature rated to 90°C when crimped with *PANDUIT* and specified competitor crimping tools and dies

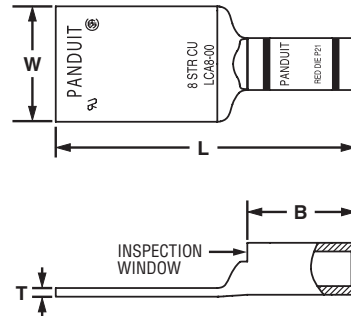

| Part Number | Copper Conductor Size | Figure Dimensions (In.) | | | | PANDUIT Color Code | PANDUIT Die Index No.‡ | Burdny Die Index No.‡ | T&B Die Index No.‡ | Wire Strip Length (In.) | Std. Pkg. Qty. |
|-------------|-------------------------------|-------------------------|------|-----|------|--------------------|------------------------|-----------------------|--------------------|-------------------------|----------------|
| | | W | B | T | L | | | | | | |
| LCA8-00-L | #8 AWG | .60 | .56 | .05 | 1.56 | Red | P21 | 49 | 21 | 5/8 | 50 |
| LCA6-00-L | #6 AWG | .62 | .81 | .06 | 1.83 | Blue | P24 | 7 | 24 | 7/8 | 50 |
| LCA4-00-L | #4 – 3 AWG STR, #2 AWG SOL | .62 | .81 | .07 | 1.85 | Gray | P29 | 8 | 29 | 7/8 | 50 |
| LCA2-00-Q | #2 AWG | .75 | .88 | .08 | 2.21 | Brown | P33 | 10 | 33 | 15/16 | 25 |
| LCA1-00-E | #1 AWG | .75 | .88 | .09 | 2.23 | Green | P37 | 11 | 37 | 15/16 | 20 |
| LCA1/0-00-X | 1/0 AWG | .80 | .94 | .12 | 2.31 | Pink | P42 | 12 | 42 | 1 | 10 |
| LCA2/0-00-X | 2/0 AWG | .85 | .98 | .13 | 2.40 | Black | P45 | 13 | 45 | 1 1/16 | 10 |
| LCA3/0-00-X | 3/0 AWG | .96 | 1.14 | .13 | 2.59 | Orange | P50 | 14 | 50 | 1 3/16 | 10 |
| LCA4/0-00-X | 4/0 AWG | 1.06 | 1.19 | .14 | 2.68 | Purple | P54 | 15 | 54 | 1 1/4 | 10 |
| LCA300-00-X | 300 kcmil | 1.19 | 1.44 | .16 | 3.70 | White | P66 | 17 | 66 | 1 1/2 | 10 |
| LCA350-00-X | 350 kcmil | 1.28 | 1.44 | .17 | 3.74 | Red | P71 | 18 | 71 | 1 1/2 | 10 |
| LCA400-00-6 | 400 kcmil | 1.39 | 1.50 | .18 | 3.82 | Blue | P76 | 19 | 76 | 1 9/16 | 6 |
| LCA500-00-6 | 500 kcmil | 1.54 | 1.75 | .22 | 4.27 | Brown | P87 | 20 | 87 | 1 13/16 | 6 |
| LCA600-00-6 | 600 kcmil | 1.70 | 1.75 | .26 | 4.20 | Green | P94 | 22 | 94 | 1 13/16 | 6 |

‡See pages D3.54 – D3.57 for tool and die information.

**Consult cable manufacturer for voltage stress relief instructions with applications greater than 2000 V.

A. System Overview

B1. Cable Ties

B2. Cable Accessories

B3. Stainless Steel Ties

C1. Wiring Duct

C2. Surface Raceway

C3. Abrasion Protection

C4. Cable Management

D1. Terminals

D2. Power Connectors

D3. Grounding Connectors

E1. Labeling Systems

E2. Labels

E3. Pre-Printed & Write-On Markers

E4. Permanent Identification

E5. Lockout/Tagout & Safety Solutions

F. Index

A. System Overview



Code Conductor, One-Hole, Long Barrel Lug

B1. Cable Ties

For Use with Stranded Copper Conductors

Type LCB

- Long barrel maximizes number of crimps and provides premium wire pull-out strength and electrical performance
- Color-coded barrels marked with *PANDUIT* and specified competitor die index numbers for proper crimp die selection
- Enclosed barrel prevents corrosive material from entering barrel when used in harsh environments
- Tin-plated to inhibit corrosion

- UL Listed and CSA Certified to 35 KV** and temperature rated to 90°C when crimped with *PANDUIT* and specified competitor crimping tools and dies
- UL Listed and CSA Certified for wide wire range-taking capability when crimped with *PANDUIT*® *UNI-DIE*™ Dieless Crimping Tools‡
- **Tested by Telcordia – meets NEBS Level 3**
- American Bureau of Shipping approved

B2. Cable Accessories

B3. Stainless Steel Ties

C1. Wiring Duct

C2. Surface Raceway

C3. Abrasion Protection

C4. Cable Management

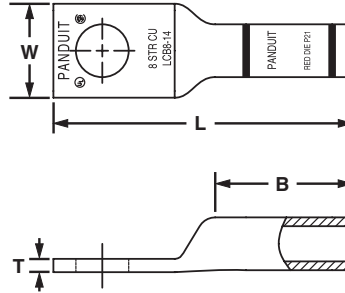

| Part Number | Copper Conductor Size | Stud Hole Size (In.) | Figure Dimensions (In.) | | | | PANDUIT Color Code | PANDUIT Die Index No.‡ | Burndy Die Index No.‡ | T&B Die Index No.‡ | Wire Strip Length (In.) | Std. Pkg. Qty. |
|-------------|----------------------------|----------------------|-------------------------|------|------|------|--------------------|------------------------|-----------------------|--------------------|-------------------------|----------------|
| | | | W | B | T | L | | | | | | |
| LCB8-10-L | #8 AWG | #10 | .41 | .70 | .08 | 1.44 | Red | P21 | 49 | 21 | 3/4 | 50 |
| LCB8-14-L | | 1/4 | .48 | .70 | .07 | 1.53 | Red | P21 | 49 | 21 | 3/4 | 50 |
| LCB8-38-L | | 3/8 | .60 | .70 | .05 | 1.75 | Red | P21 | 49 | 21 | 3/4 | 50 |
| LCB6-10-L | #6 AWG | #10 | .45 | 1.07 | .09 | 1.84 | Blue | P24 | 7 | 24 | 1 1/8 | 50 |
| LCB6-14-L | | 1/4 | .48 | 1.07 | .08 | 1.93 | Blue | P24 | 7 | 24 | 1 1/8 | 50 |
| LCB6-38-L | | 3/8 | .62 | 1.07 | .05 | 2.15 | Blue | P24 | 7 | 24 | 1 1/8 | 50 |
| LCB4-10-L | #4 – 3 AWG STR, #2 AWG SOL | #10 | .55 | 1.05 | .09 | 1.86 | Gray | P29 | 8 | 29 | 1 1/8 | 50 |
| LCB4-14-L | | 1/4 | .55 | 1.05 | .09 | 1.95 | Gray | P29 | 8 | 29 | 1 1/8 | 50 |
| LCB4-56-L | | 5/16 | .62 | 1.05 | .07 | 2.13 | Gray | P29 | 8 | 29 | 1 1/8 | 50 |
| LCB4-38-L | 3/8 | .62 | 1.05 | .07 | 2.17 | Gray | P29 | 8 | 29 | 1 1/8 | 50 | |
| LCB2-10-Q | #2 AWG | #10 | .60 | 1.16 | .10 | 2.07 | Brown | P33 | 10 | 33 | 1 1/4 | 25 |
| LCB2-56-Q | | 5/16 | .66 | 1.16 | .10 | 2.27 | Brown | P33 | 10 | 33 | 1 1/4 | 25 |
| LCB2-38-Q | | 3/8 | .66 | 1.16 | .10 | 2.34 | Brown | P33 | 10 | 33 | 1 1/4 | 25 |
| LCB1-10-E | #1 AWG | #10 | .70 | 1.36 | .11 | 2.30 | Green | P37 | 11 | 37 | 1 7/16 | 20 |
| LCB1-56-E | | 5/16 | .70 | 1.36 | .11 | 2.50 | Green | P37 | 11 | 37 | 1 7/16 | 20 |
| LCB1-38-E | | 3/8 | .70 | 1.36 | .11 | 2.57 | Green | P37 | 11 | 37 | 1 7/16 | 20 |
| LCB1/0-10-X | 1/0 AWG | #10 | .76 | 1.44 | .12 | 2.41 | Pink | P42 | 12 | 42 | 1 1/2 | 10 |
| LCB1/0-56-X | | 5/16 | .76 | 1.44 | .12 | 2.61 | Pink | P42 | 12 | 42 | 1 1/2 | 10 |
| LCB1/0-38-X | | 3/8 | .76 | 1.44 | .12 | 2.69 | Pink | P42 | 12 | 42 | 1 1/2 | 10 |
| LCB1/0-12-X | | 1/2 | .80 | 1.44 | .12 | 2.92 | Pink | P42 | 12 | 42 | 1 1/2 | 10 |

‡See pages D3.58 – D3.61 for tool and die information.

**Consult cable manufacturer for voltage stress relief instructions with applications greater than 2000 V.

E3. Pre-Printed & Write-On Markers

E4. Permanent Identification

E5. Lockout/Tagout & Safety Solutions

F. Index



Code Conductor, One-Hole, Long Barrel Lug (continued)

| Part Number | Copper Conductor Size | Stud Hole Size (In.) | Figure Dimensions (In.) | | | | PANDUIT Color Code | PANDUIT Die Index No.‡ | Burndy Die Index No.‡ | T&B Die Index No.‡ | Wire Strip Length (In.) | Std. Pkg. Qty. |
|--------------------|-----------------------|----------------------|-------------------------|------|-----|------|--------------------|------------------------|-----------------------|--------------------|-------------------------|----------------|
| | | | W | B | T | L | | | | | | |
| LCB2/0-38-X | 2/0 AWG | 3/8 | .85 | 1.50 | .13 | 2.82 | Black | P45 | 13 | 45 | 1 9/16 | 10 |
| LCB2/0-12-X | | 1/2 | .85 | 1.50 | .13 | 3.07 | Black | P45 | 13 | 45 | 1 9/16 | 10 |
| LCB3/0-38-X | 3/0 AWG | 3/8 | .96 | 1.50 | .13 | 2.87 | Orange | P50 | 14 | 50 | 1 9/16 | 10 |
| LCB3/0-12-X | | 1/2 | .96 | 1.50 | .13 | 3.12 | Orange | P50 | 14 | 50 | 1 9/16 | 10 |
| LCB4/0-38-X | 4/0 AWG | 3/8 | 1.06 | 1.56 | .14 | 3.03 | Purple | P54 | 15 | 54 | 1 5/8 | 10 |
| LCB4/0-12-X | | 1/2 | 1.06 | 1.56 | .14 | 3.22 | Purple | P54 | 15 | 54 | 1 5/8 | 10 |
| LCB250-12-X | 250 kcmil | 1/2 | 1.17 | 1.61 | .14 | 3.32 | Yellow | P62 | 16 | 62 | 1 11/16 | 10 |
| LCB250-78-X | | 7/8 | 1.25 | 1.61 | .12 | 3.85 | Yellow | P62 | 16 | 62 | 1 11/16 | 10 |
| LCB300-56-X | 300 kcmil | 5/16 | 1.19 | 2.24 | .16 | 3.95 | White | P66 | 17 | 66 | 2 5/16 | 10 |
| LCB300-38-X | | 3/8 | 1.19 | 2.24 | .16 | 3.95 | White | P66 | 17 | 66 | 2 5/16 | 10 |
| LCB300-12-X | | 1/2 | 1.19 | 2.24 | .16 | 4.06 | White | P66 | 17 | 66 | 2 5/16 | 10 |
| LCB350-12-X | 350 kcmil | 1/2 | 1.28 | 2.24 | .17 | 4.11 | Red | P71 | 18 | 71 | 2 5/16 | 10 |
| LCB350-78-X | | 7/8 | 1.28 | 2.24 | .17 | 4.78 | Red | P71 | 18 | 71 | 2 5/16 | 10 |
| LCB400-38-6 | 400 kcmil | 3/8 | 1.39 | 2.30 | .18 | 4.27 | Blue | P76 | 19 | 76 | 2 3/8 | 6 |
| LCB400-12-6 | | 1/2 | 1.39 | 2.30 | .18 | 4.27 | Blue | P76 | 19 | 76 | 2 3/8 | 6 |
| LCB400-58-6 | | 5/8 | 1.39 | 2.30 | .18 | 4.48 | Blue | P76 | 19 | 76 | 2 3/8 | 6 |
| LCB400-78-6 | 500 kcmil | 7/8 | 1.39 | 2.30 | .18 | 4.88 | Blue | P76 | 19 | 76 | 2 3/8 | 6 |
| LCB500-12-6 | | 1/2 | 1.54 | 2.50 | .22 | 4.53 | Brown | P87 | 20 | 87 | 2 9/16 | 6 |
| LCB500-58-6 | | 5/8 | 1.54 | 2.50 | .22 | 4.74 | Brown | P87 | 20 | 87 | 2 9/16 | 6 |
| LCB500-78-6 | 600 kcmil | 7/8 | 1.54 | 2.50 | .22 | 5.13 | Brown | P87 | 20 | 87 | 2 9/16 | 6 |
| LCB600-12-6 | | 1/2 | 1.70 | 2.69 | .26 | 5.40 | Green | P94 | 22 | 94 | 2 3/4 | 6 |
| LCB600-58-6 | | 5/8 | 1.70 | 2.69 | .26 | 5.40 | Green | P94 | 22 | 94 | 2 3/4 | 6 |
| LCB750-58-6 | 750 kcmil | 5/8 | 1.89 | 2.88 | .26 | 5.98 | Black | P106 | 24 | 106 | 2 15/16 | 6 |
| LCB750-78-6 | | 7/8 | 1.89 | 2.88 | .26 | 6.07 | Black | P106 | 24 | 106 | 2 15/16 | 6 |
| LCB800-58-6 | 800 kcmil | 5/8 | 1.95 | 2.94 | .29 | 6.06 | Orange | P107 | 25 | 107 | 3 | 6 |
| LCB1000-58-3 | 1000 kcmil | 5/8 | 2.17 | 3.00 | .32 | 6.32 | White | P125 | 27 | 125 | 3 1/16 | 3 |

‡See pages D3.58 – D3.61 for tool and die information.

**Consult cable manufacturer for voltage stress relief instructions with applications greater than 2000 V.

A.
System
Overview

B1.
Cable Ties

B2.
Cable
Accessories

B3.
Stainless
Steel Ties

C1.
Wiring
Duct

C2.
Surface
Raceway

C3.
Abrasion
Protection

C4.
Cable
Management

D1.
Terminals

D2.
Power
Connectors

D3.
Grounding
Connectors

E1.
Labeling
Systems

E2.
Labels

E3.
Pre-Printed
& Write-On
Markers

E4.
Permanent
Identification

E5.
Lockout/
Tagout
& Safety
Solutions

F.
Index

A. System Overview

UL LISTED CERTIFIED **Code Conductor, One-Hole, Long Barrel Lug, 45° Angle**

For Use with Stranded Copper Conductors

Type LCB-H

- Long barrel maximizes number of crimps and provides premium wire pull-out strength and electrical performance
- Color-coded barrels marked with *PANDUIT* and specified competitor die index numbers for proper crimp die selection
- Enclosed barrel prevents corrosive material from entering barrel when used in harsh environments
- Tin-plated to inhibit corrosion
- UL Listed and CSA Certified to 35 KV** and temperature rated to 90°C when crimped with *PANDUIT* and specified competitor crimping tools and dies
- UL Listed and CSA Certified for wide wire range-taking capability when crimped with *PANDUIT*® *UNI-DIE*™ Dieless Crimping Tools‡
- **Tested by Telcordia – meets NEBS Level 3**
- American Bureau of Shipping approved

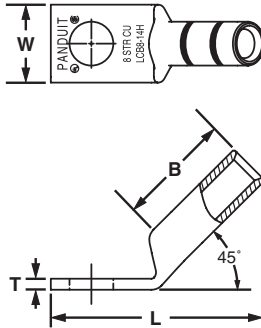

| Part Number | Copper Conductor Size | Stud Hole Size (In.) | Figure Dimensions (In.) | | | | PANDUIT Color Code | PANDUIT Die Index No.‡ | Burndy Die Index No.‡ | T&B Die Index No.‡ | Wire Strip Length (In.) | Std. Pkg. Qty. |
|--------------|----------------------------|----------------------|-------------------------|------|-----|------|--------------------|------------------------|-----------------------|--------------------|-------------------------|----------------|
| | | | W | B | T | L | | | | | | |
| LCB8-10H-L | #8 AWG | #10 | .41 | .70 | .08 | 1.23 | Red | P21 | 49 | 21 | 3/4 | 50 |
| LCB8-14H-L | | 1/4 | .48 | .70 | .07 | 1.31 | Red | P21 | 49 | 21 | 3/4 | 50 |
| LCB6-10H-L | #6 AWG | #10 | .45 | 1.07 | .09 | 1.52 | Blue | P24 | 7 | 24 | 1 1/8 | 50 |
| LCB6-14H-L | | 1/4 | .48 | 1.07 | .08 | 1.60 | Blue | P24 | 7 | 24 | 1 1/8 | 50 |
| LCB6-38H-L | | 3/8 | .62 | 1.07 | .05 | 1.81 | Blue | P24 | 7 | 24 | 1 1/8 | 50 |
| LCB4-10H-L | #4 – 3 AWG STR, #2 AWG SOL | #10 | .55 | 1.05 | .09 | 1.54 | Gray | P29 | 8 | 29 | 1 1/8 | 50 |
| LCB4-14H-L | | 1/4 | .55 | 1.05 | .09 | 1.63 | Gray | P29 | 8 | 29 | 1 1/8 | 50 |
| LCB2-10H-Q | #2 AWG | #10 | .60 | 1.16 | .10 | 1.68 | Brown | P33 | 10 | 33 | 1 1/4 | 25 |
| LCB2-56H-Q | | 5/16 | .66 | 1.16 | .10 | 1.87 | Brown | P33 | 10 | 33 | 1 1/4 | 25 |
| LCB1-10H-E | #1 AWG | #10 | .70 | 1.36 | .11 | 1.83 | Green | P37 | 11 | 37 | 1 7/16 | 20 |
| LCB1-56H-E | | 5/16 | .70 | 1.36 | .11 | 2.03 | Green | P37 | 11 | 37 | 1 7/16 | 20 |
| LCB1/0-10H-X | 1/0 AWG | #10 | .76 | 1.44 | .12 | 1.92 | Pink | P42 | 12 | 42 | 1 1/2 | 10 |
| LCB1/0-56H-X | | 5/16 | .76 | 1.44 | .12 | 2.12 | Pink | P42 | 12 | 42 | 1 1/2 | 10 |
| LCB1/0-38H-X | | 3/8 | .76 | 1.44 | .12 | 2.19 | Pink | P42 | 12 | 42 | 1 1/2 | 10 |
| LCB1/0-12H-X | | 1/2 | .80 | 1.44 | .11 | 2.42 | Pink | P42 | 12 | 42 | 1 1/2 | 10 |
| LCB2/0-38H-X | 2/0 AWG | 3/8 | .85 | 1.50 | .13 | 2.31 | Black | P45 | 13 | 45 | 1 9/16 | 10 |
| LCB2/0-12H-X | | 1/2 | .85 | 1.50 | .13 | 2.53 | Black | P45 | 13 | 45 | 1 9/16 | 10 |
| LCB3/0-38H-X | 3/0 AWG | 3/8 | .96 | 1.50 | .13 | 2.33 | Orange | P50 | 14 | 50 | 1 9/16 | 10 |
| LCB3/0-12H-X | | 1/2 | .96 | 1.50 | .13 | 2.58 | Orange | P50 | 14 | 50 | 1 9/16 | 10 |

‡See pages D3.58 – D3.61 for tool and die information.
 **Consult cable manufacturer for voltage stress relief instructions with applications greater than 2000 V.



Code Conductor, One-Hole, Long Barrel Lug, 45° Angle (continued)

| Part Number | Copper Conductor Size | Stud Hole Size (In.) | Figure Dimensions (In.) | | | | PANDUIT Color Code | PANDUIT Die Index No.‡ | Burdmy Die Index No.‡ | T&B Die Index No.‡ | Wire Strip Length (In.) | Std. Pkg. Qty. |
|--------------|-----------------------|----------------------|-------------------------|------|-----|------|--------------------|------------------------|-----------------------|--------------------|-------------------------|----------------|
| | | | W | B | T | L | | | | | | |
| LCB4/0-38H-X | 4/0 AWG | 3/8 | 1.06 | 1.56 | .14 | 2.48 | Purple | P54 | 15 | 54 | 1 5/8 | 10 |
| LCB4/0-12H-X | | 1/2 | 1.06 | 1.56 | .14 | 2.67 | Purple | P54 | 15 | 54 | 1 5/8 | 10 |
| LCB250-12H-X | 250 kcmil | 1/2 | 1.17 | 1.61 | .14 | 2.74 | Yellow | P62 | 16 | 62 | 1 11/16 | 10 |
| LCB250-78H-X | | 7/8 | 1.25 | 1.61 | .12 | 3.27 | Yellow | P62 | 16 | 62 | 1 11/16 | 10 |
| LCB300-56H-X | 300 kcmil | 5/16 | 1.19 | 2.24 | .16 | 3.24 | White | P66 | 17 | 66 | 2 5/16 | 10 |
| LCB300-38H-X | | 3/8 | 1.19 | 2.24 | .16 | 3.24 | White | P66 | 17 | 66 | 2 5/16 | 10 |
| LCB300-12H-X | | 1/2 | 1.19 | 2.24 | .16 | 3.35 | White | P66 | 17 | 66 | 2 5/16 | 10 |
| LCB350-12H-X | 350 kcmil | 1/2 | 1.28 | 2.24 | .17 | 3.39 | Red | P71 | 18 | 71 | 2 5/16 | 10 |
| LCB350-78H-X | | 7/8 | 1.28 | 2.24 | .17 | 4.04 | Red | P71 | 18 | 71 | 2 5/16 | 10 |
| LCB400-12H-6 | 400 kcmil | 1/2 | 1.39 | 2.30 | .18 | 3.53 | Blue | P76 | 19 | 76 | 2 3/8 | 6 |
| LCB400-58H-6 | | 5/8 | 1.39 | 2.30 | .18 | 3.74 | Blue | P76 | 19 | 76 | 2 3/8 | 6 |
| LCB400-78H-6 | | 7/8 | 1.39 | 2.30 | .18 | 4.13 | Blue | P76 | 19 | 76 | 2 3/8 | 6 |
| LCB500-12H-6 | 500 kcmil | 1/2 | 1.54 | 2.50 | .22 | 3.74 | Brown | P87 | 20 | 87 | 2 9/16 | 6 |
| LCB500-58H-6 | | 5/8 | 1.54 | 2.50 | .22 | 3.95 | Brown | P87 | 20 | 87 | 2 9/16 | 6 |
| LCB500-78H-6 | | 7/8 | 1.54 | 2.50 | .22 | 4.34 | Brown | P87 | 20 | 87 | 2 9/16 | 6 |
| LCB600-12H-6 | 600 kcmil | 1/2 | 1.70 | 2.69 | .26 | 4.56 | Green | P94 | 22 | 94 | 2 3/4 | 6 |
| LCB600-58H-6 | | 5/8 | 1.70 | 2.69 | .26 | 4.56 | Green | P94 | 22 | 94 | 2 3/4 | 6 |

‡See pages D3.58 – D3.61 for tool and die information.

**Consult cable manufacturer for voltage stress relief instructions with applications greater than 2000 V.

A.
System
Overview

B1.
Cable Ties

B2.
Cable
Accessories

B3.
Stainless
Steel Ties

C1.
Wiring
Duct

C2.
Surface
Raceway

C3.
Abrasion
Protection

C4.
Cable
Management

D1.
Terminals

D2.
Power
Connectors

D3.
Grounding
Connectors

E1.
Labeling
Systems

E2.
Labels

E3.
Pre-Printed
& Write-On
Markers

E4.
Permanent
Identification

E5.
Lockout/
Tagout
& Safety
Solutions

F.
Index

A. System Overview

UL LISTED **CSA CERTIFIED** **Code Conductor, One-Hole, Long Barrel Lug, 90° Angle**

For Use with Stranded Copper Conductors
Type LCB-F

- Long barrel maximizes number of crimps and provides premium wire pull-out strength and electrical performance
- Color-coded barrels marked with *PANDUIT* and specified competitor die index numbers for proper crimp die selection
- Enclosed barrel prevents corrosive material from entering barrel when used in harsh environments
- Tin-plated to inhibit corrosion

- UL Listed and CSA Certified to 35 KV** and temperature rated to 90°C when crimped with *PANDUIT* and specified competitor crimping tools and dies
- UL Listed and CSA Certified for wide wire range-taking capability when crimped with *PANDUIT*® *UNI-DIE*™ Dieless Crimping Tools‡
- **Tested by Telcordia – meets NEBS Level 3**
- American Bureau of Shipping approved

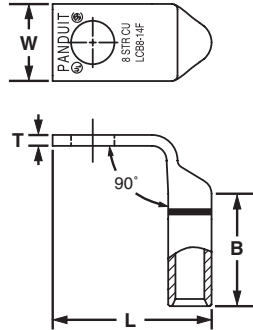

| Part Number | Copper Conductor Size | Stud Hole Size (In.) | Figure Dimensions (In.) | | | | PANDUIT Color Code | PANDUIT Die Index No.‡ | Burndy Die Index No.‡ | T&B Die Index No.‡ | Wire Strip Length (In.) | Std. Pkg. Qty. |
|--------------|----------------------------|----------------------|-------------------------|------|-----|------|--------------------|------------------------|-----------------------|--------------------|-------------------------|----------------|
| | | | W | B | T | L | | | | | | |
| LCB8-10F-L | #8 AWG | #10 | .41 | .70 | .08 | 1.08 | Red | P21 | 49 | 21 | 3/4 | 50 |
| LCB8-14F-L | | 1/4 | .48 | .70 | .07 | 1.07 | Red | P21 | 49 | 21 | 3/4 | 50 |
| LCB6-10F-L | #6 AWG | #10 | .45 | 1.07 | .09 | 1.49 | Blue | P24 | 7 | 24 | 1 1/8 | 50 |
| LCB6-14F-L | | 1/4 | .48 | 1.07 | .08 | 1.48 | Blue | P24 | 7 | 24 | 1 1/8 | 50 |
| LCB6-38F-L | | 3/8 | .62 | 1.07 | .05 | 1.45 | Blue | P24 | 7 | 24 | 1 1/8 | 50 |
| LCB4-10F-L | #4 – 3 AWG STR, #2 AWG SOL | #10 | .55 | 1.05 | .09 | 1.53 | Gray | P29 | 8 | 29 | 1 1/8 | 50 |
| LCB4-14F-L | | 1/4 | .55 | 1.05 | .09 | 1.53 | Gray | P29 | 8 | 29 | 1 1/8 | 50 |
| LCB2-10F-Q | #2 AWG | #10 | .60 | 1.16 | .10 | 1.75 | Brown | P33 | 10 | 33 | 1 1/4 | 25 |
| LCB2-56F-Q | | 5/16 | .66 | 1.16 | .10 | 1.74 | Brown | P33 | 10 | 33 | 1 1/4 | 25 |
| LCB1-10F-E | #1 AWG | #10 | .70 | 1.36 | .11 | 2.00 | Green | P37 | 11 | 37 | 1 7/16 | 20 |
| LCB1-56F-E | | 5/16 | .70 | 1.36 | .11 | 2.00 | Green | P37 | 11 | 37 | 1 7/16 | 20 |
| LCB1/0-10F-X | | #10 | .76 | 1.44 | .12 | 2.15 | Pink | P42 | 12 | 42 | 1 1/2 | 10 |
| LCB1/0-56F-X | 1/0 AWG | 5/16 | .76 | 1.44 | .12 | 2.15 | Pink | P42 | 12 | 42 | 1 1/2 | 10 |
| LCB1/0-38F-X | | 3/8 | .76 | 1.44 | .12 | 2.15 | Pink | P42 | 12 | 42 | 1 1/2 | 10 |
| LCB1/0-12F-X | | 1/2 | .80 | 1.44 | .12 | 2.14 | Pink | P42 | 12 | 42 | 1 1/2 | 10 |
| LCB2/0-38F-X | 2/0 AWG | 3/8 | .85 | 1.50 | .13 | 2.30 | Black | P45 | 13 | 45 | 1 9/16 | 10 |
| LCB2/0-12F-X | | 1/2 | .85 | 1.50 | .13 | 2.30 | Black | P45 | 13 | 45 | 1 9/16 | 10 |
| LCB3/0-38F-X | 3/0 AWG | 3/8 | .96 | 1.50 | .13 | 2.35 | Orange | P50 | 14 | 50 | 1 9/16 | 10 |
| LCB3/0-12F-X | | 1/2 | .96 | 1.50 | .13 | 2.35 | Orange | P50 | 14 | 50 | 1 9/16 | 10 |
| LCB4/0-38F-X | 4/0 AWG | 3/8 | 1.06 | 1.56 | .14 | 2.48 | Purple | P54 | 15 | 54 | 1 5/8 | 10 |
| LCB4/0-12F-X | | 1/2 | 1.06 | 1.56 | .14 | 2.48 | Purple | P54 | 15 | 54 | 1 5/8 | 10 |

‡See pages D3.58 – D3.61 for tool and die information.
 **Consult cable manufacturer for voltage stress relief instructions with applications greater than 2000 V.



Code Conductor, One-Hole, Long Barrel Lug, 90° Angle (continued)

| Part Number | Copper Conductor Size | Stud Hole Size (In.) | Figure Dimensions (In.) | | | | PANDUIT Color Code | PANDUIT Die Index No.‡ | Burndy Die Index No.‡ | T&B Die Index No.‡ | Wire Strip Length (In.) | Std. Pkg. Qty. |
|--------------|-----------------------|----------------------|-------------------------|------|-----|------|--------------------|------------------------|-----------------------|--------------------|-------------------------|----------------|
| | | | W | B | T | L | | | | | | |
| LCB250-12F-X | 250 kcmil | 1/2 | 1.17 | 1.61 | .14 | 2.57 | Yellow | P62 | 16 | 62 | 1 11/16 | 10 |
| LCB250-78F-X | | 7/8 | 1.25 | 1.61 | .12 | 2.49 | Yellow | P62 | 16 | 62 | 1 11/16 | 10 |
| LCB300-56F-X | 300 kcmil | 5/16 | 1.19 | 2.24 | .16 | 3.29 | White | P66 | 17 | 66 | 2 5/16 | 10 |
| LCB300-38F-X | | 3/8 | 1.19 | 2.24 | .16 | 3.29 | White | P66 | 17 | 66 | 2 5/16 | 10 |
| LCB300-12F-X | | 1/2 | 1.19 | 2.24 | .16 | 3.29 | White | P66 | 17 | 66 | 2 5/16 | 10 |
| LCB350-12F-X | 350 kcmil | 1/2 | 1.28 | 2.24 | .17 | 3.34 | Red | P71 | 18 | 71 | 2 5/16 | 10 |
| LCB350-78F-X | | 7/8 | 1.28 | 2.24 | .17 | 3.34 | Red | P71 | 18 | 71 | 2 5/16 | 10 |
| LCB400-12F-6 | 400 kcmil | 1/2 | 1.39 | 2.30 | .18 | 3.47 | Blue | P76 | 19 | 76 | 2 3/8 | 6 |
| LCB400-58F-6 | | 5/8 | 1.39 | 2.30 | .18 | 3.47 | Blue | P76 | 19 | 76 | 2 3/8 | 6 |
| LCB400-78F-6 | | 7/8 | 1.39 | 2.30 | .18 | 3.47 | Blue | P76 | 19 | 76 | 2 3/8 | 6 |
| LCB500-12F-6 | 500 kcmil | 1/2 | 1.54 | 2.50 | .22 | 3.77 | Brown | P87 | 20 | 87 | 2 9/16 | 6 |
| LCB500-58F-6 | | 5/8 | 1.54 | 2.50 | .22 | 3.77 | Brown | P87 | 20 | 87 | 2 9/16 | 6 |
| LCB500-78F-6 | | 7/8 | 1.54 | 2.50 | .22 | 3.77 | Brown | P87 | 20 | 87 | 2 9/16 | 6 |
| LCB600-12F-6 | 600 kcmil | 1/2 | 1.70 | 2.69 | .26 | 4.08 | Green | P94 | 22 | 94 | 2 3/4 | 6 |
| LCB600-58F-6 | | 5/8 | 1.70 | 2.69 | .26 | 4.08 | Green | P94 | 22 | 94 | 2 3/4 | 6 |

‡See pages D3.58 – D3.61 for tool and die information.

**Consult cable manufacturer for voltage stress relief instructions with applications greater than 2000 V.

A.
System
Overview

B1.
Cable Ties

B2.
Cable
Accessories

B3.
Stainless
Steel Ties

C1.
Wiring
Duct

C2.
Surface
Raceway

C3.
Abrasion
Protection

C4.
Cable
Management

D1.
Terminals

D2.
Power
Connectors

D3.
Grounding
Connectors

E1.
Labeling
Systems

E2.
Labels

E3.
Pre-Printed
& Write-On
Markers

E4.
Permanent
Identification

E5.
Lockout/
Tagout
& Safety
Solutions

F.
Index

A. System Overview



Code Conductor, One-Hole, Long Barrel with Window Lug

B1. Cable Ties

For Use with Stranded Copper Conductors

Type LCB-W

- Long barrel maximizes number of crimps and provides premium wire pull-out strength and electrical performance
- Inspection window to visually assure full conductor insertion
- Color-coded barrels marked with *PANDUIT* and specified competitor die index numbers for proper crimp die selection
- Tin-plated to inhibit corrosion
- UL Listed and CSA Certified to 35 KV** and temperature rated to 90°C when crimped with *PANDUIT* and specified competitor crimping tools and dies

- UL Listed and CSA Certified for wide wire range-taking capability when crimped with *PANDUIT*® *UNI-DIE*™ Dieless Crimping Tools‡
- **Tested by Telcordia – meets NEBS Level 3**
- Meets J-STD-607-A and TIA-942 requirements for network systems grounding applications

C1. Wiring Duct

C2. Surface Raceway

C3. Abrasion Protection

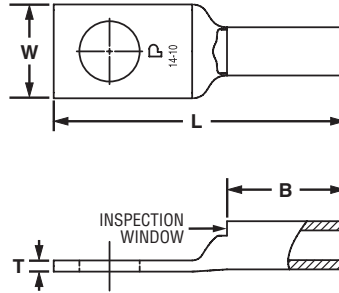

C4. Cable Management

D1. Terminals

D2. Power Connectors

D3. Grounding Connectors

| Part Number | Copper Conductor Size | Stud Hole Size (In.) | Figure Dimensions (In.) | | | | PANDUIT Color Code | PANDUIT Die Index No.‡ | Burndy Die Index No.‡ | T&B Die Index No.‡ | Wire Strip Length (In.) | Std. Pkg. Qty. |
|----------------------|------------------------------------|----------------------|-------------------------|------|-----|------|--------------------|------------------------|-----------------------|--------------------|-------------------------|----------------|
| | | | W | B | T | L | | | | | | |
| LCB10-14W-L* | #14 – 10 AWG STR, #12 – 10 AWG SOL | 1/4 | .42 | .53 | .05 | 1.31 | — | — | — | — | 9/16 | 50 |
| LCB750-38W-6 | 750 kcmil | 3/8 | 1.89 | 2.88 | .26 | 4.83 | Black | P106 | 24 | 106 | 2 15/16 | 6 |
| LCB750-12W-6 | | 1/2 | 1.89 | 2.88 | .26 | 5.03 | Black | P106 | 24 | 106 | 2 15/16 | 6 |
| LCB750-58W-6 | | 5/8 | 1.89 | 2.88 | .26 | 5.58 | Black | P106 | 24 | 106 | 2 15/16 | 6 |
| LCB750-78W-6 | | 7/8 | 1.89 | 2.88 | .26 | 5.68 | Black | P106 | 24 | 106 | 2 15/16 | 6 |
| LCB800-12W-6 | 800 kcmil | 1/2 | 1.95 | 2.94 | .30 | 5.11 | Orange | P107 | 25 | 107 | 3 | 6 |
| LCB800-58W-6 | | 5/8 | 1.95 | 2.94 | .30 | 5.68 | Orange | P107 | 25 | 107 | 3 | 6 |
| LCB1000-38W-3 | 1000 kcmil | 3/8 | 2.17 | 3.00 | .32 | 5.08 | White | P125 | 27 | 125 | 3 1/16 | 3 |
| LCB1000-12W-3 | | 1/2 | 2.17 | 3.00 | .32 | 5.27 | White | P125 | 27 | 125 | 3 1/16 | 3 |
| LCB1000-58W-3 | | 5/8 | 2.17 | 3.00 | .32 | 5.92 | White | P125 | 27 | 125 | 3 1/16 | 3 |

‡See pages D3.58 – D3.61 for tool and die information.

*Not tested to NEBS Level 3 requirements.

**Consult cable manufacturer for voltage stress relief instructions with applications greater than 2000 V.

E1. Labeling Systems

E2. Labels

E3. Pre-Printed & Write-On Markers

E4. Permanent Identification

E5. Lockout/Tagout & Safety Solutions

F. Index

UL LISTED CERTIFIED Code Conductor, One-Hole, Long Barrel with Window Lug, 45° Angle

For Use with Stranded Copper Conductors

Type LCB-WH

- Long barrel maximizes number of crimps and provides premium wire pull-out strength and electrical performance
- Inspection window to visually assure full conductor insertion
- Tin-plated to inhibit corrosion
- UL Listed and CSA Certified to 35 KV** and temperature rated to 90°C when crimped with *PANDUIT* crimping tools and dies
- Meets J-STD-607-A and TIA-942 requirements for network systems grounding applications

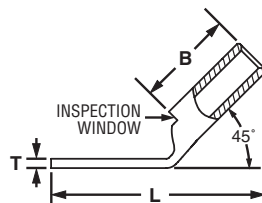
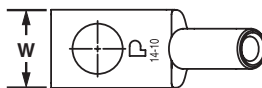

| Part Number | Copper Conductor Size | Stud Hole Size (In.) | Figure Dimensions (In.) | | | | PANDUIT Color Code | PANDUIT Die Index No.‡ | Burndy Die Index No.‡ | T&B Die Index No.‡ | Wire Strip Length (In.) | Std. Pkg. Qty. |
|--------------|------------------------------------|----------------------|-------------------------|-----|-----|------|--------------------|------------------------|-----------------------|--------------------|-------------------------|----------------|
| | | | W | B | T | L | | | | | | |
| LCB10-14WH-L | #14 – 10 AWG STR, #12 – 10 AWG SOL | 1/4 | .42 | .53 | .05 | 1.15 | — | — | — | — | 9/16 | 50 |

‡See pages D3.58 – D3.61 for tool and die information.

**Consult cable manufacturer for voltage stress relief instructions with applications greater than 2000 V.

UL LISTED CERTIFIED Code Conductor, One-Hole, Long Barrel with Window Lug, 90° Angle

For Use with Stranded Copper Conductors

Type LCB-WF

- Long barrel maximizes number of crimps and provides premium wire pull-out strength and electrical performance
- Inspection window to visually assure full conductor insertion
- Tin-plated to inhibit corrosion
- UL Listed and CSA Certified to 35 KV** and temperature rated to 90°C when crimped with *PANDUIT* crimping tools and dies
- Meets J-STD-607-A and TIA-942 requirements for network systems grounding applications

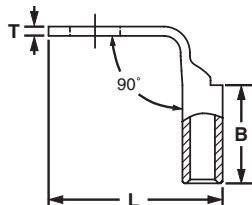
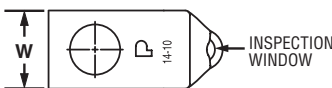

| Part Number | Copper Conductor Size | Stud Hole Size (In.) | Figure Dimensions (In.) | | | | PANDUIT Color Code | PANDUIT Die Index No.‡ | Burndy Die Index No.‡ | T&B Die Index No.‡ | Wire Strip Length (In.) | Std. Pkg. Qty. |
|--------------|------------------------------------|----------------------|-------------------------|-----|-----|-----|--------------------|------------------------|-----------------------|--------------------|-------------------------|----------------|
| | | | W | B | T | L | | | | | | |
| LCB10-14WF-L | #14 – 10 AWG STR, #12 – 10 AWG SOL | 1/4 | .42 | .53 | .05 | .94 | — | — | — | — | 9/16 | 50 |

‡See pages D3.58 – D3.61 for tool and die information.

**Consult cable manufacturer for voltage stress relief instructions with applications greater than 2000 V.

A. System Overview

B1. Cable Ties

B2. Cable Accessories

B3. Stainless Steel Ties

C1. Wiring Duct

C2. Surface Raceway

C3. Abrasion Protection

C4. Cable Management

D1. Terminals

D2. Power Connectors

D3. Grounding Connectors

E1. Labeling Systems

E2. Labels

E3. Pre-Printed & Write-On Markers

E4. Permanent Identification

E5. Lockout/Tagout & Safety Solutions

F. Index

A. System Overview



Code Conductor, One-Hole, Long Barrel with Corona Relief Taper Lug

B1. Cable Ties

To Facilitate Use with Stranded Copper Conductors in Applications of 5000 V or More

Type LCBH

- Externally chamfered barrel end inhibits Corona effect when used in high voltage applications
- Long barrel maximizes number of crimps and provides premium wire pull-out strength and electrical performance
- Color-coded barrels marked with *PANDUIT* and specified competitor die index numbers for proper crimp die selection
- Enclosed barrel prevents corrosive material from entering barrel when used in harsh environments
- Tin-plated to inhibit corrosion
- UL Listed and CSA Certified to 35 KV** and temperature rated to 90°C when crimped with *PANDUIT* and specified competitor crimping tools and dies

B2. Cable Accessories

B3. Stainless Steel Ties



Corona Relief Taper

C1. Wiring Duct

C2. Surface Raceway

C3. Abrasion Protection

C4. Cable Management

D1. Terminals

D2. Power Connectors

D3. Grounding Connectors

E1. Labeling Systems

E2. Labels

E3. Pre-Printed & Write-On Markers

E4. Permanent Identification

E5. Lockout/Tagout & Safety Solutions

F. Index

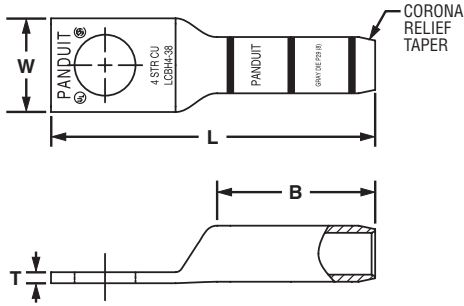

| Part Number | Copper Conductor Size | Stud Hole Size (In.) | Figure Dimensions (In.) | | | | PANDUIT Color Code | PANDUIT Die Index No. ‡ | Burdny Die Index No. ‡ | T&B Die Index No. ‡ | Wire Strip Length (In.) | Std. Pkg. Qty. |
|--------------|-----------------------|----------------------|-------------------------|------|-----|------|--------------------|-------------------------|------------------------|---------------------|-------------------------|----------------|
| | | | W | B | T | L | | | | | | |
| LCBH4-38-L | #4 AWG | 3/8 | .62 | 1.05 | .07 | 2.16 | Gray | P29 | 8 | 29 | 1 1/8 | 50 |
| LCBH2-38-Q | #2 AWG | 3/8 | .66 | 1.16 | .10 | 2.34 | Brown | P33 | 10 | 33 | 1 1/4 | 25 |
| LCBH1-38-E | #1 AWG | 3/8 | .70 | 1.36 | .10 | 2.57 | Green | P37 | 11 | 37 | 1 7/16 | 20 |
| LCBH1/0-38-X | 1/0 AWG | 3/8 | .76 | 1.44 | .12 | 2.69 | Pink | P42 | 12 | 42 | 1 1/2 | 10 |
| LCBH2/0-12-X | 2/0 AWG | 1/2 | .85 | 1.50 | .13 | 3.07 | Black | P45 | 13 | 45 | 1 9/16 | 10 |
| LCBH3/0-12-X | 3/0 AWG | 1/2 | .96 | 1.50 | .13 | 3.12 | Orange | P50 | 14 | 50 | 1 9/16 | 10 |
| LCBH4/0-12-X | 4/0 AWG | 1/2 | 1.06 | 1.56 | .14 | 3.22 | Purple | P54 | 15 | 54 | 1 5/8 | 10 |
| LCBH250-12-X | 250 kcmil | 1/2 | 1.17 | 1.61 | .14 | 3.32 | Yellow | P62 | 16 | 62 | 1 11/16 | 10 |

‡See pages D3.62, D3.63 for tool and die information.

**Consult cable manufacturer for voltage stress relief instructions with applications greater than 2000 V.



Code Conductor, Two-Hole, Standard Barrel with Window Lug

For Use with Stranded Copper Conductors

Type LCD

- Color-coded barrels marked with *PANDUIT* and specified competitor die index numbers for proper crimp die selection
- Inspection window to visually assure full conductor insertion
- Tin-plated to inhibit corrosion
- UL Listed and CSA Certified to 35 KV** and temperature rated to 90°C when crimped with *PANDUIT* and specified competitor crimping tools and dies



- UL Listed and CSA Certified for wide wire range-taking capability when crimped with *PANDUIT*® *UNI-DIE*™ Dieless Crimping Tools‡
- **Tested by Telcordia – meets NEBS Level 3**
- American Bureau of Shipping approved
- Available with NEMA hole sizes and spacing

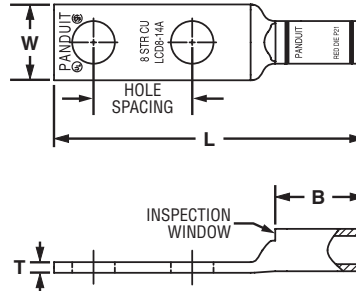

| Part Number | Copper Conductor Size | Stud Hole Size (In.) | Stud Hole Spacing (In.) | Figure Dimensions (In.) | | | | PANDUIT Color Code | PANDUIT Die Index No.‡ | Burdny Die Index No.‡ | T&B Die Index No.‡ | Wire Strip Length (In.) | Std. Pkg. Qty. |
|--------------|------------------------------------|----------------------------|-------------------------|-------------------------|-----|-----|------|--------------------|------------------------|-----------------------|--------------------|-------------------------|----------------|
| | | | | W | B | T | L | | | | | | |
| LCD10-10A-L* | #14 – 10 AWG STR, #12 – 10 AWG SOL | #10 | .63 | .38 | .38 | .06 | 1.69 | — | — | — | — | 7/16 | 50 |
| LCD10-14A-L* | | 1/4 | .63 | .42 | .38 | .05 | 1.78 | — | — | — | — | 7/16 | 50 |
| LCD10-14B-L* | | 1/4 | .75 | .42 | .38 | .05 | 1.91 | — | — | — | — | 7/16 | 50 |
| LCD10-14D-L* | | 1/4 | 1.00 | .42 | .38 | .05 | 2.16 | — | — | — | — | 7/16 | 50 |
| LCD10-38D-L* | | 3/8 | 1.00 | .56 | .38 | .04 | 2.38 | — | — | — | — | 7/16 | 50 |
| LCD8-10A-L | #8 AWG | #10 | .63 | .41 | .56 | .08 | 1.88 | Red | P21 | 49 | 21 | 5/8 | 50 |
| LCD8-14A-L | | 1/4 | .63 | .48 | .56 | .07 | 1.97 | Red | P21 | 49 | 21 | 5/8 | 50 |
| LCD8-14B-L | | 1/4 | .75 | .48 | .56 | .07 | 2.09 | Red | P21 | 49 | 21 | 5/8 | 50 |
| LCD8-14D-L | | 1/4 | 1.00 | .48 | .56 | .07 | 2.34 | Red | P21 | 49 | 21 | 5/8 | 50 |
| LCD8-38D-L | | 3/8 | 1.00 | .60 | .56 | .05 | 2.56 | Red | P21 | 49 | 21 | 5/8 | 50 |
| LCD6-10A-L | #6 AWG | #10 | .63 | .46 | .81 | .08 | 2.15 | Blue | P24 | 7 | 24 | 7/8 | 50 |
| LCD6-10B-L | | #10 | .75 | .46 | .81 | .08 | 2.27 | Blue | P24 | 7 | 24 | 7/8 | 50 |
| LCD6-10D-L | | #10 | 1.00 | .46 | .81 | .08 | 2.52 | Blue | P24 | 7 | 24 | 7/8 | 50 |
| LCD6-14A-L | | 1/4 | .63 | .48 | .81 | .08 | 2.24 | Blue | P24 | 7 | 24 | 7/8 | 50 |
| LCD6-14B-L | | 1/4 | .75 | .48 | .81 | .08 | 2.36 | Blue | P24 | 7 | 24 | 7/8 | 50 |
| LCD6-14D-L | | 1/4 | 1.00 | .48 | .81 | .08 | 2.61 | Blue | P24 | 7 | 24 | 7/8 | 50 |
| LCD6-56D-L | | 5/16 | 1.00 | .56 | .81 | .07 | 2.73 | Blue | P24 | 7 | 24 | 7/8 | 50 |
| LCD6-38D-L | | 3/8 | 1.00 | .62 | .81 | .06 | 2.83 | Blue | P24 | 7 | 24 | 7/8 | 50 |
| LCD4-10A-L | | #4 – 3 AWG STR, #2 AWG SOL | #10 | .63 | .55 | .81 | .09 | 2.17 | Gray | P29 | 8 | 29 | 7/8 |
| LCD4-10B-L | #10 | | .75 | .55 | .81 | .09 | 2.29 | Gray | P29 | 8 | 29 | 7/8 | 50 |
| LCD4-14A-L | 1/4 | | .63 | .55 | .81 | .09 | 2.26 | Gray | P29 | 8 | 29 | 7/8 | 50 |
| LCD4-14B-L | 1/4 | | .75 | .55 | .81 | .09 | 2.38 | Gray | P29 | 8 | 29 | 7/8 | 50 |
| LCD4-14D-L | 1/4 | | 1.00 | .55 | .81 | .09 | 2.63 | Gray | P29 | 8 | 29 | 7/8 | 50 |
| LCD4-38D-L | 3/8 | | 1.00 | .62 | .81 | .08 | 2.85 | Gray | P29 | 8 | 29 | 7/8 | 50 |
| LCD2-14A-Q | #2 AWG | 1/4 | .63 | .60 | .88 | .10 | 2.40 | Brown | P33 | 10 | 33 | 15/16 | 25 |
| LCD2-14B-Q | | 1/4 | .75 | .60 | .88 | .10 | 2.52 | Brown | P33 | 10 | 33 | 15/16 | 25 |
| LCD2-14D-Q | | 1/4 | 1.00 | .60 | .88 | .10 | 2.77 | Brown | P33 | 10 | 33 | 15/16 | 25 |
| LCD2-56B-Q | | 5/16 | .75 | .66 | .88 | .10 | 2.65 | Brown | P33 | 10 | 33 | 15/16 | 25 |
| LCD2-38D-Q | | 3/8 | 1.00 | .66 | .88 | .10 | 3.00 | Brown | P33 | 10 | 33 | 15/16 | 25 |
| LCD2-12-Q | | 1/2 | 1.75 | .75 | .88 | .08 | 4.14 | Brown | P33 | 10 | 33 | 15/16 | 25 |

‡See pages D3.54 – D3.57 for tool and die information.

*Not tested to NEBS Level 3 requirements.

**Consult cable manufacturer for voltage stress relief instructions with applications greater than 2000 V.

Table continues on page D2.32

A. System Overview

B1. Cable Ties

B2. Cable Accessories

B3. Stainless Steel Ties

C1. Wiring Duct

C2. Surface Raceway

C3. Abrasion Protection

C4. Cable Management

D1. Terminals

D2. Power Connectors

D3. Grounding Connectors

E1. Labeling Systems

E2. Labels

E3. Pre-Printed & Write-On Markers

E4. Permanent Identification

E5. Lockout/Tagout & Safety Solutions

F. Index

A.
System
Overview



Code Conductor, Two-Hole, Standard Barrel with Window Lug (continued)

B1.
Cable Ties

B2.
Cable
Accessories

B3.
Stainless
Steel Ties

C1.
Wiring
Duct

C2.
Surface
Raceway

C3.
Abrasion
Protection

C4.
Cable
Management

D1.
Terminals

D2.
Power
Connectors

D3.
Grounding
Connectors

E1.
Labeling
Systems

E2.
Labels

E3.
Pre-Printed
& Write-On
Markers

E4.
Permanent
Identification

E5.
Lockout/
Tagout
& Safety
Solutions

F.
Index

| Part Number | Copper Conductor Size | Stud Hole Size (In.) | Stud Hole Spacing (In.) | Figure Dimensions (In.) | | | | PANDUIT Color Code | PANDUIT Die Index No.‡ | Burndy Die Index No.‡ | T&B Die Index No.‡ | Wire Strip Length (In.) | Std. Pkg. Qty. | |
|---------------------|-----------------------|----------------------|-------------------------|-------------------------|------|------|------|--------------------|------------------------|-----------------------|--------------------|-------------------------|----------------|----|
| | | | | W | B | T | L | | | | | | | |
| LCD1-14A-E | #1 AWG | 1/4 | .63 | .70 | .88 | .11 | 2.42 | Green | P37 | 11 | 37 | 15/16 | 20 | |
| LCD1-14B-E | | 1/4 | .75 | .70 | .88 | .11 | 2.54 | Green | P37 | 11 | 37 | 15/16 | 20 | |
| LCD1-56C-E | | 5/16 | .88 | .70 | .88 | .11 | 2.79 | Green | P37 | 11 | 37 | 15/16 | 20 | |
| LCD1-38D-E | | 3/8 | 1.00 | .70 | .88 | .11 | 2.99 | Green | P37 | 11 | 37 | 15/16 | 20 | |
| LCD1-12-E | | 1/2 | 1.75 | .75 | .88 | .09 | 4.16 | Green | P37 | 11 | 37 | 15/16 | 20 | |
| LCD1/0-14A-X | | 1/0 AWG | 1/4 | .63 | .76 | .94 | .12 | 2.57 | Pink | P42 | 12 | 42 | 1 | 10 |
| LCD1/0-14B-X | 1/4 | | .75 | .76 | .94 | .12 | 2.70 | Pink | P42 | 12 | 42 | 1 | 10 | |
| LCD1/0-56C-X | 5/16 | | .88 | .76 | .94 | .12 | 2.88 | Pink | P42 | 12 | 42 | 1 | 10 | |
| LCD1/0-38D-X | 3/8 | | 1.00 | .76 | .94 | .12 | 3.08 | Pink | P42 | 12 | 42 | 1 | 10 | |
| LCD1/0-12-X | 1/2 | | 1.75 | .80 | .94 | .12 | 4.25 | Pink | P42 | 12 | 42 | 1 | 10 | |
| LCD2/0-14A-X | 2/0 AWG | | 1/4 | .63 | .85 | .98 | .13 | 2.70 | Black | P45 | 13 | 45 | 1 1/16 | 10 |
| LCD2/0-14B-X | | 1/4 | .75 | .85 | .98 | .13 | 2.83 | Black | P45 | 13 | 45 | 1 1/16 | 10 | |
| LCD2/0-56C-X | | 5/16 | .88 | .85 | .98 | .13 | 2.95 | Black | P45 | 13 | 45 | 1 1/16 | 10 | |
| LCD2/0-38D-X | | 3/8 | 1.00 | .85 | .98 | .13 | 3.14 | Black | P45 | 13 | 45 | 1 1/16 | 10 | |
| LCD2/0-12-X | | 1/2 | 1.75 | .85 | .98 | .13 | 4.30 | Black | P45 | 13 | 45 | 1 1/16 | 10 | |
| LCD3/0-14B-X | | 3/0 AWG | 1/4 | .75 | .96 | 1.14 | .13 | 3.02 | Orange | P50 | 14 | 50 | 1 3/16 | 10 |
| LCD3/0-56D-X | 5/16 | | 1.00 | .96 | 1.14 | .13 | 3.27 | Orange | P50 | 14 | 50 | 1 3/16 | 10 | |
| LCD3/0-38D-X | 3/8 | | 1.00 | .96 | 1.14 | .13 | 3.33 | Orange | P50 | 14 | 50 | 1 3/16 | 10 | |
| LCD3/0-12-X | 1/2 | | 1.75 | .96 | 1.14 | .13 | 4.49 | Orange | P50 | 14 | 50 | 1 3/16 | 10 | |
| LCD4/0-14B-X | 4/0 AWG | | 1/4 | .75 | 1.06 | 1.19 | .14 | 3.10 | Purple | P54 | 15 | 54 | 1 1/4 | 10 |
| LCD4/0-38D-X | | | 3/8 | 1.00 | 1.06 | 1.19 | .14 | 3.44 | Purple | P54 | 15 | 54 | 1 1/4 | 10 |
| ◆ LCD4/0-12-X | | 1/2 | 1.75 | 1.06 | 1.19 | .14 | 4.58 | Purple | P54 | 15 | 54 | 1 1/4 | 10 | |
| LCD250-38D-X | | 250 kcmil | 3/8 | 1.00 | 1.17 | 1.25 | .14 | 3.54 | Yellow | P62 | 16 | 62 | 1 5/16 | 10 |
| ◆ LCD250-12-X | | | 1/2 | 1.75 | 1.17 | 1.25 | .14 | 4.68 | Yellow | P62 | 16 | 62 | 1 5/16 | 10 |
| LCD300-38D-X | | 300 kcmil | 3/8 | 1.00 | 1.19 | 1.44 | .16 | 3.74 | White | P66 | 17 | 66 | 1 1/2 | 10 |
| ◆ LCD300-12-X | 1/2 | | 1.75 | 1.19 | 1.44 | .16 | 4.92 | White | P66 | 17 | 66 | 1 1/2 | 10 | |
| LCD350-14B-X | 350 kcmil | 1/4 | .75 | 1.28 | 1.44 | .17 | 3.30 | Red | P71 | 18 | 71 | 1 1/2 | 10 | |
| LCD350-38D-X | | 3/8 | 1.00 | 1.28 | 1.44 | .17 | 3.78 | Red | P71 | 18 | 71 | 1 1/2 | 10 | |
| LCD350-12E-X | | 1/2 | 1.25 | 1.28 | 1.44 | .17 | 4.33 | Red | P71 | 18 | 71 | 1 1/2 | 10 | |
| ◆ LCD350-12-X | | 1/2 | 1.75 | 1.28 | 1.44 | .17 | 4.96 | Red | P71 | 18 | 71 | 1 1/2 | 10 | |
| LCD400-38D-6 | | 400 kcmil | 3/8 | 1.00 | 1.39 | 1.50 | .18 | 3.86 | Blue | P76 | 19 | 76 | 1 9/16 | 6 |
| ◆ LCD400-12-6 | | | 1/2 | 1.75 | 1.39 | 1.50 | .18 | 5.04 | Blue | P76 | 19 | 76 | 1 9/16 | 6 |
| LCD500-14B-6 | 500 kcmil | 1/4 | .75 | 1.54 | 1.75 | .22 | 3.71 | Brown | P87 | 20 | 87 | 1 13/16 | 6 | |
| LCD500-38D-6 | | 3/8 | 1.00 | 1.54 | 1.75 | .22 | 4.19 | Brown | P87 | 20 | 87 | 1 13/16 | 6 | |
| LCD500-12E-6 | | 1/2 | 1.25 | 1.54 | 1.75 | .22 | 4.74 | Brown | P87 | 20 | 87 | 1 13/16 | 6 | |
| ◆ LCD500-12-6 | | 1/2 | 1.75 | 1.54 | 1.75 | .22 | 5.37 | Brown | P87 | 20 | 87 | 1 13/16 | 6 | |
| LCD600-38D-6 | | 600 kcmil | 3/8 | 1.00 | 1.70 | 1.75 | .26 | 4.24 | Green | P94 | 22 | 94 | 1 13/16 | 6 |
| ◆ LCD600-12-6 | | | 1/2 | 1.75 | 1.70 | 1.75 | .26 | 5.42 | Green | P94 | 22 | 94 | 1 13/16 | 6 |
| LCD750-38D-6 | 750 kcmil | 3/8 | 1.00 | 1.89 | 1.88 | .26 | 4.71 | Black | P106 | 24 | 106 | 1 15/16 | 6 | |
| ◆ LCD750-12-6 | | 1/2 | 1.75 | 1.89 | 1.88 | .26 | 5.65 | Black | P106 | 24 | 106 | 1 15/16 | 6 | |
| LCD750-58G-6 | 750 kcmil | 5/8 | 1.50 | 1.89 | 1.88 | .26 | 5.46 | Black | P106 | 24 | 106 | 1 15/16 | 6 | |
| ◆ LCD1000-12-3 | 1000 kcmil | 1/2 | 1.75 | 2.17 | 1.88 | .32 | 5.77 | White | P125 | 27 | 125 | 1 15/16 | 3 | |
| LCD1000-12E-3 | | 1/2 | 1.25 | 2.17 | 1.88 | .32 | 5.27 | White | P125 | 27 | 125 | 1 15/16 | 3 | |

‡See pages D3.54 – D3.57 for tool and die information.

**Consult cable manufacturer for voltage stress relief instructions with applications greater than 2000 V.

◆NEMA hole sizes and spacing.



Code Conductor, Two-Hole, Standard Barrel with Window Lug, 45° Angle

For Use with Stranded Copper Conductors

Type LCD-H

- Color-coded barrels marked with *PANDUIT* and specified competitor die index numbers for proper crimp die selection
- Inspection window to visually assure full conductor insertion
- Tin-plated to inhibit corrosion
- UL Listed and CSA Certified to 35 KV** and temperature rated to 90°C when crimped with *PANDUIT* and specified competitor crimping tools and dies

- UL Listed and CSA Certified for wide wire range-taking capability when crimped with *PANDUIT*® *UNI-DIE*™ Dieless Crimping Tools‡
- **Tested by Telcordia – meets NEBS Level 3**
- American Bureau of Shipping approved
- Available with NEMA hole sizes and spacing

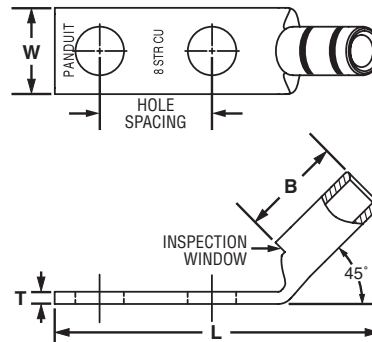

| Part Number | Copper Conductor Size | Stud Hole Size (In.) | Stud Hole Spacing (In.) | Figure Dimensions (In.) | | | | PANDUIT Color Code | PANDUIT Die Index No.‡ | Burndy Die Index No.‡ | T&B Die Index No.‡ | Wire Strip Length (In.) | Std. Pkg. Qty. |
|---------------|----------------------------|----------------------|-------------------------|-------------------------|-----|-----|------|--------------------|------------------------|-----------------------|--------------------|-------------------------|----------------|
| | | | | W | B | T | L | | | | | | |
| LCD10-10AH-L* | #14 – 10 | #10 | .63 | .38 | .38 | .06 | 1.59 | — | — | — | — | 7/16 | 50 |
| LCD10-14AH-L* | AWG STR, #12 – 10 | 1/4 | .63 | .42 | .38 | .05 | 1.67 | — | — | — | — | 7/16 | 50 |
| LCD10-38DH-L* | AWG SOL | 3/8 | 1.00 | .56 | .38 | .04 | 2.28 | — | — | — | — | 7/16 | 50 |
| LCD8-10AH-L | #8 AWG | #10 | .63 | .41 | .56 | .08 | 1.73 | Red | P21 | 49 | 21 | 5/8 | 50 |
| LCD8-14AH-L | | 1/4 | .63 | .48 | .56 | .07 | 1.81 | Red | P21 | 49 | 21 | 5/8 | 50 |
| LCD8-14BH-L | | 1/4 | .75 | .48 | .56 | .07 | 1.94 | Red | P21 | 49 | 21 | 5/8 | 50 |
| LCD8-14DH-L | | 1/4 | 1.00 | .48 | .56 | .07 | 2.19 | Red | P21 | 49 | 21 | 5/8 | 50 |
| LCD8-38DH-L | | 3/8 | 1.00 | .63 | .56 | .05 | 2.40 | Red | P21 | 49 | 21 | 5/8 | 50 |
| LCD6-10AH-L | #6 AWG | #10 | .63 | .46 | .81 | .08 | 1.92 | Blue | P24 | 7 | 24 | 7/8 | 50 |
| LCD6-10BH-L | | #10 | .75 | .46 | .81 | .08 | 2.04 | Blue | P24 | 7 | 24 | 7/8 | 50 |
| LCD6-10DH-L | | #10 | 1.00 | .46 | .81 | .08 | 2.29 | Blue | P24 | 7 | 24 | 7/8 | 50 |
| LCD6-14AH-L | | 1/4 | .63 | .48 | .81 | .08 | 2.00 | Blue | P24 | 7 | 24 | 7/8 | 50 |
| LCD6-14BH-L | | 1/4 | .75 | .48 | .81 | .08 | 2.13 | Blue | P24 | 7 | 24 | 7/8 | 50 |
| LCD6-14DH-L | | 1/4 | 1.00 | .48 | .81 | .08 | 2.38 | Blue | P24 | 7 | 24 | 7/8 | 50 |
| LCD6-56DH-L | | 5/16 | 1.00 | .56 | .81 | .07 | 2.49 | Blue | P24 | 7 | 24 | 7/8 | 50 |
| LCD6-38DH-L | | 3/8 | 1.00 | .62 | .81 | .06 | 2.59 | Blue | P24 | 7 | 24 | 7/8 | 50 |
| LCD4-10AH-L | #4 – 3 AWG STR, #2 AWG SOL | #10 | .63 | .55 | .81 | .09 | 1.94 | Gray | P29 | 8 | 29 | 7/8 | 50 |
| LCD4-10BH-L | | #10 | .75 | .55 | .81 | .09 | 2.06 | Gray | P29 | 8 | 29 | 7/8 | 50 |
| LCD4-14AH-L | | 1/4 | .63 | .55 | .81 | .09 | 2.03 | Gray | P29 | 8 | 29 | 7/8 | 50 |
| LCD4-14BH-L | | 1/4 | .75 | .55 | .81 | .09 | 2.15 | Gray | P29 | 8 | 29 | 7/8 | 50 |
| LCD4-14DH-L | | 1/4 | 1.00 | .55 | .81 | .09 | 2.40 | Gray | P29 | 8 | 29 | 7/8 | 50 |
| LCD4-38DH-L | | | 3/8 | 1.00 | .62 | .81 | .08 | 2.62 | Gray | P29 | 8 | 29 | 7/8 |

‡See pages D3.54 – D3.57 for tool and die information.

*Not tested to NEBS Level 3 requirements.

**Consult cable manufacturer for voltage stress relief instructions with applications greater than 2000 V.

Table continues on page D2.34

- A. System Overview
- B1. Cable Ties
- B2. Cable Accessories
- B3. Stainless Steel Ties
- C1. Wiring Duct
- C2. Surface Raceway
- C3. Abrasion Protection
- C4. Cable Management
- D1. Terminals
- D2. Power Connectors
- D3. Grounding Connectors
- E1. Labeling Systems
- E2. Labels
- E3. Pre-Printed & Write-On Markers
- E4. Permanent Identification
- E5. Lockout/Tagout & Safety Solutions
- F. Index

A. System Overview



Code Conductor, Two-Hole, Standard Barrel with Window Lug, 45° Angle (continued)

B1. Cable Ties

B2. Cable Accessories

B3. Stainless Steel Ties

C1. Wiring Duct

C2. Surface Raceway

C3. Abrasion Protection

C4. Cable Management

D1. Terminals

D2. Power Connectors

D3. Grounding Connectors

E1. Labeling Systems

E2. Labels

E3. Pre-Printed & Write-On Markers

E4. Permanent Identification

E5. Lockout/Tagout & Safety Solutions

F. Index

| Part Number | Copper Conductor Size | Stud Hole Size (In.) | Stud Hole Spacing (In.) | Figure Dimensions (In.) | | | | PANDUIT Color Code | PANDUIT Die Index No.‡ | Burndy Die Index No.‡ | T&B Die Index No.‡ | Wire Strip Length (In.) | Std. Pkg. Qty. | |
|---------------|-----------------------|----------------------|-------------------------|-------------------------|------|------|------|--------------------|------------------------|-----------------------|--------------------|-------------------------|----------------|----|
| | | | | W | B | T | L | | | | | | | |
| LCD2-14AH-Q | #2 AWG | 1/4 | .63 | .60 | .88 | .10 | 2.11 | Brown | P33 | 10 | 33 | 15/16 | 25 | |
| LCD2-14BH-Q | | 1/4 | .75 | .60 | .88 | .10 | 2.24 | Brown | P33 | 10 | 33 | 15/16 | 25 | |
| LCD2-14DH-Q | | 1/4 | 1.00 | .60 | .88 | .10 | 2.49 | Brown | P33 | 10 | 33 | 15/16 | 25 | |
| LCD2-56BH-Q | | 5/16 | .75 | .66 | .88 | .10 | 2.36 | Brown | P33 | 10 | 33 | 15/16 | 25 | |
| LCD2-38DH-Q | | 3/8 | 1.00 | .66 | .88 | .10 | 2.71 | Brown | P33 | 10 | 33 | 15/16 | 25 | |
| LCD2-12H-Q | | 1/2 | 1.75 | .75 | .88 | .08 | 3.84 | Brown | P33 | 10 | 33 | 15/16 | 25 | |
| LCD1-14AH-E | #1 AWG | 1/4 | .63 | .70 | .88 | .11 | 2.12 | Green | P37 | 11 | 37 | 15/16 | 20 | |
| LCD1-14BH-E | | 1/4 | .75 | .70 | .88 | .11 | 2.25 | Green | P37 | 11 | 37 | 15/16 | 20 | |
| LCD1-56CH-E | | 5/16 | .88 | .70 | .88 | .11 | 2.50 | Green | P37 | 11 | 37 | 15/16 | 20 | |
| LCD1-38DH-E | | 3/8 | 1.00 | .70 | .88 | .11 | 2.70 | Green | P37 | 11 | 37 | 15/16 | 20 | |
| LCD1-12H-E | | 1/2 | 1.75 | .75 | .88 | .09 | 3.87 | Green | P37 | 11 | 37 | 15/16 | 20 | |
| LCD1/0-14AH-X | | 1/0 AWG | 1/4 | .63 | .76 | .94 | .12 | 2.26 | Pink | P42 | 12 | 42 | 1 | 10 |
| LCD1/0-14BH-X | 1/4 | | .75 | .76 | .94 | .12 | 2.38 | Pink | P42 | 12 | 42 | 1 | 10 | |
| LCD1/0-56CH-X | 5/16 | | .88 | .76 | .94 | .12 | 2.56 | Pink | P42 | 12 | 42 | 1 | 10 | |
| LCD1/0-38DH-X | 3/8 | | 1.00 | .76 | .94 | .12 | 2.76 | Pink | P42 | 12 | 42 | 1 | 10 | |
| LCD1/0-12H-X | 1/2 | | 1.75 | .80 | .94 | .12 | 3.93 | Pink | P42 | 12 | 42 | 1 | 10 | |
| LCD2/0-14AH-X | 2/0 AWG | | 1/4 | .63 | .85 | .98 | .13 | 2.39 | Black | P45 | 13 | 45 | 1 1/16 | 10 |
| LCD2/0-14BH-X | | 1/4 | .75 | .85 | .98 | .13 | 2.52 | Black | P45 | 13 | 45 | 1 1/16 | 10 | |
| LCD2/0-56CH-X | | 5/16 | .88 | .85 | .98 | .13 | 2.64 | Black | P45 | 13 | 45 | 1 1/16 | 10 | |
| LCD2/0-38DH-X | | 3/8 | 1.00 | .85 | .98 | .13 | 2.83 | Black | P45 | 13 | 45 | 1 1/16 | 10 | |
| LCD2/0-12H-X | | 1/2 | 1.75 | .85 | .98 | .13 | 3.99 | Black | P45 | 13 | 45 | 1 1/16 | 10 | |
| LCD3/0-14BH-X | | 3/0 AWG | 1/4 | .75 | .96 | 1.14 | .13 | 2.65 | Orange | P50 | 14 | 50 | 1 3/16 | 10 |
| LCD3/0-56DH-X | 5/16 | | 1.00 | .96 | 1.14 | .13 | 2.90 | Orange | P50 | 14 | 50 | 1 3/16 | 10 | |
| LCD3/0-38DH-X | 3/8 | | 1.00 | .96 | 1.14 | .13 | 2.96 | Orange | P50 | 14 | 50 | 1 3/16 | 10 | |
| LCD3/0-12H-X | 1/2 | | 1.75 | .96 | 1.14 | .13 | 4.12 | Orange | P50 | 14 | 50 | 1 3/16 | 10 | |
| LCD4/0-14BH-X | 4/0 AWG | | 1/4 | .75 | 1.06 | 1.19 | .14 | 2.72 | Purple | P54 | 15 | 54 | 1 1/4 | 10 |
| LCD4/0-38DH-X | | | 3/8 | 1.00 | 1.06 | 1.19 | .14 | 3.05 | Purple | P54 | 15 | 54 | 1 1/4 | 10 |
| LCD4/0-12H-X | | 1/2 | 1.75 | 1.06 | 1.19 | .14 | 4.19 | Purple | P54 | 15 | 54 | 1 1/4 | 10 | |
| LCD250-38DH-X | | 250 kcmil | 3/8 | 1.00 | 1.17 | 1.25 | .14 | 3.13 | Yellow | P62 | 16 | 62 | 1 5/16 | 10 |
| LCD250-12H-X | | | 1/2 | 1.75 | 1.17 | 1.25 | .14 | 4.27 | Yellow | P62 | 16 | 62 | 1 5/16 | 10 |
| LCD300-38DH-X | | 300 kcmil | 3/8 | 1.00 | 1.17 | 1.44 | .14 | 3.36 | White | P66 | 17 | 66 | 1 1/2 | 10 |
| LCD300-12H-X | 1/2 | | 1.75 | 1.17 | 1.44 | .14 | 4.54 | White | P66 | 17 | 66 | 1 1/2 | 10 | |
| LCD350-14BH-X | 350 kcmil | 1/4 | .75 | 1.28 | 1.44 | .17 | 2.92 | Red | P71 | 18 | 71 | 1 1/2 | 10 | |
| LCD350-38DH-X | | 3/8 | 1.00 | 1.28 | 1.44 | .17 | 3.40 | Red | P71 | 18 | 71 | 1 1/2 | 10 | |
| LCD350-12EH-X | | 1/2 | 1.25 | 1.28 | 1.44 | .17 | 3.95 | Red | P71 | 18 | 71 | 1 1/2 | 10 | |
| LCD350-12H-X | | 1/2 | 1.75 | 1.28 | 1.44 | .17 | 4.58 | Red | P71 | 18 | 71 | 1 1/2 | 10 | |
| LCD400-38DH-6 | | 400 kcmil | 3/8 | 1.00 | 1.39 | 1.50 | .18 | 3.50 | Blue | P76 | 19 | 76 | 1 9/16 | 6 |
| LCD400-12H-6 | | | 1/2 | 1.75 | 1.39 | 1.50 | .18 | 4.68 | Blue | P76 | 19 | 76 | 1 9/16 | 6 |
| LCD500-14BH-6 | 500 kcmil | 1/4 | .75 | 1.54 | 1.75 | .22 | 3.27 | Brown | P87 | 20 | 87 | 1 13/16 | 6 | |
| LCD500-38DH-6 | | 3/8 | 1.00 | 1.54 | 1.75 | .22 | 3.75 | Brown | P87 | 20 | 87 | 1 13/16 | 6 | |
| LCD500-12EH-6 | | 1/2 | 1.25 | 1.54 | 1.75 | .22 | 4.30 | Brown | P87 | 20 | 87 | 1 13/16 | 6 | |
| LCD500-12H-6 | | 1/2 | 1.75 | 1.54 | 1.75 | .22 | 4.93 | Brown | P87 | 20 | 87 | 1 13/16 | 6 | |
| LCD600-38DH-6 | | 600 kcmil | 3/8 | 1.00 | 1.70 | 1.75 | .26 | 3.81 | Green | P94 | 22 | 94 | 1 13/16 | 6 |
| LCD600-12H-6 | | | 1/2 | 1.75 | 1.70 | 1.75 | .26 | 4.99 | Green | P94 | 22 | 94 | 1 13/16 | 6 |

‡See pages D3.54 – D3.57 for tool and die information.

**Consult cable manufacturer for voltage stress relief instructions with applications greater than 2000 V.

◆NEMA hole sizes and spacing.



Code Conductor, Two-Hole, Standard Barrel with Window Lug, 90° Angle

For Use with Stranded Copper Conductors

Type LCD-F

- Color-coded barrels marked with *PANDUIT* and specified competitor die index numbers for proper crimp die selection
- Inspection window to visually assure full conductor insertion
- Tin-plated to inhibit corrosion
- UL Listed and CSA Certified to 35 KV** and temperature rated to 90°C when crimped with *PANDUIT* and specified competitor crimping tools and dies

- UL Listed and CSA Certified for wide wire range-taking capability when crimped with *PANDUIT*® *UNI-DIE*™ Dieless Crimping Tools‡
- **Tested by Telcordia – meets NEBS Level 3**
- American Bureau of Shipping approved
- Available with NEMA hole sizes and spacing

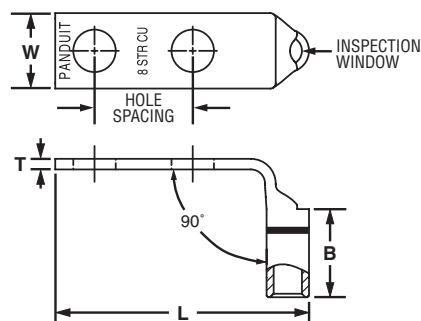

| Part Number | Copper Conductor Size | Stud Hole Size (In.) | Stud Hole Spacing (In.) | Figure Dimensions (In.) | | | | PANDUIT Color Code | PANDUIT Die Index No.‡ | Burdny Die Index No.‡ | T&B Die Index No.‡ | Wire Strip Length (In.) | Std. Pkg. Qty. |
|---------------|------------------------------------|----------------------|-------------------------|-------------------------|-----|-----|------|--------------------|------------------------|-----------------------|--------------------|-------------------------|----------------|
| | | | | W | B | T | L | | | | | | |
| LCD10-10AF-L* | #14 – 10 AWG STR, #12 – 10 AWG SOL | #10 | .63 | .38 | .38 | .06 | 1.47 | — | — | — | — | 7/16 | 50 |
| LCD10-14AF-L* | | 1/4 | .63 | .42 | .38 | .05 | 1.56 | — | — | — | — | 7/16 | 50 |
| LCD10-38DF-L* | | 3/8 | 1.00 | .56 | .38 | .04 | 2.16 | — | — | — | — | 7/16 | 50 |
| LCD8-10AF-L | #8 AWG | #10 | .63 | .41 | .56 | .08 | 1.53 | Red | P21 | 49 | 21 | 5/8 | 50 |
| LCD8-14AF-L | | 1/4 | .63 | .48 | .56 | .07 | 1.62 | Red | P21 | 49 | 21 | 5/8 | 50 |
| LCD8-14BF-L | | 1/4 | .75 | .48 | .56 | .07 | 1.74 | Red | P21 | 49 | 21 | 5/8 | 50 |
| LCD8-14DF-L | | 1/4 | 1.00 | .48 | .56 | .07 | 1.99 | Red | P21 | 49 | 21 | 5/8 | 50 |
| LCD8-38DF-L | | 3/8 | 1.00 | .63 | .56 | .05 | 2.21 | Red | P21 | 49 | 21 | 5/8 | 50 |
| LCD6-10AF-L | #6 AWG | #10 | .63 | .46 | .81 | .08 | 1.57 | Blue | P24 | 7 | 24 | 7/8 | 50 |
| LCD6-10BF-L | | #10 | .75 | .46 | .81 | .08 | 1.69 | Blue | P24 | 7 | 24 | 7/8 | 50 |
| LCD6-10DF-L | | #10 | 1.00 | .46 | .81 | .08 | 1.94 | Blue | P24 | 7 | 24 | 7/8 | 50 |
| LCD6-14AF-L | | 1/4 | .63 | .48 | .81 | .08 | 1.66 | Blue | P24 | 7 | 24 | 7/8 | 50 |
| LCD6-14BF-L | | 1/4 | .75 | .48 | .81 | .08 | 1.78 | Blue | P24 | 7 | 24 | 7/8 | 50 |
| LCD6-14DF-L | | 1/4 | 1.00 | .48 | .81 | .08 | 2.03 | Blue | P24 | 7 | 24 | 7/8 | 50 |
| LCD6-56DF-L | | 5/16 | 1.00 | .56 | .81 | .07 | 2.15 | Blue | P24 | 7 | 24 | 7/8 | 50 |
| LCD6-38DF-L | | 3/8 | 1.00 | .62 | .81 | .06 | 2.25 | Blue | P24 | 7 | 24 | 7/8 | 50 |
| LCD4-10AF-L | #4 – 3 AWG STR, #2 AWG SOL | #10 | .63 | .55 | .81 | .09 | 1.65 | Gray | P29 | 8 | 29 | 7/8 | 50 |
| LCD4-10BF-L | | #10 | .75 | .55 | .81 | .09 | 1.78 | Gray | P29 | 8 | 29 | 7/8 | 50 |
| LCD4-14AF-L | | 1/4 | .63 | .55 | .81 | .09 | 1.74 | Gray | P29 | 8 | 29 | 7/8 | 50 |
| LCD4-14BF-L | | 1/4 | .75 | .55 | .81 | .09 | 1.87 | Gray | P29 | 8 | 29 | 7/8 | 50 |
| LCD4-14DF-L | | 1/4 | 1.00 | .55 | .81 | .09 | 2.12 | Gray | P29 | 8 | 29 | 7/8 | 50 |
| LCD4-38DF-L | | 3/8 | 1.00 | .62 | .81 | .08 | 2.34 | Gray | P29 | 8 | 29 | 7/8 | 50 |
| LCD2-14AF-Q | #2 AWG | 1/4 | .63 | .60 | .88 | .10 | 1.86 | Brown | P33 | 10 | 33 | 15/16 | 25 |
| LCD2-14BF-Q | | 1/4 | .75 | .60 | .88 | .10 | 1.99 | Brown | P33 | 10 | 33 | 15/16 | 25 |
| LCD2-14DF-Q | | 1/4 | 1.00 | .60 | .88 | .10 | 2.24 | Brown | P33 | 10 | 33 | 15/16 | 25 |
| LCD2-56BF-Q | | 5/16 | .75 | .66 | .88 | .10 | 2.11 | Brown | P33 | 10 | 33 | 15/16 | 25 |
| LCD2-38DF-Q | | 3/8 | 1.00 | .66 | .88 | .10 | 2.47 | Brown | P33 | 10 | 33 | 15/16 | 25 |
| LCD2-12F-Q | | 1/2 | 1.75 | .75 | .88 | .08 | 3.61 | Brown | P33 | 10 | 33 | 15/16 | 25 |

‡See pages D3.54 – D3.57 for tool and die information.

*Not tested to NEBS Level 3 requirements.

**Consult cable manufacturer for voltage stress relief instructions with applications greater than 2000 V.

Table continues on page D2.36

A. System Overview

B1. Cable Ties

B2. Cable Accessories

B3. Stainless Steel Ties

C1. Wiring Duct

C2. Surface Raceway

C3. Abrasion Protection

C4. Cable Management

D1. Terminals

D2. Power Connectors

D3. Grounding Connectors

E1. Labeling Systems

E2. Labels

E3. Pre-Printed & Write-On Markers

E4. Permanent Identification

E5. Lockout/Tagout & Safety Solutions

F. Index

A.
System
Overview



Code Conductor, Two-Hole, Standard Barrel with Window Lug, 90° Angle (continued)

B1.
Cable Ties

B2.
Cable
Accessories

B3.
Stainless
Steel Ties

C1.
Wiring
Duct

C2.
Surface
Raceway

C3.
Abrasion
Protection

C4.
Cable
Management

D1.
Terminals

D2.
Power
Connectors

D3.
Grounding
Connectors

E1.
Labeling
Systems

E2.
Labels

E3.
Pre-Printed
& Write-On
Markers

E4.
Permanent
Identification

E5.
Lockout/
Tagout
& Safety
Solutions

F.
Index

| Part Number | Copper Conductor Size | Stud Hole Size (In.) | Stud Hole Spacing (In.) | Figure Dimensions (In.) | | | | PANDUIT Color Code | PANDUIT Die Index No.‡ | Burndy Die Index No.‡ | T&B Die Index No.‡ | Wire Strip Length (In.) | Std. Pkg. Qty. |
|----------------------|-----------------------|----------------------|-------------------------|-------------------------|------|------|-------|--------------------|------------------------|-----------------------|--------------------|-------------------------|----------------|
| | | | | W | B | T | L | | | | | | |
| LCD1-14AF-E | #1 AWG | 1/4 | .63 | .70 | .88 | .11 | 1.94 | Green | P37 | 11 | 37 | 15/16 | 20 |
| LCD1-14BF-E | | 1/4 | .75 | .70 | .88 | .11 | 2.06 | Green | P37 | 11 | 37 | 15/16 | 20 |
| LCD1-56CF-E | | 5/16 | .88 | .70 | .88 | .11 | 2.31 | Green | P37 | 11 | 37 | 15/16 | 20 |
| LCD1-38DF-E | | 3/8 | 1.00 | .70 | .88 | .11 | 2.51 | Green | P37 | 11 | 37 | 15/16 | 20 |
| LCD1-12F-E | | 1/2 | 1.75 | .75 | .88 | .09 | 3.68 | Green | P37 | 11 | 37 | 15/16 | 20 |
| LCD1/0-14AF-X | 1/0 AWG | 1/4 | .63 | .76 | .94 | .12 | 2.08 | Pink | P42 | 12 | 42 | 1 | 10 |
| LCD1/0-14BF-X | | 1/4 | .75 | .76 | .94 | .12 | 2.20 | Pink | P42 | 12 | 42 | 1 | 10 |
| LCD1/0-56CF-X | | 5/16 | .88 | .76 | .94 | .12 | 2.38 | Pink | P42 | 12 | 42 | 1 | 10 |
| LCD1/0-38DF-X | | 3/8 | 1.00 | .76 | .94 | .12 | 2.58 | Pink | P42 | 12 | 42 | 1 | 10 |
| LCD1/0-12F-X | 2/0 AWG | 1/2 | 1.75 | .80 | .94 | .12 | 3.75 | Pink | P42 | 12 | 42 | 1 | 10 |
| LCD2/0-14AF-X | | 1/4 | .63 | .85 | .98 | .13 | 2.22 | Black | P45 | 13 | 45 | 1 1/16 | 10 |
| LCD2/0-14BF-X | | 1/4 | .75 | .85 | .98 | .13 | 2.34 | Black | P45 | 13 | 45 | 1 1/16 | 10 |
| LCD2/0-56CF-X | | 5/16 | .88 | .85 | .98 | .13 | 2.47 | Black | P45 | 13 | 45 | 1 1/16 | 10 |
| LCD2/0-38DF-X | | 3/8 | 1.00 | .85 | .98 | .13 | 2.66 | Black | P45 | 13 | 45 | 1 1/16 | 10 |
| LCD2/0-12F-X | 3/0 AWG | 1/2 | 1.75 | .85 | .98 | .13 | 3.82 | Black | P45 | 13 | 45 | 1 1/16 | 10 |
| LCD3/0-14BF-X | | 1/4 | .75 | .96 | 1.14 | .13 | 2.42 | Orange | P50 | 14 | 50 | 1 3/16 | 10 |
| LCD3/0-56DF-X | | 5/16 | 1.00 | .96 | 1.14 | .13 | 2.67 | Orange | P50 | 14 | 50 | 1 3/16 | 10 |
| LCD3/0-38DF-X | | 3/8 | 1.00 | .96 | 1.14 | .13 | 2.73 | Orange | P50 | 14 | 50 | 1 3/16 | 10 |
| LCD3/0-12F-X | 4/0 AWG | 1/2 | 1.75 | .96 | 1.14 | .13 | 3.89 | Orange | P50 | 14 | 50 | 1 3/16 | 10 |
| LCD4/0-14BF-X | | 1/4 | .75 | 1.06 | 1.19 | .14 | 2.50 | Purple | P54 | 15 | 54 | 1 1/4 | 10 |
| LCD4/0-38DF-X | | 3/8 | 1.00 | 1.06 | 1.19 | .14 | 2.84 | Purple | P54 | 15 | 54 | 1 1/4 | 10 |
| ◆ LCD4/0-12F-X | 250 kcmil | 1/2 | 1.75 | 1.06 | 1.19 | .14 | 3.98 | Purple | P54 | 15 | 54 | 1 1/4 | 10 |
| LCD250-38DF-X | | 3/8 | 1.00 | 1.17 | 1.25 | .14 | 2.90 | Yellow | P62 | 16 | 62 | 1 5/16 | 10 |
| ◆ LCD250-12F-X | 300 kcmil | 1/2 | 1.75 | 1.17 | 1.25 | .14 | 4.04 | Yellow | P62 | 16 | 62 | 1 5/16 | 10 |
| LCD300-38DF-X | | 3/8 | 1.00 | 1.19 | 1.44 | .16 | 2.88 | White | P66 | 17 | 66 | 1 1/2 | 10 |
| ◆ LCD300-12F-X | 350 kcmil | 1/2 | 1.75 | 1.19 | 1.44 | .16 | 4.06 | White | P66 | 17 | 66 | 1 1/2 | 10 |
| LCD350-14BF-X | | 1/4 | .75 | 1.28 | 1.44 | .17 | 2.46 | Red | P71 | 18 | 71 | 1 1/2 | 10 |
| LCD350-38DF-X | | 3/8 | 1.00 | 1.28 | 1.44 | .17 | 2.94 | Red | P71 | 18 | 71 | 1 1/2 | 10 |
| ◆ LCD350-12EF-X | 400 kcmil | 1/2 | 1.25 | 1.28 | 1.44 | .17 | 3.49 | Red | P71 | 18 | 71 | 1 1/2 | 10 |
| LCD350-12F-X | | 1/2 | 1.75 | 1.28 | 1.44 | .17 | 4.12 | Red | P71 | 18 | 71 | 1 1/2 | 10 |
| LCD400-38DF-6 | 500 kcmil | 3/8 | 1.00 | 1.39 | 1.50 | .18 | 3.02 | Blue | P76 | 19 | 76 | 1 9/16 | 6 |
| ◆ LCD400-12F-6 | | 1/2 | 1.75 | 1.39 | 1.50 | .18 | 4.20 | Blue | P76 | 19 | 76 | 1 9/16 | 6 |
| LCD500-14BF-6 | 600 kcmil | 1/4 | .75 | 1.54 | 1.75 | .22 | 2.65 | Brown | P87 | 20 | 87 | 1 13/16 | 6 |
| LCD500-38DF-6 | | 3/8 | 1.00 | 1.54 | 1.75 | .22 | 3.13 | Brown | P87 | 20 | 87 | 1 13/16 | 6 |
| LCD500-12EF-6 | | 1/2 | 1.25 | 1.54 | 1.75 | .22 | 3.68 | Brown | P87 | 20 | 87 | 1 13/16 | 6 |
| ◆ LCD500-12F-6 | 600 kcmil | 1/2 | 1.75 | 1.54 | 1.75 | .22 | 4.31 | Brown | P87 | 20 | 87 | 1 13/16 | 6 |
| LCD600-38DF-6 | | 3/8 | 1.00 | 1.70 | 1.75 | .26 | 3.26 | Green | P94 | 22 | 94 | 1 13/16 | 6 |
| ◆ LCD600-12F-6 | 1/2 | 1.75 | 1.70 | 1.75 | .26 | 4.44 | Green | P94 | 22 | 94 | 1 13/16 | 6 | |

‡See pages D3.54 – D3.57 for tool and die information.

**Consult cable manufacturer for voltage stress relief instructions with applications greater than 2000 V.

◆NEMA hole sizes and spacing.



Code Conductor, Two-Hole, Standard Barrel with Window, Narrow Tongue Lug

For Use with Stranded Copper Conductors

Type LCDN

- Narrow tongue width for limited space applications
- Color-coded barrels marked with **PANDUIT** and specified competitor die index numbers for proper crimp die selection
- Inspection window to visually assure full conductor insertion
- Tin-plated to inhibit corrosion
- UL Listed and CSA Certified to 35 KV** and temperature rated to 90°C when crimped with **PANDUIT** and specified competitor crimping tools and dies
- UL Listed and CSA Certified for wide wire range-taking capability when crimped with **PANDUIT® UNI-DIE™** Dieless Crimping Tools‡

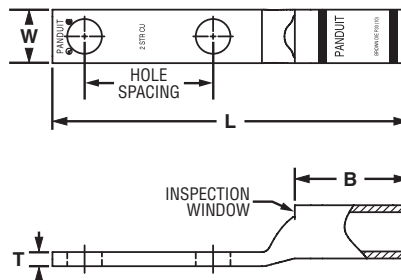

| Part Number | Copper Conductor Size | Stud Hole Size (In.) | Stud Hole Spacing (In.) | Figure Dimensions (In.) | | | | PANDUIT Color Code | PANDUIT Die Index No.‡ | Burdny Die Index No.‡ | T&B Die Index No.‡ | Wire Strip Length (In.) | Std. Pkg. Qty. |
|---------------|-----------------------|----------------------|-------------------------|-------------------------|------|-----|------|--------------------|------------------------|-----------------------|--------------------|-------------------------|----------------|
| | | | | W | B | T | L | | | | | | |
| LCDN2-14A-Q | #2 AWG | 1/4 | .63 | .42 | .88 | .11 | 2.40 | Brown | P33 | 10 | 33 | 15/16 | 25 |
| LCDN2-14B-Q | | 1/4 | .75 | .42 | .88 | .11 | 2.52 | Brown | P33 | 10 | 33 | 15/16 | 25 |
| LCDN2-14D-Q | | 1/4 | 1.00 | .42 | .88 | .11 | 2.77 | Brown | P33 | 10 | 33 | 15/16 | 25 |
| LCDN1-14B-E | #1 AWG | 1/4 | .75 | .47 | .88 | .11 | 2.54 | Green | P37 | 11 | 37 | 15/16 | 20 |
| LCDN1/0-14D-X | 1/0 AWG | 1/4 | 1.00 | .52 | .94 | .13 | 2.95 | Pink | P42 | 12 | 42 | 1 | 10 |
| LCDN1/0-56D-X | | 5/16 | 1.00 | .52 | .94 | .13 | 3.00 | Pink | P42 | 12 | 42 | 1 | 10 |
| LCDN2/0-14A-X | 2/0 AWG | 1/4 | .63 | .58 | .98 | .13 | 2.71 | Black | P45 | 13 | 45 | 1 1/16 | 10 |
| LCDN2/0-14D-X | | 1/4 | 1.00 | .58 | .98 | .13 | 3.09 | Black | P45 | 13 | 45 | 1 1/16 | 10 |
| LCDN2/0-56A-X | | 5/16 | .63 | .58 | .98 | .13 | 2.71 | Black | P45 | 13 | 45 | 1 1/16 | 10 |
| LCDN2/0-56D-X | | 5/16 | 1.00 | .58 | .98 | .13 | 3.09 | Black | P45 | 13 | 45 | 1 1/16 | 10 |
| LCDN350-38D-X | 350 kcmil | 3/8 | 1.00 | .88 | 1.44 | .17 | 3.79 | Red | P71 | 18 | 71 | 1 1/2 | 10 |
| LCDN500-38D-6 | 500 kcmil | 3/8 | 1.00 | 1.06 | 1.75 | .22 | 4.20 | Brown | P87 | 20 | 87 | 1 13/16 | 6 |
| LCDN500-12D-6 | | 1/2 | 1.00 | 1.06 | 1.75 | .22 | 4.63 | Brown | P87 | 20 | 87 | 1 13/16 | 6 |
| LCDN750-38D-6 | 750 kcmil | 3/8 | 1.00 | 1.30 | 1.88 | .26 | 4.72 | Black | P106 | 24 | 106 | 1 15/16 | 6 |
| LCDN750-12D-6 | | 1/2 | 1.00 | 1.30 | 1.88 | .26 | 4.91 | Black | P106 | 24 | 106 | 1 15/16 | 6 |

‡See pages D3.54 – D3.57 for tool and die information.

**Consult cable manufacturer for voltage stress relief instructions with applications greater than 2000 V.

A. System Overview

B1. Cable Ties

B2. Cable Accessories

B3. Stainless Steel Ties

C1. Wiring Duct

C2. Surface Raceway

C3. Abrasion Protection

C4. Cable Management

D1. Terminals

D2. Power Connectors

D3. Grounding Connectors

E1. Labeling Systems

E2. Labels

E3. Pre-Printed & Write-On Markers

E4. Permanent Identification

E5. Lockout/Tagout & Safety Solutions

F. Index

A.
System
Overview



Code Conductor, Two-Hole, Standard Barrel with Window, Narrow Tongue Lug, 45°

B1.
Cable Ties

For Use with Stranded Copper Conductors

Type LCDN-H

- Narrow tongue width for limited space applications
- Color-coded barrels marked with *PANDUIT* and specified competitor die index numbers for proper crimp die selection
- Inspection window to visually assure full conductor insertion
- Tin-plated to inhibit corrosion

- UL Listed and CSA Certified to 35 KV** and temperature rated to 90°C when crimped with *PANDUIT* and specified competitor crimping tools and dies
- UL Listed and CSA Certified for wide wire range-taking capability when crimped with *PANDUIT*® *UNI-DIE*™ Dieless Crimping Tools‡

B2.
Cable
Accessories

B3.
Stainless
Steel Ties

C1.
Wiring
Duct

C2.
Surface
Raceway

C3.
Abrasion
Protection

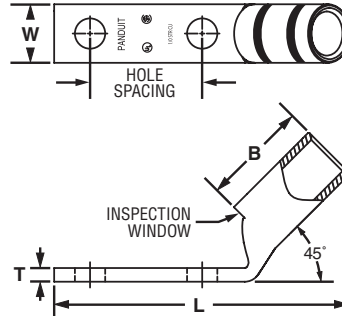

C4.
Cable
Management

| Part Number | Copper Conductor Size | Stud Hole Size (In.) | Stud Hole Spacing (In.) | Figure Dimensions (In.) | | | | PANDUIT Color Code | PANDUIT Die Index No.‡ | Burndy Die Index No.‡ | T&B Die Index No.‡ | Wire Strip Length (In.) | Std. Pkg. Qty. |
|----------------|-----------------------|----------------------|-------------------------|-------------------------|------|-----|------|--------------------|------------------------|-----------------------|--------------------|-------------------------|----------------|
| | | | | W | B | T | L | | | | | | |
| LCDN2-14AH-Q | #2 AWG | 1/4 | .63 | .42 | .88 | .11 | 2.12 | Brown | P33 | 10 | 33 | 15/16 | 25 |
| LCDN2-14DH-Q | #2 AWG | 1/4 | 1.00 | .42 | .88 | .11 | 2.49 | Brown | P33 | 10 | 33 | 15/16 | 25 |
| LCDN1/0-14DH-X | 1/0 AWG | 1/4 | 1.00 | .52 | .94 | .13 | 2.63 | Pink | P42 | 12 | 42 | 1 | 10 |
| LCDN1/0-56DH-X | 1/0 AWG | 5/16 | 1.00 | .52 | .94 | .13 | 2.70 | Pink | P42 | 12 | 42 | 1 | 10 |
| LCDN750-38DH-6 | 750 kcmil | 3/8 | 1.00 | 1.30 | 1.88 | .26 | 4.25 | Black | P106 | 24 | 106 | 1 15/16 | 6 |
| LCDN750-12DH-6 | 750 kcmil | 1/2 | 1.00 | 1.30 | 1.88 | .26 | 4.43 | Black | P106 | 24 | 106 | 1 15/16 | 6 |

‡See pages D3.54 – D3.57 for tool and die information.

**Consult cable manufacturer for voltage stress relief instructions with applications greater than 2000 V.

D1.
Terminals

D2.
Power
Connectors

D3.
Grounding
Connectors

E1.
Labeling
Systems

E2.
Labels

E3.
Pre-Printed
& Write-On
Markers

E4.
Permanent
Identification

E5.
Lockout/
Tagout
& Safety
Solutions

F.
Index



Code Conductor, Two-Hole, Standard Barrel with Window, Narrow Tongue Lug, 90°

For Use with Stranded Copper Conductors

Type LCDN-F

- Narrow tongue width for limited space applications
- Color-coded barrels marked with *PANDUIT* and specified competitor die index numbers for proper crimp die selection
- Inspection window to visually assure full conductor insertion
- Tin-plated to inhibit corrosion

- UL Listed and CSA Certified to 35 KV** and temperature rated to 90°C when crimped with *PANDUIT* and specified competitor crimping tools and dies
- UL Listed and CSA Certified for wide wire range-taking capability when crimped with *PANDUIT*® *UNI-DIE*™ Dieless Crimping Tools‡

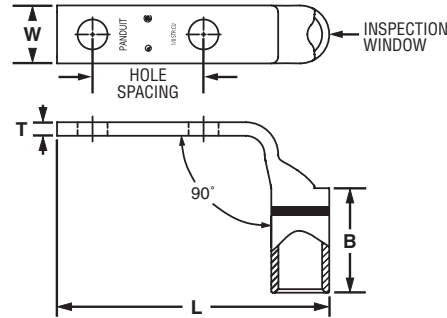

| Part Number | Copper Conductor Size | Stud Hole Size (In.) | Stud Hole Spacing (In.) | Figure Dimensions (In.) | | | | PANDUIT Color Code | PANDUIT Die Index No.‡ | Burndy Die Index No.‡ | T&B Die Index No.‡ | Wire Strip Length (In.) | Std. Pkg. Qty. |
|----------------|-----------------------|----------------------|-------------------------|-------------------------|------|-----|------|--------------------|------------------------|-----------------------|--------------------|-------------------------|----------------|
| | | | | W | B | T | L | | | | | | |
| LCDN2-14AF-Q | #2 AWG | 1/4 | .63 | .42 | .88 | .11 | 1.86 | Brown | P33 | 10 | 33 | 15/16 | 25 |
| LCDN2-14DF-Q | #2 AWG | 1/4 | 1.00 | .42 | .88 | .11 | 2.24 | Brown | P33 | 10 | 33 | 15/16 | 25 |
| LCDN1/0-14DF-X | 1/0 AWG | 1/4 | 1.00 | .52 | .94 | .13 | 2.45 | Pink | P42 | 12 | 42 | 1 | 10 |
| LCDN1/0-56DF-X | 1/0 AWG | 5/16 | 1.00 | .52 | .94 | .13 | 2.51 | Pink | P42 | 12 | 42 | 1 | 10 |
| LCDN750-38DF-6 | 750 kcmil | 3/8 | 1.00 | 1.30 | 1.88 | .26 | 3.56 | Black | P106 | 24 | 106 | 1 15/16 | 6 |
| LCDN750-12DF-6 | 750 kcmil | 1/2 | 1.00 | 1.30 | 1.88 | .26 | 3.75 | Black | P106 | 24 | 106 | 1 15/16 | 6 |

‡See pages D3.54 – D3.57 for tool and die information.

**Consult cable manufacturer for voltage stress relief instructions with applications greater than 2000 V.

A. System Overview

B1. Cable Ties

B2. Cable Accessories

B3. Stainless Steel Ties

C1. Wiring Duct

C2. Surface Raceway

C3. Abrasion Protection

C4. Cable Management

D1. Terminals

D2. Power Connectors

D3. Grounding Connectors

E1. Labeling Systems

E2. Labels

E3. Pre-Printed & Write-On Markers

E4. Permanent Identification

E5. Lockout/Tagout & Safety Solutions

F. Index

A.
System
Overview



Code Conductor, Long Blank Tongue, Standard Barrel with Window Lug

B1.
Cable Ties

For Use with Stranded Copper Conductors

Type LCD-00

- Color-coded barrels marked with *PANDUIT* and specified competitor die index numbers for proper crimp die selection
- Inspection window to visually assure full conductor insertion

- Tin-plated to inhibit corrosion
- UL Recognized and CSA Certified to 35 KV** and temperature rated to 90°C when crimped with *PANDUIT* and specified competitor crimping tools and dies

B2.
Cable
Accessories

B3.
Stainless
Steel Ties

C1.
Wiring
Duct

C2.
Surface
Raceway

C3.
Abrasion
Protection

C4.
Cable
Management

D1.
Terminals

D2.
Power
Connectors

D3.
Grounding
Connectors

E1.
Labeling
Systems

E2.
Labels

E3.
Pre-Printed
& Write-On
Markers

E4.
Permanent
Identification

E5.
Lockout/
Tagout/
& Safety
Solutions

F.
Index

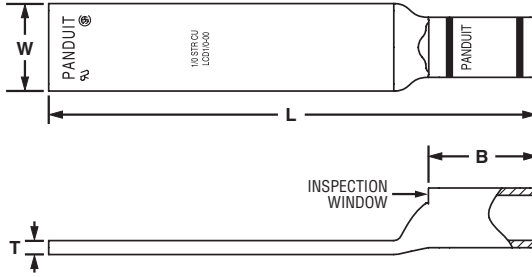

| Part Number | Copper Conductor Size | Figure Dimensions (In.) | | | | PANDUIT Color Code | PANDUIT Die Index No.‡ | Burdny Die Index No.‡ | T&B Die Index No.‡ | Wire Strip Length (In.) | Std. Pkg. Qty. |
|--------------|-----------------------|-------------------------|------|-----|------|--------------------|------------------------|-----------------------|--------------------|-------------------------|----------------|
| | | W | B | T | L | | | | | | |
| LCD1/0-00-X | 1/0 AWG | .76 | .94 | .12 | 4.25 | Pink | P42 | 12 | 42 | 1 | 10 |
| LCD2/0-00-X | 2/0 AWG | .85 | .98 | .13 | 4.30 | Black | P45 | 13 | 45 | 1 1/16 | 10 |
| LCD3/0-00-X | 3/0 AWG | .96 | 1.14 | .13 | 4.50 | Orange | P50 | 14 | 50 | 1 3/16 | 10 |
| LCD4/0-00-X | 4/0 AWG | 1.06 | 1.19 | .14 | 4.58 | Purple | P54 | 15 | 54 | 1 1/4 | 10 |
| LCD250-00-X | 250 kcmil | 1.17 | 1.25 | .14 | 4.69 | Yellow | P62 | 16 | 62 | 1 5/16 | 10 |
| LCD300-00-X | 300 kcmil | 1.19 | 1.44 | .16 | 4.93 | White | P66 | 17 | 66 | 1 1/2 | 10 |
| LCD350-00-X | 350 kcmil | 1.28 | 1.44 | .17 | 4.97 | Red | P71 | 18 | 71 | 1 1/2 | 10 |
| LCD400-00-6 | 400 kcmil | 1.39 | 1.50 | .18 | 5.05 | Blue | P76 | 19 | 76 | 1 9/16 | 6 |
| LCD500-00-6 | 500 kcmil | 1.54 | 1.75 | .22 | 5.38 | Brown | P87 | 20 | 87 | 1 13/16 | 6 |
| LCD600-00-6 | 600 kcmil | 1.70 | 1.75 | .26 | 5.43 | Green | P94 | 22 | 94 | 1 13/16 | 6 |
| LCD750-00-6 | 750 kcmil | 1.89 | 1.88 | .26 | 5.65 | Black | P106 | 24 | 106 | 1 15/16 | 6 |
| LCD1000-00-3 | 1000 kcmil | 2.17 | 1.88 | .32 | 5.77 | White | P125 | 27 | 125 | 1 15/16 | 3 |

‡See pages D3.54 – D3.57 for tool and die information.

**Consult cable manufacturer for voltage stress relief instructions with applications greater than 2000 V.

UL LISTED **CSA CERTIFIED** **Code Conductor, Two-Hole, Long Barrel Lug**

For Use with Stranded Copper Conductors

Type LCC

- Long barrel maximizes number of crimps and provides premium wire pull-out strength and electrical performance
- Color-coded barrels marked with *PANDUIT* and specified competitor die index numbers for proper crimp die selection
- Enclosed barrel prevents corrosive material from entering barrel when used in harsh environments
- Tin-plated to inhibit corrosion
- UL Listed and CSA Certified to 35 KV** and temperature rated to 90°C when crimped with *PANDUIT* and specified competitor crimping tools and dies
- UL Listed and CSA Certified for wide wire range-taking capability when crimped with *PANDUIT*® *UNI-DIE*™ Dieless Crimping Tools‡
- **Tested by Telcordia – meets NEBS Level 3**
- American Bureau of Shipping approved
- Available with NEMA hole sizes and spacing

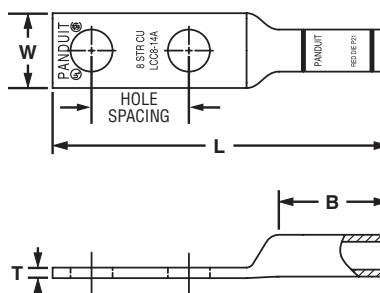

| Part Number | Copper Conductor Size | Stud Hole Size (In.) | Stud Hole Spacing (In.) | Figure Dimensions (In.) | | | | PANDUIT Color Code | PANDUIT Die Index No.‡ | Burdny Die Index No.‡ | T&B Die Index No.‡ | Wire Strip Length (In.) | Std. Pkg. Qty. |
|-------------|----------------------------|----------------------|-------------------------|-------------------------|------|------|------|--------------------|------------------------|-----------------------|--------------------|-------------------------|----------------|
| | | | | W | B | T | L | | | | | | |
| LCC8-10A-L | #8 AWG | #10 | .63 | .41 | .70 | .08 | 2.07 | Red | P21 | 49 | 21 | 3/4 | 50 |
| LCC8-14A-L | | 1/4 | .63 | .48 | .70 | .07 | 2.16 | Red | P21 | 49 | 21 | 3/4 | 50 |
| LCC8-14B-L | | 1/4 | .75 | .48 | .70 | .07 | 2.28 | Red | P21 | 49 | 21 | 3/4 | 50 |
| LCC8-14D-L | | 1/4 | 1.00 | .48 | .70 | .07 | 2.53 | Red | P21 | 49 | 21 | 3/4 | 50 |
| LCC8-38D-L | | 3/8 | 1.00 | .60 | .70 | .05 | 2.75 | Red | P21 | 49 | 21 | 3/4 | 50 |
| LCC6-10A-L | | #6 AWG | #10 | .63 | .46 | 1.07 | .08 | 2.47 | Blue | P24 | 7 | 24 | 1 1/8 |
| LCC6-14A-L | 1/4 | | .63 | .48 | 1.07 | .08 | 2.56 | Blue | P24 | 7 | 24 | 1 1/8 | 50 |
| LCC6-14B-L | 1/4 | | .75 | .48 | 1.07 | .08 | 2.68 | Blue | P24 | 7 | 24 | 1 1/8 | 50 |
| LCC6-14D-L | 1/4 | | 1.00 | .48 | 1.07 | .08 | 2.93 | Blue | P24 | 7 | 24 | 1 1/8 | 50 |
| LCC6-38D-L | 3/8 | | 1.00 | .62 | 1.07 | .06 | 3.15 | Blue | P24 | 7 | 24 | 1 1/8 | 50 |
| LCC6-12-L | 1/2 | | 1.75 | .81 | 1.13 | .16 | 4.48 | Blue | P24 | 7 | 24 | 1 3/16 | 50 |
| LCC4-14A-L | #4 – 3 AWG STR, #2 AWG SOL | 1/4 | .63 | .55 | 1.05 | .09 | 2.58 | Gray | P29 | 8 | 29 | 1 1/8 | 50 |
| LCC4-14B-L | | 1/4 | .75 | .55 | 1.05 | .09 | 2.70 | Gray | P29 | 8 | 29 | 1 1/8 | 50 |
| LCC4-38D-L | | 3/8 | 1.00 | .62 | 1.05 | .08 | 3.17 | Gray | P29 | 8 | 29 | 1 1/8 | 50 |
| LCC4-12-L | | 1/2 | 1.75 | .84 | 1.13 | .16 | 4.50 | Gray | P29 | 8 | 29 | 1 1/16 | 50 |
| LCC2-14A-Q | #2 AWG | 1/4 | .63 | .60 | 1.16 | .10 | 2.77 | Brown | P33 | 10 | 33 | 1 1/4 | 25 |
| LCC2-14B-Q | | 1/4 | .75 | .60 | 1.16 | .10 | 2.89 | Brown | P33 | 10 | 33 | 1 1/4 | 25 |
| LCC2-56B-Q | | 5/16 | .75 | .66 | 1.16 | .10 | 3.02 | Brown | P33 | 10 | 33 | 1 1/4 | 25 |
| LCC2-56C-Q | | 5/16 | .88 | .66 | 1.16 | .10 | 3.14 | Brown | P33 | 10 | 33 | 1 1/4 | 25 |
| LCC2-38D-Q | | 3/8 | 1.00 | .66 | 1.16 | .10 | 3.34 | Brown | P33 | 10 | 33 | 1 1/4 | 25 |
| LCC2-38-Q | | 3/8 | 1.75 | .66 | 1.16 | .10 | 4.09 | Brown | P33 | 10 | 33 | 1 1/4 | 25 |
| LCC2-12-Q | | 1/2 | 1.75 | .75 | 1.16 | .08 | 4.51 | Brown | P33 | 10 | 33 | 1 1/4 | 25 |
| LCC1-14A-E | | #1 AWG | 1/4 | .63 | .70 | 1.36 | .11 | 3.00 | Green | P37 | 11 | 37 | 1 7/16 |
| LCC1-14B-E | 1/4 | | .75 | .70 | 1.36 | .11 | 3.12 | Green | P37 | 11 | 37 | 1 7/16 | 20 |
| LCC1-56B-E | 5/16 | | .75 | .70 | 1.36 | .11 | 3.25 | Green | P37 | 11 | 37 | 1 7/16 | 20 |
| LCC1-56C-E | 5/16 | | .88 | .70 | 1.36 | .11 | 3.37 | Green | P37 | 11 | 37 | 1 7/16 | 20 |
| LCC1-38D-E | 3/8 | | 1.00 | .70 | 1.36 | .11 | 3.57 | Green | P37 | 11 | 37 | 1 7/16 | 20 |
| LCC1-12-E | 1/2 | | 1.75 | .75 | 1.36 | .09 | 4.74 | Green | P37 | 11 | 37 | 1 7/16 | 20 |

‡See pages D3.58 – D3.61 for tool and die information.

**Consult cable manufacturer for voltage stress relief instructions with applications greater than 2000 V.

Table continues on page D2.42

A. System Overview

B1. Cable Ties

B2. Cable Accessories

B3. Stainless Steel Ties

C1. Wiring Duct

C2. Surface Raceway

C3. Abrasion Protection

C4. Cable Management

D1. Terminals

D2. Power Connectors

D3. Grounding Connectors

E1. Labeling Systems

E2. Labels

E3. Pre-Printed & Write-On Markers

E4. Permanent Identification

E5. Lockout/Tagout & Safety Solutions

F. Index

A. System Overview



Code Conductor, Two-Hole, Long Barrel Lug (continued)

B1. Cable Ties

B2. Cable Accessories

B3. Stainless Steel Ties

C1. Wiring Duct

C2. Surface Raceway

C3. Abrasion Protection

C4. Cable Management

D1. Terminals

D2. Power Connectors

D3. Grounding Connectors

E1. Labeling Systems

E2. Labels

E3. Pre-Printed & Write-On Markers

E4. Permanent Identification

E5. Lockout/Tagout & Safety Solutions

F. Index

| Part Number | Copper Conductor Size | Stud Hole Size (In.) | Stud Hole Spacing (In.) | Figure Dimensions (In.) | | | | PANDUIT Color Code | PANDUIT Die Index No.‡ | Burndy Die Index No.‡ | T&B Die Index No.‡ | Wire Strip Length (In.) | Std. Pkg. Qty. | |
|---------------------|-----------------------|----------------------|-------------------------|-------------------------|------|------|------|--------------------|------------------------|-----------------------|--------------------|-------------------------|----------------|----|
| | | | | W | B | T | L | | | | | | | |
| LCC1/0-14A-X | 1/0 AWG | 1/4 | .63 | .76 | 1.44 | .12 | 3.18 | Pink | P42 | 12 | 42 | 1 1/2 | 10 | |
| LCC1/0-14B-X | | 1/4 | .75 | .76 | 1.44 | .12 | 3.31 | Pink | P42 | 12 | 42 | 1 1/2 | 10 | |
| LCC1/0-56C-X | | 5/16 | .88 | .76 | 1.44 | .12 | 3.49 | Pink | P42 | 12 | 42 | 1 1/2 | 10 | |
| LCC1/0-56D-X | | 5/16 | 1.00 | .76 | 1.44 | .12 | 3.61 | Pink | P42 | 12 | 42 | 1 1/2 | 10 | |
| LCC1/0-38D-X | | 3/8 | 1.00 | .76 | 1.44 | .12 | 3.69 | Pink | P42 | 12 | 42 | 1 1/2 | 10 | |
| LCC1/0-12D-X | | 1/2 | 1.00 | .80 | 1.44 | .12 | 3.95 | Pink | P42 | 12 | 42 | 1 1/2 | 10 | |
| LCC1/0-12-X | | 1/2 | 1.75 | .80 | 1.44 | .12 | 4.86 | Pink | P42 | 12 | 42 | 1 1/2 | 10 | |
| LCC2/0-14A-X | | 2/0 AWG | 1/4 | .63 | .85 | 1.50 | .13 | 3.38 | Black | P45 | 13 | 45 | 1 9/16 | 10 |
| LCC2/0-14B-X | | | 1/4 | .75 | .85 | 1.50 | .13 | 3.51 | Black | P45 | 13 | 45 | 1 9/16 | 10 |
| LCC2/0-56D-X | | | 5/16 | 1.00 | .85 | 1.50 | .13 | 3.76 | Black | P45 | 13 | 45 | 1 9/16 | 10 |
| LCC2/0-38D-X | 3/8 | | 1.00 | .85 | 1.50 | .13 | 3.82 | Black | P45 | 13 | 45 | 1 9/16 | 10 | |
| LCC2/0-12D-X | 1/2 | | 1.00 | .85 | 1.50 | .13 | 4.07 | Black | P45 | 13 | 45 | 1 9/16 | 10 | |
| LCC2/0-12-X | 1/2 | | 1.75 | .85 | 1.50 | .13 | 4.98 | Black | P45 | 13 | 45 | 1 9/16 | 10 | |
| LCC3/0-14B-X | 3/0 AWG | | 1/4 | .75 | .96 | 1.50 | .13 | 3.56 | Orange | P50 | 14 | 50 | 1 9/16 | 10 |
| LCC3/0-38D-X | | | 3/8 | 1.00 | .96 | 1.50 | .13 | 3.87 | Orange | P50 | 14 | 50 | 1 9/16 | 10 |
| LCC3/0-12D-X | | | 1/2 | 1.00 | .96 | 1.50 | .13 | 4.12 | Orange | P50 | 14 | 50 | 1 9/16 | 10 |
| LCC3/0-12-X | | | 1/2 | 1.75 | .96 | 1.50 | .13 | 5.03 | Orange | P50 | 14 | 50 | 1 9/16 | 10 |
| LCC4/0-14B-X | | 4/0 AWG | 1/4 | .75 | 1.06 | 1.56 | .14 | 3.66 | Purple | P54 | 15 | 54 | 1 5/8 | 10 |
| LCC4/0-56D-X | 5/16 | | 1.00 | 1.06 | 1.56 | .14 | 3.92 | Purple | P54 | 15 | 54 | 1 5/8 | 10 | |
| LCC4/0-38D-X | 3/8 | | 1.00 | 1.06 | 1.56 | .14 | 3.99 | Purple | P54 | 15 | 54 | 1 5/8 | 10 | |
| LCC4/0-38-X | 3/8 | | 1.75 | 1.06 | 1.56 | .14 | 4.74 | Purple | P54 | 15 | 54 | 1 5/8 | 10 | |
| LCC4/0-12D-X | 1/2 | | 1.00 | 1.06 | 1.56 | .14 | 4.22 | Purple | P54 | 15 | 54 | 1 5/8 | 10 | |
| ◆ LCC4/0-12-X | 1/2 | | 1.75 | 1.06 | 1.56 | .14 | 5.13 | Purple | P54 | 15 | 54 | 1 5/8 | 10 | |
| LCC250-38D-X | 250 kcmil | | 3/8 | 1.00 | 1.17 | 1.60 | .14 | 4.09 | Yellow | P62 | 16 | 62 | 1 11/16 | 10 |
| LCC250-12D-X | | 1/2 | 1.00 | 1.17 | 1.60 | .14 | 4.32 | Yellow | P62 | 16 | 62 | 1 11/16 | 10 | |
| ◆ LCC250-12-X | | 1/2 | 1.75 | 1.17 | 1.60 | .14 | 5.23 | Yellow | P62 | 16 | 62 | 1 11/16 | 10 | |
| LCC300-38D-X | 300 kcmil | 3/8 | 1.00 | 1.19 | 2.24 | .16 | 4.76 | White | P66 | 17 | 66 | 2 5/16 | 10 | |
| ◆ LCC300-12-X | | 1/2 | 1.75 | 1.19 | 2.24 | .16 | 5.94 | White | P66 | 17 | 66 | 2 5/16 | 10 | |
| LCC350-14B-X | 350 kcmil | 1/4 | .75 | 1.28 | 2.24 | .17 | 4.33 | Red | P71 | 18 | 71 | 2 5/16 | 10 | |
| LCC350-38D-X | | 3/8 | 1.00 | 1.28 | 2.24 | .17 | 4.81 | Red | P71 | 18 | 71 | 2 5/16 | 10 | |
| ◆ LCC350-12-X | | 1/2 | 1.75 | 1.28 | 2.24 | .17 | 5.99 | Red | P71 | 18 | 71 | 2 5/16 | 10 | |
| LCC400-14B-6 | 400 kcmil | 1/4 | .75 | 1.39 | 2.30 | .18 | 4.44 | Blue | P76 | 19 | 76 | 2 3/8 | 6 | |
| LCC400-38D-6 | | 3/8 | 1.00 | 1.39 | 2.30 | .18 | 4.92 | Blue | P76 | 19 | 76 | 2 3/8 | 6 | |
| ◆ LCC400-12-6 | | 1/2 | 1.75 | 1.39 | 2.30 | .18 | 6.10 | Blue | P76 | 19 | 76 | 2 3/8 | 6 | |
| LCC500-14B-6 | 500 kcmil | 1/4 | .75 | 1.54 | 2.50 | .22 | 4.70 | Brown | P87 | 20 | 87 | 2 9/16 | 6 | |
| LCC500-38D-6 | | 3/8 | 1.00 | 1.54 | 2.50 | .22 | 5.18 | Brown | P87 | 20 | 87 | 2 9/16 | 6 | |
| ◆ LCC500-12-6 | | 1/2 | 1.75 | 1.54 | 2.50 | .22 | 6.36 | Brown | P87 | 20 | 87 | 2 9/16 | 6 | |
| LCC600-38D-6 | 600 kcmil | 3/8 | 1.00 | 1.70 | 2.69 | .26 | 5.45 | Green | P94 | 22 | 94 | 2 3/4 | 6 | |
| ◆ LCC600-12-6 | | 1/2 | 1.75 | 1.70 | 2.69 | .26 | 6.63 | Green | P94 | 22 | 94 | 2 3/4 | 6 | |
| LCC750-38D-6 | 750 kcmil | 3/8 | 1.00 | 1.89 | 2.87 | .26 | 6.10 | Black | P106 | 24 | 106 | 2 15/16 | 6 | |
| ◆ LCC750-12-6 | | 1/2 | 1.75 | 1.89 | 2.87 | .26 | 7.04 | Black | P106 | 24 | 106 | 2 15/16 | 6 | |
| ◆ LCC800-12-6 | 800 kcmil | 1/2 | 1.75 | 1.95 | 2.94 | .29 | 7.13 | Orange | P107 | 25 | — | 3 | 6 | |
| LCC1000-38D-3 | 1000 kcmil | 3/8 | 1.00 | 2.17 | 3.00 | .32 | 6.35 | White | P125 | 27 | 125 | 3 1/16 | 3 | |
| ◆ LCC1000-12-3 | | 1/2 | 1.75 | 2.17 | 3.00 | .32 | 7.29 | White | P125 | 27 | 125 | 3 1/16 | 3 | |

‡See pages D3.58 – D3.61 for tool and die information.

**Consult cable manufacturer for voltage stress relief instructions with applications greater than 2000 V.

◆NEMA hole sizes and spacing.



Code Conductor, Two-Hole, Long Barrel Lug, 45° Angle

For Use with Stranded Copper Conductors

Type LCC-H

- Long barrel maximizes number of crimps and provides premium wire pull-out strength and electrical performance
- Color-coded barrels marked with *PANDUIT* and specified competitor die index numbers for proper crimp die selection
- Enclosed barrel prevents corrosive material from entering barrel when used in harsh environments
- Tin-plated to inhibit corrosion
- UL Listed and CSA Certified to 35 KV** and temperature rated to 90°C when crimped with *PANDUIT* and specified competitor crimping tools and dies
- UL Listed and CSA Certified for wide wire range-taking capability when crimped with *PANDUIT*® *UNI-DIE*™ Dieless Crimping Tools‡
- **Tested by Telcordia – meets NEBS Level 3**
- American Bureau of Shipping approved
- Available with NEMA hole sizes and spacing

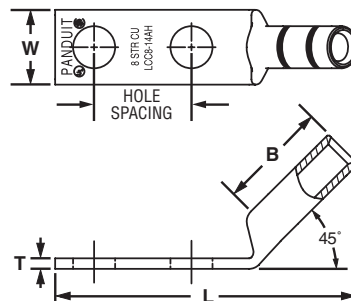

| Part Number | Copper Conductor Size | Stud Hole Size (In.) | Stud Hole Spacing (In.) | Figure Dimensions (In.) | | | | PANDUIT Color Code | PANDUIT Die Index No.‡ | Burdny Die Index No.‡ | T&B Die Index No.‡ | Wire Strip Length (In.) | Std. Pkg. Qty. |
|-------------|----------------------------|----------------------|-------------------------|-------------------------|------|-----|------|--------------------|------------------------|-----------------------|--------------------|-------------------------|----------------|
| | | | | W | B | T | L | | | | | | |
| LCC8-10AH-L | #8 AWG | #10 | .63 | .41 | .70 | .08 | 1.86 | Red | P21 | 49 | 21 | 3/4 | 50 |
| LCC8-14AH-L | | 1/4 | .63 | .48 | .70 | .07 | 1.94 | Red | P21 | 49 | 21 | 3/4 | 50 |
| LCC8-14BH-L | | 1/4 | .75 | .48 | .70 | .07 | 2.06 | Red | P21 | 49 | 21 | 3/4 | 50 |
| LCC8-14DH-L | | 1/4 | 1.00 | .48 | .70 | .07 | 2.31 | Red | P21 | 49 | 21 | 3/4 | 50 |
| LCC8-38DH-L | | 3/8 | 1.00 | .60 | .70 | .05 | 2.52 | Red | P21 | 49 | 21 | 3/4 | 50 |
| LCC6-10AH-L | #6 AWG | #10 | .63 | .46 | 1.07 | .08 | 2.14 | Blue | P24 | 7 | 24 | 1 1/8 | 50 |
| LCC6-14AH-L | | 1/4 | .63 | .48 | 1.07 | .08 | 2.23 | Blue | P24 | 7 | 24 | 1 1/8 | 50 |
| LCC6-14BH-L | | 1/4 | .75 | .48 | 1.07 | .08 | 2.35 | Blue | P24 | 7 | 24 | 1 1/8 | 50 |
| LCC6-14DH-L | | 1/4 | 1.00 | .48 | 1.07 | .08 | 2.60 | Blue | P24 | 7 | 24 | 1 1/8 | 50 |
| LCC6-38DH-L | | 3/8 | 1.00 | .62 | 1.07 | .06 | 2.81 | Blue | P24 | 7 | 24 | 1 1/8 | 50 |
| LCC4-14AH-L | #4 – 3 AWG STR, #2 AWG SOL | 1/4 | .63 | .55 | 1.05 | .09 | 2.26 | Gray | P29 | 8 | 29 | 1 1/8 | 50 |
| LCC4-14BH-L | | 1/4 | .75 | .55 | 1.05 | .09 | 2.38 | Gray | P29 | 8 | 29 | 1 1/8 | 50 |
| LCC4-38DH-L | | 3/8 | 1.00 | .62 | 1.05 | .08 | 2.84 | Gray | P29 | 8 | 29 | 1 1/8 | 50 |
| LCC2-14AH-Q | #2 AWG | 1/4 | .63 | .60 | 1.16 | .10 | 2.38 | Brown | P33 | 10 | 33 | 1 1/4 | 25 |
| LCC2-14BH-Q | | 1/4 | .75 | .60 | 1.16 | .10 | 2.50 | Brown | P33 | 10 | 33 | 1 1/4 | 25 |
| LCC2-56BH-Q | | 5/16 | .75 | .66 | 1.16 | .10 | 2.62 | Brown | P33 | 10 | 33 | 1 1/4 | 25 |
| LCC2-56CH-Q | | 5/16 | .88 | .66 | 1.16 | .10 | 2.75 | Brown | P33 | 10 | 33 | 1 1/4 | 25 |
| LCC2-38DH-Q | | 3/8 | 1.00 | .66 | 1.16 | .10 | 2.95 | Brown | P33 | 10 | 33 | 1 1/4 | 25 |
| LCC2-38H-Q | | 3/8 | 1.75 | .66 | 1.16 | .10 | 3.70 | Brown | P33 | 10 | 33 | 1 1/4 | 25 |
| LCC2-12H-Q | | 1/2 | 1.75 | .75 | 1.16 | .08 | 4.10 | Brown | P33 | 10 | 33 | 1 1/4 | 25 |

‡See pages D3.58 – D3.61 for tool and die information.

**Consult cable manufacturer for voltage stress relief instructions with applications greater than 2000 V.

◆NEMA hole sizes and spacing.

Table continues on page D2.44

- A. System Overview
- B1. Cable Ties
- B2. Cable Accessories
- B3. Stainless Steel Ties
- C1. Wiring Duct
- C2. Surface Raceway
- C3. Abrasion Protection
- C4. Cable Management
 - D1. Terminals
 - D2. Power Connectors
 - D3. Grounding Connectors
- E1. Labeling Systems
- E2. Labels
- E3. Pre-Printed & Write-On Markers
- E4. Permanent Identification
- E5. Lockout/Tagout & Safety Solutions
- F. Index

A. System Overview



Code Conductor, Two-Hole, Long Barrel Lug, 45° Angle (continued)

B1. Cable Ties

B2. Cable Accessories

B3. Stainless Steel Ties

C1. Wiring Duct

C2. Surface Raceway

C3. Abrasion Protection

C4. Cable Management

D1. Terminals

D2. Power Connectors

D3. Grounding Connectors

E1. Labeling Systems

E2. Labels

E3. Pre-Printed & Write-On Markers

E4. Permanent Identification

E5. Lockout/Tagout & Safety Solutions

F. Index

| Part Number | Copper Conductor Size | Stud Hole Size (In.) | Stud Hole Spacing (In.) | Figure Dimensions (In.) | | | | PANDUIT Color Code | PANDUIT Die Index No.‡ | Burdny Die Index No.‡ | T&B Die Index No.‡ | Wire Strip Length (In.) | Std. Pkg. Qty. |
|---------------|-----------------------|----------------------|-------------------------|-------------------------|------|------|------|--------------------|------------------------|-----------------------|--------------------|-------------------------|----------------|
| | | | | W | B | T | L | | | | | | |
| LCC1-14AH-E | #1 AWG | 1/4 | .63 | .70 | 1.36 | .11 | 2.53 | Green | P37 | 11 | 37 | 1 7/16 | 20 |
| LCC1-14BH-E | | 1/4 | .75 | .70 | 1.36 | .11 | 2.66 | Green | P37 | 11 | 37 | 1 7/16 | 20 |
| LCC1-56BH-E | | 5/16 | .75 | .70 | 1.36 | .11 | 2.78 | Green | P37 | 11 | 37 | 1 7/16 | 20 |
| LCC1-56CH-E | | 5/16 | .88 | .70 | 1.36 | .11 | 2.91 | Green | P37 | 11 | 37 | 1 7/16 | 20 |
| LCC1-38DH-E | | 3/8 | 1.00 | .70 | 1.36 | .11 | 3.11 | Green | P37 | 11 | 37 | 1 7/16 | 20 |
| LCC1-12H-E | | 1/2 | 1.75 | .75 | 1.36 | .09 | 4.27 | Green | P37 | 11 | 37 | 1 7/16 | 20 |
| LCC1/0-14AH-X | 1/0 AWG | 1/4 | .63 | .76 | 1.44 | .12 | 2.69 | Pink | P42 | 12 | 42 | 1 1/2 | 10 |
| LCC1/0-14BH-X | | 1/4 | .75 | .76 | 1.44 | .12 | 2.81 | Pink | P42 | 12 | 42 | 1 1/2 | 10 |
| LCC1/0-56CH-X | | 5/16 | .88 | .76 | 1.44 | .12 | 2.99 | Pink | P42 | 12 | 42 | 1 1/2 | 10 |
| LCC1/0-56DH-X | | 5/16 | 1.00 | .76 | 1.44 | .12 | 3.12 | Pink | P42 | 12 | 42 | 1 1/2 | 10 |
| LCC1/0-38DH-X | | 3/8 | 1.00 | .76 | 1.44 | .12 | 3.19 | Pink | P42 | 12 | 42 | 1 1/2 | 10 |
| LCC1/0-12DH-X | | 1/2 | 1.00 | .80 | 1.44 | .12 | 3.46 | Pink | P42 | 12 | 42 | 1 1/2 | 10 |
| LCC1/0-12H-X | 1/2 | 1.75 | .80 | 1.44 | .12 | 4.36 | Pink | P42 | 12 | 42 | 1 1/2 | 10 | |
| LCC2/0-14AH-X | 2/0 AWG | 1/4 | .63 | .85 | 1.50 | .13 | 2.87 | Black | P45 | 13 | 45 | 1 9/16 | 10 |
| LCC2/0-14BH-X | | 1/4 | .75 | .85 | 1.50 | .13 | 2.99 | Black | P45 | 13 | 45 | 1 9/16 | 10 |
| LCC2/0-56DH-X | | 5/16 | 1.00 | .85 | 1.50 | .13 | 3.24 | Black | P45 | 13 | 45 | 1 9/16 | 10 |
| LCC2/0-38DH-X | | 3/8 | 1.00 | .85 | 1.50 | .13 | 3.31 | Black | P45 | 13 | 45 | 1 9/16 | 10 |
| LCC2/0-12DH-X | | 1/2 | 1.00 | .85 | 1.50 | .13 | 3.56 | Black | P45 | 13 | 45 | 1 9/16 | 10 |
| LCC2/0-12H-X | | 1/2 | 1.75 | .85 | 1.50 | .13 | 4.47 | Black | P45 | 13 | 45 | 1 9/16 | 10 |
| LCC3/0-14BH-X | 3/0 AWG | 1/4 | .75 | .96 | 1.50 | .13 | 3.02 | Orange | P50 | 14 | 50 | 1 9/16 | 10 |
| LCC3/0-38DH-X | | 3/8 | 1.00 | .96 | 1.50 | .13 | 3.33 | Orange | P50 | 14 | 50 | 1 9/16 | 10 |
| LCC3/0-12DH-X | | 1/2 | 1.00 | .96 | 1.50 | .13 | 3.58 | Orange | P50 | 14 | 50 | 1 9/16 | 10 |
| LCC3/0-12H-X | | 1/2 | 1.75 | .96 | 1.50 | .13 | 4.50 | Orange | P50 | 14 | 50 | 1 9/16 | 10 |
| LCC4/0-14BH-X | 4/0 AWG | 1/4 | .75 | 1.06 | 1.56 | .14 | 3.11 | Purple | P54 | 15 | 54 | 1 5/8 | 10 |
| LCC4/0-56DH-X | | 5/16 | 1.00 | 1.06 | 1.56 | .14 | 3.37 | Purple | P54 | 15 | 54 | 1 5/8 | 10 |
| LCC4/0-38DH-X | | 3/8 | 1.00 | 1.06 | 1.56 | .14 | 3.44 | Purple | P54 | 15 | 54 | 1 5/8 | 10 |
| LCC4/0-38H-X | | 3/8 | 1.75 | 1.06 | 1.56 | .14 | 4.19 | Purple | P54 | 15 | 54 | 1 5/8 | 10 |
| LCC4/0-12DH-X | | 1/2 | 1.00 | 1.06 | 1.56 | .14 | 3.67 | Purple | P54 | 15 | 54 | 1 5/8 | 10 |
| LCC4/0-12H-X | | 1/2 | 1.75 | 1.06 | 1.56 | .14 | 4.58 | Purple | P54 | 15 | 54 | 1 5/8 | 10 |
| LCC250-38DH-X | 250 kcmil | 3/8 | 1.00 | 1.17 | 1.61 | .14 | 3.51 | Yellow | P62 | 16 | 62 | 1 11/16 | 10 |
| LCC250-12DH-X | | 1/2 | 1.00 | 1.17 | 1.61 | .14 | 3.74 | Yellow | P62 | 16 | 62 | 1 11/16 | 10 |
| LCC250-12H-X | | 1/2 | 1.75 | 1.17 | 1.61 | .14 | 4.65 | Yellow | P62 | 16 | 62 | 1 11/16 | 10 |
| LCC300-38DH-X | 300 kcmil | 3/8 | 1.00 | 1.19 | 2.24 | .16 | 4.05 | White | P66 | 17 | 66 | 2 5/16 | 10 |
| LCC300-12H-X | | 1/2 | 1.75 | 1.19 | 2.24 | .16 | 5.23 | White | P66 | 17 | 66 | 2 5/16 | 10 |
| LCC350-14BH-X | 350 kcmil | 1/4 | .75 | 1.28 | 2.24 | .17 | 3.61 | Red | P71 | 18 | 71 | 2 5/16 | 10 |
| LCC350-38DH-X | | 3/8 | 1.00 | 1.28 | 2.24 | .17 | 4.09 | Red | P71 | 18 | 71 | 2 5/16 | 10 |
| LCC350-12H-X | | 1/2 | 1.75 | 1.28 | 2.24 | .17 | 5.27 | Red | P71 | 18 | 71 | 2 5/16 | 10 |
| LCC400-14BH-6 | 400 kcmil | 1/4 | .75 | 1.39 | 2.30 | .18 | 3.70 | Blue | P76 | 19 | 76 | 2 3/8 | 6 |
| LCC400-38DH-6 | | 3/8 | 1.00 | 1.39 | 2.30 | .18 | 4.18 | Blue | P76 | 19 | 76 | 2 3/8 | 6 |
| LCC400-12H-6 | | 1/2 | 1.75 | 1.39 | 2.30 | .18 | 5.36 | Blue | P76 | 19 | 76 | 2 3/8 | 6 |
| LCC500-14BH-6 | 500 kcmil | 1/4 | .75 | 1.54 | 2.50 | .22 | 3.91 | Brown | P87 | 20 | 87 | 2 9/16 | 6 |
| LCC500-38DH-6 | | 3/8 | 1.00 | 1.54 | 2.50 | .22 | 4.39 | Brown | P87 | 20 | 87 | 2 9/16 | 6 |
| LCC500-12H-6 | | 1/2 | 1.75 | 1.54 | 2.50 | .22 | 5.57 | Brown | P87 | 20 | 87 | 2 9/16 | 6 |
| LCC600-38DH-6 | 600 kcmil | 3/8 | 1.00 | 1.70 | 2.69 | .26 | 4.61 | Green | P94 | 22 | 94 | 2 3/4 | 6 |
| LCC600-12H-6 | | 1/2 | 1.75 | 1.70 | 2.69 | .26 | 5.79 | Green | P94 | 22 | 94 | 2 3/4 | 6 |

‡See pages D3.58 – D3.61 for tool and die information.

**Consult cable manufacturer for voltage stress relief instructions with applications greater than 2000 V.

◆NEMA hole sizes and spacing.

UL LISTED CERTIFIED Code Conductor, Two-Hole, Long Barrel Lug, 90° Angle

For Use with Stranded Copper Conductors

Type LCC-F

- Long barrel maximizes number of crimps and provides premium wire pull-out strength and electrical performance
- Color-coded barrels marked with *PANDUIT* and specified competitor die index numbers for proper crimp die selection
- Enclosed barrel prevents corrosive material from entering barrel when used in harsh environments
- Tin-plated to inhibit corrosion
- UL Listed and CSA Certified to 35 KV** and temperature rated to 90°C when crimped with *PANDUIT* and specified competitor crimping tools and dies
- UL Listed and CSA Certified for wide wire range-taking capability when crimped with *PANDUIT*® *UNI-DIE*™ Dieless Crimping Tools‡
- **Tested by Telcordia – meets NEBS Level 3**
- American Bureau of Shipping approved
- Available with NEMA hole sizes and spacing

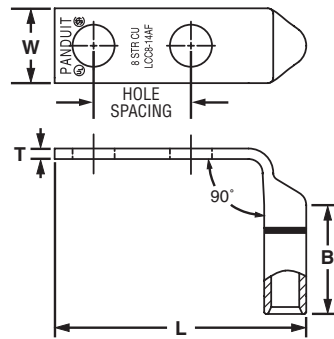

| Part Number | Copper Conductor Size | Stud Hole Size (In.) | Stud Hole Spacing (In.) | Figure Dimensions (In.) | | | | PANDUIT Color Code | PANDUIT Die Index No.‡ | Burdny Die Index No.‡ | T and B Die Index No.‡ | Wire Strip Length (In.) | Std. Pkg. Qty. |
|-------------|----------------------------|----------------------|-------------------------|-------------------------|------|-----|------|--------------------|------------------------|-----------------------|------------------------|-------------------------|----------------|
| | | | | W | B | T | L | | | | | | |
| LCC8-10AF-L | #8 AWG | #10 | .63 | .41 | .70 | .08 | 1.53 | Red | P21 | 49 | 21 | 3/4 | 50 |
| LCC8-14AF-L | | 1/4 | .63 | .48 | .70 | .07 | 1.62 | Red | P21 | 49 | 21 | 3/4 | 50 |
| LCC8-14BF-L | | 1/4 | .75 | .48 | .70 | .07 | 1.74 | Red | P21 | 49 | 21 | 3/4 | 50 |
| LCC8-14DF-L | | 1/4 | 1.00 | .48 | .70 | .07 | 1.99 | Red | P21 | 49 | 21 | 3/4 | 50 |
| LCC8-38DF-L | | 3/8 | 1.00 | .60 | .70 | .05 | 2.21 | Red | P21 | 49 | 21 | 3/4 | 50 |
| LCC6-10AF-L | #6 AWG | #10 | .63 | .46 | 1.07 | .08 | 1.57 | Blue | P24 | 7 | 24 | 1 1/8 | 50 |
| LCC6-14AF-L | | 1/4 | .63 | .48 | 1.07 | .08 | 1.66 | Blue | P24 | 7 | 24 | 1 1/8 | 50 |
| LCC6-14BF-L | | 1/4 | .75 | .48 | 1.07 | .08 | 1.78 | Blue | P24 | 7 | 24 | 1 1/8 | 50 |
| LCC6-14DF-L | | 1/4 | 1.00 | .48 | 1.07 | .08 | 2.03 | Blue | P24 | 7 | 24 | 1 1/8 | 50 |
| LCC6-38DF-L | | 3/8 | 1.00 | .62 | 1.07 | .05 | 2.25 | Blue | P24 | 7 | 24 | 1 1/8 | 50 |
| LCC4-14AF-L | #4 – 3 AWG STR, #2 AWG SOL | 1/4 | .63 | .55 | 1.05 | .09 | 1.74 | Gray | P29 | 8 | 29 | 1 1/8 | 50 |
| LCC4-14BF-L | | 1/4 | .75 | .55 | 1.05 | .09 | 1.87 | Gray | P29 | 8 | 29 | 1 1/8 | 50 |
| LCC4-38DF-L | | 3/8 | 1.00 | .62 | 1.05 | .08 | 2.34 | Gray | P29 | 8 | 29 | 1 1/8 | 50 |
| LCC2-14AF-Q | #2 AWG | 1/4 | .63 | .60 | 1.16 | .10 | 1.86 | Brown | P33 | 10 | 33 | 1 1/4 | 25 |
| LCC2-14BF-Q | | 1/4 | .75 | .60 | 1.16 | .10 | 1.99 | Brown | P33 | 10 | 33 | 1 1/4 | 25 |
| LCC2-56BF-Q | | 5/16 | .75 | .66 | 1.16 | .10 | 2.11 | Brown | P33 | 10 | 33 | 1 1/4 | 25 |
| LCC2-56CF-Q | | 5/16 | .88 | .66 | 1.16 | .10 | 2.24 | Brown | P33 | 10 | 33 | 1 1/4 | 25 |
| LCC2-38DF-Q | | 3/8 | 1.00 | .66 | 1.16 | .10 | 2.44 | Brown | P33 | 10 | 33 | 1 1/4 | 25 |
| LCC2-38F-Q | | 3/8 | 1.75 | .66 | 1.16 | .10 | 3.19 | Brown | P33 | 10 | 33 | 1 1/4 | 25 |
| LCC2-12F-Q | | 1/2 | 1.75 | .75 | 1.16 | .08 | 3.61 | Brown | P33 | 10 | 33 | 1 1/4 | 25 |

‡See pages D3.58 – D3.61 for tool and die information.

**Consult cable manufacturer for voltage stress relief instructions with applications greater than 2000 V.

Table continues on page D2.46

A. System Overview

B1. Cable Ties

B2. Cable Accessories

B3. Stainless Steel Ties

C1. Wiring Duct

C2. Surface Raceway

C3. Abrasion Protection

C4. Cable Management

D1. Terminals

D2. Power Connectors

D3. Grounding Connectors

E1. Labeling Systems

E2. Labels

E3. Pre-Printed & Write-On Markers

E4. Permanent Identification

E5. Lockout/Tagout & Safety Solutions

F. Index

A.
System
Overview



Code Conductor, Two-Hole, Long Barrel Lug, 90° Angle (continued)

B1.
Cable Ties

B2.
Cable
Accessories

B3.
Stainless
Steel Ties

C1.
Wiring
Duct

C2.
Surface
Raceway

C3.
Abrasion
Protection

C4.
Cable
Management

D1.
Terminals

D2.
Power
Connectors

D3.
Grounding
Connectors

E1.
Labeling
Systems

E2.
Labels

E3.
Pre-Printed
& Write-On
Markers

E4.
Permanent
Identification

E5.
Lockout/
Tagout
& Safety
Solutions

F.
Index

| Part Number | Copper Conductor Size | Stud Hole Size (In.) | Stud Hole Spacing (In.) | Figure Dimensions (In.) | | | | PANDUIT Color Code | PANDUIT Die Index No.‡ | Burndy Die Index No.‡ | T and B Die Index No.‡ | Wire Strip Length (In.) | Std. Pkg. Qty. | |
|---------------|-----------------------|----------------------|-------------------------|-------------------------|------|------|------|--------------------|------------------------|-----------------------|------------------------|-------------------------|----------------|----|
| | | | | W | B | T | L | | | | | | | |
| LCC1-14AF-E | #1 AWG | 1/4 | .63 | .70 | 1.36 | .11 | 1.94 | Green | P37 | 11 | 37 | 1 7/16 | 20 | |
| LCC1-14BF-E | | 1/4 | .75 | .70 | 1.36 | .11 | 2.06 | Green | P37 | 11 | 37 | 1 7/16 | 20 | |
| LCC1-56BF-E | | 5/16 | .75 | .70 | 1.36 | .11 | 2.19 | Green | P37 | 11 | 37 | 1 7/16 | 20 | |
| LCC1-56CF-E | | 5/16 | .88 | .70 | 1.36 | .11 | 2.31 | Green | P37 | 11 | 37 | 1 7/16 | 20 | |
| LCC1-38DF-E | | 3/8 | 1.00 | .70 | 1.36 | .11 | 2.51 | Green | P37 | 11 | 37 | 1 7/16 | 20 | |
| LCC1-12F-E | | 1/2 | 1.75 | .75 | 1.36 | .09 | 3.68 | Green | P37 | 11 | 37 | 1 7/16 | 20 | |
| LCC1/0-14AF-X | 1/0 AWG | 1/4 | .63 | .76 | 1.44 | .12 | 2.08 | Pink | P42 | 12 | 42 | 1 1/2 | 10 | |
| LCC1/0-14BF-X | | 1/4 | .75 | .76 | 1.44 | .12 | 2.20 | Pink | P42 | 12 | 42 | 1 1/2 | 10 | |
| LCC1/0-56CF-X | | 5/16 | .88 | .76 | 1.44 | .12 | 2.38 | Pink | P42 | 12 | 42 | 1 1/2 | 10 | |
| LCC1/0-56DF-X | | 5/16 | 1.00 | .76 | 1.44 | .12 | 2.51 | Pink | P42 | 12 | 42 | 1 1/2 | 10 | |
| LCC1/0-38DF-X | | 3/8 | 1.00 | .76 | 1.44 | .12 | 2.58 | Pink | P42 | 12 | 42 | 1 1/2 | 10 | |
| LCC1/0-12DF-X | | 1/2 | 1.00 | .80 | 1.44 | .12 | 2.85 | Pink | P42 | 12 | 42 | 1 1/2 | 10 | |
| LCC1/0-12F-X | 1/2 | 1.75 | .80 | 1.44 | .12 | 3.75 | Pink | P42 | 12 | 42 | 1 1/2 | 10 | | |
| LCC2/0-14AF-X | 2/0 AWG | 1/4 | .63 | .85 | 1.50 | .13 | 2.22 | Black | P45 | 13 | 45 | 1 9/16 | 10 | |
| LCC2/0-14BF-X | | 1/4 | .75 | .85 | 1.50 | .13 | 2.34 | Black | P45 | 13 | 45 | 1 9/16 | 10 | |
| LCC2/0-56DF-X | | 5/16 | 1.00 | .85 | 1.50 | .13 | 2.59 | Black | P45 | 13 | 45 | 1 9/16 | 10 | |
| LCC2/0-38DF-X | | 3/8 | 1.00 | .85 | 1.50 | .13 | 2.66 | Black | P45 | 13 | 45 | 1 9/16 | 10 | |
| LCC2/0-12DF-X | | 1/2 | 1.00 | .85 | 1.50 | .13 | 2.85 | Black | P45 | 13 | 45 | 1 9/16 | 10 | |
| LCC2/0-12F-X | | 1/2 | 1.75 | .85 | 1.50 | .13 | 3.82 | Black | P45 | 13 | 45 | 1 9/16 | 10 | |
| LCC3/0-14BF-X | 3/0 AWG | 1/4 | .75 | .96 | 1.50 | .13 | 2.42 | Orange | P50 | 14 | 50 | 1 9/16 | 10 | |
| LCC3/0-38DF-X | | 3/8 | 1.00 | .96 | 1.50 | .13 | 2.73 | Orange | P50 | 14 | 50 | 1 9/16 | 10 | |
| LCC3/0-12DF-X | | 1/2 | 1.00 | .96 | 1.50 | .13 | 2.98 | Orange | P50 | 14 | 50 | 1 9/16 | 10 | |
| LCC3/0-12F-X | | 1/2 | 1.75 | .96 | 1.50 | .13 | 3.89 | Orange | P50 | 14 | 50 | 1 9/16 | 10 | |
| LCC4/0-14BF-X | | 4/0 AWG | 1/4 | .75 | 1.06 | 1.56 | .14 | 2.50 | Purple | P54 | 15 | 54 | 1 5/8 | 10 |
| LCC4/0-56DF-X | | | 5/16 | 1.00 | 1.06 | 1.56 | .14 | 2.77 | Purple | P54 | 15 | 54 | 1 5/8 | 10 |
| LCC4/0-38DF-X | 3/8 | | 1.00 | 1.06 | 1.56 | .14 | 2.84 | Purple | P54 | 15 | 54 | 1 5/8 | 10 | |
| LCC4/0-38F-X | 3/8 | | 1.75 | 1.06 | 1.56 | .14 | 3.59 | Purple | P54 | 15 | 54 | 1 5/8 | 10 | |
| LCC4/0-12DF-X | 1/2 | | 1.00 | 1.06 | 1.56 | .14 | 3.07 | Purple | P54 | 15 | 54 | 1 5/8 | 10 | |
| LCC4/0-12F-X | 1/2 | | 1.75 | 1.06 | 1.56 | .14 | 3.98 | Purple | P54 | 15 | 54 | 1 5/8 | 10 | |
| LCC250-38DF-X | 250 kcmil | 3/8 | 1.00 | 1.17 | 1.61 | .14 | 2.90 | Yellow | P62 | 16 | 62 | 1 11/16 | 10 | |
| LCC250-12DF-X | | 1/2 | 1.00 | 1.17 | 1.61 | .14 | 3.13 | Yellow | P62 | 16 | 62 | 1 11/16 | 10 | |
| LCC250-12F-X | | 1/2 | 1.75 | 1.17 | 1.61 | .14 | 4.04 | Yellow | P62 | 16 | 62 | 1 11/16 | 10 | |
| LCC300-38DF-X | 300 kcmil | 3/8 | 1.00 | 1.19 | 2.24 | .16 | 2.88 | White | P66 | 17 | 66 | 2 5/16 | 10 | |
| LCC300-12F-X | | 1/2 | 1.75 | 1.19 | 2.24 | .16 | 4.06 | White | P66 | 17 | 66 | 2 5/16 | 10 | |
| LCC350-14BF-X | 350 kcmil | 1/4 | .75 | 1.28 | 2.24 | .17 | 2.46 | Red | P71 | 18 | 71 | 2 5/16 | 10 | |
| LCC350-38DF-X | | 3/8 | 1.00 | 1.28 | 2.24 | .17 | 2.94 | Red | P71 | 18 | 71 | 2 5/16 | 10 | |
| LCC350-12F-X | | 1/2 | 1.75 | 1.28 | 2.24 | .17 | 4.12 | Red | P71 | 18 | 71 | 2 5/16 | 10 | |
| LCC400-14BF-6 | 400 kcmil | 1/4 | .75 | 1.39 | 2.30 | .18 | 2.54 | Blue | P76 | 19 | 76 | 2 3/8 | 6 | |
| LCC400-38DF-6 | | 3/8 | 1.00 | 1.39 | 2.30 | .18 | 3.02 | Blue | P76 | 19 | 76 | 2 3/8 | 6 | |
| LCC400-12F-6 | | 1/2 | 1.75 | 1.39 | 2.30 | .18 | 4.20 | Blue | P76 | 19 | 76 | 2 3/8 | 6 | |
| LCC500-14BF-6 | 500 kcmil | 1/4 | .75 | 1.54 | 2.50 | .22 | 2.65 | Brown | P87 | 20 | 87 | 2 9/16 | 6 | |
| LCC500-38DF-6 | | 3/8 | 1.00 | 1.54 | 2.50 | .22 | 3.13 | Brown | P87 | 20 | 87 | 2 9/16 | 6 | |
| LCC500-12F-6 | | 1/2 | 1.75 | 1.54 | 2.50 | .22 | 4.31 | Brown | P87 | 20 | 87 | 2 9/16 | 6 | |
| LCC600-38DF-6 | 600 kcmil | 3/8 | 1.00 | 1.70 | 2.69 | .26 | 3.26 | Green | P94 | 22 | 94 | 2 3/4 | 6 | |
| LCC600-12F-6 | | 1/2 | 1.75 | 1.70 | 2.69 | .26 | 4.44 | Green | P94 | 22 | 94 | 2 3/4 | 6 | |

‡See pages D3.58 – D3.61 for tool and die information.

**Consult cable manufacturer for voltage stress relief instructions with applications greater than 2000 V.

◆NEMA hole sizes and spacing.



Code Conductor, Two-Hole, Long Barrel with Window Lug

For Use with Stranded Copper Conductors

Type LCC-W

- Long barrel maximizes number of crimps and provides premium wire pull-out strength and electrical performance
- Inspection window to visually assure full conductor insertion
- Color-coded barrels marked with *PANDUIT* and specified competitor die index numbers for proper crimp die selection
- Tin-plated to inhibit corrosion
- UL Listed and CSA Certified to 35 KV** and temperature rated to 90°C when crimped with *PANDUIT* and specified competitor crimping tools and dies
- UL Listed and CSA Certified for wide wire range-taking capability when crimped with *PANDUIT*® *UNI-DIE*™ Dieless Crimping Tools‡
- **Tested by Telcordia – meets NEBS Level 3**
- Meets J-STD-607-A and TIA-942 requirements for network systems grounding applications
- Available with NEMA hole sizes and spacing

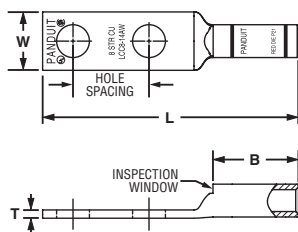

Figure 1

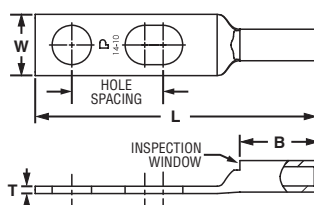

Figure 2: Slotted

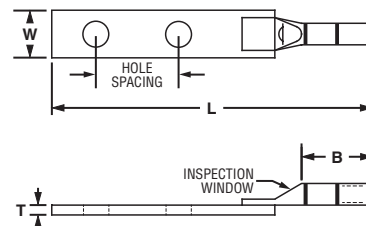

Figure 3: Two-Piece Brazed Tongue Construction

| Part Number | Figure No. | Copper Conductor Size | Stud Hole Size (In.) | Stud Hole Spacing (In.) | Figure Dimensions (In.) | | | | PANDUIT Color Code | PANDUIT Die Index No.‡ | Burndy Die Index No.‡ | T&B Die Index No.‡ | Wire Strip Length (In.) | Std. Pkg. Qty. | |
|----------------|------------|-----------------------|----------------------|-------------------------|-------------------------|------|------|------|--------------------|------------------------|-----------------------|--------------------|-------------------------|----------------|----|
| | | | | | W | B | T | L | | | | | | | |
| LCC10-14JAW-L* | 2 | #14 – 10 AWG STR. | 1/4 | .50 – .63 | .42 | .53 | .05 | 1.93 | — | — | — | — | 9/16 | 50 | |
| LCC10-14AW-L* | 1 | #12 – 10 AWG SOL | 1/4 | .63 | .42 | .53 | .05 | 1.93 | — | — | — | — | 9/16 | 50 | |
| LCC10-14BW-L* | 1 | #12 – 10 AWG SOL | 1/4 | .75 | .42 | .53 | .05 | 2.06 | — | — | — | — | 9/16 | 50 | |
| LCC8-10AW-L | 1 | #8 AWG | #10 | .63 | .41 | .70 | .08 | 2.01 | Red | P21 | 49 | 21 | 3/4 | 50 | |
| LCC8-10BW-L | 1 | | #10 | .75 | .41 | .70 | .08 | 2.14 | Red | P21 | 49 | 21 | 3/4 | 50 | |
| LCC8-10ABW-L | 2 | | #10 | .63 – .75 | .41 | .70 | .08 | 2.14 | Red | P21 | 49 | 21 | 3/4 | 50 | |
| LCC8-14AW-L | 1 | | 1/4 | .63 | .48 | .70 | .07 | 2.10 | Red | P21 | 49 | 21 | 3/4 | 50 | |
| LCC8-14BW-L | 1 | | 1/4 | .75 | .48 | .70 | .07 | 2.23 | Red | P21 | 49 | 21 | 3/4 | 50 | |
| LCC8-14ABW-L | 2 | | 1/4 | .63 – .75 | .48 | .70 | .07 | 2.23 | Red | P21 | 49 | 21 | 3/4 | 50 | |
| LCC8-14DW-L | 1 | | 1/4 | 1.00 | .48 | .70 | .07 | 2.48 | Red | P21 | 49 | 21 | 3/4 | 50 | |
| LCC8-38DW-L | 1 | | 3/8 | 1.00 | .60 | .70 | .05 | 2.70 | Red | P21 | 49 | 21 | 3/4 | 50 | |
| LCC6-10AW-L | 1 | | #6 AWG | #10 | .63 | .46 | 1.07 | .08 | 2.40 | Blue | P24 | 7 | 24 | 1 1/8 | 50 |
| LCC6-10BW-L | 1 | | | #10 | .75 | .46 | 1.07 | .08 | 2.52 | Blue | P24 | 7 | 24 | 1 1/8 | 50 |
| LCC6-10ABW-L | 2 | #10 | | .63 – .75 | .46 | 1.07 | .08 | 2.52 | Blue | P24 | 7 | 24 | 1 1/8 | 50 | |
| LCC6-14JW-L | 1 | 1/4 | | .50 | .48 | 1.07 | .08 | 2.36 | Blue | P24 | 7 | 24 | 1 1/8 | 50 | |
| LCC6-14AW-L | 1 | 1/4 | | .63 | .48 | 1.07 | .08 | 2.49 | Blue | P24 | 7 | 24 | 1 1/8 | 50 | |
| LCC6-14JAW-L | 2 | 1/4 | | .50 – .63 | .48 | 1.07 | .08 | 2.49 | Blue | P24 | 7 | 24 | 1 1/8 | 50 | |
| LCC6-14BW-L | 1 | 1/4 | | .75 | .48 | 1.07 | .08 | 2.61 | Blue | P24 | 7 | 24 | 1 1/8 | 50 | |
| LCC6-14DW-L | 1 | 1/4 | | 1.00 | .48 | 1.07 | .08 | 2.86 | Blue | P24 | 7 | 24 | 1 1/8 | 50 | |
| LCC6-14BDW-L | 2 | 1/4 | | .75 – 1.00 | .48 | 1.07 | .08 | 2.86 | Blue | P24 | 7 | 24 | 1 1/8 | 50 | |
| LCC6-14EW-L | 1 | 1/4 | | 1.25 | .48 | 1.07 | .08 | 3.11 | Blue | P24 | 7 | 24 | 1 1/8 | 50 | |
| LCC6-14W-L | 1 | 1/4 | | 1.75 | .48 | 1.07 | .08 | 3.61 | Blue | P24 | 7 | 24 | 1 1/8 | 50 | |
| LCC6-56BW-L | 1 | 5/16 | | .75 | .56 | 1.07 | .07 | 2.73 | Blue | P24 | 7 | 24 | 1 1/8 | 50 | |
| LCC6-38BW-L | 1 | 3/8 | | .75 | .62 | 1.07 | .06 | 2.83 | Blue | P24 | 7 | 24 | 1 1/8 | 50 | |
| LCC6-38CW-L | 1 | 3/8 | | .88 | .62 | 1.07 | .06 | 2.96 | Blue | P24 | 7 | 24 | 1 1/8 | 50 | |
| LCC6-38DW-L | 1 | 3/8 | | 1.00 | .62 | 1.07 | .06 | 3.08 | Blue | P24 | 7 | 24 | 1 1/8 | 50 | |
| LCC6-38BDW-L | 2 | 3/8 | | .75 – 1.00 | .62 | 1.07 | .06 | 3.08 | Blue | P24 | 7 | 24 | 1 1/8 | 50 | |
| LCC6-12W-L | 3 | 1/2 | | 1.75 | .75 | 1.13 | .16 | 5.00 | Blue | P24 | 7 | 24 | 1 3/16 | 50 | |

‡See pages D3.58 – D3.61 for tool and die information.

*Not tested to NEBS Level 3 requirements.

**Consult cable manufacturer for voltage stress relief instructions with applications greater than 2000 V.

Table continues on page D2.48

A. System Overview

B1. Cable Ties

B2. Cable Accessories

B3. Stainless Steel Ties

C1. Wiring Duct

C2. Surface Raceway

C3. Abrasion Protection

C4. Cable Management

D1. Terminals

D2. Power Connectors

D3. Grounding Connectors

E1. Labeling Systems

E2. Labels

E3. Pre-Printed & Write-On Markers

E4. Permanent Identification

E5. Lockout/Tagout & Safety Solutions

F. Index

A.
System
Overview



Code Conductor, Two-Hole, Long Barrel with Window Lug (continued)

B1.
Cable Ties

B2.
Cable
Accessories

B3.
Stainless
Steel Ties

C1.
Wiring
Duct

C2.
Surface
Raceway

C3.
Abrasion
Protection

C4.
Cable
Management

D1.
Terminals

D2.
Power
Connectors

D3.
Grounding
Connectors

E1.
Labeling
Systems

E2.
Labels

E3.
Pre-Printed
& Write-On
Markers

E4.
Permanent
Identification

E5.
Lockout/
Tagout
& Safety
Solutions

F.
Index

| Part Number | Figure No. | Copper Conductor Size | Stud Hole Size (In.) | Stud Hole Spacing (In.) | Figure Dimensions (In.) | | | | PANDUIT Color Code | PANDUIT Die Index No.‡ | Burndy Die Index No.‡ | T&B Die Index No.‡ | Wire Strip Length (In.) | Std. Pkg. Qty. | |
|---------------|------------|----------------------------|----------------------|-------------------------|-------------------------|------|------|-------|--------------------|------------------------|-----------------------|--------------------|-------------------------|----------------|----|
| | | | | | W | B | T | L | | | | | | | |
| LCC4-10AW-L | 1 | #4 – 3 AWG STR, #2 AWG SOL | #10 | .63 | .55 | 1.05 | .09 | 2.40 | Gray | P29 | 8 | 29 | 1 1/8 | 50 | |
| LCC4-10BW-L | 1 | | #10 | .75 | .55 | 1.05 | .09 | 2.53 | Gray | P29 | 8 | 29 | 1 1/8 | 50 | |
| LCC4-14AW-L | 1 | | 1/4 | .63 | .55 | 1.05 | .09 | 2.50 | Gray | P29 | 8 | 29 | 1 1/8 | 50 | |
| LCC4-14BW-L | 1 | | 1/4 | .75 | .55 | 1.05 | .09 | 2.63 | Gray | P29 | 8 | 29 | 1 1/8 | 50 | |
| LCC4-14DW-L | 1 | | 1/4 | 1.00 | .55 | 1.05 | .09 | 2.63 | Gray | P29 | 8 | 29 | 1 1/8 | 50 | |
| LCC4-14ADW-L | 2 | | 1/4 | .63 – 1.00 | .55 | 1.05 | .09 | 2.87 | Gray | P29 | 8 | 29 | 1 1/8 | 50 | |
| LCC4-38DW-L | 1 | | 3/8 | 1.00 | .62 | 1.05 | .08 | 3.09 | Gray | P29 | 8 | 29 | 1 1/8 | 50 | |
| LCC4-12W-L | 3 | | 1/2 | 1.75 | .75 | 1.13 | .16 | 5.06 | Gray | P29 | 8 | 29 | 1 3/16 | 50 | |
| LCC2-10AW-Q | 1 | | #2 AWG | #10 | .63 | .60 | 1.16 | .10 | 2.57 | Brown | P33 | 10 | 33 | 1 1/4 | 25 |
| LCC2-10BW-Q | 1 | | | #10 | .75 | .60 | 1.16 | .10 | 2.69 | Brown | P33 | 10 | 33 | 1 1/4 | 25 |
| LCC2-14AW-Q | 1 | 1/4 | | .63 | .60 | 1.16 | .10 | 2.67 | Brown | P33 | 10 | 33 | 1 1/4 | 25 | |
| LCC2-14BW-Q | 1 | 1/4 | | .75 | .60 | 1.16 | .10 | 2.79 | Brown | P33 | 10 | 33 | 1 1/4 | 25 | |
| LCC2-14DW-Q | 1 | 1/4 | | 1.00 | .60 | 1.16 | .10 | 3.04 | Brown | P33 | 10 | 33 | 1 1/4 | 25 | |
| LCC2-56BW-Q | 1 | 5/16 | | .75 | .66 | 1.16 | .10 | 2.92 | Brown | P33 | 10 | 33 | 1 1/4 | 25 | |
| LCC2-56CW-Q | 1 | 5/16 | | .88 | .66 | 1.16 | .10 | 3.04 | Brown | P33 | 10 | 33 | 1 1/4 | 25 | |
| LCC2-38BW-Q | 1 | 3/8 | | .75 | .66 | 1.16 | .10 | 2.99 | Brown | P33 | 10 | 33 | 1 1/4 | 25 | |
| LCC2-38CW-Q | 1 | 3/8 | | .88 | .66 | 1.16 | .10 | 3.12 | Brown | P33 | 10 | 33 | 1 1/4 | 25 | |
| LCC2-38DW-Q | 1 | 3/8 | | 1.00 | .66 | 1.16 | .10 | 3.24 | Brown | P33 | 10 | 33 | 1 1/4 | 25 | |
| LCC2-38W-Q | 1 | 3/8 | 1.75 | .66 | 1.16 | .10 | 3.99 | Brown | P33 | 10 | 33 | 1 1/4 | 25 | | |
| LCC2-12W-Q | 1 | 1/2 | 1.75 | .75 | 1.16 | .08 | 4.41 | Brown | P33 | 10 | 33 | 1 1/4 | 25 | | |
| LCC1-14AW-E | 1 | #1 AWG | 1/4 | .63 | .70 | 1.36 | .11 | 2.89 | Green | P37 | 11 | 37 | 1 7/16 | 20 | |
| LCC1-14BW-E | 1 | | 1/4 | .75 | .70 | 1.36 | .11 | 3.01 | Green | P37 | 11 | 37 | 1 7/16 | 20 | |
| LCC1-56BW-E | 1 | | 5/16 | .75 | .70 | 1.36 | .11 | 3.14 | Green | P37 | 11 | 37 | 1 7/16 | 20 | |
| LCC1-56CW-E | 1 | | 5/16 | .88 | .70 | 1.36 | .11 | 3.26 | Green | P37 | 11 | 37 | 1 7/16 | 20 | |
| LCC1-38DW-E | 1 | | 3/8 | 1.00 | .70 | 1.36 | .11 | 3.46 | Green | P37 | 11 | 37 | 1 7/16 | 20 | |
| LCC1-12W-E | 1 | | 1/2 | 1.75 | .75 | 1.36 | .09 | 4.63 | Green | P37 | 11 | 37 | 1 7/16 | 20 | |
| LCC1/0-14AW-X | 1 | 1/0 AWG | 1/4 | .63 | .76 | 1.44 | .12 | 3.07 | Pink | P42 | 12 | 42 | 1 1/2 | 10 | |
| LCC1/0-14BW-X | 1 | | 1/4 | .75 | .76 | 1.44 | .12 | 3.19 | Pink | P42 | 12 | 42 | 1 1/2 | 10 | |
| LCC1/0-14DW-X | 1 | | 1/4 | 1.00 | .76 | 1.44 | .12 | 3.44 | Pink | P42 | 12 | 42 | 1 1/2 | 10 | |
| LCC1/0-38DW-X | 1 | | 3/8 | 1.00 | .76 | 1.44 | .12 | 3.57 | Pink | P42 | 12 | 42 | 1 1/2 | 10 | |
| LCC1/0-38W-X | 1 | | 3/8 | 1.75 | .76 | 1.44 | .12 | 4.32 | Pink | P42 | 12 | 42 | 1 1/2 | 10 | |
| LCC1/0-12DW-X | 1 | | 1/2 | 1.00 | .80 | 1.44 | .12 | 3.84 | Pink | P42 | 12 | 42 | 1 1/2 | 10 | |
| LCC1/0-12W-X | 1 | | 1/2 | 1.75 | .80 | 1.44 | .12 | 4.74 | Pink | P42 | 12 | 42 | 1 1/2 | 10 | |
| LCC2/0-14AW-X | 1 | | 1/4 | .63 | .85 | 1.50 | .13 | 3.23 | Black | P45 | 13 | 45 | 1 9/16 | 10 | |
| LCC2/0-14BW-X | 1 | 1/4 | .75 | .85 | 1.50 | .13 | 3.36 | Black | P45 | 13 | 45 | 1 9/16 | 10 | | |
| LCC2/0-56DW-X | 1 | 5/16 | 1.00 | .85 | 1.50 | .13 | 3.61 | Black | P45 | 13 | 45 | 1 9/16 | 10 | | |
| LCC2/0-38DW-X | 1 | 3/8 | 1.00 | .85 | 1.50 | .13 | 3.67 | Black | P45 | 13 | 45 | 1 9/16 | 10 | | |
| LCC2/0-12DW-X | 1 | 1/2 | 1.00 | .85 | 1.50 | .13 | 3.92 | Black | P45 | 13 | 45 | 1 9/16 | 10 | | |
| LCC2/0-12W-X | 1 | 1/2 | 1.75 | .85 | 1.50 | .13 | 4.83 | Black | P45 | 13 | 45 | 1 9/16 | 10 | | |

‡See pages D3.58 – D3.61 for tool and die information.

**Consult cable manufacturer for voltage stress relief instructions with applications greater than 2000 V.



Code Conductor, Two-Hole, Long Barrel with Window Lug (continued)

| Part Number | Figure No. | Copper Conductor Size | Stud Hole Size (In.) | Stud Hole Spacing (In.) | Figure Dimensions (In.) | | | | PANDUIT Color Code | PANDUIT Die Index No.† | Burndy Die Index No.‡ | T&B Die Index No.‡ | Wire Strip Length (In.) | Std. Pkg. Qty. | |
|----------------|------------|-----------------------|----------------------|-------------------------|-------------------------|------|------|------|--------------------|------------------------|-----------------------|--------------------|-------------------------|----------------|----|
| | | | | | W | B | T | L | | | | | | | |
| LCC3/0-14BW-X | 1 | 3/0 AWG | 1/4 | .75 | .96 | 1.50 | .13 | 3.39 | Orange | P50 | 14 | 50 | 1 9/16 | 10 | |
| LCC3/0-56DW-X | 1 | | 5/16 | 1.00 | .96 | 1.50 | .13 | 3.64 | Orange | P50 | 14 | 50 | 1 9/16 | 10 | |
| LCC3/0-38DW-X | 1 | | 3/8 | 1.00 | .96 | 1.50 | .13 | 3.70 | Orange | P50 | 14 | 50 | 1 9/16 | 10 | |
| LCC3/0-12DW-X | 1 | | 1/2 | 1.00 | .96 | 1.50 | .13 | 3.95 | Orange | P50 | 14 | 50 | 1 9/16 | 10 | |
| LCC3/0-12W-X | 1 | | 1/2 | 1.75 | .96 | 1.50 | .13 | 4.87 | Orange | P50 | 14 | 50 | 1 9/16 | 10 | |
| LCC4/0-14AW-X | 1 | 4/0 AWG | 1/4 | .63 | 1.06 | 1.56 | .14 | 3.35 | Purple | P54 | 15 | 54 | 1 5/8 | 10 | |
| LCC4/0-14BW-X | 1 | | 1/4 | .75 | 1.06 | 1.56 | .14 | 3.48 | Purple | P54 | 15 | 54 | 1 5/8 | 10 | |
| LCC4/0-56DW-X | 1 | | 5/16 | 1.00 | 1.06 | 1.56 | .14 | 3.74 | Purple | P54 | 15 | 54 | 1 5/8 | 10 | |
| LCC4/0-38DW-X | 1 | | 3/8 | 1.00 | 1.06 | 1.56 | .14 | 3.81 | Purple | P54 | 15 | 54 | 1 5/8 | 10 | |
| LCC4/0-38W-X | 1 | | 3/8 | 1.75 | 1.06 | 1.56 | .14 | 4.56 | Purple | P54 | 15 | 54 | 1 5/8 | 10 | |
| LCC4/0-12DW-X | 1 | 250 kcmil | 1/2 | 1.00 | 1.06 | 1.56 | .14 | 4.04 | Purple | P54 | 15 | 54 | 1 5/8 | 10 | |
| LCC4/0-12W-X | 1 | | 1/2 | 1.75 | 1.06 | 1.56 | .14 | 4.95 | Purple | P54 | 15 | 54 | 1 5/8 | 10 | |
| LCC250-56DW-X | 1 | | 5/16 | 1.00 | 1.17 | 1.61 | .14 | 3.82 | Yellow | P62 | 16 | 62 | 1 11/16 | 10 | |
| LCC250-38DW-X | 1 | | 3/8 | 1.00 | 1.17 | 1.61 | .14 | 3.89 | Yellow | P62 | 16 | 62 | 1 11/16 | 10 | |
| LCC250-12DW-X | 1 | | 1/2 | 1.00 | 1.17 | 1.61 | .14 | 4.12 | Yellow | P62 | 16 | 62 | 1 11/16 | 10 | |
| LCC250-12W-X | 1 | 300 kcmil | 1/2 | 1.75 | 1.17 | 1.61 | .14 | 5.03 | Yellow | P62 | 16 | 62 | 1 11/16 | 10 | |
| LCC300-38DW-X | 1 | | 3/8 | 1.00 | 1.19 | 2.24 | .16 | 4.54 | White | P66 | 17 | 66 | 2 5/16 | 10 | |
| LCC300-12W-X | 1 | | 1/2 | 1.75 | 1.19 | 2.24 | .16 | 5.72 | White | P66 | 17 | 66 | 2 5/16 | 10 | |
| LCC350-14BW-X | 1 | | 350 kcmil | 1/4 | .75 | 1.28 | 2.24 | .17 | 4.10 | Red | P71 | 18 | 71 | 2 5/16 | 10 |
| LCC350-38DW-X | 1 | | | 3/8 | 1.00 | 1.28 | 2.24 | .17 | 4.58 | Red | P71 | 18 | 71 | 2 5/16 | 10 |
| LCC350-12W-X | 1 | 1/2 | | 1.75 | 1.28 | 2.24 | .17 | 5.76 | Red | P71 | 18 | 71 | 2 5/16 | 10 | |
| LCC400-14BW-6 | 1 | 400 kcmil | 1/4 | .75 | 1.39 | 2.30 | .18 | 4.18 | Blue | P76 | 19 | 76 | 2 3/8 | 6 | |
| LCC400-38DW-6 | 1 | | 3/8 | 1.00 | 1.39 | 2.30 | .18 | 4.66 | Blue | P76 | 19 | 76 | 2 3/8 | 6 | |
| LCC400-12W-6 | 1 | | 1/2 | 1.75 | 1.28 | 2.30 | .17 | 5.84 | Blue | P76 | 19 | 76 | 2 3/8 | 6 | |
| LCC500-14BW-6 | 1 | 500 kcmil | 1/4 | .75 | 1.54 | 2.50 | .22 | 4.46 | Brown | P87 | 20 | 87 | 2 9/16 | 6 | |
| LCC500-38DW-6 | 1 | | 3/8 | 1.00 | 1.54 | 2.50 | .22 | 4.94 | Brown | P87 | 20 | 87 | 2 9/16 | 6 | |
| LCC500-12W-6 | 1 | | 1/2 | 1.75 | 1.54 | 2.50 | .22 | 6.12 | Brown | P87 | 20 | 87 | 2 9/16 | 6 | |
| LCC600-38DW-6 | 1 | 600 kcmil | 3/8 | 1.00 | 1.70 | 2.69 | .26 | 5.18 | Green | P94 | 22 | 94 | 2 3/4 | 6 | |
| LCC600-12W-6 | 1 | | 1/2 | 1.75 | 1.70 | 2.69 | .26 | 6.36 | Green | P94 | 22 | 94 | 2 3/4 | 6 | |
| LCC750-38DW-6 | 1 | 750 kcmil | 3/8 | 1.00 | 1.89 | 2.88 | .26 | 5.71 | Black | P106 | 24 | 106 | 2 15/16 | 6 | |
| LCC750-12W-6 | 1 | | 1/2 | 1.75 | 1.89 | 2.88 | .26 | 6.65 | Black | P106 | 24 | 106 | 2 15/16 | 6 | |
| LCC800-12W-6 | 1 | 800 kcmil | 1/2 | 1.75 | 1.95 | 2.94 | .30 | 6.74 | Orange | P107 | 25 | 107 | 3 | 6 | |
| LCC1000-38DW-3 | 1 | 1000 kcmil | 3/8 | 1.00 | 2.17 | 3.00 | .32 | 5.95 | White | P125 | 27 | 125 | 3 1/16 | 3 | |
| LCC1000-12W-3 | 1 | | 1/2 | 1.75 | 2.17 | 3.00 | .32 | 6.89 | White | P125 | 27 | 125 | 3 1/16 | 3 | |

†See pages D3.58 – D3.61 for tool and die information.

**Consult cable manufacturer for voltage stress relief instructions with applications greater than 2000 V.

◆NEMA hole sizes and spacing.

A.
System
Overview

B1.
Cable
Ties

B2.
Cable
Accessories

B3.
Stainless
Steel
Ties

C1.
Wiring
Duct

C2.
Surface
Raceway

C3.
Abrasion
Protection

C4.
Cable
Management

D1.
Terminals

D2.
Power
Connectors

D3.
Grounding
Connectors

E1.
Labeling
Systems

E2.
Labels

E3.
Pre-Printed
& Write-On
Markers

E4.
Permanent
Identification

E5.
Lockout/
Tagout
& Safety
Solutions

F.
Index

A. System Overview



Code Conductor, Two-Hole, Long Barrel with Window Lug, 45° Angle

B1. Cable Ties

For Use with Stranded Copper Conductors

Type LCC-WH

- Long barrel maximizes number of crimps and provides premium wire pull-out strength and electrical performance
- Inspection window to visually assure full conductor insertion
- Color-coded barrels marked with **PANDUIT** and specified competitor die index numbers for proper crimp die selection
- Tin-plated to inhibit corrosion
- UL Listed and CSA Certified to 35 KV** and temperature rated to 90°C when crimped with **PANDUIT** and specified competitor crimping tools and dies

- UL Listed and CSA Certified for wide wire range-taking capability when crimped with **PANDUIT® UNI-DIE™** Dieless Crimping Tools‡
- **Tested by Telcordia – meets NEBS Level 3**
- Meets J-STD-607-A and TIA-942 requirements for network systems grounding applications
- Available with NEMA hole sizes and spacing

B3. Stainless Steel Ties

C1. Wiring Duct

C2. Surface Raceway

C3. Abrasion Protection

C4. Cable Management

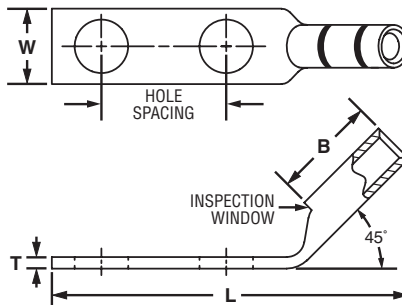

Figure 1

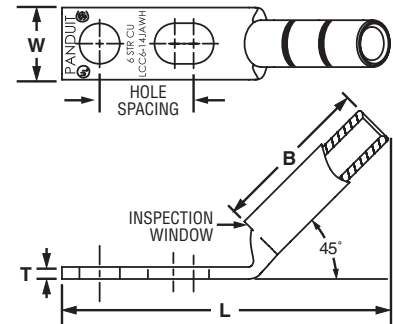

Figure 2: Slotted

D1. Terminals

D2. Power Connectors

D3. Grounding Connectors

E1. Labeling Systems

E2. Labels

E3. Pre-Printed & Write-On Markers

E4. Permanent Identification

E5. Lockout/Tagout & Safety Solutions

F. Index

| Part Number | Figure No. | Copper Conductor Size | Stud Hole Size (In.) | Stud Hole Spacing (In.) | Figure Dimensions (In.) | | | | PANDUIT Color Code | PANDUIT Die Index No.‡ | Burdny Die Index No.‡ | T&B Die Index No.‡ | Wire Strip Length (In.) | Std. Pkg. Qty. |
|-----------------|------------|-----------------------|----------------------|-------------------------|-------------------------|------|------|------|--------------------|------------------------|-----------------------|--------------------|-------------------------|----------------|
| | | | | | W | B | T | L | | | | | | |
| LCC10-14JAWH-L* | 2 | #14 – 10 | 1/4 | .50 – .63 | .42 | .53 | .05 | 1.78 | — | — | — | — | 9/16 | 50 |
| LCC10-14AWH-L* | 1 | AWG STR | 1/4 | .63 | .42 | .53 | .05 | 1.78 | — | — | — | — | 9/16 | 50 |
| LCC10-14BWH-L* | 1 | #12 – 10 AWG SOL | 1/4 | .75 | .42 | .53 | .05 | 1.90 | — | — | — | — | 9/16 | 50 |
| LCC8-10AWH-L | 1 | #8 AWG | #10 | .63 | .41 | .70 | .08 | 1.82 | Red | P21 | 49 | 21 | 3/4 | 50 |
| LCC8-10BWH-L | 1 | | #10 | .75 | .41 | .70 | .08 | 1.95 | Red | P21 | 49 | 21 | 3/4 | 50 |
| LCC8-14AWH-L | 1 | | 1/4 | .63 | .48 | .70 | .07 | 1.91 | Red | P21 | 49 | 21 | 3/4 | 50 |
| LCC8-14BWH-L | 1 | | 1/4 | .75 | .48 | .70 | .07 | 2.03 | Red | P21 | 49 | 21 | 3/4 | 50 |
| LCC8-14DWH-L | 1 | | 1/4 | 1.00 | .48 | .70 | .07 | 2.28 | Red | P21 | 49 | 21 | 3/4 | 50 |
| LCC8-38DWH-L | 1 | | 3/8 | 1.00 | .60 | .70 | .05 | 2.49 | Red | P21 | 49 | 21 | 3/4 | 50 |
| LCC6-10AWH-L | 1 | | #10 | .63 | .46 | 1.07 | .08 | 2.09 | Blue | P24 | 7 | 24 | 1 1/8 | 50 |
| LCC6-10BWH-L | 1 | #10 | .75 | .46 | 1.07 | .08 | 2.22 | Blue | P24 | 7 | 24 | 1 1/8 | 50 | |
| LCC6-14JWH-L | 1 | 1/4 | .50 | .48 | 1.07 | .08 | 2.06 | Blue | P24 | 7 | 24 | 1 1/8 | 50 | |
| LCC6-14AWH-L | 1 | 1/4 | .63 | .48 | 1.07 | .08 | 2.18 | Blue | P24 | 7 | 24 | 1 1/8 | 50 | |
| LCC6-14JAWH-L | 2 | 1/4 | .50 – .63 | .48 | 1.07 | .08 | 2.08 | Blue | P24 | 7 | 24 | 1 1/8 | 50 | |
| LCC6-14BWH-L | 1 | 1/4 | .75 | .48 | 1.07 | .08 | 2.31 | Blue | P24 | 7 | 24 | 1 1/8 | 50 | |
| LCC6-14DWH-L | 1 | 1/4 | 1.00 | .48 | 1.07 | .08 | 2.56 | Blue | P24 | 7 | 24 | 1 1/8 | 50 | |
| LCC6-14EWH-L | 1 | 1/4 | 1.25 | .48 | 1.07 | .08 | 2.81 | Blue | P24 | 7 | 24 | 1 1/8 | 50 | |
| LCC6-56BWH-L | 1 | 5/16 | .75 | .56 | 1.07 | .07 | 2.42 | Blue | P24 | 7 | 24 | 1 1/8 | 50 | |
| LCC6-38BWH-L | 1 | 3/8 | .75 | .62 | 1.07 | .06 | 2.52 | Blue | P24 | 7 | 24 | 1 1/8 | 50 | |
| LCC6-38CWH-L | 1 | 3/8 | .88 | .62 | 1.07 | .06 | 2.64 | Blue | P24 | 7 | 24 | 1 1/8 | 50 | |
| LCC6-38DWH-L | 1 | 3/8 | 1.00 | .62 | 1.07 | .06 | 2.77 | Blue | P24 | 7 | 24 | 1 1/8 | 50 | |

‡See pages D3.58 – D3.61 for tool and die information.

*Not tested to NEBS Level 3 requirements.

**Consult cable manufacturer for voltage stress relief instructions with applications greater than 2000 V.



Code Conductor, Two-Hole, Long Barrel with Window Lug, 45° Angle (continued)

A.
System
Overview

B1.
Cable Ties

B2.
Cable
Accessories

B3.
Stainless
Steel Ties

C1.
Wiring
Duct

C2.
Surface
Raceway

C3.
Abrasion
Protection

C4.
Cable
Management

D1.
Terminals

D2.
Power
Connectors

D3.
Grounding
Connectors

E1.
Labeling
Systems

E2.
Labels

E3.
Pre-Printed
& Write-On
Markers

E4.
Permanent
Identification

E5.
Lockout/
Tagout
& Safety
Solutions

F.
Index

| Part Number | Figure No. | Copper Conductor Size | Stud Hole Size (In.) | Stud Hole Spacing (In.) | Figure Dimensions (In.) | | | | PANDUIT Color Code | PANDUIT Die Index No.‡ | Burdny Die Index No.‡ | T&B Die Index No.‡ | Wire Strip Length (In.) | Std. Pkg. Qty. |
|----------------|------------|----------------------------|----------------------|-------------------------|-------------------------|------|------|--------|--------------------|------------------------|-----------------------|--------------------|-------------------------|----------------|
| | | | | | W | B | T | L | | | | | | |
| LCC4-10AWH-L | 1 | #4 – 3 AWG STR, #2 AWG SOL | #10 | .63 | .55 | 1.05 | .09 | 2.11 | Gray | P29 | 8 | 29 | 1 1/8 | 50 |
| LCC4-10BWH-L | 1 | | #10 | .75 | .55 | 1.05 | .09 | 2.23 | Gray | P29 | 8 | 29 | 1 1/8 | 50 |
| LCC4-14AWH-L | 1 | | 1/4 | .63 | .55 | 1.05 | .09 | 2.20 | Gray | P29 | 8 | 29 | 1 1/8 | 50 |
| LCC4-14BWH-L | 1 | | 1/4 | .75 | .55 | 1.05 | .09 | 2.32 | Gray | P29 | 8 | 29 | 1 1/8 | 50 |
| LCC4-38DWH-L | 1 | #2 AWG | 3/8 | 1.00 | .62 | 1.05 | .08 | 2.79 | Gray | P29 | 8 | 29 | 1 1/8 | 50 |
| LCC2-10AWH-Q | 1 | | #10 | .63 | .60 | 1.16 | .10 | 2.21 | Brown | P33 | 10 | 33 | 1 1/4 | 25 |
| LCC2-10BWH-Q | 1 | | #10 | .75 | .60 | 1.16 | .10 | 2.33 | Brown | P33 | 10 | 33 | 1 1/4 | 25 |
| LCC2-14AWH-Q | 1 | | 1/4 | .63 | .60 | 1.16 | .10 | 2.31 | Brown | P33 | 10 | 33 | 1 1/4 | 25 |
| LCC2-14BWH-Q | 1 | | 1/4 | .75 | .60 | 1.16 | .10 | 2.43 | Brown | P33 | 10 | 33 | 1 1/4 | 25 |
| LCC2-14DWH-Q | 1 | | 1/4 | 1.00 | .60 | 1.16 | .10 | 2.68 | Brown | P33 | 10 | 33 | 1 1/4 | 25 |
| LCC2-56BWH-Q | 1 | | 5/16 | .75 | .66 | 1.16 | .10 | 2.55 | Brown | P33 | 10 | 33 | 1 1/4 | 25 |
| LCC2-56CWH-Q | 1 | | 5/16 | .88 | .66 | 1.16 | .10 | 2.68 | Brown | P33 | 10 | 33 | 1 1/4 | 25 |
| LCC2-38BWH-Q | 1 | | 3/8 | .75 | .66 | 1.16 | .10 | 2.63 | Brown | P33 | 10 | 33 | 1 1/4 | 25 |
| LCC2-38CWH-Q | 1 | | 3/8 | .88 | .66 | 1.16 | .10 | 2.75 | Brown | P33 | 10 | 33 | 1 1/4 | 25 |
| LCC2-38DWH-Q | 1 | | 3/8 | 1.00 | .66 | 1.16 | .10 | 2.88 | Brown | P33 | 10 | 33 | 1 1/4 | 25 |
| LCC2-38WH-Q | 1 | | 3/8 | 1.75 | .66 | 1.16 | .10 | 3.63 | Brown | P33 | 10 | 33 | 1 1/4 | 25 |
| LCC2-12WH-Q | 1 | | 1/2 | 1.75 | .75 | 1.16 | .08 | 4.03 | Brown | P33 | 10 | 33 | 1 1/4 | 25 |
| LCC1-14AWH-E | 1 | | #1 AWG | 1/4 | .63 | .70 | 1.36 | .11 | 2.46 | Green | P37 | 11 | 37 | 1 7/16 |
| LCC1-14BWH-E | 1 | 1/4 | | .75 | .70 | 1.36 | .11 | 2.58 | Green | P37 | 11 | 37 | 1 7/16 | 20 |
| LCC1-56BWH-E | 1 | 5/16 | | .75 | .70 | 1.36 | .11 | 2.71 | Green | P37 | 11 | 37 | 1 7/16 | 20 |
| LCC1-56CWH-E | 1 | 5/16 | | .88 | .70 | 1.36 | .11 | 2.83 | Green | P37 | 11 | 37 | 1 7/16 | 20 |
| LCC1-38DWH-E | 1 | 3/8 | | 1.00 | .70 | 1.36 | .11 | 3.04 | Green | P37 | 11 | 37 | 1 7/16 | 20 |
| LCC1-12WH-E | 1 | 1/2 | | 1.75 | .75 | 1.36 | .09 | 4.20 | Green | P37 | 11 | 37 | 1 7/16 | 20 |
| LCC1/0-14AWH-X | 1 | 1/0 AWG | 1/4 | .63 | .76 | 1.44 | .12 | 2.61 | Pink | P42 | 12 | 42 | 1 1/2 | 10 |
| LCC1/0-14BWH-X | 1 | | 1/4 | .75 | .76 | 1.44 | .12 | 2.73 | Pink | P42 | 12 | 42 | 1 1/2 | 10 |
| LCC1/0-14DWH-X | 1 | | 1/4 | 1.00 | .76 | 1.44 | .12 | 2.98 | Pink | P42 | 12 | 42 | 1 1/2 | 10 |
| LCC1/0-38DWH-X | 1 | | 3/8 | 1.00 | .76 | 1.44 | .12 | 3.11 | Pink | P42 | 12 | 42 | 1 1/2 | 10 |
| LCC1/0-38WH-X | 1 | | 3/8 | 1.75 | .76 | 1.44 | .12 | 3.86 | Pink | P42 | 12 | 42 | 1 1/2 | 10 |
| LCC1/0-12DWH-X | 1 | | 1/2 | 1.00 | .80 | 1.44 | .12 | 3.37 | Pink | P42 | 12 | 42 | 1 1/2 | 10 |
| LCC1/0-12WH-X | 1 | 1/2 | 1.75 | .80 | 1.44 | .12 | 4.28 | Pink | P42 | 12 | 42 | 1 1/2 | 10 | |
| LCC2/0-14AWH-X | 1 | 2/0 AWG | 1/4 | .63 | .85 | 1.50 | .13 | 2.76 | Black | P45 | 13 | 45 | 1 9/16 | 10 |
| LCC2/0-14BWH-X | 1 | | 1/4 | .75 | .85 | 1.50 | .13 | 2.88 | Black | P45 | 13 | 45 | 1 9/16 | 10 |
| LCC2/0-56DWH-X | 1 | | 5/16 | 1.00 | .85 | 1.50 | .13 | 3.13 | Black | P45 | 13 | 45 | 1 9/16 | 10 |
| LCC2/0-38DWH-X | 1 | | 3/8 | 1.00 | .85 | 1.50 | .13 | 3.20 | Black | P45 | 13 | 45 | 1 9/16 | 10 |
| LCC2/0-12DWH-X | 1 | | 1/2 | 1.00 | .85 | 1.50 | .13 | 3.45 | Black | P45 | 13 | 45 | 1 9/16 | 10 |
| LCC2/0-12WH-X | 1 | | 1/2 | 1.75 | .85 | 1.50 | .13 | 4.36 | Black | P45 | 13 | 45 | 1 9/16 | 10 |
| LCC3/0-14BWH-X | 1 | 3/0 AWG | 1/4 | .75 | .96 | 1.50 | .13 | 2.91 | Orange | P50 | 14 | 50 | 1 9/16 | 10 |
| LCC3/0-56DWH-X | 1 | | 5/16 | 1.00 | .96 | 1.50 | .13 | 3.16 | Orange | P50 | 14 | 50 | 1 9/16 | 10 |
| LCC3/0-38DWH-X | 1 | | 3/8 | 1.00 | .96 | 1.50 | .13 | 3.22 | Orange | P50 | 14 | 50 | 1 9/16 | 10 |
| LCC3/0-12DWH-X | 1 | | 1/2 | 1.00 | .96 | 1.50 | .13 | 3.47 | Orange | P50 | 14 | 50 | 1 9/16 | 10 |
| LCC3/0-12WH-X | 1 | | 1/2 | 1.75 | .96 | 1.50 | .13 | 4.38 | Orange | P50 | 14 | 50 | 1 9/16 | 10 |
| LCC4/0-14AWH-X | 1 | | 4/0 AWG | 1/4 | .63 | 1.06 | 1.56 | .14 | 2.85 | Purple | P54 | 15 | 54 | 1 5/8 |
| LCC4/0-14BWH-X | 1 | 1/4 | | .75 | 1.06 | 1.56 | .14 | 2.98 | Purple | P54 | 15 | 54 | 1 5/8 | 10 |
| LCC4/0-56DWH-X | 1 | 5/16 | | 1.00 | 1.06 | 1.56 | .14 | 3.24 | Purple | P54 | 15 | 54 | 1 5/8 | 10 |
| LCC4/0-38DWH-X | 1 | 3/8 | | 1.00 | 1.06 | 1.56 | .14 | 3.31 | Purple | P54 | 15 | 54 | 1 5/8 | 10 |
| LCC4/0-38WH-X | 1 | 3/8 | | 1.75 | 1.06 | 1.56 | .14 | 4.06 | Purple | P54 | 15 | 54 | 1 5/8 | 10 |
| LCC4/0-12DWH-X | 1 | 1/2 | | 1.00 | 1.06 | 1.56 | .14 | 3.54 | Purple | P54 | 15 | 54 | 1 5/8 | 10 |
| LCC4/0-12WH-X | 1 | 1/2 | 1.75 | 1.06 | 1.56 | .14 | 4.45 | Purple | P54 | 15 | 54 | 1 5/8 | 10 | |

‡See pages D3.58 – D3.61 for tool and die information.

**Consult cable manufacturer for voltage stress relief instructions with applications greater than 2000 V.

◆NEMA hole sizes and spacing.

Table continues on page D2.52

A.
System
Overview



Code Conductor, Two-Hole, Long Barrel with Window Lug, 45° Angle (continued)

B1.
Cable Ties

B2.
Cable
Accessories

B3.
Stainless
Steel Ties

C1.
Wiring
Duct

C2.
Surface
Raceway

C3.
Abrasion
Protection

C4.
Cable
Management

D1.
Terminals

D2.
Power
Connectors

D3.
Grounding
Connectors

E1.
Labeling
Systems

E2.
Labels

E3.
Pre-Printed
& Write-On
Markers

E4.
Permanent
Identification

E5.
Lockout/
Tagout
& Safety
Solutions

F.
Index

| Part Number | Figure No. | Copper Conductor Size | Stud Hole Size (In.) | Stud Hole Spacing (In.) | Figure Dimensions (In.) | | | | PANDUIT Color Code | PANDUIT Die Index No.‡ | Burndy Die Index No.‡ | T&B Die Index No.‡ | Wire Strip Length (In.) | Std. Pkg. Qty. |
|-----------------|------------|-----------------------|----------------------|-------------------------|-------------------------|------|-----|------|--------------------|------------------------|-----------------------|--------------------|-------------------------|----------------|
| | | | | | W | B | T | L | | | | | | |
| LCC250-56DWH-X | 1 | 250 kcmil | 5/16 | 1.00 | 1.17 | 1.61 | .14 | 3.31 | Yellow | P62 | 16 | 62 | 1 11/16 | 10 |
| LCC250-38DWH-X | 1 | | 3/8 | 1.00 | 1.17 | 1.61 | .14 | 3.38 | Yellow | P62 | 16 | 62 | 1 11/16 | 10 |
| LCC250-12DWH-X | 1 | | 1/2 | 1.00 | 1.17 | 1.61 | .14 | 3.61 | Yellow | P62 | 16 | 62 | 1 11/16 | 10 |
| ◆ LCC250-12WH-X | 1 | 300 kcmil | 1/2 | 1.75 | 1.17 | 1.61 | .14 | 4.52 | Yellow | P62 | 16 | 62 | 1 11/16 | 10 |
| LCC300-38DWH-X | 1 | | 3/8 | 1.00 | 1.19 | 2.24 | .16 | 3.93 | White | P66 | 17 | 66 | 2 5/16 | 10 |
| ◆ LCC300-12WH-X | 1 | | 1/2 | 1.75 | 1.19 | 2.24 | .16 | 5.11 | White | P66 | 17 | 66 | 2 5/16 | 10 |
| LCC350-14BWH-X | 1 | 350 kcmil | 1/4 | .75 | 1.28 | 2.24 | .17 | 3.48 | Red | P71 | 18 | 71 | 2 5/16 | 10 |
| LCC350-38DWH-X | 1 | | 3/8 | 1.00 | 1.28 | 2.24 | .17 | 3.96 | Red | P71 | 18 | 71 | 2 5/16 | 10 |
| ◆ LCC350-12WH-X | 1 | | 1/2 | 1.75 | 1.28 | 2.24 | .17 | 5.14 | Red | P71 | 18 | 71 | 2 5/16 | 10 |
| LCC400-14BWH-6 | 1 | 400 kcmil | 1/4 | .75 | 1.39 | 2.30 | .18 | 3.59 | Blue | P76 | 19 | 76 | 2 3/8 | 6 |
| LCC400-38DWH-6 | 1 | | 3/8 | 1.00 | 1.39 | 2.30 | .18 | 4.07 | Blue | P76 | 19 | 76 | 2 3/8 | 6 |
| ◆ LCC400-12WH-6 | 1 | | 1/2 | 1.75 | 1.28 | 2.30 | .17 | 5.24 | Blue | P76 | 19 | 76 | 2 3/8 | 6 |
| LCC500-14BWH-6 | 1 | 500 kcmil | 1/4 | .75 | 1.54 | 2.50 | .22 | 3.80 | Brown | P87 | 20 | 87 | 2 9/16 | 6 |
| LCC500-38DWH-6 | 1 | | 3/8 | 1.00 | 1.54 | 2.50 | .22 | 4.29 | Brown | P87 | 20 | 87 | 2 9/16 | 6 |
| ◆ LCC500-12WH-6 | 1 | | 1/2 | 1.75 | 1.54 | 2.50 | .22 | 5.46 | Brown | P87 | 20 | 87 | 2 9/16 | 6 |
| LCC600-38DWH-6 | 1 | 600 kcmil | 3/8 | 1.00 | 1.70 | 2.69 | .26 | 4.47 | Green | P94 | 22 | 94 | 2 3/4 | 6 |
| ◆ LCC600-12WH-6 | 1 | | 1/2 | 1.75 | 1.70 | 2.69 | .26 | 5.65 | Green | P94 | 22 | 94 | 2 3/4 | 6 |

‡See pages D3.58 – D3.61 for tool and die information.

**Consult cable manufacturer for voltage stress relief instructions with applications greater than 2000 V.

◆NEMA hole sizes and spacing.



Code Conductor, Two-Hole, Long Barrel with Window Lug, 90° Angle

For Use with Stranded Copper Conductors

Type LCC-WF

- Long barrel maximizes number of crimps and provides premium wire pull-out strength and electrical performance
- Inspection window to visually assure full conductor insertion
- Color-coded barrels marked with *PANDUIT* and specified competitor die index numbers for proper crimp die selection
- Tin-plated to inhibit corrosion
- UL Listed and CSA Certified to 35 KV** and temperature rated to 90°C when crimped with *PANDUIT* and specified competitor crimping tools and dies
- UL Listed and CSA Certified for wide wire range-taking capability when crimped with *PANDUIT*® *UNI-DIE*™ Dieless Crimping Tools‡
- **Tested by Telcordia – meets NEBS Level 3**
- Meets J-STD-607-A and TIA-942 requirements for network systems grounding applications
- Available with NEMA hole sizes and spacing

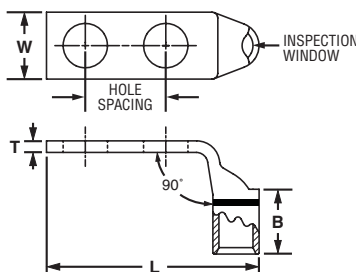

Figure 1

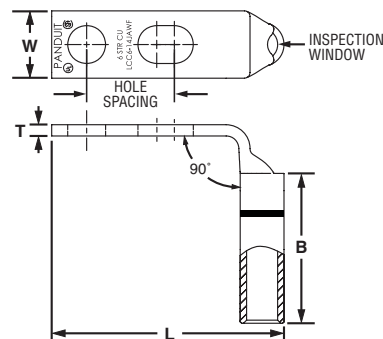

Figure 2: Slotted

| Part Number | Figure No. | Copper Conductor Size | Stud Hole Size (In.) | Stud Hole Spacing (In.) | Figure Dimensions (In.) | | | | PANDUIT Color Code | PANDUIT Die Index No.‡ | Burdny Die Index No.‡ | T&B Die Index No.‡ | Wire Strip Length (In.) | Std. Pkg. Qty. |
|-----------------|------------|-----------------------|----------------------|-------------------------|-------------------------|------|------|------|--------------------|------------------------|-----------------------|--------------------|-------------------------|----------------|
| | | | | | W | B | T | L | | | | | | |
| LCC10-14JAWF-L* | 2 | #14 – 10 | 1/4 | .50 – .63 | .42 | .53 | .05 | 1.56 | — | — | — | — | 9/16 | 50 |
| LCC10-14AWF-L* | 1 | AWG STR, | 1/4 | .63 | .42 | .53 | .05 | 1.56 | — | — | — | — | 9/16 | 50 |
| LCC10-14BWF-L* | 1 | #12 – 10 AWG SOL | 1/4 | .75 | .42 | .53 | .05 | 1.69 | — | — | — | — | 9/16 | 50 |
| LCC8-10AWF-L | 1 | #8 AWG | #10 | .63 | .41 | .70 | .08 | 1.53 | Red | P21 | 49 | 21 | 3/4 | 50 |
| LCC8-10BWF-L | 1 | | #10 | .75 | .41 | .70 | .08 | 1.65 | Red | P21 | 49 | 21 | 3/4 | 50 |
| LCC8-14AWF-L | 1 | | 1/4 | .63 | .48 | .70 | .07 | 1.61 | Red | P21 | 49 | 21 | 3/4 | 50 |
| LCC8-14BWF-L | 1 | | 1/4 | .75 | .48 | .70 | .07 | 1.74 | Red | P21 | 49 | 21 | 3/4 | 50 |
| LCC8-14DWF-L | 1 | | 1/4 | 1.00 | .48 | .70 | .07 | 1.99 | Red | P21 | 49 | 21 | 3/4 | 50 |
| LCC8-38DWF-L | 1 | | 3/8 | 1.00 | .60 | .70 | .05 | 2.21 | Red | P21 | 49 | 21 | 3/4 | 50 |
| LCC6-10AWF-L | 1 | #6 AWG | #10 | .63 | .46 | 1.07 | .08 | 1.57 | Blue | P24 | 7 | 24 | 1 1/8 | 50 |
| LCC6-10BWF-L | 1 | | #10 | .75 | .46 | 1.07 | .08 | 1.69 | Blue | P24 | 7 | 24 | 1 1/8 | 50 |
| LCC6-14JWF-L | 1 | | 1/4 | .50 | .48 | 1.07 | .08 | 1.53 | Blue | P24 | 7 | 24 | 1 1/8 | 50 |
| LCC6-14AWF-L | 1 | | 1/4 | .63 | .48 | 1.07 | .08 | 1.66 | Blue | P24 | 7 | 24 | 1 1/8 | 50 |
| LCC6-14JAWF-L | 2 | | 1/4 | .50 – .63 | .48 | 1.07 | .08 | 1.66 | Blue | P24 | 7 | 24 | 1 1/8 | 50 |
| LCC6-14BWF-L | 1 | | 1/4 | .75 | .48 | 1.07 | .08 | 1.78 | Blue | P24 | 7 | 24 | 1 1/8 | 50 |
| LCC6-14DWF-L | 1 | | 1/4 | 1.00 | .48 | 1.07 | .08 | 2.03 | Blue | P24 | 7 | 24 | 1 1/8 | 50 |
| LCC6-14EWF-L | 1 | | 1/4 | 1.25 | .48 | 1.07 | .08 | 2.28 | Blue | P24 | 7 | 24 | 1 1/8 | 50 |
| LCC6-56BWF-L | 1 | | 5/16 | .75 | .56 | 1.07 | .07 | 1.90 | Blue | P24 | 7 | 24 | 1 1/8 | 50 |
| LCC6-38BWF-L | 1 | | 3/8 | .75 | .62 | 1.07 | .06 | 2.00 | Blue | P24 | 7 | 24 | 1 1/8 | 50 |
| LCC6-38CWF-L | 1 | 3/8 | .88 | .62 | 1.07 | .06 | 2.13 | Blue | P24 | 7 | 24 | 1 1/8 | 50 | |
| LCC6-38DWF-L | 1 | 3/8 | 1.00 | .62 | 1.07 | .06 | 2.25 | Blue | P24 | 7 | 24 | 1 1/8 | 50 | |

‡See pages D3.58 – D3.61 for tool and die information.

*Not tested to NEBS Level 3 requirements.

**Consult cable manufacturer for voltage stress relief instructions with applications greater than 2000 V.

Table continues on pages D2.54 — D2.55

- A. System Overview
- B1. Cable Ties
- B2. Cable Accessories
- B3. Stainless Steel Ties
- C1. Wiring Duct
- C2. Surface Raceway
- C3. Abrasion Protection
- C4. Cable Management
- D1. Terminals
- D2. Power Connectors
- D3. Grounding Connectors
- E1. Labeling Systems
- E2. Labels
- E3. Pre-Printed & Write-On Markers
- E4. Permanent Identification
- E5. Lockout/Tagout & Safety Solutions
- F. Index

PANDUIT® ELECTRICAL SOLUTIONS

A.
System
Overview



Code Conductor, Two-Hole, Long Barrel with Window Lug, 90° Angle (continued)

B1.
Cable Ties

B2.
Cable
Accessories

B3.
Stainless
Steel Ties

C1.
Wiring
Duct

C2.
Surface
Raceway

C3.
Abrasion
Protection

C4.
Cable
Management

D1.
Terminals

D2.
Power
Connectors

D3.
Grounding
Connectors

E1.
Labeling
Systems

E2.
Labels

E3.
Pre-Printed
& Write-On
Markers

E4.
Permanent
Identification

E5.
Lockout/
Tagout
& Safety
Solutions

F.
Index

| Part Number | Figure No. | Copper Conductor Size | Stud Hole Size (In.) | Stud Hole Spacing (In.) | Figure Dimensions (In.) | | | | PANDUIT Color Code | PANDUIT Die Index No.‡ | Burdny Die Index No.‡ | T&B Die Index No.‡ | Wire Strip Length (In.) | Std. Pkg. Qty. |
|----------------|------------|----------------------------|----------------------|-------------------------|-------------------------|------|------|--------|--------------------|------------------------|-----------------------|--------------------|-------------------------|----------------|
| | | | | | W | B | T | L | | | | | | |
| LCC4-10AWF-L | 1 | #4 – 3 AWG STR, #2 AWG SOL | #10 | .63 | .55 | 1.05 | .09 | 1.65 | Gray | P29 | 8 | 29 | 1 1/8 | 50 |
| LCC4-10BWF-L | 1 | | #10 | .75 | .55 | 1.05 | .09 | 1.78 | Gray | P29 | 8 | 29 | 1 1/8 | 50 |
| LCC4-14AWF-L | 1 | | 1/4 | .63 | .55 | 1.05 | .09 | 1.74 | Gray | P29 | 8 | 29 | 1 1/8 | 50 |
| LCC4-14BWF-L | 1 | | 1/4 | .75 | .55 | 1.05 | .09 | 1.87 | Gray | P29 | 8 | 29 | 1 1/8 | 50 |
| LCC4-38DWF-L | 1 | #2 AWG | 3/8 | 1.00 | .62 | 1.05 | .08 | 2.34 | Gray | P29 | 8 | 29 | 1 1/8 | 50 |
| LCC2-10AWF-Q | 1 | | #10 | .63 | .60 | 1.16 | .10 | 1.76 | Brown | P33 | 10 | 33 | 1 1/4 | 25 |
| LCC2-10BWF-Q | 1 | | #10 | .75 | .60 | 1.16 | .10 | 1.89 | Brown | P33 | 10 | 33 | 1 1/4 | 25 |
| LCC2-14AWF-Q | 1 | | 1/4 | .63 | .60 | 1.16 | .10 | 1.86 | Brown | P33 | 10 | 33 | 1 1/4 | 25 |
| LCC2-14BWF-Q | 1 | | 1/4 | .75 | .60 | 1.16 | .10 | 1.99 | Brown | P33 | 10 | 33 | 1 1/4 | 25 |
| LCC2-14DWF-Q | 1 | | 1/4 | 1.00 | .60 | 1.16 | .10 | 2.24 | Brown | P33 | 10 | 33 | 1 1/4 | 25 |
| LCC2-56BWF-Q | 1 | | 5/16 | .75 | .66 | 1.16 | .10 | 2.11 | Brown | P33 | 10 | 33 | 1 1/4 | 25 |
| LCC2-56CWF-Q | 1 | | 5/16 | .88 | .66 | 1.16 | .10 | 2.24 | Brown | P33 | 10 | 33 | 1 1/4 | 25 |
| LCC2-38BWF-Q | 1 | | 3/8 | .75 | .66 | 1.16 | .10 | 2.19 | Brown | P33 | 10 | 33 | 1 1/4 | 25 |
| LCC2-38CWF-Q | 1 | | 3/8 | .88 | .66 | 1.16 | .10 | 2.31 | Brown | P33 | 10 | 33 | 1 1/4 | 25 |
| LCC2-38DWF-Q | 1 | | 3/8 | 1.00 | .66 | 1.16 | .10 | 2.44 | Brown | P33 | 10 | 33 | 1 1/4 | 25 |
| LCC2-38WF-Q | 1 | | 3/8 | 1.75 | .66 | 1.16 | .10 | 3.19 | Brown | P33 | 10 | 33 | 1 1/4 | 25 |
| LCC2-12WF-Q | 1 | 1/2 | 1.75 | .75 | 1.16 | .08 | 3.61 | Brown | P33 | 10 | 33 | 1 1/4 | 25 | |
| LCC1-14AWF-E | 1 | #1 AWG | 1/4 | .63 | .70 | 1.36 | .11 | 1.94 | Green | P37 | 11 | 37 | 1 7/16 | 20 |
| LCC1-14BWF-E | 1 | | 1/4 | .75 | .70 | 1.36 | .11 | 2.06 | Green | P37 | 11 | 37 | 1 7/16 | 20 |
| LCC1-56BWF-E | 1 | | 5/16 | .75 | .70 | 1.36 | .11 | 2.19 | Green | P37 | 11 | 37 | 1 7/16 | 20 |
| LCC1-56CWF-E | 1 | | 5/16 | .88 | .70 | 1.36 | .11 | 2.31 | Green | P37 | 11 | 37 | 1 7/16 | 20 |
| LCC1-38DWF-E | 1 | | 3/8 | 1.00 | .70 | 1.36 | .11 | 2.51 | Green | P37 | 11 | 37 | 1 7/16 | 20 |
| LCC1-12WF-E | 1 | | 1/2 | 1.75 | .75 | 1.36 | .09 | 3.68 | Green | P37 | 11 | 37 | 1 7/16 | 20 |
| LCC1/0-14AWF-X | 1 | | 1/4 | .63 | .76 | 1.44 | .12 | 2.08 | Pink | P42 | 12 | 42 | 1 1/2 | 10 |
| LCC1/0-14BWF-X | 1 | | 1/4 | .75 | .76 | 1.44 | .12 | 2.20 | Pink | P42 | 12 | 42 | 1 1/2 | 10 |
| LCC1/0-14DWF-X | 1 | 1/0 AWG | 1/4 | 1.00 | .76 | 1.44 | .12 | 2.45 | Pink | P42 | 12 | 42 | 1 1/2 | 10 |
| LCC1/0-38DWF-X | 1 | | 3/8 | 1.00 | .76 | 1.44 | .12 | 2.58 | Pink | P42 | 12 | 42 | 1 1/2 | 10 |
| LCC1/0-38WF-X | 1 | | 3/8 | 1.75 | .76 | 1.44 | .12 | 3.33 | Pink | P42 | 12 | 42 | 1 1/2 | 10 |
| LCC1/0-12DWF-X | 1 | | 1/2 | 1.00 | .80 | 1.44 | .12 | 2.85 | Pink | P42 | 12 | 42 | 1 1/2 | 10 |
| LCC1/0-12WF-X | 1 | 1/2 | 1.75 | .80 | 1.44 | .12 | 3.75 | Pink | P42 | 12 | 42 | 1 1/2 | 10 | |
| LCC2/0-14AWF-X | 1 | 2/0 AWG | 1/4 | .63 | .85 | 1.50 | .13 | 2.22 | Black | P45 | 13 | 45 | 1 9/16 | 10 |
| LCC2/0-14BWF-X | 1 | | 1/4 | .75 | .85 | 1.50 | .13 | 2.34 | Black | P45 | 13 | 45 | 1 9/16 | 10 |
| LCC2/0-56DWF-X | 1 | | 5/16 | 1.00 | .85 | 1.50 | .13 | 2.59 | Black | P45 | 13 | 45 | 1 9/16 | 10 |
| LCC2/0-38DWF-X | 1 | | 3/8 | 1.00 | .85 | 1.50 | .13 | 2.66 | Black | P45 | 13 | 45 | 1 9/16 | 10 |
| LCC2/0-12DWF-X | 1 | | 1/2 | 1.00 | .85 | 1.50 | .13 | 2.91 | Black | P45 | 13 | 45 | 1 9/16 | 10 |
| LCC2/0-12WF-X | 1 | | 1/2 | 1.75 | .85 | 1.50 | .13 | 3.82 | Black | P45 | 13 | 45 | 1 9/16 | 10 |
| LCC3/0-14BWF-X | 1 | 3/0 AWG | 1/4 | .75 | .96 | 1.50 | .13 | 2.42 | Orange | P50 | 14 | 50 | 1 9/16 | 10 |
| LCC3/0-56DWF-X | 1 | | 5/16 | 1.00 | .96 | 1.50 | .13 | 2.67 | Orange | P50 | 14 | 50 | 1 9/16 | 10 |
| LCC3/0-38DWF-X | 1 | | 3/8 | 1.00 | .96 | 1.50 | .13 | 2.73 | Orange | P50 | 14 | 50 | 1 9/16 | 10 |
| LCC3/0-12DWF-X | 1 | | 1/2 | 1.00 | .96 | 1.50 | .13 | 2.98 | Orange | P50 | 14 | 50 | 1 9/16 | 10 |
| LCC3/0-12WF-X | 1 | 1/2 | 1.75 | .96 | 1.50 | .13 | 3.89 | Orange | P50 | 14 | 50 | 1 9/16 | 10 | |
| LCC4/0-14AWF-X | 1 | 4/0 AWG | 1/4 | .63 | 1.06 | 1.56 | .14 | 2.38 | Purple | P54 | 15 | 54 | 1 5/8 | 10 |
| LCC4/0-14BWF-X | 1 | | 1/4 | .75 | 1.06 | 1.56 | .14 | 2.50 | Purple | P54 | 15 | 54 | 1 5/8 | 10 |
| LCC4/0-56DWF-X | 1 | | 5/16 | 1.00 | 1.06 | 1.56 | .14 | 2.77 | Purple | P54 | 15 | 54 | 1 5/8 | 10 |
| LCC4/0-38DWF-X | 1 | | 3/8 | 1.00 | 1.06 | 1.56 | .14 | 2.84 | Purple | P54 | 15 | 54 | 1 5/8 | 10 |
| LCC4/0-38WF-X | 1 | | 3/8 | 1.75 | 1.06 | 1.56 | .14 | 3.59 | Purple | P54 | 15 | 54 | 1 5/8 | 10 |
| LCC4/0-12DWF-X | 1 | | 1/2 | 1.00 | 1.06 | 1.56 | .14 | 3.07 | Purple | P54 | 15 | 54 | 1 5/8 | 10 |
| LCC4/0-12WF-X | 1 | | 1/2 | 1.75 | 1.06 | 1.56 | .14 | 3.98 | Purple | P54 | 15 | 54 | 1 5/8 | 10 |

‡See pages D3.58 – D3.61 for tool and die information.

**Consult cable manufacturer for voltage stress relief instructions with applications greater than 2000 V.

◆NEMA hole sizes and spacing.



Code Conductor, Two-Hole, Long Barrel with Window Lug, 90° Angle (continued)

| Part Number | Figure No. | Copper Conductor Size | Stud Hole Size (In.) | Stud Hole Spacing (In.) | Figure Dimensions (In.) | | | | PANDUIT Color Code | PANDUIT Die Index No.‡ | Bumdy Die Index No.‡ | T&B Die Index No.‡ | Wire Strip Length (In.) | Std. Pkg. Qty. |
|----------------|------------|-----------------------|----------------------|-------------------------|-------------------------|------|-----|------|--------------------|------------------------|----------------------|--------------------|-------------------------|----------------|
| | | | | | W | B | T | L | | | | | | |
| LCC250-56DWF-X | 1 | 250 kcmil | 5/16 | 1.00 | 1.17 | 1.61 | .14 | 2.83 | Yellow | P62 | 16 | 62 | 1 11/16 | 10 |
| LCC250-38DWF-X | 1 | | 3/8 | 1.00 | 1.17 | 1.61 | .14 | 2.90 | Yellow | P62 | 16 | 62 | 1 11/16 | 10 |
| LCC250-12DWF-X | 1 | | 1/2 | 1.00 | 1.17 | 1.61 | .14 | 3.13 | Yellow | P62 | 16 | 62 | 1 11/16 | 10 |
| LCC250-12WF-X | 1 | | 1/2 | 1.75 | 1.17 | 1.61 | .14 | 4.04 | Yellow | P62 | 16 | 62 | 1 11/16 | 10 |
| LCC300-38DWF-X | 1 | 300 kcmil | 3/8 | 1.00 | 1.19 | 2.24 | .16 | 2.88 | White | P66 | 17 | 66 | 2 5/16 | 10 |
| LCC300-12WF-X | 1 | | 1/2 | 1.75 | 1.19 | 2.24 | .16 | 4.06 | White | P66 | 17 | 66 | 2 5/16 | 10 |
| LCC350-14BWF-X | 1 | 350 kcmil | 1/4 | .75 | 1.28 | 2.24 | .17 | 2.46 | Red | P71 | 18 | 71 | 2 5/16 | 10 |
| LCC350-38DWF-X | 1 | | 3/8 | 1.00 | 1.28 | 2.24 | .17 | 2.94 | Red | P71 | 18 | 71 | 2 5/16 | 10 |
| LCC350-12WF-X | 1 | | 1/2 | 1.75 | 1.28 | 2.24 | .17 | 4.12 | Red | P71 | 18 | 71 | 2 5/16 | 10 |
| LCC400-14BWF-6 | 1 | 400 kcmil | 1/4 | .75 | 1.39 | 2.30 | .18 | 2.54 | Blue | P76 | 19 | 76 | 2 3/8 | 6 |
| LCC400-38DWF-6 | 1 | | 3/8 | 1.00 | 1.39 | 2.30 | .18 | 3.02 | Blue | P76 | 19 | 76 | 2 3/8 | 6 |
| LCC400-12WF-6 | 1 | | 1/2 | 1.75 | 1.39 | 2.30 | .18 | 4.20 | Blue | P76 | 19 | 76 | 2 3/8 | 6 |
| LCC500-14BWF-6 | 1 | 500 kcmil | 1/4 | .75 | 1.54 | 2.50 | .22 | 2.65 | Brown | P87 | 20 | 87 | 2 9/16 | 6 |
| LCC500-38DWF-6 | 1 | | 3/8 | 1.00 | 1.54 | 2.50 | .22 | 3.13 | Brown | P87 | 20 | 87 | 2 9/16 | 6 |
| LCC500-12WF-6 | 1 | | 1/2 | 1.75 | 1.54 | 2.50 | .22 | 4.31 | Brown | P87 | 20 | 87 | 2 9/16 | 6 |
| LCC600-38DWF-6 | 1 | 600 kcmil | 3/8 | 1.00 | 1.70 | 2.69 | .26 | 3.26 | Green | P94 | 22 | 94 | 2 3/4 | 6 |
| LCC600-12WF-6 | 1 | | 1/2 | 1.75 | 1.70 | 2.69 | .26 | 4.44 | Green | P94 | 22 | 94 | 2 3/4 | 6 |

‡See pages D3.58 – D3.61 for tool and die information.

**Consult cable manufacturer for voltage stress relief instructions with applications greater than 2000 V.

◆NEMA hole sizes and spacing.



Code Conductor, Two-Hole, Long Barrel with Window, Narrow Tongue Lug

For Use with Stranded Copper Conductors

Type LCCN-W

- Narrow tongue width for limited space applications
- Long barrel maximizes number of crimps and provides premium wire pull-out strength and electrical performance
- Inspection window to visually assure full conductor insertion
- Color-coded barrels marked with PANDUIT and specified competitor die index numbers for proper crimp die selection
- Tin-plated to inhibit corrosion
- UL Listed and CSA Certified to 35 KV** and temperature rated to 90°C when crimped with PANDUIT and specified competitor crimping tools and dies
- UL Listed and CSA Certified for wide wire range-taking capability when crimped with PANDUIT® UNI-DIE™ Dieless Crimping Tools‡
- **Tested by Telcordia – meets NEBS Level 3**
- Meets J-STD-607-A and TIA-942 requirements for network systems grounding applications
- Available with NEMA hole sizes and spacing

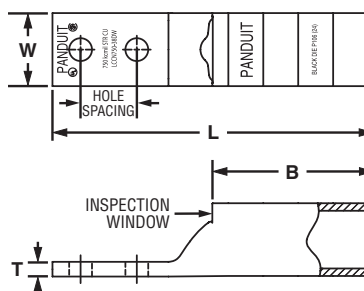

| Part Number | Copper Conductor Size | Stud Hole Size (In.) | Stud Hole Spacing (In.) | Figure Dimensions (In.) | | | | PANDUIT Color Code | PANDUIT Die Index No.‡ | Bumdy Die Index No.‡ | T&B Die Index No.‡ | Wire Strip Length (In.) | Std. Pkg. Qty. |
|----------------|-----------------------|----------------------|-------------------------|-------------------------|------|-----|------|--------------------|------------------------|----------------------|--------------------|-------------------------|----------------|
| | | | | W | B | T | L | | | | | | |
| LCCN750-38DW-6 | 750 kcmil | 3/8 | 1.00 | 1.30 | 2.88 | .28 | 5.72 | Black | P106 | 24 | 106 | 2 15/16 | 6 |
| LCCN750-12W-6 | 750 kcmil | 1/2 | 1.75 | 1.30 | 2.88 | .28 | 6.66 | Black | P106 | 24 | 106 | 2 15/16 | 6 |

‡See pages D3.58 – D3.61 for tool and die information.

**Consult cable manufacturer for voltage stress relief instructions with applications greater than 2000 V.

◆NEMA hole sizes and spacing.

A. System Overview

B1. Cable Ties

B2. Cable Accessories

B3. Stainless Steel Ties

C1. Wiring Duct

C2. Surface Raceway

C3. Abrasion Protection

C4. Cable Management

D1. Terminals

D2. Power Connectors

D3. Grounding Connectors

E1. Labeling Systems

E2. Labels

E3. Pre-Printed & Write-On Markers

E4. Permanent Identification

E5. Lockout/Tagout & Safety Solutions

F. Index

A. System Overview



Code Conductor, Two-Hole, Long Barrel with Corona Relief Taper Lug

B1. Cable Ties

To Facilitate Use with Stranded Copper Conductors in Applications of 5000 V or More

Type LCCH

- Externally chamfered barrel end inhibits Corona effect when used in high voltage applications
- Long barrel maximizes number of crimps and provides premium wire pull-out strength and electrical performance
- Color-coded barrels marked with *PANDUIT* and specified competitor die index numbers for proper crimp die selection
- Enclosed barrel prevents corrosive material from entering barrel when used in harsh environments
- Tin-plated to inhibit corrosion
- UL Listed and CSA Certified to 35 KV** and temperature rated to 90°C when crimped with *PANDUIT* and specified competitor crimping tools and dies
- Available with NEMA hole sizes and spacing

C1. Wiring Duct



C2. Surface Raceway



Corona Relief Taper

C3. Abrasion Protection

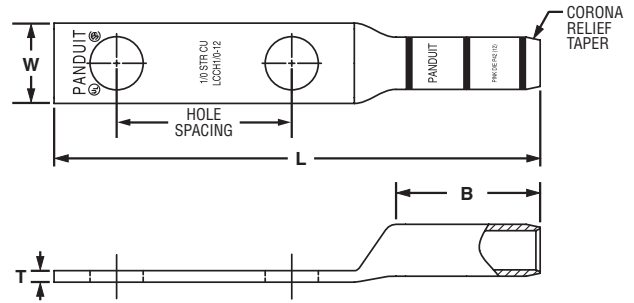

C4. Cable Management

D1. Terminals

D2. Power Connectors

D3. Grounding Connectors

| Part Number | Copper Conductor Size | Stud Hole Size (In.) | Stud Hole Spacing (In.) | Figure Dimensions (In.) | | | | PANDUIT Color Code | PANDUIT Die Index No.‡ | Burndy Die Index No.‡ | T&B Die Index No.‡ | Wire Strip Length (In.) | Std. Pkg. Qty. |
|-----------------|-----------------------|----------------------|-------------------------|-------------------------|------|-----|------|--------------------|------------------------|-----------------------|--------------------|-------------------------|----------------|
| | | | | W | B | T | L | | | | | | |
| LCCH1/0-12-X | 1/0 AWG | 1/2 | 1.75 | .80 | 1.44 | .12 | 4.86 | Pink | P42 | 12 | 42 | 1 1/2 | 10 |
| LCCH2/0-12-X | 2/0 AWG | 1/2 | 1.75 | .85 | 1.50 | .13 | 4.98 | Black | P45 | 13 | 45 | 1 9/16 | 10 |
| LCCH3/0-12-X | 3/0 AWG | 1/2 | 1.75 | .96 | 1.50 | .13 | 5.03 | Orange | P50 | 14 | 50 | 1 9/16 | 10 |
| ◆ LCCH4/0-12-X | 4/0 AWG | 1/2 | 1.75 | 1.06 | 1.56 | .14 | 5.13 | Purple | P54 | 15 | 54 | 1 5/8 | 10 |
| ◆ LCCH250-12-X | 250 kcmil | 1/2 | 1.75 | 1.17 | 1.61 | .14 | 5.23 | Yellow | P62 | 16 | 62 | 1 1/16 | 10 |
| ◆ LCCH300-12-X | 300 kcmil | 1/2 | 1.75 | 1.19 | 2.24 | .16 | 5.94 | White | P66 | 17 | 66 | 2 5/16 | 10 |
| ◆ LCCH350-12-X | 350 kcmil | 1/2 | 1.75 | 1.28 | 2.24 | .17 | 5.99 | Red | P71 | 18 | 71 | 2 5/16 | 10 |
| ◆ LCCH400-12-6 | 400 kcmil | 1/2 | 1.75 | 1.39 | 2.30 | .18 | 6.10 | Blue | P76 | 19 | 76 | 2 3/8 | 6 |
| ◆ LCCH500-12-6 | 500 kcmil | 1/2 | 1.75 | 1.54 | 2.50 | .22 | 6.36 | Brown | P87 | 20 | 87 | 2 9/16 | 6 |
| ◆ LCCH600-12-6 | 600 kcmil | 1/2 | 1.75 | 1.70 | 2.69 | .26 | 6.63 | Green | P94 | 22 | 94 | 2 3/4 | 6 |
| ◆ LCCH750-12-6 | 750 kcmil | 1/2 | 1.75 | 1.89 | 2.88 | .26 | 7.04 | Black | P106 | 24 | 106 | 2 15/16 | 6 |
| ◆ LCCH1000-12-3 | 1000 kcmil | 1/2 | 1.75 | 2.17 | 3.00 | .32 | 7.29 | White | P125 | 27 | 125 | 3 1/16 | 3 |

‡See pages D3.62, D3.63 for tool and die information.

**Consult cable manufacturer for voltage stress relief instructions with applications greater than 2000 V.

◆NEMA hole sizes and spacing.

E2. Labels

E3. Pre-Printed & Write-On Markers

E4. Permanent Identification

E5. Lockout/Tagout & Safety Solutions

F. Index



Code Conductor, Blank Tongue, Long Barrel Lug

For Use with Stranded Copper Conductors

Type LCC-00

- Long barrel maximizes number of crimps and provides premium wire pull-out strength and electrical performance
- Color-coded barrels marked with *PANDUIT* and specified competitor die index numbers for proper crimp die selection
- Enclosed barrel prevents corrosive material from entering barrel when used in harsh environments
- Tin-plated to inhibit corrosion
- UL Recognized and CSA Certified to 35 KV** and temperature rated to 90°C when crimped with *PANDUIT* and specified competitor crimping tools and dies

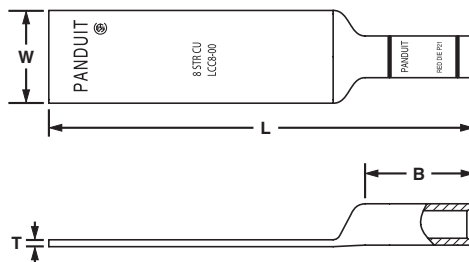

Figure 1

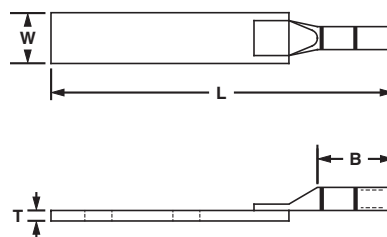

Figure 2: Two-Piece Brazed Tongue Construction

| Part Number | Figure No. | Copper Conductor Size | Figure Dimensions (In.) | | | | PANDUIT Color Code | PANDUIT Die Index No. | Burdny Die Index No.‡ | T&B Die Index No.‡ | Wire Strip Length (In.) | Std. Pkg. Qty. |
|--------------|------------|----------------------------|-------------------------|------|-----|------|--------------------|-----------------------|-----------------------|--------------------|-------------------------|----------------|
| | | | W | B | T | L | | | | | | |
| LCC8-00-L | 1 | #8 AWG | .60 | .70 | .05 | 2.75 | Red | P21 | 49 | 21 | 3/4 | 50 |
| LCC6-00-L | 2 | #6 AWG | .75 | 1.13 | .16 | 5.00 | Blue | P24 | 7 | 24 | 1 1/8 | 50 |
| LCC4-00-L | 2 | #4 – 3 AWG STR, #2 AWG SOL | .75 | 1.13 | .16 | 5.06 | Gray | P29 | 8 | 29 | 1 1/8 | 50 |
| LCC2-00-Q | 1 | #2 AWG | .75 | 1.16 | .08 | 4.51 | Brown | P33 | 10 | 33 | 1 1/4 | 25 |
| LCC1-00-E | 1 | #1 AWG | .75 | 1.36 | .09 | 4.74 | Green | P37 | 11 | 37 | 1 7/16 | 20 |
| LCC1/0-00-X | 1 | 1/0 AWG | .80 | 1.44 | .12 | 4.86 | Pink | P42 | 12 | 42 | 1 1/2 | 10 |
| LCC2/0-00-X | 1 | 2/0 AWG | .85 | 1.50 | .13 | 4.98 | Black | P45 | 13 | 45 | 1 9/16 | 10 |
| LCC3/0-00-X | 1 | 3/0 AWG | .96 | 1.50 | .13 | 5.03 | Orange | P50 | 14 | 50 | 1 9/16 | 10 |
| LCC4/0-00-X | 1 | 4/0 AWG | 1.06 | 1.56 | .14 | 5.13 | Purple | P54 | 15 | 54 | 1 5/8 | 10 |
| LCC250-00-X | 1 | 250 kcmil | 1.17 | 1.60 | .14 | 5.23 | Yellow | P62 | 16 | 62 | 1 11/16 | 10 |
| LCC300-00-X | 1 | 300 kcmil | 1.19 | 2.23 | .16 | 5.94 | White | P66 | 17 | 66 | 2 5/16 | 10 |
| LCC350-00-X | 1 | 350 kcmil | 1.28 | 2.23 | .17 | 5.99 | Red | P71 | 18 | 71 | 2 5/16 | 10 |
| LCC400-00-6 | 1 | 400 kcmil | 1.39 | 2.29 | .18 | 6.10 | Blue | P76 | 19 | 76 | 2 3/8 | 6 |
| LCC500-00-6 | 1 | 500 kcmil | 1.54 | 2.49 | .22 | 6.36 | Brown | P87 | 20 | 87 | 2 9/16 | 6 |
| LCC600-00-6 | 1 | 600 kcmil | 1.70 | 2.68 | .26 | 6.63 | Green | P94 | 22 | 94 | 2 3/4 | 6 |
| LCC750-00-6 | 1 | 750 kcmil | 1.89 | 2.87 | .26 | 7.04 | Black | P106 | 24 | 106 | 2 15/16 | 6 |
| LCC1000-00-3 | 1 | 1000 kcmil | 2.17 | 2.99 | .32 | 7.29 | White | P125 | 27 | 125 | 3 1/16 | 3 |

‡See pages D3.58 – D3.61 for tool and die information.

**Consult cable manufacturer for voltage stress relief instructions with applications greater than 2000 V.

A. System Overview

B1. Cable Ties

B2. Cable Accessories

B3. Stainless Steel Ties

C1. Wiring Duct

C2. Surface Raceway

C3. Abrasion Protection

C4. Cable Management

D1. Terminals

D2. Power Connectors

D3. Grounding Connectors

E1. Labeling Systems

E2. Labels

E3. Pre-Printed & Write-On Markers

E4. Permanent Identification

E5. Lockout/Tagout & Safety Solutions

F. Index

A. System Overview



Code Conductor, Blank Tongue, Long Barrel with Window Lug

B1. Cable Ties

For Use with Stranded Copper Conductors

Type LCC-00W

- Long barrel maximizes number of crimps and provides premium wire pull-out strength and electrical performance
- Inspection window to visually assure full conductor insertion
- Color-coded barrels marked with *PANDUIT* and specified competitor die index numbers for proper crimp die selection
- Enclosed barrel prevents corrosive material from entering barrel when used in harsh environments
- Tin-plated to inhibit corrosion
- UL Recognized and CSA Certified to 35 KV** and temperature rated to 90°C when crimped with *PANDUIT* and specified competitor crimping tools and dies

B2. Cable Accessories

B3. Stainless Steel Ties

C1. Wiring Duct

C2. Surface Raceway

C3. Abrasion Protection

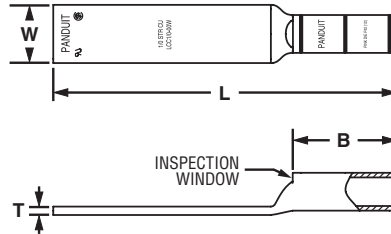

C4. Cable Management

| Part Number | Copper Conductor Size | Figure Dimensions (In.) | | | | PANDUIT Color Code | PANDUIT Die Index No.‡ | Burndy Die Index No.‡ | T&B Die Index No.‡ | Wire Strip Length (In.) | Std. Pkg. Qty. |
|--------------|-----------------------|-------------------------|------|-----|------|--------------------|------------------------|-----------------------|--------------------|-------------------------|----------------|
| | | W | B | T | L | | | | | | |
| LCC8-00W-L | #8 AWG | .60 | .70 | .05 | 2.70 | Red | P21 | 49 | 21 | 3/4 | 50 |
| LCC6-00W-L | #6 AWG | .62 | 1.07 | .06 | 3.08 | Blue | P24 | 7 | 24 | 1 1/8 | 50 |
| LCC4-00W-L | #4 AWG | .62 | 1.05 | .08 | 3.09 | Gray | P29 | 8 | 29 | 1 1/8 | 50 |
| LCC2-00W-Q | #2 AWG | .75 | 1.16 | .08 | 4.41 | Brown | P33 | 10 | 33 | 1 1/4 | 25 |
| LCC1-00W-E | #1 AWG | .75 | 1.36 | .09 | 4.63 | Green | P37 | 11 | 37 | 1 7/16 | 20 |
| LCC1/0-00W-X | 1/0 AWG | .80 | 1.44 | .12 | 4.74 | Pink | P42 | 12 | 42 | 1 1/2 | 10 |
| LCC2/0-00W-X | 2/0 AWG | .85 | 1.50 | .13 | 4.83 | Black | P45 | 13 | 45 | 1 9/16 | 10 |
| LCC3/0-00W-X | 3/0 AWG | .96 | 1.50 | .13 | 4.87 | Orange | P50 | 14 | 50 | 1 9/16 | 10 |
| LCC4/0-00W-X | 4/0 AWG | 1.06 | 1.56 | .14 | 4.95 | Purple | P54 | 15 | 54 | 1 5/8 | 10 |
| LCC250-00W-X | 250 kcmil | 1.17 | 1.61 | .14 | 5.04 | Yellow | P62 | 16 | 62 | 1 11/16 | 10 |
| LCC300-00W-X | 300 kcmil | 1.19 | 2.24 | .16 | 5.73 | White | P66 | 17 | 66 | 2 5/16 | 10 |
| LCC350-00W-X | 350 kcmil | 1.28 | 2.24 | .17 | 5.77 | Red | P71 | 18 | 71 | 2 5/16 | 10 |
| LCC400-00W-6 | 400 kcmil | 1.28 | 2.30 | .17 | 5.85 | Blue | P76 | 19 | 76 | 2 3/8 | 6 |
| LCC500-00W-6 | 500 kcmil | 1.54 | 2.50 | .22 | 6.13 | Brown | P87 | 20 | 87 | 2 9/16 | 6 |
| LCC600-00W-6 | 600 kcmil | 1.70 | 2.69 | .26 | 6.37 | Green | P94 | 22 | 94 | 2 3/4 | 6 |

D1. Terminals

D2. Power Connectors

D3. Grounding Connectors

E1. Labeling Systems

E2. Labels

E3. Pre-Printed & Write-On Markers

E4. Permanent Identification

E5. Lockout/Tagout & Safety Solutions

F. Index

‡See pages D3.58 – D3.61 for tool and die information.
 **Consult cable manufacturer for voltage stress relief instructions with applications greater than 2000 V.

UL LISTED CERTIFIED Code Conductor, Short Barrel, Butt Splice

For Use with Stranded Copper Conductors

Type SCSS

- Short barrel for limited space applications
- Color-coded barrels marked with *PANDUIT* and specified competitor die index numbers for proper crimp die selection
- Internal wire stops to prevent over-insertion of conductor
- Tin-plated to inhibit corrosion
- UL Listed and CSA Certified to 35 KV** and temperature rated to 90°C when crimped with *PANDUIT* and specified competitor crimping tools and dies
- **Tested by Telcordia – meets NEBS Level 3**

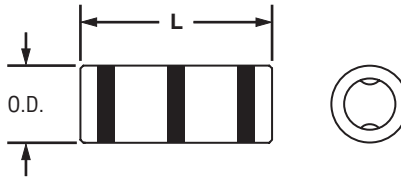

| Part Number | Copper Conductor Size | Figure Dimensions (In.) | | PANDUIT Color Code | PANDUIT Die Index No.‡ | Burdny Die Index No.‡ | T&B Die Index No.‡ | Wire Strip Length (In.) | Std. Pkg. Qty. |
|-------------|-----------------------|-------------------------|------|--------------------|------------------------|-----------------------|--------------------|-------------------------|----------------|
| | | Barrel O.D. | L | | | | | | |
| SCSS8-L | #8 AWG | .27 | 1.00 | Red | P21 | 49 | 21 | 7/16 | 50 |
| SCSS6-L | #6 AWG | .31 | 1.00 | Blue | P24 | 7 | 24 | 7/16 | 50 |
| SCSS4-L | #4 AWG | .38 | 1.00 | Gray | P29 | 8 | 29 | 7/16 | 50 |
| SCSS2-Q | #2 AWG | .42 | 1.25 | Brown | P33 | 10 | 33 | 9/16 | 25 |
| SCSS1-Q | #1 AWG | .46 | 1.44 | Green | P37 | 11 | 37 | 11/16 | 25 |
| SCSS1/0-X | 1/0 AWG | .52 | 1.44 | Pink | P42 | 12 | 42 | 11/16 | 10 |
| SCSS2/0-X | 2/0 AWG | .58 | 1.56 | Black | P45 | 13 | 45 | 3/4 | 10 |
| SCSS3/0-X | 3/0 AWG | .64 | 1.69 | Orange | P50 | 14 | 50 | 3/4 | 10 |
| SCSS4/0-X | 4/0 AWG | .71 | 1.81 | Purple | P54 | 15 | 54 | 13/16 | 10 |
| SCSS250-X | 250 kcmil | .77 | 2.19 | Yellow | P62 | 16 | 62 | 1 1/16 | 10 |

‡See pages D3.52, D3.53 for tool and die information.

**Consult cable manufacturer for voltage stress relief instructions with applications greater than 2000 V.

A. System Overview

B1. Cable Ties

B2. Cable Accessories

B3. Stainless Steel Ties

C1. Wiring Duct

C2. Surface Raceway

C3. Abrasion Protection

C4. Cable Management

D1. Terminals

D2. Power Connectors

D3. Grounding Connectors

E1. Labeling Systems

E2. Labels

E3. Pre-Printed & Write-On Markers

E4. Permanent Identification

E5. Lockout/Tagout & Safety Solutions

F. Index

A. System Overview



Code Conductor, Standard Barrel, Butt Splice

B1. Cable Ties

For Use with Stranded Copper Conductors

Type SCS

- Color-coded barrels marked with **PANDUIT** and specified competitor die index numbers for proper crimp die selection
- Internal wire stops to prevent over-insertion of conductor
- Tin-plated to inhibit corrosion
- UL Listed and CSA Certified to 35 KV** and temperature rated to 90°C when crimped with **PANDUIT** and specified competitor crimping tools and dies

- UL Listed and CSA Certified for wide wire range-taking capability when crimped with **PANDUIT® UNI-DIE™** Dieless Crimping Tools‡
- **Tested by Telcordia – meets NEBS Level 3**
- American Bureau of Shipping approved

B2. Cable Accessories

B3. Stainless Steel Ties

C1. Wiring Duct

C2. Surface Raceway

C3. Abrasion Protection

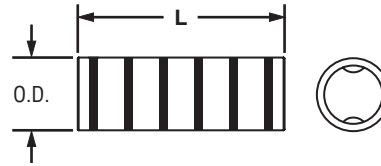

C4. Cable Management

| Part Number | Copper Conductor Size | Figure Dimensions (In.) | | PANDUIT Color Code | PANDUIT Die Index No.‡ | Burdny Die Index No.‡ | T&B Die Index No.‡ | Wire Strip Length (In.) | Std. Pkg. Qty. |
|------------------|-------------------------------|-------------------------|------|--------------------|------------------------|-----------------------|--------------------|-------------------------|----------------|
| | | Barrel O.D. | L | | | | | | |
| SCS8-L | #8 AWG | .27 | 1.50 | Red | P21 | 49 | 21 | 11/16 | 50 |
| SCS6-L | #6 AWG | .31 | 1.75 | Blue | P24 | 7 | 24 | 13/16 | 50 |
| SCS4-L | #4 – 3 AWG STR, #2 AWG SOL | .38 | 1.75 | Gray | P29 | 8 | 29 | 13/16 | 50 |
| SCS2-Q | #2 AWG | .42 | 1.87 | Brown | P33 | 10 | 33 | 7/8 | 25 |
| SCS1-E | #1 AWG | .47 | 1.87 | Green | P37 | 11 | 37 | 7/8 | 20 |
| SCS1/0-X | 1/0 AWG | .52 | 1.87 | Pink | P42 | 12 | 42 | 7/8 | 10 |
| SCS2/0-X | 2/0 AWG | .58 | 2.00 | Black | P45 | 13 | 45 | 15/16 | 10 |
| SCS3/0-X | 3/0 AWG | .64 | 2.12 | Orange | P50 | 14 | 50 | 1 | 10 |
| SCS4/0-X | 4/0 AWG | .71 | 2.12 | Purple | P54 | 15 | 54 | 1 | 10 |
| SCS250-X | 250 kcmil | .77 | 2.25 | Yellow | P62 | 16 | 62 | 1 1/16 | 10 |
| SCS300-X | 300 kcmil | .81 | 2.25 | White | P66 | 17 | 66 | 1 1/16 | 10 |
| SCS350-X | 350 kcmil | .87 | 2.37 | Red | P71 | 18 | 71 | 1 1/8 | 10 |
| SCS400-6 | 400 kcmil | .95 | 2.50 | Blue | P76 | 19 | 76 | 1 3/16 | 6 |
| SCS500-6 | 500 kcmil | 1.05 | 2.87 | Brown | P87 | 20 | 87 | 1 3/8 | 6 |
| SCS600-6 | 600 kcmil | 1.18 | 2.87 | Green | P94 | 22 | 94 | 1 3/8 | 6 |
| SCS750-6 | 750 kcmil | 1.29 | 3.37 | Black | P106 | 24 | 106 | 1 5/8 | 6 |
| SCS1000-3 | 1000 kcmil | 1.50 | 3.87 | White | P125 | 27 | 125 | 1 7/8 | 3 |

‡See pages D3.54 – D3.57 for tool and die information.

**Consult cable manufacturer for voltage stress relief instructions with applications greater than 2000 V.

E3. Pre-Printed & Write-On Markers

E4. Permanent Identification

E5. Lockout/Tagout & Safety Solutions

F. Index

UL LISTED CERTIFIED Code Conductor, Long Barrel, Butt Splice

For Use with Stranded Copper Conductors

Type SCL

- Long barrel maximizes the number of crimps and provides premium wire pull-out strength and electrical performance
- Color-coded barrels marked with *PANDUIT* and specified competitor die index numbers for proper crimp die selection
- Internal wire stops to prevent over-insertion of conductor
- Tin-plated to inhibit corrosion
- UL Listed and CSA Certified to 35 KV** and temperature rated to 90°C when crimped with *PANDUIT* and specified competitor crimping tools and dies
- UL Listed and CSA Certified for wide wire range-taking capability when crimped with *PANDUIT*® *UNI-DIE*™ Dieless Crimping Tools‡
- **Tested by Telcordia – meets NEBS Level 3**

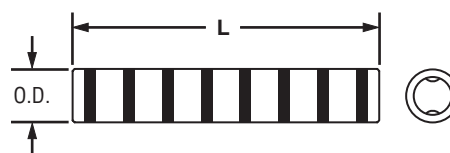

| Part Number | Copper Conductor Size | Figure Dimensions (In.) | | PANDUIT Color Code | PANDUIT Die Index No.‡ | Burndy Die Index No.‡ | T&B Die Index No.‡ | Wire Strip Length (In.) | Std. Pkg. Qty. |
|-------------|-------------------------------|-------------------------|------|--------------------|------------------------|-----------------------|--------------------|-------------------------|----------------|
| | | Barrel O.D. | L | | | | | | |
| SCL8-L | #8 AWG | .27 | 2.25 | Red | P21 | 49 | 21 | 1 1/16 | 50 |
| SCL6-L | #6 AWG | .31 | 2.38 | Blue | P24 | 7 | 24 | 1 1/8 | 50 |
| SCL4-L | #4 – 3 AWG STR, #2 AWG SOL | .38 | 2.38 | Gray | P29 | 8 | 29 | 1 1/8 | 50 |
| SCL2-Q | #2 AWG | .42 | 2.62 | Brown | P33 | 10 | 33 | 1 1/4 | 25 |
| SCL1-E | #1 AWG | .47 | 2.87 | Green | P37 | 11 | 37 | 1 3/8 | 20 |
| SCL1/0-X | 1/0 AWG | .52 | 2.87 | Pink | P42 | 12 | 42 | 1 3/8 | 10 |
| SCL2/0-X | 2/0 AWG | .58 | 3.13 | Black | P45 | 13 | 45 | 1 1/2 | 10 |
| SCL3/0-X | 3/0 AWG | .64 | 3.12 | Orange | P50 | 14 | 54 | 1 1/2 | 10 |
| SCL4/0-X | 4/0 AWG | .71 | 3.37 | Purple | P54 | 15 | 54 | 1 5/8 | 10 |
| SCL250-X | 250 kcmil | .77 | 3.38 | Yellow | P62 | 16 | 62 | 1 5/8 | 10 |
| SCL300-X | 300 kcmil | .81 | 4.12 | White | P66 | 17 | 66 | 2 | 10 |
| SCL350-X | 350 kcmil | .88 | 4.12 | Red | P71 | 18 | 71 | 2 | 10 |
| SCL400-6 | 400 kcmil | .95 | 4.37 | Blue | P76 | 19 | 76 | 2 1/8 | 6 |
| SCL500-6 | 500 kcmil | 1.06 | 4.62 | Brown | P87 | 20 | 87 | 2 1/4 | 6 |
| SCL600-6 | 600 kcmil | 1.19 | 5.50 | Green | P94 | 22 | 94 | 2 11/16 | 6 |
| SCL750-6 | 750 kcmil | 1.30 | 5.87 | Black | P106 | 24 | 106 | 2 7/8 | 6 |
| SCL1000-3 | 1000 kcmil | 1.50 | 6.12 | White | P125 | 27 | 125 | 3 | 3 |

‡See pages D3.58 – D3.61 for tool and die information.

**Consult cable manufacturer for voltage stress relief instructions with applications greater than 2000 V.

A. System Overview

B1. Cable Ties

B2. Cable Accessories

B3. Stainless Steel Ties

C1. Wiring Duct

C2. Surface Raceway

C3. Abrasion Protection

C4. Cable Management

D1. Terminals

D2. Power Connectors

D3. Grounding Connectors

E1. Labeling Systems

E2. Labels

E3. Pre-Printed & Write-On Markers

E4. Permanent Identification

E5. Lockout/Tagout & Safety Solutions

F. Index

A. System Overview



Code Conductor, Long Barrel with Corona Relief Taper Splice

B1. Cable Ties

To Facilitate Use with Stranded Copper Conductors in Applications of 5000 V or More

Type SCH

- Externally chamfered barrel end inhibits Corona effect when used in high voltage applications
- Color-coded barrels marked with *PANDUIT* and specified competitor die index numbers for proper crimp die selection
- Internal wire stops to prevent over-insertion of conductor
- Tin-plated to inhibit corrosion
- UL Listed and CSA Certified to 35 KV** and temperature rated to 90°C when crimped with *PANDUIT* and specified competitor crimping tools and dies

B2. Cable Accessories

B3. Stainless Steel Ties

C1. Wiring Duct

C2. Surface Raceway

C3. Abrasion Protection

C4. Cable Management

D1. Terminals

D2. Power Connectors

D3. Grounding Connectors

E1. Labeling Systems

E2. Labels

E3. Pre-Printed & Write-On Markers

E4. Permanent Identification

E5. Lockout/Tagout & Safety Solutions

F. Index

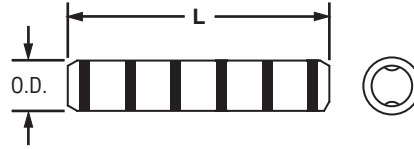

| Part Number | Copper Conductor Size | Figure Dimensions (In.) | | PANDUIT Color Code | PANDUIT Die Index No.‡ | Burdy Die Index No.‡ | T&B Die Index No.‡ | Wire Strip Length (In.) | Std. Pkg. Qty. |
|------------------|-----------------------|-------------------------|------|--------------------|------------------------|----------------------|--------------------|-------------------------|----------------|
| | | Barrel O.D. | L | | | | | | |
| SCH6-L | #6 AWG | .31 | 1.97 | Blue | P24 | 7 | 24 | 15/16 | 50 |
| SCH4-L | #4 AWG | .38 | 1.97 | Gray | P29 | 8 | 29 | 15/16 | 50 |
| SCH2-Q | #2 AWG | .42 | 2.13 | Brown | P33 | 10 | 33 | 1 | 25 |
| SCH1-E | #1 AWG | .47 | 2.13 | Green | P37 | 11 | 37 | 1 | 20 |
| SCH1/0-X | 1/0 AWG | .52 | 2.13 | Pink | P42 | 12 | 42 | 1 | 10 |
| SCH2/0-X | 2/0 AWG | .58 | 2.28 | Black | P45 | 13 | 45 | 1 1/16 | 10 |
| SCH3/0-X | 3/0 AWG | .64 | 2.47 | Orange | P50 | 14 | 50 | 1 3/16 | 10 |
| SCH4/0-X | 4/0 AWG | .71 | 2.54 | Purple | P54 | 15 | 54 | 1 3/16 | 10 |
| SCH250-X | 250 kcmil | .77 | 2.63 | Yellow | P62 | 16 | 62 | 1 1/4 | 10 |
| SCH300-X | 300 kcmil | .82 | 2.69 | White | P66 | 17 | 66 | 2 | 10 |
| SCH350-X | 350 kcmil | .88 | 2.84 | Red | P71 | 18 | 71 | 2 | 10 |
| SCH500-6 | 500 kcmil | 1.06 | 3.53 | Brown | P87 | 20 | 87 | 2 1/4 | 6 |
| SCH750-6 | 750 kcmil | 1.30 | 4.28 | Black | P106 | 24 | 106 | 2 7/8 | 6 |
| SCH1000-3 | 1000 kcmil | 1.50 | 5.06 | White | P125 | 27 | 125 | 3 | 3 |

‡See pages D3.62, D3.63 for tool and die information.

**Consult cable manufacturer for voltage stress relief instructions with applications greater than 2000 V.

Code Conductor, Long Barrel, T Splice

For Copper-to-Copper Stranded Conductors

Type SCT

- Provides a means of connecting the run conductor and taking off a perpendicular tap
- Long barrel maximizes number of crimps and provides premium wire pull-out strength and electrical performance

- Run conductor size and tap conductor size marked on each barrel
- 90°C temperature rated and for use up to 600 V when crimped with *PANDUIT* and specified competitor crimping tools and dies

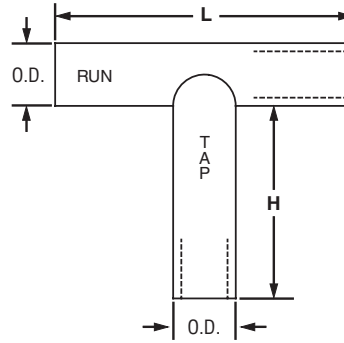

| Part Number | Copper Conductor Size | | Run O.D. | Tap O.D. | Figure Dimensions (In.) | | PANDUIT Color Code and Die Index No.‡ | | Burdny Die Index No.‡ | T&B Die Index No.‡ | Wire Strip Length (In.) | | Std. Pkg. Qty. |
|-------------|-----------------------|-----------|----------|----------|-------------------------|------|---------------------------------------|------------|-----------------------|--------------------|-------------------------|---------|----------------|
| | Run | Tap | | | H | L | Run | Tap | | | Run | Tap | |
| SCT2-2 | #2 AWG | #2 AWG | .42 | .42 | 1.50 | 3.88 | Brown P33 | Brown P33 | 10 | 33 | 2 | 1 9/16 | 1 |
| SCT1/0-1/0 | 1/0 AWG | 1/0 AWG | .51 | .51 | 1.50 | 4.00 | Pink P42 | Pink P42 | 12 | 42 | 2 1/16 | 1 9/16 | 1 |
| SCT2/0-2/0 | 2/0 AWG | 2/0 AWG | .56 | .56 | 1.50 | 4.00 | Black P45 | Black P45 | 13 | 45 | 2 1/16 | 1 9/16 | 1 |
| SCT4/0-1/0 | 4/0 AWG | 1/0 AWG | .69 | .51 | 1.50 | 4.00 | Orange P50 | Pink P42 | 14, 12 | 50, 42 | 2 1/16 | 1 9/16 | 1 |
| SCT4/0-4/0 | 4/0 AWG | 4/0 AWG | .69 | .69 | 1.63 | 4.19 | Purple P54 | Purple P54 | 15 | 54 | 2 1/8 | 1 11/16 | 1 |
| SCT250-250 | 250 kcmil | 250 kcmil | .75 | .75 | 1.63 | 4.25 | Yellow P62 | Yellow P62 | 16 | 62 | 2 3/16 | 1 11/16 | 1 |
| SCT300-300 | 300 kcmil | 300 kcmil | .81 | .81 | 2.00 | 5.44 | White P66 | White P66 | 17 | 66 | 2 13/16 | 2 1/16 | 1 |
| SCT350-350 | 350 kcmil | 350 kcmil | .88 | .88 | 2.00 | 5.50 | Red P71 | Red P71 | 18 | 71 | 2 13/16 | 2 1/16 | 1 |
| SCT500-4/0 | 500 kcmil | 4/0 AWG | 1.06 | .69 | 2.25 | 5.81 | Brown P87 | Purple P54 | 20, 15 | 87, 54 | 2 15/16 | 2 5/16 | 1 |
| SCT500-500 | 500 kcmil | 500 kcmil | 1.06 | 1.06 | 2.50 | 6.06 | Brown P87 | Brown P87 | 20 | 87 | 3 1/8 | 2 9/16 | 1 |

‡See pages D3.64, D3.65 for tool and die information.

A. System Overview

B1. Cable Ties

B2. Cable Accessories

B3. Stainless Steel Ties

C1. Wiring Duct

C2. Surface Raceway

C3. Abrasion Protection

C4. Cable Management

D1. Terminals

D2. Power Connectors

D3. Grounding Connectors

E1. Labeling Systems

E2. Labels

E3. Pre-Printed & Write-On Markers

E4. Permanent Identification

E5. Lockout/Tagout & Safety Solutions

F. Index

A.
System
Overview



Code Conductor, Color-Coded Parallel Splice

B1.
Cable Ties

For Use with Stranded Copper Conductors

Type PSC

- Industry recognized color-coding allows proper part selection and quick identification of crimping dies to speed installation
- Large easy-to-read part numbering for verification in demanding low light conditions
- Tin-plated to inhibit corrosion
- UL Listed and CSA Certified to 35 KV** and temperature rated to 90°C when crimped with *PANDUIT* dieless and die type crimping tools
- Single crimp design speeds installation and reduces labor costs
- Chamfered on both ends to facilitate fast and easy conductor insertion to speed installation

B2.
Cable
Accessories

B3.
Stainless
Steel Ties

C1.
Wiring
Duct

C2.
Surface
Raceway

C3.
Abrasion
Protection

C4.
Cable
Management

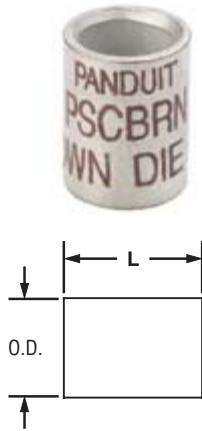

| Part Number | Figure Dimensions (in.) | | PANDUIT Color Code | PANDUIT Die Index No.‡ | Wire Strip Length (in.) | Std. Pkg. Qty. |
|-------------|-------------------------|------|--------------------|------------------------|-------------------------|----------------|
| | Barrel O.D. | L | | | | |
| PSCRED-L | .27 | .50 | Red | P21 | 7/16 | 50 |
| PSCBLU-L | .31 | .50 | Blue | P24 | 7/16 | 50 |
| PSCGRY-L | .38 | .50 | Gray | P29 | 7/16 | 50 |
| PSCBRN-L | .47 | .62 | Brown | P33 | 11/16 | 50 |
| PSCGRN-L | .52 | .62 | Green | P37 | 11/16 | 50 |
| PSCPNK-L | .58 | .62 | Pink | P42 | 11/16 | 50 |
| PSCBLK-Q | .64 | .81 | Black | P45 | 7/8 | 25 |
| PSCORG-Q | .71 | .81 | Orange | P50 | 7/8 | 25 |
| PSCPUR-Q | .77 | .88 | Purple | P54 | 1 | 25 |
| PSCYEL-Q | .81 | 1.05 | Yellow | P62 | 1 1/16 | 25 |

‡See page D3.78 for tool and die information. For smaller wires sizes, see pages D1.65 – D1.69.

For heat shrink end caps and tubing see pages C3.33 – C3.39.

For thermal transfer labeling solutions see pages E1.1 – E2.30.

**Consult cable manufacturer for voltage stress relief instructions with applications greater than 2000 V.

D1.
Terminals

D2.
Power
Connectors

D3.
Grounding
Connectors

E1.
Labeling
Systems

E2.
Labels

E3.
Pre-Printed
& Write-On
Markers

E4.
Permanent
Identification

E5.
Lockout/
Tagout
& Safety
Solutions

F.
Index

Copper Compression Parallel Splice

How to Use This Guide

Example: (3) #14 AWG wires
(2) #12 AWG wires

- In Table 1 find #14 AWG wire size and # of wires on vertical axis.
- Find #12 AWG wire size and # of wires on horizontal axis.
- Find the intersection of ① and ② to identify the correct color coded splice, which corresponds to the part number in Table 2. blue = PSCBLU-L
- See Table 3 on reverse side for proper die index number, wire strip length, and number of crimps.



| Part Number | Barrel O.D. (In.) | Length (In.) | PANDUIT Color Code | PANDUIT Die Index No. | Std. Pkg. Qty. |
|-------------|-------------------|--------------|--------------------|-----------------------|----------------|
| PSCRED-L | 0.27 | 0.50 | Red | P21 | 50 |
| PSCBLU-L | 0.31 | 0.50 | Blue | P24 | 50 |
| PSCGRY-L | 0.38 | 0.50 | Gray | P29 | 50 |
| PSCBRN-L | 0.47 | 0.62 | Brown | P33 | 50 |
| PSCGRN-L | 0.52 | 0.62 | Green | P37 | 50 |
| PSCPnk-L | 0.58 | 0.62 | Pink | P42 | 50 |
| PSCBLK-Q | 0.64 | 0.81 | Black | P45 | 25 |
| PSCORG-Q | 0.71 | 0.81 | Orange | P50 | 25 |
| PSCPUR-Q | 0.77 | 0.88 | Purple | P54 | 25 |
| PSCYEL-Q | 0.81 | 1.05 | Yellow | P62 | 25 |

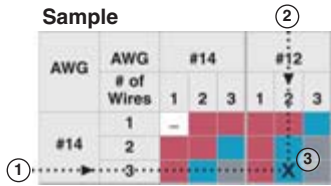

Table 2

| AWG | AWG # of Wires | #14 | | | #12 | | | #10 | | | #8 | | | #6 | | | #4 | | | #2 | | | #1 | | | 1/0 | | | 2/0 | | | 3/0 | | |
|-----|----------------|-----|------|------|------|------|------|------|------|------|------|------|------|------|------|------|------|------|------|------|------|------|------|------|------|------|------|------|------|------|------|-----|--|--|
| | | 1 | 2 | 3 | 1 | 2 | 3 | 1 | 2 | 3 | 1 | 2 | 3 | 1 | 2 | 3 | 1 | 2 | 3 | 1 | 2 | 3 | 1 | 2 | 3 | 1 | 2 | 3 | 1 | 2 | 3 | | | |
| #14 | 1 | - | Red | Red | Blue | Blue | Blue | Blue | Blue | Blue | Blue | Blue | Blue | Blue | Blue | Blue | Blue | Blue | Blue | Blue | Blue | Blue | Blue | Blue | Blue | Blue | Blue | Blue | Blue | Blue | Blue | | | |
| | 2 | Red | Blue | Blue | Blue | Blue | Blue | Blue | Blue | Blue | Blue | Blue | Blue | Blue | Blue | Blue | Blue | Blue | Blue | Blue | Blue | Blue | Blue | Blue | Blue | Blue | Blue | Blue | Blue | Blue | Blue | | | |
| | 3 | Red | Blue | Blue | Blue | Blue | Blue | Blue | Blue | Blue | Blue | Blue | Blue | Blue | Blue | Blue | Blue | Blue | Blue | Blue | Blue | Blue | Blue | Blue | Blue | Blue | Blue | Blue | Blue | Blue | Blue | | | |
| #12 | 1 | Red | Blue | Blue | Blue | Blue | Blue | Blue | Blue | Blue | Blue | Blue | Blue | Blue | Blue | Blue | Blue | Blue | Blue | Blue | Blue | Blue | Blue | Blue | Blue | Blue | Blue | Blue | Blue | Blue | Blue | | | |
| | 2 | Red | Blue | Blue | Blue | Blue | Blue | Blue | Blue | Blue | Blue | Blue | Blue | Blue | Blue | Blue | Blue | Blue | Blue | Blue | Blue | Blue | Blue | Blue | Blue | Blue | Blue | Blue | Blue | Blue | Blue | | | |
| | 3 | Red | Blue | Blue | Blue | Blue | Blue | Blue | Blue | Blue | Blue | Blue | Blue | Blue | Blue | Blue | Blue | Blue | Blue | Blue | Blue | Blue | Blue | Blue | Blue | Blue | Blue | Blue | Blue | Blue | Blue | | | |
| #10 | 1 | Red | Blue | Blue | Blue | Blue | Blue | Blue | Blue | Blue | Blue | Blue | Blue | Blue | Blue | Blue | Blue | Blue | Blue | Blue | Blue | Blue | Blue | Blue | Blue | Blue | Blue | Blue | Blue | Blue | Blue | | | |
| | 2 | Red | Blue | Blue | Blue | Blue | Blue | Blue | Blue | Blue | Blue | Blue | Blue | Blue | Blue | Blue | Blue | Blue | Blue | Blue | Blue | Blue | Blue | Blue | Blue | Blue | Blue | Blue | Blue | Blue | Blue | | | |
| | 3 | Red | Blue | Blue | Blue | Blue | Blue | Blue | Blue | Blue | Blue | Blue | Blue | Blue | Blue | Blue | Blue | Blue | Blue | Blue | Blue | Blue | Blue | Blue | Blue | Blue | Blue | Blue | Blue | Blue | Blue | | | |
| #8 | 1 | Red | Blue | Blue | Blue | Blue | Blue | Blue | Blue | Blue | Blue | Blue | Blue | Blue | Blue | Blue | Blue | Blue | Blue | Blue | Blue | Blue | Blue | Blue | Blue | Blue | Blue | Blue | Blue | Blue | Blue | | | |
| | 2 | Red | Blue | Blue | Blue | Blue | Blue | Blue | Blue | Blue | Blue | Blue | Blue | Blue | Blue | Blue | Blue | Blue | Blue | Blue | Blue | Blue | Blue | Blue | Blue | Blue | Blue | Blue | Blue | Blue | Blue | | | |
| | 3 | Red | Blue | Blue | Blue | Blue | Blue | Blue | Blue | Blue | Blue | Blue | Blue | Blue | Blue | Blue | Blue | Blue | Blue | Blue | Blue | Blue | Blue | Blue | Blue | Blue | Blue | Blue | Blue | Blue | Blue | | | |
| #6 | 1 | Red | Blue | Blue | Blue | Blue | Blue | Blue | Blue | Blue | Blue | Blue | Blue | Blue | Blue | Blue | Blue | Blue | Blue | Blue | Blue | Blue | Blue | Blue | Blue | Blue | Blue | Blue | Blue | Blue | Blue | | | |
| | 2 | Red | Blue | Blue | Blue | Blue | Blue | Blue | Blue | Blue | Blue | Blue | Blue | Blue | Blue | Blue | Blue | Blue | Blue | Blue | Blue | Blue | Blue | Blue | Blue | Blue | Blue | Blue | Blue | Blue | Blue | | | |
| | 3 | Red | Blue | Blue | Blue | Blue | Blue | Blue | Blue | Blue | Blue | Blue | Blue | Blue | Blue | Blue | Blue | Blue | Blue | Blue | Blue | Blue | Blue | Blue | Blue | Blue | Blue | Blue | Blue | Blue | Blue | | | |
| #4 | 1 | Red | Blue | Blue | Blue | Blue | Blue | Blue | Blue | Blue | Blue | Blue | Blue | Blue | Blue | Blue | Blue | Blue | Blue | Blue | Blue | Blue | Blue | Blue | Blue | Blue | Blue | Blue | Blue | Blue | Blue | | | |
| | 2 | Red | Blue | Blue | Blue | Blue | Blue | Blue | Blue | Blue | Blue | Blue | Blue | Blue | Blue | Blue | Blue | Blue | Blue | Blue | Blue | Blue | Blue | Blue | Blue | Blue | Blue | Blue | Blue | Blue | Blue | | | |
| | 3 | Red | Blue | Blue | Blue | Blue | Blue | Blue | Blue | Blue | Blue | Blue | Blue | Blue | Blue | Blue | Blue | Blue | Blue | Blue | Blue | Blue | Blue | Blue | Blue | Blue | Blue | Blue | Blue | Blue | Blue | | | |
| #2 | 1 | Red | Blue | Blue | Blue | Blue | Blue | Blue | Blue | Blue | Blue | Blue | Blue | Blue | Blue | Blue | Blue | Blue | Blue | Blue | Blue | Blue | Blue | Blue | Blue | Blue | Blue | Blue | Blue | Blue | Blue | | | |
| | 2 | Red | Blue | Blue | Blue | Blue | Blue | Blue | Blue | Blue | Blue | Blue | Blue | Blue | Blue | Blue | Blue | Blue | Blue | Blue | Blue | Blue | Blue | Blue | Blue | Blue | Blue | Blue | Blue | Blue | Blue | | | |
| | 3 | Red | Blue | Blue | Blue | Blue | Blue | Blue | Blue | Blue | Blue | Blue | Blue | Blue | Blue | Blue | Blue | Blue | Blue | Blue | Blue | Blue | Blue | Blue | Blue | Blue | Blue | Blue | Blue | Blue | Blue | | | |
| #1 | 1 | Red | Blue | Blue | Blue | Blue | Blue | Blue | Blue | Blue | Blue | Blue | Blue | Blue | Blue | Blue | Blue | Blue | Blue | Blue | Blue | Blue | Blue | Blue | Blue | Blue | Blue | Blue | Blue | Blue | Blue | | | |
| | 2 | Red | Blue | Blue | Blue | Blue | Blue | Blue | Blue | Blue | Blue | Blue | Blue | Blue | Blue | Blue | Blue | Blue | Blue | Blue | Blue | Blue | Blue | Blue | Blue | Blue | Blue | Blue | Blue | Blue | Blue | | | |
| | 3 | Red | Blue | Blue | Blue | Blue | Blue | Blue | Blue | Blue | Blue | Blue | Blue | Blue | Blue | Blue | Blue | Blue | Blue | Blue | Blue | Blue | Blue | Blue | Blue | Blue | Blue | Blue | Blue | Blue | Blue | | | |
| 1/0 | 1 | Red | Blue | Blue | Blue | Blue | Blue | Blue | Blue | Blue | Blue | Blue | Blue | Blue | Blue | Blue | Blue | Blue | Blue | Blue | Blue | Blue | Blue | Blue | Blue | Blue | Blue | Blue | Blue | Blue | Blue | | | |
| | 2 | Red | Blue | Blue | Blue | Blue | Blue | Blue | Blue | Blue | Blue | Blue | Blue | Blue | Blue | Blue | Blue | Blue | Blue | Blue | Blue | Blue | Blue | Blue | Blue | Blue | Blue | Blue | Blue | Blue | Blue | | | |
| | 3 | Red | Blue | Blue | Blue | Blue | Blue | Blue | Blue | Blue | Blue | Blue | Blue | Blue | Blue | Blue | Blue | Blue | Blue | Blue | Blue | Blue | Blue | Blue | Blue | Blue | Blue | Blue | Blue | Blue | Blue | | | |
| 2/0 | 1 | Red | Blue | Blue | Blue | Blue | Blue | Blue | Blue | Blue | Blue | Blue | Blue | Blue | Blue | Blue | Blue | Blue | Blue | Blue | Blue | Blue | Blue | Blue | Blue | Blue | Blue | Blue | Blue | Blue | Blue | | | |
| | 2 | Red | Blue | Blue | Blue | Blue | Blue | Blue | Blue | Blue | Blue | Blue | Blue | Blue | Blue | Blue | Blue | Blue | Blue | Blue | Blue | Blue | Blue | Blue | Blue | Blue | Blue | Blue | Blue | Blue | Blue | | | |
| | 3 | Red | Blue | Blue | Blue | Blue | Blue | Blue | Blue | Blue | Blue | Blue | Blue | Blue | Blue | Blue | Blue | Blue | Blue | Blue | Blue | Blue | Blue | Blue | Blue | Blue | Blue | Blue | Blue | Blue | Blue | | | |
| 3/0 | 1 | Red | Blue | Blue | Blue | Blue | Blue | Blue | Blue | Blue | Blue | Blue | Blue | Blue | Blue | Blue | Blue | Blue | Blue | Blue | Blue | Blue | Blue | Blue | Blue | Blue | Blue | Blue | Blue | Blue | Blue | | | |
| | 2 | Red | Blue | Blue | Blue | Blue | Blue | Blue | Blue | Blue | Blue | Blue | Blue | Blue | Blue | Blue | Blue | Blue | Blue | Blue | Blue | Blue | Blue | Blue | Blue | Blue | Blue | Blue | Blue | Blue | Blue | | | |
| | 3 | Red | Blue | Blue | Blue | Blue | Blue | Blue | Blue | Blue | Blue | Blue | Blue | Blue | Blue | Blue | Blue | Blue | Blue | Blue | Blue | Blue | Blue | Blue | Blue | Blue | Blue | Blue | Blue | Blue | Blue | | | |

Table 1

A. System Overview

B1. Cable Ties

B2. Cable Accessories

B3. Stainless Steel Ties

C1. Wiring Duct

C2. Surface Raceway

C3. Abrasion Protection

C4. Cable Management

D1. Terminals

D2. Power Connectors

D3. Grounding Connectors

E1. Labeling Systems

E2. Labels

E3. Pre-Printed & Write-On Markers

E4. Permanent Identification

E5. Lockout/Tagout & Safety Solutions

F. Index

UL LISTED US SP CERTIFIED Flex Conductor, One-Hole, Standard Barrel with Window Lug

For Use with Flexible, Extra-Flexible, and Code Stranded Copper Conductors

Type LCAX

- Can be used with code conductor and flex conductor class: G, H, I, K, M and Diesel Locomotive
- Generously beveled wire entry prevents bent back strands when inserting conductor into barrel
- Color-coded barrels marked with *PANDUIT* and specified competitor die index numbers for proper crimp die selection
- Inspection window to visually assure full conductor insertion
- Tin-plated to inhibit corrosion
- UL Listed and CSA Certified to 35 KV** and temperature rated to 90°C when crimped with *PANDUIT* and specified competitor crimping tools and dies
- American Bureau of Shipping approved

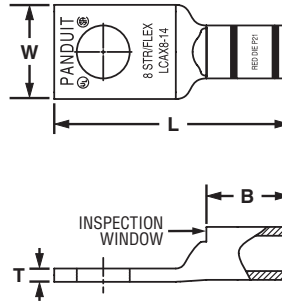

| Part Number | Flex Conductor Size | | Code Conductor Size | Stud Hole Size (In.) | Figure Dimensions (In.) | | | | PANDUIT Color Code | PANDUIT Die Index No.‡ | Burndy Die Index No.‡ | T&B Die Index No.‡ | Wire Strip Length (In.) | Std. Pkg. Qty. |
|--------------|---------------------|-------------------|---------------------|----------------------|-------------------------|-------|-----|------|--------------------|------------------------|-----------------------|--------------------|-------------------------|----------------|
| | Class G, H, I, K, M | Diesel Locomotive | | | W | B | T | L | | | | | | |
| LCAX8-10-L | #8 AWG | #8 AWG | #8 AWG | #10 | .41 | .42 | .08 | 1.11 | Red | P21 | 49 | 21 | 1/2 | 50 |
| LCAX8-14-L | | | | 1/4 | .48 | .42 | .07 | 1.20 | Red | P21 | 49 | 21 | 1/2 | 50 |
| LCAX8-56-L | | | | 5/16 | .56 | .42 | .05 | 1.32 | Red | P21 | 49 | 21 | 1/2 | 50 |
| LCAX8-38-L | | | | 3/8 | .60 | .42 | .05 | 1.42 | Red | P21 | 49 | 21 | 1/2 | 50 |
| LCAX6-10-L | #6 AWG | #6 AWG | #6 AWG | #10 | .45 | .48 | .09 | 1.19 | Blue | P24 | 7 | 24 | 9/16 | 50 |
| LCAX6-14-L | | | | 1/4 | .48 | .48 | .08 | 1.28 | Blue | P24 | 7 | 24 | 9/16 | 50 |
| LCAX6-56-L | | | | 5/16 | .56 | .48 | .07 | 1.40 | Blue | P24 | 7 | 24 | 9/16 | 50 |
| LCAX6-38-L | | | | 3/8 | .62 | .48 | .06 | 1.50 | Blue | P24 | 7 | 24 | 9/16 | 50 |
| LCAX4-10-L | #4 AWG | #5, #4, #3 AWG | #4 AWG | #10 | .55 | .53 | .09 | 1.26 | Gray | P29 | 8 | 29 | 5/8 | 50 |
| LCAX4-14-L | | | | 1/4 | .55 | .53 | .09 | 1.35 | Gray | P29 | 8 | 29 | 5/8 | 50 |
| LCAX4-56-L | | | | 5/16 | .55 | .53 | .09 | 1.47 | Gray | P29 | 8 | 29 | 5/8 | 50 |
| LCAX4-38-L | | | | 3/8 | .62 | .53 | .07 | 1.57 | Gray | P29 | 8 | 29 | 5/8 | 50 |
| LCAX2-10-E* | #2 AWG | #2 AWG | #2 AWG | #10 | .70 | .59 | .11 | 1.40 | Brown | P33 | 10 | 33 | 11/16 | 20 |
| LCAX2-14-E* | | | | 1/4 | .70 | .59 | .11 | 1.50 | Brown | P33 | 10 | 33 | 11/16 | 20 |
| LCAX2-56-E* | | | | 5/16 | .70 | .59 | .11 | 1.63 | Brown | P33 | 10 | 33 | 11/16 | 20 |
| LCAX2-38-E* | | | | 3/8 | .70 | .59 | .11 | 1.70 | Brown | P33 | 10 | 33 | 11/16 | 20 |
| LCAX2-12-E* | 1/2 | .75 | .59 | .09 | 1.94 | Brown | P33 | 10 | 33 | 11/16 | 20 | | | |
| LCAX1-10-X | #1 AWG | #1 AWG | #1 AWG | #10 | .76 | .66 | .12 | 1.50 | Green | P37 | 11 | 37 | 3/4 | 10 |
| LCAX1-14-X | | | | 1/4 | .76 | .66 | .12 | 1.67 | Green | P37 | 11 | 37 | 3/4 | 10 |
| LCAX1-56-X | | | | 5/16 | .76 | .66 | .12 | 1.72 | Green | P37 | 11 | 37 | 3/4 | 10 |
| LCAX1-38-X | | | | 3/8 | .76 | .66 | .12 | 1.80 | Green | P37 | 11 | 37 | 3/4 | 10 |
| LCAX1-12-X | 1/2 | .80 | .66 | .12 | 2.03 | Green | P37 | 11 | 37 | 3/4 | 10 | | | |
| LCAX1/0-14-X | 1/0 AWG | 1/0 AWG | 1/0 AWG | 1/4 | .85 | .72 | .13 | 1.82 | Pink | P42 | 12 | 42 | 3/4 | 10 |
| LCAX1/0-56-X | | | | 5/16 | .85 | .72 | .13 | 1.82 | Pink | P42 | 12 | 42 | 3/4 | 10 |
| LCAX1/0-38-X | | | | 3/8 | .85 | .72 | .13 | 1.89 | Pink | P42 | 12 | 42 | 3/4 | 10 |
| LCAX1/0-12-X | | | | 1/2 | .85 | .72 | .13 | 2.14 | Pink | P42 | 12 | 42 | 3/4 | 10 |

‡See pages D3.66 – D3.69 for tool and die information.

*Not UL Listed or CSA Certified with Class K flex conductor when crimped with Burndy tools.

**Consult cable manufacturer for voltage stress relief instructions with applications greater than 2000 V.



Flex Conductor, One-Hole, Standard Barrel with Window Lug (continued)

| Part Number | Flex Conductor Size | | Code Conductor Size | Stud Hole Size (In.) | Figure Dimensions (In.) | | | | PANDUIT Color Code | PANDUIT Die Index No.‡ | Burdny Die Index No.‡ | T&B Die Index No.‡ | Wire Strip Length (In.) | Std. Pkg. Qty. |
|--------------|---------------------|-------------------|---------------------|----------------------|-------------------------|-------|-----|------|--------------------|------------------------|-----------------------|--------------------|-------------------------|----------------|
| | Class G, H, I, K, M | Diesel Locomotive | | | W | B | T | L | | | | | | |
| LCAX2/0-10-X | 2/0 AWG | 2/0 AWG | 2/0 AWG | #10 | .96 | .83 | .13 | 1.72 | Black | P45 | 13 | 45 | 7/8 | 10 |
| LCAX2/0-14-X | | | | 1/4 | .96 | .83 | .13 | 1.97 | Black | P45 | 13 | 45 | 7/8 | 10 |
| LCAX2/0-56-X | | | | 5/16 | .96 | .83 | .13 | 1.97 | Black | P45 | 13 | 45 | 7/8 | 10 |
| LCAX2/0-38-X | | | | 3/8 | .96 | .83 | .13 | 2.03 | Black | P45 | 13 | 45 | 7/8 | 10 |
| LCAX2/0-12-X | | | | 1/2 | .96 | .83 | .13 | 2.28 | Black | P45 | 13 | 45 | 7/8 | 10 |
| LCAX2/0-58-X | | | | 5/8 | .96 | .83 | .13 | 2.52 | Black | P45 | 13 | 45 | 7/8 | 10 |
| LCAX2/0-34-X | | | | 3/4 | .96 | .83 | .13 | 2.88 | Black | P45 | 13 | 45 | 7/8 | 10 |
| LCAX3/0-10-X | 3/0 AWG | 3/0 AWG | 3/0 AWG | #10 | 1.06 | .91 | .14 | 1.84 | Orange | P50 | 14 | 50 | 1 | 10 |
| LCAX3/0-14-X | | | | 1/4 | 1.06 | .91 | .14 | 2.08 | Orange | P50 | 14 | 50 | 1 | 10 |
| LCAX3/0-56-X | | | | 5/16 | 1.06 | .91 | .14 | 2.10 | Orange | P50 | 14 | 50 | 1 | 10 |
| LCAX3/0-38-X | | | | 3/8 | 1.06 | .91 | .14 | 2.17 | Orange | P50 | 14 | 50 | 1 | 10 |
| LCAX3/0-12-X | | | | 1/2 | 1.06 | .91 | .14 | 2.40 | Orange | P50 | 14 | 50 | 1 | 10 |
| LCAX4/0-14-X | 4/0 AWG | 4/0 AWG | 4/0 AWG | 1/4 | 1.19 | 1.03 | .16 | 2.30 | Purple | P54 | 15 | 54 | 1 1/16 | 10 |
| LCAX4/0-56-X | | | | 5/16 | 1.19 | 1.03 | .16 | 2.53 | Purple | P54 | 15 | 54 | 1 1/16 | 10 |
| LCAX4/0-38-X | | | | 3/8 | 1.19 | 1.03 | .16 | 2.53 | Purple | P54 | 15 | 54 | 1 1/16 | 10 |
| LCAX4/0-12-X | | | | 1/2 | 1.19 | 1.03 | .16 | 2.64 | Purple | P54 | 15 | 54 | 1 1/16 | 10 |
| LCAX4/0-58-X | | | | 5/8 | 1.19 | 1.03 | .16 | 2.85 | Purple | P54 | 15 | 54 | 1 1/16 | 10 |
| LCAX4/0-34-X | | | | 3/4 | 1.19 | 1.03 | .16 | 3.04 | Purple | P54 | 15 | 54 | 1 1/16 | 10 |
| LCAX250-14-X | 250 kcmil | 262.6 kcmil | — | 1/4 | 1.28 | 1.03 | .17 | 2.34 | Yellow | P62 | 16 | 62 | 1 1/16 | 10 |
| LCAX250-56-X | | | | 5/16 | 1.28 | 1.03 | .17 | 2.57 | Yellow | P62 | 16 | 62 | 1 1/16 | 10 |
| LCAX250-38-X | | | | 3/8 | 1.28 | 1.03 | .17 | 2.57 | Yellow | P62 | 16 | 62 | 1 1/16 | 10 |
| LCAX250-12-X | | | | 1/2 | 1.28 | 1.03 | .17 | 2.68 | Yellow | P62 | 16 | 62 | 1 1/16 | 10 |
| LCAX250-58-X | | | | 5/8 | 1.28 | 1.03 | .17 | 2.89 | Yellow | P62 | 16 | 62 | 1 1/16 | 10 |
| LCAX300-38-6 | 300 kcmil | 313.1 kcmil | — | 3/8 | 1.39 | 1.19 | .18 | 2.91 | Red | P71 | 18 | 71H | 1 1/4 | 6 |
| LCAX300-12-6 | | | | 1/2 | 1.39 | 1.19 | .18 | 2.91 | Red | P71 | 18 | 71H | 1 1/4 | 6 |
| LCAX300-58-6 | | | | 5/8 | 1.39 | 1.19 | .18 | 3.12 | Red | P71 | 18 | 71H | 1 1/4 | 6 |
| LCAX350-56-6 | 350 kcmil | 373.7 kcmil | — | 5/16 | 1.54 | 1.29 | .22 | 2.93 | Blue | P76 | 19 | 76H | 1 3/8 | 6 |
| LCAX350-38-6 | | | | 3/8 | 1.54 | 1.29 | .22 | 2.93 | Blue | P76 | 19 | 76H | 1 3/8 | 6 |
| LCAX350-12-6 | | | | 1/2 | 1.54 | 1.29 | .22 | 3.09 | Blue | P76 | 19 | 76H | 1 3/8 | 6 |
| LCAX350-58-6 | 450 kcmil | 444.4 kcmil | — | 5/8 | 1.54 | 1.29 | .22 | 3.30 | Blue | P76 | 19 | 76H | 1 3/8 | 6 |
| LCAX450-12-6 | | | | 1/2 | 1.70 | 1.40 | .26 | 3.60 | Brown | P87 | 20 | 87H | 1 7/16 | 6 |
| LCAX450-58-6 | 5/8 | 1.70 | 1.40 | .26 | 3.73 | Brown | P87 | 20 | 87H | 1 7/16 | 6 | | | |
| LCAX500-56-6 | 500 kcmil | 535.3 kcmil | — | 5/16 | 1.89 | 1.48 | .26 | 3.27 | Pink | P99 | L99 | 99H | 1 9/16 | 6 |
| LCAX500-38-6 | | | | 3/8 | 1.89 | 1.48 | .26 | 3.27 | Pink | P99 | L99 | 99H | 1 9/16 | 6 |
| LCAX500-12-6 | | | | 1/2 | 1.89 | 1.48 | .26 | 3.64 | Pink | P99 | L99 | 99H | 1 9/16 | 6 |
| LCAX500-58-6 | | | | 5/8 | 1.89 | 1.48 | .26 | 4.20 | Pink | P99 | L99 | 99H | 1 9/16 | 6 |
| LCAX650-56-6 | — | 646.4 kcmil | — | 5/16 | 1.95 | 1.45 | .30 | 3.27 | Black | P106 | 24 | 106H | 1 1/2 | 6 |
| LCAX650-38-6 | | | | 3/8 | 1.95 | 1.45 | .30 | 3.27 | Black | P106 | 24 | 106H | 1 1/2 | 6 |
| LCAX650-12-6 | | | | 1/2 | 1.95 | 1.45 | .30 | 3.64 | Black | P106 | 24 | 106H | 1 1/2 | 6 |
| LCAX650-58-6 | | | | 5/8 | 1.95 | 1.45 | .30 | 4.20 | Black | P106 | 24 | 106H | 1 1/2 | 6 |
| LCAX750-12-3 | — | 777.7 kcmil | — | 1/2 | 2.17 | 1.66 | .32 | 3.94 | Yellow | P115 | L115 | 115H | 1 3/4 | 3 |
| LCAX750-58-3 | | | | 5/8 | 2.17 | 1.66 | .32 | 4.59 | Yellow | P115 | L115 | 115H | 1 3/4 | 3 |

‡See pages D3.66 – D3.69 for tool and die information.

**Consult cable manufacturer for voltage stress relief instructions with applications greater than 2000 V.

A. System Overview

B1. Cable Ties

B2. Cable Accessories

B3. Stainless Steel Ties

C1. Wiring Duct

C2. Surface Raceway

C3. Abrasion Protection

C4. Cable Management

D1. Terminals

D2. Power Connectors

D3. Grounding Connectors

E1. Labeling Systems

E2. Labels

E3. Pre-Printed & Write-On Markers

E4. Permanent Identification

E5. Lockout/Tagout & Safety Solutions

F. Index

A. System Overview

B1. Cable Ties

B2. Cable Accessories

B3. Stainless Steel Ties

C1. Wiring Duct

C2. Surface Raceway

C3. Abrasion Protection

C4. Cable Management

D1. Terminals

D2. Power Connectors

D3. Grounding Connectors

E1. Labeling Systems

E2. Labels

E3. Pre-Printed & Write-On Markers

E4. Permanent Identification

E5. Lockout/Tagout & Safety Solutions

F. Index

UL LISTED **CSA CERTIFIED** **Flex Conductor, One-Hole, Standard Barrel with Window Lug, 45° Angle**

For Use with Flexible, Extra-Flexible, and Code Stranded Copper Conductors

Type LCAX-H

- Can be used with code conductor and flex conductor class: G, H, I, K, M and Diesel Locomotive
- Generously beveled wire entry prevents bent back strands when inserting conductor into barrel
- Color-coded barrels marked with *PANDUIT* and specified competitor die index numbers for proper crimp die selection
- Inspection window to visually assure full conductor insertion
- Tin-plated to inhibit corrosion
- UL Listed and CSA Certified to 35 KV** and temperature rated to 90°C when crimped with *PANDUIT* and specified competitor crimping tools and dies
- American Bureau of Shipping approved

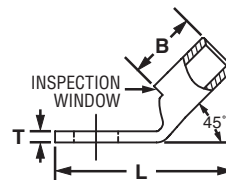
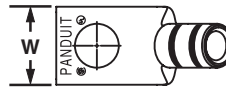

| Part Number | Flex Conductor Size | | Code Conductor Size | Stud Hole Size (In.) | Figure Dimensions (In.) | | | | PANDUIT Color Code | PANDUIT Die Index No.‡ | Burndy Die Index No.‡ | T&B Die Index No.‡ | Wire Strip Length (In.) | Std. Pkg. Qty. |
|---------------|---------------------|-------------------|---------------------|----------------------|-------------------------|-----|-----|------|--------------------|------------------------|-----------------------|--------------------|-------------------------|----------------|
| | Class G, H, I, K, M | Diesel Locomotive | | | W | B | T | L | | | | | | |
| LCAX8-10H-L | #8 AWG | #8 AWG | #8 AWG | #10 | .41 | .42 | .08 | 1.00 | Red | P21 | 49 | 21 | 1/2 | 50 |
| LCAX8-14H-L | | | | 1/4 | .48 | .42 | .07 | 1.09 | Red | P21 | 49 | 21 | 1/2 | 50 |
| LCAX8-56H-L | | | | 5/16 | .56 | .42 | .05 | 1.20 | Red | P21 | 49 | 21 | 1/2 | 50 |
| LCAX8-38H-L | | | | 3/8 | .60 | .42 | .05 | 1.30 | Red | P21 | 49 | 21 | 1/2 | 50 |
| LCAX6-10H-L | #6 AWG | #6 AWG | #6 AWG | #10 | .45 | .48 | .09 | 1.06 | Blue | P24 | 7 | 24 | 9/16 | 50 |
| LCAX6-14H-L | | | | 1/4 | .48 | .48 | .08 | 1.14 | Blue | P24 | 7 | 24 | 9/16 | 50 |
| LCAX6-56H-L | | | | 5/16 | .56 | .48 | .07 | 1.26 | Blue | P24 | 7 | 24 | 9/16 | 50 |
| LCAX6-38H-L | | | | 3/8 | .62 | .48 | .06 | 1.35 | Blue | P24 | 7 | 24 | 9/16 | 50 |
| LCAX4-10H-L | #4 AWG | #5, #4, #3 AWG | #4 AWG | #10 | .55 | .53 | .09 | 1.12 | Gray | P29 | 8 | 29 | 5/8 | 50 |
| LCAX4-14H-L | | | | 1/4 | .55 | .53 | .09 | 1.21 | Gray | P29 | 8 | 29 | 5/8 | 50 |
| LCAX4-56H-L | | | | 5/16 | .55 | .53 | .09 | 1.33 | Gray | P29 | 8 | 29 | 5/8 | 50 |
| LCAX4-38H-L | | | | 3/8 | .62 | .53 | .07 | 1.42 | Gray | P29 | 8 | 29 | 5/8 | 50 |
| LCAX2-10H-E* | #2 AWG | #2 AWG | #2 AWG | #10 | .70 | .59 | .11 | 1.22 | Brown | P33 | 10 | 33 | 11/16 | 20 |
| LCAX2-14H-E* | | | | 1/4 | .70 | .59 | .11 | 1.29 | Brown | P33 | 10 | 33 | 11/16 | 20 |
| LCAX2-56H-E* | | | | 5/16 | .70 | .59 | .11 | 1.42 | Brown | P33 | 10 | 33 | 11/16 | 20 |
| LCAX2-38H-E* | | | | 3/8 | .70 | .59 | .11 | 1.49 | Brown | P33 | 10 | 33 | 11/16 | 20 |
| LCAX2-12H-E* | | | | 1/2 | .75 | .59 | .09 | 1.73 | Brown | P33 | 10 | 33 | 11/16 | 20 |
| LCAX1-10H-X | #1 AWG | #1 AWG | #1 AWG | #10 | .76 | .66 | .12 | 1.43 | Green | P37 | 11 | 37 | 3/4 | 10 |
| LCAX1-14H-X | | | | 1/4 | .76 | .66 | .12 | 1.43 | Green | P37 | 11 | 37 | 3/4 | 10 |
| LCAX1-56H-X | | | | 5/16 | .76 | .66 | .12 | 1.49 | Green | P37 | 11 | 37 | 3/4 | 10 |
| LCAX1-38H-X | | | | 3/8 | .76 | .66 | .12 | 1.56 | Green | P37 | 11 | 37 | 3/4 | 10 |
| LCAX1-12H-X | | | | 1/2 | .80 | .66 | .12 | 1.80 | Green | P37 | 11 | 37 | 3/4 | 10 |
| LCAX1/0-14H-X | 1/0 AWG | 1/0 AWG | 1/0 AWG | 1/4 | .85 | .72 | .13 | 1.58 | Pink | P42 | 12 | 42 | 3/4 | 10 |
| LCAX1/0-56H-X | | | | 5/16 | .85 | .72 | .13 | 1.58 | Pink | P42 | 12 | 42 | 3/4 | 10 |
| LCAX1/0-38H-X | | | | 3/8 | .85 | .72 | .13 | 1.64 | Pink | P42 | 12 | 42 | 3/4 | 10 |
| LCAX1/0-12H-X | | | | 1/2 | .85 | .72 | .13 | 1.89 | Pink | P42 | 12 | 42 | 3/4 | 10 |

‡See pages D3.66 – D3.69 for tool and die information.

*Not UL Listed or CSA Certified with Class K flex conductor when crimped with Burndy tools.

**Consult cable manufacturer for voltage stress relief instructions with applications greater than 2000 V.



Flex Conductor, One-Hole, Standard Barrel with Window Lug, 45° Angle (continued)

| Part Number | Flex Conductor Size | | Code Conductor Size | Stud Hole Size (In.) | Figure Dimensions (In.) | | | | PANDUIT Color Code | PANDUIT Die Index No.‡ | Burndy Die Index No.‡ | T&B Die Index No.‡ | Wire Strip Length (In.) | Std. Pkg. Qty. |
|---------------|---------------------|-------------------|---------------------|----------------------|-------------------------|------|-----|------|--------------------|------------------------|-----------------------|--------------------|-------------------------|----------------|
| | Class G, H, I, K, M | Diesel Locomotive | | | W | B | T | L | | | | | | |
| LCAX2/0-10H-X | 2/0 AWG | 2/0 AWG | 2/0 AWG | #10 | .96 | .83 | .13 | 1.56 | Black | P45 | 13 | 45 | 7/8 | 10 |
| LCAX2/0-14H-X | | | | 1/4 | .96 | .83 | .13 | 1.68 | Black | P45 | 13 | 45 | 7/8 | 10 |
| LCAX2/0-56H-X | | | | 5/16 | .96 | .83 | .13 | 1.68 | Black | P45 | 13 | 45 | 7/8 | 10 |
| LCAX2/0-38H-X | | | | 3/8 | .96 | .83 | .13 | 1.74 | Black | P45 | 13 | 45 | 7/8 | 10 |
| LCAX2/0-12H-X | | | | 1/2 | .96 | .83 | .13 | 1.99 | Black | P45 | 13 | 45 | 7/8 | 10 |
| LCAX2/0-58H-X | | | | 5/8 | .96 | .83 | .13 | 2.28 | Black | P45 | 13 | 45 | 7/8 | 10 |
| LCAX2/0-34H-X | | | | 3/4 | .96 | .83 | .13 | 2.12 | Black | P45 | 13 | 45 | 7/8 | 10 |
| LCAX3/0-10H-X | 3/0 AWG | 3/0 AWG | 3/0 AWG | #10 | 1.06 | .91 | .14 | 1.77 | Orange | P50 | 14 | 50 | 1 | 10 |
| LCAX3/0-14H-X | | | | 1/4 | 1.06 | .91 | .14 | 1.77 | Orange | P50 | 14 | 50 | 1 | 10 |
| LCAX3/0-56H-X | | | | 5/16 | 1.06 | .91 | .14 | 1.78 | Orange | P50 | 14 | 50 | 1 | 10 |
| LCAX3/0-38H-X | | | | 3/8 | 1.06 | .91 | .14 | 1.85 | Orange | P50 | 14 | 50 | 1 | 10 |
| LCAX3/0-12H-X | | | | 1/2 | 1.06 | .91 | .14 | 2.08 | Orange | P50 | 14 | 50 | 1 | 10 |
| LCAX4/0-14H-X | 4/0 AWG | 4/0 AWG | 4/0 AWG | 1/4 | 1.19 | 1.03 | .16 | 2.03 | Purple | P54 | 15 | 54 | 1 1/16 | 10 |
| LCAX4/0-56H-X | | | | 5/16 | 1.19 | 1.03 | .16 | 2.26 | Purple | P54 | 15 | 54 | 1 1/16 | 10 |
| LCAX4/0-38H-X | | | | 3/8 | 1.19 | 1.03 | .16 | 2.26 | Purple | P54 | 15 | 54 | 1 1/16 | 10 |
| LCAX4/0-12H-X | | | | 1/2 | 1.19 | 1.03 | .16 | 2.37 | Purple | P54 | 15 | 54 | 1 1/16 | 10 |
| LCAX4/0-58H-X | | | | 5/8 | 1.19 | 1.03 | .16 | 2.58 | Purple | P54 | 15 | 54 | 1 1/16 | 10 |
| LCAX4/0-34H-X | | | | 3/4 | 1.19 | 1.03 | .16 | 2.58 | Purple | P54 | 15 | 54 | 1 1/16 | 10 |
| LCAX250-14H-X | 250 kcmil | 262.6 kcmil | — | 1/4 | 1.28 | 1.03 | .17 | 2.30 | Yellow | P62 | 16 | 62 | 1 1/16 | 10 |
| LCAX250-56H-X | | | | 5/16 | 1.28 | 1.03 | .17 | 2.30 | Yellow | P62 | 16 | 62 | 1 1/16 | 10 |
| LCAX250-38H-X | | | | 3/8 | 1.28 | 1.03 | .17 | 2.30 | Yellow | P62 | 16 | 62 | 1 1/16 | 10 |
| LCAX250-12H-X | | | | 1/2 | 1.28 | 1.03 | .17 | 2.41 | Yellow | P62 | 16 | 62 | 1 1/16 | 10 |
| LCAX250-58H-X | | | | 5/8 | 1.28 | 1.03 | .17 | 2.62 | Yellow | P62 | 16 | 62 | 1 1/16 | 10 |
| LCAX250-34H-X | | | | 3/4 | 1.28 | 1.03 | .17 | 2.62 | Yellow | P62 | 16 | 62 | 1 1/16 | 10 |
| LCAX300-38H-6 | 300 kcmil | 313.1 kcmil | — | 3/8 | 1.39 | 1.19 | .18 | 2.64 | Red | P71 | 18 | 71H | 1 1/4 | 6 |
| LCAX300-12H-6 | | | | 1/2 | 1.39 | 1.19 | .18 | 2.64 | Red | P71 | 18 | 71H | 1 1/4 | 6 |
| LCAX300-58H-6 | | | | 5/8 | 1.39 | 1.19 | .18 | 2.85 | Red | P71 | 18 | 71H | 1 1/4 | 6 |
| LCAX350-56H-6 | 350 kcmil | 373.7 kcmil | — | 5/16 | 1.54 | 1.29 | .22 | 2.62 | Blue | P76 | 19 | 76H | 1 3/8 | 6 |
| LCAX350-38H-6 | | | | 3/8 | 1.54 | 1.29 | .22 | 2.62 | Blue | P76 | 19 | 76H | 1 3/8 | 6 |
| LCAX350-12H-6 | | | | 1/2 | 1.54 | 1.29 | .22 | 2.78 | Blue | P76 | 19 | 76H | 1 3/8 | 6 |
| LCAX350-58H-6 | | | | 5/8 | 1.54 | 1.29 | .22 | 2.99 | Blue | P76 | 19 | 76H | 1 3/8 | 6 |
| LCAX450-12H-6 | 450 kcmil | 444.4 kcmil | — | 1/2 | 1.70 | 1.40 | .26 | 3.26 | Brown | P87 | 20 | 87H | 1 7/16 | 6 |
| LCAX450-58H-6 | | | | 5/8 | 1.70 | 1.40 | .26 | 3.39 | Brown | P87 | 20 | 87H | 1 7/16 | 6 |
| LCAX500-56H-6 | 500 kcmil | 535.3 kcmil | — | 5/16 | 1.89 | 1.48 | .26 | 2.87 | Pink | P99 | L99 | 99H | 1 9/16 | 6 |
| LCAX500-38H-6 | | | | 3/8 | 1.89 | 1.48 | .26 | 2.87 | Pink | P99 | L99 | 99H | 1 9/16 | 6 |
| LCAX500-12H-6 | | | | 1/2 | 1.89 | 1.48 | .26 | 3.24 | Pink | P99 | L99 | 99H | 1 9/16 | 6 |
| LCAX500-58H-6 | | | | 5/8 | 1.89 | 1.48 | .26 | 3.80 | Pink | P99 | L99 | 99H | 1 9/16 | 6 |
| LCAX650-56H-6 | — | 646.4 kcmil | — | 5/16 | 1.95 | 1.45 | .30 | 2.89 | Black | P106 | 24 | 106H | 1 1/2 | 6 |
| LCAX650-38H-6 | | | | 3/8 | 1.95 | 1.45 | .30 | 2.89 | Black | P106 | 24 | 106H | 1 1/2 | 6 |
| LCAX650-12H-6 | | | | 1/2 | 1.95 | 1.45 | .30 | 3.26 | Black | P106 | 24 | 106H | 1 1/2 | 6 |
| LCAX650-58H-6 | | | | 5/8 | 1.95 | 1.45 | .30 | 3.82 | Black | P106 | 24 | 106H | 1 1/2 | 6 |
| LCAX750-12H-3 | — | 777.7 kcmil | — | 1/2 | 2.17 | 1.66 | .32 | 3.52 | Yellow | P115 | L115 | 115H | 1 3/4 | 3 |
| LCAX750-58H-3 | | | | 5/8 | 2.17 | 1.66 | .32 | 4.18 | Yellow | P115 | L115 | 115H | 1 3/4 | 3 |

‡See pages D3.66 – D3.69 for tool and die information.

**Consult cable manufacturer for voltage stress relief instructions with applications greater than 2000 V.

A.
System
Overview

B1.
Cable Ties

B2.
Cable
Accessories

B3.
Stainless
Steel Ties

C1.
Wiring
Duct

C2.
Surface
Raceway

C3.
Abrasion
Protection

C4.
Cable
Management

D1.
Terminals

D2.
Power
Connectors

D3.
Grounding
Connectors

E1.
Labeling
Systems

E2.
Labels

E3.
Pre-Printed
& Write-On
Markers

E4.
Permanent
Identification

E5.
Lockout/
Tagout
& Safety
Solutions

F.
Index

A. System Overview



Flex Conductor, One-Hole, Standard Barrel with Window Lug, 90° Angle

For Use with Flexible, Extra-Flexible, and Code Stranded Copper Conductors

Type LCAX-F

- Can be used with code conductor and flex conductor class: G, H, I, K, M and Diesel Locomotive
- Generously beveled wire entry prevents bent back strands when inserting conductor into barrel
- Color-coded barrels marked with *PANDUIT* and specified competitor die index numbers for proper crimp die selection
- Inspection window to visually assure full conductor insertion
- Tin-plated to inhibit corrosion
- UL Listed and CSA Certified to 35 KV** and temperature rated to 90°C when crimped with *PANDUIT* and specified competitor crimping tools and dies
- American Bureau of Shipping approved

B1. Cable Ties

B2. Cable Accessories

B3. Stainless Steel Ties

C1. Wiring Duct

C2. Surface Raceway

C3. Abrasion Protection

C4. Cable Management

D1. Terminals

D2. Power Connectors

D3. Grounding Connectors

E1. Labeling Systems

E2. Labels

E3. Pre-Printed & Write-On Markers

E4. Permanent Identification

E5. Lockout/Tagout & Safety Solutions

F. Index

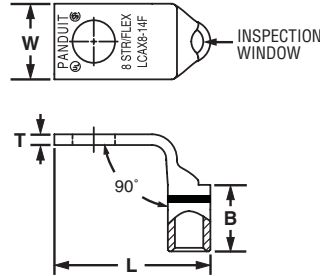

| Part Number | Flex Conductor Size | | Code Conductor Size | Stud Hole Size (In.) | Figure Dimensions (In.) | | | | PANDUIT Color Code | PANDUIT Die Index No.‡ | Burndy Die Index No.‡ | T&B Die Index No.‡ | Wire Strip Length (In.) | Std. Pkg. Qty. |
|---------------|---------------------|-------------------|---------------------|----------------------|-------------------------|-------|-----|------|--------------------|------------------------|-----------------------|--------------------|-------------------------|----------------|
| | Class G, H, I, K, M | Diesel Locomotive | | | W | B | T | L | | | | | | |
| LCAX8-10F-L | #8 AWG | #8 AWG | #8 AWG | #10 | .41 | .42 | .08 | .90 | Red | P21 | 49 | 21 | 1/2 | 50 |
| LCAX8-14F-L | | | | 1/4 | .48 | .42 | .07 | .99 | Red | P21 | 49 | 21 | 1/2 | 50 |
| LCAX8-56F-L | | | | 5/16 | .56 | .42 | .05 | 1.11 | Red | P21 | 49 | 21 | 1/2 | 50 |
| LCAX8-38F-L | | | | 3/8 | .60 | .42 | .05 | 1.21 | Red | P21 | 49 | 21 | 1/2 | 50 |
| LCAX6-10F-L | #6 AWG | #6 AWG | #6 AWG | #10 | .45 | .48 | .09 | .99 | Blue | P24 | 7 | 24 | 9/16 | 50 |
| LCAX6-14F-L | | | | 1/4 | .48 | .48 | .08 | 1.03 | Blue | P24 | 7 | 24 | 9/16 | 50 |
| LCAX6-56F-L | | | | 5/16 | .56 | .48 | .07 | 1.15 | Blue | P24 | 7 | 24 | 9/16 | 50 |
| LCAX6-38F-L | | | | 3/8 | .62 | .48 | .06 | 1.25 | Blue | P24 | 7 | 24 | 9/16 | 50 |
| LCAX4-10F-L | #4 AWG | #5, #4, #3 AWG | #4 AWG | #10 | .55 | .53 | .09 | 1.03 | Gray | P29 | 8 | 29 | 5/8 | 50 |
| LCAX4-14F-L | | | | 1/4 | .55 | .53 | .09 | 1.12 | Gray | P29 | 8 | 29 | 5/8 | 50 |
| LCAX4-56F-L | | | | 5/16 | .55 | .53 | .09 | 1.24 | Gray | P29 | 8 | 29 | 5/8 | 50 |
| LCAX4-38F-L | | | | 3/8 | .62 | .53 | .07 | 1.34 | Gray | P29 | 8 | 29 | 5/8 | 50 |
| LCAX2-10F-E* | #2 AWG | #2 AWG | #2 AWG | #10 | .70 | .59 | .11 | 1.21 | Brown | P33 | 10 | 33 | 11/16 | 20 |
| LCAX2-14F-E* | | | | 1/4 | .70 | .59 | .11 | 1.31 | Brown | P33 | 10 | 33 | 11/16 | 20 |
| LCAX2-56F-E* | | | | 5/16 | .70 | .59 | .11 | 1.44 | Brown | P33 | 10 | 33 | 11/16 | 20 |
| LCAX2-38F-E* | | | | 3/8 | .70 | .59 | .11 | 1.51 | Brown | P33 | 10 | 33 | 11/16 | 20 |
| LCAX2-12F-E* | 1/2 | .75 | .59 | .09 | 1.75 | Brown | P33 | 10 | 33 | 11/16 | 20 | | | |
| LCAX1-10F-X | #1 AWG | #1 AWG | #1 AWG | #10 | .76 | .66 | .12 | 1.28 | Green | P37 | 11 | 37 | 3/4 | 10 |
| LCAX1-14F-X | | | | 1/4 | .76 | .66 | .12 | 1.45 | Green | P37 | 11 | 37 | 3/4 | 10 |
| LCAX1-56F-X | | | | 5/16 | .76 | .66 | .12 | 1.51 | Green | P37 | 11 | 37 | 3/4 | 10 |
| LCAX1-38F-X | | | | 3/8 | .76 | .66 | .12 | 1.58 | Green | P37 | 11 | 37 | 3/4 | 10 |
| LCAX1-12F-X | 1/2 | .80 | .66 | .12 | 1.82 | Green | P37 | 11 | 37 | 3/4 | 10 | | | |
| LCAX1/0-14F-X | 1/0 AWG | 1/0 AWG | 1/0 AWG | 1/4 | .85 | .72 | .13 | 1.59 | Pink | P42 | 12 | 42 | 3/4 | 10 |
| LCAX1/0-56F-X | | | | 5/16 | .85 | .72 | .13 | 1.59 | Pink | P42 | 12 | 42 | 3/4 | 10 |
| LCAX1/0-38F-X | | | | 3/8 | .85 | .72 | .13 | 1.66 | Pink | P42 | 12 | 42 | 3/4 | 10 |
| LCAX1/0-12F-X | | | | 1/2 | .85 | .72 | .13 | 1.91 | Pink | P42 | 12 | 42 | 3/4 | 10 |

‡See pages D3.66 – D3.69 for tool and die information.

*Not UL Listed or CSA Certified with Class K flex conductor when crimped with Burndy tools.

**Consult cable manufacturer for voltage stress relief instructions with applications greater than 2000 V.



Flex Conductor, One-Hole, Standard Barrel with Window Lug, 90° Angle (continued)

| Part Number | Flex Conductor Size | | Code Conductor Size | Stud Hole Size (In.) | Figure Dimensions (In.) | | | | PANDUIT Color Code | PANDUIT Die Index No.‡ | Burndy Die Index No.‡ | T&B Die Index No.‡ | Wire Strip Length (In.) | Std. Pkg. Qty. |
|---------------|---------------------|-------------------|---------------------|----------------------|-------------------------|------|-----|------|--------------------|------------------------|-----------------------|--------------------|-------------------------|----------------|
| | Class G, H, I, K, M | Diesel Locomotive | | | W | B | T | L | | | | | | |
| LCAX2/0-10F-X | 2/0 AWG | 2/0 AWG | 2/0 AWG | #10 | .96 | .83 | .13 | 1.42 | Black | P45 | 13 | 45 | 7/8 | 10 |
| LCAX2/0-14F-X | | | | 1/4 | .96 | .83 | .13 | 1.67 | Black | P45 | 13 | 45 | 7/8 | 10 |
| LCAX2/0-56F-X | | | | 5/16 | .96 | .83 | .13 | 1.67 | Black | P45 | 13 | 45 | 7/8 | 10 |
| LCAX2/0-38F-X | | | | 3/8 | .96 | .83 | .13 | 1.73 | Black | P45 | 13 | 45 | 7/8 | 10 |
| LCAX2/0-12F-X | | | | 1/2 | .96 | .83 | .13 | 1.98 | Black | P45 | 13 | 45 | 7/8 | 10 |
| LCAX2/0-58F-X | | | | 5/8 | .96 | .83 | .13 | 2.27 | Black | P45 | 13 | 45 | 7/8 | 10 |
| LCAX2/0-34F-X | | | | 3/4 | .96 | .83 | .13 | 2.41 | Black | P45 | 13 | 45 | 7/8 | 10 |
| LCAX3/0-10F-X | 3/0 AWG | 3/0 AWG | 3/0 AWG | #10 | 1.06 | .91 | .14 | 1.51 | Orange | P50 | 14 | 50 | 1 | 10 |
| LCAX3/0-14F-X | | | | 1/4 | 1.06 | .91 | .14 | 1.75 | Orange | P50 | 14 | 50 | 1 | 10 |
| LCAX3/0-56F-X | | | | 5/16 | 1.06 | .91 | .14 | 1.77 | Orange | P50 | 14 | 50 | 1 | 10 |
| LCAX3/0-38F-X | | | | 3/8 | 1.06 | .91 | .14 | 1.84 | Orange | P50 | 14 | 50 | 1 | 10 |
| LCAX3/0-12F-X | | | | 1/2 | 1.06 | .91 | .14 | 2.07 | Orange | P50 | 14 | 50 | 1 | 10 |
| LCAX4/0-14F-X | 4/0 AWG | 4/0 AWG | 4/0 AWG | 1/4 | 1.19 | 1.03 | .16 | 1.84 | Purple | P54 | 15 | 54 | 1 1/16 | 10 |
| LCAX4/0-56F-X | | | | 5/16 | 1.19 | 1.03 | .16 | 2.07 | Purple | P54 | 15 | 54 | 1 1/16 | 10 |
| LCAX4/0-38F-X | | | | 3/8 | 1.19 | 1.03 | .16 | 2.07 | Purple | P54 | 15 | 54 | 1 1/16 | 10 |
| LCAX4/0-12F-X | | | | 1/2 | 1.19 | 1.03 | .16 | 2.18 | Purple | P54 | 15 | 54 | 1 1/16 | 10 |
| LCAX4/0-58F-X | | | | 5/8 | 1.19 | 1.03 | .16 | 2.39 | Purple | P54 | 15 | 54 | 1 1/16 | 10 |
| LCAX4/0-34F-X | | | | 3/4 | 1.19 | 1.03 | .16 | 2.58 | Purple | P54 | 15 | 54 | 1 1/16 | 10 |
| LCAX250-14F-X | | | | 250 kcmil | 262.6 kcmil | — | 1/4 | 1.28 | 1.03 | .17 | 1.90 | Yellow | P62 | 16 |
| LCAX250-56F-X | 5/16 | 1.28 | 1.03 | | | | .17 | 2.13 | Yellow | P62 | 16 | 62 | 1 1/16 | 10 |
| LCAX250-38F-X | 3/8 | 1.28 | 1.03 | | | | .17 | 2.13 | Yellow | P62 | 16 | 62 | 1 1/16 | 10 |
| LCAX250-12F-X | 1/2 | 1.28 | 1.03 | | | | .17 | 2.24 | Yellow | P62 | 16 | 62 | 1 1/16 | 10 |
| LCAX250-58F-X | 5/8 | 1.28 | 1.03 | | | | .17 | 2.45 | Yellow | P62 | 16 | 62 | 1 1/16 | 10 |
| LCAX250-34F-X | 3/4 | 1.28 | 1.03 | | | | .17 | 2.64 | Yellow | P62 | 16 | 62 | 1 1/16 | 10 |
| LCAX300-38F-6 | 300 kcmil | 313.1 kcmil | — | | | | 3/8 | 1.39 | 1.19 | .18 | 2.37 | Red | P71 | 18 |
| LCAX300-12F-6 | | | | 1/2 | 1.39 | 1.19 | .18 | 2.37 | Red | P71 | 18 | 71H | 1 1/4 | 6 |
| LCAX300-58F-6 | | | | 5/8 | 1.39 | 1.19 | .18 | 2.58 | Red | P71 | 18 | 71H | 1 1/4 | 6 |
| LCAX350-56F-6 | 350 kcmil | 373.7 kcmil | — | 5/16 | 1.54 | 1.29 | .22 | 2.32 | Blue | P76 | 19 | 76H | 1 3/8 | 6 |
| LCAX350-38F-6 | | | | 3/8 | 1.54 | 1.29 | .22 | 2.32 | Blue | P76 | 19 | 76H | 1 3/8 | 6 |
| LCAX350-12F-6 | | | | 1/2 | 1.54 | 1.29 | .22 | 2.48 | Blue | P76 | 19 | 76H | 1 3/8 | 6 |
| LCAX350-58F-6 | | | | 5/8 | 1.54 | 1.29 | .22 | 2.69 | Blue | P76 | 19 | 76H | 1 3/8 | 6 |
| LCAX450-12F-6 | 450 kcmil | 444.4 kcmil | — | 1/2 | 1.70 | 1.40 | .26 | 2.95 | Brown | P87 | 20 | 87H | 1 7/16 | 6 |
| LCAX450-58F-6 | | | | 5/8 | 1.70 | 1.40 | .26 | 3.08 | Brown | P87 | 20 | 87H | 1 7/16 | 6 |
| LCAX500-56F-6 | 500 kcmil | 535.3 kcmil | — | 5/16 | 1.89 | 1.48 | .26 | 2.44 | Pink | P99 | L99 | 99H | 1 9/16 | 6 |
| LCAX500-38F-6 | | | | 3/8 | 1.89 | 1.48 | .26 | 2.44 | Pink | P99 | L99 | 99H | 1 9/16 | 6 |
| LCAX500-12F-6 | | | | 1/2 | 1.89 | 1.48 | .26 | 2.81 | Pink | P99 | L99 | 99H | 1 9/16 | 6 |
| LCAX500-58F-6 | | | | 5/8 | 1.89 | 1.48 | .26 | 3.37 | Pink | P99 | L99 | 99H | 1 9/16 | 6 |
| LCAX650-56F-6 | — | 646.4 kcmil | — | 5/16 | 1.95 | 1.45 | .30 | 2.50 | Black | P106 | 24 | 106H | 1 1/2 | 6 |
| LCAX650-38F-6 | | | | 3/8 | 1.95 | 1.45 | .30 | 2.50 | Black | P106 | 24 | 106H | 1 1/2 | 6 |
| LCAX650-12F-6 | | | | 1/2 | 1.95 | 1.45 | .30 | 2.86 | Black | P106 | 24 | 106H | 1 1/2 | 6 |
| LCAX650-58F-6 | | | | 5/8 | 1.95 | 1.45 | .30 | 3.42 | Black | P106 | 24 | 106H | 1 1/2 | 6 |
| LCAX750-12F-3 | — | 777.7 kcmil | — | 1/2 | 2.17 | 1.66 | .32 | 2.86 | Yellow | P115 | L115 | 115H | 1 3/4 | 3 |
| LCAX750-58F-3 | | | | 5/8 | 2.17 | 1.66 | .32 | 3.67 | Yellow | P115 | L115 | 115H | 1 3/4 | 3 |

‡See pages D3.66 – D3.69 for tool and die information.

*Not UL Listed or CSA Certified with Class K flex conductor when crimped with Burndy tools.

**Consult cable manufacturer for voltage stress relief instructions with applications greater than 2000 V.

A.
System
Overview

B1.
Cable Ties

B2.
Cable
Accessories

B3.
Stainless
Steel Ties

C1.
Wiring
Duct

C2.
Surface
Raceway

C3.
Abrasion
Protection

C4.
Cable
Management

D1.
Terminals

D2.
Power
Connectors

D3.
Grounding
Connectors

E1.
Labeling
Systems

E2.
Labels

E3.
Pre-Printed
& Write-On
Markers

E4.
Permanent
Identification

E5.
Lockout/
Tagout
& Safety
Solutions

F.
Index

A. System Overview



Flex Conductor, One-Hole, Standard Barrel with Window, Narrow Tongue Lug

For Use with Flexible, Extra-Flexible, and Code Stranded Copper Conductors

B1. Cable Ties

Type LCAXN

- Narrow tongue width for limited space applications
- Can be used with flex conductor class: G, H, I, K, M and Diesel Locomotive
- Generously beveled wire entry prevents bent back strands when inserting conductor into barrel

- Color-coded barrels marked with *PANDUIT* and specified competitor die index numbers for proper crimp die selection
- Inspection window to visually assure full conductor insertion
- Tin-plated to inhibit corrosion
- UL Listed and CSA Certified to 35 KV** and temperature rated to 90°C when crimped with *PANDUIT* and specified competitor crimping tools and dies

B2. Cable Accessories

B3. Stainless Steel Ties

C1. Wiring Duct

C2. Surface Raceway

C3. Abrasion Protection

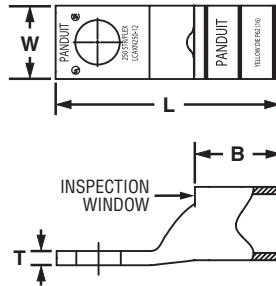

C4. Cable Management

| Part Number | Flex Conductor Size | | Stud Hole Size (In.) | Figure Dimensions (In.) | | | | PANDUIT Color Code | PANDUIT Die Index No.‡ | Burndy Die Index No.‡ | T&B Die Index No.‡ | Wire Strip Length (In.) | Std. Pkg. Qty. |
|---------------|---------------------|-------------------|----------------------|-------------------------|------|-----|------|--------------------|------------------------|-----------------------|--------------------|-------------------------|----------------|
| | Class G, H, I, K, M | Diesel Locomotive | | W | B | T | L | | | | | | |
| LCAXN250-12-X | 250 kcmil | 262.6 kcmil | 1/2 | .88 | 1.03 | .17 | 2.68 | Yellow | P62 | 16 | 62 | 1 1/16 | 10 |

‡See pages D3.66 – D3.69 for tool and die information.

**Consult cable manufacturer for voltage stress relief instructions with applications greater than 2000 V.

D1. Terminals

D2. Power Connectors



Flex Conductor, One-Hole, Standard Barrel with Window, Narrow Tongue Lug, 45°

For Use with Flexible, Extra-Flexible, and Code Stranded Copper Conductors

D3. Grounding Connectors

Type LCAXN-H

- Narrow tongue width for limited space applications
- Can be used with flex conductor class: G, H, I, K, M and Diesel Locomotive
- Generously beveled wire entry prevents bent back strands when inserting conductor into barrel

- Color-coded barrels marked with *PANDUIT* and specified competitor die index numbers for proper crimp die selection
- Inspection window to visually assure full conductor insertion
- Tin-plated to inhibit corrosion
- UL Listed and CSA Certified to 35 KV** and temperature rated to 90°C when crimped with *PANDUIT* and specified competitor crimping tools and dies

E1. Labeling Systems

E2. Labels

E3. Pre-Printed & Write-On Markers

E4. Permanent Identification

E5. Lockout/Tagout & Safety Solutions

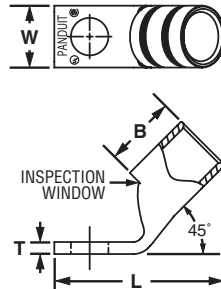

| Part Number | Flex Conductor Size | | Stud Hole Size (In.) | Figure Dimensions (In.) | | | | PANDUIT Color Code | PANDUIT Die Index No.‡ | Burndy Die Index No.‡ | T&B Die Index No.‡ | Wire Strip Length (In.) | Std. Pkg. Qty. |
|----------------|---------------------|-------------------|----------------------|-------------------------|------|-----|------|--------------------|------------------------|-----------------------|--------------------|-------------------------|----------------|
| | Class G, H, I, K, M | Diesel Locomotive | | W | B | T | L | | | | | | |
| LCAXN250-12H-X | 250 kcmil | 262.6 kcmil | 1/2 | .88 | 1.03 | .17 | 2.41 | Yellow | P62 | 16 | 62 | 1 1/16 | 10 |

‡See pages D3.66 – D3.69 for tool and die information.

**Consult cable manufacturer for voltage stress relief instructions with applications greater than 2000 V.

F. Index



Flex Conductor, One-Hole, Standard Barrel with Window, Narrow Tongue Lug, 90°

For Use with Flexible, Extra-Flexible, and Code Stranded Copper Conductors

Type LCAXN-F

- Narrow tongue width for limited space applications
- Can be used with flex conductor class: G, H, I, K, M and Diesel Locomotive
- Generously beveled wire entry prevents bent back strands when inserting conductor into barrel
- Color-coded barrels marked with *PANDUIT* and specified competitor die index numbers for proper crimp die selection
- Inspection window to visually assure full conductor insertion
- Tin-plated to inhibit corrosion
- UL Listed and CSA Certified to 35 KV** and temperature rated to 90°C when crimped with *PANDUIT* and specified competitor crimping tools and dies

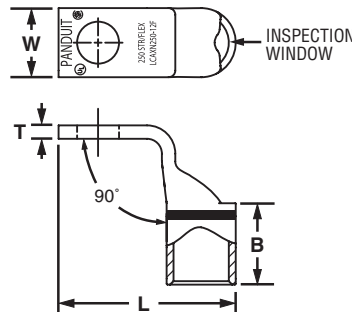

| Part Number | Flex Conductor Size | | Stud Hole Size (In.) | Figure Dimensions (In.) | | | | PANDUIT Color Code | PANDUIT Die Index No.‡ | Burdny Die Index No.‡ | T&B Die Index No.‡ | Wire Strip Length (In.) | Std. Pkg. Qty. |
|----------------|---------------------|-------------------|----------------------|-------------------------|------|-----|------|--------------------|------------------------|-----------------------|--------------------|-------------------------|----------------|
| | Class G, H, I, K, M | Diesel Locomotive | | W | B | T | L | | | | | | |
| LCAXN250-12F-X | 250 kcmil | 262.6 kcmil | 1/2 | .88 | 1.03 | .17 | 2.24 | Yellow | P62 | 16 | 62 | 1 1/16 | 10 |

‡See pages D3.66 – D3.69 for tool and die information.

**Consult cable manufacturer for voltage stress relief instructions with applications greater than 2000 V.

A. System Overview

B1. Cable Ties

B2. Cable Accessories

B3. Stainless Steel Ties

C1. Wiring Duct

C2. Surface Raceway

C3. Abrasion Protection

C4. Cable Management

D1. Terminals

D2. Power Connectors

D3. Grounding Connectors

E1. Labeling Systems

E2. Labels

E3. Pre-Printed & Write-On Markers

E4. Permanent Identification

E5. Lockout/Tagout & Safety Solutions

F. Index

A. System Overview



Flex Conductor, One-Hole, Standard Barrel with Window, Flared NEBS Lug

B1. Cable Ties

For Use with Flexible and Extra-Flexible Copper Conductors

Type LCAF

- Can be used with flex conductor class: K, M, and Diesel Locomotive
- Flared entry prevents bent back strands when inserting fine strand conductor into barrel
- Color-coded barrels marked with *PANDUIT* die index numbers for proper crimp die selection
- Inspection window to visually assure full conductor insertion

- Tin-plated to inhibit corrosion
- UL Listed and CSA Certified to 35 KV** and temperature rated to 90°C when crimped with *PANDUIT* crimping tools and dies
- **Tested by Telcordia – meets NEBS Level 3**
- American Bureau of Shipping approved

B2. Cable Accessories

B3. Stainless Steel Ties

C1. Wiring Duct

C2. Surface Raceway

C3. Abrasion Protection

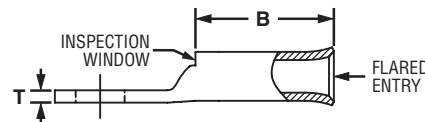
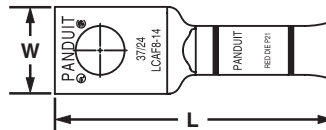

C4. Cable Management

| Part Number | Flex Conductor Size | | Stud Hole Size (In.) | Figure Dimensions (In.) | | | | PANDUIT Color Code | PANDUIT Die Index No.‡ | Wire Strip Length (In.) | Std. Pkg. Qty. |
|---------------------|---------------------|-------------------|----------------------|-------------------------|------|-----|------|--------------------|------------------------|-------------------------|----------------|
| | Class K and M | Diesel Locomotive | | W | B | T | L | | | | |
| LCAF8-10-L | — | #8 AWG | #10 | .41 | .76 | .08 | 1.45 | Red | P21 | 13/16 | 50 |
| LCAF8-14-L | | | 1/4 | .48 | .76 | .07 | 1.54 | Red | P21 | 13/16 | 50 |
| LCAF8-56-L | | | 5/16 | .56 | .76 | .05 | 1.66 | Red | P21 | 13/16 | 50 |
| LCAF8-38-L | | | 3/8 | .60 | .76 | .05 | 1.76 | Red | P21 | 13/16 | 50 |
| LCAF6-10-L | #6 AWG | #6 AWG | #10 | .45 | .81 | .09 | 1.52 | Blue | P24 | 7/8 | 50 |
| LCAF6-14-L | | | 1/4 | .48 | .81 | .08 | 1.61 | Blue | P24 | 7/8 | 50 |
| LCAF6-56-L | | | 5/16 | .56 | .81 | .07 | 1.73 | Blue | P24 | 7/8 | 50 |
| LCAF6-38-L | | | 3/8 | .62 | .81 | .06 | 1.83 | Blue | P24 | 7/8 | 50 |
| LCAF4-10-L | #4 AWG | #4 AWG | #10 | .55 | .81 | .09 | 1.54 | Gray | P29 | 7/8 | 50 |
| LCAF4-14-L | | | 1/4 | .55 | .81 | .09 | 1.63 | Gray | P29 | 7/8 | 50 |
| LCAF4-56-L | | | 5/16 | .55 | .81 | .09 | 1.75 | Gray | P29 | 7/8 | 50 |
| LCAF4-38-L | | | 3/8 | .62 | .81 | .07 | 1.85 | Gray | P29 | 7/8 | 50 |
| LCAF2-14-E | #2 AWG | #2 AWG | 1/4 | .70 | .88 | .11 | 1.79 | Brown | P33 | 15/16 | 20 |
| LCAF2-56-E | | | 5/16 | .70 | .88 | .11 | 1.92 | Brown | P33 | 15/16 | 20 |
| LCAF2-38-E | | | 3/8 | .70 | .88 | .11 | 1.99 | Brown | P33 | 15/16 | 20 |
| LCAF2-12-E | | | 1/2 | .79 | .88 | .09 | 2.23 | Brown | P33 | 15/16 | 20 |
| LCAF1-14-X | #1 AWG | #1 AWG | 1/4 | .76 | .94 | .12 | 1.95 | Pink | P42 | 1 | 10 |
| LCAF1-56-X | | | 5/16 | .76 | .94 | .12 | 2.00 | Pink | P42 | 1 | 10 |
| LCAF1-38-X | | | 3/8 | .76 | .94 | .12 | 2.08 | Pink | P42 | 1 | 10 |
| LCAF1-12-X | | | 1/2 | .80 | .94 | .12 | 2.31 | Pink | P42 | 1 | 10 |
| LCAF1/0-14-X | 1/0 AWG | 1/0 AWG | 1/4 | .85 | 1.35 | .13 | 2.46 | Black | P45 | 1 7/16 | 10 |
| LCAF1/0-56-X | | | 5/16 | .85 | 1.35 | .13 | 2.46 | Black | P45 | 1 7/16 | 10 |
| LCAF1/0-38-X | | | 3/8 | .85 | 1.35 | .13 | 2.52 | Black | P45 | 1 7/16 | 10 |
| LCAF1/0-12-X | | | 1/2 | .85 | 1.35 | .13 | 2.77 | Black | P45 | 1 7/16 | 10 |
| LCAF2/0-14-X | 2/0 AWG | 2/0 AWG | 1/4 | .96 | 1.35 | .13 | 2.49 | Orange | P50 | 1 7/16 | 10 |
| LCAF2/0-56-X | | | 5/16 | .96 | 1.35 | .13 | 2.49 | Orange | P50 | 1 7/16 | 10 |
| LCAF2/0-38-X | | | 3/8 | .96 | 1.35 | .13 | 2.55 | Orange | P50 | 1 7/16 | 10 |
| LCAF2/0-12-X | | | 1/2 | .96 | 1.35 | .13 | 2.80 | Orange | P50 | 1 7/16 | 10 |

‡See pages D3.70, D3.71 for tool and die information.

**Consult cable manufacturer for voltage stress relief instructions with applications greater than 2000 V.

E5. Lockout/Tagout & Safety Solutions

F. Index



Flex Conductor, One-Hole, Standard Barrel with Window, Flared NEBS Lug (continued)

| Part Number | Flex Conductor Size | | Stud Hole Size (In.) | Figure Dimensions (In.) | | | | PANDUIT Color Code | PANDUIT Die Index No.‡ | Wire Strip Length (In.) | Std. Pkg. Qty. |
|---------------------|---------------------|-------------------|----------------------|-------------------------|------|-----|------|--------------------|------------------------|-------------------------|----------------|
| | Class K and M | Diesel Locomotive | | W | B | T | L | | | | |
| LCAF3/0-14-X | 3/0 AWG | 3/0 AWG | 1/4 | 1.06 | 1.35 | .14 | 2.52 | Purple | P54 | 1 7/16 | 10 |
| LCAF3/0-56-X | | | 5/16 | 1.06 | 1.35 | .14 | 2.53 | Purple | P54 | 1 7/16 | 10 |
| LCAF3/0-38-X | | | 3/8 | 1.06 | 1.35 | .14 | 2.60 | Purple | P54 | 1 7/16 | 10 |
| LCAF3/0-12-X | | | 1/2 | 1.06 | 1.35 | .14 | 2.83 | Purple | P54 | 1 7/16 | 10 |
| LCAF4/0-14-X | 4/0 AWG | 4/0 AWG | 1/4 | 1.17 | 1.35 | .14 | 2.56 | Yellow | P62 | 1 7/16 | 10 |
| LCAF4/0-56-X | | | 5/16 | 1.17 | 1.35 | .14 | 2.58 | Yellow | P62 | 1 7/16 | 10 |
| LCAF4/0-38-X | | | 3/8 | 1.17 | 1.35 | .14 | 2.65 | Yellow | P62 | 1 7/16 | 10 |
| LCAF4/0-12-X | | | 1/2 | 1.17 | 1.35 | .14 | 2.88 | Yellow | P62 | 1 7/16 | 10 |
| LCAF250-38-X | 250 kcmil | 262.6 kcmil | 3/8 | 1.28 | 1.65 | .17 | 3.19 | White | P66 | 1 3/4 | 10 |
| LCAF250-12-X | | | 1/2 | 1.28 | 1.65 | .17 | 3.30 | White | P66 | 1 3/4 | 10 |
| LCAF250-58-X | | | 5/8 | 1.28 | 1.65 | .17 | 3.51 | White | P66 | 1 3/4 | 10 |
| LCAF250-78-X | | | 7/8 | 1.28 | 1.65 | .17 | 3.95 | White | P66 | 1 3/4 | 10 |
| LCAF300-38-6 | 300 kcmil | 313.1 kcmil | 3/8 | 1.39 | 1.65 | .18 | 3.37 | Red | P71 | 1 3/4 | 6 |
| LCAF300-12-6 | | | 1/2 | 1.39 | 1.65 | .18 | 3.37 | Red | P71 | 1 3/4 | 6 |
| LCAF300-58-6 | | | 5/8 | 1.39 | 1.65 | .18 | 3.58 | Red | P71 | 1 3/4 | 6 |
| LCAF300-78-6 | | | 7/8 | 1.39 | 1.65 | .18 | 3.97 | Red | P71 | 1 3/4 | 6 |
| LCAF350-38-6 | 350 kcmil | 373.7 kcmil | 3/8 | 1.54 | 1.85 | .22 | 3.49 | Blue | P76 | 1 15/16 | 6 |
| LCAF350-12-6 | | | 1/2 | 1.54 | 1.85 | .22 | 3.65 | Blue | P76 | 1 15/16 | 6 |
| LCAF350-58-6 | | | 5/8 | 1.54 | 1.85 | .22 | 3.86 | Blue | P76 | 1 15/16 | 6 |
| LCAF350-34-6 | | | 3/4 | 1.54 | 1.85 | .22 | 4.00 | Blue | P76 | 1 15/16 | 6 |
| LCAF350-78-6 | | | 7/8 | 1.54 | 1.85 | .22 | 4.25 | Blue | P76 | 1 15/16 | 6 |
| LCAF350-1-6 | | | 1 | 1.54 | 1.85 | .22 | 4.37 | Blue | P76 | 1 15/16 | 6 |
| LCAF400-12-6 | 400 kcmil | 444.4 kcmil | 1/2 | 1.70 | 2.20 | .26 | 4.65 | Brown | P87 | 2 1/4 | 6 |
| LCAF400-58-6 | | | 5/8 | 1.70 | 2.20 | .26 | 4.65 | Brown | P87 | 2 1/4 | 6 |
| LCAF400-78-6 | | | 7/8 | 1.70 | 2.20 | .26 | 4.65 | Brown | P87 | 2 1/4 | 6 |
| LCAF500-12-6 | 500 kcmil | 535.3 kcmil | 1/2 | 1.89 | 2.28 | .26 | 4.99 | Pink | P99 | 2 5/16 | 6 |
| LCAF500-58-6 | | | 5/8 | 1.89 | 2.28 | .26 | 5.18 | Pink | P99 | 2 5/16 | 6 |
| LCAF600-12-6 | — | 646.4 kcmil | 1/2 | 1.95 | 2.33 | .30 | 5.07 | Black | P106 | 2 3/8 | 6 |
| LCAF600-58-6 | | | 5/8 | 1.95 | 2.33 | .30 | 5.26 | Black | P106 | 2 3/8 | 6 |
| LCAF750-12-3 | — | 777.7 kcmil | 1/2 | 2.17 | 2.38 | .32 | 5.21 | Orange | P107 | 2 7/16 | 3 |
| LCAF750-58-3 | | | 5/8 | 2.17 | 2.38 | .32 | 5.40 | Orange | P107 | 2 7/16 | 3 |

‡See pages D3.70, D3.71 for tool and die information.

**Consult cable manufacturer for voltage stress relief instructions with applications greater than 2000 V.

A. System Overview

B1. Cable Ties

B2. Cable Accessories

B3. Stainless Steel Ties

C1. Wiring Duct

C2. Surface Raceway

C3. Abrasion Protection

C4. Cable Management

D1. Terminals

D2. Power Connectors

D3. Grounding Connectors

E1. Labeling Systems

E2. Labels

E3. Pre-Printed & Write-On Markers

E4. Permanent Identification

E5. Lockout/Tagout & Safety Solutions

F. Index

A. System Overview



Flex Conductor, One-Hole, Standard Barrel with Window, Flared NEBS Lug, 45° Angle

B1. Cable Ties

For Use with Flexible and Extra-Flexible Copper Conductors

Type LCAF-H

B2. Cable Accessories

- Can be used with flex conductor class: K, M, and Diesel Locomotive
- Flared entry prevents bent back strands when inserting fine strand conductor into barrel

- Tin-plated to inhibit corrosion

B3. Stainless Steel Ties

- Color-coded barrels marked with *PANDUIT* die index numbers for proper crimp die selection
- Inspection window to visually assure full conductor insertion

- UL Listed and CSA Certified to 35 KV** and temperature rated to 90°C when crimped with *PANDUIT* crimping tools and dies

- **Tested by Telcordia – meets NEBS Level 3**
- American Bureau of Shipping approved

C1. Wiring Duct

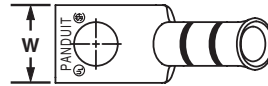

C2. Surface Raceway



C3. Abrasion Protection

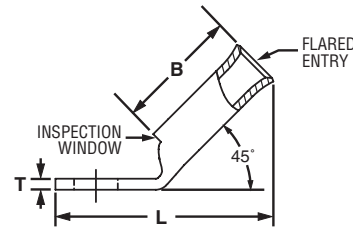

C4. Cable Management

| Part Number | Flex Conductor Size | | Stud Hole Size (In.) | Figure Dimensions (In.) | | | | PANDUIT Color Code | PANDUIT Die Index No.‡ | Wire Strip Length (In.) | Std. Pkg. Qty. |
|---------------|---------------------|-------------------|----------------------|-------------------------|------|-----|------|--------------------|------------------------|-------------------------|----------------|
| | Class K and M | Diesel Locomotive | | W | B | T | L | | | | |
| LCAF8-10H-L | — | #8 AWG | #10 | .41 | .76 | .08 | 1.26 | Red | P21 | 13/16 | 50 |
| LCAF8-14H-L | | | 1/4 | .48 | .76 | .07 | 1.35 | Red | P21 | 13/16 | 50 |
| LCAF8-56H-L | | | 5/16 | .56 | .76 | .05 | 1.46 | Red | P21 | 13/16 | 50 |
| LCAF8-38H-L | #6 AWG | #6 AWG | 3/8 | .60 | .76 | .05 | 1.55 | Red | P21 | 13/16 | 50 |
| LCAF6-10H-L | | | #10 | .45 | .81 | .09 | 1.31 | Blue | P24 | 7/8 | 50 |
| LCAF6-14H-L | | | 1/4 | .48 | .81 | .08 | 1.40 | Blue | P24 | 7/8 | 50 |
| LCAF6-56H-L | #4 AWG | #4 AWG | 5/16 | .56 | .81 | .07 | 1.51 | Blue | P24 | 7/8 | 50 |
| LCAF6-38H-L | | | 3/8 | .62 | .81 | .06 | 1.61 | Blue | P24 | 7/8 | 50 |
| LCAF4-10H-L | | | #10 | .55 | .81 | .09 | 1.34 | Gray | P29 | 7/8 | 50 |
| LCAF4-14H-L | #2 AWG | #2 AWG | 1/4 | .55 | .81 | .09 | 1.43 | Gray | P29 | 7/8 | 50 |
| LCAF4-56H-L | | | 5/16 | .55 | .81 | .09 | 1.55 | Gray | P29 | 7/8 | 50 |
| LCAF4-38H-L | | | 3/8 | .62 | .81 | .07 | 1.64 | Gray | P29 | 7/8 | 50 |
| LCAF2-14H-E | #1 AWG | #1 AWG | 1/4 | .70 | .88 | .11 | 1.52 | Brown | P33 | 15/16 | 20 |
| LCAF2-56H-E | | | 5/16 | .70 | .88 | .11 | 1.65 | Brown | P33 | 15/16 | 20 |
| LCAF2-38H-E | | | 3/8 | .70 | .88 | .11 | 1.72 | Brown | P33 | 15/16 | 20 |
| LCAF2-12H-E | #1/0 AWG | #1/0 AWG | 1/2 | .79 | .88 | .09 | 1.95 | Brown | P33 | 15/16 | 20 |
| LCAF1-14H-X | | | 1/4 | .76 | .94 | .12 | 1.65 | Pink | P42 | 1 | 10 |
| LCAF1-56H-X | | | 5/16 | .76 | .94 | .12 | 1.71 | Pink | P42 | 1 | 10 |
| LCAF1-38H-X | 2/0 AWG | 2/0 AWG | 3/8 | .76 | .94 | .12 | 1.78 | Pink | P42 | 1 | 10 |
| LCAF1-12H-X | | | 1/2 | .80 | .94 | .12 | 2.01 | Pink | P42 | 1 | 10 |
| LCAF1/0-14H-X | | | 1/4 | .85 | 1.35 | .13 | 2.06 | Black | P45 | 1 7/16 | 10 |
| LCAF1/0-56H-X | 2/0 AWG | 2/0 AWG | 5/16 | .85 | 1.35 | .13 | 2.06 | Black | P45 | 1 7/16 | 10 |
| LCAF1/0-38H-X | | | 3/8 | .85 | 1.35 | .13 | 2.12 | Black | P45 | 1 7/16 | 10 |
| LCAF1/0-12H-X | | | 1/2 | .85 | 1.35 | .13 | 2.37 | Black | P45 | 1 7/16 | 10 |
| LCAF2/0-14H-X | 2/0 AWG | 2/0 AWG | 1/4 | .96 | 1.35 | .13 | 2.08 | Orange | P50 | 1 7/16 | 10 |
| LCAF2/0-56H-X | | | 5/16 | .96 | 1.35 | .13 | 2.08 | Orange | P50 | 1 7/16 | 10 |
| LCAF2/0-38H-X | | | 3/8 | .96 | 1.35 | .13 | 2.14 | Orange | P50 | 1 7/16 | 10 |
| LCAF2/0-12H-X | | | 1/2 | .96 | 1.35 | .13 | 2.39 | Orange | P50 | 1 7/16 | 10 |

‡See pages D3.70, D3.71 for tool and die information.

**Consult cable manufacturer for voltage stress relief instructions with applications greater than 2000 V.



Flex Conductor, One-Hole, Standard Barrel with Window, Flared NEBS Lug, 45° Angle (continued)

| Part Number | Flex Conductor Size | | Stud Hole Size (In.) | Figure Dimensions (In.) | | | | PANDUIT Color Code | PANDUIT Die Index No.‡ | Wire Strip Length (In.) | Std. Pkg. Qty. |
|---------------|---------------------|-------------------|----------------------|-------------------------|------|-----|------|--------------------|------------------------|-------------------------|----------------|
| | Class K and M | Diesel Locomotive | | W | B | T | L | | | | |
| LCAF3/0-14H-X | 3/0 AWG | 3/0 AWG | 1/4 | 1.06 | 1.35 | .14 | 2.11 | Purple | P54 | 1 7/16 | 10 |
| LCAF3/0-56H-X | | | 5/16 | 1.06 | 1.35 | .14 | 2.13 | Purple | P54 | 1 7/16 | 10 |
| LCAF3/0-38H-X | | | 3/8 | 1.06 | 1.35 | .14 | 2.20 | Purple | P54 | 1 7/16 | 10 |
| LCAF3/0-12H-X | | | 1/2 | 1.06 | 1.35 | .14 | 2.43 | Purple | P54 | 1 7/16 | 10 |
| LCAF4/0-14H-X | 4/0 AWG | 4/0 AWG | 1/4 | 1.17 | 1.35 | .14 | 2.16 | Yellow | P62 | 1 7/16 | 10 |
| LCAF4/0-56H-X | | | 5/16 | 1.17 | 1.35 | .14 | 2.17 | Yellow | P62 | 1 7/16 | 10 |
| LCAF4/0-38H-X | | | 3/8 | 1.17 | 1.35 | .14 | 2.24 | Yellow | P62 | 1 7/16 | 10 |
| LCAF4/0-12H-X | | | 1/2 | 1.17 | 1.35 | .14 | 2.47 | Yellow | P62 | 1 7/16 | 10 |
| LCAF250-38H-X | 250 kcmil | 262.6 kcmil | 3/8 | 1.28 | 1.65 | .17 | 3.19 | White | P66 | 1 3/4 | 10 |
| LCAF250-12H-X | | | 1/2 | 1.28 | 1.65 | .17 | 2.89 | White | P66 | 1 3/4 | 10 |
| LCAF250-58H-X | | | 5/8 | 1.28 | 1.65 | .17 | 3.10 | White | P66 | 1 3/4 | 10 |
| LCAF250-78H-X | | | 7/8 | 1.28 | 1.65 | .17 | 3.54 | White | P66 | 1 3/4 | 10 |
| LCAF300-38H-6 | 300 kcmil | 313.1 kcmil | 3/8 | 1.39 | 1.64 | .18 | 3.00 | Red | P71 | 1 3/4 | 6 |
| LCAF300-12H-6 | | | 1/2 | 1.39 | 1.64 | .18 | 3.00 | Red | P71 | 1 3/4 | 6 |
| LCAF300-58H-6 | | | 5/8 | 1.39 | 1.64 | .18 | 3.21 | Red | P71 | 1 3/4 | 6 |
| LCAF300-78H-6 | | | 7/8 | 1.39 | 1.64 | .18 | 3.60 | Red | P71 | 1 3/4 | 6 |
| LCAF350-38H-6 | 350 kcmil | 373.7 kcmil | 3/8 | 1.54 | 1.84 | .22 | 3.06 | Blue | P76 | 1 15/16 | 6 |
| LCAF350-12H-6 | | | 1/2 | 1.54 | 1.84 | .22 | 3.22 | Blue | P76 | 1 15/16 | 6 |
| LCAF350-58H-6 | | | 5/8 | 1.54 | 1.84 | .22 | 3.43 | Blue | P76 | 1 15/16 | 6 |
| LCAF350-34H-6 | | | 3/4 | 1.54 | 1.84 | .22 | 3.57 | Blue | P76 | 1 15/16 | 6 |
| LCAF350-78H-6 | | | 7/8 | 1.54 | 1.84 | .22 | 3.82 | Blue | P76 | 1 15/16 | 6 |
| LCAF350-1H-6 | | | 1 | 1.54 | 1.84 | .22 | 3.94 | Blue | P76 | 1 15/16 | 6 |
| LCAF400-12H-6 | 400 kcmil | 444.4 kcmil | 1/2 | 1.70 | 2.19 | .26 | 4.12 | Brown | P87 | 2 1/4 | 6 |
| LCAF400-58H-6 | | | 5/8 | 1.70 | 2.19 | .26 | 4.12 | Brown | P87 | 2 1/4 | 6 |
| LCAF400-78H-6 | | | 7/8 | 1.70 | 2.19 | .26 | 4.12 | Brown | P87 | 2 1/4 | 6 |

‡See pages D3.70, D3.71 for tool and die information.

**Consult cable manufacturer for voltage stress relief instructions with applications greater than 2000 V.

A. System Overview

B1. Cable Ties

B2. Cable Accessories

B3. Stainless Steel Ties

C1. Wiring Duct

C2. Surface Raceway

C3. Abrasion Protection

C4. Cable Management

D1. Terminals

D2. Power Connectors

D3. Grounding Connectors

E1. Labeling Systems

E2. Labels

E3. Pre-Printed & Write-On Markers

E4. Permanent Identification

E5. Lockout/Tagout & Safety Solutions

F. Index

A. System Overview



Flex Conductor, One-Hole, Standard Barrel with Window, Flared NEBS Lug, 90° Angle

B1. Cable Ties

For Use with Flexible and Extra-Flexible Copper Conductors

Type LCAF-F

- Can be used with flex conductor class: K, M, and Diesel Locomotive
- Flared entry prevents bent back strands when inserting fine strand conductor into barrel
- Color-coded barrels marked with *PANDUIT* die index numbers for proper crimp die selection
- Inspection window to visually assure full conductor insertion
- Tin-plated to inhibit corrosion
- UL Listed and CSA Certified to 35 KV** and temperature rated to 90°C when crimped with *PANDUIT* crimping tools and dies
- **Tested by Telcordia – meets NEBS Level 3**
- American Bureau of Shipping Approved

C1. Wiring Duct

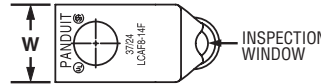

C2. Surface Raceway

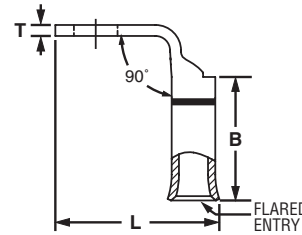

C3. Abrasion Protection

C4. Cable Management

D1. Terminals

D2. Power Connectors

D3. Grounding Connectors

E1. Labeling Systems

E2. Labels

E3. Pre-Printed & Write-On Markers

E4. Permanent Identification

E5. Lockout/Tagout & Safety Solutions

F. Index

| Part Number | Flex Conductor Size | | Stud Hole Size (In.) | Figure Dimensions (In.) | | | | PANDUIT Color Code | PANDUIT Die Index No.‡ | Wire Strip Length (In.) | Std. Pkg. Qty. |
|---------------|---------------------|-------------------|----------------------|-------------------------|------|-----|------|--------------------|------------------------|-------------------------|----------------|
| | Class K and M | Diesel Locomotive | | W | B | T | L | | | | |
| LCAF8-10F-L | — | #8 AWG | #10 | .41 | .76 | .08 | .93 | Red | P21 | 13/16 | 50 |
| LCAF8-14F-L | | | 1/4 | .48 | .76 | .07 | 1.02 | Red | P21 | 13/16 | 50 |
| LCAF8-56F-L | | | 5/16 | .56 | .76 | .05 | 1.14 | Red | P21 | 13/16 | 50 |
| LCAF8-38F-L | #6 AWG | #6 AWG | 3/8 | .60 | .76 | .05 | 1.24 | Red | P21 | 13/16 | 50 |
| LCAF6-10F-L | | | #10 | .45 | .81 | .09 | 1.52 | Blue | P24 | 7/8 | 50 |
| LCAF6-14F-L | | | 1/4 | .48 | .81 | .08 | 1.06 | Blue | P24 | 7/8 | 50 |
| LCAF6-56F-L | #4 AWG | #4 AWG | 5/16 | .56 | .81 | .07 | 1.18 | Blue | P24 | 7/8 | 50 |
| LCAF6-38F-L | | | 3/8 | .62 | .81 | .06 | 1.28 | Blue | P24 | 7/8 | 50 |
| LCAF4-10F-L | | | #10 | .55 | .81 | .09 | 1.07 | Gray | P29 | 7/8 | 50 |
| LCAF4-14F-L | #1 AWG | #1 AWG | 1/4 | .55 | .81 | .09 | 1.16 | Gray | P29 | 7/8 | 50 |
| LCAF4-56F-L | | | 5/16 | .55 | .81 | .09 | 1.28 | Gray | P29 | 7/8 | 50 |
| LCAF4-38F-L | | | 3/8 | .62 | .81 | .07 | 1.38 | Gray | P29 | 7/8 | 50 |
| LCAF2-14F-E | #2 AWG | #2 AWG | 1/4 | .70 | .88 | .11 | 1.35 | Brown | P33 | 15/16 | 20 |
| LCAF2-56F-E | | | 5/16 | .70 | .88 | .11 | 1.48 | Brown | P33 | 15/16 | 20 |
| LCAF2-38F-E | | | 3/8 | .70 | .88 | .11 | 1.55 | Brown | P33 | 15/16 | 20 |
| LCAF2-12F-E | #1 AWG | #1 AWG | 1/2 | .79 | .88 | .09 | 1.79 | Brown | P33 | 15/16 | 20 |
| LCAF1-14F-X | | | 1/4 | .76 | .94 | .12 | 1.49 | Pink | P42 | 1 | 10 |
| LCAF1-56F-X | | | 5/16 | .76 | .94 | .12 | 1.54 | Pink | P42 | 1 | 10 |
| LCAF1-38F-X | 1/0 AWG | 1/0 AWG | 3/8 | .76 | .94 | .12 | 1.62 | Pink | P42 | 1 | 10 |
| LCAF1-12F-X | | | 1/2 | .80 | .94 | .12 | 1.85 | Pink | P42 | 1 | 10 |
| LCAF1/0-14F-X | | | 1/4 | .85 | 1.35 | .13 | 1.64 | Black | P45 | 1 7/16 | 10 |
| LCAF1/0-56F-X | 2/0 AWG | 2/0 AWG | 5/16 | .85 | 1.35 | .13 | 1.70 | Black | P45 | 1 7/16 | 10 |
| LCAF1/0-38F-X | | | 3/8 | .85 | 1.35 | .13 | 1.70 | Black | P45 | 1 7/16 | 10 |
| LCAF1/0-12F-X | | | 1/2 | .85 | 1.35 | .13 | 1.95 | Black | P45 | 1 7/16 | 10 |
| LCAF2/0-14F-X | 2/0 AWG | 2/0 AWG | 1/4 | .96 | 1.35 | .13 | 1.71 | Orange | P50 | 1 7/16 | 10 |
| LCAF2/0-56F-X | | | 5/16 | .96 | 1.35 | .13 | 1.71 | Orange | P50 | 1 7/16 | 10 |
| LCAF2/0-38F-X | | | 3/8 | .96 | 1.35 | .13 | 1.77 | Orange | P50 | 1 7/16 | 10 |
| LCAF2/0-12F-X | | | 1/2 | .96 | 1.35 | .13 | 2.02 | Orange | P50 | 1 7/16 | 10 |

‡See pages D3.70, D3.71 for tool and die information.

**Consult cable manufacturer for voltage stress relief instructions with applications greater than 2000 V.



Flex Conductor, One-Hole, Standard Barrel with Window, Flared NEBS Lug, 90° Angle (continued)

| Part Number | Flex Conductor Size | | Stud Hole Size (In.) | Figure Dimensions (In.) | | | | PANDUIT Color Code | PANDUIT Die Index No.‡ | Wire Strip Length (In.) | Std. Pkg. Qty. |
|---------------|---------------------|-------------------|----------------------|-------------------------|------|-----|------|--------------------|------------------------|-------------------------|----------------|
| | Class K and M | Diesel Locomotive | | W | B | T | L | | | | |
| LCAF3/0-14F-X | 3/0 AWG | 3/0 AWG | 1/4 | 1.06 | 1.35 | .14 | 1.81 | Purple | P54 | 1 7/16 | 10 |
| LCAF3/0-56F-X | | | 5/16 | 1.06 | 1.35 | .14 | 1.82 | Purple | P54 | 1 7/16 | 10 |
| LCAF3/0-38F-X | | | 3/8 | 1.06 | 1.35 | .14 | 1.89 | Purple | P54 | 1 7/16 | 10 |
| LCAF3/0-12F-X | | | 1/2 | 1.06 | 1.35 | .14 | 2.12 | Purple | P54 | 1 7/16 | 10 |
| LCAF4/0-14F-X | 4/0 AWG | 4/0 AWG | 1/4 | 1.17 | 1.35 | .14 | 1.88 | Yellow | P62 | 1 7/16 | 10 |
| LCAF4/0-56F-X | | | 5/16 | 1.17 | 1.35 | .14 | 1.90 | Yellow | P62 | 1 7/16 | 10 |
| LCAF4/0-38F-X | | | 3/8 | 1.17 | 1.35 | .14 | 1.97 | Yellow | P62 | 1 7/16 | 10 |
| LCAF4/0-12F-X | | | 1/2 | 1.17 | 1.35 | .14 | 2.20 | Yellow | P62 | 1 7/16 | 10 |
| LCAF250-38F-X | 250 kcmil | 262.6 kcmil | 3/8 | 1.28 | 1.65 | .17 | 2.21 | White | P66 | 1 3/4 | 10 |
| LCAF250-12F-X | | | 1/2 | 1.28 | 1.65 | .17 | 2.32 | White | P66 | 1 3/4 | 10 |
| LCAF250-58F-X | | | 5/8 | 1.28 | 1.65 | .17 | 2.53 | White | P66 | 1 3/4 | 10 |
| LCAF250-78F-X | | | 7/8 | 1.28 | 1.65 | .17 | 2.97 | White | P66 | 1 3/4 | 10 |
| LCAF300-38F-6 | 300 kcmil | 313.1 kcmil | 3/8 | 1.39 | 1.65 | .18 | 2.44 | Red | P71 | 1 3/4 | 6 |
| LCAF300-12F-6 | | | 1/2 | 1.39 | 1.65 | .18 | 2.44 | Red | P71 | 1 3/4 | 6 |
| LCAF300-58F-6 | | | 5/8 | 1.39 | 1.65 | .18 | 2.65 | Red | P71 | 1 3/4 | 6 |
| LCAF300-78F-6 | | | 7/8 | 1.39 | 1.65 | .18 | 3.04 | Red | P71 | 1 3/4 | 6 |
| LCAF350-38F-6 | 350 kcmil | 373.7 kcmil | 3/8 | 1.54 | 1.85 | .22 | 2.40 | Blue | P76 | 1 15/16 | 6 |
| LCAF350-12F-6 | | | 1/2 | 1.54 | 1.85 | .22 | 2.40 | Blue | P76 | 1 15/16 | 6 |
| LCAF350-58F-6 | | | 5/8 | 1.54 | 1.85 | .22 | 2.77 | Blue | P76 | 1 15/16 | 6 |
| LCAF350-34F-6 | | | 3/4 | 1.54 | 1.85 | .22 | 2.91 | Blue | P76 | 1 15/16 | 6 |
| LCAF350-78F-6 | | | 7/8 | 1.54 | 1.85 | .22 | 3.16 | Blue | P76 | 1 15/16 | 6 |
| LCAF350-1F-6 | | | 1 | 1.54 | 1.85 | .22 | 3.28 | Blue | P76 | 1 15/16 | 6 |
| LCAF400-12F-6 | 400 kcmil | 444.4 kcmil | 1/2 | 1.70 | 2.20 | .26 | 3.28 | Brown | P87 | 2 1/4 | 6 |
| LCAF400-58F-6 | | | 5/8 | 1.70 | 2.20 | .26 | 3.28 | Brown | P87 | 2 1/4 | 6 |
| LCAF400-78F-6 | | | 7/8 | 1.70 | 2.20 | .26 | 3.28 | Brown | P87 | 2 1/4 | 6 |

‡See pages D3.70, D3.71 for tool and die information.

**Consult cable manufacturer for voltage stress relief instructions with applications greater than 2000 V.

A.
System
Overview

B1.
Cable
Ties

B2.
Cable
Accessories

B3.
Stainless
Steel
Ties

C1.
Wiring
Duct

C2.
Surface
Raceway

C3.
Abrasion
Protection

C4.
Cable
Management

D1.
Terminals

D2.
Power
Connectors

D3.
Grounding
Connectors

E1.
Labeling
Systems

E2.
Labels

E3.
Pre-Printed
& Write-On
Markers

E4.
Permanent
Identification

E5.
Lockout/
Tagout/
& Safety
Solutions

F.
Index

A. System Overview



Flex Conductor, One-Hole, Long Barrel with Window Lug

For Use with Flexible, Extra-Flexible, and Code Stranded Copper Conductors

B1. Cable Ties

Type LCBX

- Can be used with code conductor and flex conductor class: G, H, I, K, M and Diesel Locomotive
- Long barrel maximizes number of crimps and provides premium wire pull-out strength and electrical performance
- Generously beveled wire entry prevents bent back strands when inserting conductor into barrel
- Color-coded barrels marked with *PANDUIT* and specified competitor die index numbers for proper crimp die selection
- Inspection window to visually assure full conductor insertion
- Tin-plated to inhibit corrosion
- UL Listed and CSA Certified to 35 KV** and temperature rated to 90°C when crimped with *PANDUIT* and specified competitor crimping tools and dies
- Meets J-STD-607-A and TIA-942 requirements for network systems grounding applications

B2. Cable Accessories

B3. Stainless Steel Ties

C1. Wiring Duct

C2. Surface Raceway

C3. Abrasion Protection

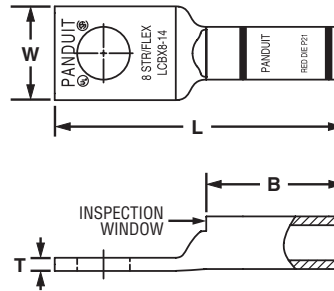

C4. Cable Management

| Part Number | Flex Conductor Size | | Code Conductor Size | Stud Hole Size (In.) | Figure Dimensions (In.) | | | | PANDUIT Color Code | PANDUIT Die Index No.‡ | Burndy Die Index No.‡ | T&B Die Index No.‡ | Wire Strip Length (In.) | Std. Pkg. Qty. |
|--------------|---------------------|-------------------|---------------------|----------------------|-------------------------|------|-----|------|--------------------|------------------------|-----------------------|--------------------|-------------------------|----------------|
| | Class G, H, I, K, M | Diesel Locomotive | | | W | B | T | L | | | | | | |
| LCBX8-10-L | | | | #10 | .41 | .70 | .08 | 1.39 | Red | P21 | 49 | 21 | 3/4 | 50 |
| LCBX8-14-L | #8 AWG | #8 AWG | #8 AWG | 1/4 | .48 | .70 | .07 | 1.48 | Red | P21 | 49 | 21 | 3/4 | 50 |
| LCBX8-38-L | | | | 3/8 | .60 | .70 | .05 | 1.70 | Red | P21 | 49 | 21 | 3/4 | 50 |
| LCBX6-14-L | #6 AWG | #6 AWG | #6 AWG | 1/4 | .48 | 1.07 | .08 | 1.86 | Blue | P24 | 7 | 24 | 1 1/8 | 50 |
| LCBX6-38-L | | | | 3/8 | .62 | 1.07 | .06 | 2.08 | Blue | P24 | 7 | 24 | 1 1/8 | 50 |
| LCBX4-14-L | #4 AWG | #5, #4, #3 AWG | #4 AWG | 1/4 | .55 | 1.05 | .09 | 1.87 | Gray | P29 | 8 | 29 | 1 1/8 | 50 |
| LCBX4-38-L | | | | 3/8 | .62 | 1.05 | .07 | 2.09 | Gray | P29 | 8 | 29 | 1 1/8 | 50 |
| LCBX2-14-E* | | | | 1/4 | .70 | 1.36 | .11 | 2.26 | Brown | P33 | 10 | 33 | 1 7/16 | 20 |
| LCBX2-38-E* | #2 AWG | #2 AWG | #2 AWG | 3/8 | .70 | 1.36 | .11 | 2.46 | Brown | P33 | 10 | 33 | 1 7/16 | 20 |
| LCBX2-12-E* | | | | 1/2 | .75 | 1.36 | .09 | 2.70 | Brown | P33 | 10 | 33 | 1 7/16 | 20 |
| LCBX1-14-X | | | | 1/4 | .76 | 1.44 | .12 | 2.44 | Green | P37 | 11 | 37 | 1 1/2 | 10 |
| LCBX1-56-X | #1 AWG | #1 AWG | #1 AWG | 5/16 | .76 | 1.44 | .12 | 2.50 | Green | P37 | 11 | 37 | 1 1/2 | 10 |
| LCBX1-38-X | | | | 3/8 | .76 | 1.44 | .12 | 2.57 | Green | P37 | 11 | 37 | 1 1/2 | 10 |
| LCBX1/0-14-X | | | | 1/4 | .85 | 1.50 | .13 | 2.61 | Pink | P42 | 12 | 42 | 1 9/16 | 10 |
| LCBX1/0-38-X | 1/0 AWG | 1/0 AWG | 1/0 AWG | 3/8 | .85 | 1.50 | .13 | 2.67 | Pink | P42 | 12 | 42 | 1 9/16 | 10 |
| LCBX1/0-12-X | | | | 1/2 | .85 | 1.50 | .13 | 2.92 | Pink | P42 | 12 | 42 | 1 9/16 | 10 |
| LCBX2/0-14-X | | | | 1/4 | .96 | 1.50 | .13 | 2.64 | Black | P45 | 13 | 45 | 1 9/16 | 10 |
| LCBX2/0-38-X | 2/0 AWG | 2/0 AWG | 2/0 AWG | 3/8 | .96 | 1.50 | .13 | 2.70 | Black | P45 | 13 | 45 | 1 9/16 | 10 |
| LCBX2/0-12-X | | | | 1/2 | .96 | 1.50 | .13 | 2.96 | Black | P45 | 13 | 45 | 1 9/16 | 10 |
| LCBX3/0-38-X | 3/0 AWG | 3/0 AWG | 3/0 AWG | 3/8 | 1.06 | 1.56 | .14 | 2.81 | Orange | P50 | 14 | 50 | 1 5/8 | 10 |
| LCBX4/0-38-X | | | | 3/8 | 1.19 | 2.24 | .16 | 3.74 | Purple | P54 | 15 | 54 | 2 5/16 | 10 |
| LCBX4/0-12-X | 4/0 AWG | 4/0 AWG | 4/0 AWG | 1/2 | 1.19 | 2.24 | .16 | 3.85 | Purple | P54 | 15 | 54 | 2 5/16 | 10 |
| LCBX250-38-X | 250 kcmil | 262.6 kcmil | — | 3/8 | 1.28 | 2.24 | .17 | 3.78 | Yellow | P62 | 16 | 62 | 2 5/16 | 10 |
| LCBX300-38-6 | 300 kcmil | 313.1 kcmil | — | 3/8 | 1.39 | 2.30 | .18 | 4.02 | Red | P71 | 18 | 71H | 2 3/8 | 6 |
| LCBX350-38-6 | | | | 3/8 | 1.54 | 2.50 | .22 | 4.14 | Blue | P76 | 19 | 76H | 2 9/16 | 6 |
| LCBX350-12-6 | 350 kcmil | 373.7 kcmil | — | 1/2 | 1.54 | 2.50 | .22 | 4.30 | Blue | P76 | 19 | 76H | 2 9/16 | 6 |
| LCBX450-38-6 | 450 kcmil | 444.4 kcmil | — | 3/8 | 1.70 | 2.69 | .26 | 5.14 | Brown | P87 | 20 | 87H | 2 3/4 | 6 |
| LCBX500-38-6 | | | | 3/8 | 1.89 | 2.88 | .26 | 4.84 | Pink | P99 | L99 | 99H | 2 15/16 | 6 |
| LCBX500-12-6 | 500 kcmil | 535.3 kcmil | — | 1/2 | 1.89 | 2.88 | .26 | 5.03 | Pink | P99 | L99 | 99H | 2 15/16 | 6 |

‡See pages D3.66 – D3.69 for tool and die information.

*Not UL Listed or CSA Certified with Class K flex conductor when crimped with Burndy tools.

**Consult cable manufacturer for voltage stress relief instructions with applications greater than 2000 V.



Flex Conductor, One-Hole, Long Barrel with Window Lug, 45° Angle

For Use with Flexible, Extra-Flexible, and Code Stranded Copper Conductors

Type LCBX-H

- Can be used with code conductor and flex conductor class: G, H, I, K, M and Diesel Locomotive
- Long barrel maximizes number of crimps and provides premium wire pull-out strength and electrical performance
- Generously beveled wire entry prevents bent back strands when inserting conductor into barrel
- Color-coded barrels marked with *PANDUIT* and specified competitor die index numbers for proper crimp die selection
- Inspection window to visually assure full conductor insertion
- Tin-plated to inhibit corrosion
- UL Listed and CSA Certified to 35 KV** and temperature rated to 90°C when crimped with *PANDUIT* and specified competitor crimping tools and dies
- Meets J-STD-607-A and TIA-942 requirements for network systems grounding applications

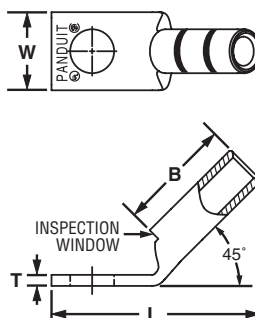

| Part Number | Flex Conductor Size | | Code Conductor Size | Stud Hole Size (In.) | Figure Dimensions (In.) | | | | PANDUIT Color Code | PANDUIT Die Index No.‡ | Burndy Die Index No.‡ | T&B Die Index No.‡ | Wire Strip Length (In.) | Std. Pkg. Qty. |
|---------------|---------------------|-------------------|---------------------|----------------------|-------------------------|------|-----|------|--------------------|------------------------|-----------------------|--------------------|-------------------------|----------------|
| | Class G, H, I, K, M | Diesel Locomotive | | | W | B | T | L | | | | | | |
| LCBX8-10H-L | | | | #10 | .41 | .70 | .08 | 1.20 | Red | P21 | 49 | 21 | 3/4 | 50 |
| LCBX8-14H-L | #8 AWG | #8 AWG | #8 AWG | 1/4 | .48 | .70 | .07 | 1.28 | Red | P21 | 49 | 21 | 3/4 | 50 |
| LCBX8-38H-L | | | | 3/8 | .60 | .70 | .05 | 1.49 | Red | P21 | 49 | 21 | 3/4 | 50 |
| LCBX6-14H-L | #6 AWG | #6 AWG | #6 AWG | 1/4 | .48 | 1.07 | .08 | 1.56 | Blue | P24 | 7 | 24 | 1 1/8 | 50 |
| LCBX6-38H-L | | | | 3/8 | .62 | 1.07 | .06 | 1.77 | Blue | P24 | 7 | 24 | 1 1/8 | 50 |
| LCBX4-14H-L | #4 AWG | #5, #4, #3 AWG | #4 AWG | 1/4 | .55 | 1.05 | .09 | 1.57 | Gray | P29 | 8 | 29 | 1 1/8 | 50 |
| LCBX4-38H-L | | | | 3/8 | .62 | 1.05 | .07 | 1.78 | Gray | P29 | 8 | 29 | 1 1/8 | 50 |
| LCBX2-14H-E* | | | | 1/4 | .70 | 1.36 | .11 | 1.83 | Brown | P33 | 10 | 33 | 1 7/16 | 20 |
| LCBX2-38H-E* | #2 AWG | #2 AWG | #2 AWG | 3/8 | .70 | 1.36 | .11 | 2.03 | Brown | P33 | 10 | 33 | 1 7/16 | 20 |
| LCBX2-12H-E* | | | | 1/2 | .75 | 1.36 | .09 | 2.26 | Brown | P33 | 10 | 33 | 1 7/16 | 20 |
| LCBX1-14H-X | #1 AWG | #1 AWG | #1 AWG | 1/4 | .76 | 1.44 | .12 | 1.98 | Green | P37 | 11 | 37 | 1 1/2 | 10 |
| LCBX1-56H-X | | | | 5/16 | .76 | 1.44 | .12 | 2.04 | Green | P37 | 11 | 37 | 1 1/2 | 10 |
| LCBX1-38H-X | | | | 3/8 | .76 | 1.44 | .12 | 2.11 | Green | P37 | 11 | 37 | 1 1/2 | 10 |
| LCBX1/0-14H-X | 1/0 AWG | 1/0 AWG | 1/0 AWG | 1/4 | .85 | 1.50 | .13 | 2.13 | Pink | P42 | 12 | 42 | 1 9/16 | 10 |
| LCBX1/0-38H-X | | | | 3/8 | .85 | 1.50 | .13 | 2.20 | Pink | P42 | 12 | 42 | 1 9/16 | 10 |
| LCBX1/0-12H-X | | | | 1/2 | .85 | 1.50 | .13 | 2.45 | Pink | P42 | 12 | 42 | 1 9/16 | 10 |
| LCBX2/0-14H-X | 2/0 AWG | 2/0 AWG | 2/0 AWG | 1/4 | .96 | 1.50 | .13 | 2.16 | Black | P45 | 13 | 45 | 1 9/16 | 10 |
| LCBX2/0-38H-X | | | | 3/8 | .96 | 1.50 | .13 | 2.22 | Black | P45 | 13 | 45 | 1 9/16 | 10 |
| LCBX2/0-12H-X | | | | 1/2 | .96 | 1.50 | .13 | 2.47 | Black | P45 | 13 | 45 | 1 9/16 | 10 |
| LCBX3/0-38H-X | 3/0 AWG | 3/0 AWG | 3/0 AWG | 3/8 | 1.06 | 1.56 | .14 | 2.31 | Orange | P50 | 14 | 50 | 1 5/8 | 10 |
| LCBX4/0-38H-X | 4/0 AWG | 4/0 AWG | 4/0 AWG | 3/8 | 1.19 | 2.24 | .16 | 3.12 | Purple | P54 | 15 | 54 | 2 5/16 | 10 |
| LCBX4/0-12H-X | | | | 1/2 | 1.19 | 2.24 | .16 | 3.23 | Purple | P54 | 15 | 54 | 2 5/16 | 10 |
| LCBX250-38H-X | 250 kcmil | 262.6 kcmil | — | 3/8 | 1.28 | 2.24 | .17 | 3.15 | Yellow | P62 | 16 | 62 | 2 5/16 | 10 |
| LCBX300-38H-6 | 300 kcmil | 313.1 kcmil | — | 3/8 | 1.39 | 2.30 | .18 | 3.42 | Red | P71 | 18 | 71H | 2 3/8 | 6 |
| LCBX300-12H-6 | | | | 1/2 | 1.39 | 2.30 | .18 | 3.69 | Red | P71 | 18 | 71H | 2 3/8 | 6 |
| LCBX350-38H-6 | 350 kcmil | 373.7 kcmil | — | 3/8 | 1.54 | 2.50 | .22 | 3.48 | Blue | P76 | 19 | 76H | 2 9/16 | 6 |
| LCBX350-12H-6 | | | | 1/2 | 1.54 | 2.50 | .22 | 3.64 | Blue | P76 | 19 | 76H | 2 9/16 | 6 |
| LCBX450-38H-6 | 450 kcmil | 444.4 kcmil | — | 3/8 | 1.70 | 2.69 | .26 | 4.42 | Brown | P87 | 20 | 87H | 2 3/4 | 6 |
| LCBX500-38H-6 | 500 kcmil | 535.3 kcmil | — | 3/8 | 1.89 | 2.88 | .26 | 4.08 | Pink | P99 | L99 | 99H | 2 15/16 | 6 |
| LCBX500-12H-6 | | | | 1/2 | 1.89 | 2.88 | .26 | 4.27 | Pink | P99 | L99 | 99H | 2 15/16 | 6 |

‡See pages D3.66 – D3.69 for tool and die information.

*Not UL Listed or CSA Certified with Class K flex conductor when crimped with Burndy tools.

**Consult cable manufacturer for voltage stress relief instructions with applications greater than 2000 V.

A. System Overview

B1. Cable Ties

B2. Cable Accessories

B3. Stainless Steel Ties

C1. Wiring Duct

C2. Surface Raceway

C3. Abrasion Protection

C4. Cable Management

D1. Terminals

D2. Power Connectors

D3. Grounding Connectors

E1. Labeling Systems

E2. Labels

E3. Pre-Printed & Write-On Markers

E4. Permanent Identification

E5. Lockout/Tagout & Safety Solutions

F. Index

A. System Overview

B1. Cable Ties



Flex Conductor, One-Hole, Long Barrel with Window Lug, 90° Angle

For Use with Flexible, Extra-Flexible, and Code Stranded Copper Conductors

Type LCBX-F

- Can be used with code conductor and flex conductor class: G, H, I, K, M and Diesel Locomotive
- Long barrel maximizes number of crimps and provides premium wire pull-out strength and electrical performance
- Generously beveled wire entry prevents bent back strands when inserting conductor into barrel
- Color-coded barrels marked with *PANDUIT* and specified competitor die index numbers for proper crimp die selection
- Inspection window to visually assure full conductor insertion
- Tin-plated to inhibit corrosion
- UL Listed and CSA Certified to 35 KV** and temperature rated to 90°C when crimped with *PANDUIT* and specified competitor crimping tools and dies
- Meets J-STD-607-A and TIA-942 requirements for network systems grounding applications

C1. Wiring Duct



C2. Surface Raceway

C3. Abrasion Protection

C4. Cable Management

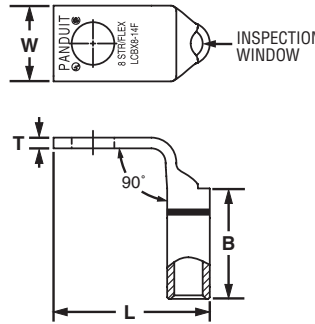

D1. Terminals

D2. Power Connectors

D3. Grounding Connectors

E1. Labeling Systems

E2. Labels

E3. Pre-Printed & Write-On Markers

E4. Permanent Identification

E5. Lockout/Tagout & Safety Solutions

F. Index

| Part Number | Flex Conductor Size | | Code Conductor Size | Stud Hole Size (In.) | Figure Dimensions (In.) | | | | PANDUIT Color Code | PANDUIT Die Index No.‡ | Burndy Die Index No.‡ | T&B Die Index No.‡ | Wire Strip Length (In.) | Std. Pkg. Qty. |
|---------------|---------------------|-------------------|---------------------|----------------------|-------------------------|------|-----|------|--------------------|------------------------|-----------------------|--------------------|-------------------------|----------------|
| | Class G, H, I, K, M | Diesel Locomotive | | | W | B | T | L | | | | | | |
| LCBX8-10F-L | | | | #10 | .41 | .70 | .08 | .90 | Red | P21 | 49 | 21 | 3/4 | 50 |
| LCBX8-14F-L | #8 AWG | #8 AWG | #8 AWG | 1/4 | .48 | .70 | .07 | .99 | Red | P21 | 49 | 21 | 3/4 | 50 |
| LCBX8-38F-L | | | | 3/8 | .60 | .70 | .05 | 1.21 | Red | P21 | 49 | 21 | 3/4 | 50 |
| LCBX6-14F-L | #6 AWG | #6 AWG | #6 AWG | 1/4 | .48 | 1.07 | .08 | 1.03 | Blue | P24 | 7 | 24 | 1 1/8 | 50 |
| LCBX6-38F-L | | | | 3/8 | .62 | 1.07 | .06 | 1.25 | Blue | P24 | 7 | 24 | 1 1/8 | 50 |
| LCBX4-14F-L | #4 AWG | #5, #4, #3 AWG | #4 AWG | 1/4 | .55 | 1.05 | .09 | 1.12 | Gray | P29 | 8 | 29 | 1 1/8 | 50 |
| LCBX4-38F-L | | | | 3/8 | .62 | 1.05 | .07 | 1.34 | Gray | P29 | 8 | 29 | 1 1/8 | 50 |
| LCBX2-14F-E* | | | | 1/4 | .70 | 1.36 | .11 | 1.31 | Brown | P33 | 10 | 33 | 1 7/16 | 20 |
| LCBX2-38F-E* | #2 AWG | #2 AWG | #2 AWG | 3/8 | .70 | 1.36 | .11 | 1.51 | Brown | P33 | 10 | 33 | 1 7/16 | 20 |
| LCBX2-12F-E* | | | | 1/2 | .75 | 1.36 | .09 | 1.75 | Brown | P33 | 10 | 33 | 1 7/16 | 20 |
| LCBX1-14F-X | | | | 1/4 | .76 | 1.44 | .12 | 1.45 | Green | P37 | 11 | 37 | 1 1/2 | 10 |
| LCBX1-56F-X | #1 AWG | #1 AWG | #1 AWG | 5/16 | .76 | 1.44 | .12 | 1.51 | Green | P37 | 11 | 37 | 1 1/2 | 10 |
| LCBX1-38F-X | | | | 3/8 | .76 | 1.44 | .12 | 1.58 | Green | P37 | 11 | 37 | 1 1/2 | 10 |
| LCBX1/0-14F-X | | | | 1/4 | .85 | 1.50 | .13 | 1.61 | Pink | P42 | 12 | 42 | 1 9/16 | 10 |
| LCBX1/0-38F-X | 1/0 AWG | 1/0 AWG | 1/0 AWG | 3/8 | .85 | 1.50 | .13 | 1.66 | Pink | P42 | 12 | 42 | 1 9/16 | 10 |
| LCBX1/0-12F-X | | | | 1/2 | .85 | 1.50 | .13 | 1.91 | Pink | P42 | 12 | 42 | 1 9/16 | 10 |
| LCBX2/0-14F-X | | | | 1/4 | .96 | 1.50 | .13 | 1.67 | Black | P45 | 13 | 45 | 1 9/16 | 10 |
| LCBX2/0-38F-X | 2/0 AWG | 2/0 AWG | 2/0 AWG | 3/8 | .96 | 1.50 | .13 | 1.73 | Black | P45 | 13 | 45 | 1 9/16 | 10 |
| LCBX2/0-12F-X | | | | 1/2 | .96 | 1.50 | .13 | 1.98 | Black | P45 | 13 | 45 | 1 9/16 | 10 |
| LCBX3/0-38F-X | 3/0 AWG | 3/0 AWG | 3/0 AWG | 3/8 | 1.06 | 1.56 | .14 | 1.84 | Orange | P50 | 14 | 50 | 1 5/8 | 10 |
| LCBX4/0-38F-X | | | | 3/8 | 1.19 | 2.24 | .16 | 2.07 | Purple | P54 | 15 | 54 | 2 5/16 | 10 |
| LCBX4/0-12F-X | 4/0 AWG | 4/0 AWG | 4/0 AWG | 1/2 | 1.19 | 2.24 | .16 | 2.18 | Purple | P54 | 15 | 54 | 2 5/16 | 10 |
| LCBX250-38F-X | 250 kcmil | 262.6 kcmil | — | 3/8 | 1.28 | 2.24 | .17 | 2.13 | Yellow | P62 | 16 | 62 | 2 5/16 | 10 |
| LCBX300-38F-6 | 300 kcmil | 313.1 kcmil | — | 3/8 | 1.39 | 2.30 | .18 | 2.37 | Red | P71 | 18 | 71H | 2 3/8 | 6 |
| LCBX300-12F-6 | | | | 1/2 | 1.39 | 2.30 | .18 | 2.37 | Red | P71 | 18 | 71H | 2 3/8 | 6 |
| LCBX350-38F-6 | | | | 3/8 | 1.54 | 2.50 | .22 | 2.32 | Blue | P76 | 19 | 76H | 2 9/16 | 6 |
| LCBX350-12F-6 | 350 kcmil | 373.7 kcmil | — | 1/2 | 1.54 | 2.50 | .22 | 2.48 | Blue | P76 | 19 | 76H | 2 9/16 | 6 |
| LCBX450-38F-6 | 450 kcmil | 444.4 kcmil | — | 3/8 | 1.70 | 2.69 | .26 | 3.14 | Brown | P87 | 20 | 87H | 2 3/4 | 6 |
| LCBX500-38F-6 | | | | 3/8 | 1.89 | 2.88 | .26 | 2.62 | Pink | P99 | L99 | 99H | 2 15/16 | 6 |
| LCBX500-12F-6 | 500 kcmil | 535.3 kcmil | — | 1/2 | 1.89 | 2.88 | .26 | 2.81 | Pink | P99 | L99 | 99H | 2 15/16 | 6 |

‡See pages D3.66 – D3.69 for tool and die information.
 *Not UL Listed or CSA Certified with Class K flex conductor when crimped with Burndy tools.
 **Consult cable manufacturer for voltage stress relief instructions with applications greater than 2000 V.



Flex Conductor, Two-Hole, Standard Barrel with Window Lug

For Use with Flexible, Extra-Flexible, and Code Stranded Copper Conductors

Type LCDX

- Can be used with code conductor and flex conductor class: G, H, I, K, M and Diesel Locomotive
- Generously beveled wire entry prevents bent back strands when inserting conductor into barrel
- Color-coded barrels marked with *PANDUIT* and specified competitor die index numbers for proper crimp die selection
- Inspection window to visually assure full conductor insertion
- Tin-plated to inhibit corrosion
- UL Listed and CSA Certified to 35 KV** and temperature rated to 90°C when crimped with *PANDUIT* and specified competitor crimping tools and dies
- American Bureau of Shipping approved
- Available with NEMA hole sizes and spacing.

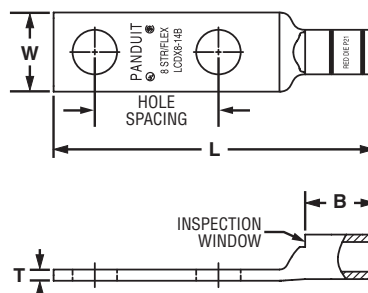

| Part Number | Flex Conductor Size | | Code Conductor Size | Stud Hole Size (In.) | Stud Hole Spacing (In.) | Figure Dimensions (In.) | | | | PANDUIT Color Code | PANDUIT Die Index No.‡ | Burndy Die Index No.‡ | T&B Die Index No.‡ | Wire Strip Length (In.) | Std. Pkg. Qty. |
|--------------|---------------------|-------------------|---------------------|----------------------|-------------------------|-------------------------|-----|-----|------|--------------------|------------------------|-----------------------|--------------------|-------------------------|----------------|
| | Class G, H, I, K, M | Diesel Locomotive | | | | W | B | T | L | | | | | | |
| LCDX8-10A-L | #8 AWG | #8 AWG | #8 AWG | #10 | .63 | .41 | .42 | .08 | 1.74 | Red | P21 | 49 | 21 | 1/2 | 50 |
| LCDX8-14A-L | | | | 1/4 | .63 | .48 | .42 | .07 | 1.83 | Red | P21 | 49 | 21 | 1/2 | 50 |
| LCDX8-14B-L | | | | 1/4 | .75 | .48 | .42 | .07 | 1.95 | Red | P21 | 49 | 21 | 1/2 | 50 |
| LCDX8-14D-L | | | | 1/4 | 1.00 | .48 | .42 | .07 | 2.20 | Red | P21 | 49 | 21 | 1/2 | 50 |
| LCDX8-38D-L | | | | 3/8 | 1.00 | .60 | .42 | .05 | 2.42 | Red | P21 | 49 | 21 | 1/2 | 50 |
| LCDX6-10A-L | #6 AWG | #6 AWG | #6 AWG | #10 | .63 | .46 | .48 | .08 | 1.82 | Blue | P24 | 7 | 24 | 9/16 | 50 |
| LCDX6-10B-L | | | | #10 | .75 | .46 | .48 | .08 | 1.94 | Blue | P24 | 7 | 24 | 9/16 | 50 |
| LCDX6-10G-L | | | | #10 | 1.50 | .46 | .48 | .08 | 2.69 | Blue | P24 | 7 | 24 | 9/16 | 50 |
| LCDX6-10P-L | | | | #10 | .69 | .46 | .48 | .08 | 1.88 | Blue | P24 | 7 | 24 | 9/16 | 50 |
| LCDX6-14A-L | | | | 1/4 | .63 | .48 | .48 | .08 | 1.91 | Blue | P24 | 7 | 24 | 9/16 | 50 |
| LCDX6-14B-L | | | | 1/4 | .75 | .48 | .48 | .08 | 2.03 | Blue | P24 | 7 | 24 | 9/16 | 50 |
| LCDX6-14D-L | | | | 1/4 | 1.00 | .48 | .48 | .08 | 2.28 | Blue | P24 | 7 | 24 | 9/16 | 50 |
| LCDX6-56D-L | | | | 5/16 | 1.00 | .56 | .48 | .07 | 2.40 | Blue | P24 | 7 | 24 | 9/16 | 50 |
| LCDX6-38D-L | | | | 3/8 | 1.00 | .62 | .48 | .06 | 2.50 | Blue | P24 | 7 | 24 | 9/16 | 50 |
| LCDX4-14A-L | | | | #4 AWG | #5, #4, #3 AWG | #4 AWG | 1/4 | .63 | .55 | .53 | .09 | 1.98 | Gray | P29 | 8 |
| LCDX4-14B-L | 1/4 | .75 | .55 | | | | .53 | .09 | 2.10 | Gray | P29 | 8 | 29 | 5/8 | 50 |
| LCDX4-14D-L | 1/4 | 1.00 | .55 | | | | .53 | .09 | 2.35 | Gray | P29 | 8 | 29 | 5/8 | 50 |
| LCDX4-56D-L | 5/16 | 1.00 | .55 | | | | .53 | .09 | 2.47 | Gray | P29 | 8 | 29 | 5/8 | 50 |
| LCDX4-38D-L | 3/8 | 1.00 | .62 | | | | .53 | .08 | 2.57 | Gray | P29 | 8 | 29 | 5/8 | 50 |
| LCDX2-14A-E* | #2 AWG | #2 AWG | #2 AWG | 1/4 | .63 | .70 | .59 | .11 | 2.13 | Brown | P33 | 10 | 33 | 11/16 | 20 |
| LCDX2-14B-E* | | | | 1/4 | .75 | .70 | .59 | .11 | 2.25 | Brown | P33 | 10 | 33 | 11/16 | 20 |
| LCDX2-14D-E* | | | | 1/4 | 1.00 | .70 | .59 | .11 | 2.50 | Brown | P33 | 10 | 33 | 11/16 | 20 |
| LCDX2-56D-E* | | | | 5/16 | 1.00 | .70 | .59 | .11 | 2.63 | Brown | P33 | 10 | 33 | 11/16 | 20 |
| LCDX2-38D-E* | | | | 3/8 | 1.00 | .70 | .59 | .11 | 2.70 | Brown | P33 | 10 | 33 | 11/16 | 20 |
| LCDX2-12-E* | | | | 1/2 | 1.75 | .75 | .59 | .09 | 3.87 | Brown | P33 | 10 | 33 | 11/16 | 20 |
| LCDX1-14A-X | #1 AWG | #1 AWG | #1 AWG | 1/4 | .63 | .76 | .66 | .12 | 2.29 | Green | P37 | 11 | 37 | 3/4 | 10 |
| LCDX1-14B-X | | | | 1/4 | .75 | .76 | .66 | .12 | 2.42 | Green | P37 | 11 | 37 | 3/4 | 10 |
| LCDX1-14D-X | | | | 1/4 | 1.00 | .76 | .66 | .12 | 2.67 | Green | P37 | 11 | 37 | 3/4 | 10 |
| LCDX1-56D-X | | | | 5/16 | 1.00 | .76 | .66 | .12 | 2.72 | Green | P37 | 11 | 37 | 3/4 | 10 |
| LCDX1-38D-X | | | | 3/8 | 1.00 | .76 | .66 | .12 | 2.80 | Green | P37 | 11 | 37 | 3/4 | 10 |
| LCDX1-12-X | | | | 1/2 | 1.75 | .80 | .66 | .12 | 3.97 | Green | P37 | 11 | 37 | 3/4 | 10 |

‡See pages D3.66 – D3.69 for tool and die information.

*Not UL Listed or CSA Certified with Class K flex conductor when crimped with Burndy tools.

**Consult cable manufacturer for voltage stress relief instructions with applications greater than 2000 V.

◆NEMA hole sizes and spacing.

Table continues on page D2.84

A. System Overview

B1. Cable Ties

B2. Cable Accessories

B3. Stainless Steel Ties

C1. Wiring Duct

C2. Surface Raceway

C3. Abrasion Protection

C4. Cable Management

D1. Terminals

D2. Power Connectors

D3. Grounding Connectors

E1. Labeling Systems

E2. Labels

E3. Pre-Printed & Write-On Markers

E4. Permanent Identification

E5. Lockout/Tagout & Safety Solutions

F. Index

A. System Overview

B1. Cable Ties

B2. Cable Accessories

B3. Stainless Steel Ties

C1. Wiring Duct

C2. Surface Raceway

C3. Abrasion Protection

C4. Cable Management

D1. Terminals

D2. Power Connectors

D3. Grounding Connectors

E1. Labeling Systems

E2. Labels

E3. Pre-Printed & Write-On Markers

E4. Permanent Identification

E5. Lockout/Tagout & Safety Solutions

F. Index



Flex Conductor, Two-Hole, Standard Barrel with Window Lug (continued)

| Part Number | Flex Conductor Size | | Code Conductor Size | Stud Hole Size (In.) | Stud Hole Spacing (In.) | Figure Dimensions (In.) | | | | PANDUIT Color Code | PANDUIT Die Index No.‡ | Burndy Die Index No.‡ | T&B Die Index No.‡ | Wire Strip Length (In.) | Std. Pkg. Qty. | | | |
|---------------|---------------------|-------------------|---------------------|----------------------|-------------------------|-------------------------|------|------|------|--------------------|------------------------|-----------------------|--------------------|-------------------------|----------------|------|--------|----|
| | Class G, H, I, K, M | Diesel Locomotive | | | | W | B | T | L | | | | | | | | | |
| LCDX1/0-14A-X | 1/0 AWG | 1/0 AWG | 1/0 AWG | 1/4 | .63 | .85 | .72 | .13 | 2.45 | Pink | P42 | 12 | 42 | 3/4 | 10 | | | |
| LCDX1/0-14B-X | | | | 1/4 | .75 | .85 | .72 | .13 | 2.57 | Pink | P42 | 12 | 42 | 3/4 | 10 | | | |
| LCDX1/0-56B-X | | | | 5/16 | .75 | .85 | .72 | .13 | 2.57 | Pink | P42 | 12 | 42 | 3/4 | 10 | | | |
| LCDX1/0-56D-X | | | | 5/16 | 1.00 | .85 | .72 | .13 | 2.82 | Pink | P42 | 12 | 42 | 3/4 | 10 | | | |
| LCDX1/0-38D-X | | | | 3/8 | 1.00 | .85 | .72 | .13 | 2.89 | Pink | P42 | 12 | 42 | 3/4 | 10 | | | |
| LCDX1/0-12D-X | | | | 1/2 | 1.00 | .85 | .72 | .13 | 3.14 | Pink | P42 | 12 | 42 | 3/4 | 10 | | | |
| LCDX1/0-12-X | 2/0 AWG | 2/0 AWG | 2/0 AWG | 1/2 | 1.75 | .85 | .72 | .13 | 4.05 | Pink | P42 | 12 | 42 | 3/4 | 10 | | | |
| LCDX2/0-14A-X | | | | 1/4 | .63 | .96 | .83 | .13 | 2.59 | Black | P45 | 13 | 45 | 7/8 | 10 | | | |
| LCDX2/0-14B-X | | | | 1/4 | .75 | .96 | .83 | .13 | 2.72 | Black | P45 | 13 | 45 | 7/8 | 10 | | | |
| LCDX2/0-56D-X | | | | 5/16 | 1.00 | .96 | .83 | .13 | 2.97 | Black | P45 | 13 | 45 | 7/8 | 10 | | | |
| LCDX2/0-38D-X | | | | 3/8 | 1.00 | .96 | .83 | .13 | 3.03 | Black | P45 | 13 | 45 | 7/8 | 10 | | | |
| LCDX2/0-12D-X | | | | 1/2 | 1.00 | .96 | .83 | .13 | 3.28 | Black | P45 | 13 | 45 | 7/8 | 10 | | | |
| LCDX2/0-12-X | 3/0 AWG | 3/0 AWG | 3/0 AWG | 1/2 | 1.75 | .96 | .83 | .13 | 4.19 | Black | P45 | 13 | 45 | 7/8 | 10 | | | |
| LCDX3/0-14A-X | | | | 1/4 | .63 | 1.06 | .91 | .14 | 2.71 | Orange | P50 | 14 | 50 | 1 | 10 | | | |
| LCDX3/0-56D-X | | | | 5/16 | 1.00 | 1.06 | .91 | .14 | 3.10 | Orange | P50 | 14 | 50 | 1 | 10 | | | |
| LCDX3/0-38D-X | | | | 3/8 | 1.00 | 1.06 | .91 | .14 | 3.17 | Orange | P50 | 14 | 50 | 1 | 10 | | | |
| LCDX3/0-12-X | | | | 1/2 | 1.75 | 1.06 | .91 | .14 | 4.31 | Orange | P50 | 14 | 50 | 1 | 10 | | | |
| LCDX4/0-14A-X | | | | 4/0 AWG | 4/0 AWG | 4/0 AWG | 1/4 | .63 | 1.19 | 1.03 | .16 | 2.74 | Purple | P54 | 15 | 54 | 1 1/16 | 10 |
| LCDX4/0-14B-X | 1/4 | .75 | 1.19 | | | | 1.03 | .16 | 2.96 | Purple | P54 | 15 | 54 | 1 1/16 | 10 | | | |
| LCDX4/0-56D-X | 5/16 | 1.00 | 1.19 | | | | 1.03 | .16 | 3.31 | Purple | P54 | 15 | 54 | 1 1/16 | 10 | | | |
| LCDX4/0-38D-X | 3/8 | 1.00 | 1.19 | | | | 1.03 | .16 | 3.34 | Purple | P54 | 15 | 54 | 1 1/16 | 10 | | | |
| LCDX4/0-12D-X | 1/2 | 1.00 | 1.19 | | | | 1.03 | .16 | 3.61 | Purple | P54 | 15 | 54 | 1 1/16 | 10 | | | |
| LCDX4/0-12E-X | 1/2 | 1.25 | 1.19 | | | | 1.03 | .16 | 3.89 | Purple | P54 | 15 | 54 | 1 1/16 | 10 | | | |
| LCDX4/0-12-X | 250 kcmil | 262.6 kcmil | — | 1/2 | 1.75 | 1.19 | 1.03 | .16 | 4.52 | Purple | P54 | 15 | 54 | 1 1/16 | 10 | | | |
| LCDX250-38D-X | | | | 3/8 | 1.00 | 1.28 | 1.03 | .17 | 3.38 | Yellow | P62 | 16 | 62 | 1 1/16 | 10 | | | |
| LCDX250-38-X | | | | 3/8 | 1.75 | 1.28 | 1.03 | .17 | 4.13 | Yellow | P62 | 16 | 62 | 1 1/16 | 10 | | | |
| LCDX250-12E-X | | | | 1/2 | 1.25 | 1.28 | 1.03 | .17 | 3.93 | Yellow | P62 | 16 | 62 | 1 1/16 | 10 | | | |
| LCDX250-12-X | | | | 1/2 | 1.75 | 1.28 | 1.03 | .17 | 4.56 | Yellow | P62 | 16 | 62 | 1 1/16 | 10 | | | |
| LCDX300-38D-6 | | | | 300 kcmil | 313.1 kcmil | — | 3/8 | 1.00 | 1.39 | 1.19 | .18 | 3.56 | Red | P71 | 18 | 71H | 1 1/4 | 6 |
| LCDX300-12-6 | 1/2 | 1.75 | 1.39 | | | | 1.19 | .18 | 4.74 | Red | P71 | 18 | 71H | 1 1/4 | 6 | | | |
| LCDX350-56D-6 | 5/16 | 1.00 | 1.54 | | | | 1.29 | .22 | 3.71 | Blue | P76 | 19 | 76H | 1 3/8 | 6 | | | |
| LCDX350-38D-6 | 3/8 | 1.00 | 1.54 | | | | 1.29 | .22 | 3.74 | Blue | P76 | 19 | 76H | 1 3/8 | 6 | | | |
| LCDX350-38-6 | 350 kcmil | 373.7 kcmil | — | | | | 3/8 | 1.75 | 1.54 | 1.29 | .22 | 4.49 | Blue | P76 | 19 | 76H | 1 3/8 | 6 |
| LCDX350-12E-6 | | | | | | | 1/2 | 1.25 | 1.54 | 1.29 | .22 | 4.29 | Blue | P76 | 19 | 76H | 1 3/8 | 6 |
| LCDX350-12-6 | 450 kcmil | 444.4 kcmil | — | 1/2 | 1.75 | 1.54 | 1.29 | .22 | 4.92 | Blue | P76 | 19 | 76H | 1 3/8 | 6 | | | |
| LCDX450-38D-6 | | | | 3/8 | 1.00 | 1.70 | 1.40 | .26 | 3.90 | Brown | P87 | 20 | 87H | 1 7/16 | 6 | | | |
| LCDX450-12-6 | | | | 1/2 | 1.75 | 1.70 | 1.40 | .26 | 5.08 | Brown | P87 | 20 | 87H | 1 7/16 | 6 | | | |
| LCDX500-56D-6 | | | | 500 kcmil | 535.3 kcmil | — | 5/16 | 1.00 | 1.89 | 1.48 | .26 | 4.05 | Pink | P99 | L99 | 99H | 1 9/16 | 6 |
| LCDX500-38D-6 | | | | | | | 3/8 | 1.00 | 1.89 | 1.48 | .26 | 4.08 | Pink | P99 | L99 | 99H | 1 9/16 | 6 |
| LCDX500-12E-6 | | | | | | | 1/2 | 1.25 | 1.89 | 1.48 | .26 | 4.76 | Pink | P99 | L99 | 99H | 1 9/16 | 6 |
| LCDX500-12-6 | 1/2 | 1.75 | 1.89 | | | | 1.48 | .26 | 5.26 | Pink | P99 | L99 | 99H | 1 9/16 | 6 | | | |
| LCDX600-12-6 | 600 kcmil | — | — | | | | 1/2 | 1.75 | 1.89 | 1.48 | .26 | 5.26 | Pink | P99 | 400 | 99H | 1 9/16 | 6 |
| LCDX650-38D-6 | | | | | | | 3/8 | 1.00 | 1.95 | 1.45 | .30 | 4.08 | Black | P106 | 24 | 106H | 1 1/2 | 6 |
| LCDX650-12-6 | — | 646.4 kcmil | — | 1/2 | 1.75 | 1.95 | 1.45 | .30 | 5.26 | Black | P106 | 24 | 106H | 1 1/2 | 6 | | | |
| LCDX750-38D-3 | — | 777.7 kcmil | — | 3/8 | 1.00 | 2.17 | 1.66 | .32 | 4.62 | Yellow | P115 | L115 | 115H | 1 3/4 | 3 | | | |
| LCDX750-12E-3 | | | | 1/2 | 1.25 | 2.17 | 1.66 | .32 | 5.06 | Yellow | P115 | L115 | 115H | 1 3/4 | 3 | | | |
| LCDX750-12G-3 | | | | 1/2 | 1.50 | 2.17 | 1.66 | .32 | 5.31 | Yellow | P115 | L115 | 115H | 1 3/4 | 3 | | | |
| LCDX750-12-3 | | | | — | — | — | 1/2 | 1.75 | 2.17 | 1.66 | .32 | 5.56 | Yellow | P115 | L115 | 115H | 1 3/4 | 3 |
| LCDX750-58G-3 | | | | | | | 5/8 | 1.50 | 2.17 | 1.66 | .32 | 5.37 | Yellow | P115 | L115 | 115H | 1 3/4 | 3 |

‡See pages D3.66 – D3.69 for tool and die information.

*Not UL Listed or CSA Certified with Class K flex conductor when crimped with Burndy tools.

**Consult cable manufacturer for voltage stress relief instructions with applications greater than 2000 V.

◆NEMA hole sizes and spacing.



Flex Conductor, Two-Hole, Standard Barrel with Window Lug, 45° Angle

For Use with Flexible, Extra-Flexible, and Code Stranded Copper Conductors

Type LCDX-H

- Can be used with code conductor and flex conductor class: G, H, I, K, M and Diesel Locomotive
- Generously beveled wire entry prevents bent back strands when inserting conductor into barrel
- Color-coded barrels marked with *PANDUIT* and specified competitor die index numbers for proper crimp die selection
- Inspection window to visually assure full conductor insertion
- Tin-plated to inhibit corrosion
- UL Listed and CSA Certified to 35 KV** and temperature rated to 90°C when crimped with *PANDUIT* and specified competitor crimping tools and dies
- American Bureau of Shipping approved
- Available with NEMA hole sizes and spacing

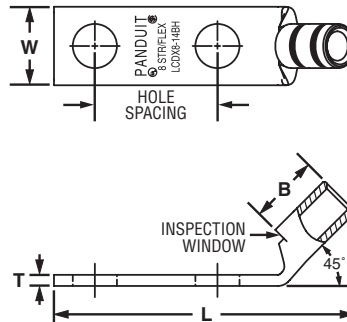

A. System Overview

B1. Cable Ties

B2. Cable Accessories

B3. Stainless Steel Ties

C1. Wiring Duct

C2. Surface Raceway

C3. Abrasion Protection

C4. Cable Management

D1. Terminals

D2. Power Connectors

D3. Grounding Connectors

E1. Labeling Systems

E2. Labels

E3. Pre-Printed & Write-On Markers

E4. Permanent Identification

E5. Lockout/Tagout & Safety Solutions

F. Index

| Part Number | Flex Conductor Size | | Code Conductor Size | Stud Hole Size (In.) | Stud Hole Spacing (In.) | Figure Dimensions (In.) | | | | PANDUIT Color Code | PANDUIT Die Index No.‡ | Burndy Die Index No.‡ | T&B Die Index No.‡ | Wire Strip Length (In.) | Std. Pkg. Qty. |
|---------------|---------------------|-------------------|---------------------|----------------------|-------------------------|-------------------------|-------|-----|------|--------------------|------------------------|-----------------------|--------------------|-------------------------|----------------|
| | Class G, H, I, K, M | Diesel Locomotive | | | | W | B | T | L | | | | | | |
| LCDX8-10AH-L | #8 AWG | #8 AWG | #8 AWG | #10 | .63 | .41 | .42 | .08 | 1.63 | Red | P21 | 49 | 21 | 1/2 | 50 |
| LCDX8-14AH-L | | | | 1/4 | .63 | .48 | .42 | .07 | 1.71 | Red | P21 | 49 | 21 | 1/2 | 50 |
| LCDX8-14BH-L | | | | 1/4 | .75 | .48 | .42 | .07 | 1.84 | Red | P21 | 49 | 21 | 1/2 | 50 |
| LCDX8-14DH-L | | | | 1/4 | 1.00 | .48 | .42 | .07 | 2.09 | Red | P21 | 49 | 21 | 1/2 | 50 |
| LCDX8-38DH-L | | | | 3/8 | 1.00 | .60 | .42 | .05 | 2.30 | Red | P21 | 49 | 21 | 1/2 | 50 |
| LCDX6-10AH-L | #6 AWG | #6 AWG | #6 AWG | #10 | .63 | .46 | .48 | .08 | 1.68 | Blue | P24 | 7 | 24 | 9/16 | 50 |
| LCDX6-10BH-L | | | | #10 | .75 | .46 | .48 | .08 | 1.81 | Blue | P24 | 7 | 24 | 9/16 | 50 |
| LCDX6-10GH-L | | | | #10 | 1.50 | .46 | .48 | .08 | 2.56 | Blue | P24 | 7 | 24 | 9/16 | 50 |
| LCDX6-10PH-L | | | | #10 | .69 | .46 | .48 | .08 | 1.74 | Blue | P24 | 7 | 24 | 9/16 | 50 |
| LCDX6-14AH-L | | | | 1/4 | .63 | .48 | .48 | .08 | 1.77 | Blue | P24 | 7 | 24 | 9/16 | 50 |
| LCDX6-14BH-L | | | | 1/4 | .75 | .48 | .48 | .08 | 1.89 | Blue | P24 | 7 | 24 | 9/16 | 50 |
| LCDX6-14DH-L | | | | 1/4 | 1.00 | .48 | .48 | .08 | 2.14 | Blue | P24 | 7 | 24 | 9/16 | 50 |
| LCDX6-56DH-L | | | | 5/16 | 1.00 | .56 | .48 | .07 | 2.26 | Blue | P24 | 7 | 24 | 9/16 | 50 |
| LCDX6-38DH-L | | | | 3/8 | 1.00 | .62 | .48 | .06 | 2.35 | Blue | P24 | 7 | 24 | 9/16 | 50 |
| LCDX4-14AH-L | | | | #4 AWG | #5, #4, #3 AWG | #4 AWG | 1/4 | .63 | .55 | .53 | .09 | 1.83 | Gray | P29 | 8 |
| LCDX4-14BH-L | 1/4 | .75 | .55 | | | | .53 | .09 | 1.96 | Gray | P29 | 8 | 29 | 5/8 | 50 |
| LCDX4-14DH-L | 1/4 | 1.00 | .55 | | | | .53 | .09 | 2.21 | Gray | P29 | 8 | 29 | 5/8 | 50 |
| LCDX4-56DH-L | 5/16 | 1.00 | .55 | | | | .53 | .09 | 2.33 | Gray | P29 | 8 | 29 | 5/8 | 50 |
| LCDX4-38DH-L | 3/8 | 1.00 | .62 | .53 | .08 | 2.42 | Gray | P29 | 8 | 29 | 5/8 | 50 | | | |
| LCDX2-14AH-E* | #2 AWG | #2 AWG | #2 AWG | 1/4 | .63 | .70 | .59 | .11 | 1.92 | Brown | P33 | 10 | 33 | 11/16 | 20 |
| LCDX2-14BH-E* | | | | 1/4 | .75 | .70 | .59 | .11 | 2.04 | Brown | P33 | 10 | 33 | 11/16 | 20 |
| LCDX2-14DH-E* | | | | 1/4 | 1.00 | .70 | .59 | .11 | 2.29 | Brown | P33 | 10 | 33 | 11/16 | 20 |
| LCDX2-56DH-E* | | | | 5/16 | 1.00 | .70 | .59 | .11 | 2.42 | Brown | P33 | 10 | 33 | 11/16 | 20 |
| LCDX2-38DH-E* | | | | 3/8 | 1.00 | .70 | .59 | .11 | 2.49 | Brown | P33 | 10 | 33 | 11/16 | 20 |
| LCDX2-12H-E* | 1/2 | 1.75 | .75 | .59 | .09 | 3.66 | Brown | P33 | 10 | 33 | 11/16 | 20 | | | |
| LCDX1-14AH-X | #1 AWG | #1 AWG | #1 AWG | 1/4 | .63 | .76 | .66 | .12 | 2.06 | Green | P37 | 11 | 37 | 3/4 | 10 |
| LCDX1-14BH-X | | | | 1/4 | .75 | .76 | .66 | .12 | 2.18 | Green | P37 | 11 | 37 | 3/4 | 10 |
| LCDX1-14DH-X | | | | 1/4 | 1.00 | .76 | .66 | .12 | 2.43 | Green | P37 | 11 | 37 | 3/4 | 10 |
| LCDX1-56DH-X | | | | 5/16 | 1.00 | .76 | .66 | .12 | 2.49 | Green | P37 | 11 | 37 | 3/4 | 10 |
| LCDX1-38DH-X | | | | 3/8 | 1.00 | .76 | .66 | .12 | 2.56 | Green | P37 | 11 | 37 | 3/4 | 10 |
| LCDX1-12H-X | | | | 1/2 | 1.75 | .80 | .66 | .12 | 3.73 | Green | P37 | 11 | 37 | 3/4 | 10 |

‡See pages D3.66 – D3.69 for tool and die information.

*Not UL Listed or CSA Certified with Class K flex conductor when crimped with Burndy tools.

**Consult cable manufacturer for voltage stress relief instructions with applications greater than 2000 V.

◆NEMA hole sizes and spacing.

Table continues on page D2.86

A. System Overview

B1. Cable Ties



Flex Conductor, Two-Hole, Standard Barrel with Window Lug, 45° Angle (continued)

B2. Cable Accessories

B3. Stainless Steel Ties

C1. Wiring Duct

C2. Surface Raceway

C3. Abrasion Protection

C4. Cable Management

D1. Terminals

D2. Power Connectors

D3. Grounding Connectors

E1. Labeling Systems

E2. Labels

E3. Pre-Printed & Write-On Markers

E4. Permanent Identification

E5. Lockout/Tagout & Safety Solutions

F. Index

| Part Number | Flex Conductor Size | | Code Conductor Size | Stud Hole Size (In.) | Stud Hole Spacing (In.) | Figure Dimensions (In.) | | | | PANDUIT Color Code | PANDUIT Die Index No.‡ | Burndy Die Index No.‡ | T&B Die Index No.‡ | Wire Strip Length (In.) | Std. Pkg. Qty. | | | |
|----------------|---------------------|-------------------|---------------------|----------------------|-------------------------|-------------------------|--------|------|------|--------------------|------------------------|-----------------------|--------------------|-------------------------|----------------|----|-----|----|
| | Class G, H, I, K, M | Diesel Locomotive | | | | W | B | T | L | | | | | | | | | |
| LCDX1/0-14AH-X | 1/0 AWG | 1/0 AWG | 1/0 AWG | 1/4 | .63 | .85 | .72 | .13 | 2.21 | Pink | P42 | 12 | 42 | 3/4 | 10 | | | |
| LCDX1/0-14BH-X | | | | 1/4 | .75 | .85 | .72 | .13 | 2.33 | Pink | P42 | 12 | 42 | 3/4 | 10 | | | |
| LCDX1/0-56BH-X | | | | 5/16 | .75 | .85 | .72 | .13 | 2.33 | Pink | P42 | 12 | 42 | 3/4 | 10 | | | |
| LCDX1/0-56DH-X | | | | 5/16 | 1.00 | .85 | .72 | .13 | 2.58 | Pink | P42 | 12 | 42 | 3/4 | 10 | | | |
| LCDX1/0-38DH-X | | | | 3/8 | 1.00 | .85 | .72 | .13 | 2.64 | Pink | P42 | 12 | 42 | 3/4 | 10 | | | |
| LCDX1/0-12DH-X | | | | 1/2 | 1.00 | .85 | .72 | .13 | 2.89 | Pink | P42 | 12 | 42 | 3/4 | 10 | | | |
| LCDX1/0-12H-X | | | | 1/2 | 1.75 | .85 | .72 | .13 | 3.81 | Pink | P42 | 12 | 42 | 3/4 | 10 | | | |
| LCDX2/0-14AH-X | | | | 2/0 AWG | 2/0 AWG | 2/0 AWG | 1/4 | .63 | .96 | .83 | .13 | 2.30 | Black | P45 | 13 | 45 | 7/8 | 10 |
| LCDX2/0-14BH-X | | | | | | | 1/4 | .75 | .96 | .83 | .13 | 2.43 | Black | P45 | 13 | 45 | 7/8 | 10 |
| LCDX2/0-56DH-X | | | | | | | 5/16 | 1.00 | .96 | .83 | .13 | 2.68 | Black | P45 | 13 | 45 | 7/8 | 10 |
| LCDX2/0-38DH-X | 3/8 | 1.00 | .96 | | | | .83 | .13 | 2.74 | Black | P45 | 13 | 45 | 7/8 | 10 | | | |
| LCDX2/0-12DH-X | 1/2 | 1.00 | .96 | | | | .83 | .13 | 3.03 | Black | P45 | 13 | 45 | 7/8 | 10 | | | |
| LCDX2/0-12H-X | 1/2 | 1.75 | .96 | | | | .83 | .13 | 3.90 | Black | P45 | 13 | 45 | 7/8 | 10 | | | |
| LCDX3/0-14AH-X | 3/0 AWG | 3/0 AWG | 3/0 AWG | 1/4 | .63 | 1.06 | .91 | .14 | 2.39 | Orange | P50 | 14 | 50 | 1 | 10 | | | |
| LCDX3/0-56DH-X | | | | 5/16 | 1.00 | 1.06 | .91 | .14 | 2.78 | Orange | P50 | 14 | 50 | 1 | 10 | | | |
| LCDX3/0-38DH-X | | | | 3/8 | 1.00 | 1.06 | .91 | .14 | 2.85 | Orange | P50 | 14 | 50 | 1 | 10 | | | |
| LCDX3/0-12H-X | | | | 1/2 | 1.75 | 1.06 | .91 | .14 | 3.99 | Orange | P50 | 14 | 50 | 1 | 10 | | | |
| LCDX4/0-14AH-X | 4/0 AWG | 4/0 AWG | 4/0 AWG | 1/4 | .63 | 1.19 | 1.03 | .16 | 2.67 | Purple | P54 | 15 | 54 | 1 1/16 | 10 | | | |
| LCDX4/0-14BH-X | | | | 1/4 | .75 | 1.19 | 1.03 | .16 | 2.79 | Purple | P54 | 15 | 54 | 1 1/16 | 10 | | | |
| LCDX4/0-56DH-X | | | | 5/16 | 1.00 | 1.19 | 1.03 | .16 | 3.04 | Purple | P54 | 15 | 54 | 1 1/16 | 10 | | | |
| LCDX4/0-38DH-X | | | | 3/8 | 1.00 | 1.19 | 1.03 | .16 | 3.07 | Purple | P54 | 15 | 54 | 1 1/16 | 10 | | | |
| LCDX4/0-12DH-X | | | | 1/2 | 1.00 | 1.19 | 1.03 | .16 | 3.36 | Purple | P54 | 15 | 54 | 1 1/16 | 10 | | | |
| LCDX4/0-12EH-X | | | | 1/2 | 1.25 | 1.19 | 1.03 | .16 | 3.62 | Purple | P54 | 15 | 54 | 1 1/16 | 10 | | | |
| LCDX4/0-12H-X | 1/2 | 1.75 | 1.19 | 1.03 | .16 | 4.25 | Purple | P54 | 15 | 54 | 1 1/16 | 10 | | | | | | |
| LCDX250-38DH-X | 250 kcmil | 262.6 kcmil | — | 3/8 | 1.00 | 1.28 | 1.03 | .17 | 3.11 | Yellow | P62 | 16 | 62 | 1 1/16 | 10 | | | |
| LCDX250-38H-X | | | | 3/8 | 1.75 | 1.28 | 1.03 | .17 | 3.86 | Yellow | P62 | 16 | 62 | 1 1/16 | 10 | | | |
| LCDX250-12EH-X | | | | 1/2 | 1.25 | 1.28 | 1.03 | .17 | 3.66 | Yellow | P62 | 16 | 62 | 1 1/16 | 10 | | | |
| LCDX250-12H-X | | | | 1/2 | 1.75 | 1.28 | 1.03 | .17 | 4.29 | Yellow | P62 | 16 | 62 | 1 1/16 | 10 | | | |
| LCDX300-38DH-6 | 300 kcmil | 313.1 kcmil | — | 3/8 | 1.00 | 1.39 | 1.19 | .18 | 3.29 | Red | P71 | 18 | 71H | 1 1/4 | 6 | | | |
| LCDX300-12H-6 | | | | 1/2 | 1.75 | 1.39 | 1.19 | .18 | 4.47 | Red | P71 | 18 | 71H | 1 1/4 | 6 | | | |
| LCDX350-56DH-6 | 350 kcmil | 373.7 kcmil | — | 5/16 | 1.00 | 1.54 | 1.29 | .22 | 3.40 | Blue | P76 | 19 | 76H | 1 3/8 | 6 | | | |
| LCDX350-38DH-6 | | | | 3/8 | 1.00 | 1.54 | 1.29 | .22 | 3.43 | Blue | P76 | 19 | 76H | 1 3/8 | 6 | | | |
| LCDX350-38H-6 | | | | 3/8 | 1.75 | 1.54 | 1.29 | .22 | 4.18 | Blue | P76 | 19 | 76H | 1 3/8 | 6 | | | |
| LCDX350-12EH-6 | | | | 1/2 | 1.25 | 1.54 | 1.29 | .22 | 3.98 | Blue | P76 | 19 | 76H | 1 3/8 | 6 | | | |
| LCDX350-12H-6 | 1/2 | 1.75 | 1.54 | 1.29 | .22 | 4.61 | Blue | P76 | 19 | 76H | 1 3/8 | 6 | | | | | | |
| LCDX450-38DH-6 | 450 kcmil | 444.4 kcmil | — | 3/8 | 1.00 | 1.70 | 1.40 | .26 | 3.75 | Brown | P87 | 20 | 87H | 1 7/16 | 6 | | | |
| LCDX450-12H-6 | | | | 1/2 | 1.75 | 1.70 | 1.40 | .26 | 4.74 | Brown | P87 | 20 | 87H | 1 7/16 | 6 | | | |
| LCDX500-56DH-6 | 500 kcmil | 535.3 kcmil | — | 5/16 | 1.00 | 1.89 | 1.48 | .26 | 3.70 | Pink | P99 | L99 | 99H | 1 9/16 | 6 | | | |
| LCDX500-38DH-6 | | | | 3/8 | 1.00 | 1.89 | 1.48 | .26 | 3.73 | Pink | P99 | L99 | 99H | 1 9/16 | 6 | | | |
| LCDX500-12EH-6 | | | | 1/2 | 1.25 | 1.89 | 1.48 | .26 | 4.41 | Pink | P99 | L99 | 99H | 1 9/16 | 6 | | | |
| LCDX500-12H-6 | | | | 1/2 | 1.75 | 1.89 | 1.48 | .26 | 4.91 | Pink | P99 | L99 | 99H | 1 9/16 | 6 | | | |
| LCDX600-12H-6 | 600 kcmil | — | — | 1/2 | 1.75 | 1.89 | 1.48 | .26 | 4.91 | Pink | P99 | 400 | 99H | 1 9/16 | 6 | | | |
| LCDX650-38DH-6 | — | 646.4 kcmil | — | 3/8 | 1.00 | 1.95 | 1.45 | .30 | 3.74 | Black | P106 | 24 | 106H | 1 1/2 | 6 | | | |
| LCDX650-12H-6 | | | | 1/2 | 1.75 | 1.95 | 1.45 | .30 | 4.92 | Black | P106 | 24 | 106H | 1 1/2 | 6 | | | |
| LCDX750-38DH-3 | — | 777.7 kcmil | — | 3/8 | 1.00 | 2.17 | 1.66 | .32 | 4.21 | Yellow | P115 | L115 | 115H | 1 3/4 | 3 | | | |
| LCDX750-12EH-3 | | | | 1/2 | 1.25 | 2.17 | 1.66 | .32 | 4.65 | Yellow | P115 | L115 | 115H | 1 3/4 | 3 | | | |
| LCDX750-12GH-3 | | | | 1/2 | 1.50 | 2.17 | 1.66 | .32 | 4.90 | Yellow | P115 | L115 | 115H | 1 3/4 | 3 | | | |
| LCDX750-12H-3 | | | | 1/2 | 1.75 | 2.17 | 1.66 | .32 | 5.15 | Yellow | P115 | L115 | 115H | 1 3/4 | 3 | | | |
| LCDX750-58GH-3 | 5/8 | 1.50 | 2.17 | 1.66 | .32 | 4.90 | Yellow | P115 | L115 | 115H | 1 3/4 | 3 | | | | | | |

‡See pages D3.66 – D3.69 for tool and die information.
 **Consult cable manufacturer for voltage stress relief instructions with applications greater than 2000 V.
 ◆NEMA hole sizes and spacing.



Flex Conductor, Two-Hole, Standard Barrel with Window Lug, 90° Angle

For Use with Flexible, Extra-Flexible, and Code Stranded Copper Conductors

Type LCDX-F

- Can be used with code conductor and flex conductor class: G, H, I, K, M and Diesel Locomotive
- Generously beveled wire entry prevents bent back strands when inserting conductor into barrel
- Color-coded barrels marked with *PANDUIT* and specified competitor die index numbers for proper crimp die selection
- Inspection window to visually assure full conductor insertion
- Tin-plated to inhibit corrosion
- UL Listed and CSA Certified to 35 KV** and temperature rated to 90°C when crimped with *PANDUIT* and specified competitor crimping tools and dies
- American Bureau of Shipping approved
- Available with NEMA hole sizes and spacing

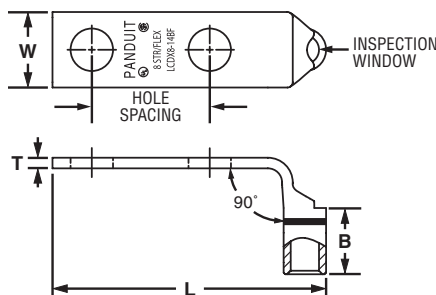

| Part Number | Flex Conductor Size | | Code Conductor Size | Stud Hole Size (In.) | Stud Hole Spacing (In.) | Figure Dimensions (In.) | | | | PANDUIT Color Code | PANDUIT Die Index No.‡ | Burndy Die Index No.‡ | T&B Die Index No.‡ | Wire Strip Length (In.) | Std. Pkg. Qty. |
|---------------|---------------------|-------------------|---------------------|----------------------|-------------------------|-------------------------|-------|-----|------|--------------------|------------------------|-----------------------|--------------------|-------------------------|----------------|
| | Class G, H, I, K, M | Diesel Locomotive | | | | W | B | T | L | | | | | | |
| LCDX8-10AF-L | #8 AWG | #8 AWG | #8 AWG | #10 | .63 | .41 | .42 | .08 | 1.53 | Red | P21 | 49 | 21 | 1/2 | 50 |
| LCDX8-14AF-L | | | | 1/4 | .63 | .48 | .42 | .07 | 1.62 | Red | P21 | 49 | 21 | 1/2 | 50 |
| LCDX8-14BF-L | | | | 1/4 | .75 | .48 | .42 | .07 | 1.74 | Red | P21 | 49 | 21 | 1/2 | 50 |
| LCDX8-14DF-L | | | | 1/4 | 1.00 | .48 | .42 | .07 | 1.99 | Red | P21 | 49 | 21 | 1/2 | 50 |
| LCDX8-38DF-L | | | | 3/8 | 1.00 | .63 | .42 | .05 | 2.21 | Red | P21 | 49 | 21 | 1/2 | 50 |
| LCDX6-10AF-L | #6 AWG | #6 AWG | #6 AWG | #10 | .63 | .46 | .48 | .08 | 1.57 | Blue | P24 | 7 | 24 | 9/16 | 50 |
| LCDX6-10BF-L | | | | #10 | .75 | .46 | .48 | .08 | 1.69 | Blue | P24 | 7 | 24 | 9/16 | 50 |
| LCDX6-10GF-L | | | | #10 | 1.50 | .46 | .48 | .08 | 2.44 | Blue | P24 | 7 | 24 | 9/16 | 50 |
| LCDX6-10PF-L | | | | #10 | .69 | .46 | .48 | .08 | 1.63 | Blue | P24 | 7 | 24 | 9/16 | 50 |
| LCDX6-14AF-L | | | | 1/4 | .63 | .48 | .48 | .08 | 1.66 | Blue | P24 | 7 | 24 | 9/16 | 50 |
| LCDX6-14BF-L | | | | 1/4 | .75 | .48 | .48 | .08 | 1.78 | Blue | P24 | 7 | 24 | 9/16 | 50 |
| LCDX6-14DF-L | | | | 1/4 | 1.00 | .48 | .48 | .08 | 2.03 | Blue | P24 | 7 | 24 | 9/16 | 50 |
| LCDX6-56DF-L | | | | 5/16 | 1.00 | .56 | .48 | .07 | 2.15 | Blue | P24 | 7 | 24 | 9/16 | 50 |
| LCDX6-38DF-L | | | | 3/8 | 1.00 | .62 | .48 | .06 | 2.25 | Blue | P24 | 7 | 24 | 9/16 | 50 |
| LCDX4-14AF-L | | | | #4 AWG | #5, #4, #3 AWG | #4 AWG | 1/4 | .63 | .55 | .53 | .09 | 1.74 | Gray | P29 | 8 |
| LCDX4-14BF-L | 1/4 | .75 | .55 | | | | .53 | .09 | 1.87 | Gray | P29 | 8 | 29 | 5/8 | 50 |
| LCDX4-14DF-L | 1/4 | 1.00 | .55 | | | | .53 | .09 | 2.12 | Gray | P29 | 8 | 29 | 5/8 | 50 |
| LCDX4-56DF-L | 5/16 | 1.00 | .55 | | | | .53 | .09 | 2.24 | Gray | P29 | 8 | 29 | 5/8 | 50 |
| LCDX4-38DF-L | 3/8 | 1.00 | .62 | | | | .53 | .08 | 2.34 | Gray | P29 | 8 | 29 | 5/8 | 50 |
| LCDX2-14AF-E* | #2 AWG | #2 AWG | #2 AWG | 1/4 | .63 | .70 | .59 | .11 | 1.94 | Brown | P33 | 10 | 33 | 11/16 | 20 |
| LCDX2-14BF-E* | | | | 1/4 | .75 | .70 | .59 | .11 | 2.06 | Brown | P33 | 10 | 33 | 11/16 | 20 |
| LCDX2-14DF-E* | | | | 1/4 | 1.00 | .70 | .59 | .11 | 2.31 | Brown | P33 | 10 | 33 | 11/16 | 20 |
| LCDX2-56DF-E* | | | | 5/16 | 1.00 | .70 | .59 | .11 | 2.44 | Brown | P33 | 10 | 33 | 11/16 | 20 |
| LCDX2-38DF-E* | | | | 3/8 | 1.00 | .70 | .59 | .11 | 2.51 | Brown | P33 | 10 | 33 | 11/16 | 20 |
| LCDX2-12F-E* | 1/2 | 1.75 | .75 | .59 | .09 | 3.68 | Brown | P33 | 10 | 33 | 11/16 | 20 | | | |
| LCDX1-14AF-X | #1 AWG | #1 AWG | #1 AWG | 1/4 | .63 | .76 | .66 | .12 | 2.08 | Green | P37 | 11 | 37 | 3/4 | 10 |
| LCDX1-14BF-X | | | | 1/4 | .75 | .76 | .66 | .12 | 2.20 | Green | P37 | 11 | 37 | 3/4 | 10 |
| LCDX1-14DF-X | | | | 1/4 | 1.00 | .76 | .66 | .12 | 2.45 | Green | P37 | 11 | 37 | 3/4 | 10 |
| LCDX1-56DF-X | | | | 5/16 | 1.00 | .76 | .66 | .12 | 2.51 | Green | P37 | 11 | 37 | 3/4 | 10 |
| LCDX1-38DF-X | | | | 3/8 | 1.00 | .76 | .66 | .12 | 2.58 | Green | P37 | 11 | 37 | 3/4 | 10 |
| LCDX1-12F-X | | | | 1/2 | 1.75 | .80 | .66 | .12 | 3.75 | Green | P37 | 11 | 37 | 3/4 | 10 |

‡See pages D3.66 – D3.69 for tool and die information.

*Not UL Listed or CSA Certified with Class K flex conductor when crimped with Burndy tools.

**Consult cable manufacturer for voltage stress relief instructions with applications greater than 2000 V.

Table continues on page D2.88

A. System Overview

B1. Cable Ties

B2. Cable Accessories

B3. Stainless Steel Ties

C1. Wiring Duct

C2. Surface Raceway

C3. Abrasion Protection

C4. Cable Management

D1. Terminals

D2. Power Connectors

D3. Grounding Connectors

E1. Labeling Systems

E2. Labels

E3. Pre-Printed & Write-On Markers

E4. Permanent Identification

E5. Lockout/Tagout & Safety Solutions

F. Index

A. System Overview

B1. Cable Ties



Flex Conductor, Two-Hole, Standard Barrel with Window Lug, 90° Angle (continued)

B2. Cable Accessories

B3. Stainless Steel Ties

C1. Wiring Duct

C2. Surface Raceway

C3. Abrasion Protection

C4. Cable Management

D1. Terminals

D2. Power Connectors

D3. Grounding Connectors

E1. Labeling Systems

E2. Labels

E3. Pre-Printed & Write-On Markers

E4. Permanent Identification

E5. Lockout/Tagout & Safety Solutions

| Part Number | Flex Conductor Size | | Code Conductor Size | Stud Hole Size (In.) | Stud Hole Spacing (In.) | Figure Dimensions (In.) | | | | PANDUIT Color Code | PANDUIT Die Index No.‡ | Burdny Die Index No.‡ | T&B Die Index No.‡ | Wire Strip Length (In.) | Std. Pkg. Qty. |
|----------------|---------------------|-------------------|---------------------|----------------------|-------------------------|-------------------------|------|-----|------|--------------------|------------------------|-----------------------|--------------------|-------------------------|----------------|
| | Class G, H, I, K, M | Diesel Locomotive | | | | W | B | T | L | | | | | | |
| LCDX1/0-14AF-X | | | | 1/4 | .63 | .85 | .72 | .13 | 2.22 | Pink | P42 | 12 | 42 | 3/4 | 10 |
| LCDX1/0-14BF-X | | | | 1/4 | .75 | .85 | .72 | .13 | 2.34 | Pink | P42 | 12 | 42 | 3/4 | 10 |
| LCDX1/0-56BF-X | | | | 5/16 | .75 | .85 | .72 | .13 | 2.34 | Pink | P42 | 12 | 42 | 3/4 | 10 |
| LCDX1/0-56DF-X | | | | 5/16 | 1.00 | .85 | .72 | .13 | 2.59 | Pink | P42 | 12 | 42 | 3/4 | 10 |
| LCDX1/0-38DF-X | | | | 3/8 | 1.00 | .85 | .72 | .13 | 2.66 | Pink | P42 | 12 | 42 | 3/4 | 10 |
| LCDX1/0-12DF-X | | | | 1/2 | 1.00 | .85 | .72 | .13 | 2.91 | Pink | P42 | 12 | 42 | 3/4 | 10 |
| LCDX1/0-12F-X | | | | 1/2 | 1.75 | .85 | .72 | .13 | 3.82 | Pink | P42 | 12 | 42 | 3/4 | 10 |
| LCDX2/0-14AF-X | | | | 1/4 | .63 | .96 | .83 | .13 | 2.29 | Black | P45 | 13 | 45 | 7/8 | 10 |
| LCDX2/0-14BF-X | | | | 1/4 | .75 | .96 | .83 | .13 | 2.42 | Black | P45 | 13 | 45 | 7/8 | 10 |
| LCDX2/0-56DF-X | | | | 5/16 | 1.00 | .96 | .83 | .13 | 2.67 | Black | P45 | 13 | 45 | 7/8 | 10 |
| LCDX2/0-38DF-X | | | | 3/8 | 1.00 | .96 | .83 | .13 | 2.73 | Black | P45 | 13 | 45 | 7/8 | 10 |
| LCDX2/0-12DF-X | | | | 1/2 | 1.00 | .96 | .83 | .13 | 2.98 | Black | P45 | 13 | 45 | 7/8 | 10 |
| LCDX2/0-12F-X | | | | 1/2 | 1.75 | .96 | .83 | .13 | 3.89 | Black | P45 | 13 | 45 | 7/8 | 10 |
| LCDX3/0-14AF-X | | | | 1/4 | .63 | 1.06 | .91 | .14 | 2.38 | Orange | P50 | 14 | 50 | 1 | 10 |
| LCDX3/0-56DF-X | | | | 5/16 | 1.00 | 1.06 | .91 | .14 | 2.77 | Orange | P50 | 14 | 50 | 1 | 10 |
| LCDX3/0-38DF-X | | | | 3/8 | 1.00 | 1.06 | .91 | .14 | 2.84 | Orange | P50 | 14 | 50 | 1 | 10 |
| LCDX3/0-12F-X | | | | 1/2 | 1.75 | 1.06 | .91 | .14 | 3.98 | Orange | P50 | 14 | 50 | 1 | 10 |
| LCDX4/0-14AF-X | | | | 1/4 | .63 | 1.19 | 1.03 | .16 | 2.28 | Purple | P54 | 15 | 54 | 1 1/16 | 10 |
| LCDX4/0-14BF-X | | | | 1/4 | .75 | 1.19 | 1.03 | .16 | 2.40 | Purple | P54 | 15 | 54 | 1 1/16 | 10 |
| LCDX4/0-56DF-X | | | | 5/16 | 1.00 | 1.19 | 1.03 | .16 | 2.85 | Purple | P54 | 15 | 54 | 1 1/16 | 10 |
| LCDX4/0-38DF-X | | | | 3/8 | 1.00 | 1.19 | 1.03 | .16 | 2.88 | Purple | P54 | 15 | 54 | 1 1/16 | 10 |
| LCDX4/0-12DF-X | | | | 1/2 | 1.00 | 1.19 | 1.03 | .16 | 3.15 | Purple | P54 | 15 | 54 | 1 1/16 | 10 |
| LCDX4/0-12EF-X | | | | 1/2 | 1.25 | 1.19 | 1.03 | .16 | 3.43 | Purple | P54 | 15 | 54 | 1 1/16 | 10 |
| LCDX4/0-12F-X | | | | 1/2 | 1.75 | 1.19 | 1.03 | .16 | 4.06 | Purple | P54 | 15 | 54 | 1 1/16 | 10 |
| LCDX250-38DF-X | | | | 3/8 | 1.00 | 1.28 | 1.03 | .17 | 2.94 | Yellow | P62 | 16 | 62 | 1 1/16 | 10 |
| LCDX250-38F-X | | | | 3/8 | 1.75 | 1.28 | 1.03 | .17 | 3.69 | Yellow | P62 | 16 | 62 | 1 1/16 | 10 |
| LCDX250-12EF-X | | | | 1/2 | 1.25 | 1.28 | 1.03 | .17 | 3.49 | Yellow | P62 | 16 | 62 | 1 1/16 | 10 |
| LCDX250-12F-X | | | | 1/2 | 1.75 | 1.28 | 1.03 | .17 | 4.12 | Yellow | P62 | 16 | 62 | 1 1/16 | 10 |
| LCDX300-38DF-6 | | | | 3/8 | 1.00 | 1.39 | 1.19 | .18 | 3.02 | Red | P71 | 18 | 71H | 1 1/4 | 6 |
| LCDX300-12F-6 | | | | 1/2 | 1.75 | 1.39 | 1.19 | .18 | 4.20 | Red | P71 | 18 | 71H | 1 1/4 | 6 |
| LCDX350-56DF-6 | | | | 5/16 | 1.00 | 1.54 | 1.29 | .22 | 3.10 | Blue | P76 | 19 | 76H | 1 3/8 | 6 |
| LCDX350-38DF-6 | | | | 3/8 | 1.00 | 1.54 | 1.29 | .22 | 3.13 | Blue | P76 | 19 | 76H | 1 3/8 | 6 |
| LCDX350-38F-6 | | | | 3/8 | 1.75 | 1.54 | 1.29 | .22 | 3.88 | Blue | P76 | 19 | 76H | 1 3/8 | 6 |
| LCDX350-12EF-6 | | | | 1/2 | 1.25 | 1.54 | 1.29 | .22 | 3.68 | Blue | P76 | 19 | 76H | 1 3/8 | 6 |
| LCDX350-12F-6 | | | | 1/2 | 1.75 | 1.54 | 1.29 | .22 | 4.31 | Blue | P76 | 19 | 76H | 1 3/8 | 6 |
| LCDX450-38DF-6 | | | | 3/8 | 1.00 | 1.70 | 1.40 | .26 | 3.26 | Brown | P87 | 20 | 87H | 1 7/16 | 6 |
| LCDX450-12F-6 | | | | 1/2 | 1.75 | 1.70 | 1.40 | .26 | 4.44 | Brown | P87 | 20 | 87H | 1 7/16 | 6 |
| LCDX500-56DF-6 | | | | 5/16 | 1.00 | 1.89 | 1.48 | .26 | 3.29 | Pink | P99 | L99 | 99H | 1 9/16 | 6 |
| LCDX500-38DF-6 | | | | 3/8 | 1.00 | 1.89 | 1.48 | .26 | 3.32 | Pink | P99 | L99 | 99H | 1 9/16 | 6 |
| LCDX500-12EF-6 | | | | 1/2 | 1.25 | 1.89 | 1.48 | .26 | 4.00 | Pink | P99 | L99 | 99H | 1 9/16 | 6 |
| LCDX500-12F-6 | | | | 1/2 | 1.75 | 1.89 | 1.48 | .26 | 4.50 | Pink | P99 | L99 | 99H | 1 9/16 | 6 |
| LCDX600-12F-6 | | | | 1/2 | 1.75 | 1.89 | 1.48 | .26 | 4.50 | Pink | P99 | 400 | 99H | 1 9/16 | 6 |
| LCDX650-38DF-6 | | | | 3/8 | 1.00 | 1.95 | 1.45 | .30 | 3.37 | Black | P106 | 24 | 106H | 1 1/2 | 6 |
| LCDX650-12F-6 | | | | 1/2 | 1.75 | 1.95 | 1.45 | .30 | 4.55 | Black | P106 | 24 | 106H | 1 1/2 | 6 |
| LCDX750-38DF-3 | | | | 3/8 | 1.00 | 2.17 | 1.66 | .32 | 3.76 | Yellow | P115 | L115 | 115H | 1 3/4 | 3 |
| LCDX750-12EF-3 | | | | 1/2 | 1.25 | 2.17 | 1.66 | .32 | 4.20 | Yellow | P115 | L115 | 115H | 1 3/4 | 3 |
| LCDX750-12GF-3 | | | | 1/2 | 1.50 | 2.17 | 1.66 | .32 | 4.45 | Yellow | P115 | L115 | 115H | 1 3/4 | 3 |
| LCDX750-12F-3 | | | | 1/2 | 1.75 | 2.17 | 1.66 | .32 | 4.70 | Yellow | P115 | L115 | 115H | 1 3/4 | 3 |
| LCDX750-58GF-3 | | | | 5/8 | 1.50 | 2.17 | 1.66 | .32 | 4.45 | Yellow | P115 | L115 | 115H | 1 3/4 | 3 |

‡See pages D3.66 – D3.69 for tool and die information.

**Consult cable manufacturer for voltage stress relief instructions with applications greater than 2000 V.

◆NEMA hole sizes and spacing.



Flex Conductor, Two-Hole, Standard Barrel with Window, Narrow Tongue Lug

For Use with Flexible, Extra-Flexible, and Code Stranded Copper Conductors

Type LCDXN

- Narrow tongue width for limited space applications
- Can be used with code conductor and flex conductor class: G, H, I, K, M and Diesel Locomotive
- Generously beveled wire entry prevents bent back strands when inserting conductor into barrel
- Color-coded barrels marked with *PANDUIT* and specified competitor die index numbers for proper crimp die selection
- Inspection window to visually assure full conductor insertion
- Tin-plated to inhibit corrosion
- UL Listed and CSA Certified to 35 KV** and temperature rated to 90°C when crimped with *PANDUIT* and specified competitor crimping tools and dies
- Available with NEMA hole sizes and spacing

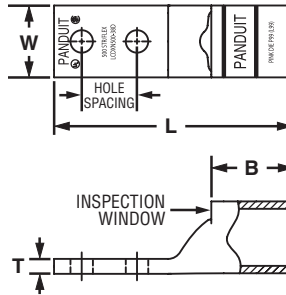

| Part Number | Flex Conductor Size | | Code Conductor Size | Stud Hole Size (In.) | Stud Hole Spacing (In.) | Figure Dimensions (In.) | | | | PANDUIT Color Code | PANDUIT Die Index No.‡ | Burdny Die Index No.‡ | T&B Die Index No.‡ | Wire Strip Length (In.) | Std. Pkg. Qty. |
|-----------------|---------------------|-------------------|---------------------|----------------------|-------------------------|-------------------------|------|-----|------|--------------------|------------------------|-----------------------|--------------------|-------------------------|----------------|
| | Class G, H, I, K, M | Diesel Locomotive | | | | W | B | T | L | | | | | | |
| LCDXN2-14A-E* | #2 AWG | #2 AWG | #2 AWG | 1/4 | .63 | .47 | .59 | .11 | 2.13 | Brown | P33 | 10 | 33 | 11/16 | 20 |
| LCDXN4/0-38D-X | 4/0 AWG | 4/0 AWG | 4/0 AWG | 3/8 | 1.00 | .81 | 1.03 | .16 | 3.34 | Purple | P54 | 15 | 54 | 1 1/16 | 10 |
| LCDXN350-38D-6 | 350 kcmil | 373.7 kcmil | — | 3/8 | 1.00 | 1.06 | 1.29 | .22 | 3.74 | Blue | P76 | 19 | 76H | 1 3/8 | 6 |
| LCDXN500-38D-6 | 500 kcmil | 535.3 kcmil | — | 3/8 | 1.00 | 1.30 | 1.48 | .28 | 4.32 | Pink | P99 | L99 | 99H | 1 9/16 | 6 |
| LCDXN750-38D-3 | — | 777.7 kcmil | — | 3/8 | 1.00 | 1.50 | 1.66 | .34 | 4.62 | Yellow | P115 | L115 | 115H | 1 3/4 | 3 |
| ◆ LCDXN750-12-3 | — | 777.7 kcmil | — | 1/2 | 1.75 | 1.50 | 1.66 | .35 | 5.55 | Yellow | P115 | L115 | 115H | 1 3/4 | 3 |

‡See pages D3.66 – D3.69 for tool and die information.

*Not UL Listed or CSA Certified with Class K flex conductor when crimped with Burdny tools.

**Consult cable manufacturer for voltage stress relief instructions with applications greater than 2000 V.

◆NEMA hole sizes and spacing.

A. System Overview

B1. Cable Ties

B2. Cable Accessories

B3. Stainless Steel Ties

C1. Wiring Duct

C2. Surface Raceway

C3. Abrasion Protection

C4. Cable Management

D1. Terminals

D2. Power Connectors

D3. Grounding Connectors

E1. Labeling Systems

E2. Labels

E3. Pre-Printed & Write-On Markers

E4. Permanent Identification

E5. Lockout/Tagout & Safety Solutions

F. Index

A. System Overview

B1. Cable Ties

B2. Cable Accessories

B3. Stainless Steel Ties

C1. Wiring Duct

C2. Surface Raceway

C3. Abrasion Protection

C4. Cable Management

D1. Terminals

D2. Power Connectors

D3. Grounding Connectors

E1. Labeling Systems

E2. Labels

E3. Pre-Printed & Write-On Markers

E4. Permanent Identification

E5. Lockout/Tagout & Safety Solutions

F. Index



Flex Conductor, Two-Hole, Standard Barrel with Window, Narrow Tongue Lug, 45°

For Use with Flexible Copper Conductors

Type LCDXN-H

- Narrow tongue width for limited space applications
- To be used with Diesel Locomotive flex conductor
- Generously beveled wire entry prevents bent back strands when inserting conductor into barrel
- Color-coded barrels marked with *PANDUIT* and specified competitor die index numbers for proper crimp die selection

- Inspection window to visually assure full conductor insertion
- Tin-plated to inhibit corrosion
- UL Listed and CSA Certified to 35 KV** and temperature rated to 90°C when crimped with *PANDUIT* and specified competitor crimping tools and dies

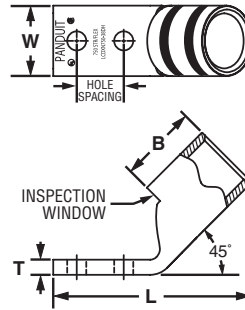

| Part Number | Flex Conductor Size | | Stud Hole Size (In.) | Stud Hole Spacing (In.) | Figure Dimensions (In.) | | | | PANDUIT Color Code | PANDUIT Die Index No. ‡ | Burndy Die Index No. ‡ | T&B Die Index No. ‡ | Wire Strip Length (In.) | Std. Pkg. Qty. |
|-----------------|---------------------|-------------------|----------------------|-------------------------|-------------------------|------|-----|------|--------------------|-------------------------|------------------------|---------------------|-------------------------|----------------|
| | Class G, H, I, K, M | Diesel Locomotive | | | W | B | T | L | | | | | | |
| LCDXN750-38DH-3 | — | 777.7 kcmil | 3/8 | 1.00 | 1.50 | 1.66 | .35 | 4.22 | Yellow | P115 | L115 | 115H | 1 3/4 | 3 |

‡See pages D3.66 – D3.69 for tool and die information.

**Consult cable manufacturer for voltage stress relief instructions with applications greater than 2000 V.



Flex Conductor, Two-Hole, Standard Barrel with Window, Narrow Tongue Lug, 90°

For Use with Flexible Copper Conductors

Type LCDXN-F

- Narrow tongue width for limited space applications
- To be used with Diesel Locomotive flex conductor
- Generously beveled wire entry prevents bent back strands when inserting conductor into barrel
- Color-coded barrels marked with *PANDUIT* and specified competitor die index numbers for proper crimp die selection

- Inspection window to visually assure full conductor insertion
- Tin-plated to inhibit corrosion
- UL Listed and CSA Certified to 35 KV** and temperature rated to 90°C when crimped with *PANDUIT* and specified competitor crimping tools and dies

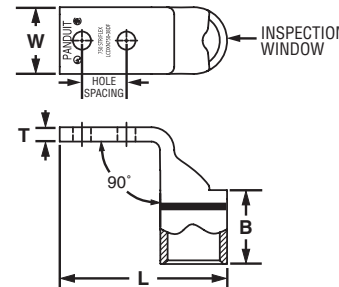

| Part Number | Flex Conductor Size | | Stud Hole Size (In.) | Stud Hole Spacing (In.) | Figure Dimensions (In.) | | | | PANDUIT Color Code | PANDUIT Die Index No. ‡ | Burndy Die Index No. | T&B Die Index No. | Wire Strip Length (In.) | Std. Pkg. Qty. |
|-----------------|---------------------|-------------------|----------------------|-------------------------|-------------------------|------|-----|------|--------------------|-------------------------|----------------------|-------------------|-------------------------|----------------|
| | Class G, H, I, K, M | Diesel Locomotive | | | W | B | T | L | | | | | | |
| LCDXN750-38DF-3 | — | 777.7 kcmil | 3/8 | 1.00 | 1.50 | 1.66 | .35 | 3.76 | Yellow | P115 | L115 | 115H | 1 3/4 | 3 |

‡See pages D3.66 – D3.69 for tool and die information.

**Consult cable manufacturer for voltage stress relief instructions with applications greater than 2000 V.



Flex Conductor, Two-Hole, Long Barrel with Window Lug

For Use with Flexible, Extra-Flexible, and Code Stranded Copper Conductors

Type LCCX

- Can be used with code conductor and flex conductor class: G, H, I, K, M and Diesel Locomotive
- Long barrel maximizes number of crimps and provides premium wire pull-out strength and electrical performance
- Generously beveled wire entry prevents bent back strands when inserting conductor into barrel
- Color-coded barrels marked with *PANDUIT* and specified competitor die index numbers for proper crimp die selection
- Inspection window to visually assure full conductor insertion
- Tin-plated to inhibit corrosion
- UL Listed and CSA Certified to 35 KV** and temperature rated to 90°C when crimped with *PANDUIT* and specified competitor crimping tools and dies
- Meets J-STD-607-A and TIA-942 requirements for network systems grounding applications
- Available with NEMA hole sizes and spacing

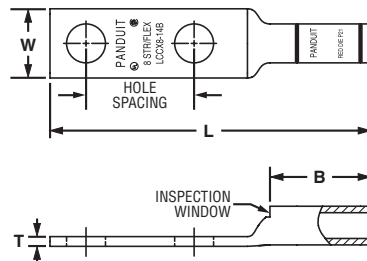

Figure 1

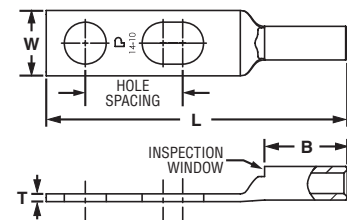

Figure 2: Slotted

| Part Number | Flex Conductor Size | | Code Conductor Size | Stud Hole Size (In.) | Stud Hole Spacing (In.) | Figure Dimensions (In.) | | | | PANDUIT Color Code | PANDUIT Die Index No.‡ | Burndy Die Index No. | T&B Die Index No. | Wire Strip Length (In.) | Std. Pkg. Qty. |
|---------------|---------------------|-------------------|---------------------|----------------------|-------------------------|-------------------------|------|-----|------|--------------------|------------------------|----------------------|-------------------|-------------------------|----------------|
| | Class G, H, I, K, M | Diesel Locomotive | | | | W | B | T | L | | | | | | |
| LCCX8-10A-L | #8 AWG | #8 AWG | #8 AWG | #10 | .63 | .41 | .70 | .08 | 2.01 | Red | P21 | 49 | 21 | 3/4 | 50 |
| LCCX8-10B-L | | | | #10 | .75 | .41 | .70 | .08 | 2.14 | Red | P21 | 49 | 21 | 3/4 | 50 |
| LCCX8-10AB-L* | | | | #10 | .63 – .75 | .41 | .70 | .08 | 2.14 | Red | P21 | 49 | 21 | 3/4 | 50 |
| LCCX8-14A-L | | | | 1/4 | .63 | .48 | .70 | .07 | 2.10 | Red | P21 | 49 | 21 | 3/4 | 50 |
| LCCX8-14B-L | | | | 1/4 | .75 | .48 | .70 | .07 | 2.23 | Red | P21 | 49 | 21 | 3/4 | 50 |
| LCCX8-14AB-L* | | | | 1/4 | .63 – .75 | .48 | .70 | .07 | 2.23 | Red | P21 | 49 | 21 | 3/4 | 50 |
| LCCX8-14D-L | | | | 1/4 | 1.00 | .48 | .70 | .07 | 2.48 | Red | P21 | 49 | 21 | 3/4 | 50 |
| LCCX8-38D-L | | | | 3/8 | 1.00 | .60 | .70 | .05 | 2.70 | Red | P21 | 49 | 21 | 3/4 | 50 |
| LCCX6-10B-L | #6 AWG | #6 AWG | #6 AWG | #10 | .75 | .46 | 1.07 | .08 | 2.52 | Blue | P24 | 7 | 24 | 1 1/8 | 50 |
| LCCX6-14A-L | | | | 1/4 | .63 | .48 | 1.07 | .08 | 2.49 | Blue | P24 | 7 | 24 | 1 1/8 | 50 |
| LCCX6-14B-L | | | | 1/4 | .75 | .48 | 1.07 | .08 | 2.61 | Blue | P24 | 7 | 24 | 1 1/8 | 50 |
| LCCX6-14AB-L* | | | | 1/4 | .63 – .75 | .48 | 1.07 | .08 | 2.61 | Blue | P24 | 7 | 24 | 1 1/8 | 50 |
| LCCX6-14D-L | | | | 1/4 | 1.00 | .48 | 1.07 | .08 | 2.86 | Blue | P24 | 7 | 24 | 1 1/8 | 50 |
| LCCX6-38A-L | | | | 3/8 | .63 | .62 | 1.07 | .06 | 2.71 | Blue | P24 | 7 | 24 | 1 1/8 | 50 |
| LCCX6-38C-L | | | | 3/8 | .88 | .62 | 1.07 | .06 | 2.96 | Blue | P24 | 7 | 24 | 1 1/8 | 50 |
| LCCX6-38AC-L* | | | | 3/8 | .63 – .88 | .62 | 1.07 | .06 | 2.96 | Blue | P24 | 7 | 24 | 1 1/8 | 50 |
| LCCX6-38D-L | 3/8 | 1.00 | .62 | 1.07 | .06 | 3.08 | Blue | P24 | 7 | 24 | 1 1/8 | 50 | | | |
| LCCX4-14A-L | #4 AWG | #5, #4, #3 AWG | #4 AWG | 1/4 | .63 | .55 | 1.05 | .09 | 2.49 | Gray | P29 | 8 | 29 | 1 1/8 | 50 |
| LCCX4-14B-L | | | | 1/4 | .75 | .55 | 1.05 | .09 | 2.63 | Gray | P29 | 8 | 29 | 1 1/8 | 50 |
| LCCX4-14AB-L* | | | | 1/4 | .63 – .75 | .55 | 1.05 | .09 | 2.63 | Gray | P29 | 8 | 29 | 1 1/8 | 50 |
| LCCX4-38B-L | | | | 3/8 | .75 | .62 | 1.05 | .08 | 2.84 | Gray | P29 | 8 | 29 | 1 1/8 | 50 |
| LCCX4-38D-L | | | | 3/8 | 1.00 | .62 | 1.05 | .08 | 3.09 | Gray | P29 | 8 | 29 | 1 1/8 | 50 |
| LCCX4-38BD-L* | 3/8 | .75 – 1.00 | .62 | 1.05 | .08 | 3.09 | Gray | P29 | 8 | 29 | 1 1/8 | 50 | | | |
| LCCX2-14A-E* | #2 AWG | #2 AWG | #2 AWG | 1/4 | .63 | .70 | 1.36 | .11 | 2.89 | Brown | P33 | 10 | 33 | 1 7/16 | 20 |
| LCCX2-14B-E* | | | | 1/4 | .75 | .70 | 1.36 | .11 | 3.01 | Brown | P33 | 10 | 33 | 1 7/16 | 20 |
| LCCX2-38D-E* | | | | 3/8 | 1.00 | .70 | 1.36 | .11 | 3.46 | Brown | P33 | 10 | 33 | 1 7/16 | 20 |
| LCCX2-12-E* | | | | 1/2 | 1.75 | .75 | 1.36 | .09 | 4.63 | Brown | P33 | 10 | 33 | 1 7/16 | 20 |

‡See pages D3.66 – D3.69 for tool and die information.

*Not UL Listed or CSA Certified with Class K flex conductor when crimped with Burndy tools.

**Consult cable manufacturer for voltage stress relief instructions with applications greater than 2000 V.

^Slotted lug, refer to Figure 2.

Table continues on page D2.92

A. System Overview

B1. Cable Ties

B2. Cable Accessories

B3. Stainless Steel Ties

C1. Wiring Duct

C2. Surface Raceway

C3. Abrasion Protection

C4. Cable Management

D1. Terminals

D2. Power Connectors

D3. Grounding Connectors

E1. Labeling Systems

E2. Labels

E3. Pre-Printed & Write-On Markers

E4. Permanent Identification

E5. Lockout/Tagout & Safety Solutions

F. Index

A.
System
Overview

B1.
Cable Ties

B2.
Cable
Accessories

B3.
Stainless
Steel Ties

C1.
Wiring
Duct

C2.
Surface
Raceway

C3.
Abrasion
Protection

C4.
Cable
Management

D1.
Terminals

D2.
Power
Connectors

D3.
Grounding
Connectors

E1.
Labeling
Systems

E2.
Labels

E3.
Pre-Printed
& Write-On
Markers

E4.
Permanent
Identification

E5.
Lockout/
Tagout
& Safety
Solutions

F.
Index

UL LISTED US SP CERTIFIED Flex Conductor, Two-Hole, Long Barrel with Window Lug (continued)

| Part Number | Flex Conductor Size | | Code Conductor Size | Stud Hole Size (In.) | Stud Hole Spacing (In.) | Figure Dimensions (In.) | | | | PANDUIT Color Code | PANDUIT Die Index No.‡ | Burndy Die Index No. | T&B Die Index No. | Wire Strip Length (In.) | Std. Pkg. Qty. |
|---------------|---------------------|-------------------|---------------------|----------------------|-------------------------|-------------------------|------|-----|------|--------------------|------------------------|----------------------|-------------------|-------------------------|----------------|
| | Class G, H, I, K, M | Diesel Locomotive | | | | W | B | T | L | | | | | | |
| LCCX1-14A-X | #1 AWG | #1 AWG | #1 AWG | 1/4 | .63 | .76 | 1.44 | .12 | 3.07 | Green | P37 | 11 | 37 | 1 1/2 | 10 |
| LCCX1-14B-X | | | | 1/4 | .75 | .76 | 1.44 | .12 | 3.19 | Green | P37 | 11 | 37 | 1 1/2 | 10 |
| LCCX1-14D-X | | | | 1/4 | 1.00 | .76 | 1.44 | .12 | 3.44 | Green | P37 | 11 | 37 | 1 1/2 | 10 |
| LCCX1-56C-X | | | | 5/16 | .88 | .76 | 1.44 | .12 | 3.37 | Green | P37 | 11 | 37 | 1 1/2 | 10 |
| LCCX1-56D-X | | | | 5/16 | 1.00 | .76 | 1.44 | .12 | 3.50 | Green | P37 | 11 | 37 | 1 1/2 | 10 |
| LCCX1-38D-X | | | | 3/8 | 1.00 | .76 | 1.44 | .12 | 3.57 | Green | P37 | 11 | 37 | 1 1/2 | 10 |
| LCCX1/0-14A-X | 1/0 AWG | 1/0 AWG | 1/0 AWG | 1/4 | .63 | .85 | 1.50 | .13 | 3.23 | Pink | P42 | 12 | 42 | 1 9/16 | 10 |
| LCCX1/0-14B-X | | | | 1/4 | .75 | .85 | 1.50 | .13 | 3.36 | Pink | P42 | 12 | 42 | 1 9/16 | 10 |
| LCCX1/0-38D-X | | | | 3/8 | 1.00 | .85 | 1.50 | .13 | 3.67 | Pink | P42 | 12 | 42 | 1 9/16 | 10 |
| LCCX1/0-12-X | | | | 1/2 | 1.75 | .85 | 1.50 | .13 | 4.83 | Pink | P42 | 12 | 42 | 1 9/16 | 10 |
| LCCX2/0-14A-X | 2/0 AWG | 2/0 AWG | 2/0 AWG | 1/4 | .63 | .96 | 1.50 | .13 | 3.27 | Black | P45 | 13 | 45 | 1 9/16 | 10 |
| LCCX2/0-14B-X | | | | 1/4 | .75 | .96 | 1.50 | .13 | 3.39 | Black | P45 | 13 | 45 | 1 9/16 | 10 |
| LCCX2/0-38D-X | | | | 3/8 | 1.00 | .96 | 1.50 | .13 | 3.70 | Black | P45 | 13 | 45 | 1 9/16 | 10 |
| LCCX2/0-12-X | | | | 1/2 | 1.75 | .96 | 1.50 | .13 | 4.87 | Black | P45 | 13 | 45 | 1 9/16 | 10 |
| LCCX3/0-14B-X | 3/0 AWG | 3/0 AWG | 3/0 AWG | 1/4 | .75 | 1.06 | 1.56 | .14 | 3.48 | Orange | P50 | 14 | 50 | 1 5/8 | 10 |
| LCCX3/0-38D-X | | | | 3/8 | 1.00 | 1.06 | 1.56 | .14 | 3.81 | Orange | P50 | 14 | 50 | 1 5/8 | 10 |
| LCCX4/0-14B-X | 4/0 AWG | 4/0 AWG | 4/0 AWG | 1/4 | .75 | 1.19 | 2.24 | .16 | 4.07 | Purple | P54 | 15 | 54 | 2 5/16 | 10 |
| LCCX4/0-38D-X | | | | 3/8 | 1.00 | 1.19 | 2.24 | .16 | 4.55 | Purple | P54 | 15 | 54 | 2 5/16 | 10 |
| LCCX4/0-12-X | | | | 1/2 | 1.75 | 1.19 | 2.24 | .16 | 5.73 | Purple | P54 | 15 | 54 | 2 5/16 | 10 |
| LCCX250-14B-X | 250 kcmil | 262.6 kcmil | — | 1/4 | .75 | 1.28 | 2.24 | .17 | 4.11 | Yellow | P62 | 16 | 62 | 2 5/16 | 10 |
| LCCX250-38D-X | | | | 3/8 | 1.00 | 1.28 | 2.24 | .17 | 4.59 | Yellow | P62 | 16 | 62 | 2 5/16 | 10 |
| LCCX300-38D-6 | 300 kcmil | 313.1 kcmil | — | 3/8 | 1.00 | 1.39 | 2.30 | .18 | 4.67 | Red | P71 | 18 | 71H | 2 3/8 | 6 |
| LCCX350-14B-6 | 350 kcmil | 373.7 kcmil | — | 1/4 | .75 | 1.54 | 2.50 | .22 | 4.47 | Blue | P76 | 19 | 76H | 2 9/16 | 6 |
| LCCX350-38D-6 | | | | 3/8 | 1.00 | 1.54 | 2.50 | .22 | 4.95 | Blue | P76 | 19 | 76H | 2 9/16 | 6 |
| LCCX350-12-6 | | | | 1/2 | 1.75 | 1.54 | 2.50 | .22 | 6.13 | Blue | P76 | 19 | 76H | 2 9/16 | 6 |
| LCCX500-12-6 | 500 kcmil | 535.3 kcmil | — | 1/2 | 1.75 | 1.89 | 2.88 | .26 | 6.66 | Pink | P99 | L99 | 99H | 2 15/16 | 6 |

‡See pages D3.66 – D3.69 for tool and die information.

**Consult cable manufacturer for voltage stress relief instructions with applications greater than 2000 V.

◆NEMA hole sizes and spacing.



Flex Conductor, Two-Hole, Long Barrel with Window Lug, 45° Angle

For Use with Flexible, Extra-Flexible, and Code Stranded Copper Conductors

Type LCCX-H

- Can be used with code conductor and flex conductor class: G, H, I, K, M and Diesel Locomotive
- Long barrel maximizes number of crimps and provides premium wire pull-out strength and electrical performance
- Generously beveled wire entry prevents bent back strands when inserting conductor into barrel
- Color-coded barrels marked with *PANDUIT* and specified competitor die index numbers for proper crimp die selection
- Inspection window to visually assure full conductor insertion
- Tin-plated to inhibit corrosion
- UL Listed and CSA Certified to 35 KV** and temperature rated to 90°C when crimped with *PANDUIT* and specified competitor crimping tools and dies
- Meets J-STD-607-A and TIA-942 requirements for network systems grounding applications
- Available with NEMA hole sizes and spacing

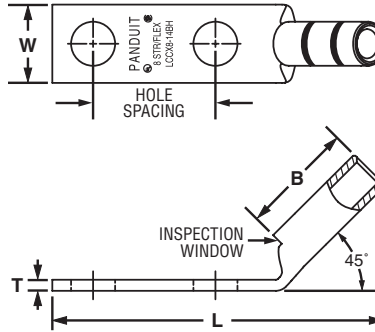

| Part Number | Flex Conductor Size | | Code Conductor Size | Stud Hole Size (In.) | Stud Hole Spacing (In.) | Figure Dimensions (In.) | | | | PANDUIT Color Code | PANDUIT Die Index No.‡ | Burndy Die Index No.‡ | T&B Die Index No.‡ | Wire Strip Length (In.) | Std. Pkg. Qty. |
|---------------|---------------------|-------------------|---------------------|----------------------|-------------------------|-------------------------|------|-----|------|--------------------|------------------------|-----------------------|--------------------|-------------------------|----------------|
| | Class G, H, I, K, M | Diesel Locomotive | | | | W | B | T | L | | | | | | |
| LCCX8-10AH-L | #8 AWG | #8 AWG | #8 AWG | #10 | .63 | .41 | .70 | .08 | 1.82 | Red | P21 | 49 | 21 | 3/4 | 50 |
| LCCX8-10BH-L | | | | #10 | .75 | .41 | .70 | .08 | 1.95 | Red | P21 | 49 | 21 | 3/4 | 50 |
| LCCX8-14AH-L | | | | 1/4 | .63 | .48 | .70 | .07 | 1.91 | Red | P21 | 49 | 21 | 3/4 | 50 |
| LCCX8-14BH-L | | | | 1/4 | .75 | .48 | .70 | .07 | 2.03 | Red | P21 | 49 | 21 | 3/4 | 50 |
| LCCX8-14DH-L | | | | 1/4 | 1.00 | .48 | .70 | .07 | 2.28 | Red | P21 | 49 | 21 | 3/4 | 50 |
| LCCX8-38DH-L | | | | 3/8 | 1.00 | .60 | .70 | .05 | 2.49 | Red | P21 | 49 | 21 | 3/4 | 50 |
| LCCX6-10BH-L | #6 AWG | #6 AWG | #6 AWG | #10 | .75 | .46 | 1.07 | .08 | 2.22 | Blue | P24 | 7 | 24 | 1 1/8 | 50 |
| LCCX6-14AH-L | | | | 1/4 | .63 | .48 | 1.07 | .08 | 2.18 | Blue | P24 | 7 | 24 | 1 1/8 | 50 |
| LCCX6-14BH-L | | | | 1/4 | .75 | .48 | 1.07 | .08 | 2.31 | Blue | P24 | 7 | 24 | 1 1/8 | 50 |
| LCCX6-14DH-L | | | | 1/4 | 1.00 | .48 | 1.07 | .08 | 2.56 | Blue | P24 | 7 | 24 | 1 1/8 | 50 |
| LCCX6-38AH-L | | | | 3/8 | .63 | .62 | 1.07 | .06 | 2.39 | Blue | P24 | 7 | 24 | 1 1/8 | 50 |
| LCCX6-38CH-L | | | | 3/8 | .88 | .62 | 1.07 | .06 | 2.64 | Blue | P24 | 7 | 24 | 1 1/8 | 50 |
| LCCX6-38DH-L | 3/8 | 1.00 | .62 | 1.07 | .06 | 2.77 | Blue | P24 | 7 | 24 | 1 1/8 | 50 | | | |
| LCCX4-14AH-L | #4 AWG | #5, #4, #3 AWG | #4 AWG | 1/4 | .63 | .55 | 1.05 | .09 | 2.20 | Gray | P29 | 8 | 29 | 1 1/8 | 50 |
| LCCX4-14BH-L | | | | 1/4 | .75 | .55 | 1.05 | .09 | 2.32 | Gray | P29 | 8 | 29 | 1 1/8 | 50 |
| LCCX4-38BH-L | | | | 3/8 | .75 | .62 | 1.05 | .08 | 2.54 | Gray | P29 | 8 | 29 | 1 1/8 | 50 |
| LCCX4-38DH-L | | | | 3/8 | 1.00 | .62 | 1.05 | .08 | 2.79 | Gray | P29 | 8 | 29 | 1 1/8 | 20 |
| LCCX2-14AH-E* | #2 AWG | #2 AWG | #2 AWG | 1/4 | .63 | .70 | 1.36 | .11 | 2.46 | Brown | P33 | 10 | 33 | 1 7/16 | 20 |
| LCCX2-14BH-E* | | | | 1/4 | .75 | .70 | 1.36 | .11 | 2.58 | Brown | P33 | 10 | 33 | 1 7/16 | 20 |
| LCCX2-38DH-E* | | | | 3/8 | 1.00 | .70 | 1.36 | .11 | 3.04 | Brown | P33 | 10 | 33 | 1 7/16 | 20 |
| LCCX2-12H-E* | | | | 1/2 | 1.75 | .75 | 1.36 | .09 | 4.20 | Brown | P33 | 10 | 33 | 1 7/16 | 10 |
| LCCX1-14AH-X | #1 AWG | #1 AWG | #1 AWG | 1/4 | .63 | .76 | 1.44 | .12 | 2.61 | Green | P37 | 11 | 37 | 1 1/2 | 10 |
| LCCX1-14BH-X | | | | 1/4 | .75 | .76 | 1.44 | .12 | 2.73 | Green | P37 | 11 | 37 | 1 1/2 | 10 |
| LCCX1-14DH-X | | | | 1/4 | 1.00 | .76 | 1.44 | .12 | 2.98 | Green | P37 | 11 | 37 | 1 1/2 | 10 |
| LCCX1-56CH-X | | | | 5/16 | .88 | .76 | 1.44 | .12 | 2.91 | Green | P37 | 11 | 37 | 1 1/2 | 10 |
| LCCX1-56DH-X | | | | 5/16 | 1.00 | .76 | 1.44 | .12 | 3.04 | Green | P37 | 11 | 37 | 1 1/2 | 10 |
| LCCX1-38DH-X | | | | 3/8 | 1.00 | .76 | 1.44 | .12 | 3.11 | Green | P37 | 11 | 37 | 1 1/2 | 10 |

‡See pages D3.66 – D3.69 for tool and die information.

*Not UL Listed or CSA Certified with Class K flex conductor when crimped with Burndy tools.

**Consult cable manufacturer for voltage stress relief instructions with applications greater than 2000 V.

Table continues on page D2.94

A. System Overview

B1. Cable Ties

B2. Cable Accessories

B3. Stainless Steel Ties

C1. Wiring Duct

C2. Surface Raceway

C3. Abrasion Protection

C4. Cable Management

D1. Terminals

D2. Power Connectors

D3. Grounding Connectors

E1. Labeling Systems

E2. Labels

E3. Pre-Printed & Write-On Markers

E4. Permanent Identification

E5. Lockout/Tagout & Safety Solutions

F. Index

A.
System
Overview

B1.
Cable Ties

B2.
Cable
Accessories

B3.
Stainless
Steel Ties

C1.
Wiring
Duct

C2.
Surface
Raceway

C3.
Abrasion
Protection

C4.
Cable
Management

D1.
Terminals

D2.
Power
Connectors

D3.
Grounding
Connectors

E1.
Labeling
Systems

E2.
Labels

E3.
Pre-Printed
& Write-On
Markers

E4.
Permanent
Identification

E5.
Lockout/
Tagout
& Safety
Solutions

F.
Index



Flex Conductor, Two-Hole, Long Barrel with Window Lug, 45° Angle (continued)

| Part Number | Flex Conductor Size | | Code Conductor Size | Stud Hole Size (In.) | Stud Hole Spacing (In.) | Figure Dimensions (In.) | | | | PANDUIT Color Code | PANDUIT Die Index No.‡ | Burndy Die Index No.‡ | T&B Die Index No.‡ | Wire Strip Length (In.) | Std. Pkg. Qty. |
|----------------|------------------------|----------------------|---------------------------|-------------------------------|----------------------------------|----------------------------|------|-----|------|--------------------------|------------------------------|--------------------------------|-----------------------------|----------------------------------|----------------------|
| | Class G, H, I, K, M | Diesel Locomotive | | | | W | B | T | L | | | | | | |
| LCCX1/0-14AH-X | 1/0 AWG | 1/0 AWG | 1/0 AWG | 1/4 | .63 | .85 | 1.50 | .13 | 2.76 | Pink | P42 | 12 | 42 | 1 9/16 | 10 |
| LCCX1/0-14BH-X | | | | 1/4 | .75 | .85 | 1.50 | .13 | 2.88 | Pink | P42 | 12 | 42 | 1 9/16 | 10 |
| LCCX1/0-38DH-X | | | | 3/8 | 1.00 | .85 | 1.50 | .13 | 3.20 | Pink | P42 | 12 | 42 | 1 9/16 | 10 |
| LCCX1/0-12H-X | | | | 1/2 | 1.75 | .85 | 1.50 | .13 | 4.36 | Pink | P42 | 12 | 42 | 1 9/16 | 10 |
| LCCX2/0-14AH-X | 2/0 AWG | 2/0 AWG | 2/0 AWG | 1/4 | .63 | .96 | 1.50 | .13 | 2.78 | Black | P45 | 13 | 45 | 1 9/16 | 10 |
| LCCX2/0-14BH-X | | | | 1/4 | .75 | .96 | 1.50 | .13 | 2.91 | Black | P45 | 13 | 45 | 1 9/16 | 10 |
| LCCX2/0-38DH-X | | | | 3/8 | 1.00 | .96 | 1.50 | .13 | 3.22 | Black | P45 | 13 | 45 | 1 9/16 | 10 |
| LCCX2/0-12H-X | | | | 1/2 | 1.75 | .96 | 1.50 | .13 | 4.38 | Black | P45 | 13 | 45 | 1 9/16 | 10 |
| LCCX3/0-14BH-X | 3/0 AWG | 3/0 AWG | 3/0 AWG | 1/4 | .75 | 1.06 | 1.56 | .14 | 2.98 | Orange | P50 | 14 | 50 | 1 5/8 | 10 |
| LCCX3/0-38DH-X | | | | 3/8 | 1.00 | 1.06 | 1.56 | .14 | 3.31 | Orange | P50 | 14 | 50 | 1 5/8 | 10 |
| LCCX4/0-14BH-X | 4/0 AWG | 4/0 AWG | 4/0 AWG | 1/4 | .75 | 1.19 | 2.24 | .16 | 3.45 | Purple | P54 | 15 | 54 | 2 5/16 | 10 |
| LCCX4/0-38DH-X | | | | 3/8 | 1.00 | 1.19 | 2.24 | .16 | 3.93 | Purple | P54 | 15 | 54 | 2 5/16 | 10 |
| LCCX4/0-12H-X | | | | 1/2 | 1.75 | 1.19 | 2.24 | .16 | 5.11 | Purple | P54 | 15 | 54 | 2 5/16 | 10 |
| LCCX250-14BH-X | 250 kcmil | 262.6 kcmil | — | 1/4 | .75 | 1.28 | 2.24 | .17 | 3.48 | Yellow | P62 | 16 | 62 | 2 5/16 | 10 |
| LCCX250-38DH-X | | | | 3/8 | 1.00 | 1.28 | 2.24 | .17 | 3.96 | Yellow | P62 | 16 | 62 | 2 5/16 | 6 |
| LCCX300-38DH-6 | 300 kcmil | 313.1 kcmil | — | 3/8 | 1.00 | 1.39 | 2.30 | .18 | 4.07 | Red | P71 | 18 | 71H | 2 3/8 | 6 |
| LCCX350-14BH-6 | 350 kcmil | 373.7 kcmil | — | 1/4 | .75 | 1.54 | 2.50 | .22 | 3.81 | Blue | P76 | 19 | 76H | 2 9/16 | 6 |
| LCCX350-38DH-6 | | | | 3/8 | 1.00 | 1.54 | 2.50 | .22 | 4.29 | Blue | P76 | 19 | 76H | 2 9/16 | 6 |
| LCCX350-12H-6 | | | | 1/2 | 1.75 | 1.54 | 2.50 | .22 | 5.47 | Blue | P76 | 19 | 76H | 2 9/16 | 6 |

‡See pages D3.66 – D3.69 for tool and die information.

**Consult cable manufacturer for voltage stress relief instructions with applications greater than 2000 V.

◆NEMA hole sizes and spacing.



Flex Conductor, Two-Hole, Long Barrel with Window Lug, 90° Angle

For Use with Flexible, Extra-Flexible, and Code Stranded Copper Conductors

Type LCCX-F

- Can be used with code conductor and flex conductor class: G, H, I, K, M and Diesel Locomotive
- Long barrel maximizes number of crimps and provides premium wire pull-out strength and electrical performance
- Generously beveled wire entry prevents bent back strands when inserting conductor into barrel
- Color-coded barrels marked with *PANDUIT* and specified competitor die index numbers for proper crimp die selection
- Inspection window to visually assure full conductor insertion
- Tin-plated to inhibit corrosion
- UL Listed and CSA Certified to 35 KV** and temperature rated to 90°C when crimped with *PANDUIT* and specified competitor crimping tools and dies
- Meets J-STD-607-A and TIA-942 requirements for network systems grounding applications
- Available with NEMA hole sizes and spacing

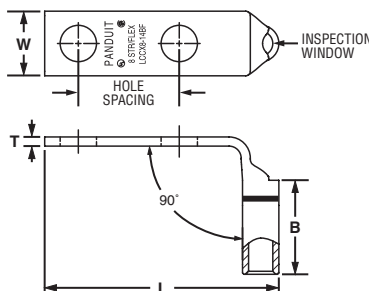

| Part Number | Flex Conductor Size | | Code Conductor Size | Stud Hole Size (In.) | Stud Hole Spacing (In.) | Figure Dimensions (In.) | | | | PANDUIT Color Code | PANDUIT Die Index No.‡ | Burndy Die Index No. | T&B Die Index No. | Wire Strip Length (In.) | Std. Pkg. Qty. |
|----------------|---------------------|-------------------|---------------------|----------------------|-------------------------|-------------------------|-------|-----|------|--------------------|------------------------|----------------------|-------------------|-------------------------|----------------|
| | Class G, H, I, K, M | Diesel Locomotive | | | | W | B | T | L | | | | | | |
| LCCX8-10AF-L | #8 AWG | #8 AWG | #8 AWG | #10 | .63 | .41 | .70 | .08 | 1.53 | Red | P21 | 49 | 21 | 3/4 | 50 |
| LCCX8-10BF-L | | | | #10 | .75 | .41 | .70 | .08 | 1.65 | Red | P21 | 49 | 21 | 3/4 | 50 |
| LCCX8-14AF-L | | | | 1/4 | .63 | .48 | .70 | .07 | 1.62 | Red | P21 | 49 | 21 | 3/4 | 50 |
| LCCX8-14BF-L | | | | 1/4 | .75 | .48 | .70 | .07 | 1.74 | Red | P21 | 49 | 21 | 3/4 | 50 |
| LCCX8-14DF-L | | | | 1/4 | 1.00 | .48 | .70 | .07 | 1.99 | Red | P21 | 49 | 21 | 3/4 | 50 |
| LCCX8-38DF-L | | | | 3/8 | 1.00 | .60 | .70 | .05 | 2.21 | Red | P21 | 49 | 21 | 3/4 | 50 |
| LCCX6-10BF-L | #6 AWG | #6 AWG | #6 AWG | #10 | .75 | .46 | 1.07 | .08 | 1.69 | Blue | P24 | 7 | 24 | 1 1/8 | 50 |
| LCCX6-14AF-L | | | | 1/4 | .63 | .48 | 1.07 | .08 | 1.66 | Blue | P24 | 7 | 24 | 1 1/8 | 50 |
| LCCX6-14BF-L | | | | 1/4 | .75 | .48 | 1.07 | .08 | 1.78 | Blue | P24 | 7 | 24 | 1 1/8 | 50 |
| LCCX6-14DF-L | | | | 1/4 | 1.00 | .48 | 1.07 | .08 | 2.03 | Blue | P24 | 7 | 24 | 1 1/8 | 50 |
| LCCX6-38AF-L | | | | 3/8 | .63 | .62 | 1.07 | .06 | 1.88 | Blue | P24 | 7 | 24 | 1 1/8 | 50 |
| LCCX6-38CF-L | | | | 3/8 | .88 | .62 | 1.07 | .06 | 2.13 | Blue | P24 | 7 | 24 | 1 1/8 | 50 |
| LCCX6-38DF-L | 3/8 | 1.00 | .62 | 1.07 | .06 | 2.25 | Blue | P24 | 7 | 24 | 1 1/8 | 50 | | | |
| LCCX4-14AF-L | #4 AWG | #5, #4, #3 AWG | #4 AWG | 1/4 | .63 | .55 | 1.05 | .09 | 1.74 | Gray | P29 | 8 | 29 | 1 1/8 | 50 |
| LCCX4-14BF-L | | | | 1/4 | .75 | .55 | 1.05 | .09 | 1.87 | Gray | P29 | 8 | 29 | 1 1/8 | 50 |
| LCCX4-38BF-L | | | | 3/8 | .75 | .62 | 1.05 | .08 | 2.09 | Gray | P29 | 8 | 29 | 1 1/8 | 50 |
| LCCX4-38DF-L | | | | 3/8 | 1.00 | .62 | 1.05 | .08 | 2.34 | Gray | P29 | 8 | 29 | 1 1/8 | 50 |
| LCCX2-14AF-E* | #2 AWG | #2 AWG | #2 AWG | 1/4 | .63 | .70 | 1.36 | .11 | 1.94 | Brown | P33 | 10 | 33 | 1 7/16 | 20 |
| LCCX2-14BF-E* | | | | 1/4 | .75 | .70 | 1.36 | .11 | 2.06 | Brown | P33 | 10 | 33 | 1 7/16 | 20 |
| LCCX2-38DF-E* | | | | 3/8 | 1.00 | .70 | 1.36 | .11 | 2.51 | Brown | P33 | 10 | 33 | 1 7/16 | 20 |
| LCCX2-12F-E* | 1/2 | 1.75 | .75 | 1.36 | .09 | 3.68 | Brown | P33 | 10 | 33 | 1 7/16 | 20 | | | |
| LCCX1-14AF-X | #1 AWG | #1 AWG | #1 AWG | 1/4 | .63 | .76 | 1.44 | .12 | 2.08 | Green | P37 | 11 | 37 | 1 1/2 | 10 |
| LCCX1-14BF-X | | | | 1/4 | .75 | .76 | 1.44 | .12 | 2.20 | Green | P37 | 11 | 37 | 1 1/2 | 10 |
| LCCX1-14DF-X | | | | 1/4 | 1.00 | .76 | 1.44 | .12 | 2.45 | Green | P37 | 11 | 37 | 1 1/2 | 10 |
| LCCX1-56CF-X | | | | 5/16 | .88 | .76 | 1.44 | .12 | 2.38 | Green | P37 | 11 | 37 | 1 1/2 | 10 |
| LCCX1-56DF-X | | | | 5/16 | 1.00 | .76 | 1.44 | .12 | 2.51 | Green | P37 | 11 | 37 | 1 1/2 | 10 |
| LCCX1-38DF-X | 3/8 | 1.00 | .76 | 1.44 | .12 | 2.58 | Green | P37 | 11 | 37 | 1 1/2 | 10 | | | |
| LCCX1/0-14AF-X | 1/0 AWG | 1/0 AWG | 1/0 AWG | 1/4 | .63 | .85 | 1.50 | .13 | 2.22 | Pink | P42 | 12 | 42 | 1 9/16 | 10 |
| LCCX1/0-14BF-X | | | | 1/4 | .75 | .85 | 1.50 | .13 | 2.34 | Pink | P42 | 12 | 42 | 1 9/16 | 10 |
| LCCX1/0-38DF-X | | | | 3/8 | 1.00 | .85 | 1.50 | .13 | 2.66 | Pink | P42 | 12 | 42 | 1 9/16 | 10 |
| LCCX1/0-12F-X | 1/2 | 1.75 | .85 | 1.50 | .13 | 3.82 | Pink | P42 | 12 | 42 | 1 9/16 | 10 | | | |

‡See pages D3.66 – D3.69 for tool and die information.

*Not UL Listed or CSA Certified with Class K flex conductor when crimped with Burndy tools.

**Consult cable manufacturer for voltage stress relief instructions with applications greater than 2000 V.

Table continues on page D2.96

A. System Overview

B1. Cable Ties

B2. Cable Accessories

B3. Stainless Steel Ties

C1. Wiring Duct

C2. Surface Raceway

C3. Abrasion Protection

C4. Cable Management

D1. Terminals

D2. Power Connectors

D3. Grounding Connectors

E1. Labeling Systems

E2. Labels

E3. Pre-Printed & Write-On Markers

E4. Permanent Identification

E5. Lockout/Tagout & Safety Solutions

F. Index

A.
System
Overview

B1.
Cable Ties

B2.
Cable
Accessories

B3.
Stainless
Steel Ties

C1.
Wiring
Duct

C2.
Surface
Raceway

C3.
Abrasion
Protection

C4.
Cable
Management

D1.
Terminals

D2.
Power
Connectors

D3.
Grounding
Connectors

E1.
Labeling
Systems

E2.
Labels

E3.
Pre-Printed
& Write-On
Markers

E4.
Permanent
Identification

E5.
Lockout/
Tagout
& Safety
Solutions

F.
Index

  **Flex Conductor, Two-Hole, Long Barrel with Window Lug, 90° Angle (continued)**

| Part Number | Flex Conductor Size | | Code Conductor Size | Stud Hole Size (In.) | Stud Hole Spacing (In.) | Figure Dimensions (In.) | | | | PANDUIT Color Code | PANDUIT Die Index No.‡ | Burndy Die Index No. | T&B Die Index No. | Wire Strip Length (In.) | Std. Pkg. Qty. |
|----------------|------------------------|----------------------|---------------------------|-------------------------------|----------------------------------|----------------------------|------|-----|------|--------------------------|------------------------------|-------------------------------|----------------------------|----------------------------------|----------------------|
| | Class G, H, I, K, M | Diesel Locomotive | | | | W | B | T | L | | | | | | |
| LCCX2/0-14AF-X | 2/0 AWG | 2/0 AWG | 2/0 AWG | 1/4 | .63 | .96 | 1.50 | .13 | 2.29 | Black | P45 | 13 | 45 | 1 9/16 | 10 |
| LCCX2/0-14BF-X | | | | 1/4 | .75 | .96 | 1.50 | .13 | 2.42 | Black | P45 | 13 | 45 | 1 9/16 | 10 |
| LCCX2/0-38DF-X | | | | 3/8 | 1.00 | .96 | 1.50 | .13 | 2.73 | Black | P45 | 13 | 45 | 1 9/16 | 10 |
| LCCX2/0-12F-X | | | | 1/2 | 1.75 | .96 | 1.50 | .13 | 3.89 | Black | P45 | 13 | 45 | 1 9/16 | 10 |
| LCCX3/0-14BF-X | 3/0 AWG | 3/0 AWG | 3/0 AWG | 1/4 | .75 | 1.06 | 1.56 | .14 | 2.50 | Orange | P50 | 14 | 50 | 1 5/8 | 10 |
| LCCX3/0-38DF-X | | | | 3/8 | 1.00 | 1.06 | 1.56 | .14 | 2.84 | Orange | P50 | 14 | 50 | 1 5/8 | 10 |
| LCCX4/0-14BF-X | 4/0 AWG | 4/0 AWG | 4/0 AWG | 1/4 | .75 | 1.19 | 2.24 | .16 | 2.69 | Purple | P54 | 15 | 54 | 2 5/16 | 10 |
| LCCX4/0-38DF-X | | | | 3/8 | 1.00 | 1.19 | 2.24 | .16 | 2.88 | Purple | P54 | 15 | 54 | 2 5/16 | 10 |
| LCCX4/0-12F-X | | | | 1/2 | 1.75 | 1.19 | 2.24 | .16 | 4.06 | Purple | P54 | 15 | 54 | 2 5/16 | 10 |
| LCCX250-14BF-X | 250 kcmil | 262.6 kcmil | — | 1/4 | .75 | 1.28 | 2.24 | .17 | 2.46 | Yellow | P62 | 16 | 62 | 2 5/16 | 10 |
| LCCX250-38DF-X | | | | 3/8 | 1.00 | 1.28 | 2.24 | .17 | 2.94 | Yellow | P62 | 16 | 62 | 2 5/16 | 10 |
| LCCX300-38DF-6 | 300 kcmil | 313.1 kcmil | — | 3/8 | 1.00 | 1.39 | 2.30 | .18 | 3.02 | Red | P71 | 18 | 71H | 2 3/8 | 6 |
| LCCX350-14BF-6 | 350 kcmil | 373.7 kcmil | — | 1/4 | .75 | 1.54 | 2.50 | .22 | 2.65 | Blue | P76 | 19 | 76H | 2 9/16 | 6 |
| LCCX350-38DF-6 | | | | 3/8 | 1.00 | 1.54 | 2.50 | .22 | 3.13 | Blue | P76 | 19 | 76H | 2 9/16 | 6 |
| LCCX350-12F-6 | | | | 1/2 | 1.75 | 1.54 | 2.50 | .22 | 4.31 | Blue | P76 | 19 | 76H | 2 9/16 | 6 |

‡See pages D3.66 – D3.69 for tool and die information.

**Consult cable manufacturer for voltage stress relief instructions with applications greater than 2000 V.

◆NEMA hole sizes and spacing.

UL LISTED Flex Conductor, Two-Hole, Long Barrel, Flared NEBS Lug

For Use with Flexible and Extra-Flexible Copper Conductors

Type LCCF

- Can be used with flex conductor class: K, M, and Diesel Locomotive
- Long barrel maximizes the number of crimps and provides premium wire pull-out strength and electrical performance
- Flared entry prevents bent back strands when inserting fine strand conductor into barrel
- Color-coded barrels marked with *PANDUIT* die index numbers for proper crimp die selection
- Enclosed barrel prevents corrosive material from entering barrel when used in harsh environments
- Tin-plated to inhibit corrosion
- UL Listed and CSA Certified to 35 KV** and temperature rated to 90°C when crimped with *PANDUIT* crimping tools and dies
- **Tested by Telcordia – meets NEBS Level 3**
- Available with NEMA hole sizes and spacing

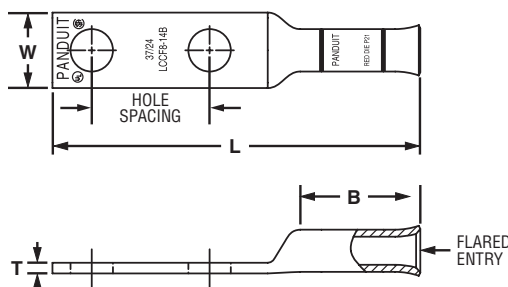

| Part Number | Flex Conductor Size | | Stud Hole Size (In.) | Stud Hole Spacing (In.) | Figure Dimensions (In.) | | | | PANDUIT Color Code | PANDUIT Die Index No.‡ | Wire Strip Length (In.) | Std. Pkg. Qty. |
|-------------|---------------------|-------------------|----------------------|-------------------------|-------------------------|------|-----|------|--------------------|------------------------|-------------------------|----------------|
| | Class K and M | Diesel Locomotive | | | W | B | T | L | | | | |
| LCCF8-14A-L | — | #8 AWG | 1/4 | .63 | .48 | .76 | .07 | 2.22 | Red | P21 | 13/16 | 50 |
| LCCF8-14B-L | | | 1/4 | .75 | .48 | .76 | .07 | 2.34 | Red | P21 | 13/16 | 50 |
| LCCF8-38D-L | | | 3/8 | 1.00 | .60 | .76 | .05 | 2.81 | Red | P21 | 13/16 | 50 |
| LCCF6-14A-L | #6 AWG | #6 AWG | 1/4 | .63 | .48 | 1.22 | .08 | 2.71 | Blue | P24 | 1 5/16 | 50 |
| LCCF6-14B-L | | | 1/4 | .75 | .48 | 1.22 | .08 | 2.83 | Blue | P24 | 1 5/16 | 50 |
| LCCF6-38D-L | | | 3/8 | 1.00 | .62 | 1.22 | .06 | 3.30 | Blue | P24 | 1 5/16 | 50 |
| LCCF4-14A-L | #4 AWG | #4 AWG | 1/4 | .63 | .55 | 1.23 | .09 | 2.75 | Gray | P29 | 1 5/16 | 50 |
| LCCF4-14B-L | | | 1/4 | .75 | .55 | 1.23 | .09 | 2.88 | Gray | P29 | 1 5/16 | 50 |
| LCCF4-38D-L | | | 3/8 | 1.00 | .62 | 1.23 | .08 | 3.35 | Gray | P29 | 1 5/16 | 50 |
| LCCF2-14A-E | #2 AWG | #2 AWG | 1/4 | .63 | .70 | 1.36 | .11 | 3.00 | Brown | P33 | 1 7/16 | 20 |
| LCCF2-14B-E | | | 1/4 | .75 | .70 | 1.36 | .11 | 3.12 | Brown | P33 | 1 7/16 | 20 |
| LCCF2-56B-E | | | 5/16 | .75 | .70 | 1.36 | .11 | 3.25 | Brown | P33 | 1 7/16 | 20 |
| LCCF2-38D-E | | | 3/8 | 1.00 | .70 | 1.36 | .11 | 3.57 | Brown | P33 | 1 7/16 | 20 |
| LCCF2-12-E | | | 1/2 | 1.75 | .75 | 1.36 | .09 | 4.74 | Brown | P33 | 1 7/16 | 20 |
| LCCF1-14A-X | #1 AWG | #1 AWG | 1/4 | .63 | .76 | 1.44 | .12 | 3.18 | Pink | P42 | 1 1/2 | 10 |
| LCCF1-14B-X | | | 1/4 | .75 | .76 | 1.44 | .12 | 3.31 | Pink | P42 | 1 1/2 | 10 |
| LCCF1-56C-X | | | 5/16 | .88 | .76 | 1.44 | .12 | 3.49 | Pink | P42 | 1 1/2 | 10 |
| LCCF1-38D-X | | | 3/8 | 1.00 | .76 | 1.44 | .12 | 3.69 | Pink | P42 | 1 1/2 | 10 |
| LCCF1-12-X | | | 1/2 | 1.75 | .80 | 1.44 | .12 | 4.86 | Pink | P42 | 1 1/2 | 10 |

‡See pages D3.70, D3.71 for tool and die information.

**Consult cable manufacturer for voltage stress relief instructions with applications greater than 2000 V.

◆NEMA hole sizes and spacing.

Table continues on page D2.98

A. System Overview

B1. Cable Ties

B2. Cable Accessories

B3. Stainless Steel Ties

C1. Wiring Duct

C2. Surface Raceway

C3. Abrasion Protection

C4. Cable Management

D1. Terminals

D2. Power Connectors

D3. Grounding Connectors

E1. Labeling Systems

E2. Labels

E3. Pre-Printed & Write-On Markers

E4. Permanent Identification

E5. Lockout/Tagout & Safety Solutions

F. Index

A. System Overview

B1. Cable Ties

B2. Cable Accessories

B3. Stainless Steel Ties

C1. Wiring Duct

C2. Surface Raceway

C3. Abrasion Protection

C4. Cable Management

D1. Terminals

D2. Power Connectors

D3. Grounding Connectors

E1. Labeling Systems

E2. Labels

E3. Pre-Printed & Write-On Markers

E4. Permanent Identification

E5. Lockout/Tagout & Safety Solutions

F. Index



Flex Conductor, Two-Hole, Long Barrel, Flared NEBS Lug (continued)

| Part Number | Flex Conductor Size | | Stud Hole Size (In.) | Stud Hole Spacing (In.) | Figure Dimensions (In.) | | | | PANDUIT Color Code | PANDUIT Die Index No.‡ | Wire Strip Length (In.) | Std. Pkg. Qty. | | |
|----------------------|---------------------|-------------------|----------------------|-------------------------|-------------------------|------|------|------|--------------------|------------------------|-------------------------|----------------|--------|---|
| | Class K and M | Diesel Locomotive | | | W | B | T | L | | | | | | |
| LCCF1/0-14A-X | 1/0 AWG | 1/0 AWG | 1/4 | .63 | .85 | 1.50 | .13 | 3.38 | Black | P45 | 1 9/16 | 10 | | |
| LCCF1/0-14B-X | | | 1/4 | .75 | .85 | 1.50 | .13 | 3.51 | Black | P45 | 1 9/16 | 10 | | |
| LCCF1/0-56C-X | | | 5/16 | .88 | .85 | 1.50 | .13 | 3.63 | Black | P45 | 1 9/16 | 10 | | |
| LCCF1/0-38D-X | | | 3/8 | 1.00 | .85 | 1.50 | .13 | 3.82 | Black | P45 | 1 9/16 | 10 | | |
| LCCF1/0-12-X | 2/0 AWG | 2/0 AWG | 1/2 | 1.75 | .85 | 1.50 | .13 | 4.98 | Black | P45 | 1 9/16 | 10 | | |
| LCCF2/0-14A-X | | | 1/4 | .63 | .96 | 1.50 | .13 | 3.43 | Orange | P50 | 1 9/16 | 10 | | |
| LCCF2/0-14B-X | | | 1/4 | .75 | .96 | 1.50 | .13 | 3.56 | Orange | P50 | 1 9/16 | 10 | | |
| LCCF2/0-38D-X | | | 3/8 | 1.00 | .96 | 1.50 | .13 | 3.87 | Orange | P50 | 1 9/16 | 10 | | |
| LCCF2/0-12-X | 3/0 AWG | 3/0 AWG | 1/2 | 1.75 | .96 | 1.50 | .13 | 5.03 | Orange | P50 | 1 9/16 | 10 | | |
| LCCF3/0-14B-X | | | 1/4 | .75 | 1.06 | 1.56 | .14 | 3.66 | Purple | P54 | 1 5/8 | 10 | | |
| LCCF3/0-38D-X | | | 3/8 | 1.00 | 1.06 | 1.56 | .14 | 3.99 | Purple | P54 | 1 5/8 | 10 | | |
| LCCF3/0-12-X | | | 1/2 | 1.75 | 1.06 | 1.56 | .14 | 5.13 | Purple | P54 | 1 5/8 | 10 | | |
| LCCF4/0-14B-X | 4/0 AWG | 4/0 AWG | 1/4 | .75 | 1.17 | 1.61 | .14 | 3.60 | Yellow | P62 | 1 11/16 | 10 | | |
| LCCF4/0-38D-X | | | 3/8 | 1.00 | 1.17 | 1.61 | .14 | 4.09 | Yellow | P62 | 1 11/16 | 10 | | |
| LCCF4/0-38-X | | | 3/8 | 1.75 | 1.17 | 1.61 | .14 | 4.84 | Yellow | P62 | 1 11/16 | 10 | | |
| LCCF4/0-12-X | | | 1/2 | 1.75 | 1.17 | 1.61 | .14 | 5.23 | Yellow | P62 | 1 11/16 | 10 | | |
| LCCF250-14B-X | 250 kcmil | 262.6 kcmil | 1/4 | .75 | 1.28 | 2.24 | .17 | 4.33 | White | P66 | 2 5/16 | 10 | | |
| LCCF250-38D-X | | | 3/8 | 1.00 | 1.28 | 2.24 | .17 | 4.81 | White | P66 | 2 5/16 | 10 | | |
| LCCF250-12E-X | | | 1/2 | 1.25 | 1.28 | 2.24 | .17 | 5.49 | White | P66 | 2 5/16 | 10 | | |
| LCCF250-12-X | | | 1/2 | 1.75 | 1.28 | 2.24 | .17 | 5.99 | White | P66 | 2 5/16 | 10 | | |
| LCCF300-14B-6 | 300 kcmil | 313.1 kcmil | 1/4 | .75 | 1.38 | 2.30 | .18 | 4.44 | Red | P71 | 2 3/8 | 6 | | |
| LCCF300-38D-6 | | | 3/8 | 1.00 | 1.38 | 2.30 | .18 | 4.92 | Red | P71 | 2 3/8 | 6 | | |
| LCCF300-12-6 | | | 1/2 | 1.75 | 1.38 | 2.30 | .18 | 6.10 | Red | P71 | 2 3/8 | 6 | | |
| LCCF350-14B-6 | | | 1/4 | .75 | 1.53 | 2.50 | .22 | 4.70 | Blue | P76 | 2 9/16 | 6 | | |
| LCCF350-38D-6 | 350 kcmil | 373.7 kcmil | 3/8 | 1.00 | 1.53 | 2.50 | .22 | 5.18 | Blue | P76 | 2 9/16 | 6 | | |
| LCCF350-12E-6 | | | 1/2 | 1.25 | 1.53 | 2.50 | .22 | 5.86 | Blue | P76 | 2 9/16 | 6 | | |
| LCCF350-12-6 | | | 1/2 | 1.75 | 1.53 | 2.50 | .22 | 6.36 | Blue | P76 | 2 9/16 | 6 | | |
| LCCF400-38D-6 | | | 3/8 | 1.00 | 1.70 | 2.69 | .26 | 5.45 | Brown | P87 | 2 3/4 | 6 | | |
| LCCF400-12-6 | 400 kcmil | 444.4 kcmil | 1/2 | 1.75 | 1.70 | 2.69 | .26 | 6.63 | Brown | P87 | 2 3/4 | 6 | | |
| LCCF500-12-6 | | | 1/2 | 1.75 | 1.89 | 2.88 | .26 | 7.04 | Pink | P99 | 2 15/16 | 6 | | |
| LCCF600-12-6 | | | — | 646.4 kcmil | 1/2 | 1.75 | 1.95 | 2.94 | .29 | 7.13 | Black | P106 | 3 | 6 |
| LCCF750-38D-3 | | | — | 777.7 kcmil | 3/8 | 1.00 | 2.17 | 3.00 | .32 | 6.35 | Orange | P107 | 3 1/16 | 3 |
| LCCF750-12-3 | — | 777.7 kcmil | 1/2 | 1.75 | 2.17 | 3.00 | .32 | 7.29 | Orange | P107 | 3 1/16 | 3 | | |

‡See pages D3.70, D3.71 for tool and die information.

**Consult cable manufacturer for voltage stress relief instructions with applications greater than 2000 V.

◆NEMA hole sizes and spacing.



Flex Conductor, Two-Hole, Long Barrel, Flared NEBS Lug, 45° Angle

For Use with Flexible and Extra-Flexible Copper Conductors

Type LCCF-H

- Can be used with flex conductor class: K, M, and Diesel Locomotive
- Long barrel maximizes the number of crimps and provides premium wire pull-out strength and electrical performance
- Flared entry prevents bent back strands when inserting fine strand conductor into barrel
- Color-coded barrels marked with *PANDUIT* die index numbers for proper crimp die selection
- Enclosed barrel prevents corrosive material from entering barrel when used in harsh environments
- Tin-plated to inhibit corrosion
- UL Listed and CSA Certified to 35 KV** and temperature rated to 90°C when crimped with *PANDUIT* crimping tools and dies
- **Tested by Telcordia – meets NEBS Level 3**
- Available with NEMA hole sizes and spacing

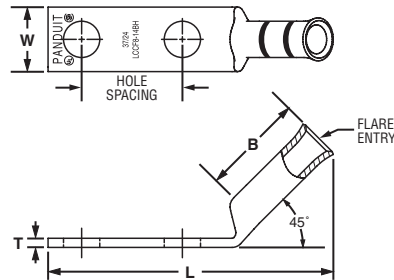

A. System Overview

B1. Cable Ties

B2. Cable Accessories

B3. Stainless Steel Ties

C1. Wiring Duct

C2. Surface Raceway

C3. Abrasion Protection

C4. Cable Management

D1. Terminals

D2. Power Connectors

D3. Grounding Connectors

E1. Labeling Systems

E2. Labels

E3. Pre-Printed & Write-On Markers

E4. Permanent Identification

E5. Lockout/Tagout & Safety Solutions

F. Index

| Part Number | Flex Conductor Size | | Stud Hole Size (In.) | Stud Hole Spacing (In.) | Figure Dimensions (In.) | | | | PANDUIT Color Code | PANDUIT Die Index No.‡ | Wire Strip Length (In.) | Std. Pkg. Qty. |
|----------------|---------------------|-------------------|----------------------|-------------------------|-------------------------|------|-----|------|--------------------|------------------------|-------------------------|----------------|
| | Class K and M | Diesel Locomotive | | | W | B | T | L | | | | |
| LCCF8-14AH-L | — | #8 AWG | 1/4 | .63 | .48 | .76 | .07 | 2.00 | Red | P21 | 13/16 | 50 |
| LCCF8-14BH-L | | | 1/4 | .75 | .48 | .76 | .07 | 2.12 | Red | P21 | 13/16 | 50 |
| LCCF8-38DH-L | | | 3/8 | 1.00 | .60 | .76 | .05 | 2.58 | Red | P21 | 13/16 | 50 |
| LCCF6-14AH-L | #6 AWG | #6 AWG | 1/4 | .63 | .48 | 1.22 | .08 | 2.36 | Blue | P24 | 1 5/16 | 50 |
| LCCF6-14BH-L | | | 1/4 | .75 | .48 | 1.22 | .08 | 2.48 | Blue | P24 | 1 5/16 | 50 |
| LCCF6-38DH-L | | | 3/8 | 1.00 | .62 | 1.22 | .06 | 2.94 | Blue | P24 | 1 5/16 | 50 |
| LCCF4-14AH-L | #4 AWG | #4 AWG | 1/4 | .63 | .55 | 1.23 | .09 | 2.41 | Gray | P29 | 1 5/16 | 50 |
| LCCF4-14BH-L | | | 1/4 | .75 | .55 | 1.23 | .09 | 2.54 | Gray | P29 | 1 5/16 | 50 |
| LCCF4-38DH-L | | | 3/8 | 1.00 | .62 | 1.23 | .08 | 3.00 | Gray | P29 | 1 5/16 | 50 |
| LCCF2-14AH-E | #2 AWG | #2 AWG | 1/4 | .63 | .70 | 1.36 | .11 | 2.56 | Brown | P33 | 1 7/16 | 20 |
| LCCF2-14BH-E | | | 1/4 | .75 | .70 | 1.36 | .11 | 2.68 | Brown | P33 | 1 7/16 | 20 |
| LCCF2-56BH-E | | | 5/16 | .75 | .70 | 1.36 | .11 | 2.81 | Brown | P33 | 1 7/16 | 20 |
| LCCF2-38DH-E | #1 AWG | #1 AWG | 3/8 | 1.00 | .70 | 1.36 | .11 | 3.13 | Brown | P33 | 1 7/16 | 20 |
| LCCF2-12H-E | | | 1/2 | 1.75 | .75 | 1.36 | .09 | 4.30 | Brown | P33 | 1 7/16 | 20 |
| LCCF1-14AH-X | | | 1/4 | .63 | .76 | 1.44 | .12 | 2.71 | Pink | P42 | 1 1/2 | 10 |
| LCCF1-14BH-X | #1 AWG | #1 AWG | 1/4 | .75 | .76 | 1.44 | .12 | 2.84 | Pink | P42 | 1 1/2 | 10 |
| LCCF1-56CH-X | | | 5/16 | .88 | .76 | 1.44 | .12 | 3.02 | Pink | P42 | 1 1/2 | 10 |
| LCCF1-38DH-X | | | 3/8 | 1.00 | .76 | 1.44 | .12 | 3.22 | Pink | P42 | 1 1/2 | 10 |
| LCCF1-12H-X | 1/0 AWG | 1/0 AWG | 1/2 | 1.75 | .80 | 1.44 | .12 | 4.38 | Pink | P42 | 1 1/2 | 10 |
| LCCF1/0-14AH-X | | | 1/4 | .63 | .85 | 1.50 | .13 | 2.90 | Black | P45 | 1 9/16 | 10 |
| LCCF1/0-14BH-X | | | 1/4 | .75 | .85 | 1.50 | .13 | 3.02 | Black | P45 | 1 9/16 | 10 |
| LCCF1/0-56CH-X | 1/0 AWG | 1/0 AWG | 5/16 | .88 | .85 | 1.50 | .13 | 3.15 | Black | P45 | 1 9/16 | 10 |
| LCCF1/0-38DH-X | | | 3/8 | 1.00 | .85 | 1.50 | .13 | 3.34 | Black | P45 | 1 9/16 | 10 |
| LCCF1/0-12H-X | | | 1/2 | 1.75 | .85 | 1.50 | .13 | 4.50 | Black | P45 | 1 9/16 | 10 |
| LCCF2/0-14AH-X | 2/0 AWG | 2/0 AWG | 1/4 | .63 | .96 | 1.50 | .13 | 2.92 | Orange | P50 | 1 9/16 | 10 |
| LCCF2/0-14BH-X | | | 1/4 | .75 | .96 | 1.50 | .13 | 3.05 | Orange | P50 | 1 9/16 | 10 |
| LCCF2/0-38DH-X | | | 3/8 | 1.00 | .96 | 1.50 | .13 | 3.36 | Orange | P50 | 1 9/16 | 10 |
| LCCF2/0-12H-X | 3/0 AWG | 3/0 AWG | 1/2 | 1.75 | .96 | 1.50 | .13 | 4.52 | Orange | P50 | 1 9/16 | 10 |
| LCCF3/0-14BH-X | | | 1/4 | .75 | 1.06 | 1.56 | .14 | 3.14 | Purple | P54 | 1 5/8 | 10 |
| LCCF3/0-38DH-X | | | 3/8 | 1.00 | 1.06 | 1.56 | .14 | 3.47 | Purple | P54 | 1 5/8 | 10 |
| LCCF3/0-12H-X | 3/0 AWG | 3/0 AWG | 1/2 | 1.75 | 1.06 | 1.56 | .14 | 4.61 | Purple | P54 | 1 5/8 | 10 |

‡See pages D3.70, D3.71 for tool and die information.

**Consult cable manufacturer for voltage stress relief instructions with applications greater than 2000 V.

◆NEMA hole sizes and spacing.

Table continues on page D2.100

A.
System
Overview

B1.
Cable Ties

B2.
Cable
Accessories

B3.
Stainless
Steel Ties

C1.
Wiring
Duct

C2.
Surface
Raceway

C3.
Abrasion
Protection

C4.
Cable
Management

D1.
Terminals

D2.
Power
Connectors

D3.
Grounding
Connectors

E1.
Labeling
Systems

E2.
Labels

E3.
Pre-Printed
& Write-On
Markers

E4.
Permanent
Identification

E5.
Lockout/
Tagout
& Safety
Solutions

F.
Index



Flex Conductor, Two-Hole, Long Barrel, Flared NEBS Lug, 45° Angle (continued)

| Part Number | Flex Conductor Size | | Stud Hole Size (In.) | Stud Hole Spacing (In.) | Figure Dimensions (In.) | | | | PANDUIT Color Code | PANDUIT Die Index No.‡ | Wire Strip Length (In.) | Std. Pkg. Qty. |
|-----------------|---------------------|-------------------|----------------------|-------------------------|-------------------------|------|-----|------|--------------------|------------------------|-------------------------|----------------|
| | Class K and M | Diesel Locomotive | | | W | B | T | L | | | | |
| LCCF4/0-14BH-X | 4/0 AWG | 4/0 AWG | 1/4 | .75 | 1.17 | 1.61 | .14 | 3.06 | Yellow | P62 | 1 11/16 | 10 |
| LCCF4/0-38DH-X | | | 3/8 | 1.00 | 1.17 | 1.61 | .14 | 3.55 | Yellow | P62 | 1 11/16 | 10 |
| LCCF4/0-38H-X | | | 3/8 | 1.75 | 1.17 | 1.61 | .14 | 4.30 | Yellow | P62 | 1 11/16 | 10 |
| ◆ LCCF4/0-12H-X | 250 kcmil | 262.6 kcmil | 1/2 | 1.75 | 1.17 | 1.61 | .14 | 4.69 | Yellow | P62 | 1 11/16 | 10 |
| LCCF250-14BH-X | | | 1/4 | .75 | 1.28 | 2.24 | .17 | 3.66 | White | P66 | 2 5/16 | 10 |
| LCCF250-38DH-X | | | 3/8 | 1.00 | 1.28 | 2.24 | .17 | 4.14 | White | P66 | 2 5/16 | 10 |
| LCCF250-12EH-X | 300 kcmil | 313.1 kcmil | 1/2 | 1.25 | 1.28 | 2.24 | .17 | 4.82 | White | P66 | 2 5/16 | 10 |
| ◆ LCCF250-12H-X | | | 1/2 | 1.75 | 1.28 | 2.24 | .17 | 5.32 | White | P66 | 2 5/16 | 10 |
| LCCF300-14BH-6 | | | 1/4 | .75 | 1.38 | 2.30 | .18 | 3.77 | Red | P71 | 2 3/8 | 6 |
| LCCF300-38DH-6 | 350 kcmil | 373.7 kcmil | 3/8 | 1.00 | 1.38 | 2.30 | .18 | 4.25 | Red | P71 | 2 3/8 | 6 |
| ◆ LCCF300-12H-6 | | | 1/2 | 1.75 | 1.38 | 2.30 | .18 | 5.43 | Red | P71 | 2 3/8 | 6 |
| LCCF350-14BH-6 | | | 1/4 | .75 | 1.53 | 2.50 | .22 | 3.98 | Blue | P76 | 2 9/16 | 6 |
| LCCF350-38DH-6 | 400 kcmil | 444.4 kcmil | 3/8 | 1.00 | 1.53 | 2.50 | .22 | 4.46 | Blue | P76 | 2 9/16 | 6 |
| LCCF350-12EH-6 | | | 1/2 | 1.25 | 1.53 | 2.50 | .22 | 5.14 | Blue | P76 | 2 9/16 | 6 |
| ◆ LCCF350-12H-6 | | | 1/2 | 1.75 | 1.53 | 2.50 | .22 | 5.64 | Blue | P76 | 2 9/16 | 6 |
| LCCF400-38DH-6 | 500 kcmil | 535.3 kcmil | 3/8 | 1.00 | 1.70 | 2.69 | .26 | 4.66 | Brown | P87 | 2 3/4 | 6 |
| ◆ LCCF400-12H-6 | | | 1/2 | 1.75 | 1.70 | 2.69 | .26 | 5.84 | Brown | P87 | 2 3/4 | 6 |
| ◆ LCCF500-12H-6 | | | 1/2 | 1.75 | 1.89 | 2.88 | .26 | 6.18 | Pink | P99 | 2 15/16 | 6 |
| ◆ LCCF600-12H-6 | — | 646.4 kcmil | 1/2 | 1.75 | 1.95 | 2.94 | .29 | 6.25 | Black | P106 | 3 | 6 |
| LCCF750-38DH-3 | — | 777.7 kcmil | 3/8 | 1.00 | 2.17 | 3.00 | .32 | 5.45 | Orange | P107 | 3 1/16 | 3 |
| ◆ LCCF750-12H-3 | | | 1/2 | 1.75 | 2.17 | 3.00 | .32 | 6.39 | Orange | P107 | 3 1/16 | 3 |

‡See pages D3.70, D3.71 for tool and die information.

**Consult cable manufacturer for voltage stress relief instructions with applications greater than 2000 V.

◆NEMA hole sizes and spacing.



Flex Conductor, Two-Hole, Long Barrel, Flared NEBS Lug, 90° Angle

For Use with Flexible and Extra-Flexible Copper Conductors

Type LCCF-F

- Can be used with flex conductor class: K, M, and Diesel Locomotive
- Long barrel maximizes the number of crimps and provides premium wire pull-out strength and electrical performance
- Flared entry prevents bent back strands when inserting fine strand conductor into barrel
- Color-coded barrels marked with *PANDUIT* die index numbers for proper crimp die selection
- Enclosed barrel prevents corrosive material from entering barrel when used in harsh environments
- Tin-plated to inhibit corrosion
- UL Listed and CSA Certified to 35 KV** and temperature rated to 90°C when crimped with *PANDUIT* crimping tools and dies
- **Tested by Telcordia – meets NEBS Level 3**
- Available with NEMA hole sizes and spacing

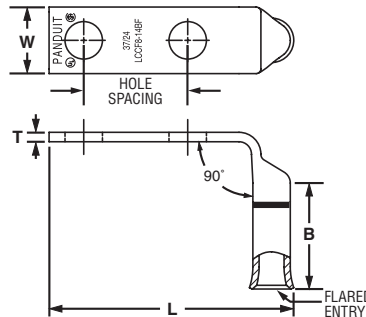

| Part Number | Flex Conductor Size | | Stud Hole Size (In.) | Stud Hole Spacing (In.) | Figure Dimensions (In.) | | | | PANDUIT Color Code | PANDUIT Die Index No.‡ | Wire Strip Length (In.) | Std. Pkg. Qty. |
|----------------|---------------------|-------------------|----------------------|-------------------------|-------------------------|------|-----|------|--------------------|------------------------|-------------------------|----------------|
| | Class K and M | Diesel Locomotive | | | W | B | T | L | | | | |
| LCCF8-14AF-L | — | #8 AWG | 1/4 | .63 | .48 | .76 | .07 | 1.64 | Red | P21 | 13/16 | 50 |
| LCCF8-14BF-L | | | 1/4 | .75 | .48 | .76 | .07 | 1.77 | Red | P21 | 13/16 | 50 |
| LCCF8-38DF-L | | | 3/8 | 1.00 | .60 | .76 | .05 | 2.24 | Red | P21 | 13/16 | 50 |
| LCCF6-14AF-L | #6 AWG | #6 AWG | 1/4 | .63 | .48 | 1.22 | .08 | 1.69 | Blue | P24 | 1 5/16 | 50 |
| LCCF6-14BF-L | | | 1/4 | .75 | .48 | 1.22 | .08 | 1.81 | Blue | P24 | 1 5/16 | 50 |
| LCCF6-38DF-L | | | 3/8 | 1.00 | .62 | 1.22 | .06 | 2.28 | Blue | P24 | 1 5/16 | 50 |
| LCCF4-14AF-L | #4 AWG | #4 AWG | 1/4 | .63 | .55 | 1.23 | .09 | 1.78 | Gray | P29 | 1 5/16 | 50 |
| LCCF4-14BF-L | | | 1/4 | .75 | .55 | 1.23 | .09 | 1.91 | Gray | P29 | 1 5/16 | 50 |
| LCCF2-14BF-E | | | 1/4 | .75 | .70 | 1.36 | .11 | 2.10 | Brown | P33 | 1 7/16 | 20 |
| LCCF2-56BF-E | #2 AWG | #2 AWG | 5/16 | .75 | .70 | 1.36 | .11 | 2.23 | Brown | P33 | 1 7/16 | 20 |
| LCCF2-38DF-E | | | 3/8 | 1.00 | .70 | 1.36 | .11 | 2.55 | Brown | P33 | 1 7/16 | 20 |
| LCCF2-12F-E | | | 1/2 | 1.75 | .79 | 1.36 | .09 | 3.72 | Brown | P33 | 1 7/16 | 20 |
| LCCF1-14AF-X | #1 AWG | #1 AWG | 1/4 | .63 | .76 | 1.44 | .12 | 2.11 | Pink | P42 | 1 1/2 | 10 |
| LCCF1-14BF-X | | | 1/4 | .75 | .76 | 1.44 | .12 | 2.24 | Pink | P42 | 1 1/2 | 10 |
| LCCF1-56CF-X | | | 5/16 | .88 | .76 | 1.44 | .12 | 2.42 | Pink | P42 | 1 1/2 | 10 |
| LCCF1-38DF-X | | | 3/8 | 1.00 | .76 | 1.44 | .12 | 2.62 | Pink | P42 | 1 1/2 | 10 |
| LCCF1-12F-X | | | 1/2 | 1.75 | .80 | 1.44 | .11 | 3.79 | Pink | P42 | 1 1/2 | 10 |
| LCCF1/0-14AF-X | 1/0 AWG | 1/0 AWG | 1/4 | .63 | .85 | 1.50 | .13 | 2.27 | Black | P45 | 1 9/16 | 10 |
| LCCF1/0-14BF-X | | | 1/4 | .75 | .85 | 1.50 | .13 | 2.39 | Black | P45 | 1 9/16 | 10 |
| LCCF1/0-56CF-X | | | 5/16 | .88 | .85 | 1.50 | .13 | 2.52 | Black | P45 | 1 9/16 | 10 |
| LCCF1/0-38DF-X | | | 3/8 | 1.00 | .85 | 1.50 | .13 | 2.70 | Black | P45 | 1 9/16 | 10 |
| LCCF1/0-12F-X | | | 1/2 | 1.75 | .85 | 1.50 | .13 | 3.87 | Black | P45 | 1 9/16 | 10 |
| LCCF2/0-14AF-X | 2/0 AWG | 2/0 AWG | 1/4 | .63 | .96 | 1.50 | .13 | 2.33 | Orange | P50 | 1 9/16 | 10 |
| LCCF2/0-14BF-X | | | 1/4 | .75 | .96 | 1.50 | .13 | 2.46 | Orange | P50 | 1 9/16 | 10 |
| LCCF2/0-38DF-X | | | 3/8 | 1.00 | .96 | 1.50 | .13 | 2.77 | Orange | P50 | 1 9/16 | 10 |
| LCCF2/0-12F-X | | | 1/2 | 1.75 | .96 | 1.50 | .13 | 3.93 | Orange | P50 | 1 9/16 | 10 |
| LCCF3/0-14BF-X | 3/0 AWG | 3/0 AWG | 1/4 | .75 | 1.06 | 1.56 | .14 | 2.56 | Purple | P54 | 1 5/8 | 10 |
| LCCF3/0-38DF-X | | | 3/8 | 1.00 | 1.06 | 1.56 | .14 | 2.89 | Purple | P54 | 1 5/8 | 10 |
| LCCF3/0-12F-X | | | 1/2 | 1.75 | 1.06 | 1.56 | .14 | 4.03 | Purple | P54 | 1 5/8 | 10 |

‡See pages D3.70, D3.71 for tool and die information.

**Consult cable manufacturer for voltage stress relief instructions with applications greater than 2000 V.

Table continues on page D2.102

A. System Overview

B1. Cable Ties

B2. Cable Accessories

B3. Stainless Steel Ties

C1. Wiring Duct

C2. Surface Raceway

C3. Abrasion Protection

C4. Cable Management

D1. Terminals

D2. Power Connectors

D3. Grounding Connectors

E1. Labeling Systems

E2. Labels

E3. Pre-Printed & Write-On Markers

E4. Permanent Identification

E5. Lockout/Tagout & Safety Solutions

F. Index

A.
System
Overview

B1.
Cable Ties

B2.
Cable
Accessories

B3.
Stainless
Steel Ties

C1.
Wiring
Duct

C2.
Surface
Raceway

C3.
Abrasion
Protection

C4.
Cable
Management

D1.
Terminals

D2.
Power
Connectors

D3.
Grounding
Connectors

E1.
Labeling
Systems

E2.
Labels

E3.
Pre-Printed
& Write-On
Markers

E4.
Permanent
Identification

E5.
Lockout/
Tagout
& Safety
Solutions

F.
Index



Flex Conductor, Two-Hole, Long Barrel, Flared NEBS Lug, 90° Angle (continued)

| Part Number | Flex Conductor Size | | Stud Hole Size (In.) | Stud Hole Spacing (In.) | Figure Dimensions (In.) | | | | PANDUIT Color Code | PANDUIT Die Index No.‡ | Wire Strip Length (In.) | Std. Pkg. Qty. |
|----------------|---------------------|-------------------|----------------------|-------------------------|-------------------------|------|-----|------|--------------------|------------------------|-------------------------|----------------|
| | Class K and M | Diesel Locomotive | | | W | B | T | L | | | | |
| LCCF4/0-14BF-X | 4/0 AWG | 4/0 AWG | 1/4 | .75 | 1.17 | 1.61 | .14 | 2.48 | Yellow | P62 | 1 11/16 | 10 |
| LCCF4/0-38DF-X | | | 3/8 | 1.00 | 1.17 | 1.61 | .14 | 2.97 | Yellow | P62 | 1 11/16 | 10 |
| LCCF4/0-38F-X | | | 3/8 | 1.75 | 1.17 | 1.61 | .14 | 3.72 | Yellow | P62 | 1 11/16 | 10 |
| LCCF4/0-12F-X | 250 kcmil | 262.6 kcmil | 1/2 | 1.75 | 1.17 | 1.61 | .14 | 4.11 | Yellow | P62 | 1 11/16 | 10 |
| LCCF250-14BF-X | | | 1/4 | .75 | 1.28 | 2.24 | .17 | 2.54 | White | P66 | 2 5/16 | 10 |
| LCCF250-38DF-X | | | 3/8 | 1.00 | 1.28 | 2.24 | .17 | 3.02 | White | P66 | 2 5/16 | 10 |
| LCCF250-12EF-X | 300 kcmil | 313.1 kcmil | 1/2 | 1.25 | 1.28 | 2.24 | .17 | 3.70 | White | P66 | 2 5/16 | 10 |
| LCCF250-12F-X | | | 1/2 | 1.75 | 1.28 | 2.24 | .17 | 4.20 | White | P66 | 2 5/16 | 10 |
| LCCF300-14BF-6 | | | 1/4 | .75 | 1.38 | 2.30 | .18 | 2.61 | Red | P71 | 2 3/8 | 6 |
| LCCF300-38DF-6 | 350 kcmil | 373.7 kcmil | 3/8 | 1.00 | 1.38 | 2.30 | .18 | 3.09 | Red | P71 | 2 3/8 | 6 |
| LCCF300-12F-6 | | | 1/2 | 1.75 | 1.38 | 2.30 | .18 | 4.27 | Red | P71 | 2 3/8 | 6 |
| LCCF350-14BF-6 | | | 1/4 | .75 | 1.53 | 2.50 | .22 | 2.73 | Blue | P76 | 2 9/16 | 6 |
| LCCF350-38DF-6 | 400 kcmil | 444.4 kcmil | 3/8 | 1.00 | 1.53 | 2.50 | .22 | 3.21 | Blue | P76 | 2 9/16 | 6 |
| LCCF350-12EF-6 | | | 1/2 | 1.25 | 1.53 | 2.50 | .22 | 3.89 | Blue | P76 | 2 9/16 | 6 |
| LCCF350-12F-6 | | | 1/2 | 1.75 | 1.53 | 2.50 | .22 | 4.39 | Blue | P76 | 2 9/16 | 6 |
| LCCF400-38DF-6 | 500 kcmil | 535.3 kcmil | 3/8 | 1.00 | 1.70 | 2.69 | .26 | 3.33 | Brown | P87 | 2 3/4 | 6 |
| LCCF400-12F-6 | | | 1/2 | 1.75 | 1.70 | 2.69 | .26 | 4.51 | Brown | P87 | 2 3/4 | 6 |
| LCCF500-12F-6 | | | 1/2 | 1.75 | 1.89 | 2.88 | .26 | 4.67 | Pink | P99 | 2 15/16 | 6 |
| LCCF600-12F-6 | — | 646.4 kcmil | 1/2 | 1.75 | 1.95 | 2.88 | .29 | 4.73 | Black | P106 | 3 | 6 |
| LCCF750-38DF-3 | — | 777.7 kcmil | 3/8 | 1.00 | 2.17 | 3.00 | .32 | 3.96 | Orange | P107 | 3 1/16 | 3 |
| LCCF750-12F-3 | | | 1/2 | 1.75 | 2.17 | 3.00 | .32 | 4.90 | Orange | P107 | 3 1/16 | 3 |

‡See pages D3.70, D3.71 for tool and die information.

**Consult cable manufacturer for voltage stress relief instructions with applications greater than 2000 V.

◆NEMA hole sizes and spacing.



Flex Conductor, Standard Barrel, Flared, NEBS Butt Splice

For Use with Flexible and Extra-Flexible Copper Conductors

Type SCSF

- Can be used with flex conductor class: K, M, and Diesel Locomotive
- Flared entry prevents bent back strands when inserting fine strand conductor into barrel
- Color-coded barrels marked with *PANDUIT* die index numbers for proper crimp die selection
- Internal wire stops to prevent over-insertion of conductor
- Tin-plated to inhibit corrosion
- UL Listed and CSA Certified to 35 KV** and temperature rated to 90°C when crimped with *PANDUIT* crimping tools and dies
- **Tested by Telcordia – meets NEBS Level 3**
- American Bureau of Shipping approved

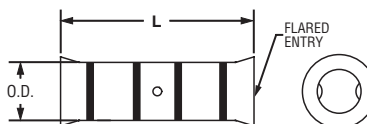

| Part Number | Flex Conductor Size | | Figure Dimensions (In.) | | PANDUIT Color Code | PANDUIT Die Index No.‡ | Wire Strip Length (In.) | Std. Pkg. Qty. |
|-------------|---------------------|-------------------|-------------------------|------|--------------------|------------------------|-------------------------|----------------|
| | Class K and M | Diesel Locomotive | Barrel O.D. | L | | | | |
| SCSF8-L | — | #8 AWG | .27 | 1.50 | Red | P21 | 11/16 | 50 |
| SCSF6-L | #6 AWG | #6 AWG | .31 | 1.75 | Blue | P24 | 13/16 | 50 |
| SCSF4-L | #4 AWG | #4 AWG | .38 | 1.75 | Gray | P29 | 13/16 | 50 |
| SCSF2-E | #2 AWG | #2 AWG | .47 | 1.87 | Brown | P33 | 7/8 | 20 |
| SCSF1-X | #1 AWG | #1 AWG | .52 | 1.87 | Pink | P42 | 7/8 | 10 |
| SCSF1/0-X | 1/0 AWG | 1/0 AWG | .58 | 2.50 | Black | P45 | 1 3/16 | 10 |
| SCSF2/0-X | 2/0 AWG | 2/0 AWG | .64 | 2.50 | Orange | P50 | 1 3/16 | 10 |
| SCSF3/0-X | 3/0 AWG | 3/0 AWG | .71 | 2.50 | Purple | P54 | 1 3/16 | 10 |
| SCSF4/0-X | 4/0 AWG | 4/0 AWG | .77 | 2.50 | Yellow | P62 | 1 3/16 | 10 |
| SCSF250-X | 250 kcmil | 262.6 kcmil | .88 | 2.50 | White | P66 | 1 3/16 | 10 |
| SCSF300-6 | 300 kcmil | 313.1 kcmil | .95 | 2.56 | Red | P71 | 1 1/4 | 6 |
| SCSF350-6 | 350 kcmil | 373.7 kcmil | 1.06 | 2.94 | Blue | P76 | 1 1/2 | 6 |

‡See pages D3.70, D3.71 for tool and die information.

**Consult cable manufacturer for voltage stress relief instructions with applications greater than 2000 V.

A. System Overview

B1. Cable Ties

B2. Cable Accessories

B3. Stainless Steel Ties

C1. Wiring Duct

C2. Surface Raceway

C3. Abrasion Protection

C4. Cable Management

D1. Terminals

D2. Power Connectors

D3. Grounding Connectors

E1. Labeling Systems

E2. Labels

E3. Pre-Printed & Write-On Markers

E4. Permanent Identification

E5. Lockout/Tagout & Safety Solutions

F. Index

A.
System
Overview

Code/Flex Conductor, with Window, In-Line Reducing Splice Kit

B1.
Cable Ties

Type RSCK

- Includes all components in one package for making a complete electrical connection: *PANDUIT* copper compression RSC in-line reducing splice (see pages D2.106 – D2.107) and crystal clear PVC heat shrink sleeves pre-cut to length to insulate reducing splice
- PANDUIT* RSC in-line reducing splice is UL Listed and temperature rated to 90°C when crimped with *PANDUIT* crimping tools and dies
- PANDUIT* crystal clear PVC heat shrink has a UL 224 VW-1 flammability rating and passes Telcordia GR-347-CORE Compression and Cut-Through Penetration Test and Abrasion Resistance Test
- PANDUIT* crystal clear PVC heat shrink is UL Recognized with a temperature rating of 150°C, high temperature insulating property
- Rated for 600 V applications when *PANDUIT* crystal clear PVC heat shrink is applied

B2.
Cable
Accessories

B3.
Stainless
Steel Ties



C1.
Wiring
Duct

C2.
Surface
Raceway

C3.
Abrasion
Protection

C4.
Cable
Management

D1.
Terminals

D2.
Power
Connectors

D3.
Grounding
Connectors

E1.
Labeling
Systems

E2.
Labels

E3.
Pre-Printed
& Write-On
Markers

E4.
Permanent
Identification

E5.
Lockout/
Tagout
& Safety
Solutions

F.
Index

| Part Number | Part Description | Std. Pkg. Qty. |
|--------------------|---|----------------|
| RSCK4-6-1 | Kit contains: 1 pc. RSC4-6-L copper compression in-line reducing splice. 1 pc. HSTTPN50-713-Q crystal clear PVC heat shrink 1/2" dia. x 7.125" long. | 1 |
| RSCK2-6-1 | Kit contains: 1 pc. RSC2-6-Q copper compression in-line reducing splice. 1 pc. HSTTPN62-750-Q crystal clear PVC heat shrink 5/8" dia. x 7.500" long. | 1 |
| RSCK2-4-1 | Kit contains: 1 pc. RSC2-4-Q copper compression in-line reducing splice. 1 pc. HSTTPN62-750-Q crystal clear PVC heat shrink 5/8" dia. x 7.500" long. | 1 |
| RSCK1/0-6-1 | Kit contains: 1 pc. RSC1/0-6-X copper compression in-line reducing splice. 1 pc. HSTTPN75-775-Q crystal clear PVC heat shrink 3/4" dia. x 7.750" long. 1 pc. HSTTPN50-438-L crystal clear PVC heat shrink 1/2" dia. x 4.375" long. | 1 |
| RSCK1/0-4-1 | Kit contains: 1 pc. RSC1/0-4-X copper compression in-line reducing splice. 1 pc. HSTTPN75-775-Q crystal clear PVC heat shrink 3/4" dia. x 7.750" long. 1 pc. HSTTPN50-438-L crystal clear PVC heat shrink 1/2" dia. x 4.375" long. | 1 |
| RSCK2/0-6-1 | Kit contains: 1 pc. RSC2/0-6-X copper compression in-line reducing splice. 1 pc. HSTTPN75-775-Q crystal clear PVC heat shrink 3/4" dia. x 7.750" long. 1 pc. HSTTPN50-438-L crystal clear PVC heat shrink 1/2" dia. x 4.375" long. | 1 |
| RSCK2/0-4-1 | Kit contains: 1 pc. RSC2/0-4-X copper compression in-line reducing splice. 1 pc. HSTTPN75-775-Q crystal clear PVC heat shrink 3/4" dia. x 7.750" long. 1 pc. HSTTPN50-438-L crystal clear PVC heat shrink 1/2" dia. x 4.375" long. | 1 |
| RSCK4/0-6-1 | Kit contains: 1 pc. RSC4/0-6-X copper compression in-line reducing splice. 1 pc. HSTTPN100-775-Q crystal clear PVC heat shrink 1" dia. x 7.750" long. 1 pc. HSTTPN50-438-L crystal clear PVC heat shrink 1/2" dia. x 4.375" long. | 1 |
| RSCK4/0-4-1 | Kit contains: 1 pc. RSC4/0-4-X copper compression in-line reducing splice. 1 pc. HSTTPN100-775-Q crystal clear PVC heat shrink 1" dia. x 7.750" long. 1 pc. HSTTPN50-438-L crystal clear PVC heat shrink 1/2" dia. x 4.375" long. | 1 |

Code/Flex Conductor, with Window, In-Line Reducing Splice Kit (continued)



| Part Number | Part Description | Std. Pkg. Qty. |
|----------------|---|----------------|
| RSCK4/0-1/0-1 | Kit contains: 1 pc. RSC4/0-1/0-X copper compression in-line reducing splice. 1 pc. HSTTPN100-775-Q crystal clear PVC heat shrink 1" dia. x 7.750" long. 1 pc. HSTTPN75-775-Q crystal clear PVC heat shrink 3/4" dia. x 7.750" long. | 1 |
| RSCK4/0-2/0-1 | Kit contains: 1 pc. RSC4/0-2/0-X copper compression in-line reducing splice. 1 pc. HSTTPN100-775-Q crystal clear PVC heat shrink 1" dia. x 7.750" long. 1 pc. HSTTPN75-775-Q crystal clear PVC heat shrink 3/4" dia. x 7.750" long. | 1 |
| RSCK500-X4/0-1 | Kit contains: 1 pc. RSC500-X4/0-6 copper compression in-line reducing splice. 1 pc. HSTTPN150-925-X crystal clear PVC heat shrink 1 1/2" dia. x 9.250" long. | 1 |
| RSCK500-X350-1 | Kit contains: 1 pc. RSC500-X350-6 copper compression in-line reducing splice. 1 pc. HSTTPN150-925-X crystal clear PVC heat shrink 1 1/2" dia. x 9.250" long. | 1 |
| RSCK750-4/0-1 | Kit contains: 1 pc. RSC750-4/0-6 copper compression in-line reducing splice. 1 pc. HSTTPN150-925-X crystal clear PVC heat shrink 1 1/2" dia. x 9.250" long. 1 pc. HSTTPN100-775-Q crystal clear PVC heat shrink 1" dia. x 7.750" long. | 1 |
| RSCK750-X4/0-1 | Kit contains: 1 pc. RSC750-X4/0-6 copper compression in-line reducing splice. 1 pc. HSTTPN150-925-X crystal clear PVC heat shrink 1 1/2" dia. x 9.250" long. | 1 |
| RSCK750-X350-1 | Kit contains: 1 pc. RSC750-X350-6 copper compression in-line reducing splice. 1 pc. HSTTPN150-925-X crystal clear PVC heat shrink 1 1/2" dia. x 9.250" long. | 1 |
| RSCK750-500-1 | Kit contains: 1 pc. RSC750-500-6 copper compression in-line reducing splice. 1 pc. HSTTPN150-925-X crystal clear PVC heat shrink 1 1/2" dia. x 9.250" long. | 1 |
| RSCK750-X500-1 | Kit contains: 1 pc. RSC750-X500-6 copper compression in-line reducing splice. 1 pc. HSTTPN150-925-X crystal clear PVC heat shrink 1 1/2" dia. x 9.250" long. | 1 |
| RSCK750-750-1 | Kit contains: 1 pc. RSC750-750-6 copper compression in-line reducing splice. 1 pc. HSTTPN150-925-X crystal clear PVC heat shrink 1 1/2" dia. x 9.250" long. | 1 |
| RSCKX750-4/0-1 | Kit contains: 1 pc. RSCX750-4/0-3 copper compression in-line reducing splice. 1 pc. HSTTPN200-950-X crystal clear PVC heat shrink 2" dia. x 9.500" long. 1 pc. HSTTPN100-775-Q crystal clear PVC heat shrink 1" dia. x 7.750" long. | 1 |
| RSCKX750-750-1 | Kit contains: 1 pc. RSCX750-750-3 copper compression in-line reducing splice. 1 pc. HSTTPN200-950-X crystal clear PVC heat shrink 2" dia. x 9.500" long. | 1 |

A.
System
Overview

B1.
Cable Ties

B2.
Cable
Accessories

B3.
Stainless
Steel Ties

C1.
Wiring
Duct

C2.
Surface
Raceway

C3.
Abrasion
Protection

C4.
Cable
Management

D1.
Terminals

D2.
Power
Connectors

D3.
Grounding
Connectors

E1.
Labeling
Systems

E2.
Labels

E3.
Pre-Printed
& Write-On
Markers

E4.
Permanent
Identification

E5.
Lockout/
Tagout
& Safety
Solutions

F.
Index

A. System Overview

B1. Cable Ties



Code/Flex Conductor, with Window, In-Line Reducing Splice

For Use with Stranded Copper Code and Class I Flex Conductors

Type RSC

- Low profile design provides minimum space requirements
- Manufactured from seamless, high conductivity copper tubing
- Color-coded barrels marked with *PANDUIT* and specified competitor die index numbers for proper crimp die selection
- Inspection windows in each barrel to visually assure full conductor insertion

- Generous internally beveled wire entry for easy conductor insertion
- Tin-plated to inhibit corrosion
- UL Listed and CSA Certified to 35 KV** and temperature rated to 90°C when crimped with *PANDUIT* and specified competitor crimping tools and dies
- Also sold as a kit with crystal clear PVC heat shrink (see pages D2.104, D2.105)

B3. Stainless Steel Ties

C1. Wiring Duct



C2. Surface Raceway

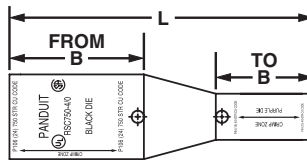

C3. Abrasion Protection

C4. Cable Management

| Part Number | Copper Conductor Size | Figure Dimensions (In.) | | PANDUIT Color Code | PANDUIT Die Index No.‡ | Burndy Die Index No.‡ | T&B Die Index No.‡ | Wire Strip Length (In.) | Std. Pkg. Qty. | |
|---------------|-----------------------|---------------------------|------|--------------------|------------------------|-----------------------|--------------------|-------------------------|----------------|---|
| | | B | L | | | | | | | |
| RSC4-6-L | Reduces From | #4 – 3 AWG STR,#2 AWG SOL | 1.05 | 2.54 | Gray | P29 | 8 | 29 | 1 | 1 |
| | Reduces To | #6 AWG | 1.38 | | Blue | P24 | 7 | 24 | 1 5/16 | |
| RSC2-6-Q | Reduces From | #2 AWG | 1.05 | 2.62 | Brown | P33 | 10 | 33 | 1 | 1 |
| | Reduces To | #6 AWG | 1.38 | | Blue | P24 | 7 | 34 | 1 5/16 | |
| RSC2-4-Q | Reduces From | #2 AWG | 1.05 | 2.50 | Brown | P33 | 10 | 33 | 1 | 1 |
| | Reduces To | #4 – 3 AWG STR,#2 AWG SOL | 1.38 | | Gray | P29 | 8 | 29 | 1 5/16 | |
| RSC1/0-6-X | Reduces From | 1/0 AWG | 1.05 | 2.81 | Pink | P42 | 12 | 42 | 1 | 1 |
| | Reduces To | #6 AWG | 1.38 | | Blue | P24 | 7 | 24 | 1 5/16 | |
| RSC1/0-4-X | Reduces From | 1/0 AWG | 1.05 | 2.70 | Pink | P42 | 12 | 42 | 1 | 1 |
| | Reduces To | #4 – 3 AWG STR,#2 AWG SOL | 1.38 | | Gray | P29 | 8 | 29 | 1 5/16 | |
| RSC2/0-6-X | Reduces From | 2/0 AWG | 1.13 | 2.99 | Black | P45 | 13 | 45 | 1 1/16 | 1 |
| | Reduces To | #6 AWG | 1.38 | | Blue | P24 | 7 | 24 | 1 5/16 | |
| RSC2/0-4-X | Reduces From | 2/0 AWG | 1.13 | 2.88 | Black | P45 | 13 | 45 | 1 1/16 | 1 |
| | Reduces To | #4 – 3 AWG STR,#2 AWG SOL | 1.38 | | Gray | P29 | 8 | 29 | 1 5/16 | |
| RSC4/0-6-X | Reduces From | 4/0 AWG | 1.13 | 3.24 | Purple | P54 | 15 | 54 | 1 1/16 | 1 |
| | Reduces To | #6 AWG | 1.38 | | Blue | P24 | 7 | 24 | 1 5/16 | |
| RSC4/0-4-X | Reduces From | 4/0 AWG | 1.13 | 3.12 | Purple | P54 | 15 | 54 | 1 1/16 | 1 |
| | Reduces To | #4 – 3 AWG STR,#2 AWG SOL | 1.38 | | Gray | P29 | 8 | 29 | 1 5/16 | |
| RSC4/0-1/0-X | Reduces From | 4/0 AWG | 1.16 | 3.13 | Purple | P54 | 15 | 54 | 1 1/16 | 1 |
| | Reduces To | 1/0 AWG | 1.63 | | Pink | P42 | 12 | 42 | 1 9/16 | |
| RSC4/0-2/0-X | Reduces From | 4/0 AWG | 1.16 | 2.90 | Purple | P54 | 15 | 54 | 1 1/16 | 1 |
| | Reduces To | 2/0 AWG | 1.50 | | Black | P45 | 13 | 45 | 1 7/16 | |
| RSC500-X4/0-6 | Reduces From | 500 kcmil | 1.94 | 3.97 | Brown | P87 | 20 | 87 | 1 7/8 | 1 |
| | Reduces To | 4/0 Flex | 1.50 | | Yellow | P62 | 16 | 62 | 1 7/16 | |
| RSC500-X350-6 | Reduces From | 500 kcmil | 1.94 | 4.38 | Brown | P87 | 20 | 87 | 1 7/8 | 1 |
| | Reduces To | 350 Flex | 1.94 | | Blue | P76 | 19 | 76 | 1 7/8 | |

‡See pages D3.72 – D3.77 for tool and die information.

**Consult cable manufacturer for voltage stress relief instructions with applications greater than 2000 V.



Code/Flex Conductor, with Window, In-Line Reducing Splice (continued)

| Part Number | | Copper Conductor Size | Figure Dimensions (In.) | | PANDUIT Color Code | PANDUIT Die Index No.‡ | Burndy Die Index No.‡ | T&B Die Index No.‡ | Wire Strip Length (In.) | Std. Pkg. Qty. |
|---------------|--------------|-----------------------|-------------------------|------|--------------------|------------------------|-----------------------|--------------------|-------------------------|----------------|
| | | | B | L | | | | | | |
| RSC750-4/0-6 | Reduces From | 750 kcmil | 2.06 | 4.66 | Black | P106 | 24 | 106 | 2 | 1 |
| | Reduces To | 4/0 AWG | 1.50 | | Purple | P54 | 15 | 54 | 1 5/8 | |
| RSC750-X4/0-6 | Reduces From | 750 kcmil | 2.06 | 4.54 | Black | P106 | 24 | 106 | 2 | 1 |
| | Reduces To | 4/0 Flex | 1.50 | | Yellow | P62 | 16 | 62 | 1 7/16 | |
| RSC750-X350-6 | Reduces From | 750 kcmil | 2.06 | 4.45 | Black | P106 | 24 | 106 | 2 | 1 |
| | Reduces To | 350 Flex | 1.94 | | Blue | P76 | 19 | 76 | 1 7/8 | |
| RSC750-500-6 | Reduces From | 750 kcmil | 2.06 | 4.45 | Black | P106 | 24 | 106 | 2 | 1 |
| | Reduces To | 500 kcmil | 1.94 | | Brown | P87 | 20 | 87 | 1 7/8 | |
| RSC750-X500-6 | Reduces From | 750 kcmil | 2.06 | 4.63 | Black | P106 | 24 | 106 | 2 | 1 |
| | Reduces To | 500 Flex | 2.06 | | Pink | P99 | 400 | 99 | 2 | |
| RSC750-750-6 | Reduces From | 750 kcmil | 2.06 | 4.63 | Black | P106 | 24 | 106 | 2 | 1 |
| | Reduces To | 750 kcmil | 2.06 | | Black | P106 | 24 | 106 | 2 | |
| RSCX750-4/0-3 | Reduces From | 750 Flex | 2.06 | 5.04 | Yellow | P115 | 115 | 115 | 2 | 1 |
| | Reduces To | 4/0 AWG | 1.50 | | Purple | P54 | 15 | 54 | 1 5/8 | |
| RSCX750-750-3 | Reduces From | 750 Flex | 2.06 | 4.50 | Yellow | P115 | 115 | 115 | 2 | 1 |
| | Reduces To | 750 kcmil | 2.06 | | Black | P106 | 24 | 106 | 2 | |

‡See pages D3.72 – D3.77 for tool and die information.

**Consult cable manufacturer for voltage stress relief instructions with applications greater than 2000 V.

A.
System
Overview

B1.
Cable
Ties

B2.
Cable
Accessories

B3.
Stainless
Steel Ties

C1.
Wiring
Duct

C2.
Surface
Raceway

C3.
Abrasion
Protection

C4.
Cable
Management

D1.
Terminals

D2.
Power
Connectors

D3.
Grounding
Connectors

E1.
Labeling
Systems

E2.
Labels

E3.
Pre-Printed
& Write-On
Markers

E4.
Permanent
Identification

E5.
Lockout/
Tagout
& Safety
Solutions

F.
Index

A. System Overview

Part Number System for Metric Lugs

B1. Cable Ties

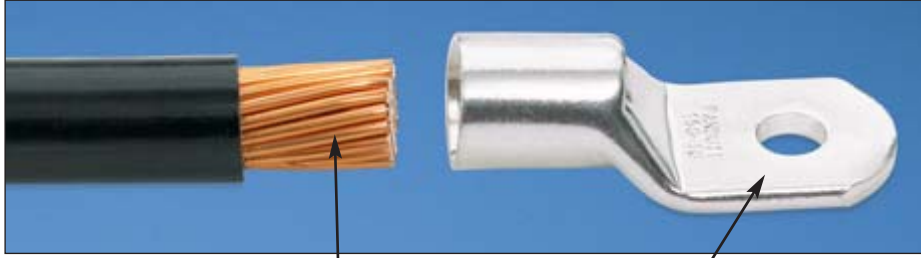

LCMA **150** — **10** —

150 = 150mm² 10 = 10mm

X

1 = 1 X = 10 C = 100
5 = 5 L = 50

B2. Cable Accessories

B3. Stainless Steel Ties

C1. Wiring Duct

Part Number System for *PAN-LUG*™ Compression Metric Lugs

C2. Surface Raceway

LCMA **150** — **10** — **X**

Type Conductor Size Stud Hole Size Standard Package Size

C3. Abrasion Protection

C4. Cable Management

5 = #5
6 = 6mm
8 = 8mm
10 = 10mm
12 = 12mm
14 = 14mm
16 = 16mm
20 = 20mm
00 = Blank Tongue*

1 = 1
5 = 5
6 = 6
X = 10
Q = 25
L = 50
C = 100

D1. Terminals

D2. Power Connectors

NEW! **Metric Conductor, One-Hole, Standard Barrel with Window Lug**

D3. Grounding Connectors

For Use with Class 2 Stranded Copper Conductors

Type LCMA

- Inspection window to visually assure full conductor insertion
- Tin-plated to inhibit corrosion
- UL Listed, UL Recognized, and CSA Certified to 35 KV** and temperature rated to 90°C when crimped with *PANDUIT* tools and dies

- Product information marked on connector for selection and installation
- Rounded tongue convenient for use in tight spaces
- Internally beveled wire entry for fast and easy installation

E1. Labeling Systems

E2. Labels

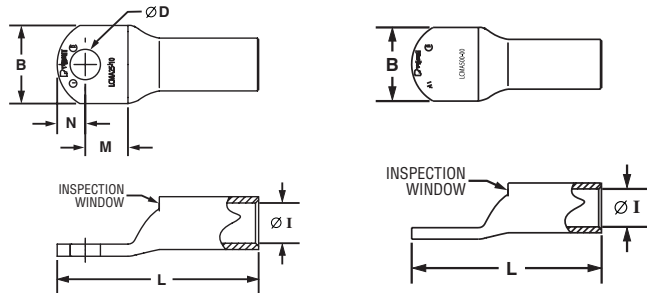

E3. Pre-Printed & Write-On Markers

E4. Permanent Identification

| Part Number | Copper Conductor Size Class 2 (mm ²) | Current Rating (Amps) | Stud Hole Size (mm) | Figure Dimensions (mm) | | | | | | PANDUIT Die Index No.‡ | Std. Pkg. Qty. |
|-------------|--|-----------------------|---------------------|------------------------|------|-----|-----|------|-----|------------------------|----------------|
| | | | | ØI | B | M | N | I | ØD | | |
| LCMA6-5-C* | 4 – 6 | 30 | M5 | 3.8 | 10.0 | 7.8 | 6.2 | 27.5 | 5.5 | P10 | 100 |
| LCMA6-6-C* | 4 – 6 | 30 | M6 | 3.8 | 10.8 | 7.8 | 6.2 | 27.5 | 6.6 | P10 | 100 |
| LCMA6-8-C* | 4 – 6 | 30 | M8 | 3.8 | 13.0 | 8.0 | 8.0 | 30.5 | 9.0 | P10 | 100 |

E5. Lockout/Tagout & Safety Solutions

F. Index

‡See page D3.79 for tool and die information.
*UL Recognized only.
**Consult cable manufacturer for voltage stress relief instructions with applications greater than 2000 V.



Metric Conductor, One-Hole, Standard Barrel with Window Lug (continued)



| Part Number | Copper Conductor Size Class 2 (mm ²) | Current Rating (Amps) | Stud Hole Size (mm) | Figure Dimensions (mm) | | | | | | PANDUIT Die Index No.‡ | Std. Pkg. Qty. |
|---------------|--|-----------------------|---------------------|------------------------|------|------|------|-------|------|------------------------|----------------|
| | | | | ØI | B | M | N | I | ØD | | |
| LCMA10-5-C | 10 | — | M5 | 4.5 | 11.0 | 9.8 | 6.0 | 30.8 | 5.5 | P21 | 100 |
| LCMA10-6-C | 10 | — | M6 | 4.5 | 11.0 | 9.8 | 6.0 | 30.8 | 6.6 | P21 | 100 |
| LCMA10-8-C | 10 | — | M8 | 4.5 | 13.0 | 8.5 | 8.0 | 30.8 | 9.0 | P21 | 100 |
| LCMA10-10-C | 10 | — | M10 | 4.4 | 14.5 | 8.5 | 8.0 | 30.8 | 11.0 | P21 | 100 |
| LCMA16-5-C* | 16 | 65 | M5 | 5.5 | 13.0 | 10.3 | 6.5 | 34.5 | 5.5 | P24 | 100 |
| LCMA16-6-C* | 16 | 65 | M6 | 5.5 | 13.0 | 10.3 | 6.5 | 34.5 | 6.6 | P24 | 100 |
| LCMA16-8-C* | 16 | 65 | M8 | 5.5 | 13.0 | 10.3 | 6.5 | 34.5 | 9.0 | P24 | 100 |
| LCMA16-10-C* | 16 | 65 | M10 | 5.5 | 15.0 | 10.2 | 8.0 | 36.7 | 11.0 | P24 | 100 |
| LCMA25-6-C | 25 | — | M6 | 6.9 | 14.0 | 10.0 | 8.0 | 37.0 | 6.6 | P29 | 100 |
| LCMA25-8-C | 25 | — | M8 | 6.9 | 15.5 | 10.0 | 8.0 | 37.0 | 9.0 | P29 | 100 |
| LCMA25-10-C | 25 | — | M10 | 6.9 | 15.5 | 10.0 | 8.0 | 37.0 | 11.0 | P29 | 100 |
| LCMA35-6-C | 35 | — | M6 | 8.2 | 15.5 | 12.3 | 8.5 | 42.0 | 6.6 | P33 | 100 |
| LCMA35-8-C | 35 | — | M8 | 8.2 | 15.5 | 12.3 | 8.5 | 42.0 | 9.0 | P33 | 100 |
| LCMA35-10-C | 35 | — | M10 | 8.2 | 15.5 | 12.3 | 8.5 | 42.0 | 11.0 | P33 | 100 |
| LCMA35-12-C | 35 | — | M12 | 8.2 | 21.5 | 14.5 | 11.5 | 48.0 | 14.0 | P33 | 100 |
| LCMA50-6-L | 50 | — | M6 | 9.8 | 18.0 | 11.5 | 10.0 | 46.5 | 6.6 | P42 | 50 |
| LCMA50-8-L | 50 | — | M8 | 9.8 | 18.0 | 11.5 | 10.0 | 46.5 | 9.0 | P42 | 50 |
| LCMA50-10-L | 50 | — | M10 | 9.8 | 18.0 | 11.5 | 10.0 | 46.5 | 11.0 | P42 | 50 |
| LCMA50-12-L | 50 | — | M12 | 9.8 | 23.0 | 14.0 | 11.0 | 50.0 | 14.0 | P42 | 50 |
| LCMA70-6-L | 70 | — | M6 | 11.5 | 20.8 | 14.5 | 11.5 | 53.5 | 6.6 | P45 | 50 |
| LCMA70-8-L | 70 | — | M8 | 11.5 | 20.8 | 14.5 | 11.5 | 53.5 | 9.0 | P45 | 50 |
| LCMA70-10-L | 70 | — | M10 | 11.5 | 20.8 | 14.5 | 11.5 | 53.5 | 11.0 | P45 | 50 |
| LCMA70-12-L | 70 | — | M12 | 11.5 | 20.8 | 14.5 | 11.5 | 53.5 | 14.0 | P45 | 50 |
| LCMA95-8-L | 95 | — | M8 | 13.5 | 24.5 | 15.0 | 13.5 | 60.5 | 9.0 | P54 | 50 |
| LCMA95-10-L | 95 | — | M10 | 13.5 | 24.5 | 15.0 | 13.5 | 60.5 | 11.0 | P54 | 50 |
| LCMA95-12-L | 95 | — | M12 | 13.5 | 24.5 | 15.0 | 13.5 | 60.5 | 14.0 | P54 | 50 |
| LCMA95-16-L | 95 | — | M16 | 13.5 | 24.5 | 15.0 | 13.5 | 60.5 | 18.0 | P54 | 50 |
| LCMA120-8-L | 120 | — | M8 | 15.2 | 27.5 | 15.5 | 14.5 | 65.0 | 9.0 | P62 | 50 |
| LCMA120-10-L | 120 | — | M10 | 15.2 | 27.5 | 15.5 | 14.5 | 65.0 | 11.0 | P62 | 50 |
| LCMA120-12-L | 120 | — | M12 | 15.2 | 27.5 | 15.5 | 14.5 | 65.0 | 14.0 | P62 | 50 |
| LCMA120-16-L | 120 | — | M16 | 15.2 | 27.5 | 15.5 | 14.5 | 65.0 | 18.0 | P62 | 50 |
| LCMA150-8-X | 150 | — | M8 | 16.5 | 30.5 | 18.0 | 16.5 | 70.5 | 9.0 | P66 | 10 |
| LCMA150-10-X | 150 | — | M10 | 16.5 | 30.5 | 18.0 | 16.5 | 70.5 | 11.0 | P66 | 10 |
| LCMA150-12-X | 150 | — | M12 | 16.5 | 30.5 | 18.0 | 16.5 | 70.5 | 14.0 | P66 | 10 |
| LCMA150-16-X | 150 | — | M16 | 16.5 | 30.5 | 18.0 | 16.5 | 70.5 | 18.0 | P66 | 10 |
| LCMA150-20-X | 150 | — | M20 | 16.5 | 30.5 | 22.0 | 16.5 | 74.0 | 22.0 | P66 | 10 |
| LCMA185-10-X | 185 | — | M10 | 18.6 | 33.5 | 16.5 | 17.5 | 72.5 | 11.0 | P76 | 10 |
| LCMA185-12-X | 185 | — | M12 | 18.6 | 33.5 | 16.5 | 17.5 | 72.5 | 14.0 | P76 | 10 |
| LCMA185-16-X | 185 | — | M16 | 18.6 | 33.5 | 16.5 | 17.5 | 72.5 | 18.0 | P76 | 10 |
| LCMA185-20-X | 185 | — | M20 | 18.6 | 33.5 | 21.0 | 17.5 | 77.0 | 22.0 | P76 | 10 |
| LCMA240-10-X | 240 | — | M10 | 20.8 | 37.5 | 21.0 | 19.5 | 86.5 | 11.0 | P87 | 10 |
| LCMA240-12-X | 240 | — | M12 | 20.8 | 37.5 | 21.0 | 19.5 | 86.5 | 14.0 | P87 | 10 |
| LCMA240-16-X | 240 | — | M16 | 20.8 | 37.5 | 21.0 | 19.5 | 86.5 | 18.0 | P87 | 10 |
| LCMA240-20-X | 240 | — | M20 | 20.8 | 37.5 | 21.0 | 19.5 | 86.5 | 22.0 | P87 | 10 |
| LCMA300-10-5 | 300 | — | M10 | 23.5 | 42.5 | 22.0 | 20.0 | 94.5 | 11.0 | P94 | 5 |
| LCMA300-12-5 | 300 | — | M12 | 23.5 | 42.5 | 22.0 | 20.0 | 94.5 | 14.0 | P94 | 5 |
| LCMA300-16-5 | 300 | — | M16 | 23.5 | 42.5 | 22.0 | 20.0 | 94.5 | 18.0 | P94 | 5 |
| LCMA300-20-5 | 300 | — | M20 | 23.5 | 42.5 | 22.0 | 20.0 | 94.5 | 22.0 | P94 | 5 |
| LCMA400-12-5 | 400 | — | M12 | 27.0 | 49.5 | 26.5 | 23.5 | 107.0 | 14.0 | P106 | 5 |
| LCMA400-16-5 | 400 | — | M16 | 27.0 | 49.5 | 26.5 | 23.5 | 107.0 | 18.0 | P106 | 5 |
| LCMA400-20-5 | 400 | — | M20 | 27.0 | 49.5 | 26.5 | 23.5 | 107.0 | 22.0 | P106 | 5 |
| LCMA500-12-1 | 500 | — | M12 | 31.0 | 57.5 | 28.5 | 25.5 | 120.0 | 14.0 | P125 | 1 |
| LCMA500-16-1 | 500 | — | M16 | 31.0 | 57.5 | 28.5 | 25.5 | 120.0 | 18.0 | P125 | 1 |
| LCMA500-20-1 | 500 | — | M20 | 31.0 | 57.5 | 28.5 | 25.5 | 120.0 | 22.0 | P125 | 1 |
| LCMA500-00-1* | 500 | — | Blank | 31.0 | 57.5 | — | — | 120.0 | — | P125 | 1 |
| LCMA630-16-1 | 630 | — | M16 | 34.5 | 63.0 | 28.5 | 27.5 | 131.0 | 18.0 | P125 | 1 |
| LCMA630-20-1 | 630 | — | M20 | 34.5 | 63.0 | 28.5 | 27.5 | 131.0 | 22.0 | P125 | 1 |
| LCMA630-00-1* | 630 | — | Blank | 34.5 | 63.0 | — | — | 131.0 | — | P125 | 1 |

‡See page D3.79 for tool and die information.

*UL Recognized only.

**Consult cable manufacturer for voltage stress relief instructions with applications greater than 2000 V.

A.
System
Overview

B1.
Cable Ties

B2.
Cable
Accessories

B3.
Stainless
Steel Ties

C1.
Wiring
Duct

C2.
Surface
Raceway

C3.
Abrasion
Protection

C4.
Cable
Management

D1.
Terminals

D2.
Power
Connectors

D3.
Grounding
Connectors

E1.
Labeling
Systems

E2.
Labels

E3.
Pre-Printed
& Write-On
Markers

E4.
Permanent
Identification

E5.
Lockout/
Tagout
& Safety
Solutions

F.
Index

A. System Overview

B1. Cable Ties

B2. Cable Accessories

B3. Stainless Steel Ties

C1. Wiring Duct

C2. Surface Raceway

C3. Abrasion Protection

C4. Cable Management

D1. Terminals

D2. Power Connectors

D3. Grounding Connectors

E1. Labeling Systems

E2. Labels

E3. Pre-Printed & Write-On Markers

E4. Permanent Identification

E5. Lockout/Tagout & Safety Solutions

F. Index



Metric Conductor, Two-Hole, Standard Barrel with Window Lug

For Use with Class 2 Stranded Copper Conductors

Type LCMD

- Inspection window to visually assure full conductor insertion
- Tin-plated to inhibit corrosion
- UL Listed, UL Recognized, and CSA Certified to 35 KV** and temperature rated to 90°C when crimped with *PANDUIT* tools and dies
- Product information marked on connector for selection and installation
- Internally beveled wire entry for fast and easy installation

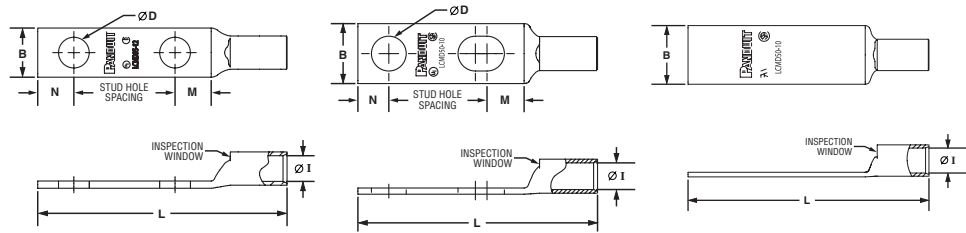

| Part Number | Copper Conductor Size Class 2 (mm ²) | Current Rating (Amps) | Stud Hole Size (mm) | Stud Hole Spacing (In.) | Figure Dimensions (mm) | | | | | | PANDUIT Die Index No.‡ | Std. Pkg. Qty. |
|----------------|--|-----------------------|---------------------|-------------------------|------------------------|------|------|------|-------|------|------------------------|----------------|
| | | | | | ØI | B | M | N | L | ØD | | |
| LCMD6-5CD-Q* | 4 – 6 | 30 | M5 | 22.0 – 25.0 | 3.8 | 10.0 | 7.8 | 6.2 | 52.5 | 5.5 | P10 | 25 |
| LCMD10-6CD-Q | 10 | — | M6 | 22.0 – 25.0 | 4.5 | 11.0 | 9.8 | 6.0 | 55.8 | 6.6 | P21 | 25 |
| LCMD10-8-Q | 10 | — | M8 | 44.5 | 4.5 | 13.0 | 8.5 | 8.0 | 75.3 | 9.0 | P21 | 25 |
| LCMD10-00-Q* | 10 | 90 | Blank | — | 4.4 | 14.5 | — | — | 75.3 | — | P21 | 25 |
| LCMD16-6CD-Q* | 16 | 65 | M6 | 22.0 – 25.0 | 5.5 | 13.0 | 10.3 | 6.5 | 59.5 | 6.6 | P24 | 25 |
| LCMD16-8-Q* | 16 | 65 | M8 | 44.5 | 5.5 | 13.0 | 10.3 | 6.5 | 79.0 | 9.0 | P24 | 25 |
| LCMD16-00-Q* | 16 | 65 | Blank | — | 5.5 | 15.0 | — | — | 81.2 | — | P24 | 25 |
| LCMD25-8CD-Q* | 25 | — | M8 | 22.0 – 25.0 | 6.9 | 15.5 | 10.0 | 8.0 | 62.0 | 9.0 | P29 | 25 |
| LCMD25-8-Q | 25 | — | M8 | 44.5 | 6.9 | 15.5 | 10.0 | 8.0 | 81.5 | 9.0 | P29 | 25 |
| LCMD25-10-Q | 25 | — | M10 | 44.5 | 6.9 | 15.5 | 10.0 | 8.0 | 81.5 | 11.0 | P29 | 25 |
| LCMD25-12-Q | 25 | — | M12 | 44.5 | 6.9 | 18.0 | 14.5 | 11.5 | 89.5 | 14.0 | P29 | 25 |
| LCMD25-00-Q* | 25 | — | Blank | — | 7.1 | 20.0 | — | — | 89.5 | — | P29 | 25 |
| LCMD35-8CD-Q | 35 | — | M8 | 22.0 – 25.0 | 8.2 | 15.5 | 12.3 | 8.5 | 67.0 | 9.0 | P33 | 25 |
| LCMD35-10-Q | 35 | — | M10 | 44.5 | 8.2 | 15.5 | 12.3 | 8.5 | 86.5 | 11.0 | P33 | 25 |
| LCMD35-12-Q | 35 | — | M12 | 44.5 | 8.2 | 21.5 | 14.5 | 11.5 | 92.5 | 14.0 | P33 | 25 |
| LCMD35-00-Q* | 35 | — | Blank | — | 8.2 | 21.5 | — | — | 92.5 | — | P33 | 25 |
| LCMD50-10CD-X | 50 | — | M10 | 22.0 – 25.0 | 9.8 | 18.0 | 11.5 | 10.0 | 71.5 | 11.0 | P42 | 10 |
| LCMD50-10-X | 50 | — | M10 | 44.5 | 9.8 | 18.0 | 11.5 | 10.0 | 91.0 | 11.0 | P42 | 10 |
| LCMD50-12-X | 50 | — | M12 | 44.5 | 9.8 | 23.0 | 14.0 | 11.0 | 94.5 | 14.0 | P42 | 10 |
| LCMD50-00-X* | 50 | — | Blank | — | 9.8 | 23.0 | — | — | 94.5 | — | P42 | 10 |
| LCMD70-10CD-X | 70 | — | M10 | 22.0 – 25.0 | 11.5 | 20.5 | 14.5 | 11.0 | 78.5 | 11.0 | P45 | 10 |
| LCMD70-10-X | 70 | — | M10 | 44.5 | 11.5 | 20.8 | 14.5 | 11.5 | 98.0 | 11.0 | P45 | 10 |
| LCMD70-12-X | 70 | — | M12 | 44.5 | 11.5 | 20.8 | 14.5 | 11.5 | 98.0 | 14.0 | P45 | 10 |
| LCMD70-00-X* | 70 | — | Blank | — | 11.5 | 20.8 | — | — | 98.0 | — | P45 | 10 |
| LCMD95-10CD-X | 95 | — | M10 | 22.0 – 25.0 | 13.5 | 24.5 | 15.0 | 13.0 | 85.5 | 11.0 | P54 | 10 |
| LCMD95-12-X | 95 | — | M12 | 44.5 | 13.5 | 24.5 | 15.0 | 13.5 | 105.0 | 14.0 | P54 | 10 |
| LCMD95-14-X | 95 | — | M14 | 44.5 | 13.5 | 24.5 | 15.0 | 13.5 | 105.0 | 16.0 | P54 | 10 |
| LCMD95-00-X* | 95 | — | Blank | — | 13.5 | 24.5 | — | — | 105.0 | — | P54 | 10 |
| LCMD120-10CD-X | 120 | — | M10 | 22.0 – 25.0 | 15.2 | 27.5 | 15.5 | 14.0 | 90.0 | 11.0 | P62 | 10 |
| LCMD120-12-X | 120 | — | M12 | 44.5 | 15.2 | 27.5 | 15.5 | 14.5 | 109.5 | 14.0 | P62 | 10 |
| LCMD120-14-X | 120 | — | M14 | 44.5 | 15.2 | 27.5 | 15.5 | 14.5 | 109.5 | 16.0 | P62 | 10 |
| LCMD120-00-X* | 120 | — | Blank | — | 15.2 | 27.5 | — | — | 109.5 | — | P62 | 10 |
| LCMD150-10CD-X | 150 | — | M10 | 22.0 – 25.0 | 16.5 | 30.5 | 18.0 | 16.0 | 95.5 | 11.0 | P66 | 10 |
| LCMD150-12-X | 150 | — | M12 | 44.5 | 16.5 | 30.5 | 18.0 | 16.5 | 115.0 | 14.0 | P66 | 10 |
| LCMD150-14-X | 150 | — | M14 | 44.5 | 16.5 | 30.5 | 22.0 | 16.5 | 118.5 | 16.0 | P66 | 10 |
| LCMD150-00-X* | 150 | — | Blank | — | 16.5 | 30.5 | — | — | 118.5 | — | P66 | 10 |

‡See page D3.79 for tool and die information.

*UL Recognized only.

**Consult cable manufacturer for voltage stress relief instructions with applications greater than 2000 V.



Metric Conductor, Two-Hole, Standard Barrel with Window Lug (continued)



| Part Number | Copper Conductor Size Class 2 (mm ²) | Current Rating (Amps) | Stud Hole Size (mm) | Stud Hole Spacing (In.) | Figure Dimensions (mm) | | | | | | PANDUIT Die Index No.‡ | Std. Pkg. Qty. |
|----------------|--|-----------------------|---------------------|-------------------------|------------------------|------|------|------|-------|------|------------------------|----------------|
| | | | | | ØI | B | M | N | L | ØD | | |
| LCMD185-10CD-X | 185 | — | M10 | 22.0 – 25.0 | 18.6 | 33.5 | 16.5 | 17.0 | 97.5 | 11.0 | P76 | 10 |
| LCMD185-12-X | 185 | — | M12 | 44.5 | 18.6 | 33.5 | 16.5 | 17.5 | 117.0 | 14.0 | P76 | 10 |
| LCMD185-14-X | 185 | — | M14 | 44.5 | 18.6 | 33.5 | 21.0 | 17.5 | 121.5 | 16.0 | P76 | 10 |
| LCMD185-00-X* | 185 | — | Blank | — | 18.6 | 33.5 | — | — | 121.5 | — | P76 | 10 |
| LCMD240-10CD-5 | 240 | — | M10 | 22.0 – 25.0 | 20.8 | 37.5 | 21.0 | 19.0 | 111.5 | 11.0 | P87 | 5 |
| LCMD240-12-5 | 240 | — | M12 | 44.5 | 20.8 | 37.5 | 21.0 | 19.5 | 131.0 | 14.0 | P87 | 5 |
| LCMD240-14-5 | 240 | — | 14 | 44.5 | 20.8 | 37.5 | 21.0 | 19.5 | 131.0 | 16.0 | P87 | 5 |
| LCMD240-00-5* | 240 | — | Blank | — | 20.8 | 37.5 | — | — | 131.0 | — | P87 | 5 |
| LCMD300-12-5 | 300 | — | M12 | 44.5 | 23.5 | 42.5 | 22.0 | 20.0 | 139.0 | 14.0 | P94 | 5 |
| LCMD300-14-5 | 300 | — | M14 | 44.5 | 23.5 | 42.5 | 22.0 | 20.0 | 139.0 | 16.0 | P94 | 5 |
| LCMD300-00-5* | 300 | — | Blank | — | 23.5 | 42.5 | — | — | 139.0 | — | P94 | 5 |
| LCMD400-12-5 | 400 | — | M12 | 44.5 | 27.0 | 49.5 | 26.5 | 23.5 | 151.5 | 14.0 | P106 | 5 |
| LCMD400-14-5 | 400 | — | M14 | 44.5 | 27.0 | 49.5 | 26.5 | 23.5 | 151.5 | 16.0 | P106 | 5 |
| LCMD400-16-5 | 400 | — | M16 | 44.5 | 27.0 | 49.5 | 26.5 | 23.5 | 151.5 | 18.0 | P106 | 5 |
| LCMD400-00-5* | 400 | — | Blank | — | 27.0 | 49.5 | — | — | 151.5 | — | P106 | 5 |
| LCMD500-12-1 | 500 | — | M12 | 44.5 | 31.0 | 57.5 | 28.5 | 25.5 | 164.5 | 14.0 | P125 | 1 |
| LCMD500-14-1 | 500 | — | M14 | 44.5 | 31.0 | 57.5 | 28.5 | 25.5 | 164.5 | 16.0 | P125 | 1 |
| LCMD500-16-1 | 500 | — | M16 | 44.5 | 31.0 | 57.5 | 28.5 | 25.5 | 164.5 | 18.0 | P125 | 1 |
| LCMD500-00-1* | 500 | — | Blank | — | 31.0 | 57.5 | — | — | 164.5 | — | P125 | 1 |
| LCMD630-12-1 | 630 | — | M12 | 44.5 | 34.5 | 63.0 | 28.5 | 27.5 | 175.5 | 14.0 | P125 | 1 |
| LCMD630-14-1 | 630 | — | M14 | 44.5 | 34.5 | 63.0 | 28.5 | 27.5 | 175.5 | 16.0 | P125 | 1 |
| LCMD630-16-1 | 630 | — | M16 | 44.5 | 34.5 | 63.0 | 28.5 | 27.5 | 175.5 | 18.0 | P125 | 1 |
| LCMD630-00-1* | 630 | — | Blank | — | 34.5 | 63.0 | — | — | 175.5 | — | P125 | 1 |

‡See page D3.79 for tool and die information.

*UL Recognized only.

**Consult cable manufacturer for voltage stress relief instructions with applications greater than 2000 V.

A. System Overview

B1. Cable Ties

B2. Cable Accessories

B3. Stainless Steel Ties

C1. Wiring Duct

C2. Surface Raceway

C3. Abrasion Protection

C4. Cable Management

D1. Terminals

D2. Power Connectors

D3. Grounding Connectors

E1. Labeling Systems

E2. Labels

E3. Pre-Printed & Write-On Markers

E4. Permanent Identification

E5. Lockout/Tagout & Safety Solutions

F. Index

A.
System
Overview



Metric Conductor, Standard Barrel, Butt Splice

For Use with Class 2 Stranded Copper Conductors

B1.
Cable Ties

Type SCMS

- Tin-plated to inhibit corrosion
- UL Listed, UL Recognized, and CSA Certified to 35 KV** and temperature rated to 90°C when crimped with *PANDUIT* tools and dies
- Product information marked on connector for selection and installation
- Internally beveled wire entry for fast and easy installation

B2.
Cable
Accessories

B3.
Stainless
Steel Ties

C1.
Wiring
Duct

C2.
Surface
Raceway

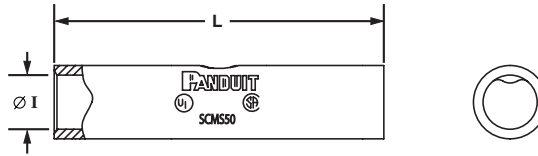

C3.
Abrasion
Protection

C4.
Cable
Management

| Part Number | Copper Conductor Size Class 2 (mm ²) | Current Rating (Amps) | Figure Dimensions (mm) | | PANDUIT Die Index No.‡ | Std. Pkg. Qty. |
|-------------|--|-----------------------|------------------------|-------|------------------------|----------------|
| | | | ØI | L | | |
| SCMS10-C | 10 | — | 4.5 | 30.0 | P21 | 100 |
| SCMS16-C* | 16 | 65 | 5.5 | 35.0 | P24 | 100 |
| SCMS25-L | 25 | — | 6.9 | 36.0 | P29 | 50 |
| SCMS35-L | 35 | — | 8.2 | 36.0 | P33 | 50 |
| SCMS50-L | 50 | — | 9.8 | 49.0 | P42 | 50 |
| SCMS70-L | 70 | — | 11.5 | 52.0 | P45 | 50 |
| SCMS95-Q | 95 | — | 13.5 | 54.0 | P54 | 25 |
| SCMS120-Q | 120 | — | 15.2 | 57.0 | P62 | 25 |
| SCMS150-X | 150 | — | 16.5 | 57.0 | P66 | 10 |
| SCMS185-X | 185 | — | 18.6 | 61.0 | P76 | 10 |
| SCMS240-X | 240 | — | 20.8 | 72.0 | P87 | 10 |
| SCMS300-5 | 300 | — | 23.5 | 75.0 | P94 | 5 |
| SCMS400-5 | 400 | — | 27.0 | 95.0 | P106 | 5 |
| SCMS500-6 | 500 | — | 31.0 | 96.0 | P125 | 6 |
| SCMS630-6 | 630 | — | 34.5 | 131.0 | P125 | 6 |

‡See page D3.79 for tool and die information.

*UL Recognized only.

**Consult cable manufacturer for voltage stress relief instructions with applications greater than 2000 V.

E1.
Labeling
Systems

E2.
Labels

E3.
Pre-Printed
& Write-On
Markers

E4.
Permanent
Identification

E5.
Lockout/
Tagout/
& Safety
Solutions

F.
Index

PANDUIT Custom Copper Compression Lugs for Special Applications

Manufactured to meet your special dimensional specifications and requirements

PANDUIT has incorporated manufacturing processes that permit custom lug capabilities with premium two day or standard two week delivery. PANDUIT offers a wide variety of dimensional choices for #8 AWG to 250 kcmil copper code lugs and #8 AWG to 4/0 AWG copper flex lugs.

Options:

Tongues

- Straight or bent
- Stacking
- Special lengths

Stud Holes

- Various sizes, #10 to 1/2"
- Multiple hole sizes and spacing
- Special locations

Barrels

- Three standard lengths: short, standard, and long
- Custom lengths

With Dependable PANDUIT Service

- Excellent quality
- Fast delivery
- Low minimum order quantities
- Competitive prices

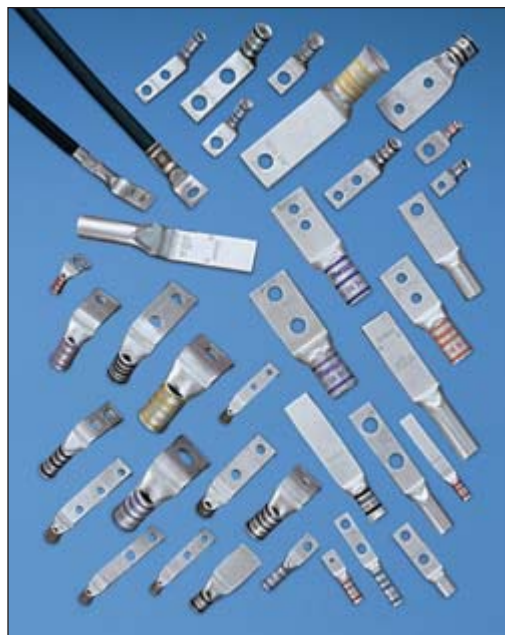

A.
System
Overview

B1.
Cable Ties

B2.
Cable
Accessories

B3.
Stainless
Steel Ties

C1.
Wiring
Duct

C2.
Surface
Raceway

C3.
Abrasion
Protection

C4.
Cable
Management

D1.
Terminals

D2.
Power
Connectors

D3.
Grounding
Connectors

E1.
Labeling
Systems

E2.
Labels

E3.
Pre-Printed
& Write-On
Markers

E4.
Permanent
Identification

E5.
Lockout/
Tagout
& Safety
Solutions

F.
Index

Custom Lugs Spec Sheet Instructions

Use these instructions to design your own custom lugs. Fill in the Custom Lugs Preliminary Spec Sheet to place your custom lugs order. You can copy the sheet from page D2.115 or download it at www.panduit.com/customlugs.

- Fill out this section completely.
 - Check the conductor size and type (code or flex). Fill in the strand designation and type for flex conductor.
 - Check a barrel length. Refer to Chart "A" for standard barrel length dimensions. If the length you require is not listed, fill in the special box with your required length.
 - Check "YES" if an inspection window is required; check "NO" if it is not required.
 - Check the barrel end type you require.
 - Check a stud size and tongue style (one-hole, two-hole, or blank). Refer to Chart "A" and Chart "B" for standard tongue dimensions. If you require tongue dimensions other than those listed, fill in the box that corresponds to the feature that requires a special dimension. You must fill in a hole spacing on two-hole lugs and tongue length on blank tongue lugs.
- Note: Steps 7 and 8 are for bent or stacking lugs ONLY.**
- Check the stacking lug you require. If both upper and lower lugs are required, check "both" (two drawings will be provided). If you choose a bent stacking lug, fill in the required angle.
 - Check the bent lug you require. If you check "special angle", fill in the required angle.
 - Check the special options you require. Fill in any blank lines that correspond to the option you've selected.
 - Fax or mail the completed spec sheet to PANDUIT Corp. Phone/fax numbers are listed on the bottom of the Custom Lugs Preliminary Spec Sheet (see page D2.115 or go to www.panduit.com/customlugs). PANDUIT will send drawings for your approval.

Chart "A"

| Code Conductor Size | Flex Conductor Size | Barrel | | Barrel Length | | | Tongue Width | | | | |
|---------------------|---------------------|--------|------|---------------|----------|------|-------------------|-----|------|-----|-----|
| | | I.D. | O.D. | Short | Standard | Long | Nominal Stud Size | | | | |
| | | | | | | | #10 | 1/4 | 5/16 | 3/8 | 1/2 |
| #8 | — | .18 | .27 | .42 | .56 | .70 | .41 | .48 | .56 | .60 | — |
| #6 | #6 AWG | .22 | .31 | .48 | .81 | 1.07 | .45 | .48 | .56 | .62 | — |
| #4 | #4 AWG | .28 | .38 | .53 | .81 | 1.05 | .55 | | .62 | — | |
| #2 | — | .31 | .42 | .57 | .88 | 1.16 | .60 | | .66 | .75 | |
| #1 | #2 AWG | .36 | .47 | .59 | .88 | 1.36 | .70 | | | .75 | |
| 1/0 | #1 AWG | .39 | .52 | .66 | .94 | 1.44 | .76 | | | .80 | |
| 2/0 | 1/0 AWG | .45 | .58 | .72 | .98 | 1.50 | .85 | | | | |
| 3/0 | 2/0 AWG | .51 | .64 | .83 | 1.14 | 1.50 | .96 | | | | |
| 4/0 | 3/0 AWG | .57 | .71 | .91 | 1.19 | 1.56 | 1.06 | | | | |
| 250 | 4/0 AWG | .63 | .77 | 1.03 | 1.25 | 1.61 | 1.17 | | | | |

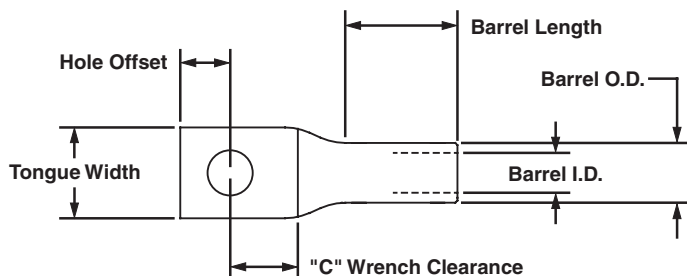





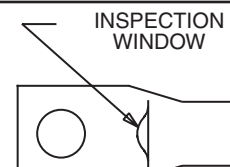



Chart "B"

| Nominal Stud Size | Actual Hole Size | Minimum Hole Offset | Minimum "C" Wrench Size |
|-------------------|------------------|---------------------|-------------------------|
| #10 | .20 | .23 | .31 |
| 1/4" | .27 | .25 | .38 |
| 5/16" | .34 | .32 | .38 |
| 3/8" | .41 | .38 | .44 |
| 1/2" | .53 | .50 | .56 |
| 5/8" | .69 | .63 | .69 |
| 3/4" | .81 | .75 | .75 |

Custom Lugs Preliminary Spec Sheet



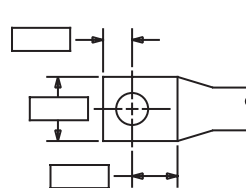
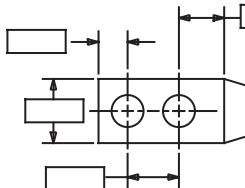
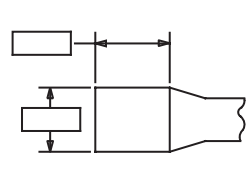

Photocopy this form to place your order. This form is also available at www.panduit.com/customlugs.
Mail or fax the photocopy to receive drawings and quotation. Place your order through your local PANDUIT distributor.

| | | | |
|---------------------------|--|---|--|
| 1 CUSTOMER PROFILE | | | |
| Company Name _____ | | City/State _____ | |
| Address _____ | | | |
| Your Name _____ | | Phone Number _____ | |
| Fax Number _____ | | Quantity Required _____ Delivery Date _____ | |

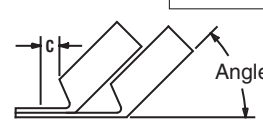
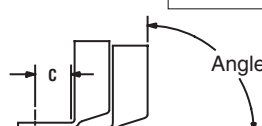
| | | | |
|---|--|--|--|
| 2 CONDUCTOR <input type="checkbox"/> #8 <input type="checkbox"/> #6 <input type="checkbox"/> #4 <input type="checkbox"/> #2 <input type="checkbox"/> #1 <input type="checkbox"/> 1/0 <input type="checkbox"/> 2/0 <input type="checkbox"/> 3/0 <input type="checkbox"/> 4/0 <input type="checkbox"/> 250 kcmil <input type="checkbox"/> Special <hr/> <input type="checkbox"/> Code <input type="checkbox"/> Flex { Strands _____ Type _____ | 3 BARREL LENGTH <input type="checkbox"/>  SHORT <input type="checkbox"/>  STANDARD <input type="checkbox"/>  LONG <input type="checkbox"/>  SPECIAL | 4 INSPECTION WINDOW  <input type="checkbox"/> YES <input type="checkbox"/> NO | 5 BARREL END TYPE <input type="checkbox"/>  STANDARD <input type="checkbox"/>  CORONA RELIEF <input type="checkbox"/>  FLARED |
|---|--|--|--|

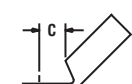
| | | | |
|---|--|---|---|
| 6 TONGUE SPECIFICATIONS (Standard Dimensions apply to boxes left blank – See Charts “A” and “B”) | | | |
| Stud Sizes <input type="checkbox"/> #10 <input type="checkbox"/> 1/4 <input type="checkbox"/> 5/16 <input type="checkbox"/> 3/8 <input type="checkbox"/> 1/2 <input type="checkbox"/> Other _____ | <input type="checkbox"/>  <input type="checkbox"/> One-Hole | <input type="checkbox"/>  <input type="checkbox"/> Two-Hole | <input type="checkbox"/>  <input type="checkbox"/> Blank |

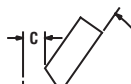
| | | | |
|--|---|--|--|
| 7 STACKING LUG SELECTION (If not needed – proceed to Step 8) | | | |
| Lugs With 0° to 45° Angles | | | |
| <input type="checkbox"/> Upper Bent _____ Angle  <input type="checkbox"/> Both <input type="checkbox"/> Lower Bent _____ Angle | <input type="checkbox"/> Upper Bent _____ Angle  <input type="checkbox"/> Lower Bent _____ Angle | | |

| | | | |
|--|--|--|--|
| 8 BENT LUG SELECTION (If not needed – proceed to Step 9) | | | |
| <input type="checkbox"/>  45° <input type="checkbox"/>  90° | <input type="checkbox"/> SPECIAL ANGLE _____ <input type="checkbox"/> SPECIAL ANGLE _____ | <input type="checkbox"/>  45° <input type="checkbox"/>  90° | |

| | |
|---|--------------------------------------|
| 9 SPECIAL OPTIONS FEATURES | |
| <input type="checkbox"/> Part I.D. on Tongue | <input type="checkbox"/> PANDUIT P/N |
| Custom P/N: _____ | |
| <input type="checkbox"/> No Barrel Markings | |
| <input type="checkbox"/> Special Plating (TIN STD): _____ | |
| <input type="checkbox"/> Special Packaging _____ | |
| <input type="checkbox"/> Other _____ | |

| | |
|---|--|
| 10 FAX DIRECTIONS | |
| Fax to PANDUIT Corp. PHONE: 888-506-5400 Ext. 2241 FAX: 815-485-5839 ATTN: Product Management | |
| CONTACT FACTORY FOR MINIMUM ORDER | |

A. System Overview

B1. Cable Ties

B2. Cable Accessories

B3. Stainless Steel Ties

C1. Wiring Duct

C2. Surface Raceway

C3. Abrasion Protection

C4. Cable Management

D1. Terminals

D2. Power Connectors

D3. Grounding Connectors

E1. Labeling Systems

E2. Labels

E3. Pre-Printed & Write-On Markers

E4. Permanent Identification

E5. Lockout/Tagout & Safety Solutions

F. Index

A. System Overview

B1. Cable Ties

B2. Cable Accessories

B3. Stainless Steel Ties

C1. Wiring Duct

C2. Surface Raceway

C3. Abrasion Protection

C4. Cable Management

D1. Terminals

D2. Power Connectors

D3. Grounding Connectors

E1. Labeling Systems

E2. Labels

E3. Pre-Printed & Write-On Markers

E4. Permanent Identification

E5. Lockout/Tagout & Safety Solutions

F. Index

UL LISTED SB CERTIFIED Code Conductor, One-Hole, Aluminum Lug

For Use with Stranded Aluminum or Copper Code Conductors

Type LAA

- Manufactured from high conductivity thick wall wrought aluminum
- Enclosed barrel prevents corrosive material from entering barrel when used in harsh environments
- Factory pre-filled with joint compound and sealed with easy pull-out end plug to inhibit corrosion
- Tin-plated to inhibit corrosion
- Color-coded end plug and *PANDUIT* and specified competitor die index numbers marked on barrel for proper crimp die selection
- UL Listed and CSA Certified to 35 KV** and temperature rated to 90°C when crimped with *PANDUIT* and specified competitor crimping tools and dies

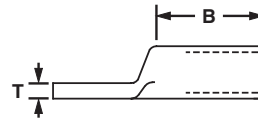
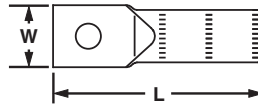

| Part Number | Aluminum or Copper Conductor Size | Stud Hole Size (In.) | Figure Dimensions (In.) | | | | PANDUIT Color Code | PANDUIT Die Index No.‡ | Burdny Die Index No.‡ | T&B Die Index No.‡ | Wire Strip Length (In.) | Std. Pkg. Qty. |
|--------------|-----------------------------------|----------------------|-------------------------|------|------|-------|--------------------|------------------------|-----------------------|--------------------|-------------------------|----------------|
| | | | W | B | T | L | | | | | | |
| LAA6-14-X | #6 AWG | 1/4 | .55 | .86 | .11 | 2.20 | Gray | P29 | 346 | 29 | 1 | 10 |
| LAA6-56-X | | 5/16 | .55 | 1.00 | .11 | 2.20 | Gray | P29 | 346 | 29 | 1 | 10 |
| LAA4-14-X | #4 AWG | 1/4 | .66 | 1.05 | .19 | 2.05 | Green | P37 | 375 | 37 | 1 1/16 | 10 |
| LAA4-56-X | | 5/16 | .69 | 1.08 | .16 | 2.23 | Green | P37 | 375 | 37 | 1 1/16 | 10 |
| LAA4-38-X | #2 AWG | 3/8 | .69 | .92 | .16 | 2.33 | Green | P37 | 375 | 37 | 1 1/16 | 10 |
| LAA2-14-X | | 1/4 | .75 | .98 | .17 | 2.63 | Pink | P42 | 348 | 42 | 1 | 10 |
| LAA2-56-X | 5/16 | .75 | .98 | .17 | 2.63 | Pink | P42 | 348 | 42 | 1 | 10 | |
| LAA2-38-X | #1 AWG | 3/8 | .75 | .98 | .17 | 2.63 | Pink | P42 | 348 | 42 | 1 | 10 |
| LAA1-14-X | | 1/4 | .75 | .98 | .17 | 2.63 | Gold | P45 | 471 | 45 | 1 | 10 |
| LAA1-56-X | 5/16 | .75 | .98 | .17 | 2.63 | Gold | P45 | 471 | 45 | 1 | 10 | |
| LAA1-38-X | 1/0 AWG | 3/8 | .75 | .98 | .17 | 2.63 | Gold | P45 | 471 | 45 | 1 | 10 |
| LAA1/0-56-X | | 5/16 | .88 | 1.30 | .25 | 3.23 | Tan | P50 | 296 | 50 | 1 9/16 | 10 |
| LAA1/0-38-X | 3/8 | .88 | 1.30 | .25 | 3.23 | Tan | P50 | 296 | 50 | 1 9/16 | 10 | |
| LAA1/0-12-X | 2/0 AWG | 1/2 | .88 | 1.30 | .25 | 3.23 | Tan | P50 | 296 | 50 | 1 9/16 | 10 |
| LAA2/0-38-5 | | 3/8 | .95 | 1.31 | .23 | 3.19 | Olive | P54 | 297 | 54 | 1 9/16 | 5 |
| LAA2/0-12-5 | 1/2 | .95 | 1.30 | .23 | 3.19 | Olive | P54 | 297 | 54 | 1 9/16 | 5 | |
| LAA3/0-38-5 | 3/0 AWG | 3/8 | 1.07 | 1.50 | .25 | 3.44 | Ruby | P60 | 467 | 60 | 1 9/16 | 5 |
| LAA3/0-12-5 | | 1/2 | 1.07 | 1.50 | .25 | 3.44 | Ruby | P60 | 467 | 60 | 1 9/16 | 5 |
| LAA4/0-38-5 | 4/0 AWG | 3/8 | 1.19 | 1.44 | .32 | 3.56 | White | P66 | 298 | 66 | 1 3/4 | 5 |
| LAA4/0-12-5 | | 1/2 | 1.19 | 1.44 | .32 | 3.56 | White | P66 | 298 | 66 | 1 3/4 | 5 |
| LAA250-38-5 | 250 kcmil | 3/8 | 1.24 | 1.56 | .30 | 3.63 | Red | P71 | 324 | 71 | 1 9/16 | 5 |
| LAA250-12-5 | | 1/2 | 1.24 | 1.56 | .30 | 3.63 | Red | P71 | 324 | 71 | 1 9/16 | 5 |
| LAA300-38-2 | 300 kcmil | 3/8 | 1.38 | 2.25 | .34 | 4.05 | Blue | P76 | 470 | 76 | 2 5/16 | 2 |
| LAA300-12-2 | | 1/2 | 1.38 | 2.25 | .34 | 4.05 | Blue | P76 | 470 | 76 | 2 5/16 | 2 |
| LAA350-12-2 | 350 kcmil | 1/2 | 1.50 | 2.25 | .38 | 4.30 | Brown | P87 | 299 | 87 | 2 5/16 | 2 |
| LAA400-58-2 | 400 kcmil | 5/8 | 1.61 | 2.50 | .41 | 4.92 | Green | P94 | 472 | 94 | 2 9/16 | 2 |
| LAA500-12-2 | 500 kcmil | 1/2 | 1.75 | 3.00 | .44 | 5.56 | Pink | P99 | 300 | 99 | 3 1/16 | 2 |
| LAA500-58-2 | | 5/8 | 1.75 | 3.00 | .44 | 5.56 | Pink | P99 | 300 | 99 | 3 1/16 | 2 |
| LAA750-58-1 | 750 kcmil | 5/8 | 1.75 | 3.38 | .53 | 6.55 | Red | P125 | 301 | 115 | 3 7/16 | 1 |
| LAA1000-58-1 | 1000 kcmil | 5/8 | 2.56 | 4.50 | .61 | 7.38 | Brown | P161 | 302 | 161 | 4 3/4 | 1 |

‡See pages D3.80, D3.81 for tool and die information.

**Consult cable manufacturer for voltage stress relief instructions with applications greater than 2000 V.

See page D2.123 for *PANDUIT* joint compounds recommended for pad to pad and conductor connections.



Code Conductor, Two-Hole, Aluminum Lug

For Use with Stranded Aluminum or Copper Code Conductors

Type LAB

- Manufactured from high conductivity thick wall wrought aluminum
- Factory pre-filled with joint compound and sealed with easy pull-out end plug to inhibit corrosion
- Color-coded end plug and *PANDUIT* and specified competitor die index numbers marked on barrel for proper crimp die selection
- Enclosed barrel prevents corrosive material from entering barrel when used in harsh environments
- Tin-plated to inhibit corrosion
- UL Listed and CSA Certified to 35 KV** and temperature rated to 90°C when crimped with *PANDUIT* and specified competitor crimping tools and dies
- Available with NEMA hole sizes and spacing

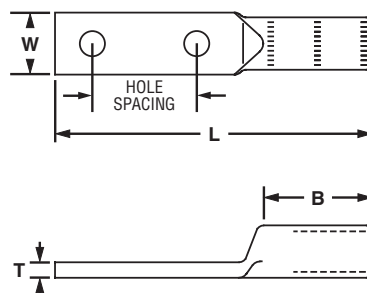

| Part Number | Aluminum or Copper Conductor Size | Stud Hole Size (In.) | Stud Hole Spacing (In.) | Figure Dimensions (In.) | | | | PANDUIT Color Code | PANDUIT Die Index No.‡ | Burdny Die Index No.‡ | T&B Die Index No.‡ | Wire Strip Length (In.) | Std. Pkg. Qty. |
|----------------|-----------------------------------|----------------------|-------------------------|-------------------------|------|-----|------|--------------------|------------------------|-----------------------|--------------------|-------------------------|----------------|
| | | | | W | B | T | L | | | | | | |
| LAB1/0-38-X | 1/0 AWG | 3/8 | 1.75 | .88 | 1.55 | .25 | 5.33 | Tan | P50 | 296 | 50 | 1 9/16 | 10 |
| ◆ LAB2/0-12-5 | 2/0 AWG | 1/2 | 1.75 | .94 | 1.55 | .27 | 5.55 | Olive | P54 | 297 | 54 | 1 9/16 | 5 |
| ◆ LAB3/0-12-5 | 3/0 AWG | 1/2 | 1.75 | 1.03 | 1.55 | .27 | 5.55 | Ruby | P60 | 467 | 60 | 1 9/16 | 5 |
| ◆ LAB4/0-12-5 | 4/0 AWG | 1/2 | 1.75 | 1.19 | 1.80 | .31 | 5.98 | White | P66 | 298 | 66 | 1 3/4 | 5 |
| ◆ LAB250-12-5 | 250 kcmil | 1/2 | 1.75 | 1.25 | 1.80 | .31 | 6.05 | Red | P71 | 324 | 71 | 1 3/4 | 5 |
| ◆ LAB300-12-2 | 300 kcmil | 1/2 | 1.75 | 1.36 | 2.30 | .34 | 6.61 | Blue | P76 | 470 | 76 | 2 5/16 | 2 |
| ◆ LAB350-12-2 | 350 kcmil | 1/2 | 1.75 | 1.50 | 2.30 | .38 | 6.61 | Brown | P87 | 299 | 87 | 2 5/16 | 2 |
| ◆ LAB400-12-2 | 400 kcmil | 1/2 | 1.75 | 1.66 | 2.55 | .38 | 6.92 | Green | P94 | 472 | 94 | 2 9/16 | 2 |
| ◆ LAB500-12-2 | 500 kcmil | 1/2 | 1.75 | 1.72 | 3.05 | .44 | 7.36 | Pink | P99 | 300 | 99 | 3 1/16 | 2 |
| ◆ LAB600-12-2 | 600 kcmil | 1/2 | 1.75 | 1.72 | 3.05 | .50 | 7.55 | Black | P106 | 473 | 106 | 3 1/16 | 2 |
| ◆ LAB750-12-1 | 750 kcmil | 1/2 | 1.75 | 1.72 | 3.42 | .56 | 8.30 | Red | P125 | 301 | 115 | 3 7/16 | 1 |
| ◆ LAB800-12-1 | 800 kcmil | 1/2 | 1.75 | 1.72 | 3.42 | .59 | 8.30 | Gray | P140 | 474 | 125 | 3 7/16 | 1 |
| ◆ LAB1000-12-1 | 1000 kcmil | 1/2 | 1.75 | 2.56 | 4.67 | .63 | 9.67 | Brown | P161 | 302 | 161 | 4 3/4 | 1 |

‡See pages D3.80, D3.81 for tool and die information.

**Consult cable manufacturer for voltage stress relief instructions with applications greater than 2000 V.

See page D2.123 for *PANDUIT* joint compounds recommended for pad to pad and conductor connections.

◆NEMA hole sizes and spacing.

A. System Overview

B1. Cable Ties

B2. Cable Accessories

B3. Stainless Steel Ties

C1. Wiring Duct

C2. Surface Raceway

C3. Abrasion Protection

C4. Cable Management

D1. Terminals

D2. Power Connectors

D3. Grounding Connectors

E1. Labeling Systems

E2. Labels

E3. Pre-Printed & Write-On Markers

E4. Permanent Identification

E5. Lockout/Tagout & Safety Solutions

F. Index

A.
System
Overview

Belleville Compression Washers

B1.
Cable Ties

Type CW

• Conical spring washer for use when assembling aluminum connectors to copper and/or steel pads, compensates for differing rates of thermal expansion to keep hardware assembly from loosening

- For assembly information, see page D2.164
- Made from hardened steel to provide high strength
- Cadmium-plated to inhibit corrosion

B2.
Cable
Accessories



B3.
Stainless
Steel Ties

C1.
Wiring
Duct

| Part Number | Stud Hole Size (In.) | Figure Dimensions (In.) | | | Std. Pkg. Qty. |
|----------------|----------------------|-------------------------|-----|-----|----------------|
| | | D | H | T | |
| CW-14-L | 1/4 | .68 | .09 | .05 | 50 |
| CW-56-L | 5/16 | .81 | .08 | .06 | 50 |
| CW-38-L | 3/8 | .93 | .10 | .07 | 50 |
| CW-12-Q | 1/2 | 1.18 | .12 | .09 | 25 |
| CW-58-Q | 5/8 | 1.49 | .15 | .12 | 25 |

C2.
Surface
Raceway

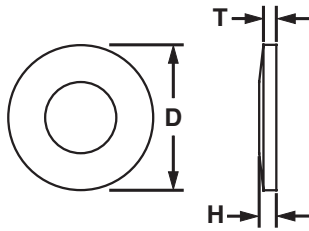

C3.
Abrasion
Protection

C4.
Cable
Management

D1.
Terminals

D2.
Power
Connectors

D3.
Grounding
Connectors

E1.
Labeling
Systems

E2.
Labels

E3.
Pre-Printed
& Write-On
Markers

E4.
Permanent
Identification

E5.
Lockout/
Tagout/
& Safety
Solutions

F.
Index

UL LISTED **CSA CERTIFIED** **Code Conductor, Aluminum Splice**

For Use with Stranded Aluminum-to-Aluminum or Copper-to-Copper Conductors

Type SA

- Manufactured from high conductivity thick wall wrought aluminum
- Factory pre-filled with joint compound and sealed with easy pull-out end plug to inhibit corrosion
- Color-coded end plugs and *PANDUIT* and specified competitor die index numbers marked on barrel for proper crimp die selection
- Tin-plated to inhibit corrosion
- Internal solid center prevents over-insertion of conductor
- UL Listed and CSA Certified to 35 KV** and temperature rated to 90°C when crimped with *PANDUIT* and specified competitor crimping tools and dies

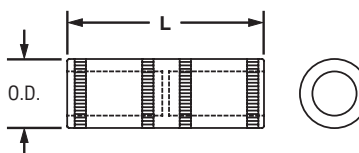

| Part Number | Aluminum or Copper Conductor Size | Figure Dimensions (In.) | | PANDUIT Color Code | PANDUIT Die Index No.‡ | Burndy Die Index No.‡ | T&B Die Index No.‡ | Wire Strip Length (In.) | Std. Pkg. Qty. |
|-------------|-----------------------------------|-------------------------|------|--------------------|------------------------|-----------------------|--------------------|-------------------------|----------------|
| | | Barrel O.D. | L | | | | | | |
| SA6-X | #6 AWG | .34 | 1.62 | Gray | P29 | 346 | 29 | 3/4 | 10 |
| SA4-X | #4 AWG | .48 | 2.13 | Green | P37 | 375 | 37 | 7/8 | 10 |
| SA2-X | #2 AWG | .53 | 2.00 | Pink | P42 | 348 | 45 | 7/16 | 10 |
| SA1-X | #1 AWG | .53 | 2.00 | Gold | P45 | 471 | 45 | 7/16 | 10 |
| SA1/0-X | 1/0 AWG | .64 | 2.12 | Tan | P50 | 296 | 50 | 1 | 10 |
| SA2/0-5 | 2/0 AWG | .69 | 2.31 | Olive | P54 | 297 | 54 | 1 1/8 | 5 |
| SA3/0-5 | 3/0 AWG | .76 | 2.62 | Ruby | P60 | 467 | 60 | 1 1/4 | 5 |
| SA4/0-5 | 4/0 AWG | .88 | 2.75 | White | P66 | 298 | 66 | 1 5/16 | 5 |
| SA250-5 | 250 kcmil | .91 | 2.94 | Red | P71 | 324 | 71 | 1 7/16 | 5 |
| SA300-2 | 300 kcmil | 1.01 | 3.12 | Blue | P76 | 470 | 76 | 1 1/2 | 2 |
| SA350-2 | 350 kcmil | 1.12 | 3.37 | Brown | P87 | 299 | 87 | 1 5/8 | 2 |
| SA400-2 | 400 kcmil | 1.19 | 3.75 | Green | P94 | 472 | 94 | 1 13/16 | 2 |
| SA500-2 | 500 kcmil | 1.32 | 3.87 | Pink | P99 | 300 | 99 | 1 7/8 | 2 |
| SA600-2 | 600 kcmil | 1.44 | 4.12 | Black | P106 | 473 | 106 | 2 | 2 |
| SA750-1 | 750 kcmil | 1.60 | 4.62 | Red | P125 | 301 | 115 | 2 1/4 | 1 |
| SA800-1 | 800 kcmil | 1.66 | 4.75 | Gray | P140 | 474 | 125 | 2 5/16 | 1 |
| SA1000-1 | 1000 kcmil | 1.84 | 5.25 | Brown | P161 | 302 | 161 | 2 9/16 | 1 |

‡See pages D3.80, D3.81 for tool and die information.

**Consult cable manufacturer for voltage stress relief instructions with applications greater than 2000 V.

See page D2.123 for *PANDUIT* joint compounds recommended for pad to pad and conductor connections.

A. System Overview

B1. Cable Ties

B2. Cable Accessories

B3. Stainless Steel Ties

C1. Wiring Duct

C2. Surface Raceway

C3. Abrasion Protection

C4. Cable Management

D1. Terminals

D2. Power Connectors

D3. Grounding Connectors

E1. Labeling Systems

E2. Labels

E3. Pre-Printed & Write-On Markers

E4. Permanent Identification

E5. Lockout/Tagout & Safety Solutions

F. Index

A.
System
Overview

Code Conductor, Aluminum, Reducing Splice

B1.
Cable Ties

For Reducing Stranded Aluminum-to-Aluminum or Aluminum-to-Copper Conductors

Type SAR

B2.
Cable
Accessories

- Dual rated for use with aluminum or copper conductors
- Tin-plated to inhibit corrosion
- Factory pre-filled with joint compound and sealed with easy pull-out end plug to inhibit corrosion
- For use up to 35 KV** and temperature rated 90°C when crimped with *PANDUIT* and specified competitor crimping tools and dies
- Color-coded end plug and *PANDUIT* and specified competitor die index numbers marked on barrel for proper crimp die selection

B3.
Stainless
Steel Ties



C1.
Wiring
Duct

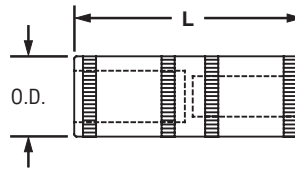

C2.
Surface
Raceway

C3.
Abrasion
Protection

| Part Number | Aluminum Conductor Size From | Aluminum or Copper Conductor Size To | Figure Dimensions (In.) | | PANDUIT Color Code | PANDUIT Die Index No.‡ | Burdny Die Index No.‡ | T&B Die Index No.‡ | Wire Strip Length (In.) | Std. Pkg. Qty. |
|---------------------|------------------------------|--------------------------------------|-------------------------|------|--------------------|------------------------|-----------------------|--------------------|-------------------------|----------------|
| | | | Barrel O.D. | L | | | | | | |
| SAR2-4-X | #2 AWG | #4 AWG | .64 | 4.25 | Tan | P50 | 296 | 50 | 2 1/16 | 10 |
| SAR1/0-2-X | 1/0 AWG | #2 AWG | .64 | 4.25 | Tan | P50 | 296 | 50 | 2 1/16 | 10 |
| SAR3/0-1/0-5 | 3/0 AWG | 1/0 AWG | .91 | 4.98 | Red | P71 | 324 | 71 | 2 5/16 | 5 |
| SAR4/0-2/0-5 | 4/0 AWG | 2/0 AWG | .91 | 5.24 | Red | P71 | 324 | 71 | 2 3/16 | 5 |
| SAR350-4/0-2 | 350 kcmil | 4/0 AWG | 1.12 | 6.63 | Brown | P87 | 299 | 87 | 3 3/16 | 2 |
| SAR500-350-2 | 500 kcmil | 350 kcmil | 1.32 | 8.60 | Pink | P99 | 300 | 99 | 4 1/4 | 2 |
| SAR600-500-2 | 600 kcmil | 500 kcmil | 1.49 | 9.25 | Black | P106 | 473 | 106 | 4 | 2 |
| SAR750-600-2 | 750 kcmil | 600 kcmil | 1.60 | 9.88 | Red | P125 | 301 | 115 | 4 7/16 | 2 |

C4.
Cable
Management

D1.
Terminals

‡See pages D3.82 – D3.83 for tool and die information.

**Consult cable manufacturer for voltage stress relief instructions with applications greater than 2000 V.

See page D2.123 for *PANDUIT* joint compounds recommended for pad to pad and conductor connections.

D2.
Power
Connectors

D3.
Grounding
Connectors

E1.
Labeling
Systems

E2.
Labels

E3.
Pre-Printed
& Write-On
Markers

E4.
Permanent
Identification

E5.
Lockout/
Tagout/
& Safety
Solutions

F.
Index

UL LISTED Code Conductor, Aluminum, Bi-Metallic Pin Connector

Provides Copper Pigtail for Connecting Aluminum Conductors to a Copper or Aluminum/Copper Rated Mechanical Lug

Type BPC

- Factory pre-filled with joint compound and sealed with easy pull-out end plug to inhibit corrosion
- Color-coded end plug and *PANDUIT* die index number marked on barrel for proper crimp die selection
- Insulating rubber sleeve included to insulate aluminum barrel from contact with copper connector when attached to pin
- Tin-plated to inhibit corrosion
- UL Listed per UL 486B; temperature rated 90°C and for use up to 600 V when crimped with *PANDUIT* and specified competitor crimping tools and dies

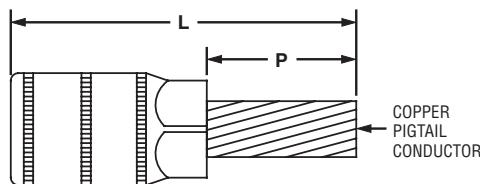

| Part Number | Aluminum Conductor Size | Copper Pigtail Size | Figure Dimensions (In.) | | PANDUIT Color Code | PANDUIT Die Index No.‡ | Burdyn Die Index No.‡ | T&B Die Index No.‡ | Wire Strip Length (In.) | Std. Pkg. Qty. |
|-------------|-------------------------|---------------------|-------------------------|------|--------------------|------------------------|-----------------------|--------------------|-------------------------|----------------|
| | | | L | P | | | | | | |
| BPC6-L | #6 AWG | #8 AWG | 2.45 | .88 | Tan | P50 | 296 | 50 | 1 1/16 | 50 |
| BPC4-L | #4 AWG | #6 AWG | 2.45 | .88 | Tan | P50 | 296 | 50 | 1 1/16 | 50 |
| BPC2-L | #2 AWG | #4 AWG | 2.45 | .88 | Tan | P50 | 296 | 50 | 1 1/16 | 50 |
| BPC1-X | #1 AWG | #3 AWG | 2.58 | 1.00 | Tan | P50 | 296 | 50 | 1 1/16 | 10 |
| BPC1/0-X | 1/0 AWG | #2 AWG | 3.33 | 1.25 | Red | P71 | 298 | 76 | 1 5/16 | 10 |
| BPC2/0-X | 2/0 AWG | #1 AWG | 3.33 | 1.25 | Red | P71 | 298 | 76 | 1 5/16 | 10 |
| BPC3/0-X | 3/0 AWG | 1/0 AWG | 3.46 | 1.38 | Red | P71 | 298 | 76 | 1 5/16 | 10 |
| BPC4/0-X | 4/0 AWG | 2/0 AWG | 3.46 | 1.38 | Red | P71 | 298 | 76 | 1 5/16 | 10 |
| BPC250-X | 250 kcmil | 3/0 AWG | 3.71 | 1.50 | Green | P94 | 299 | 99,87 | 1 7/16 | 10 |
| BPC300-X | 300 kcmil | 4/0 AWG | 4.10 | 1.63 | Green | P94 | 299 | 99,87 | 1 7/16 | 10 |
| BPC350-X | 350 kcmil | 4/0 AWG | 4.10 | 1.63 | Green | P94 | 299 | 99,87 | 1 7/16 | 10 |
| BPC400-X | 400 kcmil | 250 kcmil | 4.35 | 1.88 | Black | P106 | 300 | 106 | 1 7/16 | 10 |
| BPC500-X | 500 kcmil | 350 kcmil | 4.35 | 1.88 | Black | P106 | 300 | 106 | 1 7/16 | 10 |
| BPC600-6 | 600 kcmil | 350 kcmil | 4.77 | 1.88 | Red | P125 | 936 | 115 | 1 15/16 | 6 |
| BPC750-6 | 750 kcmil | 500 kcmil | 4.90 | 2.00 | Red | P125 | 936 | 115 | 1 15/16 | 6 |

‡See pages D3.84 – D3.85 for tool and die information.
See page D2.123 for *PANDUIT* joint compounds recommended for pad to pad and conductor connections.

A. System Overview

B1. Cable Ties

B2. Cable Accessories

B3. Stainless Steel Ties

C1. Wiring Duct

C2. Surface Raceway

C3. Abrasion Protection

C4. Cable Management

D1. Terminals

D2. Power Connectors

D3. Grounding Connectors

E1. Labeling Systems

E2. Labels

E3. Pre-Printed & Write-On Markers

E4. Permanent Identification

E5. Lockout/Tagout & Safety Solutions

F. Index

A.
System
Overview

Code Conductor, Aluminum HTAP

B1.
Cable Ties

For Combinations of Aluminum-to-Aluminum or Aluminum-to-Copper Code Conductors

Type HTAP

B2.
Cable
Accessories

- Dual rated – used to tap into continuous runs of aluminum conductor with either aluminum or copper tap conductor
- Factory pre-filled with joint compound to inhibit corrosion
- Conductor range for each tap groove and die index number marked on barrel to identify proper conductor size and crimping die to be used
- Made from high conductivity, high strength aluminum to provide premium mechanical and electrical performance
- For use up to 600 V and 90°C temperature rated when crimped with *PANDUIT* crimping tools and dies

B3.
Stainless
Steel Ties



C1.
Wiring
Duct

C2.
Surface
Raceway

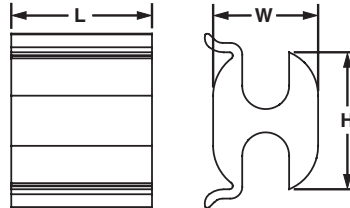

C3.
Abrasion
Protection

C4.
Cable
Management

D1.
Terminals

D2.
Power
Connectors

D3.
Grounding
Connectors

| Part Number | Conductor Size | | Figure Dimensions (In.) | | | PANDUIT Die Index No.‡ | Wire Strip Length (In.) | Std. Pkg. Qty. |
|----------------------|--|--|-------------------------|------|------|------------------------|-------------------------|----------------|
| | Run | Tap | L | W | H | | | |
| HTAP2-8-L | #2 – 6 AWG STR or #1 – 6 AWG SOL | #8 – 14 AWG STR or #7 – 14 AWG SOL | .75 | .56 | .73 | P50 | 7/8 | 50 |
| HTAP1-1-Q | #1 – 6 AWG STR or #2 – 6 AWG SOL | #1 – 6 AWG STR or #2 – 6 AWG SOL | 1.50 | .70 | 1.10 | P0 | 1 5/8 | 25 |
| HTAP1/0-1-Q | 1/0 – 6 AWG STR or #2 – 6 AWG SOL | #1 – 6 AWG STR or #2 – 6 AWG SOL | 1.50 | .70 | 1.17 | P0 | 1 5/8 | 25 |
| HTAP2/0-1-Q | 2/0 – 2 AWG STR or #2 – 6 AWG SOL | #1 – 6 AWG STR or #2 – 6 AWG SOL | 1.50 | .70 | 1.17 | P0 | 1 5/8 | 25 |
| HTAP3/0-1-Q | 3/0 – 1/0 AWG STR or 4/0 – 3/0 AWG SOL | #1 – 6 AWG STR or #2 – 6 AWG SOL | 1.50 | .88 | 1.39 | PD or PD3 | 1 5/8 | 25 |
| HTAP3/0-3/0-Q | 3/0 – 1/0 AWG STR or 4/0 – 3/0 AWG SOL | 3/0 – 1/0 AWG STR or 4/0 – 3/0 AWG SOL | 1.88 | .90 | 1.48 | PD or PD3 | 2 | 25 |
| HTAP4/0-2-Q | 4/0 – 3/0 AWG STR | #1 – 6 AWG STR or #2 – 6 AWG SOL | 1.50 | .88 | 1.38 | PD or PD3 | 1 5/8 | 25 |
| HTAP4/0-3/0-Q | 4/0 – 3/0 AWG STR | 3/0 – 1 AWG STR | 2.25 | .90 | 1.44 | PD or PD3 | 2 3/8 | 25 |
| HTAP4/0-4/0-Q | 4/0 – 3/0 AWG STR | 4/0 – 3/0 AWG STR | 2.50 | .90 | 1.38 | PD or PD3 | 2 5/8 | 25 |
| HTAP500-500-X | 500 kcmil – 4/0 AWG STR | 500 kcmil – 4/0 AWG STR | 4.50 | 1.20 | 1.88 | PN | 4 5/8 | 10 |
| HTAP500-4/0-X | 500 kcmil – 4/0 AWG STR | 4/0 – 1/0 AWG STR | 2.75 | 1.20 | 1.88 | PN | 2 7/8 | 10 |

‡See page D3.86 for tool and die information.

See page D2.123 for type TAPC HTAP covers.

See page D2.123 for *PANDUIT* joint compounds recommended for pad to pad and conductor connections.

E1.
Labeling
Systems

E2.
Labels

E3.
Pre-Printed
& Write-On
Markers

E4.
Permanent
Identification

E5.
Lockout/
Tagout/
& Safety
Solutions

F.
Index

Black Covers for Copper CTAPs and Aluminum HTAPs

Protect CTAP or HTAP Connection from Environment And Act as Insulation

Type TAPC

- Used to insulate connectors and protect tap connections from corrosive environments
- Made of durable, weather-resistant black polypropylene
- Double locking latches provide secure cover installation
- Flexible molded fingers at end of covers conform to conductor and prevent foreign objects from contacting connector

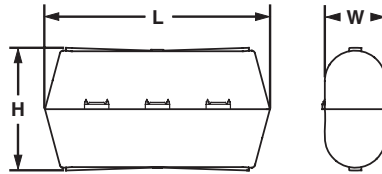

| Part Number | Use with CTAP Part Number | Use with HTAP Part Number | Figure Dimensions (In.) | | | Std. Pkg. Qty. |
|---------------|--|--|-------------------------|------|------|----------------|
| | | | L | W | H | |
| TAPC2-2/0-X | CTAP 4-6, CTAP 4-4, CTAP 2-4, CTAP 2-2 | HTAP 1-1, HTAP 1/0-1, HTAP 2-8, HTAP 2/0-1 | 4.62 | 1.60 | 2.22 | 10 |
| TAPC3/0-4/0-5 | CTAP 4/0-4/0 | HTAP 3/0-1, HTAP 3/0-3/0, HTAP 4/0-2, HTAP 4/0-3/0, HTAP 4/0-4/0 | 5.65 | 1.72 | 2.38 | 5 |
| TAPC500-2 | — | HTAP 500-4/0, HTAP 500-500 | 6.81 | 2.86 | 2.38 | 2 |

For information on copper CTAPs, see page D3.7.
For information on aluminum HTAPs, see page D2.122.

Joint Compounds

For Use with Aluminum Connectors

Type CMP

- Oxide inhibitor for compression conductor connections lowers electrical resistance of compression joint while sealing out air and moisture to prevent the formation of surface oxides
- Wide operating temperature range; can be used in a wide range of electrical and environmental conditions
- Packaged in convenient dispenser bottles



| Part Number | Part Description | Std. Pkg. Qty. |
|-------------|--|----------------|
| CMP-100-1 | Contact aid for pad-to-pad or thread-to-thread aluminum connections, 8 oz. Operating temperature range -60°F (-51°C) to 400°F (204°C). | 1 |
| CMP-200-1 | Contact aid for cable connections with compression connections made on aluminum conductor, 8 oz. Operating temperature range -40°F (-40°C) to 400°F (204°C). Compatible with all insulating materials. | 1 |

A. System Overview

B1. Cable Ties

B2. Cable Accessories

B3. Stainless Steel Ties

C1. Wiring Duct

C2. Surface Raceway

C3. Abrasion Protection

C4. Cable Management

D1. Terminals

D2. Power Connectors

D3. Grounding Connectors

E1. Labeling Systems

E2. Labels

E3. Pre-Printed & Write-On Markers

E4. Permanent Identification

E5. Lockout/Tagout & Safety Solutions

F. Index

A.
System
Overview

B1.
Cable Ties

B2.
Cable
Accessories

B3.
Stainless
Steel Ties

C1.
Wiring
Duct

C2.
Surface
Raceway

C3.
Abrasion
Protection

C4.
Cable
Management

D1.
Terminals

D2.
Power
Connectors

D3.
Grounding
Connectors

E1.
Labeling
Systems

E2.
Labels

E3.
Pre-Printed
& Write-On
Markers

E4.
Permanent
Identification

E5.
Lockout/
Tagout/
& Safety
Solutions

F.
Index

NOTES

PAN-LUG™ MECHANICAL CONNECTORS

PANDUIT offers a broad variety of mechanical lugs, splices, and split bolt connectors suitable for a wide range of electrical terminations using code conductor. Designed to be reusable and installed without special tooling, PAN-LUG™ Mechanical Connectors provide quality performance, ease of installation, and lowest installed cost.



- Functional product information is marked directly on the connector, facilitating the identification, ordering, and usage of the mechanical connector
- Incorporate wide wire range-taking capability to minimize inventory requirements
- Made from high strength, high conductivity electrolytic copper and aluminum alloy materials to provide optimum connectivity for power and grounding applications
- UL Listed and CSA Certified, as noted

PAN-LUG™ Mechanical Connectors include split bolt connectors, copper mechanical lugs, aluminum mechanical lugs and aluminum multi-tap connectors with clear PVC insulation. Products are available in stamped and formed, extruded and cast varieties of multiple barrel and tongue configurations to provide solutions for diverse power and grounding needs. PANDUIT offers a wide assortment of PAN-LUG™ Power and Grounding Connectors to meet customer needs and today's application requirements.

A.
System
Overview

B1.
Cable
Ties

B2.
Cable
Accessories

B3.
Stainless
Steel
Ties

C1.
Wiring
Duct

C2.
Surface
Raceway

C3.
Abrasion
Protection

C4.
Cable
Management

D1.
Terminals

D2.
Power
Connectors

D3.
Grounding
Connectors

E1.
Labeling
Systems

E2.
Labels

E3.
Pre-Printed
& Write-On
Markers

E4.
Permanent
Identification

E5.
Lockout/
Tagout/
& Safety
Solutions

F.
Index

A. System Overview

Features and Benefits – PAN-LUG™ Mechanical Connectors

B1. Cable Ties

Copper Split Bolt Connectors

Part number and conductor range marked on part for easy identification

Hex head with large wrench flats for easy assembly

Waxed body to prohibit binding of contact pad or nut

250 kcmil and larger sizes have contact serrations for higher pull-out strength

Extra-long body available to connect two taps with one run

Made from high strength copper alloy



Cast Copper Connectors

Made from high strength copper alloy

Inspection windows to assure complete conductor insertion

Serrated barrel available for high pull-out strength

Part number and conductor range marked on part for easy identification

Flat bottom allows full contact surface mounting



C3. Abrasion Protection

Stamped and Formed Copper Connectors

Made from high strength, electrolytic copper alloy

Hex head bolt (slotted set screw used up through 1/0 AWG sizes) for assembly with a wrench or screwdriver

Part number and conductor range marked on part for easy identification

Two styles of tongues available: fixed and floating

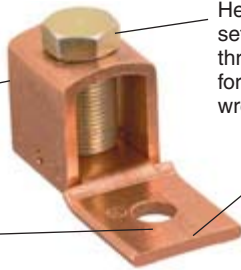

Aluminum Connectors

Dual rated for aluminum or copper conductors

Hex socket set screw (slotted set screw used up through 2/0 AWG sizes) for assembly with a wrench or screwdriver

Made from high strength, extruded aluminum alloy

Electro tin-plated to inhibit corrosion

Part number and conductor range marked on part for easy identification

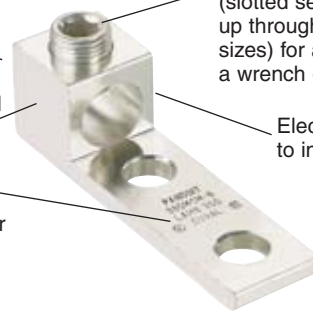

D3. Grounding Connectors

Multi-Tap Connectors

Hex socket set screws (slotted set screw for smallest size) for assembly with a wrench or screwdriver

Pre-insulated aluminum body to eliminate the need for taping

Clear PVC insulation for visual inspection of the complete conductor insertion

Dual-sided conductor entry

Factory pre-filled with oxide inhibitor to prevent oxidation



Made from high strength, extruded aluminum alloy



Available with two isolated mounting holes at either end of connector to facilitate direct mounting using 1/4" bolts.

E5. Lockout/Tagout & Safety Solutions



PANDUIT designs and manufactures a full line of labeling products, software, and printers to assist you with your labeling requirements. See pages E1.1 – E2.30.













PAN-STEEL® Stainless Cable Ties provide a strong, durable method of bundling and fastening, in all indoor, outdoor, and underground applications. See pages B3.2 – B3.19.



PANDUIT provides a complete selection of nylon cable ties to bundle, mount, and identify in countless indoor, outdoor, and harsh environment applications. See pages B1.1 – B1.84.

Selection Guide – PAN-LUG™ Mechanical Connectors, Cast Copper

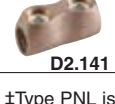
| 1. Select Connector Type and Stud Hole Size Desired | | | 2. Determine Conductor Size and then Select PANDUIT Part Number | | | | | | | | | | | | | | | | | | | | | | | | | | | | |
|---|----------------------------------|--------------------|---|---------|---------|--------------|--------|--------|--------------|--------|---------|--------------|---------|---------|--------------|-----------|-----------|-----------|-----------|-----------|-----------|------------|--|--|--|--|--|--|--|--|--|
| UL LISTED ‡ | Mechanical Connector Type | Stud Hole Size In. | Copper Code Conductor Size | | | | | | | | | | | | | | | | | | | | | | | | | | | | |
| | | | #14 AWG | #12 AWG | #10 AWG | #8 AWG | #6 AWG | #4 AWG | #2 AWG | #1 AWG | 1/0 AWG | 2/0 AWG | 3/0 AWG | 4/0 AWG | 250 kcmil | 300 kcmil | 350 kcmil | 500 kcmil | 600 kcmil | 750 kcmil | 800 kcmil | 1000 kcmil | | | | | | | | | |
| | | | PANDUIT Part Number | | | | | | | | | | | | | | | | | | | | | | | | | | | | |
|  | One-Hole, Straight Tongue HL | 1/4 | HL1-25-X ■* | | | HL4-1-X ■* | | | HL8-1-X* | | | HL13-1-5 | | | HL21-1-5 | | | HL30-1-2 | | | HL50-1-2 | | | | | | | | | | |
| | | 3/8 | | | | | | | | | | | | | | | | | | | | | | | | | | | | | |
| | | 1/2 | | | | | | | | | | | | | | | | | | | | | | | | | | | | | |
|  | One-Hole, Straight Tongue HLB | 1/4 | HLB4-1-X ■* | | | | | | | | | | | | | | | | | | | | | | | | | | | | |
|  | One-Hole, Straight Tongue HLA-90 | 1/4 | HLA4-1-90-X ■* | | | HLA8-1-90-X* | | | HLA13-1-90-5 | | | HLA21-1-90-5 | | | | | | | | | | | | | | | | | | | |
| | | 3/8 | | | | | | | | | | | | | | | | | | | | | | | | | | | | | |
|  | Two-Hole, Straight Tongue HL-2 | 1/4 | HL1-2-25-X ■* | | | HL4-2-X ■* | | | HL8-2-X* | | | HL13-2-5 | | | HL21-2-5 | | | HL30-2-2 | | | HL50-2-2 | | | | | | | | | | |
| | | 5/16 | | | | | | | | | | | | | | | | | | | | | | | | | | | | | |
| | | 3/8 | | | | | | | | | | | | | | | | | | | | | | | | | | | | | |
|  | Two-Hole, Straight Tongue HL-2N | 1/2 | | | | HL8-2N-X ◆* | | | HL13-2N-5 ◆ | | | HL21-2N-5 ◆ | | | HL30-2N-2 ◆ | | | | | | | | | | | | | | | | |
|  | Two-Hole, Straight Tongue H2L-2N | 1/2 | H2L4-2N-X ◆ ■* | | | H2L8-2N-2 ◆* | | | H2L13-2N-2 ◆ | | | H2L21-2N-2 ◆ | | | H2L30-2N-1 ◆ | | | | | | | | | | | | | | | | |
| | | | | | | | | | | | | | | | | | | | | | | | | | | | | | | | |
| | | | | | | | | | | | | | | | | | | | | | | | | | | | | | | | |
|  | Two-Way, Connector HC | — | HC4-3 ■* | | | HC8-3* | | | HC13-3 | | | HC21-1 | | | HC30-1 | | | HC50-1 | | | | | | | | | | | | | |
| | | | | | | | | | | | | | | | | | | | | | | | | | | | | | | | |
| | | | | | | | | | | | | | | | | | | | | | | | | | | | | | | | |
|  | Two-Hole, Straight Tongue HHL-2N | 1/2 | | | | HHL8-2N-X ◆* | | | HHL13-2N-5 ◆ | | | HHL21-2N-5 ◆ | | | HHL30-2N-1 ◆ | | | | | | | | | | | | | | | | |
|  | One-Hole, Straight Tongue PNL | #10 | PNL-8-C ■* | | | | | | | | | | | | | | | | | | | | | | | | | | | | |
| | | 1/4 | PNL-4-C ■* | | | | | | | | | | | | | | | | | | | | | | | | | | | | |
| | | 5/16 | PNL-1/0-L* | | | | | | | | | | | | | | | | | | | | | | | | | | | | |
| | | 3/8 | PNL-250-Q* | | | | | | | | | | | | | | | | | | | | | | | | | | | | |
| | | 1/2 | PNL-500-3* | | | | | | | | | | | | | | | | | | | | | | | | | | | | |
|  | One-Hole, Straight Tongue ML | 3/16 | ML8-CY ■* | | | | | | | | | | | | | | | | | | | | | | | | | | | | |
| | | 1/4 | ML4-CY ■* | | | | | | | | | | | | | | | | | | | | | | | | | | | | |
| | | 5/16 | ML1/0-LY* | | | | | | | | | | | | | | | | | | | | | | | | | | | | |
| | | 3/8 | ML250-QY | | | | | | | | | | | | | | | | | | | | | | | | | | | | |
|  | Two-Hole, Straight Tongue PNL-2 | 5/16 | PNL-1/0-2-L* | | | | | | | | | | | | | | | | | | | | | | | | | | | | |
| | | 3/8 | PNL-250-2-Q* | | | | | | | | | | | | | | | | | | | | | | | | | | | | |
| | | 1/2 | PNL-500-2-3* | | | | | | | | | | | | | | | | | | | | | | | | | | | | |
|  | Two-Way, Connector PNLC | — | PNLC-1/0-3* | | | | | | | | | | | | | | | | | | | | | | | | | | | | |
| | | | PNLC-250-1* | | | | | | | | | | | | | | | | | | | | | | | | | | | | |
| | | | PNLC-500-1* | | | | | | | | | | | | | | | | | | | | | | | | | | | | |

‡Type PNL is also CSA Certified, Type PNLC is not UL Listed or CSA Certified.
 ◆NEMA hole sizes and spacing.
 ■Uses slotted set screw.
 *Denotes minimum conductor size is solid conductor.

A. System Overview

B1. Cable Ties

B2. Cable Accessories

B3. Stainless Steel Ties

C1. Wiring Duct

C2. Surface Raceway

C3. Abrasion Protection

C4. Cable Management

D1. Terminals

D2. Power Connectors

D3. Grounding Connectors

E1. Labeling Systems

E2. Labels

E3. Pre-Printed & Write-On Markers

E4. Permanent Identification

E5. Lockout/Tagout & Safety Solutions

F. Index

A.
System
Overview

B1.
Cable Ties

B2.
Cable
Accessories

B3.
Stainless
Steel Ties

C1.
Wiring
Duct

C2.
Surface
Raceway

C3.
Abrasion
Protection

C4.
Cable
Management

D1.
Terminals

D2.
Power
Connectors

D3.
Grounding
Connectors

E1.
Labeling
Systems

E2.
Labels







E3.
Pre-Printed
& Write-On
Markers

E4.
Permanent
Identification

E5.
Lockout/
Tagout/
& Safety
Solutions

















F.
Index

Selection Guide – PAN-LUG™ Mechanical Connectors, Stamped and Formed

| | | 1. Select Connector Type and Stud Hole Size Desired | | | | 2. Determine Conductor Size and then Select PANDUIT Part Number | | | | | | | | | | | | | | | |
|---|--|---|----------------------|----------------------------|---------|---|--------|--------|--------|--------|--------|---------|---------|---------|---------|-----------|-----------|-----------|-----------|-----------|-----------|
| UL LISTED CS® CERTIFIED | Mechanical Connector Type | Current Rating AMPS | Stud Hole Size (In.) | Copper Code Conductor Size | | | | | | | | | | | | | | | | | |
| | | | | #14 AWG | #12 AWG | #10 AWG | #8 AWG | #6 AWG | #4 AWG | #2 AWG | #1 AWG | 1/0 AWG | 2/0 AWG | 3/0 AWG | 4/0 AWG | 250 kcmil | 350 kcmil | 400 kcmil | 500 kcmil | 600 kcmil | 750 kcmil |
| | | | | PANDUIT Part Number | | | | | | | | | | | | | | | | | |
|  | One-Hole, Offset Tongue CB | 25 | 1/8 | CB25-18-CY■ | | | | | | | | | | | | | | | | | |
| | | 50 | 3/16 | CB35-36-CY•■ | | | | | | | | | | | | | | | | | |
| | | 70 | 1/4 | CBA70-14-CY■ | | | | | | | | | | | | | | | | | |
| | | 90 | | CB70-14-CY•■ | | | | | | | | | | | | | | | | | |
| | | 125 | | CB125-14-QY■ | | | | | | | | | | | | | | | | | |
| | | 175 | 3/8 | CB175-38-QY | | | | | | | | | | | | | | | | | |
| | | 225 | 5/16 | CB225-56-QY | | | | | | | | | | | | | | | | | |
| | | 300 | 3/8 | CB300-38-QY | | | | | | | | | | | | | | | | | |
| | | 400 | | CB400-38-3Y | | | | | | | | | | | | | | | | | |
| 650 | 1/2 | CB650-12-3Y | | | | | | | | | | | | | | | | | | | |
|  | Two Barrel, One-Hole, Offset Tongue DC | 450 | 3/8 | DC450-38-3Y | | | | | | | | | | | | | | | | | |
| | | 600 | | DC600-38-3Y | | | | | | | | | | | | | | | | | |
| | | 800 | 1/2 | DC800-12-3Y | | | | | | | | | | | | | | | | | |
|  | Two-Hole, Offset Tongue CO | 50 | 3/16 | CO35-36-QY•■(1) | | | | | | | | | | | | | | | | | |
| | | 90 | 1/4 | CO70-14-QY•■(1) | | | | | | | | | | | | | | | | | |
| | | 125 | | CO125-14-QY■(1) | | | | | | | | | | | | | | | | | |
| | | 225 | 5/16 | CO225-56-QY(1) | | | | | | | | | | | | | | | | | |
| | | 300 | 3/8 | CO300-38-3Y(3) | | | | | | | | | | | | | | | | | |
| | | 400 | | CO400-38-3Y(2) | | | | | | | | | | | | | | | | | |
| 650 | 1/2 | CO650-12-3Y■(2) | | | | | | | | | | | | | | | | | | | |
|  | One-Hole, Straight "Fixed" Tongue CX | 35 | 3/16 | CX35-36-CY■ | | | | | | | | | | | | | | | | | |
| | | 70 | 1/4 | CX70-14-CY•■ | | | | | | | | | | | | | | | | | |
| | | 125 | | CX125-14-QY■ | | | | | | | | | | | | | | | | | |
| | | 225 | 5/16 | CX225-56-QY | | | | | | | | | | | | | | | | | |
| 400 | 3/8 | CX400-38-3Y | | | | | | | | | | | | | | | | | | | |
|  | One-Hole, Straight Tongue CS | 25 | 1/8 | CS25-18-CY■ | | | | | | | | | | | | | | | | | |
| | | 50 | 3/16 | CS35-36-CY•■ | | | | | | | | | | | | | | | | | |
| | | 70 | 1/4 | CSA70-14-CY■ | | | | | | | | | | | | | | | | | |
| | | 90 | | CS70-14-CY•■ | | | | | | | | | | | | | | | | | |
| | | 125 | | CS125-14-QY■ | | | | | | | | | | | | | | | | | |
| | | 175 | 3/8 | CS175-38-QY | | | | | | | | | | | | | | | | | |
| | | 225 | 5/16 | CS225-56-QY | | | | | | | | | | | | | | | | | |
| | | 300 | 3/8 | CS300-38-QY | | | | | | | | | | | | | | | | | |
| 400 | CS400-38-3Y | | | | | | | | | | | | | | | | | | | | |
| 650 | 1/2 | CS650-12-3Y | | | | | | | | | | | | | | | | | | | |
|  | Two-Hole, Straight Tongue CD | 50 | 3/16 | CD35-36-QY•■(1) | | | | | | | | | | | | | | | | | |
| | | 90 | 1/4 | CD70-14-QY■(1) | | | | | | | | | | | | | | | | | |
| | | 125 | | CD125-14-QY■(1) | | | | | | | | | | | | | | | | | |
| | | 225 | 5/16 | CD225-56-QY(1) | | | | | | | | | | | | | | | | | |
| | | 300 | 3/8 | CD300-38-3Y(1) | | | | | | | | | | | | | | | | | |
| | | 400 | | CD400-38-3Y(2) | | | | | | | | | | | | | | | | | |
| | | 650 | 1/2 | CD650-12-3Y◆(2) | | | | | | | | | | | | | | | | | |

- Multiple conductor combinations.
- ◆NEMA hole sizes and spacing.
- Uses slotted set screw.
- (1) 1.00" stud hole spacing.
- (2) 1.75" stud hole spacing.
- (3) 1.87" stud hole spacing.

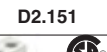
Selection Guide – PAN-LUG™ Mechanical Connectors, Aluminum

| 1. Select Connector Type and Stud Hole Size Desired | | 2. Determine Conductor Size and then Select PANDUIT Part Number | | | | | | | | | | | | | | | | | | | | | | | |
|--|--|--|------------------|-----------------|-------------------|-----------------|------------------|-----------------|--------------------|-----------------|-------------------|----------------|---------|-----------------|-------------------|-----------|-----------------|-------------------|-----------|--------------------|------------|--|-------------------|--|--|
| Mechanical Connector Type | Stud Hole Size (In.) | Aluminum/Copper Code Conductor Size | | | | | | | | | | | | | | | | | | | | | | | |
| | | #14 AWG | #12 AWG | #10 AWG | #8 AWG | #6 AWG | #4 AWG | #2 AWG | #1 AWG | 1/0 AWG | 2/0 AWG | 3/0 AWG | 4/0 AWG | 250 kcmil | 300 kcmil | 350 kcmil | 500 kcmil | 600 kcmil | 750 kcmil | 800 kcmil | 1000 kcmil | | | | |
| | | PANDUIT Part Number | | | | | | | | | | | | | | | | | | | | | | | |
|   D2.147 One Barrel, One-Hole LAMA | 1/4 | LAMA6-14-QY■ | | | LAMA14-14-QY■ | | | LAMA1/0-14-QY■ | | | LAMA2/0-14-QY■ | | | | | | | | | | | | | | |
| | | LAMA250-56-QY | | | LAMA300-56-QY | | | LAMA350-38-QY | | | LAMA500-38-6Y | | | LAMA600-38-6Y | | | LAMA600S-38-6Y‡ | | | | | | | | |
| | | LAMA800-58-6Y | | | LAMA1000-58-6Y | | | | | | | | | | | | | | | | | | | | |
| | | | | | | | | | | | | | | | | | | | | | | | | | |
| |   D2.148 One Barrel, Two-Hole LAMB | 1/2 | LAMB350-12-6Y◆ | | | LAMB600-12-3Y◆ | | | LAML800-12-3Y◆▲ | | | | | | | | | | | | | | | | |
| | | | | | | | | | | | | | | | | | | | | | | | | | |
|   D2.148 Two Barrel, One-Hole LAM2A | 1/4 | LAM2A1/0-14-6Y■ | | | LAM2A2/0-14-6Y■ ^ | | | LAM2A250-38-6Y | | | LAM2A350-12-6Y | | | LAM2A600-12-6Y | | | LAM2A800-58-6Y | | | LAM2A1000-58-6Y‡‡^ | | | | | |
| | | 1/2 | LAM2B350-12-3Y◆ | | | LAM2B600-12-3Y◆ | | | LAM2LB800-12-3Y▲‡‡ | | | | | | | | | | | | | | | | |
| | 5/8 | | | | | | | | | | | | | | | | | | | | | | | | |
| | |   D2.149 Two Barrel, Two-Hole LAM2B | 1/2 | LAM2SB600-38-1Y | | | LAM2SB750-38-1Y^ | | | LAM2SB500-141Y▲ | | | | | | | | | | | | | | | |
| | | | | | | | | | | | | | | | | | | | | | | | | | |
|   D2.150 Two Barrel, Two-Hole LAM2SB | 1/4 | | | | | | | | | | | | | | | | | | | | | | | | |
| | | | | | | | | | | | | | | | | | | | | | | | | | |
|   D2.150 Three Barrel, Two-Hole LAM3B | 5/16 | LAM3B2-14-6Y■ | | | LAM3B1/0-38-6Y■ | | | LAM3B3/0-12-3Y◆ | | | LAM3B250-12-1Y◆ | | | LAM3B350-12-1Y◆ | | | LAM3B600-12-1Y◆ | | | LAM3LB800-12-1Y◆▲ | | | LAM3LB1000-121Y◆▲ | | |
| | | 3/8 | LAM3SB600-38-1Y | | | LAM3SB750-38-1Y | | | LAM2SB500-141Y▲ | | | | | | | | | | | | | | | | |
| | 1/2 | | LAM3D3/0-12-3Y◆■ | | | LAM3D250-12-1Y◆ | | | LAM3D350-12-1Y◆ | | | LAM3D600-12-1Y | | | LAM3LD800-12-1Y◆▲ | | | LAM3LD1000-121Y◆▲ | | | | | | | |
| | | 3/8 | LAM4SB600-38-1Y | | | LAM4SB750-38-1Y | | | | | | | | | | | | | | | | | | | |
| | | | | | | | | | | | | | | | | | | | | | | | | | |
|   D2.151 Three Barrel, Four-Hole LAM3D | 1/2 | | | | | | | | | | | | | | | | | | | | | | | | |
| | | | | | | | | | | | | | | | | | | | | | | | | | |
|   D2.152 Four Barrel, Two-Hole LAM4SB | 3/8 | LAM4D250-12-1Y◆ | | | LAM4D350-12-1Y◆ | | | LAM4D600-12-1Y◆ | | | LAM4LD800-12-1Y◆▲ | | | | | | | | | | | | | | |
| | | | | | | | | | | | | | | | | | | | | | | | | | |
|   D2.152 Four Barrel, Four-Hole LAM4D | 1/2 | | | | | | | | | | | | | | | | | | | | | | | | |
| | | | | | | | | | | | | | | | | | | | | | | | | | |

‡LAMA600S-38-6 can also be used with (2) 250 kcmil-1/0 AWG conductors.

◆NEMA hole sizes and spacing.

■Uses slotted set screws.

▲Uses double set screws.

^Not CSA Certified.

‡‡Not UL Listed.

Note: Use of PANDUIT oxide inhibiting joint compound CMP-100 is recommended for use with aluminum mechanical connectors.

A. System Overview

B1. Cable Ties

B2. Cable Accessories

B3. Stainless Steel Ties

C1. Wiring Duct

C2. Surface Raceway

C3. Abrasion Protection

C4. Cable Management

D1. Terminals

D2. Power Connectors

D3. Grounding Connectors

E1. Labeling Systems

E2. Labels

E3. Pre-Printed & Write-On Markers

E4. Permanent Identification

E5. Lockout/Tagout & Safety Solutions

F. Index

A. System Overview

B1. Cable Ties

B2. Cable Accessories

B3. Stainless Steel Ties

C1. Wiring Duct

C2. Surface Raceway

C3. Abrasion Protection

C4. Cable Management

D1. Terminals

D2. Power Connectors

D3. Grounding Connectors

E1. Labeling Systems

E2. Labels

E3. Pre-Printed & Write-On Markers

E4. Permanent Identification

E5. Lockout/Tagout & Safety Solutions

F. Index

Selection Guide – PAN-LUG™ Mechanical Connectors, Split Bolts and Multi-Taps

1. Select Split Bolt Style Desired
2. Determine Conductor Range and then Select PANDUIT Part Number

Copper Split Bolt Connectors – SBC

For Use with Copper Code Conductors



| PANDUIT Part Number | Conductor Size Range** | | PANDUIT Part Number | Copper Conductor Range** | |
|---------------------|------------------------|--------|---------------------|--------------------------|------------|
| | Min. | Max. | | Min. | Max. |
| SBC8-C | #10 STR | #8 STR | SBC1/0-L | #4 STR | 1/0 STR |
| SBC8L-C^ | #16 STR | #8 STR | SBC2/0-Q | #2 STR | 2/0 STR |
| SBC6S-C | #8 STR | #6 SOL | SBC3/0-Q | #1 STR | 3/0 STR |
| SBC6SL-C^ | #8 STR | #6 STR | SBC250-Q | #1 STR | 250 kcmil |
| SBC4S-C | #8 STR | #6 STR | SBC350-1 | 2/0 STR | 350 kcmil |
| SBC4SL-C^ | #8 STR | #6 STR | SBC500-1 | 300 kcmil | 500 kcmil |
| SBC3-C | #8 STR | #4 STR | SBC750-1 | #8 SOL | 750 kcmil |
| SBC2-C | #6 STR | #2 STR | SBC1000-1 | #8 SOL | 1000 kcmil |
| SBC2L-C^ | #14 STR | #2 STR | | | |

^Long body accommodates two tap conductors with single run; not CSA Certified.
 **The conductor sizes shown are for equal run and tap combinations

Tin Plated Copper Split Bolt Connectors – SBCT

For Use with Combinations of Copper and Aluminum Conductors



| PANDUIT Part Number | Copper and Aluminum Conductor Range | | |
|------------------------|-------------------------------------|------------|----------------------------|
| | Range of Equal Run and Tap | | Min. Tap with One Max. Run |
| | Min. | Max. | |
| SBCT8-C | #8 STR | #6 SOL | #14 STR |
| SBCT6-C | #8 STR | #6 STR | #10 STR |
| SBCT3-C | #8 STR | #4 STR | #10 STR |
| SBCT2-C | #6 STR | #2 STR | #14 STR |
| SBCT1/0-L | #4 STR | 1/0 STR | #10 STR |
| SBCT2/0-Q | #2 STR | 2/0 STR | #8 STR |
| Copper Conductor Range | | | |
| SBCT10-C | #16 STR | #10 STR | #16 STR |
| SBCT3/0-Q | #1 STR | 3/0 STR | #8 STR |
| SBCT250-Q | #1 STR | 250 kcmil | #8 STR |
| SBCT350-1 | 2/0 STR | 350 kcmil | 1/0 STR |
| SBCT500-1 | 300 kcmil | 500 kcmil | 2/0 STR |
| SBCT750-1 | 2/0 STR | 750 kcmil | 2/0 STR |
| SBCT1000-1 | 4/0 STR | 1000 kcmil | 4/0 STR |

Dual Rated Aluminum Split Bolt Connectors – SBA

For Use with Aluminum and Copper Conductor Combinations



| PANDUIT Part Number | Aluminum to Aluminum, Aluminum to Copper, Copper to Copper Conductors | | | | | |
|---------------------|---|-----------|----------------------|------------------|----------------------|------------------|
| | Max. Run to Max. Tap | | Min. Run to Min. Tap | | Max. Run to Min. Tap | |
| SBA6-C | #6 STR | #6 STR | #10 SOL | #10 SOL | #6 STR | #10 SOL |
| SBA4-C | #4 STR | #4 STR | #8 SOL | #10 SOL | #4 STR | #2 SOL |
| SBA2-C | #2 STR | #2 STR | #6 SOL | #8 STR | #2 STR | #8 STR |
| SBA1/0-Q | 1/0 STR | 1/0 STR | #2 STR (Compact) | #8 SOL | 1/0 STR | #8 SOL |
| SBA2/0-Q | 2/0 STR | 2/0 STR | #2 STR (Compact) | #8 STR | 2/0 STR | #8 STR |
| SBA4/0-Q | 4/0 STR | 4/0 STR | #2 STR (Compact) | #6 STR | 4/0 STR | #6 STR |
| SBA350-1^ | 350 kcmil | 350 kcmil | 1/0 STR (Compact) | #4 STR | 350 kcmil | #4 STR |
| SBA500-1^ | 500 kcmil | 500 kcmil | 400 kcmil (Compact) | #2 STR (Compact) | 500 kcmil | #2 STR (Compact) |

^Not CSA Certified.

Multi-Tap Connectors with Clear Insulation

For Use with Aluminum and Copper Code Conductor Combinations



D2.155 – D2.160



| Type | Description | No. of Ports | Copper or Aluminum Code Conductor Range |
|--------|-----------------------------------|--------------|---|
| PCSB | Double-Sided Wire Entry | 2 to 14 | 14 AWG Solid to 750 kcmil |
| PCSB-S | Single-Sided Wire Entry | 2 to 14 | 14 AWG Stranded to 600 kcmil |
| PISR | In-Line Splicer/Reducer | 2 | 14 AWG Stranded to 500 kcmil |
| PCSBM | Double-Sided Wire Entry Mountable | 2 to 14 | 14 AWG Stranded to 600 kcmil |
| PCSBMT | Single-Sided Wire Entry Mountable | 2 to 14 | 14 AWG Stranded to 600 kcmil |



Split Bolt, Copper

For Use with Copper Code Conductors

Type SBC

- Made from high strength copper alloy to resist corrosion and provide premium electrical and mechanical performance
- Offered with extra long body to allow connection of one or two taps to a single run conductor
- Wide wire range-taking capability minimizes inventory requirements
- Nut hex provides correct fit with socket, box, or open end wrenches resulting in proper torquing of electrical connection

- Pressure bar provides secure connection on a full range of conductor combinations used with each connector assuring premium wire pull-out strength
- UL Listed and CSA Certified for use up to 600 V and temperature rated 90°C

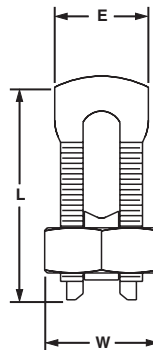

| Part Number | Copper Conductor | | | Max. Conductor Copperweld STR | Figure Dimensions (In.) | | | Tightening Torque (In.-Lbs.) | Std. Pkg. Qty. |
|------------------|----------------------------|------------|-------------------------------|-------------------------------------|----------------------------|------|------|------------------------------------|----------------------|
| | Range of Equal Run and Tap | | Min. Tap with One Max. Run | | E | W | L | | |
| | Min. | Max. | | | | | | | |
| SBC8-C | #10 STR | #8 STR | #16 STR | — | .39 | .55 | .86 | 80 | 100 |
| SBC8L-C* | #16 STR | #8 STR | #16 STR | — | .38 | .50 | .84 | 80 | 100 |
| SBC6S-C | #8 STR | #6 SOL | #16 STR | — | .41 | .62 | .95 | 165 | 100 |
| SBC6SL-C* | #8 STR | #6 STR | #16 STR | — | .41 | .63 | 1.10 | 165 | 100 |
| SBC4S-C | #8 STR | #6 STR | #14 STR | — | .45 | .69 | .98 | 165 | 100 |
| SBC4SL-C* | #8 STR | #6 STR | #14 STR | — | .45 | .69 | 1.30 | 165 | 100 |
| SBC3-C | #8 STR | #4 STR | #14 STR | — | .58 | .81 | 1.16 | 275 | 100 |
| SBC2-C | #6 STR | #2 STR | #14 STR | — | .59 | .86 | 1.23 | 275 | 100 |
| SBC2L-C* | #14 STR | #2 STR | #14 STR | 3 No. 7 | .63 | .81 | 1.55 | 275 | 100 |
| SBC1/0-L | #4 STR | 1/0 STR | #14 STR | — | .75 | .93 | 1.55 | 385 | 50 |
| SBC2/0-Q | #2 STR | 2/0 STR | #14 STR | — | .79 | 1.05 | 1.72 | 385 | 25 |
| SBC3/0-Q | #1 STR | 3/0 STR | #8 STR | — | .95 | 1.24 | 2.07 | 500 | 25 |
| SBC250-Q | #1 STR | 250 kcmil | #8 STR | — | 1.03 | 1.36 | 2.09 | 650 | 25 |
| SBC350-1 | 2/0 STR | 350 kcmil | 1/0 STR | — | 1.16 | 1.48 | 2.42 | 650 | 1 |
| SBC500-1 | 300 kcmil | 500 kcmil | 2/0 STR | — | 1.33 | 1.74 | 2.83 | 825 | 1 |
| SBC750-1 | #8 SOL | 750 kcmil | #8 SOL | 19 No. 5 | 1.94 | 2.13 | 3.75 | 1000 | 1 |
| SBC1000-1 | #8 SOL | 1000 kcmil | #8 SOL | — | 2.25 | 2.50 | 4.00 | 1100 | 1 |

*Long body accommodates two tap conductors with single run; not CSA Certified.

A.
System
Overview

B1.
Cable
Ties

B2.
Cable
Accessories

B3.
Stainless
Steel
Ties

C1.
Wiring
Duct

C2.
Surface
Raceway

C3.
Abrasion
Protection

C4.
Cable
Management

D1.
Terminals

D2.
Power
Connectors

D3.
Grounding
Connectors

E1.
Labeling
Systems

E2.
Labels

E3.
Pre-Printed
& Write-On
Markers

E4.
Permanent
Identification

E5.
Lockout/
Tagout/
& Safety
Solutions

F.
Index

A. System Overview

B1. Cable Ties

B2. Cable Accessories

B3. Stainless Steel Ties

C1. Wiring Duct

C2. Surface Raceway

C3. Abrasion Protection

C4. Cable Management

D1. Terminals

D2. Power Connectors

D3. Grounding Connectors

E1. Labeling Systems

E2. Labels

E3. Pre-Printed & Write-On Markers

E4. Permanent Identification

E5. Lockout/Tagout & Safety Solutions

F. Index



Split Bolt, Copper, Tin-Plated

For Specified Combinations of Copper and Aluminum Code Conductors

Type SBCT

- Made from high strength copper alloy to provide premium electrical and mechanical performance
- Tin-plated to inhibit corrosion and oxidation
- Offered with dual rating for use with aluminum or copper conductors
- Wide wire range-taking capability minimizes inventory requirements
- Nut hex provides correct fit with socket, box, or open end wrenches resulting in proper torquing of electrical connection
- Free floating pressure bar separates conductors of dissimilar materials for secure connection on a full range of conductor combinations
- UL Listed and CSA Certified for use up to 600 V and UL temperature rated 90°C

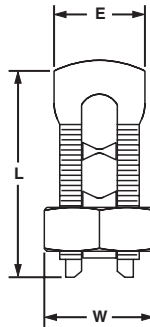

| Part Number | Copper and Aluminum Code Conductor | | | ACSR Range | Max. Conductor | | Figure Dimensions (In.) | | | Tightening Torque (In.-Lbs.) | Std. Pkg. Qty. |
|-------------|------------------------------------|------|----------------------------|------------|----------------|-----|-------------------------|---|---|------------------------------|----------------|
| | Range of Equal Run and Tap | | Min. Tap with One Max. Run | | Copperweld | STR | E | W | L | | |
| | Min. | Max. | | | | | | | | | |

UL Listed and CSA Certified with Copper and Aluminum Conductors

| | | | | | | | | | | |
|------------------|--------|---------|---------|---|---|-----|-----|------|-----|-----|
| SBCT8-C | #8 STR | #6 SOL | #14 STR | — | — | .49 | .62 | 1.10 | 165 | 100 |
| SBCT6-C | #8 STR | #6 STR | #10 STR | — | — | .56 | .68 | 1.28 | 165 | 100 |
| SBCT3-C | #8 STR | #4 STR | #10 STR | — | — | .69 | .80 | 1.55 | 275 | 100 |
| SBCT2-C | #6 STR | #2 STR | #14 STR | — | — | .69 | .80 | 1.54 | 275 | 100 |
| SBCT1/0-L | #4 STR | 1/0 STR | #10 STR | — | — | .75 | .86 | 1.63 | 385 | 50 |
| SBCT2/0-Q | #2 STR | 2/0 STR | #8 STR | — | — | .82 | .99 | 1.82 | 385 | 25 |

UL Listed and CSA Certified with Copper Code Conductors Only

| | | | | | | | | | | |
|-------------------|-----------|------------|---------|-------------|----------|------|------|------|------|-----|
| SBCT10-C | #16 STR | #10 STR | #16 STR | — | — | .38 | .49 | .87 | 80 | 100 |
| SBCT3/0-Q | #1 STR | 3/0 STR | #8 STR | — | — | .88 | 1.12 | 2.01 | 500 | 25 |
| SBCT250-Q | #1 STR | 250 kcmil | #8 STR | — | — | 1.00 | 1.27 | 1.37 | 650 | 25 |
| SBCT350-1 | 2/0 STR | 350 kcmil | 1/0 STR | — | — | 1.50 | 1.63 | 2.57 | 650 | 1 |
| SBCT500-1 | 300 kcmil | 500 kcmil | 2/0 STR | — | — | 1.65 | 1.81 | 3.00 | 825 | 1 |
| SBCT750-1 | 2/0 STR | 750 kcmil | 2/0 STR | 4/0 – 666.6 | 19 No. 5 | 1.93 | 2.11 | 3.78 | 1000 | 1 |
| SBCT1000-1 | 4/0 STR | 1000 kcmil | 4/0 STR | 300 – 900 | — | 2.29 | 2.53 | 4.02 | 1100 | 1 |

The use of PANDUIT oxide inhibiting joint compound (CMP-100) is recommended. See pages D2.123 and D2.161.

UL LISTED SP® Split Bolt, Aluminum

For Use with Copper and Aluminum Code Conductors

Type SBA

- Made from lightweight, durable aluminum alloy to resist corrosion and provide premium electrical and mechanical performance
- Dual rated for use with aluminum to aluminum, aluminum to copper, and copper to copper conductor combinations
- Tin-plated to inhibit corrosion and oxidation
- Wide wire range-taking capability minimizes inventory requirements
- True hex design for body and nut hex provides correct fit with socket, box, or open end wrenches resulting in proper torquing of electrical connection
- Free floating pressure bar separates conductors of dissimilar materials for secure connection on a full range of conductor combinations
- UL Listed and CSA Certified for use up to 600 V and UL temperature rated 90°C

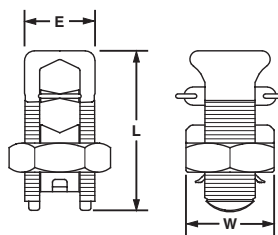

| Part Number | Max. Run to Max. Tap | Min. Run to Min. Tap | Max. Run to Min. Tap | Figure Dimensions (In.) | | | Tightening Torque (In.-Lbs.) | Std. Pkg. Qty. |
|-------------|-----------------------|--|------------------------------|-------------------------|------|------|------------------------------|----------------|
| | | | | E | W | L | | |
| SBA6-C | #6 STR – #6 STR | #10 SOL – #10 SOL | #6 STR – #10 SOL | .56 | .75 | 1.58 | 165 | 100 |
| SBA4-C | #4 STR – #4 STR | #8 SOL – #10 SOL | #4 STR – #10 SOL | .62 | .81 | 1.38 | 165 | 100 |
| SBA2-C | #2 STR – #2 STR | #6 SOL – #8 STR | #2 STR – #8 STR | .69 | .94 | 1.58 | 275 | 100 |
| SBA1/0-Q | 1/0 STR – 1/0 STR | #2 STR (Compact) – #8 SOL | 1/0 STR – #8 SOL | .75 | 1.00 | 1.92 | 385 | 25 |
| SBA2/0-Q | 2/0 STR – 2/0 STR | #2 STR (Compact) – #8 STR | 2/0 STR – #8 STR | .88 | 1.12 | 1.92 | 385 | 25 |
| SBA4/0-Q | 4/0 STR – 4/0 STR | #2 STR (Compact) – #6 STR | 4/0 STR – #6 STR | 1.13 | 1.49 | 2.54 | 500 | 25 |
| ^ SBA350-1 | 350 kcmil – 350 kcmil | 1/0 STR (Compact) – #4 STR | 350 kcmil – #4 STR | 1.50 | 1.69 | 3.24 | 650 | 1 |
| ^ SBA500-1 | 500 kcmil – 500 kcmil | 400 kcmil (Compact) – #2 STR (Compact) | 500 kcmil – #2 STR (Compact) | 1.73 | 2.00 | 3.62 | 825 | 1 |

The use of PANDUIT oxide inhibiting joint compound (CMP-100) is recommended. See page D2.161.
 ^Not CSA Certified.

UL LISTED Two-Bolt Connector, Bronze

For Use with Copper Code Conductors

Type VT

- Made from high strength bronze for heavy duty connections and to inhibit corrosion
- Cap swivels for easy installation of conductors
- Rubber washer retains hardware to connector and eliminates loose parts
- High strength silicon-bronze hardware provides premium mechanical performance when assembled to conductor
- Wide wire range-taking capability minimizes inventory requirements
- UL Listed for use up to 600 V and 90°C temperature rated

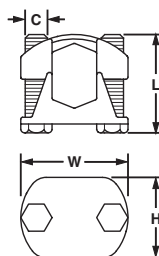

| Part Number | Copper Conductor Size | | Figure Dimensions (In.) | | | | Hex Size | Tightening Torque (In.-Lbs.) | Std. Pkg. Qty. |
|-------------|------------------------|----------------------|-------------------------|------|------|-----|----------|------------------------------|----------------|
| | Run | Tap | L | W | H | C | | | |
| VT-0-Q | #2 STR – 1/0 STR | #10 STR – 1/0 STR | 1.50 | 1.44 | .94 | .31 | 1/2 | 180 | 25 |
| VT-1-Q | #2 STR – 2/0 STR | #10 STR – 2/0 STR | 1.50 | 1.56 | 1.13 | .31 | 1/2 | 180 | 25 |
| VT-2-Q | 1/0 STR – 4/0 STR | #10 STR – 4/0 STR | 1.75 | 1.84 | 1.34 | .38 | 9/16 | 240 | 25 |
| VT-3-12 | 250 kcmil – 350 kcmil | #10 STR – 350 kcmil | 2.00 | 2.31 | 1.63 | .50 | 3/4 | 480 | 12 |
| VT-4-12 | 250 kcmil – 500 kcmil | #10 STR – 500 kcmil | 2.25 | 2.44 | 1.69 | .50 | 3/4 | 480 | 12 |
| VT-5-6 | 400 kcmil – 800 kcmil | 3/0 STR – 800 kcmil | 2.50 | 2.69 | 1.88 | .50 | 9/16 | 480 | 6 |
| VT-6-6 | 500 kcmil – 1000 kcmil | 3/0 STR – 1000 kcmil | 2.75 | 3.06 | 2.25 | .63 | 15/16 | 660 | 6 |

- A. System Overview
- B1. Cable Ties
- B2. Cable Accessories
- B3. Stainless Steel Ties
- C1. Wiring Duct
- C2. Surface Raceway
- C3. Abrasion Protection
- C4. Cable Management
- D1. Terminals
- D2. Power Connectors
- D3. Grounding Connectors
- E1. Labeling Systems
- E2. Labels
- E3. Pre-Printed & Write-On Markers
- E4. Permanent Identification
- E5. Lockout/Tagout & Safety Solutions
- F. Index

A. System Overview

B1. Cable Ties

B2. Cable Accessories

B3. Stainless Steel Ties

C1. Wiring Duct

C2. Surface Raceway

C3. Abrasion Protection

C4. Cable Management

D1. Terminals

D2. Power Connectors

D3. Grounding Connectors

E1. Labeling Systems

E2. Labels

E3. Pre-Printed & Write-On Markers

E4. Permanent Identification

E5. Lockout/Tagout & Safety Solutions

F. Index

Two-Bolt Connector, Bronze, Tin-Plated

For Use with Copper and Aluminum Code Conductors

Type VTA

- Made from high strength bronze for heavy duty connections
- Tin-plated to inhibit corrosion and oxidation
- Cap swivels for easy installation of conductors
- Rubber washer retains hardware to connector and eliminates loose parts
- High strength silicon-bronze hardware provides premium mechanical performance when assembled to conductor
- Offered for use with aluminum conductors, but not UL Listed
- UL Listed for use up to 600 V and 90°C temperature rated when used with copper code conductor

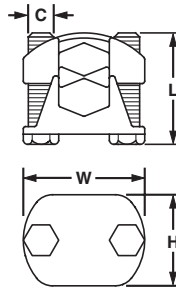

| Part Number | Max. Copper Conductor Size | Max. Aluminum Conductor Size* | Copperweld Solid | Figure Dimensions (In.) | | | | Hex Size (In.) | Tightening Torque (In.-Lbs.) | Std. Pkg. Qty. |
|-------------|----------------------------|-------------------------------|------------------|-------------------------|------|------|------|----------------|------------------------------|----------------|
| | | | | L | W | H | C | | | |
| VTA-0-Q | 2/0 SOL – 1/0 STR | 1/0 STR – 1 ACSR | 2/0 | 1.25 | 1.44 | .94 | 5/16 | 1/2 | 180 | 25 |
| VTA-1-Q | 3/0 SOL – 2/0 STR | — | 3/0 | 1.50 | 1.56 | 1.13 | 5/16 | 1/2 | 180 | 25 |
| VTA-2-Q | 4/0 SOL – 4/0 STR | — | 4/0 | 1.75 | 1.84 | 1.34 | 3/8 | 9/16 | 240 | 25 |
| VTA-3-12 | 350 kcmil | — | — | 2.00 | 2.31 | 1.63 | 1/2 | 3/4 | 480 | 12 |
| VTA-4-12 | 500 kcmil | — | — | 2.25 | 2.44 | 1.69 | 1/2 | 3/4 | 480 | 12 |
| VTA-5-6 | 800 kcmil | — | — | 2.50 | 2.69 | 1.88 | 1/2 | 3/4 | 480 | 6 |
| VTA-6-6 | 1000 kcmil | — | — | 2.75 | 3.06 | 2.25 | 5/8 | 15/16 | 660 | 6 |

*Not UL Listed.

One-Hole, Straight Tongue, Barrel Post Lug

For Use with Copper Code Conductors

Type ML

- Made from high strength electrolytic copper to provide premium electrical and mechanical performance
- Compact design saves space
- Wide wire range-taking capability minimizes inventory requirements
- Inspection window to visually assure full conductor insertion
- Plated steel set screw provides high strength, durable electrical contact between conductor and connector
- Flat bottom allows for complete contact with mounting surface
- UL Listed for use up to 600 V and temperature rated 90°C

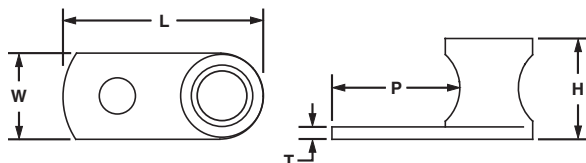

| Part Number | Copper Conductor Size Range | Stud Hole Size (In.) | Hex Key Size (In.) | Figure Dimensions (In.) | | | | | Tightening Torque (In.-Lbs.) | Std. Pkg. Qty. |
|-----------------|-----------------------------|----------------------|--------------------|-------------------------|-----|------|-----|------|------------------------------|----------------|
| | | | | L | W | H | T | P | | |
| ML8-CY | #14 SOL – #8 STR | 3/16 | ** | .81 | .38 | .38 | .08 | .48 | 25 | 100 |
| ML4-CY | #14 SOL – #4 STR | 1/4 | ** | 1.13 | .50 | .53 | .09 | .63 | 45 | 100 |
| ML1/0-LY | #8 SOL – 1/0 STR | 5/16 | 1/4 | 1.50 | .75 | .75 | .09 | .80 | 200 | 50 |
| ML250-QY | #6 STR – 250 kcmil | 3/8 | 1/4 | 1.94 | .94 | 1.06 | .13 | 1.00 | 200 | 25 |

**Uses slotted head set screw.

One-Hole, Straight Tongue, Tin-Plated, Barrel Post Lug

For Use with Copper Code Conductors

Type ML-T

- Made from high strength, electrolytic copper to provide premium electrical and mechanical performance
- Tin-plated to inhibit corrosion
- Compact design saves space
- Wide wire range-taking capability minimizes inventory requirements
- Inspection window to visually assure full conductor insertion
- Plated steel set screw provides high strength, durable electrical contact between conductor and connector
- Flat bottom allows for complete contact with mounting surface
- UL Listed for use up to 600 V and temperature rated 90°C

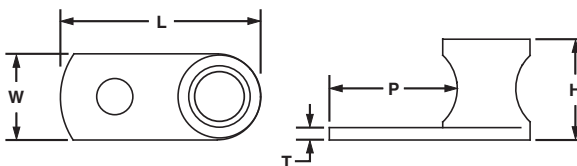

| Part Number | Copper Conductor Size Range | Stud Hole Size (In.) | Hex Key Size (In.) | Figure Dimensions (In.) | | | | | Tightening Torque (In.-Lbs.) | Std. Pkg. Qty. |
|-------------|-----------------------------|----------------------|--------------------|-------------------------|-----|------|-----|------|------------------------------|----------------|
| | | | | L | W | H | T | P | | |
| ML8T-CY | #14 SOL – #8 STR | 3/16 | ** | .81 | .38 | .38 | .08 | .48 | 25 | 100 |
| ML4T-CY | #14 SOL – #4 STR | 1/4 | ** | 1.13 | .50 | .53 | .09 | .63 | 45 | 100 |
| ML1/0T-LY | #8 SOL – 1/0 STR | 5/16 | 1/4 | 1.50 | .75 | .75 | .09 | .80 | 200 | 50 |
| ML250T-QY | #6 STR – 250 kcmil | 3/8 | 1/4 | 1.94 | .94 | 1.06 | .13 | 1.00 | 200 | 25 |

**Uses slotted head set screw.

One-Hole, Straight Tongue Lug

For Use with Copper Code Conductors

Type PNL

- Cast from high strength corrosion resistant copper alloy to provide premium electrical and mechanical performance
- Compact design saves space
- Wide wire range-taking capability minimizes inventory requirements
- Inspection window to visually assure full conductor insertion
- Plated steel set screw provides high strength, durable electrical contact between conductor and connector
- Flat bottom allows for complete contact with mounting surface
- UL Listed and CSA Certified for use up to 600 V and UL temperature rated 90°C

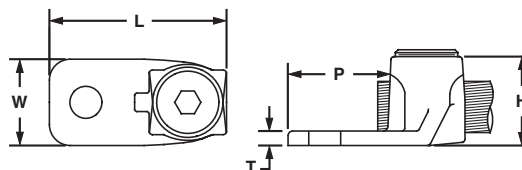

| Part Number | Copper Conductor Size Range | Stud Hole Size (In.) | Hex Key Size (In.) | Figure Dimensions (In.) | | | | | Tightening Torque (In.-Lbs.) | Std. Pkg. Qty. |
|-------------|-----------------------------|----------------------|--------------------|-------------------------|------|------|-----|------|------------------------------|----------------|
| | | | | L | W | H | T | P | | |
| PNL-8-C | #14 SOL – #8 STR | #10 | ** | .88 | .38 | .44 | .09 | .50 | 25 | 100 |
| PNL-4-C | #14 SOL – #4 STR | 1/4 | ** | 1.25 | .53 | .56 | .14 | .66 | 45 | 100 |
| PNL-1/0-L | #8 SOL – 1/0 STR | 5/16 | 1/4 | 1.59 | .73 | .78 | .14 | .85 | 200 | 50 |
| PNL-250-Q | #6 SOL – 250 kcmil | 3/8 | 5/16 | 1.97 | .94 | 1.05 | .13 | 1.00 | 275 | 25 |
| PNL-500-3 | #4 SOL – 500 kcmil | 1/2 | 3/8 | 3.00 | 1.38 | 1.47 | .25 | 1.63 | 375 | 3 |
| PNL-1000-3 | 500 kcmil – 1000 kcmil | 1/2 | 1/2 | 3.88 | 1.75 | 2.00 | .38 | 2.13 | 500 | 3 |

**Uses slotted head set screw.

A. System Overview

B1. Cable Ties

B2. Cable Accessories

B3. Stainless Steel Ties

C1. Wiring Duct

C2. Surface Raceway

C3. Abrasion Protection

C4. Cable Management

D1. Terminals

D2. Power Connectors

D3. Grounding Connectors

E1. Labeling Systems

E2. Labels

E3. Pre-Printed & Write-On Markers

E4. Permanent Identification

E5. Lockout/Tagout & Safety Solutions

F. Index

A. System Overview

B1. Cable Ties

B2. Cable Accessories

B3. Stainless Steel Ties

C1. Wiring Duct

C2. Surface Raceway

C3. Abrasion Protection

C4. Cable Management

D1. Terminals

D2. Power Connectors

D3. Grounding Connectors

E1. Labeling Systems

E2. Labels

E3. Pre-Printed & Write-On Markers

E4. Permanent Identification

E5. Lockout/Tagout & Safety Solutions

F. Index

One-Hole, Straight Tongue Lug with Internal Pressure Plate

For Use with Copper Code Conductors

Type HL

- Cast from high strength corrosion resistant copper alloy to provide premium electrical and mechanical performance
- Compact design saves space
- Wide wire range-taking capability minimizes inventory requirements
- Pressure plate* provides uniform clamping force on conductor for premium electrical performance
- Plated steel set screw provides high strength, durable electrical contact between conductor and connector
- Flat bottom allows for complete contact with mounting surface
- Inspection window to visually assure full conductor insertion
- UL Listed for use up to 600 V and temperature rated 90°C

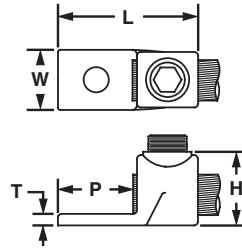

| Part Number | Copper Conductor Size Range | Stud Hole Size (In.) | Hex Key Size (In.) | Figure Dimensions (In.) | | | | | Tightening Torque (In.-Lbs.) | Std. Pkg. Qty. |
|-------------|-----------------------------|----------------------|--------------------|-------------------------|------|------|-----|------|------------------------------|----------------|
| | | | | L | W | H | T | P | | |
| HL1-25-X | #14 SOL – #8 STR | 1/4 | ** | 1.25 | .56 | .79 | .19 | .63 | 20 | 10 |
| HL4-1-X | #8 SOL – #4 STR | 1/4 | ** | 1.25 | .56 | .79 | .19 | .63 | 35 | 10 |
| HL8-1-X | #4 SOL – #1 STR | 1/4 | 7/16 | 1.56 | .75 | .90 | .22 | .69 | 100 | 10 |
| HL13-1-5 | #1 STR – 2/0 STR | 3/8 | 9/16 | 1.88 | .81 | 1.14 | .22 | .88 | 250 | 5 |
| HL21-1-5 | 2/0 STR – 4/0 STR | 3/8 | 9/16 | 2.19 | 1.00 | 1.31 | .25 | 1.00 | 250 | 5 |
| HL30-1-2 | 4/0 STR – 300 kcmil | 1/2 | 5/8 | 2.50 | 1.06 | 1.47 | .31 | 1.25 | 350 | 2 |
| HL50-1-2 | 300 kcmil – 500 kcmil | 1/2 | 3/4 | 3.00 | 1.38 | 1.65 | .34 | 1.50 | 480 | 2 |

*HL1-25-X and HL4-1-X do not include pressure plates.
**Uses slotted head set screw.

One-Hole, Straight Tongue, Flag Lug

For Use with Copper Code Conductors

Type HLB

- Provides connection of conductor at right angles to terminal bar
- Cast from high strength corrosion resistant copper alloy to provide premium electrical and mechanical performance
- Compact design saves space
- Wire range-taking capability minimizes inventory requirements
- Internal pressure plate provides uniform clamping force on conductor for premium electrical performance
- Flush bottom allows for complete contact with mounting surface
- Inspection window to visually assure full conductor insertion
- UL Listed for use up to 600 V and temperature rated 90°C

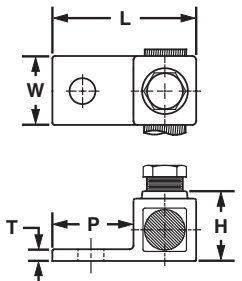

| Part Number | Copper Conductor Size Range | Stud Hole Size (In.) | Hex Key Size (In.) | Figure Dimensions (In.) | | | | | Tightening Torque (In.-Lbs.) | Std. Pkg. Qty. |
|-------------|-----------------------------|----------------------|--------------------|-------------------------|-----|-----|-----|-----|------------------------------|----------------|
| | | | | L | W | H | T | P | | |
| HLB4-1-X | #8 SOL – #4 STR | 1/4 | ** | 1.25 | .50 | .79 | .19 | .63 | 35 | 10 |

**Uses slotted head set screw.

UL LISTED One-Hole, Straight Tongue, 90° Lug

For Use with Copper Code Conductors

Type HLA-90

- Provides connection of conductor at right angles to terminal bar
- Cast from high strength corrosion resistant copper alloy to provide premium electrical and mechanical performance
- Compact design saves space
- Wide wire range-taking capability minimizes inventory requirements
- Internal pressure plate provides uniform clamping force on conductor for premium electrical performance
- Flush bottom allows for complete contact with mounting surface
- UL Listed for use up to 600 V and temperature rated 90°C

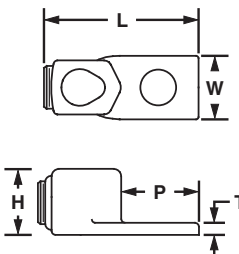

| Part Number | Copper Conductor Size Range | Stud Hole Size (In.) | Hex Key Size (In.) | Figure Dimensions (In.) | | | | | Tightening Torque (In.-Lbs.) | Std. Pkg. Qty. |
|--------------|-----------------------------|----------------------|--------------------|-------------------------|------|------|-----|------|------------------------------|----------------|
| | | | | L | W | H | T | P | | |
| HLA4-1-90-X | #8 SOL – #4 STR | 1/4 | ** | 1.81 | .56 | .73 | .19 | .63 | 35 | 10 |
| HLA8-1-90-X | #4 SOL – #1 STR | 1/4 | 7/16 | 1.50 | .75 | .75 | .22 | .69 | 100 | 10 |
| HLA13-1-90-5 | #1 STR – 2/0 STR | 3/8 | 9/16 | 2.38 | .81 | 1.00 | .22 | .88 | 250 | 5 |
| HLA21-1-90-5 | 2/0 STR – 4/0 STR | 3/8 | 9/16 | 2.69 | 1.00 | 1.14 | .25 | 1.00 | 250 | 5 |

**Uses slotted head set screw.

UL LISTED Two-Hole, Straight Tongue Lug

For Use with Copper Code Conductors

Type PNL-2

- Cast from high strength corrosion resistant copper alloy to provide premium electrical and mechanical performance
- Wide wire range-taking capability minimizes inventory requirements
- Inspection window to visually assure full conductor insertion
- Plated steel set screw provides high strength, durable electrical contact between conductor and connector
- Flat bottom allows for complete contact with mounting surface
- UL Listed for use up to 600 V and temperature rated 90°C
- Available with NEMA hole sizes and spacing

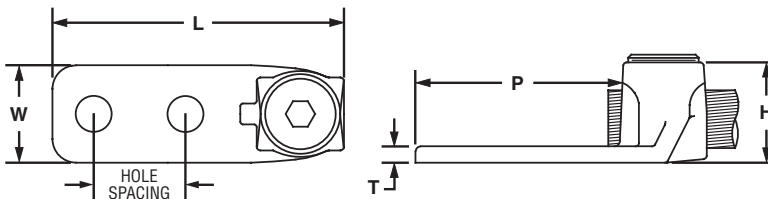

| Part Number | Copper Conductor Size Range | Stud Hole Size (In.) | Stud Hole Spacing (In.) | Hex Key Size (In.) | Figure Dimensions (In.) | | | | | Tightening Torque (In.-Lbs.) | Std. Pkg. Qty. |
|--------------|-----------------------------|----------------------|-------------------------|--------------------|-------------------------|------|------|-----|------|------------------------------|----------------|
| | | | | | L | W | H | T | P | | |
| PNL-1/0-2-L | #8 SOL – 1/0 STR | 5/16 | 1.00 | 1/4 | 2.75 | .75 | .84 | .19 | 2.00 | 200 | 50 |
| PNL-250-2-Q | #6 SOL – 250 kcmil | 3/8 | 1.00 | 1/4 | 2.88 | .94 | 1.03 | .22 | 2.02 | 200 | 25 |
| PNL-500-2-3 | #4 SOL – 500 kcmil | 3/8 | 1.00 | 3/8 | 3.38 | 1.38 | 1.47 | .31 | 2.00 | 375 | 3 |
| PNL-1000-2-3 | 500 kcmil – 1000 kcmil | 1/2 | 1.50 | 3/8 | 4.88 | 1.75 | 2.00 | .38 | 3.13 | 375 | 3 |

A.
System
Overview

B1.
Cable Ties

B2.
Cable
Accessories

B3.
Stainless
Steel Ties

C1.
Wiring
Duct

C2.
Surface
Raceway

C3.
Abrasion
Protection

C4.
Cable
Management

D1.
Terminals

D2.
Power
Connectors

D3.
Grounding
Connectors

E1.
Labeling
Systems

E2.
Labels

E3.
Pre-Printed
& Write-On
Markers

E4.
Permanent
Identification

E5.
Lockout/
Tagout/
& Safety
Solutions

F.
Index

Two-Hole, Straight Tongue Lug with Internal Pressure Plate

For Use with Copper Code Conductors

Type HL-2

- Cast from high strength corrosion resistant copper alloy to provide premium electrical and mechanical performance
- Wide wire range-taking capability minimizes inventory requirements
- Internal pressure plate provides uniform clamping force on conductor for premium electrical performance
- Plated steel set screw provides high strength, durable electrical contact between conductor and connector
- Inspection window to visually assure full conductor insertion
- Flat bottom allows for complete contact with mounting surface
- UL Listed for use up to 600 V and temperature rated 90°C

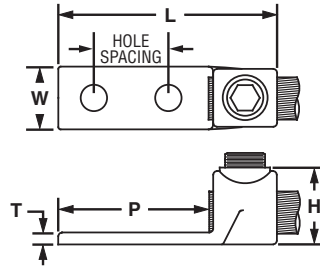

| Part Number | Copper Conductor Size Range | Stud Hole Size (In.) | Stud Hole Spacing (In.) | Hex Key Size (In.) | Figure Dimensions (In.) | | | | | Tightening Torque (In.-Lbs.) | Std. Pkg. Qty. |
|-------------------|-----------------------------|----------------------|-------------------------|--------------------|-------------------------|------|------|-----|------|------------------------------|----------------|
| | | | | | L | W | H | T | P | | |
| HL1-2-25-X | #14 SOL – #8 STR | 1/4 | .63 | ** | 2.00 | .56 | .70 | .19 | 1.25 | 20 | 10 |
| HL4-2-X | #8 SOL – #4 STR | 1/4 | .63 | ** | 2.00 | .56 | .69 | .18 | 1.25 | 35 | 10 |
| HL8-2-X | #4 SOL – #1 STR | 1/4 | .75 | 7/16 | 2.44 | .75 | .92 | .22 | 1.50 | 100 | 10 |
| HL13-2-5 | #1 STR – 2/0 STR | 5/16 | 1.00 | 9/16 | 2.88 | .81 | 1.07 | .22 | 1.88 | 250 | 5 |
| HL21-2-5 | 2/0 STR – 4/0 STR | 3/8 | 1.00 | 9/16 | 3.00 | 1.00 | 1.33 | .25 | 1.75 | 250 | 5 |
| HL30-2-2 | 4/0 STR – 300 kcmil | 3/8 | 1.00 | 5/8 | 3.13 | 1.06 | 1.45 | .31 | 2.00 | 350 | 2 |
| HL50-2-2 | 300 kcmil – 500 kcmil | 3/8 | 1.00 | 3/4 | 3.44 | 1.38 | 1.66 | .34 | 2.00 | 480 | 2 |

**Uses slotted head set screw.



Two-Hole, Straight Tongue Lug with NEMA Hole Sizes and Spacing

For Use with Copper Code Conductors

Type HL-2N

- Cast from high strength corrosion resistant copper alloy to provide premium electrical and mechanical performance
- Wide wire range-taking capability minimizes inventory requirements
- Internal pressure plate provides uniform clamping force on conductor for premium electrical performance
- Internal barrel serrations allow for premium wire pull-out strength
- Inspection window to visually assure full conductor insertion
- Flat bottom allows for complete contact with mounting surface
- UL Listed for use up to 600 V and temperature rated 90°C
- Available with NEMA hole sizes and spacing

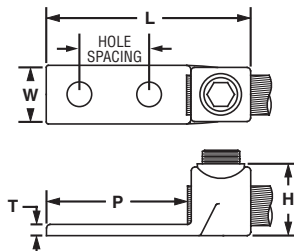

| Part Number | Copper Conductor Size Range | Stud Hole Size (In.) | Stud Hole Spacing (In.) | Hex Key Size (In.) | Figure Dimensions (In.) | | | | | Tightening Torque (In.-Lbs.) | Std. Pkg. Qty. |
|-------------|-----------------------------|----------------------|-------------------------|--------------------|-------------------------|------|------|-----|------|------------------------------|----------------|
| | | | | | L | W | H | T | P | | |
| ◆ HL8-2N-X | #4 SOL – #1 STR | 1/2 | 1.75 | 7/16 | 3.94 | 1.00 | .90 | .22 | 3.00 | 100 | 10 |
| ◆ HL13-2N-5 | #1 STR – 2/0 STR | 1/2 | 1.75 | 9/16 | 4.25 | 1.00 | 1.07 | .22 | 3.00 | 250 | 5 |
| ◆ HL21-2N-5 | 2/0 STR – 4/0 STR | 1/2 | 1.75 | 9/16 | 4.19 | 1.25 | 1.34 | .25 | 3.00 | 250 | 5 |
| ◆ HL30-2N-2 | 4/0 STR – 300 kcmil | 1/2 | 1.75 | 5/8 | 4.25 | 1.25 | 1.46 | .31 | 3.00 | 350 | 2 |

◆NEMA hole sizes and spacing.



Two-Hole, Straight Tongue, Tandem Set Screw Lug

For Use with Copper Code Conductors

Type HHL-2N

- Cast from high strength corrosion resistant copper alloy to provide premium electrical and mechanical performance
- Double set screws provide additional wire secureness for use in heavy duty applications
- Wide wire range-taking capability minimizes inventory requirements
- Internal pressure plate provides uniform clamping force on conductor for premium electrical performance
- Internal barrel serrations allow for premium wire pull-out strength
- Inspection window to visually assure full conductor insertion
- Flat bottom allows for complete contact with mounting surface
- UL Listed for use up to 600 V and temperature rated 90°C
- Available with NEMA hole sizes and spacing

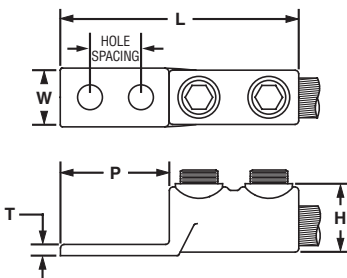

| Part Number | Copper Conductor Size Range | Stud Hole Size (In.) | Stud Hole Spacing (In.) | Hex Key Size (In.) | Figure Dimensions (In.) | | | | | Tightening Torque (In.-Lbs.) | Std. Pkg. Qty. |
|--------------|-----------------------------|----------------------|-------------------------|--------------------|-------------------------|------|------|-----|------|------------------------------|----------------|
| | | | | | L | W | H | T | P | | |
| ◆ HHL8-2N-X | #4 SOL – #1 STR | 1/2 | 1.75 | 7/16 | 5.13 | 1.00 | .80 | .22 | 3.00 | 100 | 10 |
| ◆ HHL13-2N-5 | #1 STR – 2/0 STR | 1/2 | 1.75 | 9/16 | 4.88 | 1.25 | 1.00 | .22 | 3.00 | 250 | 5 |
| ◆ HHL21-2N-5 | 2/0 STR – 4/0 STR | 1/2 | 1.75 | 9/16 | 5.63 | 1.50 | 1.37 | .25 | 3.00 | 250 | 5 |
| ◆ HHL30-2N-1 | 4/0 STR – 300 kcmil | 1/2 | 1.75 | 5/8 | 5.88 | 1.50 | 1.45 | .31 | 3.00 | 350 | 1 |

◆NEMA hole sizes and spacing.

A. System Overview

B1. Cable Ties

B2. Cable Accessories

B3. Stainless Steel Ties

C1. Wiring Duct

C2. Surface Raceway

C3. Abrasion Protection

C4. Cable Management

D1. Terminals

D2. Power Connectors

D3. Grounding Connectors

E1. Labeling Systems

E2. Labels

E3. Pre-Printed & Write-On Markers

E4. Permanent Identification

E5. Lockout/Tagout & Safety Solutions

F. Index

A. System Overview

B1. Cable Ties

B2. Cable Accessories

B3. Stainless Steel Ties

C1. Wiring Duct

C2. Surface Raceway

C3. Abrasion Protection

C4. Cable Management

D1. Terminals

D2. Power Connectors

D3. Grounding Connectors

E1. Labeling Systems

E2. Labels

E3. Pre-Printed & Write-On Markers

E4. Permanent Identification

E5. Lockout/Tagout & Safety Solutions

F. Index

UL LISTED Two-Hole, Straight Tongue, Two-Barrel Lug

For Use with Copper Code Conductors

Type H2L-2N

- Allows for termination of two copper conductors
- Cast from high strength corrosion resistant copper alloy to provide premium electrical and mechanical performance
- Wide wire range-taking capability minimizes inventory requirements
- Internal pressure plate provides uniform clamping force on conductor for premium electrical performance
- Internal barrel serrations provide premium wire pull-out strength
- Inspection window to visually assure full conductor insertion
- Flat bottom allows for complete contact with mounting surface
- UL Listed for use up to 600 V and temperature rated 90°C
- Available with NEMA hole sizes and spacing

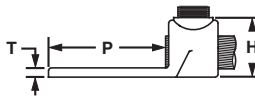
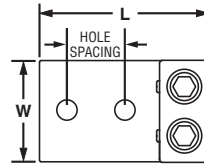

| Part Number | Copper Conductor Size Range | Stud Hole Size (In.) | Stud Hole Spacing (In.) | Hex Key Size (In.) | Figure Dimensions (In.) | | | | | Tightening Torque (In.-Lbs.) | Std. Pkg. Qty. |
|--------------|-----------------------------|----------------------|-------------------------|--------------------|-------------------------|------|------|-----|------|------------------------------|----------------|
| | | | | | L | W | H | T | P | | |
| ◆ H2L4-2N-X | #8 SOL – #4 STR | 1/2 | 1.75 | ** | 3.75 | 1.25 | .76 | .19 | 3.00 | 35 | 10 |
| ◆ H2L8-2N-2 | #4 SOL – #1 STR | 1/2 | 1.75 | 7/16 | 3.94 | 1.38 | .92 | .22 | 3.00 | 100 | 2 |
| ◆ H2L13-2N-2 | #1 STR – 2/0 STR | 1/2 | 1.75 | 9/16 | 4.00 | 1.63 | 1.06 | .22 | 3.00 | 250 | 2 |
| ◆ H2L21-2N-2 | 2/0 STR – 4/0 STR | 1/2 | 1.75 | 9/16 | 4.19 | 1.88 | 1.34 | .31 | 3.00 | 250 | 2 |
| ◆ H2L30-2N-1 | 4/0 STR – 300 kcmil | 1/2 | 1.75 | 5/8 | 4.38 | 2.00 | 1.45 | .31 | 3.00 | 350 | 1 |

**Uses slotted head set screw.
◆NEMA hole sizes and spacing.

UL LISTED Two-Hole, Straight Tongue, Two-Barrel, Tin-Plated Lug

For Use with Copper Code Conductors

Type P2NLT

- Allows for termination of two copper conductors
- Cast from high strength corrosion resistant copper alloy to provide premium electrical and mechanical performance
- Tin-plated to inhibit corrosion
- Wide wire range-taking capability minimizes inventory requirements
- Internal barrel serrations provide premium wire pull-out strength
- Inspection window to visually assure full conductor insertion
- Plated steel set screw provides high strength, durable electrical contact
- Flat bottom allows for complete contact with mounting surface
- UL Listed for use up to 600 V and temperature rated 90°C
- Available with NEMA hole sizes and spacing

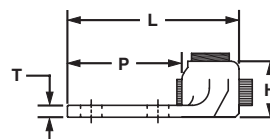
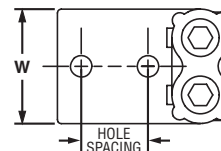

| Part Number | Copper Conductor Size Range | Stud Hole Size (In.) | Stud Hole Spacing (In.) | Hex Key Size (In.) | Figure Dimensions (In.) | | | | | Tightening Torque (In.-Lbs.) | Std. Pkg. Qty. |
|---------------|-----------------------------|----------------------|-------------------------|--------------------|-------------------------|------|------|-----|------|------------------------------|----------------|
| | | | | | L | W | H | T | P | | |
| ◆ P2NLT-500-3 | #4 SOL – 500 kcmil | 1/2 | 1.75 | 3/8 | 4.50 | 2.50 | 1.47 | .38 | 3.00 | 375 | 3 |

◆NEMA hole sizes and spacing.

Two-Set Screw Splice

For Use with Copper Code Conductors

Type PNLC

- Cast from high strength corrosion resistant copper alloy to provide premium electrical and mechanical performance
- Wide wire range-taking capability minimizes inventory requirements
- Plated steel set screw provides high strength, durable electrical contact between conductor and connector
- Internal wire stops to prevent over-insertion of conductor
- For use up to 600 V and temperature rated 90°C

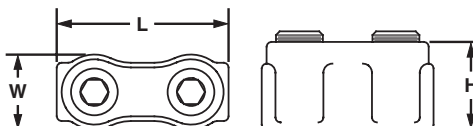

| Part Number | Copper Conductor Size Range | Hex Key Size (In.) | Figure Dimensions (In.) | | | Tightening Torque (In.-Lbs.) | Std. Pkg. Qty. |
|-------------|-----------------------------|--------------------|-------------------------|------|------|------------------------------|----------------|
| | | | L | W | H | | |
| PNLC-1/0-3 | #8 SOL – 1/0 STR | 1/4 | 1.63 | .72 | .84 | 200 | 3 |
| PNLC-250-1 | #6 SOL – 250 kcmil | 3/8 | 2.13 | .97 | 1.06 | 375 | 1 |
| PNLC-500-1 | #4 SOL – 500 kcmil | 3/8 | 3.00 | 1.38 | 1.47 | 375 | 1 |



Two-Set Screw Splice with Internal Pressure Plate

For Use with Copper Code Conductors

Type HC

- Cast from high strength corrosion resistant copper alloy to provide premium electrical and mechanical performance
- Wide wire range-taking capability minimizes inventory requirements
- Internal pressure plate provides uniform clamping force on conductor for premium electrical performance
- Internal barrel serrations provide premium wire pull-out strength
- Internal wire stops to prevent over-insertion of conductor
- UL Listed for use up to 600 V and temperature rated 90°C

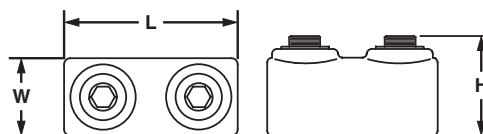

| Part Number | Copper Conductor Size Range | Hex Key Size (In.) | Figure Dimensions (In) | | | Tightening Torque (In.-Lbs.) | Std. Pkg. Qty. |
|-------------|-----------------------------|--------------------|------------------------|------|------|------------------------------|----------------|
| | | | L | W | H | | |
| HC4-3* | #8 SOL – #4 STR | ** | 1.25 | .50 | .56 | 35 | 3 |
| HC8-3* | #4 SOL – #1 STR | 7/16 | 1.75 | .69 | .81 | 100 | 3 |
| HC13-3 | #1 STR – 2/0 STR | 9/16 | 2.00 | .81 | .94 | 250 | 3 |
| HC21-1 | 2/0 STR – 4/0 STR | 9/16 | 2.25 | 1.00 | 1.19 | 250 | 1 |
| HC30-1 | 4/0 STR – 300 kcmil | 5/8 | 2.56 | 1.19 | 1.44 | 350 | 1 |
| HC50-1 | 300 kcmil – 500 kcmil | 3/4 | 3.00 | 1.38 | 1.63 | 480 | 1 |

*Includes swivel screws, not internal pressure plate.

**Uses slotted head set screw.

A. System Overview

B1. Cable Ties

B2. Cable Accessories

B3. Stainless Steel Ties

C1. Wiring Duct

C2. Surface Raceway

C3. Abrasion Protection

C4. Cable Management

D1. Terminals

D2. Power Connectors

D3. Grounding Connectors

E1. Labeling Systems

E2. Labels

E3. Pre-Printed & Write-On Markers

E4. Permanent Identification

E5. Lockout/Tagout & Safety Solutions

F. Index

A. System Overview

B1. Cable Ties

B2. Cable Accessories

B3. Stainless Steel Ties

C1. Wiring Duct

C2. Surface Raceway

C3. Abrasion Protection

C4. Cable Management

D1. Terminals

D2. Power Connectors

D3. Grounding Connectors

E1. Labeling Systems

E2. Labels

E3. Pre-Printed & Write-On Markers

E4. Permanent Identification

E5. Lockout/Tagout & Safety Solutions

F. Index



One-Hole, Straight Fixed Tongue Lug

For Use with Stranded Copper Code Conductors

Type CX

- Made from high strength electrolytic copper to provide premium electrical and mechanical performance
- Compact design saves space
- Wide wire range-taking capability minimizes inventory requirements
- Inspection window to visually assure full conductor insertion
- Plated steel set screw provides high strength, durable electrical contact between conductor and connector
- UL Listed and CSA Certified for use up to 600 V

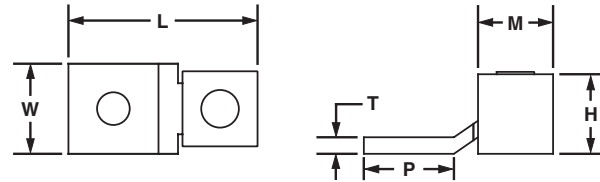

| Part Number | Copper Conductor Size Range | Current Rating (Amps) | Stud Hole Size (In.) | Hex Size (In.) | Figure Dimensions (In.) | | | | | | Tightening Torque (In.-Lbs.) | Std. Pkg. Qty. |
|--------------------|---|-----------------------|----------------------|----------------|-------------------------|------|------|-----|------|------|------------------------------|----------------|
| | | | | | L | W | H | T | P | M | | |
| CX35-36-CY | #14 – 6 AWG | 35 | 3/16 | ** | 1.02 | .38 | .48 | .07 | .44 | .38 | 25 | 100 |
| CX70-14-CY | #14 – 4 AWG, (2) #14 AWG, (2) #12 AWG | 70 | 1/4 | ** | 1.27 | .50 | .57 | .08 | .59 | .50 | 35 | 100 |
| CX125-14-QY | #4 – 1/0 AWG | 125 | 1/4 | ** | 1.53 | .62 | .77 | .32 | .84 | .62 | 50 | 25 |
| CX225-56-QY | #2 – 4/0 AWG | 225 | 5/16 | 9/16 | 2.19 | 1.00 | 1.13 | .13 | 1.06 | 1.00 | 50 | 25 |
| CX400-38-3Y | 4/0 AWG – 500 kcmil | 400 | 3/8 | 3/4 | 3.16 | 1.50 | 1.65 | .19 | 1.69 | 1.38 | 50 | 3 |

**Uses slotted head set screw.



One-Hole, Straight Fixed Tongue, Tin-Plated Lug

For Use with Stranded Copper Code Conductors

Type CX-T

- Made from high strength electrolytic copper to provide premium electrical and mechanical performance
- Tin-plated to inhibit corrosion
- Compact design saves space
- Wide wire range-taking capability minimizes inventory requirements
- Inspection window to visually assure full conductor insertion
- Plated steel set screw provides high strength, durable electrical contact between conductor and connector
- UL Listed and CSA Certified for use up to 600 V

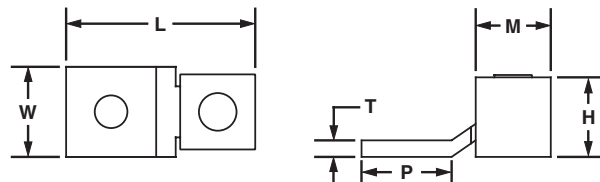

| Part Number | Copper Conductor Size Range | Current Rating (Amps) | Stud Hole Size (In.) | Hex Size (In.) | Figure Dimensions (In.) | | | | | | Tightening Torque (In.-Lbs.) | Std. Pkg. Qty. |
|-----------------------|---|-----------------------|----------------------|----------------|-------------------------|------|------|-----|------|------|------------------------------|----------------|
| | | | | | L | W | H | T | P | M | | |
| CX35-36T-CY | #14 – 6 AWG | 35 | 3/16 | ** | 1.02 | .38 | .48 | .07 | .44 | .38 | 25 | 100 |
| CX70-14T-CY | #14 – 4 AWG, (2) #14 AWG, (2) #12 AWG | 70 | 1/4 | ** | 1.27 | .50 | .57 | .08 | .59 | .50 | 35 | 100 |
| CX125-56T-QY | #4 – 1/0 AWG | 125 | 5/16 | ** | 1.53 | .62 | .77 | .13 | .84 | .62 | 50 | 25 |
| CX225-38T-QY | #2 – 4/0 AWG | 225 | 3/8 | 9/16 | 2.19 | 1.00 | 1.13 | .13 | 1.06 | 1.00 | 50 | 25 |
| CX225-56T-QY | #2 – 4/0 AWG | 225 | 5/16 | 9/16 | 2.19 | 1.00 | 1.13 | .13 | 1.06 | 1.00 | 50 | 25 |
| CX400-12T-3Y‡‡ | 4/0 AWG – 500 kcmil | 400 | 1/2 | 3/4 | 3.16 | 1.50 | 1.65 | .19 | 1.69 | 1.38 | 50 | 3 |

**Uses slotted head set screw.

‡‡Not UL Listed or CSA Certified.



One-Hole, Straight Floating Tongue Lug

For Use with Stranded Copper Code Conductors

Type CS

- Made from high strength electrolytic copper to provide premium electrical and mechanical performance
- Wide wire range-taking capability minimizes inventory requirements
- Internal pressure bar and V-bottom collar provide uniform clamping force on conductor to assure positive contact between conductor and connector
- Inspection window to visually assure full conductor insertion
- Plated steel set screw provides high strength, durable electrical contact between conductor and connector
- UL Listed and CSA Certified for use up to 600 V

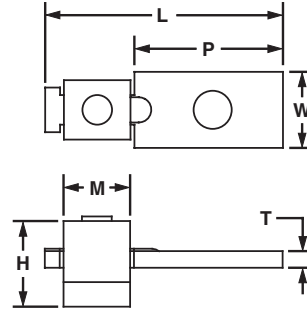

| Part Number | Copper Conductor Size Range | Current Rating (Amps) | Stud Hole Size (In.) | Hex Size (In.) | Figure Dimensions (In.) | | | | | | Tightening Torque (In.-Lbs.) | Std. Pkg. Qty. |
|-------------|--|-----------------------|----------------------|----------------|-------------------------|------|------|-----|------|------|------------------------------|----------------|
| | | | | | L | W | H | T | P | M | | |
| CS25-18-CY | #14 – 10 AWG | 25 | 1/8 | ** | 1.16 | .32 | .37 | .07 | .75 | .28 | 45 | 100 |
| CS35-36-CY | #14 – 6 AWG, (2) #10 AWG, (2) #12 AWG, (2) #14 AWG, (1) #10 AWG with (1) #12 AWG, (1) #12 AWG with (1) #14 AWG | 50 | 3/16 | ** | 1.14 | .38 | .52 | .07 | .60 | .44 | 120 | 100 |
| CSA70-14-CY | #14 – 4 AWG | 70 | 1/4 | ** | 1.30 | .50 | .56 | .08 | .71 | .42 | 200 | 100 |
| CS70-14-CY | #12 AWG – 1 AWG, (1) #8 AWG with (1) #4 AWG, (1) #8 AWG with (1) #6 AWG | 90 | 1/4 | ** | 1.50 | .50 | .65 | .08 | .81 | .50 | 200 | 100 |
| CS125-14-QY | #2 – 1/0 AWG | 125 | 1/4 | ** | 1.94 | .62 | .88 | .13 | 1.00 | .62 | 200 | 25 |
| CS175-38-QY | #4 – 3/0 AWG | 175 | 3/8 | 9/16 | 2.19 | .75 | 1.04 | .16 | 1.25 | .75 | 375 | 25 |
| CS225-56-QY | #6 – 4/0 AWG | 225 | 5/16 | 5/8 | 2.38 | 1.00 | 1.13 | .13 | 1.19 | 1.00 | 275 | 25 |
| CS300-38-QY | #1 AWG – 350 kcmil | 300 | 3/8 | 3/4 | 3.19 | 1.00 | 1.38 | .19 | 1.63 | 1.23 | 375 | 25 |
| CS400-38-3Y | 1/0 AWG – 500 kcmil | 400 | 3/8 | 3/4 | 3.88 | 1.50 | 1.56 | .19 | 2.19 | 1.50 | 375 | 3 |
| CS650-12-3Y | 600 kcmil – 1000 kcmil | 650 | 1/2 | 1 1/8 | 5.13 | 2.00 | 2.34 | .25 | 2.82 | 1.87 | 500 | 3 |

**Uses slotted head set screw.

A. System Overview

B1. Cable Ties

B2. Cable Accessories

B3. Stainless Steel Ties

C1. Wiring Duct

C2. Surface Raceway

C3. Abrasion Protection

C4. Cable Management

D1. Terminals

D2. Power Connectors

D3. Grounding Connectors

E1. Labeling Systems

E2. Labels

E3. Pre-Printed & Write-On Markers

E4. Permanent Identification

E5. Lockout/Tagout & Safety Solutions

F. Index

A. System Overview

B1. Cable Ties



Two-Hole, Straight Floating Tongue Lug

For Use with Stranded Copper Code Conductors

Type CD

- Made from high strength electrolytic copper to provide premium electrical and mechanical performance
- Wide wire range-taking capability minimizes inventory requirements
- Internal pressure bar and V-bottom collar provide uniform clamping force on conductor to assure positive contact between conductor and connector
- Inspection window to visually assure full conductor insertion
- Plated steel set screw provides high strength, durable electrical contact between conductor and connector
- UL Listed and CSA Certified for use up to 600 V
- Available with NEMA hole sizes and spacing

B2. Cable Accessories

B3. Stainless Steel Ties

C1. Wiring Duct



C2. Surface Raceway

C3. Abrasion Protection

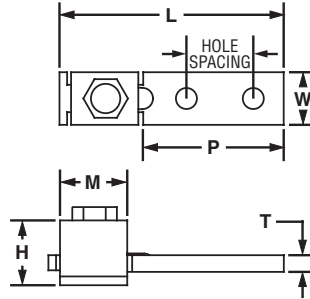

C4. Cable Management

| Part Number | Copper Conductor Size Range | Current Rating (Amps) | Stud Hole Size (In.) | Stud Hole Spacing (In.) | Hex Size (In.) | Figure Dimensions (In.) | | | | | | Tightening Torque (In.-Lbs.) | Std. Pkg. Qty. |
|----------------------|--|-----------------------|----------------------|-------------------------|----------------|-------------------------|------|------|-----|------|------|------------------------------|----------------|
| | | | | | | L | W | H | T | P | M | | |
| CD35-36-QY | #14 – 6 AWG, (2) #10 AWG, (2) #12 AWG, (2) #14 AWG, (1) #10 AWG with (1) #12 AWG, (1) #12 AWG with (1) #14 AWG | 50 | 3/16 | 1.00 | ** | 2.13 | .38 | .52 | .07 | 1.60 | .44 | 120 | 25 |
| CD70-14-QY | #12 – 2 AWG | 90 | 1/4 | 1.00 | ** | 2.26 | .50 | .65 | .09 | 1.63 | .50 | 200 | 25 |
| CD125-14-QY | #8 – 2/0 AWG | 125 | 1/4 | 1.00 | ** | 2.94 | .62 | .88 | .13 | 1.88 | .62 | 200 | 25 |
| CD225-56-QY | #6 – 4/0 AWG | 225 | 5/16 | 1.00 | 5/8 | 3.38 | 1.00 | 1.17 | .13 | 2.13 | 1.00 | 275 | 25 |
| CD300-38-3Y | #1 AWG – 350 kcmil | 300 | 3/8 | 1.00 | 3/4 | 4.94 | 1.00 | 1.39 | .19 | 3.32 | 1.23 | 375 | 3 |
| CD400-38-3Y | 1/0 AWG – 500 kcmil | 400 | 3/8 | 1.75 | 3/4 | 5.62 | 1.50 | 1.56 | .19 | 3.57 | 1.50 | 375 | 3 |
| ◆ CD650-12-3Y | 600 kcmil – 1000 kcmil | 650 | 1/2 | 1.75 | 1 1/8 | 6.88 | 2.00 | 2.34 | .25 | 4.69 | 1.88 | 500 | 3 |

**Uses slotted head set screw.
◆NEMA hole sizes and spacing.

D1. Terminals

D2. Power Connectors

D3. Grounding Connectors

E1. Labeling Systems

E2. Labels

E3. Pre-Printed & Write-On Markers

E4. Permanent Identification

E5. Lockout/Tagout & Safety Solutions

F. Index

UL LISTED CERTIFIED One-Hole, Offset Floating Tongue Lug

For Use with Stranded Copper Code Conductors

Type CB

- Made from high strength electrolytic copper to provide premium electrical and mechanical performance
- Wide wire range-taking capability minimizes inventory requirements
- Internal pressure bar and V-bottom collar provide uniform clamping force on conductor to assure positive contact between conductor and connector



- Inspection window to visually assure full conductor insertion
- Plated steel set screw provides high strength, durable electrical contact between conductor and connector
- UL Listed and CSA Certified for use up to 600 V

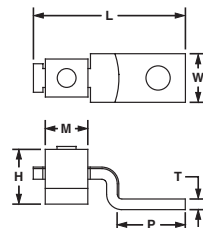

| Part Number | Copper Conductor Size Range | Current Rating (Amps) | Stud Hole Size (In.) | Hex Size (In.) | Figure Dimensions (In.) | | | | | | Tightening Torque (In.-Lbs.) | Std. Pkg. Qty. |
|-------------|--|-----------------------|----------------------|----------------|-------------------------|------|------|-----|------|------|------------------------------|----------------|
| | | | | | L | W | H | T | P | M | | |
| CB25-18-CY | #14 – 10 AWG | 25 | 1/8 | ** | 1.00 | .32 | .37 | .07 | .44 | .28 | 45 | 100 |
| CB35-36-CY | #14 – 6 AWG, (2) #10 AWG, (2) #12 AWG, (2) #14 AWG, (1) #10 AWG with (1) #12 AWG, (1) #12 AWG with (1) #14 AWG | 50 | 3/16 | ** | 1.19 | .38 | .52 | .07 | .47 | .44 | 120 | 100 |
| CBA70-14-CY | #14 – 4 AWG | 70 | 1/4 | ** | 1.31 | .50 | .58 | .08 | .57 | .43 | 200 | 100 |
| CB70-14-CY | #12 – 2 AWG, (1) #8 AWG with (1) #4 AWG, (1) #8 AWG with (1) #6 AWG | 90 | 1/4 | ** | 1.55 | .50 | .65 | .09 | .66 | .49 | 200 | 100 |
| CB125-14-QY | #2 – 1/0 AWG | 125 | 1/4 | ** | 1.97 | .63 | .88 | .13 | .93 | .62 | 200 | 25 |
| CB175-38-QY | #4 – 3/0 AWG | 175 | 3/8 | 5/16 | 2.19 | .75 | 1.04 | .16 | .94 | .74 | 375 | 25 |
| CB225-56-QY | #6 – 4/0 AWG | 225 | 5/16 | 5/8 | 2.38 | 1.00 | 1.17 | .13 | 1.06 | 1.00 | 275 | 25 |
| CB300-38-QY | #1 AWG – 350 kcmil | 300 | 3/8 | 3/4 | 3.16 | 1.00 | 1.41 | .19 | 1.50 | 1.23 | 375 | 25 |
| CB400-38-3Y | 1/0 AWG – 500 kcmil | 400 | 3/8 | 3/4 | 4.25 | 1.50 | 1.57 | .19 | 2.02 | 1.50 | 375 | 3 |
| CB650-12-3Y | 600 kcmil – 1000 kcmil | 650 | 1/2 | 1 1/8 | 4.63 | 2.00 | 2.34 | .25 | 2.04 | 1.84 | 500 | 3 |

**Uses slotted head set screw.

UL LISTED CERTIFIED One-Hole, Offset Floating Tongue, Two-Barrel Lug

For Use with Stranded Copper Code Conductors

Type DC

- Dual barrel provides termination of two copper conductors
- Made from high strength electrolytic copper to provide premium electrical and mechanical performance
- Wide wire range-taking capability minimizes inventory requirements
- Internal pressure bar and V-bottom collar provide uniform clamping force on conductor to assure positive contact between conductor and connector



- Inspection window to visually assure full conductor insertion
- Plated steel set screw provides high strength, durable electrical contact between conductor and connector
- UL Listed and CSA Certified for use up to 600 V

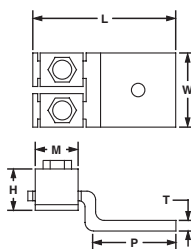

| Part Number | Copper Conductor Size Range | Current Rating (Amps) | Stud Hole Size (In.) | Hex Size (In.) | Figure Dimensions (In.) | | | | | | Tightening Torque (In.-Lbs.) | Std. Pkg. Qty. |
|-------------|-----------------------------|-----------------------|----------------------|----------------|-------------------------|------|------|-----|------|------|------------------------------|----------------|
| | | | | | L | W | H | T | P | M | | |
| DC450-38-3Y | #6 – 4/0 AWG | 450 | 3/8 | 5/8 | 3.40 | 1.50 | 1.13 | .19 | 1.94 | 1.00 | 375 | 3 |
| DC600-38-3Y | #1 AWG – 350 kcmil | 600 | 3/8 | 3/4 | 3.50 | 1.75 | 1.39 | .19 | 1.76 | 1.23 | 375 | 3 |
| DC800-12-3Y | 1/0 AWG – 500 kcmil | 800 | 1/2 | 3/4 | 4.43 | 2.00 | 1.13 | .25 | 2.09 | 1.50 | 500 | 3 |

A. System Overview

B1. Cable Ties

B2. Cable Accessories

B3. Stainless Steel Ties

C1. Wiring Duct

C2. Surface Raceway

C3. Abrasion Protection

C4. Cable Management

D1. Terminals

D2. Power Connectors

D3. Grounding Connectors

E1. Labeling Systems

E2. Labels

E3. Pre-Printed & Write-On Markers

E4. Permanent Identification

E5. Lockout/Tagout & Safety Solutions

F. Index

A. System Overview



Two-Hole, Offset Floating Tongue Lug

For Use with Stranded Copper Code Conductors

B1. Cable Ties

Type CO

- Made from high strength electrolytic copper to provide premium electrical and mechanical performance
- Wide wire range-taking capability minimizes inventory requirements
- Internal pressure bar and V-bottom collar provide uniform clamping force on conductor to assure positive contact between conductor and connector
- Inspection window to visually assure full conductor insertion
- Plated steel set screw provides high strength, durable electrical contact between conductor and connector
- UL Listed and CSA Certified for use up to 600 V
- Available with NEMA hole sizes and spacing

B2. Cable Accessories

B3. Stainless Steel Ties

C1. Wiring Duct

C2. Surface Raceway

C3. Abrasion Protection

C4. Cable Management

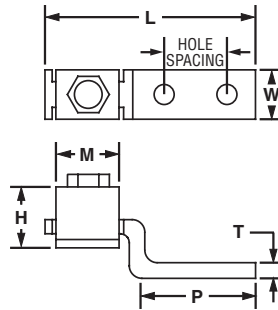

D1. Terminals

D2. Power Connectors

D3. Grounding Connectors

| Part Number | Copper Conductor Size Range | Current Rating (Amps) | Stud Hole Size (In.) | Stud Hole Spacing (In.) | Hex Size (In.) | Figure Dimensions (In.) | | | | | | Tightening Torque (In.-Lbs.) | Std. Pkg. Qty. |
|----------------------|--|-----------------------|----------------------|-------------------------|----------------|-------------------------|------|------|-----|------|------|------------------------------|----------------|
| | | | | | | L | W | H | T | P | M | | |
| CO35-36-QY | #14 – 6 AWG, (2) #10 AWG, (2) #12 AWG, (2) #14 AWG, (1) #10 AWG with (1) #12 AWG, (1) #12 AWG with (1) #14 AWG | 50 | 3/16 | 1.00 | ** | 2.19 | .38 | .52 | .07 | 1.50 | .44 | 120 | 25 |
| CO70-14-QY | #12 – 1 AWG, (1) #8 AWG with (1) #4 AWG, (1) #8 AWG with (1) #6 AWG | 90 | 1/4 | 1.00 | ** | 2.50 | .50 | .65 | .09 | 1.66 | .50 | 200 | 25 |
| CO125-14-QY | #2 – 1/0 AWG | 125 | 1/4 | 1.00 | ** | 2.97 | .63 | .88 | .13 | 1.88 | .63 | 200 | 25 |
| CO225-56-QY | #6 – 4/0 AWG | 225 | 5/16 | 1.00 | 5/8 | 3.62 | 1.00 | 1.12 | .13 | 2.27 | 1.00 | 275 | 25 |
| CO300-38-3Y | #1 AWG – 350 kcmil | 300 | 3/8 | 1.87 | 3/4 | 5.69 | 1.00 | 1.39 | .19 | 4.01 | 1.23 | 375 | 3 |
| CO400-38-3Y | 1/0 AWG – 500 kcmil | 400 | 3/8 | 1.75 | 3/4 | 6.00 | 1.50 | 1.56 | .19 | 3.77 | 1.53 | 375 | 3 |
| ◆ CO650-12-3Y | 600 kcmil – 1000 kcmil | 650 | 1/2 | 1.75 | 1 1/8 | 6.25 | 2.00 | 2.34 | .25 | 3.69 | 1.88 | 500 | 3 |

**Uses slotted head set screw.

◆NEMA hole sizes and spacing.

E1. Labeling Systems

E2. Labels

E3. Pre-Printed & Write-On Markers

E4. Permanent Identification

E5. Lockout/Tagout & Safety Solutions

F. Index

UL LISTED CERTIFIED **One-Hole, Single Barrel Lug**

For Use with Stranded Aluminum or Copper Code Conductors

Type LAMA

- Made from high strength, extruded aluminum alloy to provide premium electrical and mechanical performance
- Tin-plated to inhibit corrosion
- Compact design saves space
- Wide wire range-taking capability minimizes inventory requirements

- Inspection window to visually assure full conductor insertion
- Plated steel or aluminum set screw provides high strength, durable electrical contact between conductor and connector
- UL Listed and CSA Certified for use up to 600 V and UL temperature rated 90°C

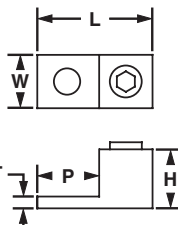

| Part Number | Conductor Size Range | Stud Hole Size (In.) | Hex Key Size (In.) | Figure Dimensions (In.) | | | | | Tightening Torque (In.-Lbs.) | Std. Pkg. Qty. |
|--------------------------|---|----------------------|--------------------|-------------------------|------|------|-----|------|------------------------------|----------------|
| | | | | L | W | H | T | P | | |
| LAMA6-14-QY | #14 – 6 AWG | 1/4 | ** | 1.06 | .38 | .50 | .09 | .68 | 45* | 25 |
| LAMA2-14-QY | #14 – 2 AWG | 1/4 | ** | 1.16 | .50 | .56 | .09 | .69 | 50* | 25 |
| LAMA1/0-14-QY | #14 – 1/0 AWG | 1/4 | ** | 1.47 | .62 | .81 | .19 | .84 | 50* | 25 |
| LAMA2/0-14-QY | #14 – 2/0 AWG | 1/4 | ** | 1.47 | .62 | .81 | .19 | .84 | 50* | 25 |
| LAMA250-56-QY | #6 AWG – 250 kcmil | 5/16 | 3/8 | 2.00 | .90 | 1.06 | .22 | 1.00 | 375* | 25 |
| LAMA300-56-QY | #6 AWG – 300 kcmil | 5/16 | 3/8 | 2.00 | .90 | 1.06 | .22 | 1.00 | 375* | 25 |
| LAMA350-38-QY | #6 AWG – 350 kcmil | 3/8 | 3/8 | 2.25 | 1.13 | 1.25 | .25 | 1.13 | 375* | 25 |
| LAMA500-38-6Y | #4 AWG – 500 kcmil | 3/8 | 1/2 | 2.75 | 1.38 | 1.50 | .31 | 1.50 | 500 | 6 |
| LAMA600-38-6Y | #4 AWG – 600 kcmil | 3/8 | 1/2 | 2.75 | 1.38 | 1.50 | .31 | 1.50 | 500 | 6 |
| LAMA600S-38-6Y*** | #4 AWG – 600 kcmil or (2) 1/0 AWG – 250 kcmil | 3/8 | 1/2 | 2.81 | 1.38 | 1.81 | .31 | 1.50 | 500 | 6 |
| LAMA800-58-6Y | 350 kcmil – 800 kcmil | 5/8 | 9/16 | 3.38 | 1.63 | 1.94 | .38 | 1.75 | 600 | 6 |
| LAMA1000-58-6Y | 500 kcmil – 1000 kcmil | 5/8 | 9/16 | 3.50 | 1.75 | 2.13 | .44 | 1.75 | 600 | 6 |

The use of PANDUIT oxide inhibiting joint compound (CMP-100) is recommended for pad to pad and conductor connections. See page D2.161.

*Listed torque values are for maximum conductor sizes, consult the installation instruction sheet for smaller sizes.

**Uses slotted head set screw.

***Accommodates two conductors for conductor range 1/0 AWG – 250 kcmil.

A. System Overview

B1. Cable Ties

B2. Cable Accessories

B3. Stainless Steel Ties

C1. Wiring Duct

C2. Surface Raceway

C3. Abrasion Protection

C4. Cable Management

D1. Terminals

D2. Power Connectors

D3. Grounding Connectors

E1. Labeling Systems

E2. Labels

E3. Pre-Printed & Write-On Markers

E4. Permanent Identification

E5. Lockout/Tagout & Safety Solutions

F. Index

A. System Overview



Two-Hole, Single Barrel Lug

For Use with Stranded Aluminum or Copper Code Conductors

Type LAMB

- Made from high strength, extruded aluminum alloy to provide premium electrical and mechanical performance
- Tin-plated to inhibit corrosion
- Compact design saves space
- Wide wire range-taking capability minimizes inventory requirements
- Inspection window to visually assure full conductor insertion

- Plated steel or aluminum set screw provides high strength, durable electrical contact between conductor and connector
- LAMLB provided with dual set screws for premium clamping of conductor to connector for heavy duty applications
- UL Listed and CSA Certified for use up to 600 V and UL temperature rated 90°C
- Available with NEMA hole sizes and spacing

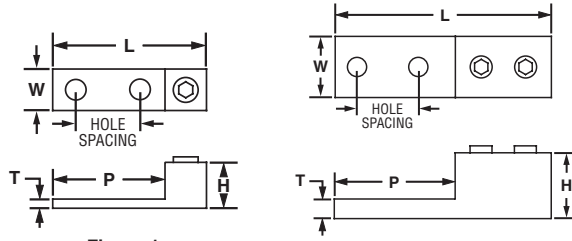

Figure 1

Figure 2

| Part Number | Figure No. | Conductor Size Range | Stud Hole Size (In.) | Stud Hole Spacing (In.) | Hex Key Size (In.) | Figure Dimensions (In.) | | | | | Tightening Torque (In.-Lbs.) | Std. Pkg. Qty. |
|------------------|------------|-----------------------|----------------------|-------------------------|--------------------|-------------------------|------|------|-----|------|---|----------------|
| | | | | | | L | W | H | T | P | | |
| ◆ LAMB350-12-6Y | 1 | #6 AWG – 350 kcmil | 1/2 | 1.75 | 3/8 | 4.19 | 1.13 | 1.25 | .25 | 3.06 | #6 – 2 AWG – 200 kcmil, #1 AWG – 350 kcmil – 375 kcmil | 6 |
| ◆ LAMB600-12-3Y | 1 | #4 AWG – 600 kcmil | 1/2 | 1.75 | 1/2 | 4.69 | 1.50 | 1.56 | .44 | 3.31 | 500 | 3 |
| ◆ LAMLB800-12-3Y | 2 | 350 kcmil – 800 kcmil | 1/2 | 1.75 | 3/8 | 6.19 | 1.75 | 1.88 | .56 | 3.44 | 375 | 3 |

The use of PANDUIT oxide inhibiting joint compound (CMP-100) is recommended for pad to pad and conductor connections. See page D2.161.
◆NEMA hole sizes and spacing.

B1. Cable Ties

B2. Cable Accessories

B3. Stainless Steel Ties

C1. Wiring Duct

C2. Surface Raceway

C3. Abrasion Protection

C4. Cable Management

D1. Terminals

D2. Power Connectors

D3. Grounding Connectors

E1. Labeling Systems

E2. Labels

E3. Pre-Printed & Write-On Markers

E4. Permanent Identification

E5. Lockout/Tagout & Safety Solutions

F. Index



One-Hole, Two-Barrel Lug

For Use with Stranded Aluminum or Copper Code Conductors

Type LAM2A

- Dual barrel provides termination of two conductors
- Made from high strength, extruded aluminum alloy to provide premium electrical and mechanical performance
- Tin-plated to inhibit corrosion
- Wide wire range-taking capability minimizes inventory requirements
- Inspection window to visually assure full conductor insertion

- Plated steel or aluminum set screw provides high strength, durable electrical contact between conductor and connector
- UL Listed and CSA Certified for use up to 600 V and UL temperature rated 90°C
- Available with NEMA hole sizes and spacing

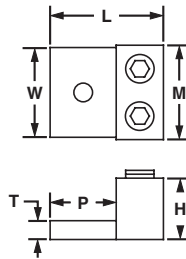

| Part Number | Conductor Size Range | Stud Hole Size (In.) | Hex Key Size (In.) | Figure Dimensions (In.) | | | | | | Tightening Torque (In.-Lbs.) | Std. Pkg. Qty. |
|-------------------|------------------------|----------------------|--------------------|-------------------------|------|------|-----|------|------|------------------------------|----------------|
| | | | | L | W | H | T | P | M | | |
| Λ LAM2A1/0-14-6Y | #14 – 1/0 AWG | 1/4 | ** | 1.47 | 1.12 | .81 | .19 | .85 | 1.12 | 45* | 6 |
| Λ LAM2A2/0-14-6Y | #14 – 2/0 AWG | 1/4 | ** | 1.47 | 1.20 | .81 | .19 | .85 | 1.20 | 50* | 6 |
| Λ LAM2A250-38-6Y | #6 AWG – 250 kcmil | 3/8 | 3/8 | 2.56 | 1.50 | 1.19 | .25 | 1.56 | 1.62 | 375 | 6 |
| Λ LAM2A350-12-6Y | #6 AWG – 350 kcmil | 1/2 | 3/8 | 2.88 | 1.75 | 1.25 | .25 | 1.75 | 1.94 | 375* | 6 |
| Λ LAM2A600-12-6Y | #4 AWG – 600 kcmil | 1/2 | 1/2 | 3.13 | 2.00 | 1.56 | .44 | 1.75 | 2.38 | 500 | 6 |
| Λ LAM2A800-58-6Y | 350 kcmil – 800 kcmil | 5/8 | 7/16 | 3.50 | 2.81 | .69 | .50 | 2.00 | 2.81 | 500 | 6 |
| ▼ LAM2A1000-58-6Y | 500 kcmil – 1000 kcmil | 5/8 | 3/8 | 3.50 | 2.87 | 1.69 | .50 | 2.00 | 2.87 | 500 | 6 |

The use of PANDUIT oxide inhibiting joint compound (CMP-100) is recommended for pad to pad and conductor connections. See page D2.161.

*Listed torque values are for maximum conductor sizes, consult the installation instruction sheet for smaller sizes.

**Uses slotted head set screw.

ΛNot CSA Certified.

▼Not UL Listed or CSA Certified.



One-Hole, Vertical Two-Barrel Lug

For Use with Stranded Aluminum or Copper Code Conductors

Type LAM2SA

- Dual barrel provides termination of two conductors
- Made from high strength, extruded aluminum alloy to provide premium electrical and mechanical performance
- Tin-plated to inhibit corrosion
- Wide wire range-taking capability minimizes inventory requirements

- Inspection window to visually assure full conductor insertion
- Plated steel or aluminum set screw provides high strength, durable electrical contact between conductor and connector
- UL Listed and CSA Certified for use up to 600 V and UL temperature rated 90°C

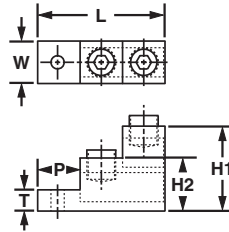

| Part Number | Conductor Size Range | Stud Hole Size (In.) | Hex Key Size (In.) | Figure Dimensions (In.) | | | | | | Tightening Torque (In.-Lbs.) | Std. Pkg. Qty. |
|----------------|----------------------|----------------------|--------------------|-------------------------|------|------|------|-----|------|------------------------------|----------------|
| | | | | L | W | H1 | H2 | T | P | | |
| LAM2SA300-56-3 | #6 AWG – 300 kcmil | 5/16 | 5/16 | 3.00 | 1.00 | 2.00 | 1.25 | .50 | 1.00 | 375* | 3 |

The use of PANDUIT oxide inhibiting joint compound (CMP-100) is recommended for pad to pad and conductor connections. See page D2.161.
*Listed torque values are for maximum conductor sizes, consult the installation instruction sheet for smaller sizes.



Two-Hole, Two-Barrel Lug

For Use with Stranded Aluminum or Copper Code Conductors

Type LAM2B

- Dual barrel provides termination of two conductors
- Made from high strength, extruded aluminum alloy to provide premium electrical and mechanical performance
- Tin-plated to inhibit corrosion
- Wide wire range-taking capability minimizes inventory requirements
- Inspection window to visually assure full conductor insertion

- Plated steel or aluminum set screw provides high strength, durable electrical contact between conductor and connector
- LAM2LB connector provided with dual set screws for premium clamping of conductor to connector for heavy duty applications
- UL Listed for use up to 600 V and temperature rated 90°C
- Available with NEMA hole sizes and spacing

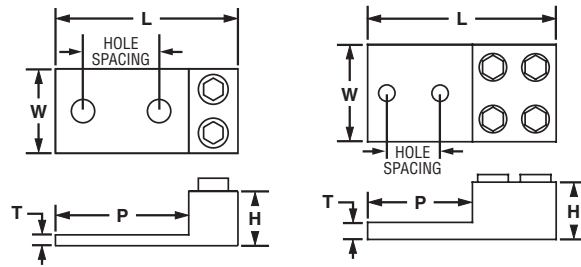

Figure 1

Figure 2

| Part Number | Figure No. | Conductor Size Range | Stud Hole Size (In.) | Stud Hole Spacing (In.) | Hex Key Size (In.) | Figure Dimensions (In.) | | | | | Tightening Torque (In.-Lbs.) | Std. Pkg. Qty. |
|--------------------|------------|-----------------------|----------------------|-------------------------|--------------------|-------------------------|------|------|-----|------|------------------------------|----------------|
| | | | | | | L | W | H | T | P | | |
| ◆ LAM2B350-12-3Y | 1 | #6 AWG – 350 kcmil | 1/2 | 1.75 | 3/8 | 4.19 | 1.94 | 1.25 | .25 | 3.06 | 375** | 3 |
| ◆ LAM2B600-12-3Y | 1 | #4 AWG – 600 kcmil | 1/2 | 1.75 | 1/2 | 4.69 | 2.44 | 1.56 | .44 | 3.31 | 500 | 3 |
| ◆ LAM2LB800-12-3Y* | 2 | 350 kcmil – 800 kcmil | 1/2 | 1.75 | 3/8 | 6.19 | 3.19 | 1.88 | .56 | 3.44 | 500 | 3 |

The use of PANDUIT oxide inhibiting joint compound (CMP-100) is recommended for pad to pad and conductor connections. See page D2.161.

*Not UL Listed.

**Listed torque values are for maximum conductor sizes, consult the installation instruction sheet for smaller sizes.

◆NEMA hole sizes and spacing.

A. System Overview

B1. Cable Ties

B2. Cable Accessories

B3. Stainless Steel Ties

C1. Wiring Duct

C2. Surface Raceway

C3. Abrasion Protection

C4. Cable Management

D1. Terminals

D2. Power Connectors

D3. Grounding Connectors

E1. Labeling Systems

E2. Labels

E3. Pre-Printed & Write-On Markers

E4. Permanent Identification

E5. Lockout/Tagout & Safety Solutions

F. Index

A. System Overview



Two-Hole, Vertical Two-Barrel Lug

For Use with Stranded Aluminum or Copper Code Conductors

B1. Cable Ties

Type LAM2SB

- Dual barrel provides termination of two conductors
- Vertical configuration saves space
- Made from high strength, extruded aluminum alloy to provide premium electrical and mechanical performance
- Tin-plated to inhibit corrosion
- Wide wire range-taking capability minimizes inventory requirements

- Inspection window to visually assure full conductor insertion
- Plated steel or aluminum set screw provides high strength, durable electrical contact between conductor and connector
- UL Listed and CSA Certified for use up to 600 V and UL temperature rated 90°C

B2. Cable Accessories

B3. Stainless Steel Ties

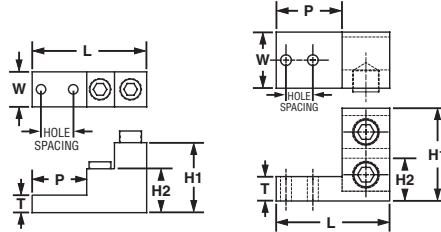

C1. Wiring Duct

C2. Surface Raceway

| Part Number | Figure No. | Conductor Size Range | Stud Hole Size (In.) | Stud Hole Spacing (In.) | Hex Key Size (In.) | Figure Dimensions (In.) | | | | | | Tightening Torque (In.-Lbs.) | Std. Pkg. Qty. |
|------------------|------------|----------------------|----------------------|-------------------------|--------------------|-------------------------|------|------|------|-----|------|------------------------------|----------------|
| | | | | | | L | W | H1 | H2 | T | P | | |
| LAM2SB600-38-1Y* | 1 | #2 AWG – 600 kcmil | 3/8 | 1.38 | 1/2 | 4.91 | 1.50 | 3.00 | 1.88 | .75 | 2.34 | 500 | 1 |
| LAM2SB750-38-1Y* | 1 | 3/0 AWG – 750 kcmil | 3/8 | 1.38 | 1/2 | 4.91 | 1.50 | 3.00 | 1.88 | .75 | 2.34 | 500 | 1 |
| LAM2SSB500-141Y | 2 | 4/0 AWG – 500 kcmil | 1/4 | .69 | 3/8 | 2.91 | 1.44 | 2.38 | 1.77 | .63 | 1.69 | 375 | 1 |

The use of PANDUIT oxide inhibiting joint compound (CMP-100) is recommended for pad to pad and conductor connections. See page D2.161.
*Not CSA Certified.

C3. Abrasion Protection

C4. Cable Management

Two-Hole, Three-Barrel Lug

For Use with Stranded Aluminum or Copper Code Conductors

Type LAM3B

- Triple barrel provides termination of three conductors
- Made from high strength, extruded aluminum alloy to provide premium electrical and mechanical performance
- Tin-plated to inhibit corrosion
- Wide wire range-taking capability minimizes inventory requirements
- Inspection window to visually assure full conductor insertion
- Plated steel or aluminum set screw provides high strength, durable electrical contact between conductor and connector

- LAM3LB connector is provided with dual set screws to allow premium clamping of conductor to connector for heavy duty applications
- For use up to 600 V and temperature rated 90°C
- Available with NEMA hole sizes and spacing

D1. Terminals

D2. Power Connectors

D3. Grounding Connectors

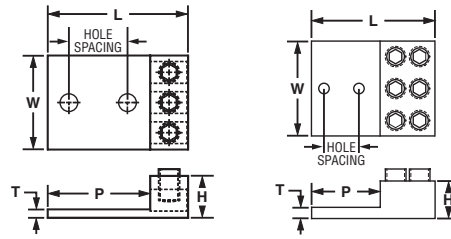

E1. Labeling Systems

E2. Labels

| Part Number | Figure No. | Conductor Size Range | Stud Hole Size (In.) | Stud Hole Spacing (In.) | Hex Key Size (In.) | Figure Dimensions (In.) | | | | | Tightening Torque (In.-Lbs.) | Std. Pkg. Qty. |
|-------------------|------------|------------------------|----------------------|-------------------------|--------------------|-------------------------|------|------|-----|------|------------------------------|----------------|
| | | | | | | L | W | H | T | P | | |
| LAM3B2-14-6Y | 1 | #14 – 2 AWG | 5/16 | .87 | ** | 2.49 | 1.63 | .47 | .19 | 2.03 | 50* | 6 |
| LAM3B1/0-38-6Y | 1 | #12 – 1/0 AWG | 3/8 | 1.00 | ** | 2.94 | 1.94 | .63 | .19 | 2.31 | 50* | 6 |
| ◆ LAM3B3/0-12-3Y | 1 | #6 – 3/0 AWG | 1/2 | 1.75 | 5/16 | 4.19 | 2.81 | .81 | .25 | 3.38 | 200 | 3 |
| ◆ LAM3B250-12-1Y | 1 | #6 AWG – 250 kcmil | 1/2 | 1.75 | 5/16 | 4.19 | 2.81 | 1.25 | .25 | 3.06 | 375* | 1 |
| ◆ LAM3B350-12-1Y | 1 | #6 AWG – 350 kcmil | 1/2 | 1.75 | 5/16 | 4.19 | 3.00 | 1.25 | .25 | 3.06 | 375* | 1 |
| ◆ LAM3B600-12-1Y | 1 | # 2 AWG – 600 kcmil | 1/2 | 1.75 | 1/2 | 4.69 | 3.75 | 1.56 | .44 | 3.31 | 375 | 1 |
| ◆ LAM3LB800-12-1Y | 2 | 350 kcmil – 800 kcmil | 1/2 | 1.75 | 3/8 | 6.19 | 4.25 | 1.88 | .56 | 3.44 | 375 | 1 |
| ◆ LAM3LB1000-121Y | 2 | 500 kcmil – 1000 kcmil | 1/2 | 1.75 | 3/8 | 6.19 | 4.75 | 1.88 | .56 | 3.44 | 375 | 1 |

The use of PANDUIT oxide inhibiting joint compound (CMP-100) is recommended for pad to pad and conductor connections. See page D2.161.

*Listed torque values are for maximum conductor sizes, consult the installation instruction sheet for smaller sizes.

**Uses slotted head set screw.

◆NEMA hole sizes and spacing.

E3. Pre-Printed & Write-On Markers

E4. Permanent Identification

E5. Lockout/ Tagout & Safety Solutions

F. Index



Two-Hole, Vertical Three-Barrel Lug

For Use with Stranded Aluminum or Copper Code Conductors

Type LAM3SB

- Triple barrel provides termination of three conductors
- Vertical configuration saves space
- Made from high strength, extruded aluminum alloy to provide premium electrical and mechanical performance
- Tin-plated to inhibit corrosion



- Wide wire range-taking capability minimizes inventory requirements
- Inspection window to visually assure full conductor insertion
- Plated steel or aluminum set screw provides high strength, durable electrical contact between conductor and connector
- UL Listed and CSA Certified for use up to 600 V and UL temperature rated 90°C

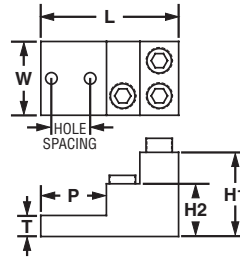

| Part Number | Conductor Size Range | Stud Hole Size (In.) | Stud Hole Spacing (In.) | Hex Key Size (In.) | Figure Dimensions (In.) | | | | | | Tightening Torque (In.-Lbs.) | Std. Pkg. Qty. |
|-----------------|----------------------|----------------------|-------------------------|--------------------|-------------------------|------|------|------|-----|------|------------------------------|----------------|
| | | | | | L | W | H1 | H2 | T | P | | |
| LAM3SB600-38-1Y | #2 AWG – 600 kcmil | 3/8 | 1.38 | 1/2 | 4.91 | 2.47 | 3.00 | 1.88 | .75 | 2.34 | 500 | 1 |
| LAM3SB750-38-1Y | 3/0 AWG – 750 kcmil | 3/8 | 1.38 | 1/2 | 4.91 | 2.63 | 3.00 | 1.88 | .75 | 2.34 | 500 | 1 |

The use of PANDUIT oxide inhibiting joint compound (CMP-100) is recommended for pad to pad and conductor connections. See page D2.161.

Four-Hole, Three-Barrel Lug

For Use with Stranded Aluminum or Copper Code Conductors

Type LAM3D

- Triple barrel provides termination of three conductors
- Made from high strength, extruded aluminum alloy to provide premium electrical and mechanical performance
- Tin-plated to inhibit corrosion
- Wide wire range-taking capability minimizes inventory requirements
- Inspection window to visually assure full conductor insertion



- Plated steel or aluminum set screw provides high strength, durable electrical contact between conductor and connector
- LAM3LD connector is provided with dual set screws to allow premium clamping of conductor to connector for heavy duty applications
- For use up to 600 V and temperature rated 90°C
- Available with NEMA hole sizes and spacing

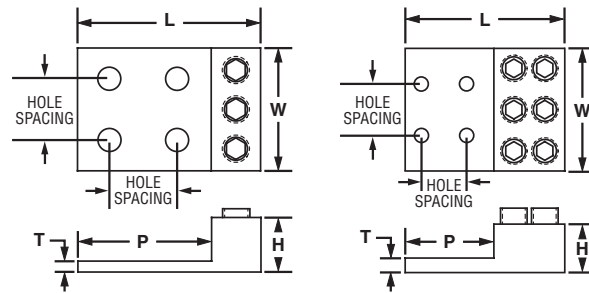

Figure 1

Figure 2

| Part Number | Figure No. | Conductor Size Range | Stud Hole Size (In.) | Stud Hole Spacing (In.) | Hex Key Size (In.) | Figure Dimensions (In.) | | | | | Tightening Torque (In.-Lbs.) | Std. Pkg. Qty. |
|-------------------|------------|------------------------|----------------------|-------------------------|--------------------|-------------------------|------|------|-----|------|------------------------------|----------------|
| | | | | | | L | W | H | T | P | | |
| ◆ LAM3D3/0-12-3Y | 1 | #6 – 3/0 AWG | 1/2 | 1.75 | 1/4 | 4.19 | 2.81 | .81 | .25 | 3.38 | 200 | 3 |
| ◆ LAM3D250-12-1Y | 1 | #6 AWG – 250 kcmil | 1/2 | 1.75 | 1/4 | 4.19 | 2.81 | 1.25 | .25 | 3.07 | 375* | 1 |
| ◆ LAM3D350-12-1Y | 1 | #6 AWG – 350 kcmil | 1/2 | 1.75 | 5/16 | 4.19 | 3.00 | 1.25 | .25 | 3.06 | 375* | 1 |
| ◆ LAM3D600-12-1Y | 1 | #2 AWG – 600 kcmil | 1/2 | 1.75 | 3/8 | 4.69 | 3.75 | 1.56 | .44 | 3.31 | 500 | 1 |
| ◆ LAM3LD800-12-1Y | 2 | 350 kcmil – 800 kcmil | 1/2 | 1.75 | 3/8 | 6.19 | 4.25 | 1.88 | .56 | 3.44 | 375 | 1 |
| ◆ LAM3LD1000-121Y | 2 | 500 kcmil – 1000 kcmil | 1/2 | 1.75 | 9/16 | 6.19 | 4.75 | 1.88 | .56 | 3.44 | 600 | 1 |

The use of PANDUIT oxide inhibiting joint compound (CMP-100) is recommended for pad to pad and conductor connections. See page D2.161.

*Listed torque values are for maximum conductor sizes, consult the installation instruction sheet for smaller sizes.

◆NEMA hole sizes and spacing.

A. System Overview

B1. Cable Ties

B2. Cable Accessories

B3. Stainless Steel Ties

C1. Wiring Duct

C2. Surface Raceway

C3. Abrasion Protection

C4. Cable Management

D1. Terminals

D2. Power Connectors

D3. Grounding Connectors

E1. Labeling Systems

E2. Labels

E3. Pre-Printed & Write-On Markers

E4. Permanent Identification

E5. Lockout/Tagout & Safety Solutions

F. Index

A. System Overview



Two-Hole, Vertical Four-Barrel Lug

For Use with Stranded Aluminum or Copper Code Conductors

B1. Cable Ties

Type LAM4SB

- Four barrels provide termination of four conductors
- Vertical configuration saves space
- Made from high strength, extruded aluminum alloy to provide premium electrical and mechanical performance
- Tin-plated to inhibit corrosion
- Wide wire range-taking capability minimizes inventory requirements
- Inspection window to visually assure full conductor insertion
- Plated steel or aluminum set screw provides high strength, durable electrical contact between conductor and connector
- UL Listed and CSA Certified for use up to 600 V and UL temperature rated 90°C

B2. Cable Accessories

B3. Stainless Steel Ties

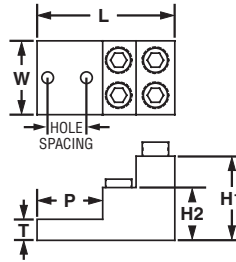

C1. Wiring Duct

C2. Surface Raceway

C3. Abrasion Protection

| Part Number | Conductor Size Range | Stud Hole Size (In.) | Stud Hole Spacing (In.) | Hex Key Size (In.) | Figure Dimensions (In.) | | | | | | Tightening Torque (In.-Lbs.) | Std. Pkg. Qty. |
|-----------------|----------------------|----------------------|-------------------------|--------------------|-------------------------|------|------|------|-----|------|------------------------------|----------------|
| | | | | | L | W | H1 | H2 | T | P | | |
| LAM4SB600-38-1Y | #2 AWG – 600 kcmil | 3/8 | 1.38 | 1/2 | 4.91 | 2.47 | 3.00 | 1.88 | .75 | 2.34 | 500 | 1 |
| LAM4SB750-38-1Y | 1/0 AWG – 750 kcmil | 3/8 | 1.38 | 1/2 | 4.91 | 2.63 | 3.00 | 1.88 | .75 | 2.34 | 500 | 1 |

The use of PANDUIT oxide inhibiting joint compound (CMP-100) is recommended for pad to pad and conductor connections. See page D2.161.

C4. Cable Management

Four-Hole, Four-Barrel Lug

For Use with Stranded Aluminum or Copper Code Conductors

D1. Terminals

Type LAM4D

- Four barrels provide termination of four conductors
- Made from high strength, extruded aluminum alloy to provide premium electrical and mechanical performance
- Tin-plated to inhibit corrosion
- Wide wire range-taking capability minimizes inventory requirements
- Inspection window to visually assure full conductor insertion
- Plated steel or aluminum set screw provides high strength, durable electrical contact between conductor and connector
- LAM4LD connector is provided with dual set screws to allow premium clamping of conductor to connector for heavy duty applications
- For use up to 600 V and temperature rated 90°C
- Available with NEMA hole sizes and spacing

D2. Power Connectors

D3. Grounding Connectors

E1. Labeling Systems

E2. Labels

E3. Pre-Printed & Write-On Markers

E4. Permanent Identification

E5. Lockout/Tagout & Safety Solutions

F. Index

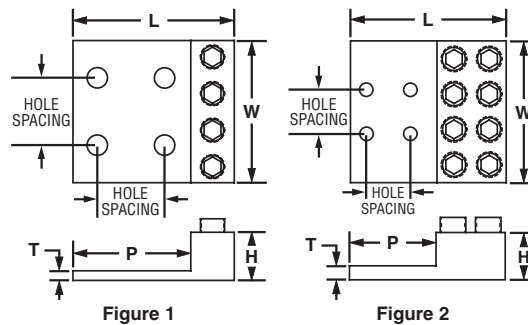

| Part Number | Figure No. | Conductor Size Range | Stud Hole Size (In.) | Stud Hole Spacing (In.) | Hex Key Size (In.) | Figure Dimensions (In.) | | | | | Tightening Torque (In.-Lbs.) | Std. Pkg. Qty. |
|-------------------|------------|-----------------------|----------------------|-------------------------|--------------------|-------------------------|------|------|-----|------|------------------------------|----------------|
| | | | | | | L | W | H | T | P | | |
| ◆ LAM4D250-12-1Y | 1 | # 6 AWG – 250 kcmil | 1/2 | 1.75 | 3/8 | 4.19 | 3.69 | 1.00 | .25 | 3.06 | 375* | 1 |
| ◆ LAM4D350-12-1Y | 1 | # 6 AWG – 350 kcmil | 1/2 | 1.75 | 5/16 | 4.19 | 3.94 | 1.25 | .25 | 3.06 | 275 | 1 |
| ◆ LAM4D600-12-1Y | 1 | # 2 AWG – 600 kcmil | 1/2 | 1.75 | 3/8 | 4.69 | 5.00 | 1.56 | .44 | 3.31 | 500 | 1 |
| ◆ LAM4LD800-12-1Y | 2 | 350 kcmil – 800 kcmil | 1/2 | 1.75 | 3/8 | 6.19 | 6.53 | 1.88 | .56 | 3.44 | 375 | 1 |

The use of PANDUIT oxide inhibiting joint compound (CMP-100) is recommended for pad to pad and conductor connections. See page D2.161.

*Listed torque values are for maximum conductor sizes, consult the installation instruction sheet for smaller sizes.

◆NEMA hole sizes and spacing.

Transformer Lug Kit

For Use with Stranded Aluminum or Copper Code Conductors

Type KLM

- Kits include all of the connectors and hardware to make a complete transformer connection in a single convenient package
- Lugs are made from high strength, extruded aluminum alloy and are tin-plated to inhibit corrosion and oxidation
- Plated steel cap screws, belleville and flat washers, and hex nuts are provided to assure that terminal to bus connections are made using proper hardware resulting in true torque to pressure performance

- Hardware is packaged in a sealed plastic bag to prevent lost hardware prior to installation
- KLM6-800 and KLM350-800 kits include lugs that accommodate 750 kcmil conductors used with large transformers
- Lugs are UL Listed and CSA Certified for use up to 600 V and UL temperature rated 90°C



| Part Number | Transformer KVA Rating | Aluminum Mechanical Lug | | Conductor Size Range | Hardware (Sizes in Inches) | | | | | |
|-------------|--|-------------------------|------|-----------------------|--|---------|----------------------------|---------|--|--------------------|
| | | Part No. | Qty. | | Hex Bolt Size | Qty. | Nut Size | Qty. | Washer Size | Qty. |
| KLM14-250Y | 15 – 37.5 KVA 1PH 15 – 45 KVA 3PH | LAMA2-14 | 8 | #14 – 2 AWG | 1/4 – 20 x 3/4 HH | 8 | 1/4 – 20 HN | 8 | 1/4 FLAT 1/4 CMP | 16 8 |
| | | LAMA250-56 | 4 | #6 AWG – 250 kcmil | | | | | | |
| KLM6-250Y | 50 – 75 KVA 1 PH 75 – 112.5 KVA 3 PH | LAMA250-56 | 12 | #6 AWG – 250 kcmil | 1/4 – 20 x 3/4 HH 1/4 – 20 x 2 HH | 8 8 | 1/4 – 20 HN | 16 | 1/4 FLAT 1/4 CMP | 32 16 |
| KLM6-600Y | 100 – 167 KVA 1PH 150 – 300 KVA 3 PH | LAMA250-56 | 3 | #6 AWG – 250 kcmil | 1/4 – 20 x 3/4 HH 3/8 – 16 x 2 HH | 3 16 | 1/4 – 20 HN 3/8 – 16 HN | 3 16 | 3/8 FLAT 1/4 FLAT 3/8 CMP 1/4 CMP | 32 6 16 3 |
| | | LAMA600-38 | 3 | #4 AWG – 600 kcmil | | | | | | |
| KLM6-800Y | 100 – 167 KVA 1 PH 150 – 300 KVA 3 PH | LAM2A350-12 | 6 | #6 AWG – 350 kcmil | 1/2 – 13 x 2 HH | 5 | 1/2 – 13 HN | 11 | 1/2 FLAT | 22 |
| | | LAM2A800-58 | 7 | 350 kcmil – 800 kcmil | 1/2 – 13 x 2 1/2 HH | 6 | | | 1/2 CMP | 11 |
| KLM350-800Y | 500 KVA 3 PH | LAM2A800-58 | 15 | 350 kcmil – 800 kcmil | 1/2 – 13 x 2 HH 1/2 – 13 x 2 1/2 HH | 7 4 | 1/2 – 13 HN | 11 | 1/2 FLAT 1/2 CMP | 22 11 |

Suffix: HH = Hex Head; HN = Hex Nut; FLAT = Flat Washer; CMP = Compression Washer.

The use of PANDUIT oxide inhibiting joint compound (CMP-100) is recommended for pad to pad and conductor connections. See page D2.161.

A.
System
Overview

B1.
Cable
Ties

B2.
Cable
Accessories

B3.
Stainless
Steel
Ties

C1.
Wiring
Duct

C2.
Surface
Raceway

C3.
Abrasion
Protection

C4.
Cable
Management

D1.
Terminals

D2.
Power
Connectors

D3.
Grounding
Connectors

E1.
Labeling
Systems

E2.
Labels

E3.
Pre-Printed
& Write-On
Markers

E4.
Permanent
Identification

E5.
Lockout/
Tagout/
& Safety
Solutions

F.
Index

A.
System
Overview



Splicer/Reducer

B1.
Cable Ties

For Use with Stranded Aluminum or Copper Code Conductors

Type SR

- Made from high strength extruded aluminum alloy to provide premium electrical and mechanical performance
- Tin-plated to inhibit corrosion
- Rounded bottoms to facilitate taping

- Solid center barrier prevents contact of dissimilar metal conductors
- Wide wire range-taking capability minimizes inventory requirements
- UL Listed and CSA Certified for use up to 600 V and UL temperature rated 90°C

B2.
Cable
Accessories

B3.
Stainless
Steel Ties

C1.
Wiring
Duct

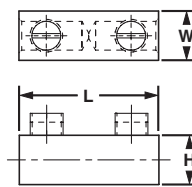

Figure 1

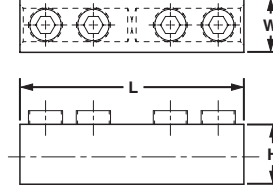

Figure 2

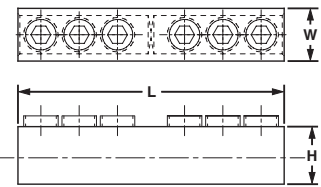

Figure 3

C2.
Surface
Raceway

C3.
Abrasion
Protection

C4.
Cable
Management

| Part Number | Figure No. | Conductor Size Range | | Figure Dimensions (In.) | | | Hex Key Size (In.) | Tightening Torque (In.-Lbs.) | Std. Pkg. Qty. |
|-------------|------------|-----------------------------|-----------------------------|-------------------------|------|------|--------------------|------------------------------|----------------|
| | | Max. | Min. | L | W | H | | | |
| SR-2-XY | 1 | #2 AWG STR, #10 AWG SOL | #14 AWG STR, #14 AWG SOL | 1.38 | .50 | .56 | ** | 50* | 10 |
| SR-0-XY | 1 | 1/0 AWG STR, #10 AWG SOL | #14 AWG STR, #14 AWG SOL | 1.91 | .75 | .75 | ** | 50* | 10 |
| SR-4/0-XY | 1 | 4/0 AWG | #6 AWG | 2.31 | 1.00 | 1.13 | 5/16 | 50 | 10 |
| SR-250-XY | 2 | 250 kcmil | #6 AWG | 3.94 | 1.00 | 1.13 | 5/16 | 275 | 10 |
| SR-350-XY | 2 | 350 kcmil | #6 AWG | 4.19 | 1.13 | 1.19 | 5/16 | 275 | 10 |
| SR-500-3Y | 2 | 500 kcmil | 3/0 AWG | 5.00 | 1.37 | 1.40 | 3/8 | 375 | 3 |
| SR-750-1Y | 2 | 750 kcmil | 250 kcmil | 6.25 | 1.63 | 1.75 | 1/2 | 500 | 1 |
| SR-1000-1Y | 3 | 1000 kcmil | 500 kcmil | 8.69 | 1.72 | 1.88 | 9/16 | 600 | 1 |

The use of PANDUIT oxide inhibiting joint compound (CMP-100) is recommended. See page D2.161.

*Listed torque values are for maximum conductor sizes, consult the installation instruction sheet for smaller sizes.

**Uses slotted screws.

D2.
Power
Connectors

D3.
Grounding
Connectors

E1.
Labeling
Systems

E2.
Labels

E3.
Pre-Printed
& Write-On
Markers

E4.
Permanent
Identification

E5.
Lockout/
Tagout/
& Safety
Solutions

F.
Index



Multi-Tap Connector with Clear Insulation, Single-Sided

For Use with Aluminum or Copper Code Conductors

Type PCSB-S

- Flexible design – can be used as a tap, splice, or dead end connector
- Body made from high strength, extruded aluminum alloy to provide premium electrical and mechanical performance
- Insulated with clear PVC to eliminate the need for taping and allow for visual inspection of the complete conductor insertion

- Each port pre-filled with oxide inhibiting joint compound seals out air and moisture to deter surface oxidation
- Wide wire range-taking capability minimizes inventory requirements
- Plated steel or aluminum set screw provides high strength, durable electrical contact between conductor and connector
- UL Listed and CSA Certified for use up to 600 V and temperature rated 90°C

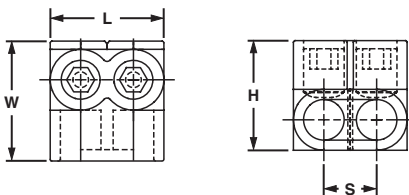

| Part Number | Conductor Size Range | No. of Ports | Figure Dimensions (In.) | | | | Hex Key Size (In.) | Tightening Torque (In.-Lbs.) | Std. Pkg. Qty. | |
|----------------|-------------------------|-------------------------|-------------------------|------|------|------|--------------------|------------------------------|----------------|---|
| | | | L | W | H | S | | | | |
| PCSB4-2S-12Y | #4 – 14 AWG STR | 2 | 1.08 | 1.12 | 1.25 | .44 | 1/8 | 50* | 12 | |
| PCSB4-3S-12Y | | 3 | 1.52 | 1.12 | 1.25 | .44 | 1/8 | 50* | 12 | |
| PCSB4-4S-6Y | | 4 | 1.96 | 1.12 | 1.25 | .44 | 1/8 | 50* | 6 | |
| PCSB4-5S-6Y | | 5 | 2.39 | 1.12 | 1.25 | .44 | 1/8 | 50* | 6 | |
| PCSB4-6S-6Y | | 6 | 2.83 | 1.12 | 1.25 | .44 | 1/8 | 50* | 6 | |
| PCSB4-10S-4Y | | 10 | 4.58 | 1.12 | 1.25 | .44 | 1/8 | 50* | 4 | |
| PCSB4-12S-3Y | | 12 | 5.46 | 1.12 | 1.25 | .44 | 1/8 | 50* | 3 | |
| PCSB4-14S-2Y | | 14 | 6.34 | 1.12 | 1.25 | .44 | 1/8 | 50* | 2 | |
| PCSB2/0-2S-6 | | 2/0 – 14 AWG STR | 2 | 1.52 | 1.32 | 1.19 | .67 | 3/16 | 120 | 6 |
| PCSB2/0-3S-6Y | | | 3 | 2.19 | 1.32 | 1.19 | .67 | 3/16 | 120 | 6 |
| PCSB2/0-4S-6Y | 4 | | 2.86 | 1.32 | 1.19 | .67 | 3/16 | 120 | 6 | |
| PCSB2/0-5S-4Y | 5 | | 3.53 | 1.32 | 1.19 | .67 | 3/16 | 120 | 4 | |
| PCSB2/0-6S-4Y | 6 | | 4.20 | 1.32 | 1.19 | .67 | 3/16 | 120 | 4 | |
| PCSB2/0-8S-3 | 8 | | 5.55 | 1.32 | 1.19 | .67 | 3/16 | 120 | 3 | |
| PCSB2/0-10S-2Y | 10 | | 6.89 | 1.32 | 1.19 | .67 | 3/16 | 120 | 2 | |
| PCSB2/0-12S-1Y | 12 | | 8.24 | 1.32 | 1.19 | .67 | 3/16 | 120 | 1 | |
| PCSB2/0-14S-1Y | 14 | | 9.58 | 1.32 | 1.19 | .67 | 3/16 | 120 | 1 | |
| PCSB250-2S-6Y | 250 kcmil – #10 AWG STR | | 2 | 2.03 | 2.07 | 2.13 | .94 | 5/16 | 275 | 6 |
| PCSB250-3S-6Y | | 3 | 2.97 | 2.07 | 2.13 | .94 | 5/16 | 275 | 6 | |
| PCSB250-4S-6Y | | 4 | 3.91 | 2.07 | 2.13 | .94 | 5/16 | 275 | 6 | |
| PCSB250-5S-4Y | | 5 | 4.84 | 2.07 | 2.13 | .94 | 5/16 | 275 | 4 | |
| PCSB250-6S-4Y | | 6 | 5.78 | 2.07 | 2.13 | .94 | 5/16 | 275 | 4 | |
| PCSB250-8S-3Y | | 8 | 7.66 | 2.07 | 2.13 | .94 | 5/16 | 275 | 3 | |
| PCSB250-10S-2Y | | 10 | 9.53 | 2.07 | 2.13 | .94 | 5/16 | 275 | 2 | |
| PCSB250-12S-2Y | | 12 | 11.41 | 2.07 | 2.13 | .94 | 5/16 | 275 | 2 | |
| PCSB250-14S-1Y | | 14 | 13.29 | 2.07 | 2.13 | .94 | 5/16 | 275 | 1 | |
| PCSB350-2S-4Y | | 350 kcmil – #10 AWG STR | 2 | 2.17 | 2.32 | 2.50 | 1.00 | 5/16 | 275 | 4 |
| PCSB350-3S-4Y | 3 | | 3.17 | 2.32 | 2.50 | 1.00 | 5/16 | 275 | 4 | |
| PCSB350-4S-3Y | 4 | | 4.17 | 2.32 | 2.50 | 1.00 | 5/16 | 275 | 3 | |
| PCSB350-5S-3Y | 5 | | 5.17 | 2.32 | 2.50 | 1.00 | 5/16 | 275 | 3 | |
| PCSB350-6S-2Y | 6 | | 6.17 | 2.32 | 2.50 | 1.00 | 5/16 | 275 | 2 | |
| PCSB350-8S-2Y | 8 | | 8.17 | 2.32 | 2.50 | 1.00 | 5/16 | 275 | 2 | |
| PCSB350-10S-2Y | 10 | | 10.17 | 2.32 | 2.50 | 1.00 | 5/16 | 275 | 2 | |
| PCSB350-12S-1Y | 12 | | 12.17 | 2.32 | 2.50 | 1.00 | 5/16 | 275 | 1 | |
| PCSB350-14S-1Y | 14 | | 14.17 | 2.32 | 2.50 | 1.00 | 5/16 | 275 | 1 | |
| PCSB600-2S-4Y | 600 kcmil – #4 AWG STR | | 2 | 2.72 | 2.38 | 2.75 | 1.28 | 3/8 | 375 | 4 |
| PCSB600-3S-3Y | | 3 | 4.00 | 2.38 | 2.75 | 1.28 | 3/8 | 375 | 3 | |
| PCSB600-4S-2Y | | 4 | 5.28 | 2.38 | 2.75 | 1.28 | 3/8 | 375 | 2 | |
| PCSB600-5S-2Y | | 5 | 6.56 | 2.38 | 2.75 | 1.28 | 3/8 | 375 | 2 | |
| PCSB600-6S-2Y | | 6 | 7.84 | 2.38 | 2.75 | 1.28 | 3/8 | 375 | 2 | |
| PCSB600-8S-2Y | | 8 | 10.41 | 2.38 | 2.75 | 1.28 | 3/8 | 375 | 2 | |
| PCSB600-10S-1Y | | 10 | 12.97 | 2.38 | 2.75 | 1.28 | 3/8 | 375 | 1 | |
| PCSB600-12S-1Y | | 12 | 15.93 | 2.38 | 2.75 | 1.28 | 3/8 | 375 | 1 | |
| PCSB600-14S-1Y | | 14 | 18.09 | 2.38 | 2.75 | 1.28 | 3/8 | 375 | 1 | |

*Listed torque values are for maximum conductor sizes, consult the packaging label for smaller sizes.

A. System Overview

B1. Cable Ties

B2. Cable Accessories

B3. Stainless Steel Ties

C1. Wiring Duct

C2. Surface Raceway

C3. Abrasion Protection

C4. Cable Management

D1. Terminals

D2. Power Connectors

D3. Grounding Connectors

E1. Labeling Systems

E2. Labels

E3. Pre-Printed & Write-On Markers

E4. Permanent Identification

E5. Lockout/Tagout & Safety Solutions

F. Index

A. System Overview



Multi-Tap Connector with Clear Insulation, Double-Sided

For Use with Aluminum or Copper Code Conductors

B1. Cable Ties

Type PCSB

- Flexible design – can be used as a tap, splice, or dead end connector
- Body made from high strength, extruded aluminum alloy to provide premium electrical and mechanical performance
- Insulated with clear PVC to eliminate the need for taping and allow for visual inspection of the complete conductor insertion
- Each port pre-filled with oxide inhibiting joint compound seals out air and moisture to deter surface oxidation

- Wide wire range-taking capability minimizes inventory requirements
- Dual-sided entry allows offset and opposite entry for primary and secondary conductors
- Plated steel or aluminum set screw provides high strength, durable electrical contact between conductor and connector
- UL Listed and CSA Certified for use up to 600 V and temperature rated 90°C

B2. Cable Accessories

B3. Stainless Steel Ties

C1. Wiring Duct

C2. Surface Raceway

C3. Abrasion Protection

C4. Cable Management

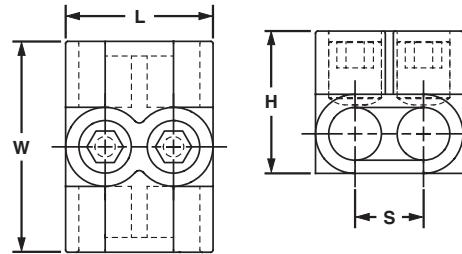

D1. Terminals

D2. Power Connectors

D3. Grounding Connectors

E1. Labeling Systems

E2. Labels

E3. Pre-Printed & Write-On Markers

E4. Permanent Identification

E5. Lockout/Tagout & Safety Solutions

F. Index

| Part Number | Conductor Size Range | No. of Ports | Figure Dimensions (In.) | | | | Hex Key Size (In.) | Tightening Torque (In.-Lbs.) | Std. Pkg. Qty. |
|----------------------|---------------------------------------|-------------------------------------|-------------------------|------|------|------|--------------------|------------------------------|----------------|
| | | | L | W | H | S | | | |
| PCSB4-2-12Y‡ | #4 – 14 AWG STR #10 – 14 AWG SOL | 2 | 1.16 | 1.50 | 1.25 | .49 | ** | 45* | 12 |
| PCSB4-3-12Y‡ | | 3 | 1.64 | 1.50 | 1.25 | .49 | ** | 45* | 12 |
| PCSB4-4-6Y‡ | | 4 | 2.13 | 1.50 | 1.25 | .49 | ** | 45* | 6 |
| PCSB4-5-6Y‡ | | 5 | 2.62 | 1.50 | 1.25 | .49 | ** | 45* | 6 |
| PCSB4-6-6Y‡ | | 6 | 3.10 | 1.50 | 1.25 | .49 | ** | 45* | 6 |
| PCSB4-7-4Y‡ | | 7 | 3.59 | 1.50 | 1.25 | .49 | ** | 45* | 4 |
| PCSB4-8-4Y‡ | | 8 | 4.08 | 1.50 | 1.25 | .49 | ** | 45* | 4 |
| PCSB4-10-4Y | | #4 – 14 AWG STR #10 – 14 AWG SOL | 10 | 4.58 | 1.50 | 1.25 | .44 | 1/8 | 50* |
| PCSB4-12-3Y | 12 | | 5.46 | 1.50 | 1.25 | .44 | 1/8 | 50* | 3 |
| PCSB4-14-2Y | 14 | | 6.34 | 1.50 | 1.25 | .44 | 1/8 | 50* | 2 |
| PCSB2/0-2-12‡ | 2/0 – #14 AWG STR #10 – 14 AWG SOL | 2 | 1.63 | 1.60 | 1.38 | .72 | 3/16 | 50* | 12 |
| PCSB2/0-3-6‡ | | 3 | 2.36 | 1.60 | 1.38 | .72 | 3/16 | 50* | 6 |
| PCSB2/0-4-6‡ | | 4 | 3.08 | 1.60 | 1.38 | .72 | 3/16 | 50* | 6 |
| PCSB2/0-5-6‡ | | 5 | 3.81 | 1.60 | 1.38 | .72 | 3/16 | 50* | 6 |
| PCSB2/0-6-6‡ | | 6 | 4.53 | 1.60 | 1.38 | .72 | 3/16 | 50* | 6 |
| PCSB2/0-7-4‡ | | 7 | 5.25 | 1.60 | 1.38 | .72 | 3/16 | 50* | 4 |
| PCSB2/0-8-4‡ | | 8 | 5.98 | 1.60 | 1.38 | .72 | 3/16 | 50* | 4 |
| PCSB2/0-10-2Y | | 2/0 – #14 AWG STR | 10 | 6.89 | 1.56 | 1.38 | .67 | 3/16 | 120 |
| PCSB2/0-12-2Y | 12 | | 8.24 | 1.56 | 1.38 | .67 | 3/16 | 120 | 2 |
| PCSB2/0-14-1Y | 14 | | 9.58 | 1.56 | 1.38 | .67 | 3/16 | 120 | 1 |
| PCSB250-2-6Y‡ | 250 kcmil – #6 AWG STR | 2 | 2.13 | 2.60 | 2.13 | .97 | 5/16 | 275 | 6 |
| PCSB250-3-6Y‡ | | 3 | 3.10 | 2.60 | 2.13 | .97 | 5/16 | 275 | 6 |
| PCSB250-4-6Y‡ | | 4 | 4.06 | 2.60 | 2.13 | .97 | 5/16 | 275 | 6 |
| PCSB250-5-4Y‡ | | 5 | 5.03 | 2.60 | 2.13 | .97 | 5/16 | 275 | 4 |
| PCSB250-6-4Y‡ | | 6 | 6.00 | 2.60 | 2.13 | .97 | 5/16 | 275 | 4 |
| PCSB250-7-3Y‡ | | 7 | 6.98 | 2.60 | 2.13 | .97 | 5/16 | 275 | 3 |
| PCSB250-8-3Y‡ | | 8 | 7.95 | 2.60 | 2.13 | .97 | 5/16 | 275 | 3 |
| PCSB250-10-2Y | | 250 kcmil – #10 AWG STR | 10 | 9.53 | 2.64 | 2.13 | .94 | 5/16 | 275 |
| PCSB250-12-2Y | 12 | | 11.41 | 2.64 | 2.13 | .94 | 5/16 | 275 | 2 |
| PCSB250-14-1Y | 14 | | 13.29 | 2.64 | 2.13 | .94 | 5/16 | 275 | 1 |

*Listed torque values are for maximum conductor sizes, consult the packaging label for smaller sizes.

**Uses slotted head set screw.

‡Not CSA Certified.

‡‡Not UL Listed or CSA Certified.



Multi-Tap Connector with Clear Insulation, Double-Sided (continued)

| Part Number | Conductor Size Range | No. of Ports | Figure Dimensions (In.) | | | | Hex Key Size (In.) | Tightening Torque (In.-Lbs.) | Std. Pkg. Qty. | |
|----------------------|--|------------------------|-------------------------|------|------|------|--------------------|------------------------------|----------------|---|
| | | | L | W | H | S | | | | |
| PCSB350-2-4‡ | 350 kcmil – #10 AWG STR #10 AWG SOL | 2 | 2.22 | 3.00 | 2.50 | 1.02 | 3/8 | 375 | 4 | |
| PCSB350-3-4‡ | | 3 | 3.24 | 3.00 | 2.50 | 1.02 | 3/8 | 375 | 4 | |
| PCSB350-4-3‡ | | 4 | 4.25 | 3.00 | 2.50 | 1.02 | 3/8 | 375 | 3 | |
| PCSB350-5-3‡ | | 5 | 5.28 | 3.00 | 2.50 | 1.02 | 3/8 | 375 | 3 | |
| PCSB350-6-2‡ | | 6 | 6.30 | 3.00 | 2.50 | 1.02 | 3/8 | 375 | 2 | |
| PCSB350-7-2‡ | | 7 | 7.31 | 3.00 | 2.50 | 1.02 | 3/8 | 375 | 2 | |
| PCSB350-8-2‡ | | 8 | 8.33 | 3.00 | 2.50 | 1.02 | 3/8 | 375 | 2 | |
| PCSB350-10-2Y | | 10 | 10.17 | 3.00 | 2.50 | 1.00 | 5/16 | 275 | 2 | |
| PCSB350-12-1Y | 350 kcmil – #10 AWG STR | 12 | 12.17 | 3.00 | 2.50 | 1.00 | 5/16 | 275 | 1 | |
| PCSB350-14-1Y | | 14 | 14.17 | 3.00 | 2.50 | 1.00 | 5/16 | 275 | 1 | |
| PCSB500-2-4Y‡ | | 2 | 2.71 | 3.00 | 2.75 | 1.27 | 3/8 | 375 | 4 | |
| PCSB500-3-3Y‡ | 500 kcmil – #6 AWG STR | 3 | 4.00 | 3.00 | 2.75 | 1.27 | 3/8 | 375 | 3 | |
| PCSB500-4-2Y‡ | | 4 | 5.26 | 3.00 | 2.75 | 1.27 | 3/8 | 375 | 2 | |
| PCSB500-5-2Y‡ | | 5 | 6.53 | 3.00 | 2.75 | 1.27 | 3/8 | 375 | 2 | |
| PCSB500-6-2Y‡ | | 6 | 7.81 | 3.00 | 2.75 | 1.27 | 3/8 | 375 | 2 | |
| PCSB500-7-2Y‡ | | 7 | 9.08 | 3.00 | 2.75 | 1.27 | 3/8 | 375 | 2 | |
| PCSB500-8-2Y‡ | | 8 | 10.35 | 3.00 | 2.75 | 1.27 | 3/8 | 375 | 2 | |
| PCSB600-2-4Y | | 600 kcmil – #4 AWG STR | 2 | 2.72 | 3.00 | 2.75 | 1.28 | 3/8 | 375 | 4 |
| PCSB600-3-3Y | | | 3 | 4.00 | 3.00 | 2.75 | 1.28 | 3/8 | 375 | 3 |
| PCSB600-4-2Y | 4 | | 5.28 | 3.00 | 2.75 | 1.28 | 3/8 | 375 | 2 | |
| PCSB600-5-2 | 5 | | 6.56 | 3.00 | 2.75 | 1.28 | 3/8 | 375 | 2 | |
| PCSB600-6-2Y | 6 | | 7.84 | 3.00 | 2.75 | 1.28 | 3/8 | 375 | 2 | |
| PCSB600-8-2Y | 8 | | 10.41 | 3.00 | 2.75 | 1.28 | 3/8 | 375 | 2 | |
| PCSB600-10-1Y | 10 | | 12.97 | 3.00 | 2.75 | 1.28 | 3/8 | 375 | 1 | |
| PCSB600-12-1Y | 12 | | 15.53 | 3.00 | 2.75 | 1.28 | 3/8 | 375 | 1 | |
| PCSB600-14-1Y | 14 | | 18.09 | 3.00 | 2.75 | 1.28 | 3/8 | 375 | 1 | |
| PCSB750-2-2Y‡‡ | 750 kcmil – 1/0 AWG STR | | 2 | 3.00 | 3.38 | 2.25 | 1.41 | 3/8 | 375 | 2 |
| PCSB750-3-2Y‡‡ | | 3 | 4.44 | 3.38 | 2.25 | 1.41 | 3/8 | 375 | 2 | |
| PCSB750-4-2Y‡‡ | | 4 | 5.81 | 3.38 | 2.25 | 1.41 | 3/8 | 375 | 2 | |
| PCSB750-5-1Y‡‡ | | 5 | 7.25 | 3.38 | 2.25 | 1.41 | 3/8 | 375 | 1 | |
| PCSB750-6-1Y‡‡ | | 6 | 8.63 | 3.38 | 2.25 | 1.41 | 3/8 | 375 | 1 | |
| PCSB750-7-1Y‡‡ | | 7 | 10.00 | 3.38 | 2.25 | 1.41 | 3/8 | 375 | 1 | |
| PCSB750-8-1Y‡‡ | | 8 | 11.44 | 3.38 | 2.25 | 1.41 | 3/8 | 375 | 1 | |
| PCSB750-9-1Y‡‡ | | 9 | 12.81 | 3.38 | 2.25 | 1.41 | 3/8 | 375 | 1 | |
| PCSB750-10-1Y‡‡ | | 10 | 14.25 | 3.38 | 2.25 | 1.41 | 3/8 | 375 | 1 | |

‡Not CSA Certified.

‡‡Not UL Listed or CSA Certified.

A.
System
Overview

B1.
Cable Ties

B2.
Cable
Accessories

B3.
Stainless
Steel Ties

C1.
Wiring
Duct

C2.
Surface
Raceway

C3.
Abrasion
Protection

C4.
Cable
Management

D1.
Terminals

D2.
Power
Connectors

D3.
Grounding
Connectors

E1.
Labeling
Systems

E2.
Labels

E3.
Pre-Printed
& Write-On
Markers

E4.
Permanent
Identification

E5.
Lockout/
Tagout
& Safety
Solutions

F.
Index

A.
System
Overview



In-Line Splicer/Reducer with Clear Insulation

B1.
Cable Ties

For Use with Aluminum or Copper Code Conductors

Type PISR

- Flexible design – can be used as a splice or reducer
- Dual rated for use with copper or aluminum conductors
- Made from high strength, extruded aluminum alloy to provide premium electrical and mechanical performance
- Insulated with clear PVC to eliminate the need for taping and allow for visual inspection of the complete conductor insertion
- Each port pre-filled with oxide inhibiting joint compound seals out air and moisture to deter surface oxidation
- Wide wire range-taking capability minimizes inventory requirements
- Plated steel or aluminum set screw provides high strength, durable electrical contact between conductor and connector
- UL Listed and CSA Certified for use up to 600 V and UL temperature rated 90°C

B2.
Cable
Accessories

B3.
Stainless
Steel Ties

C1.
Wiring
Duct

C2.
Surface
Raceway

C3.
Abrasion
Protection

C4.
Cable
Management

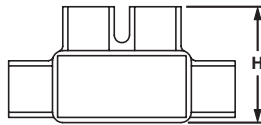
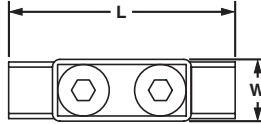

D1.
Terminals

D2.
Power
Connectors

D3.
Grounding
Connectors

E1.
Labeling
Systems

E2.
Labels

E3.
Pre-Printed
& Write-On
Markers

E4.
Permanent
Identification

E5.
Lockout/
Tagout/
& Safety
Solutions

F.
Index

| Part Number | Conductor Size Range | Figure Dimensions (In.) | | | Std. Pkg. Qty. |
|------------------|---------------------------|-------------------------|------|------|----------------|
| | | L | W | H | |
| PISR2-1 | #2 AWG STR – #14 AWG SOL | 2.38 | .75 | 1.25 | 1 |
| PISR1/0-1 | 1/0 AWG STR – #14 AWG SOL | 2.91 | .95 | 1.41 | 1 |
| PISR250-1 | 250 kcmil – #10 AWG SOL | 4.00 | 1.25 | 2.24 | 1 |
| PISR350-1 | 350 kcmil – #10 AWG SOL | 4.63 | 1.40 | 2.28 | 1 |
| PISR500-1 | 500 kcmil – #6 AWG SOL | 5.25 | 1.72 | 2.56 | 1 |



Multi-Tap Connector with Clear Insulation, Single-Sided, with Mounting Holes

For Use with Aluminum or Copper Code Conductors

Type PCSBMT-S

- Flexible design – can be used as a tap, splice, or dead end connector
- Body made from high strength, extruded aluminum alloy to provide premium electrical and mechanical performance
- Two isolated mounting holes at either end of connector facilitate direct mounting using 1/4" bolts
- Insulated with clear PVC to eliminate the need for taping and allow for visual inspection of the complete conductor insertion

- Each port pre-filled with oxide inhibiting joint compound seals out air and moisture to deter surface oxidation
- Wide wire range-taking capability minimizes inventory requirements
- Plated steel or aluminum set screw provides high strength, durable electrical contact between conductor and connector
- UL Listed and CSA Certified for use up to 600 V and temperature rated 90°C

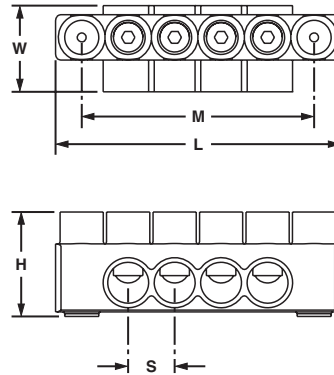

| Part Number | Conductor Size Range | No. of Ports | Figure Dimensions (In.) | | | | | Mounting Hole Size (In.) | Hex Key Size (In.) | Tightening Torque (In.-Lbs.) | Std. Pkg. Qty. |
|-----------------|-------------------------|--------------|-------------------------|------|------|------|-------|--------------------------|--------------------|------------------------------|----------------|
| | | | L | W | H | S | M | | | | |
| PCSBMT2/0-4S-3Y | 2/0 – #14 AWG STR | 4 | 4.20 | 1.38 | 1.50 | .67 | 3.00 | 1/4 | 3/16 | 120 | 3 |
| PCSBMT2/0-6S-2Y | | 6 | 5.55 | 1.38 | 1.50 | .67 | 4.70 | 1/4 | 3/16 | 120 | 2 |
| PCSBMT2/0-8S-2Y | | 8 | 6.89 | 1.38 | 1.50 | .67 | 6.05 | 1/4 | 3/16 | 120 | 2 |
| PCSBMT2/0-10S2Y | | 10 | 8.24 | 1.38 | 1.50 | .67 | 7.39 | 1/4 | 3/16 | 120 | 2 |
| PCSBMT2/0-12S1Y | | 12 | 9.58 | 1.38 | 1.50 | .67 | 8.74 | 1/4 | 3/16 | 120 | 1 |
| PCSBMT250-4S-2Y | 250 kcmil – #10 AWG STR | 4 | 5.78 | 2.07 | 2.26 | .94 | 4.69 | 1/4 | 5/16 | 275 | 2 |
| PCSBMT250-6S-2Y | | 6 | 7.66 | 2.07 | 2.26 | .94 | 6.57 | 1/4 | 5/16 | 275 | 2 |
| PCSBMT250-8S-2Y | | 8 | 9.53 | 2.07 | 2.26 | .94 | 8.44 | 1/4 | 5/16 | 275 | 2 |
| PCSBMT250-10S2Y | | 10 | 11.41 | 2.07 | 2.26 | .94 | 10.32 | 1/4 | 5/16 | 275 | 2 |
| PCSBMT250-12S1Y | | 12 | 13.29 | 2.07 | 2.26 | .94 | 12.19 | 1/4 | 5/16 | 275 | 1 |
| PCSBMT350-4S-2Y | 350 kcmil – #10 AWG STR | 4 | 6.17 | 2.32 | 2.63 | 1.00 | 5.00 | 1/4 | 5/16 | 275 | 2 |
| PCSBMT350-6S-2Y | | 6 | 8.17 | 2.32 | 2.63 | 1.00 | 7.00 | 1/4 | 5/16 | 275 | 2 |
| PCSBMT350-8S-2Y | | 8 | 10.17 | 2.32 | 2.63 | 1.00 | 9.00 | 1/4 | 5/16 | 275 | 2 |
| PCSBMT350-10S1Y | | 10 | 12.17 | 2.32 | 2.63 | 1.00 | 11.00 | 1/4 | 5/16 | 275 | 1 |
| PCSBMT350-12S1Y | | 12 | 14.17 | 2.32 | 2.63 | 1.00 | 13.00 | 1/4 | 5/16 | 275 | 1 |
| PCSBMT600-4S-2Y | 600 kcmil – #4 AWG STR | 4 | 7.84 | 2.38 | 2.88 | 1.28 | 6.41 | 1/4 | 3/8 | 375 | 2 |
| PCSBMT600-6S-2Y | | 6 | 10.41 | 2.38 | 2.88 | 1.28 | 8.97 | 1/4 | 3/8 | 375 | 2 |
| PCSBMT600-8S-2Y | | 8 | 12.97 | 2.38 | 2.88 | 1.28 | 11.53 | 1/4 | 3/8 | 375 | 2 |
| PCSBMT600-10S1Y | | 10 | 15.53 | 2.38 | 2.88 | 1.28 | 14.09 | 1/4 | 3/8 | 375 | 1 |
| PCSBMT600-12S1Y | | 12 | 18.09 | 2.38 | 2.88 | 1.28 | 16.65 | 1/4 | 3/8 | 375 | 1 |

A. System Overview

B1. Cable Ties

B2. Cable Accessories

B3. Stainless Steel Ties

C1. Wiring Duct

C2. Surface Raceway

C3. Abrasion Protection

C4. Cable Management

D1. Terminals

D2. Power Connectors

D3. Grounding Connectors

E1. Labeling Systems

E2. Labels

E3. Pre-Printed & Write-On Markers

E4. Permanent Identification

E5. Lockout/Tagout & Safety Solutions

F. Index

A.
System
Overview



Multi-Tap Connector with Clear Insulation, Double-Sided, with Mounting Holes

For Use with Aluminum or Copper Code Conductors

B1.
Cable Ties

Type PCSBMT

- Flexible design – can be used as a tap, splice, or dead end connector
- Body made from high strength, extruded aluminum alloy to provide premium electrical and mechanical performance
- Two isolated mounting holes at either end of connector facilitate direct mounting using 1/4" bolts
- Insulated with clear PVC to eliminate the need for taping and allow for visual inspection of the complete conductor insertion

- Each port pre-filled with oxide inhibiting joint compound seals out air and moisture to deter surface oxidation
- Wide wire range-taking capability minimizes inventory requirements
- Dual-sided entry allows offset and opposite entry for primary and secondary conductors
- Plated steel or aluminum set screw provides high strength, durable electrical contact between conductor and connector
- UL Listed and CSA Certified for use up to 600 V and temperature rated 90°C

B2.
Cable
Accessories

B3.
Stainless
Steel Ties

C1.
Wiring
Duct

C2.
Surface
Raceway

C3.
Abrasion
Protection

C4.
Cable
Management

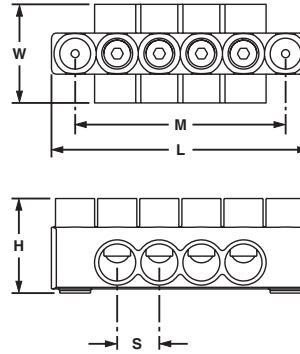

D1.
Terminals

D2.
Power
Connectors

D3.
Grounding
Connectors

E1.
Labeling
Systems

E2.
Labels

E3.
Pre-Printed
& Write-On
Markers

E4.
Permanent
Identification

E5.
Lockout/
Tagout/
& Safety
Solutions

F.
Index

| Part Number | Conductor Size Range | No. of Ports | Figure Dimensions (In.) | | | | | Mounting Hole Size (In.) | Hex Key Size (In.) | Tightening Torque (In.-Lbs.) | Std. Pkg. Qty. |
|-----------------|-------------------------|--------------|-------------------------|------|------|------|-------|--------------------------|--------------------|------------------------------|----------------|
| | | | L | W | H | S | M | | | | |
| PCSBMT2/0-4-3Y | 2/0 – #14 AWG STR | 4 | 4.20 | 1.56 | 1.50 | .67 | 3.00 | 1/4 | 3/16 | 120 | 3 |
| PCSBMT2/0-6-2Y | | 6 | 5.55 | 1.56 | 1.50 | .67 | 4.70 | 1/4 | 3/16 | 120 | 2 |
| PCSBMT2/0-8-2Y | | 8 | 6.89 | 1.56 | 1.50 | .67 | 6.05 | 1/4 | 3/16 | 120 | 2 |
| PCSBMT2/0-10-2Y | | 10 | 8.24 | 1.56 | 1.50 | .67 | 7.39 | 1/4 | 3/16 | 120 | 2 |
| PCSBMT2/0-12-1Y | 250 kcmil – #10 AWG STR | 12 | 9.58 | 1.56 | 1.50 | .67 | 8.74 | 1/4 | 3/16 | 120 | 1 |
| PCSBMT250-4-2Y | | 4 | 5.78 | 2.64 | 2.26 | .94 | 4.69 | 1/4 | 5/16 | 275 | 2 |
| PCSBMT250-6-2Y | | 6 | 7.66 | 2.64 | 2.26 | .94 | 6.57 | 1/4 | 5/16 | 275 | 2 |
| PCSBMT250-8-2Y | | 8 | 9.53 | 2.64 | 2.26 | .94 | 8.44 | 1/4 | 5/16 | 275 | 2 |
| PCSBMT250-10-2Y | 350 kcmil – #10 AWG STR | 10 | 11.41 | 2.64 | 2.26 | .94 | 10.32 | 1/4 | 5/16 | 275 | 2 |
| PCSBMT250-12-1Y | | 12 | 13.29 | 2.64 | 2.26 | .94 | 12.19 | 1/4 | 5/16 | 275 | 1 |
| PCSBMT350-4-2Y | | 4 | 6.17 | 3.00 | 2.63 | 1.00 | 5.00 | 1/4 | 5/16 | 275 | 2 |
| PCSBMT350-6-2Y | | 6 | 8.17 | 3.00 | 2.63 | 1.00 | 7.00 | 1/4 | 5/16 | 275 | 2 |
| PCSBMT350-8-2Y | 600 kcmil – #4 AWG STR | 8 | 10.17 | 3.00 | 2.63 | 1.00 | 9.00 | 1/4 | 5/16 | 275 | 2 |
| PCSBMT350-10-1Y | | 10 | 12.17 | 3.00 | 2.63 | 1.00 | 11.00 | 1/4 | 5/16 | 275 | 1 |
| PCSBMT350-12-1Y | | 12 | 14.17 | 3.00 | 2.63 | 1.00 | 13.00 | 1/4 | 5/16 | 275 | 1 |
| PCSBMT600-4-2Y | | 4 | 7.84 | 3.00 | 2.88 | 1.28 | 6.41 | 1/4 | 3/8 | 375 | 2 |
| PCSBMT600-6-2Y | 600 kcmil – #4 AWG STR | 6 | 10.41 | 3.00 | 2.88 | 1.28 | 8.97 | 1/4 | 3/8 | 375 | 2 |
| PCSBMT600-8-2Y | | 8 | 12.97 | 3.00 | 2.88 | 1.28 | 11.53 | 1/4 | 3/8 | 375 | 2 |
| PCSBMT600-10-1Y | | 10 | 15.53 | 3.00 | 2.88 | 1.28 | 14.09 | 1/4 | 3/8 | 375 | 1 |
| PCSBMT600-12-1Y | | 12 | 18.09 | 3.00 | 2.88 | 1.28 | 16.65 | 1/4 | 3/8 | 375 | 1 |

Belleville Compression Washers

Type CW

- Conical spring washer for use when assembling aluminum connectors to copper and/or steel pads, compensates for differing rates of thermal expansion to keep hardware assembly from loosening
- For assembly information, see page D2.162
- Made from hardened steel to provide high strength
- Cadmium-plated to inhibit corrosion

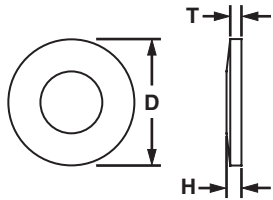

| Part Number | Stud Hole Size (In.) | Figure Dimensions (In.) | | | Std. Pkg. Qty. |
|-------------|----------------------|-------------------------|-----|-----|----------------|
| | | D | H | T | |
| CW-14-L | 1/4 | .68 | .09 | .05 | 50 |
| CW-56-L | 5/16 | .81 | .08 | .06 | 50 |
| CW-38-L | 3/8 | .93 | .10 | .07 | 50 |
| CW-12-Q | 1/2 | 1.18 | .12 | .09 | 25 |
| CW-58-Q | 5/8 | 1.49 | .15 | .12 | 25 |

Joint Compounds

For Use with Aluminum Connectors

Type CMP

- Oxide inhibitor for compression conductor connections lowers electrical resistance of compression joint while sealing out air and moisture to prevent the formation of surface oxides
- Wide operating temperature range; can be used in a wide range of electrical and environmental conditions
- Packaged in convenient dispenser bottles



| Part Number | Description | Std. Pkg. Qty. |
|-------------|--|----------------|
| CMP-100-1 | Contact aid for pad-to-pad or thread-to-thread aluminum connections, 8 oz. Operating temperature range -60°F (-51°C) to 400°F (204°C). | 1 |

A.
System
Overview

B1.
Cable Ties

B2.
Cable
Accessories

B3.
Stainless
Steel Ties

C1.
Wiring
Duct

C2.
Surface
Raceway

C3.
Abrasion
Protection

C4.
Cable
Management

D1.
Terminals

D2.
Power
Connectors

D3.
Grounding
Connectors

E1.
Labeling
Systems

E2.
Labels

E3.
Pre-Printed
& Write-On
Markers

E4.
Permanent
Identification

E5.
Lockout/
Tagout/
& Safety
Solutions

F.
Index

A.
System
Overview

Guidelines for Installing Aluminum Mechanical Connectors

B1.
Cable Ties



1. Select the correct connector for your application.

- Always use an aluminum conductor with an aluminum connector
- Verify that the connector is marked for the conductor size and type that you are using

B2.
Cable
Accessories

B3.
Stainless
Steel Ties

C1.
Wiring
Duct



2. Remove the insulation from insulated cable.

- See page D3.34 for *PANDUIT* cable stripping tools
- Use care to avoid nicking the conductor strands
- Strip the insulation to the proper length as listed in the installation instructions provided with *PANDUIT* connectors

C2.
Surface
Raceway

C3.
Abrasion
Protection

C4.
Cable
Management



3. Clean the exposed conductor using a wire brush or an emery cloth.

- In a similar manner, clean an unplated connector pad and the surface to which the connector will be attached
- Solvent should be used to clean plated parts that are dirty, but the plating should never be disturbed with abrasives

D1.
Terminals

D2.
Power
Connectors

D3.
Grounding
Connectors



4. Apply *PANDUIT* joint compound to the clean conductor for mechanical connector applications (see pages D2.161).

- Joint compound will deter the formation of surface oxides after installation
- Aluminum compression connectors and insulated mechanical connectors are pre-filled with joint compound

E1.
Labeling
Systems

E2.
Labels

E3.
Pre-Printed
& Write-On
Markers

E4.
Permanent
Identification

E5.
Lockout/
Tagout/
& Safety
Solutions



5. Insert the conductor into the connector and:

- For mechanical connectors, tighten the screws to the recommended torque values
- For compression connectors, use the recommended die and crimping tool to make the proper compression connection

F.
Index

PANDUIT Power Connector Approvals



| Logo (Symbol) | Agency | Spec/Approval | Applicable Products |
|---------------------|---------------------------------|--|--|
| | Underwriters Laboratories, Inc. | UL 486A Wire Connectors and Soldering Lugs for use in US and Canada | LCAX, LCBX, LCCX, LCDX, LCAN, LCDN, RSC, LCEX |
| | Underwriters Laboratories, Inc. | UL 486A Wire Connectors and Soldering Lugs for use in US | Copper and aluminum compression connectors (except: SCT, HTAP, TAPC, SAR); Copper and aluminum split bolts; Copper and aluminum mechanical lugs and splices (except: PNLC, LAM2A1000, LAM3B, LAM3SB, LAM3D, LAM4D, PCSB750, LAM2LB800) |
| | Underwriters Laboratories, Inc. | UL 486A Wire Connectors and Soldering Lugs for use in US | LCA-00, LCD-00, LCC-00, LCMA6, LCMA16, LCMA-00, LCMD6, LCD16, LCMD-00, SCMS16 |
| | Canadian Standards Association | C22.2 No. 65-03 Wire Connectors | Copper and aluminum compression connectors (except: SCT, HTAP, TAPC, SAR, CTAP, BPC); Copper and aluminum split bolts (except: SBCL, VT, VTA); Copper and aluminum mechanical lugs and splices (except: PNLC, LAM2A1000, LAM3B, LAM3SB, LAM3D, LAM4D, PCSB750, ML, ML-T, HL, HLB, HLA-90, PNL-2, HL-2, HL-2N, HHL-2N, H2L-2N, P2NLT, PNLC, HC, LAM2A1000, LAM2B, LAM2SB600, LAM2SB750, LAM3B, LAM3SB, LAM3D, LAM4D, PCSB750) |
| | American Bureau of Shipping | ABS Rules Steel Vessel Rules 1-1-4/7.7, 4-8-3/9.19, 4-8-4/21.27 | Copper compression connectors LCA, LCAF, LCAS, LCAX, LCB, LCC, LCD, S-R, LCDX, SCS, SCSF |
| NEBS Level 3 | Telcordia Technologies, Inc. | Network Equipment – Building Systems | Copper compression connectors LCAS, LCA, LCD, LCB, LCC, LCAF, LCCF, SCSS, SCS, SCL, SCSF |

A.
System
Overview

B1.
Cable Ties

B2.
Cable
Accessories

B3.
Stainless
Steel Ties

C1.
Wiring
Duct

C2.
Surface
Raceway

C3.
Abrasion
Protection

C4.
Cable
Management

D1.
Terminals

D2.
Power
Connectors

D3.
Grounding
Connectors

E1.
Labeling
Systems

E2.
Labels

E3.
Pre-Printed
& Write-On
Markers

E4.
Permanent
Identification

E5.
Lockout/
Tagout
& Safety
Solutions

F.
Index

A. System Overview

Recommended Termination Hardware

B1. Cable Ties

B2. Cable Accessories

B3. Stainless Steel Ties

C1. Wiring Duct

C2. Surface Raceway

C3. Abrasion Protection

C4. Cable Management

D1. Terminals

D2. Power Connectors

D3. Grounding Connectors

E1. Labeling Systems

E2. Labels

E3. Pre-Printed & Write-On Markers

E4. Permanent Identification

E5. Lockout/Tagout & Safety Solutions

F. Index

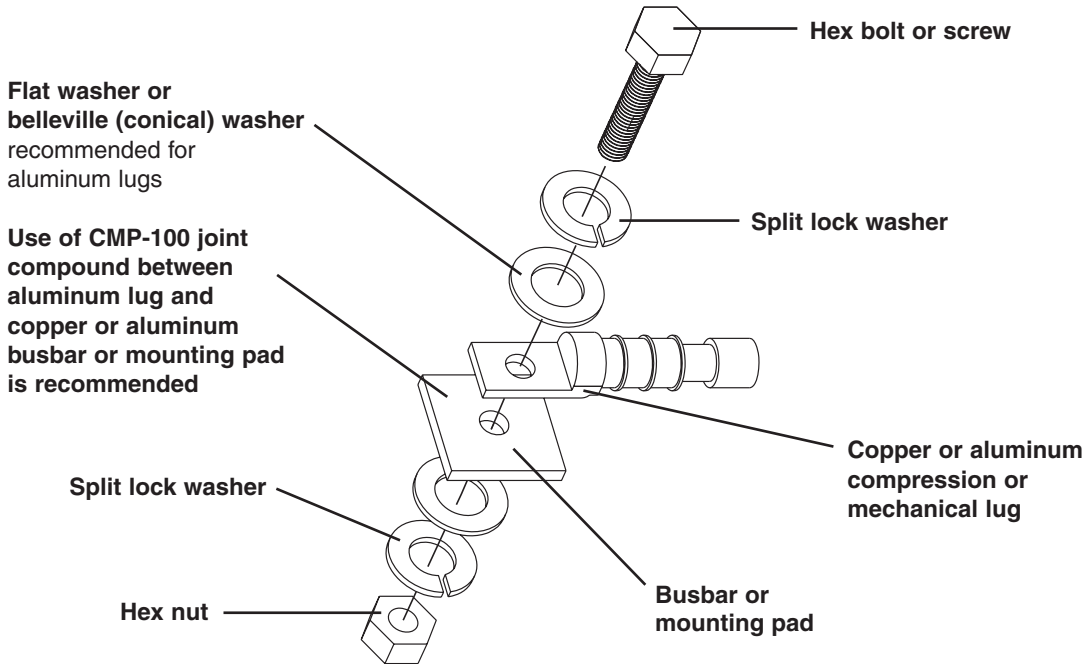
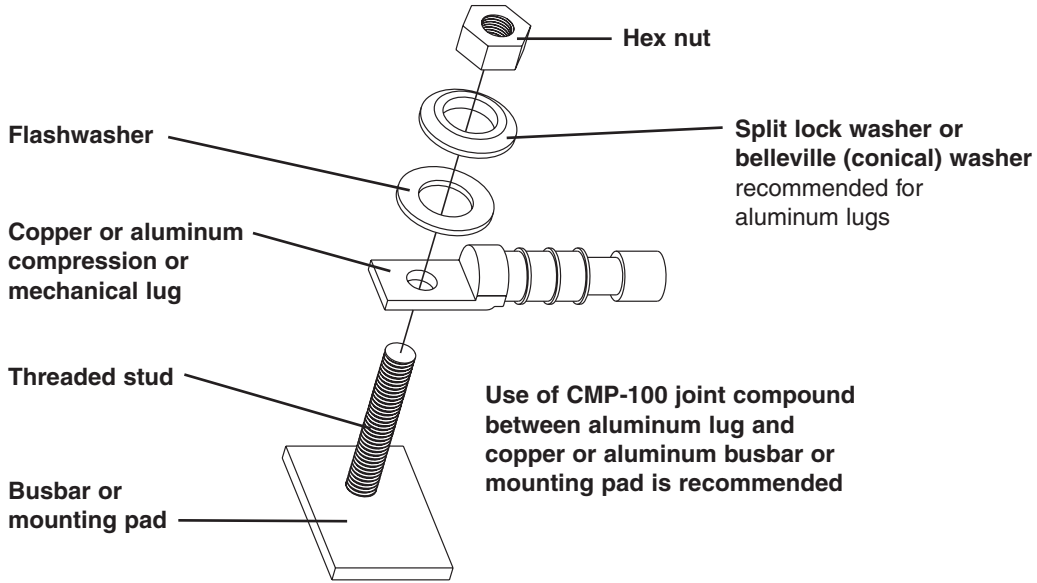

Recommended Hardware Material

Material Configuration of Lug/Mounting Surface

| Copper to Copper | Aluminum to Copper | Aluminum to Aluminum | Copper to Steel | Aluminum to Steel |
|---|--|---|---|---|
| <ol style="list-style-type: none"> 1. Silicon bronze 2. Stainless steel | <ol style="list-style-type: none"> 1. Silicon bronze 2. Aluminum 3. Stainless steel | <ol style="list-style-type: none"> 1. Aluminum 2. Stainless steel 3. Plated silicon bronze | <ol style="list-style-type: none"> 1. Silicon bronze 2. Stainless steel | <ol style="list-style-type: none"> 1. Aluminum 2. Stainless steel |

Conductor Sizes

Copper Concentric Stranded Conductor Sizes

| Conductor Size AWG or kcmil | Number of Strands | Nominal Diameter (In.) | Class |
|--------------------------------|----------------------|---------------------------|-------|
| #20 | 7 | .036 /3 | B |
| #18 | 7 | .045 /6 | B |
| #16 | 7 | .057 /6 | B |
| #14 | 7 | .072 /6 | B |
| #12 | 7 | .091 /5 | B |
| #10 | 7 | .116 | B |
| #9 | 7 | .130 | B |
| #8 | 7 | .146 | B |
| #7 | 7 | .164 | B |
| #6 | 7 | .184 | B |
| #5 | 7 | .206 | B |
| #4 | 3 | .254 | AA |
| #4 | 7 | .232 | B&A |
| #3 | 3 | .285 | AA |
| #3 | 7 | .260 | B&A |
| #2 | 3 | .320 | AA |
| #2 | 7 | .292 | B&A |
| #1 | 3 | .360 | AA |
| #1 | 7 | .328 | AA |
| #1 | 19 | .332 | B |
| 1/0 | 7 | .368 | A&A |
| 1/0 | 12 | .390 | — |
| 1/0 | 19 | .373 | B |
| 2/0 | 7 | .414 | A&A |
| 2/0 | 12 | .438 | — |
| 2/0 | 19 | .419 | B |
| 3/0 | 7 | .464 | A&A |
| 3/0 | 12 | .492 | — |
| 3/0 | 19 | .470 | B |
| 4/0 | 7 | .522 | A&A |
| 4/0 | 12 | .522 | — |
| 4/0 | 19 | .528 | B |
| 250 | 12 | .600 | AA |
| 250 | 19 | .574 | A |
| 250 | 37 | .575 | B |
| 300 | 12 | .657 | AA |
| 300 | 19 | .628 | A |
| 300 | 37 | .630 | B |
| 350 | 12 | .710 | AA |
| 350 | 19 | .679 | A |
| 350 | 37 | .681 | B |
| 400 | 19 | .726 | A&AA |
| 400 | 37 | .728 | B |
| 450 | 19 | .770 | AA |
| 450 | 37 | .772 | B&A |
| 500 | 19 | .811 | AA |
| 500 | 37 | .813 | B&A |
| 600 | 37 | .891 | A&AA |
| 600 | 61 | .893 | B |
| 700 | 37 | .963 | BB |
| 700 | 61 | .964 | B&A |
| 750 | 37 | .977 | AA |
| 750 | 61 | .998 | B&A |
| 800 | 37 | 1.029 | AA |
| 800 | 61 | 1.031 | B&A |
| 900 | 37 | 1.092 | AA |
| 900 | 61 | 1.094 | B&A |
| 1000 | 37 | 1.151 | AA |
| 1000 | 61 | 1.152 | B&A |
| 1000 | 61 | 1.152 | B&A |

Flexible Copper Conductor Sizes

| Conductor Size AWG or kcmil | Number of Strands | Nominal Diameter (In.) | Class |
|--------------------------------|----------------------|---------------------------|-------------------|
| #8 | 41/.0201 | .156 | I |
| #8 | 49/.0184 | .166 | G |
| #8 | 133/.0111 | .167 | H |
| #8 | 168/.010 | .157 | K |
| #8 | 37 | .330 | Locomotive (DLO) |
| #8 | 420/.0063 | .162 | M |
| #7 | 49/.0206 | .185 | G |
| #7 | 52/.0201 | .185 | I |
| #7 | 133/.0125 | .188 | H |
| #7 | 210/.010 | .179 | K |
| #7 | — | — | Locomotive (DLO) |
| #7 | 532/.0063 | .196 | M |
| #6 | 49/.0231 | .208 | G |
| #6 | 63/.0201 | .207 | I |
| #6 | 133/.0140 | .210 | H |
| #6 | 266/.010 | .210 | K |
| #6 | 61 | .410 | Locomotive (DLO) |
| #6 | 665/.0063 | .215 | M |
| #5 | 49/.0260 | .234 | G |
| #5 | 84/.0201 | .235 | I |
| #5 | 133/.0158 | .237 | H |
| #5 | 336/.010 | .235 | K |
| #5 | — | — | Locomotive (DLO) |
| #5 | 836/.0063 | .240 | M |
| #4 | 49/.0292 | .263 | G |
| #4 | 105/.0201 | .263 | I |
| #4 | 133/.0177 | .266 | H |
| #4 | 420/.010 | .272 | K |
| #4 | 105 | .460 | Locomotive (DLO) |
| #4 | 1064/.0063 | .269 | M |
| #3 | 49/.0328 | .295 | G |
| #3 | 133/.0199 | .299 | H |
| #3 | 133/.0201 | .291 | I |
| #3 | 532/.010 | .304 | K |
| #3 | 125 | .480 | Locomotive (DLO) |
| #3 | 1323/.0063 | .305 | M |
| #2 | 49/.0368 | .331 | G |
| #2 | 133/.0223 | .335 | H |
| #2 | 161/.0201 | .319 | I |
| #2 | 665/.010 | .338 | K |
| #2 | 150 | .510 | Locomotive (DLO) |
| #2 | 1666/.0063 | .337 | M |
| #1 | 133/.0251 | .337 | G |
| #1 | 210/.0201 | .367 | I |
| #1 | 259/.018 | .378 | H |
| #1 | 836/.010 | .397 | K |
| #1 | 225 | .650 | Locomotive (DLO) |
| #1 | 2107/.0063 | .376 | M |
| 1/0 | 133/.0282 | .423 | G |
| 1/0 | 259/.0202 | .424 | H |
| 1/0 | 266/.0201 | .441 | I |
| 1/0 | 1064/.010 | .451 | K |
| 1/0 | 275 | .680 | Locomotive (DLO) |
| 1/0 | 2646/.0063 | .423 | M |
| 2/0 | 133/.0316 | .474 | G |
| 2/0 | 259/.0227 | .477 | H |
| 2/0 | 342/.0201 | .500 | I |
| 2/0 | 1323/.010 | .470 | K |
| 2/0 | 325 | .720 | Locomotive (DLO) |
| 2/0 | 3325/.0063 | .508 | M |

Table continues on page D2.166

A.
System
Overview

B1.
Cable
Ties

B2.
Cable
Accessories

B3.
Stainless
Steel Ties

C1.
Wiring
Duct

C2.
Surface
Raceway

C3.
Abrasion
Protection

C4.
Cable
Management

D1.
Terminals

D2.
Power
Connectors

D3.
Grounding
Connectors

E1.
Labeling
Systems

E2.
Labels

E3.
Pre-Printed
& Write-On
Markers

E4.
Permanent
Identification

E5.
Lockout/
Tagout
& Safety
Solutions

F.
Index

A.
System
Overview

Conductor Sizes (continued)

B1.
Cable Ties

Flexible Copper Conductor Sizes

| Conductor Size AWG or kcmil | No. of Strands/ Strand Dia. | Nominal Diameter (In.) | Class |
|--------------------------------|--------------------------------|---------------------------|------------------|
| 3/0 | 133/.0355 | .533 | G |
| 3/0 | 259/.0255 | .536 | H |
| 3/0 | 418/.0201 | .549 | I |
| 3/0 | 1666/.010 | .533 | K |
| 3/0 | 450 | .810 | Locomotive (DLO) |
| 3/0 | 4256/.0063 | .576 | M |
| 4/0 | 133/.0399 | .599 | G |
| 4/0 | 259/.0286 | .601 | H |
| 4/0 | 532/.0201 | .613 | I |
| 4/0 | 2107/.010 | .627 | K |
| 4/0 | 550 | .840 | Locomotive (DLO) |
| 4/0 | 5320/.0063 | .645 | M |
| 250 | 259/.0311 | .650 | G |
| 250 | 427/.0242 | .653 | H |
| 250 | 637/.0201 | .682 | I |
| 250 | 2499/.010 | .682 | K |
| 262.6 | 650 | .960 | Locomotive (DLO) |
| 250 | 6384/.0063 | .713 | M |
| 300 | 259/.0340 | .714 | G |
| 300 | 427/.0265 | .716 | H |
| 300 | 735/.0201 | .737 | I |
| 300 | 2989/.010 | .768 | K |
| 313.1 | 775 | 1.040 | Locomotive (DLO) |
| 300 | 7581/.0063 | .768 | M |
| 350 | 259/.0368 | .773 | G |
| 350 | 427/.0268 | .772 | H |
| 350 | 882/.0201 | .800 | I |
| 350 | 3458/.010 | .809 | K |
| 373.7 | 925 | 1.140 | Locomotive (DLO) |
| 350 | 8806/.0063 | .825 | M |
| 400 | 259/.0393 | .825 | G |
| 400 | 427/.0306 | .826 | H |
| 400 | 980/.0201 | .831 | I |
| 400 | 3990/.010 | .878 | K |
| 400 | — | — | Locomotive (DLO) |
| 400 | 10101/.0063 | .901 | M |
| 450 | 259/.0417 | .876 | G |
| 450 | 427/.325 | .878 | H |
| 450 | 1127/.0201 | .894 | I |
| 450 | 4522/.010 | .933 | K |
| 444.4 | 1100 | 1.230 | Locomotive (DLO) |
| 450 | 11396/.0063 | .940 | M |
| 500 | 259/.0439 | .922 | G |
| 500 | 427/.0342 | .923 | H |
| 500 | 1125/.0201 | .941 | I |
| 500 | 5054/.010 | .988 | K |
| 535.3 | 1325 | 1.320 | Locomotive (DLO) |
| 500 | 12691/.0063 | .997 | M |
| 600 | 427/.0375 | 1.013 | G |
| 600 | 703/.0292 | 1.022 | H |
| 600 | 1470/.0201 | 1.027 | I |
| 600 | 5985/.010 | 1.125 | K |
| 646.4 | 1600 | 1.450 | Locomotive (DLO) |
| 600 | 14945/.0063 | 1.084 | M |
| 700 | 427/.0405 | 1.094 | G |
| 700 | 703/.0316 | 1.106 | H |
| 700 | 1729/.0201 | 1.194 | I |
| 700 | 6916/.010 | 1.207 | K |
| 777.7 | 1925 | 1.540 | Locomotive (DLO) |
| 700 | 17507/.0063 | 1.183 | M |

Flexible Copper Conductor Sizes

| Conductor Size AWG or kcmil | No. of Strands/ Strand Dia. | Nominal Diameter (In.) | Class |
|--------------------------------|--------------------------------|---------------------------|------------------|
| 800 | 427/.0433 | 1.169 | G |
| 800 | 703/.0337 | 1.180 | H |
| 800 | 1995/.0201 | 1.290 | I |
| 800 | 7980/.010 | 1.305 | K |
| 800 | — | — | Locomotive (DLO) |
| 800 | 20069/.0063 | 1.256 | M |
| 900 | 427/.0459 | 1.239 | G |
| 900 | 703/.0358 | 1.253 | H |
| 900 | 2261/.0201 | 1.372 | I |
| 900 | 9065/.010 | 1.323 | K |
| 900 | — | — | Locomotive (DLO) |
| 900 | 22631/.0063 | 1.331 | M |
| 1000 | 427/.0484 | 1.307 | G |
| 1000 | 703/.0377 | 1.320 | H |
| 1000 | 2527/.0201 | 1.427 | I |
| 1000 | 10101/.010 | 1.419 | K |
| 1000 | — | — | Locomotive (DLO) |
| 1000 | 25193/.0063 | 1.404 | M |

Copper Compact Stranded Conductor Sizes

| Conductor Size AWG or kcmil | Number of Strands | Conductor Diameter (In.) | Class |
|--------------------------------|----------------------|-----------------------------|---------|
| #8 | 7 | .134 | Compact |
| #6 | 7 | .169 | Compact |
| #4 | 7 | .213 | Compact |
| #2 | 7 | .268 | Compact |
| #1 | 19 | .299 | Compact |
| 1/0 | 19 | .336 | Compact |
| 1/0 | 19 | .376 | Compact |
| 3/0 | 19 | .423 | Compact |
| 4/0 | 19 | .475 | Compact |
| 250 | 37 | .520 | Compact |
| 300 | 37 | .570 | Compact |
| 350 | 37 | .616 | Compact |
| 400 | 37 | .659 | Compact |
| 450 | 37 | .700 | Compact |
| 500 | 37 | .736 | Compact |
| 550 | 61 | .775 | Compact |
| 600 | 61 | .813 | Compact |
| 650 | 61 | .845 | Compact |
| 700 | 61 | .877 | Compact |
| 750 | 61 | .908 | Compact |
| 800 | 61 | .938 | Compact |
| 900 | 61 | .999 | Compact |
| 1000 | 61 | 1.060 | Compact |

F.
Index

Conductor Sizes (continued)

Copper Solid Conductor Sizes

| Solid Copper Conductor Size AWG or kcmil | Conductor Diameter (In.) |
|--|--------------------------|
| #18 | .040 |
| #17 | .045 |
| #16 | .050 |
| #15 | .057 |
| #14 | .064 |
| #13 | .071 |
| #12 | .080 |
| #11 | .090 |
| #10 | .101 |
| #9 | .114 |
| #8 | .128 |
| #7 | .128 |
| #6 | .162 |
| #5 | .181 |
| #4 | .204 |
| #3 | .229 |
| #2 | .257 |
| #1 | .289 |
| 1/0 | .324 |
| 2/0 | .364 |
| 3/0 | .409 |
| 4/0 | .460 |

Aluminum Concentric Stranded Conductor Sizes

| Class B Aluminum Concentric AWG or kcmil | Number of Strands | Diameter of each Strand (Mils) |
|--|-------------------|--------------------------------|
| #8 | 7 | 48.6 |
| #7 | 7 | 54.5 |
| #6 | 7 | 61.2 |
| #5 | 7 | 68.8 |
| #4 | 7 | 77.2 |
| #3 | 7 | 86.7 |
| #2 | 7 | 97.4 |
| #1 | 19 | 66.4 |
| 1/0 | 19 | 74.5 |
| 2/0 | 19 | 83.7 |
| 3/0 | 19 | 94.0 |
| 4/0 | 19 | 105.5 |
| 250 | 37 | 82.2 |
| 300 | 37 | 90.0 |
| 350 | 37 | 97.3 |
| 400 | 37 | 104.0 |
| 450 | 37 | 110.3 |
| 500 | 37 | 116.2 |
| 550 | 61 | 95.0 |
| 600 | 61 | 99.2 |
| 650 | 61 | 103.2 |
| 700 | 61 | 107.1 |
| 750 | 61 | 110.9 |
| 800 | 61 | 114.5 |
| 900 | 61 | 121.5 |
| 1000 | 61 | 128.0 |

Aluminum Compact Stranded Conductor Sizes

| Compact Aluminum AWG or kcmil | Class ASTM B400 | Number of Strands | Conductor Diameter (In.) |
|-------------------------------|-----------------|-------------------|--------------------------|
| #8 | A, B | 7 | .134 |
| #6 | A, B | 7 | .169 |
| #4 | A, B | 7 | .213 |
| #3 | A, B | 7 | .238 |
| #2 | AA, A, B | 7 | .268 |
| #1 | AA, A | 7 | .299 |
| #1 | B | 19 | .299 |
| 1/0 | AA, A | 7 | .336 |
| 1/0 | B | 19 | .336 |
| 2/0 | AA, A | 7 | .376 |
| 2/0 | B | 19 | .376 |
| 3/0 | AA, A | 7 | .423 |
| 3/0 | B | 19 | .423 |
| 4/0 | AA, A | 7 | .475 |
| 4/0 | B | 19 | .475 |
| 250 | AA | 7 | .520 |
| 250 | A | 19 | .520 |
| 250 | B | 37 | .520 |
| 266 | AA | 7 | .337 |
| 266 | A | 19 | .337 |
| 300 | AA | 7 | .570 |
| 300 | A | 19 | .570 |
| 300 | B | 37 | .570 |
| 336 | AA | 7 | .603 |
| 336 | A | 19 | .603 |
| 350 | A | 19 | .616 |
| 350 | B | 37 | .616 |
| 397 | AA, A | 19 | .659 |
| 400 | B | 37 | .659 |
| 450 | B | 37 | .700 |
| 477 | AA | 19 | .722 |
| 500 | AA | 19 | .736 |
| 500 | B | 37 | .736 |
| 550 | B | 61 | .775 |
| 556 | AA | 19 | .780 |
| 600 | B | 61 | .813 |
| 650 | B | 61 | .845 |
| 700 | B | 61 | .877 |
| 750 | B | 61 | .908 |
| 800 | B | 61 | .938 |
| 900 | B | 61 | .999 |
| 1000 | B | 61 | 1.060 |

A.
System
Overview

B1.
Cable
Ties

B2.
Cable
Accessories

B3.
Stainless
Steel
Ties

C1.
Wiring
Duct

C2.
Surface
Raceway

C3.
Abrasion
Protection

C4.
Cable
Management

D1.
Terminals

D2.
Power
Connectors

D3.
Grounding
Connectors

E1.
Labeling
Systems

E2.
Labels

E3.
Pre-Printed
& Write-On
Markers

E4.
Permanent
Identification

E5.
Lockout/
Tagout
& Safety
Solutions

F.
Index

A.
System
Overview

Common Conductor Sizes and Strandings Reference Chart

B1.
Cable Ties

B2.
Cable
Accessories

B3.
Stainless
Steel Ties

C1.
Wiring
Duct

C2.
Surface
Raceway

C3.
Abrasion
Protection

C4.
Cable
Management

D1.
Terminals

D2.
Power
Connectors

D3.
Grounding
Connectors

E1.
Labeling
Systems

E2.
Labels

E3.
Pre-Printed
& Write-On
Markers

E4.
Permanent
Identification

E5.
Lockout/
Tagout
& Safety
Solutions

F.
Index

| Conductor | Individual Strands | | | Overall Conductor Size | | | Conductor | Individual Strands | | | Overall Conductor Size | | | | |
|-----------|------------------------|-----|----------|------------------------|------|-------|------------|--------------------|------------------------|----------|------------------------|------|------|------|------------|
| | Diameter | | Diameter | Diameter | | Area | | Diameter | | Diameter | Diameter | | Area | | |
| AWG | Metric mm ² | No. | mm | In. | mm | In. | Circ. MILS | AWG | Metric mm ² | No. | mm | In. | mm | In. | Circ. MILS |
| | .05 | 25 | .05 | .002 | .25 | .010 | 97 | | | 19 | 0.25 | .010 | 1.30 | .051 | 1841 |
| | .06 | 41 | .05 | .002 | .36 | .014 | 159 | | | 1 | 1.13 | .044 | 1.13 | .044 | 1979 |
| 26 | | 10 | .13 | .005 | .53 | .021 | 250 | | 1.0 | 32 | .20 | .008 | 1.30 | .051 | 1984 |
| | | 1 | .41 | .016 | .41 | .016 | 256 | | | 7 | .43 | .017 | 1.30 | .051 | 2006 |
| | | 7 | .16 | .006 | .48 | .019 | 278 | | | 19 | .29 | .011 | 1.47 | .058 | 2426 |
| | | 19 | .10 | .004 | .51 | .020 | 304 | | | 65 | .16 | .006 | 1.50 | .059 | 2580 |
| 24 | | 41 | .08 | .003 | .58 | .023 | 384 | 16 | | *26 | .25 | .010 | 1.50 | .059 | 2600 |
| | | 10 | .16 | .006 | .58 | .023 | 397 | | | 1 | 1.30 | .051 | 1.30 | .051 | 2601 |
| | | 1 | .51 | .020 | .51 | .020 | 400 | | | 105 | .13 | .005 | 1.50 | .059 | 2625 |
| | | 7 | .20 | .008 | .61 | .024 | 448 | | | *7 | .51 | .020 | 1.52 | .060 | 2828 |
| 22 | | 19 | .13 | .005 | .61 | .024 | 475 | | 1.5 | 30 | .25 | .010 | 1.70 | .067 | 2906 |
| | | 65 | .07 | .003 | .65 | .026 | 484 | | | 21 | .30 | .012 | 1.60 | .063 | 2930 |
| | | 128 | .05 | .002 | .65 | .026 | 496 | | | 189 | .10 | .004 | 1.90 | .075 | 2930 |
| | | 32 | .10 | .004 | .65 | .026 | 496 | | | 7 | .52 | .020 | 1.60 | .063 | 2934 |
| 20 | | 14 | .16 | .006 | .65 | .026 | 556 | | 2.5 | 1 | 1.38 | .054 | 1.38 | .054 | 2952 |
| | | 1 | .64 | .025 | .64 | .025 | 625 | | | 45 | .16 | .006 | 1.85 | .073 | 3786 |
| | | 16 | .16 | .006 | .76 | .030 | 635 | | | 19 | .38 | .014 | 1.85 | .073 | 3831 |
| | | 26 | .13 | .005 | .76 | .030 | 650 | | | 1 | 1.63 | .064 | 1.63 | .064 | 4096 |
| 18 | | 7 | .25 | .010 | .76 | .030 | 700 | 14 | | *41 | .25 | .010 | 1.85 | .073 | 4100 |
| | | 19 | .16 | .006 | .79 | .031 | 754 | | | *7 | .64 | .025 | 1.85 | .073 | 4481 |
| | | 48 | .10 | .004 | .80 | .031 | 744 | | | 50 | .25 | .010 | 2.20 | .087 | 4844 |
| | | 194 | .05 | .002 | .80 | .031 | 752 | | | 7 | .67 | .026 | 2.10 | .083 | 4871 |
| 16 | | 100 | .07 | .003 | .80 | .031 | 760 | | 4.0 | 35 | .30 | .012 | 2.20 | .087 | 4883 |
| | | 7 | .27 | .011 | .80 | .031 | 791 | | | 315 | .10 | .004 | 2.20 | .087 | 4883 |
| | | 12 | .21 | .008 | .80 | .031 | 820 | | | 1 | 1.78 | .070 | 1.78 | .070 | 4911 |
| | | 21 | .16 | .006 | .80 | .031 | 833 | | | 19 | .45 | .018 | 2.36 | .093 | 6088 |
| 14 | | 7 | .30 | .012 | .90 | .035 | 977 | 12 | | *65 | .25 | .010 | 2.41 | .095 | 6500 |
| | | 16 | .20 | .008 | .90 | .035 | 992 | | | 165 | .16 | .006 | 2.41 | .095 | 6549 |
| | | 1 | .80 | .031 | .80 | .031 | 992 | | | 1 | 2.06 | .081 | 2.06 | .081 | 6561 |
| | | *10 | .25 | .010 | .89 | .035 | 1000 | | | *7 | .81 | .032 | 2.44 | .096 | 7168 |
| 12 | | 1 | .81 | .032 | .81 | .032 | 1024 | | 6.0 | 56 | .30 | .012 | 3.10 | .122 | 7812 |
| | | 41 | .13 | .005 | .91 | .036 | 1025 | | | 1 | 2.26 | .089 | 2.26 | .089 | 7917 |
| | | 26 | .16 | .006 | .91 | .036 | 1032 | | | 511 | .10 | .004 | 3.00 | .118 | 7921 |
| | | *7 | .32 | .013 | .97 | .038 | 1111 | | | 19 | .52 | .020 | 2.70 | .106 | 7963 |
| 10 | | 19 | .20 | .008 | .94 | .037 | 1216 | 10 | | 37 | .40 | .016 | 2.92 | .115 | 9354 |
| | | 7 | .37 | .015 | 1.10 | .043 | 1485 | | | 49 | .36 | .014 | 2.95 | .116 | 9880 |
| | | 24 | .20 | .008 | 1.20 | .047 | 1488 | | | *7 | .98 | .039 | 2.95 | .116 | 10376 |
| | | 1 | 1.00 | .039 | 1.00 | .039 | 1550 | | | 1 | 2.59 | .102 | 2.59 | .102 | 10404 |
| 8 | | *16 | .25 | .010 | 1.19 | 0.047 | 1600 | | 10 | *105 | .25 | .010 | 2.95 | .116 | 10500 |
| | | 1 | 1.02 | .040 | 1.02 | .040 | 1600 | | | 84 | .30 | .012 | 3.50 | .138 | 11718 |
| | | 65 | .13 | .005 | 1.19 | .047 | 1625 | | | 756 | .10 | .004 | 3.70 | .146 | 11718 |
| | | 41 | .16 | .006 | 1.19 | .047 | 1627 | | | 1 | 2.76 | .109 | 2.76 | .109 | 11807 |
| 6 | | *7 | .40 | .016 | 1.22 | .048 | 1770 | | 6.0 | 7 | 1.05 | .041 | 3.20 | .126 | 11962 |
| | | 19 | .25 | .010 | 1.24 | .049 | 1900 | | | 19 | .64 | .025 | 3.30 | .130 | 12063 |

*Strandings required for UL and CSA Certification testing.

This chart details the different conductors commonly used in the industry. For each size, either AWG or Metric, various stranding options are listed. Typically the higher stranding is used in applications requiring greater conductor flexibility.

| AWG to Metric Wire Crosses | |
|----------------------------|---------------------------|
| AWG | Metric (mm ²) |
| 26 – 22 | 0.1 – 0.5 |
| 22 – 18 | 0.5 – 1.0 |
| 16 – 14 | 1.5 – 2.5 |
| 12 – 10 | 4.0 – 6.0 |

Common Conductor Sizes and Strandings Reference Chart (continued)

| Conductor | | Individual Strands | | | Overall Conductor Size | | | Conductor | | Individual Strands | | | Overall Conductor Size | | |
|-----------|------------------------|--------------------|----------|--------|------------------------|-------|--------|------------|-----|--------------------|----------|-------|------------------------|-------------|--------------|
| | | No. | Diameter | | Diameter | | Area | | | No. | Diameter | | Diameter | | Area |
| AWG | Metric mm ² | | | mm | In. | mm | In. | Circ. MILS | | | | | mm | In. | Circ. MILS |
| | 6 | 7 | 0.107 | 0.042 | 3.21 | 0.126 | 11840 | 95 | 19 | 2.57 | 0.101 | 12.8 | 0.505 | 187500 | |
| | | 1 | 2.77 | 0.109 | 2.77 | 0.109 | 11840 | | 37 | 1.83 | 0.072 | 12.5 | 0.504 | 187500 | |
| 9 | | 7 | 1.1 | 0.0432 | 3.3 | 0.13 | 13000 | 4/0 | 19 | 2.89 | 0.1055 | 13.4 | 0.528 | 211600 | |
| | | 1 | 2.91 | 0.1144 | 2.91 | 0.114 | 13090 | 120 | 37 | 2.06 | 0.081 | 14.4 | 0.567 | 237.8 kcmil | |
| 8 | | 1 | 3.26 | 0.1285 | 3.25 | 0.128 | 16510 | 250 kcmil | 37 | 2.07 | 0.0822 | 14.6 | 0.575 | 250 kcmil | |
| | | 7 | 1.23 | 0.0486 | 3.7 | 0.146 | 16510 | 300 kcmil | 150 | 37 | 2.29 | 0.09 | 16 | 0.63 | 300 kcmil |
| | 10 | 7 | 1.37 | 0.054 | 4.12 | 0.162 | 19740 | 350 kcmil | 37 | 2.47 | 0.0973 | 17.3 | 0.681 | 350 kcmil | |
| | | 1 | 3.58 | 0.141 | 3.58 | 0.141 | 19740 | 185 | 37 | 2.54 | 0.1 | 17.8 | 0.7 | 365.1 kcmil | |
| 7 | | 7 | 1.38 | 0.0545 | 4.15 | 0.164 | 20520 | 400 kcmil | 37 | 2.64 | 0.104 | 18.5 | 0.728 | 400 kcmil | |
| | | 1 | 3.67 | 0.1443 | 3.67 | 0.144 | 20520 | 240 | 37 | 2.9 | 0.114 | 20.3 | 0.798 | 473.6 kcmil | |
| 6 | | 7 | 1.55 | 0.0612 | 4.66 | 0.184 | 26240 | 500 kcmil | 61 | 2.26 | 0.089 | 20.3 | 0.801 | 473.6 kcmil | |
| | | 1 | 4.11 | 0.162 | 4.11 | 0.162 | 26240 | | 37 | 2.95 | 0.1162 | 20.7 | 0.813 | 500 kcmil | |
| | 16 | 7 | 1.73 | 0.008 | 5.13 | 0.204 | 31580 | | 61 | 2.3 | 0.0905 | 20.7 | 0.814 | 500 kcmil | |
| 5 | | 7 | 1.75 | 0.0688 | 5.24 | 0.206 | 33090 | 300 kcmil | 61 | 2.51 | 0.099 | 22.6 | 0.891 | 592.1 kcmil | |
| 4 | | 7 | 1.96 | 0.0772 | 5.88 | 0.232 | 41740 | 600 kcmil | 61 | 2.52 | 0.0992 | 22.7 | 0.893 | 600 kcmil | |
| | 25 | 7 | 2.16 | 0.085 | 6.48 | 0.255 | 49340 | 700 kcmil | 61 | 2.72 | 0.1071 | 24.5 | 0.964 | 700 kcmil | |
| | | 19 | 1.32 | 0.052 | 6.6 | 0.26 | 49340 | 750 kcmil | 61 | 2.82 | 0.1109 | 25.4 | 0.998 | 750 kcmil | |
| 3 | | 7 | 2.2 | 0.0867 | 6.61 | 0.26 | 52620 | | 91 | 2.31 | 0.0908 | 25.4 | 0.998 | 750 kcmil | |
| 2 | | 7 | 2.47 | 0.0974 | 7.42 | 0.292 | 66300 | | 400 | 61 | 2.9 | 0.114 | 26.1 | 1.026 | 798.4 kcmil |
| | 35 | 7 | 2.54 | 0.1 | 7.62 | 0.300 | 69070 | 800 kcmil | 61 | 2.91 | 0.1145 | 26.2 | 1.031 | 800 kcmil | |
| | | 19 | 1.55 | 0.001 | 7.75 | 0.305 | 69070 | | 91 | 2.38 | 0.0938 | 26.2 | 1.032 | 800 kcmil | |
| 1 | | 19 | 1.5 | 0.0064 | 8.43 | 0.332 | 83690 | 1000 kcmil | 500 | 61 | 3.25 | 0.128 | 28.3 | 1.152 | 986.8 kcmil |
| | 50 | 19 | 1.85 | 0.073 | 9.27 | 0.365 | 98680 | | 91 | 2.66 | 0.1048 | 29.3 | 1.153 | 1000 kcmil | |
| 1/0 | | 19 | 1.59 | 0.0745 | 9.46 | 0.373 | 10500 | | 625 | 91 | 2.97 | 0.117 | 32.7 | 1.287 | 1233.7 kcmil |
| 2/0 | | 19 | 2.13 | 0.0837 | 10.6 | 0.419 | 133100 | | | | | | | | |
| | 70 | 19 | 2.18 | 0.086 | 10.9 | 0.43 | 138100 | | | | | | | | |
| | | 19 | 2.59 | 0.094 | 11.9 | 0.47 | 167800 | | | | | | | | |
| 3/0 | | 36 | 1.71 | 0.0673 | 12 | 0.471 | 167800 | | | | | | | | |

A.
System
Overview

B1.
Cable Ties

B2.
Cable
Accessories

B3.
Stainless
Steel Ties

C1.
Wiring
Duct

C2.
Surface
Raceway

C3.
Abrasion
Protection

C4.
Cable
Management

D1.
Terminals

D2.
Power
Connectors

D3.
Grounding
Connectors

E1.
Labeling
Systems

E2.
Labels

E3.
Pre-Printed
& Write-On
Markers

E4.
Permanent
Identification

E5.
Lockout/
Tagout/
& Safety
Solutions

F.
Index











A. System Overview

Stud Size Chart (Inches/Millimeters)

B1. Cable Ties

B2. Cable Accessories

B3. Stainless Steel Ties





| | | | | | | | | | | |
|--|---|---|---|---|---|---|--|---|---|---|
| |  |  |  |  |  |  |  |  |  |  |
| Standard Stud Size | #2 | #4 | #5 | #6 | #8 | #10 | 1/4" | 5/16" | 3/8" | 7/16" |
| Stud Size Decimal Equivalent | .086" | .112" | .127" | .138" | .164" | .190" | .250" | .312" | .375" | .438" |
| Terminal Hole Diameter | .090" | .118" | .130" | .147" | .173" | .204" | .270" | .343" | .392** .406*** | .456" |
| Stud Size Designation in PANDUIT Part Number | 2 | 4 | 5 | 6 | 8 | 10 | 14 | 56 | 38 | 76 |

C1. Wiring Duct

C2. Surface Raceway

C3. Abrasion Protection

C4. Cable Management

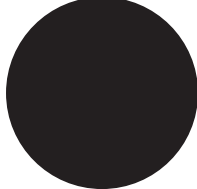
| | | | | | |
|--|---|---|---|--|---|
| |  |  |  |  |  |
| Standard Stud Size | 1/2" | 5/8" | 3/4" | 7/8" | 1" |
| Stud Size Decimal Equivalent | .500" | .625" | .750" | .875" | 1.00" |
| Terminal Hole Diameter | .531" | .656" | .810" | .906" | 1.031" |
| Stud Size Designation in PANDUIT Part Number | 12 | 58 | 34 | 78 | 1 |

D1. Terminals

D2. Power Connectors

D3. Grounding Connectors

*Terminal stud.
**Power Connector stud.

Equivalent Tables Decimal/Inches/Millimeters

E1. Labeling Systems























































































E2. Labels

E3. Pre-Printed & Write-On Markers

E4. Permanent Identification

E5. Lockout/Tagout & Safety Solutions

F. Index

| | | | | | | | | | | | | | | | |
|---|---|-------|-------|---|---|-------|--------|---|---|-------|--------|---|---|-------|--------|
|  |  | .0156 | 0,396 |  |  | .2656 | 6,746 |  |  | .5156 | 13,100 |  |  | .7656 | 19,446 |
|  |  | .0312 | 0,792 |  |  | .2812 | 7,143 |  |  | .5312 | 13,492 |  |  | .7812 | 14,842 |
|  |  | .0468 | 1,189 |  |  | .2968 | 7,541 |  |  | .5468 | 13,891 |  |  | .7968 | 20,241 |
|  |  | .0625 | 1,588 |  |  | .3125 | 7,938 |  |  | .5625 | 14,288 |  |  | .8125 | 20,637 |
|  |  | .0781 | 1,984 |  |  | .3281 | 8,337 |  |  | .5781 | 14,684 |  |  | .8281 | 21,034 |
|  |  | .0937 | 2,380 |  |  | .3437 | 8,730 |  |  | .5937 | 15,080 |  |  | .8437 | 21,480 |
|  |  | .1093 | 2,779 |  |  | .3593 | 9,129 |  |  | .6093 | 15,479 |  |  | .8593 | 21,828 |
| |  | .125 | 3,175 |  |  | .375 | 9,525 |  |  | .625 | 15,875 |  |  | .875 | 22,225 |
| | | .1406 | 3,571 |  |  | .3906 | 9,921 | |  | .6406 | 16,271 | |  | .8906 | 22,620 |
| | | .1562 | 3,968 |  |  | .4062 | 10,317 | |  | .6562 | 16,667 | |  | .9062 | 23,017 |
| | | .1718 | 4,366 |  |  | .4218 | 10,716 | |  | .6718 | 17,066 | |  | .9218 | 23,416 |
| | | .1875 | 4,763 |  |  | .4375 | 11,113 | |  | .6875 | 17,463 | |  | .9375 | 23,810 |
| | | .2031 | 5,159 |  |  | .4531 | 11,509 | |  | .7031 | 17,859 | |  | .9531 | 24,208 |
| | | .2187 | 5,555 |  |  | .4687 | 11,905 | |  | .7187 | 18,255 | |  | .9687 | 24,605 |
| | | .2343 | 5,954 | | | .4843 | 12,304 | | | .7343 | 18,654 | | | .9843 | 25,001 |
| | | .25 | 6,350 | | | .5 | 12,700 | | | .75 | 19,050 | | | 1. | 25,400 |

STRUCTUREDGROUND™ GROUNDING CONNECTORS

PANDUIT® STRUCTUREDGROUND™ Grounding Connectors provide innovative solutions for joining ground conductors to water pipe, ground rods, rebar, conduit, iron pipe and structural steel. Designed with the needs of the end user in mind, STRUCTUREDGROUND™ Grounding Connectors feature easy installation, lowest installed cost, and long-term reliability.



- Functional product information is marked directly on the connector, facilitating the identification, ordering, and usage of the grounding connector
- Compression connectors are color-coded to facilitate quick identification of the proper crimping die
- Mechanical connectors are designed for easy installation – no special tools required
- Incorporate wide wire range-taking capability to minimize inventory requirements
- Made from high strength, high conductivity electrolytic copper and aluminum alloy materials to provide optimum connectivity for both power and grounding applications
- Wide assortment of manual, controlled cycle, battery operated hydraulic and pneumatic crimping tools for reliable connections at the lowest installed cost

PANDUIT® STRUCTUREDGROUND™ Grounding Connectors are designed for use with many different code and flex conductor types and are available in a broad range of styles and sizes. A full line of manual, controlled cycle, and battery operated hydraulic crimping tools meet application needs and provide lowest installed cost. PANDUIT offers a wide variety of STRUCTUREDGROUND™ Grounding Connectors to meet customer needs and today's application requirements.

A.
System
Overview

B1.
Cable
Ties

B2.
Cable
Accessories

B3.
Stainless
Steel Ties

C1.
Wiring
Duct

C2.
Surface
Raceway

C3.
Abrasion
Protection

C4.
Cable
Management

D1.
Terminals

D2.
Power
Connectors

D3.
Grounding
Connectors

E1.
Labeling
Systems

E2.
Labels

E3.
Pre-Printed
& Write-On
Markers

E4.
Permanent
Identification

E5.
Lockout/
Tagout
& Safety
Solutions

F.
Index

A. System Overview

Features and Benefits – STRUCTUREDGROUND™ Compression Connectors

B1. Cable Ties

Bolded features are unique to PANDUIT.

B2. Cable Accessories

B3. Stainless Steel Ties

C1. Wiring Duct

C2. Surface Raceway

C3. Abrasion Protection

C4. Cable Management

D1. Terminals

D2. Power Connectors

D3. Grounding Connectors

E1. Labeling Systems

E2. Labels

E3. Pre-Printed & Write-On Markers

E4. Permanent Identification

E5. Lockout/Tagout & Safety Solutions

F. Index

Copper HTAPs

Easy-to-read, color-coded die index number for PANDUIT crimping dies, legible after crimping, for selection

Conductor sizes for each tap pocket marked on part

Part number and agency listings marked on part for easy identification

Slotted design to reduce installation time when used with PANDUIT cable ties (included)

Made from high conductivity copper and electro tin-plated to inhibit corrosion



Clear Covers for Copper HTAPs

Optically clear to allow 360° inspections

Made from high impact strength self-extinguishing plastic with UL94V-0 flammability rating and minimum oxygen index of 28

Built-in flanges retain HTAP in cover
Easy to assemble snap-on design

Molded in flash barriers protect against electrical flash over



Retainer clips to hold labels inside cover*. Retainer clips have a write-on surface for manual marking

Corresponding PANDUIT HTAP part number, voltage rating, and temperature rating molded into cover half for easy identification

Low profile design minimizes space requirements

Flexible fingers closely conform to conductor preventing foreign objects from entering cover

*Labels shown printed with PANDUIT® PANTHER™ LS8E Printer. See page E1.8.

Thin Wall Copper CTAPs

Part number and conductor size marked on part for easy identification

Color-coded for proper crimp die selection

Ribbed design provides high strength

Made from high conductivity wrought copper



Heavy Duty Copper CTAPs

Easy-to-read die index number for selection

Made from heavy wall, extruded, high conductivity copper; provides high strength and premium electrical properties

Part number and conductor size marked on part for easy identification



Access Floor Grounding Clamp



Each part accommodates a wide range of copper conductor sizes – minimizes inventory

Made from high strength cast bronze

Hinged U-bolt bonds to the pedestal with a single bolt to simplify installation

Quad bolt bonds perpendicular MCBN conductors

Bonds to both square and round access floor pedestals



Service Entrance Grounding Roadmap

- Complies with J-STD-607-A and IEEE Std 1100 (IEEE Emerald Book)
- Grounding Equalizer (GE) is required when two or more Telecommunications Bonding Backbones (TBB) are used within a multi-story building; bond TBBs together with a GE at the top floor and at a minimum of every third floor in between

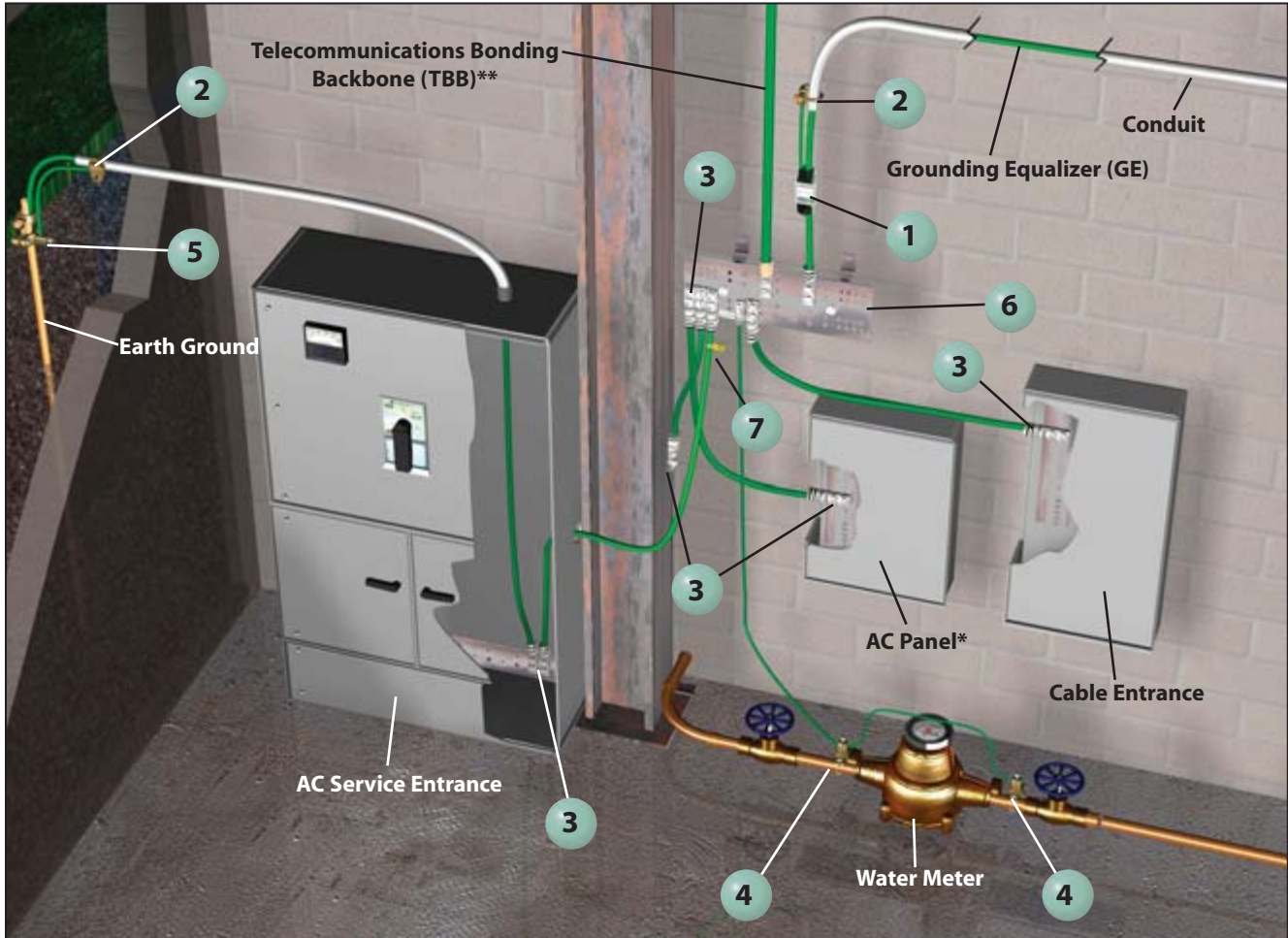

A. System Overview

B1. Cable Ties

B2. Cable Accessories

B3. Stainless Steel Ties

C1. Wiring Duct

C2. Surface Raceway

C3. Abrasion Protection

C4. Cable Management

D1. Terminals

D2. Power Connectors

D3. Grounding Connectors

E1. Labeling Systems









E2. Labels

E3. Pre-Printed & Write-On Markers

E4. Permanent Identification

E5. Lockout/Tagout & Safety Solutions

F. Index

| | |
|--|--|
| <p>1 Copper Compression HTAP and Clear Cover: HTWC (see pages D3.8 and D3.9)</p>  | <p>5 Bronze, Grounding Rod Clamp: WB (see page D3.25) connected by a cable to 2 (U-Bolt Grounding Clamp)</p>  |
| <p>2 Bronze, U-Bolt Grounding Clamp: GPL (see page D3.22) connected by a cable to 1 (HTAP)</p>  | <p>6 Telecommunications Main Grounding Busbar (TMGB) and Busbar Label (see page D3.5)</p>   |
| <p>3 Copper Compression, Two-Hole, Long Barrel with Window Lug: LCC-W (see pages D2.47 – D2.49)</p>  | <p>7 Telecommunications Grounding and Bonding Conductor Label Kit: LTYK (see page D3.5)</p>  |
| <p>4 Bronze, Water Pipe Grounding Clamp: KP (see page D3.23)</p>  | |

*AC Panel should be grounded per NEC standards. Enclosure should be grounded per manufacturer's specifications.

**Specification J-STD-607-A specifies different size conductors based on the length of the Telecommunications Bonding Backbone (TBB).

A. System Overview



Access Floor Grounding Clamp

Type GPQC

- Bonds mesh common bonding network (MCBN) conductors to each other and bonds the access floor pedestals to the conductors
- Made with stainless steel hardware to eliminate zinc whiskers which can dislodge and enter equipment, causing shorts
- Specifically designed to bond perpendicular MCBN conductors per TIA-942

- Bonds to the pedestal with a single bolt to simplify installation
- Accommodates conductors from #6 – 1/0 AWG, minimizes inventory requirements
- Bonds round and square access floor pedestals for greater flexibility

B1. Cable Ties

B2. Cable Accessories

B3. Stainless Steel Ties

C1. Wiring Duct

C2. Surface Raceway

C3. Abrasion Protection

C4. Cable Management

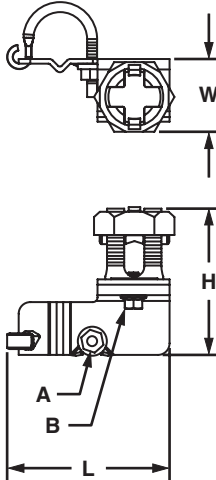
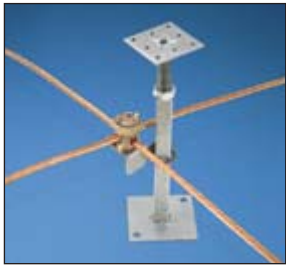

D1. Terminals

D2. Power Connectors

D3. Grounding Connectors

E1. Labeling Systems

E2. Labels

E3. Pre-Printed & Write-On Markers

E4. Permanent Identification

E5. Lockout/Tagout & Safety Solutions

F. Index

| Part Number | Round Pedestal In. (mm) | Square Pedestal In. (mm) | MCBN Conductor Size Range AWG (mm²) | Figure Dimensions In. (mm) | | | | | Tightening Torque In.-Lbs. (Nm) | | Std. Pkg. Qty. | Std. Ctn. Qty. |
|----------------|----------------------------|--------------------------|-------------------------------------|----------------------------|----------------|----------------|----------------|--------------|---------------------------------|---------------|----------------|----------------|
| | | | | L | W | H | A | B | Conductor | Clamp | | |
| GPQC1/0 | 3/4 – 7/8 (19.1 – 22.2) | 3/4 – 1 (19.1 – 25.4) | #6 – 1/0 (16 – 50) | 3.50 (88.9) | 1.75 (44.5) | 3.50 (88.9) | 7/16 (11.1) | 3/8 (9.5) | 385 (43.5) | 150 (17.0) | 1 | 10 |

cUL^{us} BICSI/J-STD-607-A Telecommunications Grounding Busbars

Type GB

- Meets BICSI and J-STD-607-A requirements for network systems grounding applications
- Made of high conductivity copper and tin-plated to inhibit corrosion
- Comes pre-assembled with brackets and insulators attached for quick installation
- Use *PANDUIT* self-laminating laser/ink jet labels to identify busbars to meet TIA/EIA-606-A, see chart below



TGB



TMGB

| Part Number | Bar Size | No. of Mounting Positions | | Std. Pkg. Qty. |
|---|-----------------|---------------------------------------|-------------------------------------|----------------|
| | | 1/4" Stud Hole with 5/8" Hole Spacing | 3/8" Stud Hole with 1" Hole Spacing | |
| Telecommunications Grounding Busbars (TGB) | | | | |
| GB2B0304TPI-1 | 1/4" x 2" x 10" | 4 | 3 | 1 |
| GB2B0306TPI-1 | 1/4" x 2" x 12" | 6 | 3 | 1 |
| GB2B0312TPI-1 | 1/4" x 2" x 20" | 12 | 3 | 1 |

| Telecommunications Main Grounding Busbars (TMGB) | | | | |
|---|-----------------|----|---|---|
| GB4B0612TPI-1 | 1/4" x 4" x 12" | 12 | 6 | 1 |
| GB4B0624TPI-1 | 1/4" x 4" x 20" | 24 | 6 | 1 |

For additional label sizes, materials, and print technologies and to see the complete line of *PANDUIT* identification products, see pages E1.2 – E3.12.

Component Labels for BICSI/J-STD-607-A Telecommunications Grounding Busbars



| Suggested Label Solutions for TIA/EIA-606-A Compliance | | | | |
|--|-------------------------------------|--|---------------------------------------|-------------------------------------|
| Telecommunications Grounding Busbar Part Number | Laser/Ink Jet Desktop Printer Label | TDP43MY Thermal Transfer Desktop Printer Label | PANTHER™ LS8E Hand-Held Printer Label | COUGAR™ LS9 Hand-Held Printer Label |
| All GB2B and GB4B Parts | C200X100FJJ | C200X100YPT | C200X100FJC | T100X000VPC-BK |

For complete labeling solutions and product information, reference charts on pages E1.1 – E2.30.

Telecommunications Grounding and Bonding Conductor Label Kit

- Meets labeling requirements of J-STD-607-A; each telecommunications grounding and bonding conductor shall be labeled as close as practicable to its point of termination in a readable position
- Can be applied as a wrap-around marker (parallel to cable) or flag marker (45° or 90°) to cable
- Kit includes everything needed to properly label cables; ten flame retardant cable ties and ten rigid plastic yellow tags printed with "IF THIS CONNECTOR OR CABLE IS LOOSE OR MUST BE REMOVED, PLEASE CALL THE BUILDING TELECOMMUNICATIONS MANAGER."



| Part Number | Part Description | Std. Pkg. Qty. |
|-------------|---|----------------|
| LTYK | Label kit includes ten printed tags and ten flame retardant cable ties. | 1 |

- A. System Overview
- B1. Cable Ties
- B2. Cable Accessories
- B3. Stainless Steel Ties
- C1. Wiring Duct
- C2. Surface Raceway
- C3. Abrasion Protection
- C4. Cable Management
- D1. Terminals
- D2. Power Connectors
- D3. Grounding Connectors
- E1. Labeling Systems
- E2. Labels
- E3. Pre-Printed & Write-On Markers
- E4. Permanent Identification
- E5. Lockout/Tagout & Safety Solutions
- F. Index

A. System Overview

UL US **CSA CERTIFIED** **Code Conductor, Thin Wall, CTAP**

B1. Cable Ties

For Copper Code Stranded Connections

Type CTAPF

- For copper-to-copper tapping, splicing, or pigtailling
- Wide wire range-taking capability minimizes inventory requirements
- Color-coded for proper crimp die selection
- Ribbed design provides high strength

- Made from high conductivity wrought copper
- UL Listed and CSA Certified to 600 V and temperature rated to 90°C when crimped with *PANDUIT* and specified competitor crimping tools and dies[^]

B2. Cable Accessories

B3. Stainless Steel Ties

C1. Wiring Duct

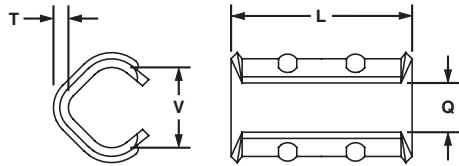

C2. Surface Raceway

C3. Abrasion Protection

C4. Cable Management

D1. Terminals

D2. Power Connectors

D3. Grounding Connectors

| Part Number | Copper Conductor Size | | Number of Ribs | Figure Dimensions In. (mm) | | | | PANDUIT Color Code | Wire Strip Length In. (mm) | Std. Pkg. Qty. |
|----------------------|----------------------------|----------------------------|----------------|----------------------------|-----------|------------|------------|--------------------|----------------------------|----------------|
| | AWG Run (mm ²) | AWG Tap (mm ²) | | L | T | V | Q | | | |
| CTAPF10-16-C* | #14 AWG (2.5) | #16 – #14 AWG (1.5 – 2.5) | 0 | .41 (10.4) | .06 (1.5) | .19 (4.8) | .13 (3.3) | Red | 1/2 (12.7) | 100 |
| | #12 AWG (4.0) | #16 – #12 AWG (1.5 – 4.0) | | | | | | | | |
| | #10 AWG (6.0) | #14 AWG (2.5) | | | | | | | | |
| CTAPF8-12-C | #10 AWG (6.0) | #10 AWG (6.0) | 0 | .67 (17.0) | .07 (1.8) | .26 (6.6) | .19 (4.8) | Blue | 11/16 (17.5) | 100 |
| | #8 AWG (10.0) | #12 AWG (4.0) | | | | | | | | |
| CTAPF6-12-C | #8 AWG (10.0) | #10 – #8 AWG (6.0 – 10.0) | 0 | .67 (17.0) | .07 (1.8) | .32 (8.1) | .24 (6.1) | Gray | 11/16 (17.5) | 100 |
| | #6 AWG (16.0) | #12 – #10 AWG (4.0 – 6.0) | | | | | | | | |
| CTAPF4-12-C | #6 AWG (16) | #8 – #6 AWG (10 – 16) | 1 | 1.25 (31.8) | .07 (1.8) | .40 (10.2) | .28 (7.1) | Brown | 1 5/16 (33.3) | 100 |
| | #5, #4 AWG (16, 25) | #12 – #8 AWG (4 – 10) | | | | | | | | |
| CTAPF3-12-C | #5, #4 AWG (16, 25) | #6 – #5 AWG (16) | 1 | 1.25 (31.8) | .08 (2.0) | .46 (11.7) | .31 (7.9) | Green | 1 5/16 (33.3) | 100 |
| | #3 AWG (25) | #12 – #6 AWG (4 – 16) | | | | | | | | |
| CTAPF2-12-C | #4 AWG (25) | #4 AWG (25) | 1 | 1.25 (31.8) | .08 (2.0) | .51 (13.0) | .33 (8.4) | Pink | 1 5/16 (33.3) | 100 |
| | #3 AWG (25) | #5 AWG (16) | | | | | | | | |
| | #2 AWG (35) | #12 – #6 AWG (4 – 16) | | | | | | | | |
| CTAPF1-12-C | #3 AWG (25) | #4 – #3 AWG (25) | 2 | 1.82 (46.2) | .08 (2.0) | .57 (14.5) | .40 (10.2) | Black | 1 7/8 (47.6) | 100 |
| | #2 AWG (35) | #5 – #4 AWG (16 – 25) | | | | | | | | |
| | #1 AWG (35) | #12 – #5 AWG (4 – 16) | | | | | | | | |
| CTAPF1/0-12-L | #2 AWG (35) | #4 – #2 AWG (25 – 35) | 2 | 1.82 (46.2) | .09 (2.3) | .63 (16.0) | .42 (10.7) | Orange | 1 7/8 (47.6) | 50 |
| | #1 AWG (35) | #4 – #3 AWG (25) | | | | | | | | |
| | 1/0 AWG (50) | #12 – #4 AWG (4 – 25) | | | | | | | | |
| CTAPF2/0-12-Q | #1 AWG (35) | #2 – #1 AWG (35) | 2 | 1.82 (46.2) | .09 (2.3) | .71 (18.0) | .48 (12.2) | Purple | 1 7/8 (47.6) | 25 |
| | 1/0 AWG (50) | #3 – #2 AWG (25 – 35) | | | | | | | | |
| | 2/0 AWG (70) | #12 – #3 AWG (4 – 35) | | | | | | | | |
| CTAPF3/0-12-Q | 1/0 AWG (50) | #1 – 1/0 AWG (50) | 2 | 1.82 (46.2) | .09 (2.3) | .81 (20.6) | .55 (14.0) | Yellow | 1 7/8 (47.6) | 25 |
| | 2/0 AWG (70) | #2 – #1 AWG (35) | | | | | | | | |
| | 3/0 AWG (95) | #12 – #2 AWG (4 – 35) | | | | | | | | |

See pages D3.88 and D3.89 for tool and die information.
 *CTAPF10-16-C available with square, not flared ends.
 All parts available in tin-plated; add TP before packaging code – example: CTAPF6-12TP-C.
[^]Note: CTAPF parts are UL Listed and CSA Certified with AWG wire only.

UL LISTED Code Conductor, Heavy Duty, CTAP

For Use with Solid and Stranded Copper Code Conductors

Type CTAP

- For tapping into unbroken continuous main, as a wire joint or two-way splice
- Wide wire range-taking capability minimizes inventory requirements
- Made from heavy wall, extruded, high conductivity copper; provides high strength and premium electrical properties

- UL Listed per UL 467 for use up to 35 KV** and temperature rated 90°C when crimped with *PANDUIT* and specified competitor crimping tools and dies
- UL Listed for grounding and bonding suitable for direct burial in earth or concrete when crimped with *PANDUIT* and specified competitor crimping tools and dies[^]

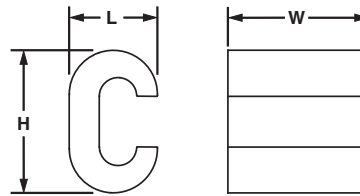

| Part Number | Copper Conductor Size | | Figure Dimensions In. (mm) | | | PANDUIT Die Index No.‡ | Burdny Die Index No.‡ | Wire Strip Length In. (mm) | Tap Cover* | Std. Pkg. Qty. |
|---------------|---|--|----------------------------|----------------|----------------|------------------------|-----------------------|----------------------------|---------------|----------------|
| | AWG Run (mm²) | AWG Tap (mm²) | L | W | H | | | | | |
| CTAP4-8-L | #6 – #4 AWG SOL or STR 16 SOL or STR | #8 AWG SOL or STR 10 SOL or STR | .46 (11.7) | .63 (16.0) | .73 (18.5) | PBG | BG | 3/4 (19) | TAPC2-2/0-X | 50 |
| CTAP4-6-L | #6 AWG STR, #4 AWG SOL or STR 16 SOL or STR | #6 AWG SOL or STR 95 STR | .48 (12.2) | .63 (16.0) | .76 (19.3) | PBG | BG | 3/4 (19) | TAPC2-2/0-X | 50 |
| CTAP4-4-L | #4 AWG SOL or STR 16 SOL or STR | #4 AWG STR 16 STR | .46 (11.7) | .63 (16.0) | .81 (20.6) | PBG | BG | 3/4 (19) | TAPC2-2/0-X | 50 |
| CTAP2-4-Q | #2 AWG SOL or STR 35 SOL or STR | #8 – #4 AWG SOL or STR 10 – 16 SOL or STR | .60 (15.2) | .76 (19.3) | .96 (24.4) | PC | C | 7/8 (22) | TAPC2-2/0-X | 25 |
| CTAP2-2-X | #2 AWG SOL or STR 35 SOL or STR | #2 AWG SOL or STR 25 SOL or STR | .60 (15.2) | .75 (19.0) | 1.05 (26.7) | PC | C | 7/8 (22) | TAPC2-2/0-X | 10 |
| CTAP2/0-2-X | 1/0 – 2/0 AWG STR 70 STR | #8 – #2 AWG SOL or STR 10 – 25 SOL or STR | .80 (20.3) | .93 (23.6) | 1.32 (33.5) | PO | O | 1 1/16 (27) | TAPC2-2/0-X | 10 |
| CTAP2/0-2/0-X | 1/0 – 2/0 AWG STR 70 STR | 1/0 – 2/0 AWG STR 50 STR | .80 (20.3) | .93 (23.6) | 1.37 (34.8) | PO | O | 1 1/16 (27) | TAPC2-2/0-X | 10 |
| CTAP4/0-2-X | 3/0 – 4/0 AWG STR 95 STR | #6 – #2 AWG SOL or STR 16 – 35 SOL or STR | .94 (23.9) | 1.08 (27.4) | 1.66 (42.2) | PD3 | F | 1 1/4 (32) | TAPC3/0-4/0-5 | 10 |
| CTAP4/0-2/0-X | 3/0 – 4/0 AWG STR 95 STR | 1/0 – 2/0 AWG STR 50 – 70 STR | 1.00 (25.4) | 1.08 (27.3) | 1.57 (39.9) | PD3 | F | 1 1/4 (32) | TAPC3/0-4/0-5 | 10 |
| CTAP4/0-4/0-X | 3/0 – 4/0 AWG STR 95 STR | 3/0 – 4/0 AWG STR 95 STR | 1.00 (25.4) | 1.08 (27.4) | 1.57 (39.9) | PD3 | F | 1 1/4 (32) | TAPC3/0-4/0-5 | 10 |

‡See page D3.90 for tool and die information.

*See page D3.8 for type TAPC CTAP covers.

**Consult cable manufacturer for voltage stress relief instructions with applications greater than 2000 V.

[^]Note: CTAP parts are UL Listed and CSA Certified with AWG wire only.

A. System Overview

B1. Cable Ties

B2. Cable Accessories

B3. Stainless Steel Ties

C1. Wiring Duct

C2. Surface Raceway

C3. Abrasion Protection

C4. Cable Management

D1. Terminals

D2. Power Connectors

D3. Grounding Connectors

E1. Labeling Systems

E2. Labels

E3. Pre-Printed & Write-On Markers

E4. Permanent Identification

E5. Lockout/Tagout & Safety Solutions

F. Index

A. System Overview



Clear Covers for HTCT HTAPs

B1. Cable Ties

For Use with PANDUIT HTCT HTAPs

Type CLRCVR

B2. Cable Accessories

- Made of high impact plastic to provide high impact strength and 360° inspections of crimped connection to assure the crimp is complete and the correct die was used
- Incorporate dual self-latching spring loaded latches and supplied with two *PANDUIT* UL 94V-0 cable ties to allow for easy snap-on assembly and ensure covers are secured
- Low profile design minimizes space requirements
- Each cover half supports installation information labels inside plastic retainer strips to allow labels to be viewed on either side of cover and to protect labels from being removed

- Incorporate molded in flash barriers which encompass the HTAP installation providing protection against electrical flash over
- UL 94V-0 flame rating and oxygen index of 28 providing self-extinguishing, flame retardant properties
- Part number, voltage rating, temperature rating and HTCT part number molded into cover for easy identification
- See page D3.29 for detailed installation instructions

B3. Stainless Steel Ties

C1. Wiring Duct

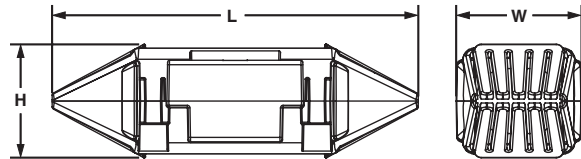

C2. Surface Raceway

C3. Abrasion Protection

C4. Cable Management

| Part Number | Use with HTAP Part Number | Figure Dimensions In. (mm) | | | Std. Pkg. Qty. |
|-------------|---|----------------------------|-----------------|----------------|----------------|
| | | L | W | H | |
| CLRCVR1-1 | HTCT8-8, HTCT6-6 | 4.48 (113.8) | 1.41 (35.8) | 1.20 (30.5) | 1 |
| CLRCVR2-1 | HTCT2-2 | 5.10 (129.5) | 1.66 (42.2) | 1.40 (35.6) | 1 |
| CLRCVR3-1 | HTCT250-8, HTCT250-2, HTCT250-250 | 5.35 (135.9) | 2.16 (54.9) | 1.40 (35.6) | 1 |
| CLRCVR5-1 | HTCT500-250, HTCT500-500 | 7.50 (190.5) | 3.10 (78.7) | 1.90 (48.3) | 1 |
| CLRCVR6-1 | HTCT750-4/0, HTCT750-750, HTCT1000-250, HTCT1000-1000 | 8.50 (215.9) | 4.13 (104.9) | 2.40 (61) | 1 |

D1. Terminals

D2. Power Connectors

D3. Grounding Connectors

Black Covers for Copper CTAPs and Aluminum HTAPs

Protect CTAP or HTAP connection from environment and act as insulation

Type TAPC

E1. Labeling Systems

- Used to insulate connectors and protect tap connections from corrosive environments
- Made of durable, weather-resistant black polypropylene

- Double locking latches provide secure cover installation
- Flexible molded fingers at end of covers conform to conductor and prevent foreign objects from contacting connector

E2. Labels

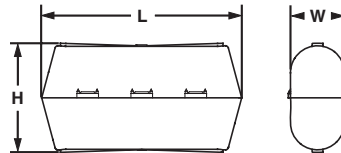

E3. Pre-Printed & Write-On Markers

E4. Permanent Identification

| Part Number | Use with CTAP Part Number | Use with HTAP Part Number | Figure Dimensions In. (mm) | | | Std. Pkg. Qty. |
|---------------|--|--|----------------------------|----------------|----------------|----------------|
| | | | L | W | H | |
| TAPC2-2/0-X | CTAP 4-6, CTAP 4-4, CTAP 2-4, CTAP 2-2 | HTAP 1-1, HTAP 1/0-1, HTAP 2-8, HTAP 2/0-1 | 4.62 (117.4) | 1.60 (40.6) | 2.22 (56.4) | 10 |
| TAPC3/0-4/0-5 | CTAP 4/0-4/0 | HTAP 3/0-1, HTAP 3/0-3/0, HTAP 4/0-2, HTAP 4/0-3/0, HTAP 4/0-4/0 | 5.65 (143.5) | 1.72 (43.7) | 2.38 (60.5) | 5 |
| TAPC500-2 | — | HTAP 500-4/0, HTAP 500-500 | 6.81 (173.0) | 2.86 (72.6) | 2.38 (60.5) | 2 |

E5. Lockout/Tagout & Safety Solutions

F. Index

For information on copper CTAPs, see page D3.7.
For information on aluminum HTAPs, see page D2.122.

UL LISTED **CSA CERTIFIED** **Code/Flex Conductor HTAP**

For Making Parallel and Multiple Tap Connections on Code and Flex Conductors

Type HTCT

- Used to tap into continuous conductors as a splice or pigtailling
- Each HTAP terminates a wide range of conductor sizes and combinations of code and flex conductors Class G, H, I and Diesel Locomotive to suit a variety of applications
- Slotted design allows quick and easy assembly of conductor to HTAP using three *PANDUIT* 94V-0 cable ties included
- Tap grooves are separated from one another allowing them to function independently so HTAP can be used with a single or multiple taps providing maximum design and installation flexibility
- Color-coded and marked with *PANDUIT* die index numbers for proper crimp die selection
- UL Listed and CSA Certified for applications up to 600 V when crimped with *PANDUIT* and specified competitor crimping tools and *PANDUIT* crimping dies[†]
- Tin-plated to inhibit corrosion
- See page D3.29 for detailed installation instructions

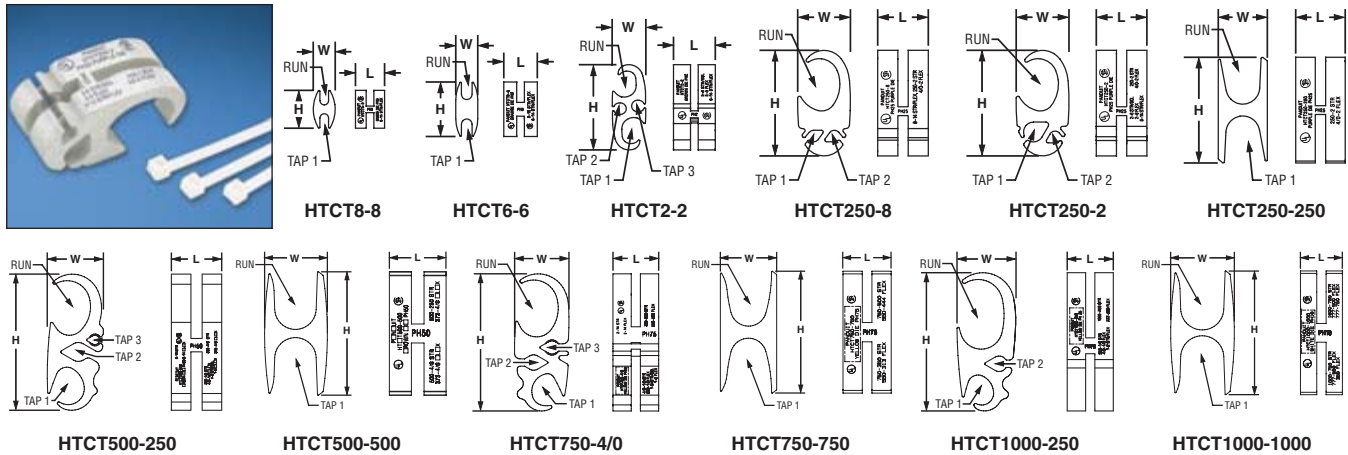

| Part Number | Wire Strand Type | Copper Conductor Size Range AWG (mm ²) | | | | Figure Dimensions In. (mm) | | | PANDUIT Die Color and Die No.‡ | Wire Strip Length In. (mm) | Std. Pkg. Qty. |
|---------------|------------------|--|-------------------------------|------------------------|------------------------|----------------------------|------------|-------------|--------------------------------|----------------------------|----------------|
| | | Run | Tap 1 | Tap 2 | Tap 3 | L | W | H | | | |
| HTCT8-8-1 | Code | #8 – #14 AWG (6 – 2.5) | #8 – #14 AWG (6 – 2.5) | — | — | .53 (13.5) | .40 (10.2) | .69 (17.5) | Green PH8 | 19/32 (15) | 1 |
| | Flex | #8 – #14 AWG (6 – 2.5) | #8 – #14 AWG (6 – 2.5) | — | — | | | | | | |
| HTCT6-6-1 | Code | #6 – #10 AWG (10 – 6) | #6 – #14 AWG (10 – 2.5) | — | — | .61 (15.5) | .40 (10.2) | .99 (25.1) | Orange PH6 | 11/16 (18) | 1 |
| | Flex | #6 – #10 AWG (10 – 6) | #6 – #14 AWG (10 – 2.5) | — | — | | | | | | |
| HTCT2-2-1 | Code | #2 – #6 AWG STR/SOL (25 – 16) | #2 – #6 AWG STR/SOL (25 – 16) | #8 – #14 AWG (6 – 2.5) | #8 – #14 AWG (6 – 2.5) | .76 (19.3) | .61 (15.5) | 1.55 (39.4) | Brown PH2 | 13/16 (21) | 1 |
| | Flex | #2 – #8 AWG (25 – 10) | #2 – #8 AWG (25 – 10) | #8 – #14 AWG (6 – 2.5) | #8 – #14 AWG (6 – 2.5) | | | | | | |
| HTCT250-8-1 | Code | 250 kcmil – #2 AWG (120 – 35) | #8 – #14 AWG (6 – 2.5) | #8 – #14 AWG (6 – 2.5) | — | .92 (23.4) | .96 (24.4) | 1.92 (48.8) | Purple PH25 | 1 (25) | 1 |
| | Flex | 4/0 – #2 AWG (90 – 35) | #8 – #14 AWG (6 – 2.5) | #8 – #14 AWG (6 – 2.5) | — | | | | | | |
| HTCT250-2-1 | Code | 250 kcmil – #2 AWG (120 – 35) | #2 – #6 AWG STR/SOL (25 – 16) | #8 – #14 AWG (6 – 2.5) | — | .92 (23.4) | .96 (24.4) | 1.92 (48.8) | Purple PH25 | 1 (25) | 1 |
| | Flex | 4/0 – #2 AWG (95 – 35) | #2 – #8 AWG (25 – 10) | #8 – #14 AWG (6 – 2.5) | — | | | | | | |
| HTCT250-250-1 | Code | 250 kcmil – #2 AWG (120 – 35) | 250 kcmil – #2 AWG (120 – 35) | — | — | .90 (22.9) | .89 (22.6) | 1.92 (48.8) | Purple PH25 | 1 (25) | 1 |
| | Flex | 4/0 – #2 AWG (95 – 35) | 4/0 – #2 AWG (95° 35) | — | — | | | | | | |

‡See page D3.87 for tool and die information.

^Note: HTCT parts are UL Listed and CSA Certified with AWG wire only.

Table continues on page D3.10

A. System Overview

B1. Cable Ties

B2. Cable Accessories

B3. Stainless Steel Ties

C1. Wiring Duct

C2. Surface Raceway

C3. Abrasion Protection

C4. Cable Management

D1. Terminals

D2. Power Connectors

D3. Grounding Connectors

E1. Labeling Systems

E2. Labels

E3. Pre-Printed & Write-On Markers

E4. Permanent Identification

E5. Lockout/Tagout & Safety Solutions

F. Index

A. System Overview

B1. Cable Ties

B2. Cable Accessories

B3. Stainless Steel Ties

C1. Wiring Duct

C2. Surface Raceway

C3. Abrasion Protection

C4. Cable Management

D1. Terminals

D2. Power Connectors

D3. Grounding Connectors

E1. Labeling Systems

E2. Labels

E3. Pre-Printed & Write-On Markers

E4. Permanent Identification

E5. Lockout/Tagout & Safety Solutions

F. Index

  **Code/Flex Conductor HTAP (continued)**

| Part Number | Wire Strand Type | Copper Conductor Size Range | | | | Figure Dimensions In. (mm) | | | PANDUIT Die Color and Die No.‡ | Wire Strip Length In. (mm) | Std. Pkg. Qty. |
|-----------------|------------------|---------------------------------|---------------------------------|--|-------------------------|-------------------------------|-------------|-------------|--------------------------------|----------------------------|----------------|
| | | Run | Tap 1 | Tap 2 | Tap 3 | L | W | H | | | |
| HTCT500-250-1 | Code | 500 kcmil – 4/0 AWG (240 – 120) | 250 kcmil – 1/0 AWG (120 – 70) | #1 – #6 AWG STR/SOL (35 – 16 STR or SOL) | #8 – #14 AWG — | 1.12 (28.4) | 1.25 (31.8) | 3.03 (77.0) | Brown PH50 | 1 1/4 (32) | 1 |
| | Flex | 373 kcmil – 4/0 AWG (185 – 120) | 4/0 – 1/0 AWG (95 – 70) | #1 – #8 AWG (35 – 10) | #8 – #14 AWG — | | | | | | |
| HTCT500-500-1 | Code | 500 – 250 kcmil (240 – 150) | 500 kcmil – 4/0 AWG (240 – 120) | — | — | 1.12 (28.4) | 1.24 (31.5) | 2.44 (62.0) | Brown PH50 | 1 1/4 (32) | 1 |
| | Flex | 373 kcmil – 4/0 AWG (185 – 120) | 373 kcmil – 4/0 AWG (185 – 120) | — | — | | | | | | |
| HTCT750-4/0-1 | Code | 750 – 350 kcmil (300 – 185) | 4/0 – 1/0 AWG (95 – 70) | #1 – #6 AWGSTR/SOL (35 – 16 STR or SOL) | #2 – #14 AWG (25 – 2.5) | 1.25 (31.8) | 1.49 (37.8) | 3.75 (95.3) | Yellow PH75 | 1 3/8 (35) | 1 |
| | Flex | 550 – 500 kcmil (300) | 250 kcmil – 1/0 AWG (120 – 70) | #1 – #8 AWG (35 – 10) | #2 – #14 AWG (25 – 2.5) | | | | | | |
| HTCT750-750-1 | Code | 750 – 500 kcmil (300) | 750 – 350 kcmil (300 – 185) | — | — | 1.25 (31.8) | 1.46 (37.1) | 3.16 (80.3) | Yellow PH75 | 1 3/8 (35) | 1 |
| | Flex | 550 – 444 kcmil (240) | 550 – 313 kcmil (240 – 185) | — | — | | | | | | |
| HTCT1000-250-1 | Code | 1000 – 750 kcmil (500 – 400) | 250 kcmil – 1/0 AWG (120 – 70) | #1 – #2 AWG (35) | — | 1.25 (31.8) | 1.59 (40.4) | 3.75 (95.3) | Yellow PH75 | 1 3/8 (35) | 1 |
| | Flex | 777 – 500 kcmil (400 – 300) | 4/0 – 1/0 AWG (95 – 70) | #1 – #2 AWG (35) | — | | | | | | |
| HTCT1000-1000-1 | Code | 1000 – 750 kcmil (500 – 400) | 1000 – 750 kcmil (500 – 400) | — | — | 1.12 (28.4) | 1.70 (43.2) | 3.30 (83.8) | White PH10 | 1 1/4 (32) | 1 |
| | Flex | 777 – 500 kcmil (400) | 777 – 500 kcmil (185) | — | — | | | | | | |
| | | 777 – 750 kcmil (400) | 350 kcmil (185) | — | — | | | | | | |

‡See page D3.87 for tool and die information.
 ^Note: HTCT parts are UL Listed and CSA Certified with AWG wire only.

UL LISTED **CSA CERTIFIED** **Code/Flex Conductor HTAP Kit**

Type HTWC

- Include all components to make a complete HTAP and cover installation: HTCT HTAP, matching CLRCVR clear cover, and cable ties
- Each HTCT HTAP designed to terminate a wide range of copper code and flex conductor combinations to accommodate a variety of applications
- HTAPs incorporate a unique slotted design that allows for quick and easy installation using supplied *PANDUIT* cable ties; saves time and cost

- Matching clear covers are made from high impact plastic and provide high impact strength and 360° viewing of installed HTAP
- Clear covers have a UL 94V-0 flame rating and an oxygen index of 28 providing self-extinguishing, flame retardant properties
- UL Listed and CSA Certified for applications up to 600 V when crimped with *PANDUIT* and specified competitor crimping tools and *PANDUIT* crimping dies
- See page D3.29 for detailed installation instructions

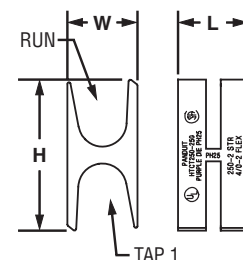
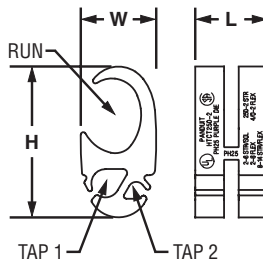
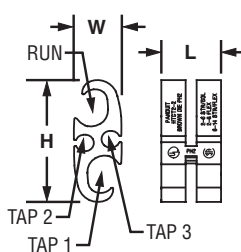
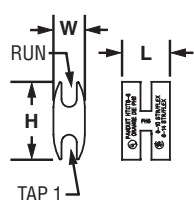

| Part Number | Components | | Wire Strand Type | Copper Conductor Size Range AWG (mm ²) | | | | Std. Pkg. Qty. |
|---------------|---------------|----------------------|------------------|--|-------------------------------|------------------------|------------------------|----------------|
| | HTAP Part No. | Clear Cover Part No. | | Run | Tap 1 | Tap 2 | Tap 3 | |
| HTWC8-8-1 | HTCT8-8-1 | CLRCVR1-1 | Code | #8 – #14 AWG (6 – 2.5) | #8 – #14 AWG (6 – 2.5) | — | — | 1 |
| | | | Flex | #8 – #14 AWG (6 – 2.5) | #8 – #14 AWG (6 – 2.5) | (6 – 2.5) | — | |
| HTWC6-6-1 | HTCT6-6-1 | CLRCVR1-1 | Code | #6 – #10 AWG (10 – 6) | #6 – #14 AWG (10 – 2.5) | — | — | 1 |
| | | | Flex | #6 – #10 AWG (10 – 6) | #6 – #14 AWG (10 – 2.5) | (10 – 2.5) | (6 – 2.5) | |
| HTWC2-2-1 | HTCT2-2-1 | CLRCVR2-1 | Code | #2 – #6 AWG STR/SOL (25 – 16) | #2 – #6 AWG STR/SOL (25 – 16) | #8 – #14 AWG (6 – 2.5) | #8 – #14 AWG (6 – 2.5) | 1 |
| | | | Flex | #2 – #8 AWG (25 – 10) | #2 – #8 AWG (25 – 10) | #8 – #14 AWG (25 – 10) | #8 – #14 AWG (6 – 2.5) | |
| HTWC250-8-1 | HTCT250-8-1 | CLRCVR3-1 | Code | 250 kcmil – #2 AWG (120 – 35) | #8 – #14 AWG (6 – 2.5) | #8 – #14 AWG (6 – 2.5) | — | 1 |
| | | | Flex | 4/0 – #2 AWG (90 – 35) | #8 – #14 AWG (6 – 2.5) | #8 – #14 AWG (6 – 2.5) | — | |
| HTWC250-2-1 | HTCT250-2-1 | CLRCVR3-1 | Code | 250 kcmil – #2 AWG (120 – 35) | #2 – #6 AWG STR/SOL (25 – 16) | #8 – #14 AWG (6 – 2.5) | — | 1 |
| | | | Flex | 4/0 – #2 AWG (95 – 35) | #2 – #8 AWG (25 – 10) | #8 – #14 AWG (25 – 10) | — | |
| HTWC250-250-1 | HTCT250-250-1 | CLRCVR3-1 | Code | 250 kcmil – #2 AWG (120 – 35) | 250 kcmil – #2 AWG (120 – 35) | — | — | 1 |
| | | | Flex | 4/0 – #2 AWG (95 – 35) | 4/0 – #2 AWG (95 – 35) | (95 – 35) | — | |

See pages D3.8 – D3.10 for more information on HTAPs and clear covers, including tap sizes and locations.
 Note: HTCT parts are UL Listed and CSA Certified with AWG wire only.

Table continues on page D3.12

A. System Overview

B1. Cable Ties

B2. Cable Accessories

B3. Stainless Steel Ties

C1. Wiring Duct

C2. Surface Raceway

C3. Abrasion Protection

C4. Cable Management

D1. Terminals

D2. Power Connectors

D3. Grounding Connectors

E1. Labeling Systems

E2. Labels

E3. Pre-Printed & Write-On Markers

E4. Permanent Identification

E5. Lockout/Tagout & Safety Solutions

F. Index

A.
System
Overview

B1.
Cable Ties



Code/Flex Conductor HTAP Kit (continued)

B2.
Cable
Accessories

B3.
Stainless
Steel Ties

C1.
Wiring
Duct

C2.
Surface
Raceway

C3.
Abrasion
Protection

C4.
Cable
Management

D1.
Terminals

D2.
Power
Connectors

D3.
Grounding
Connectors

E1.
Labeling
Systems

E2.
Labels

E3.
Pre-Printed
& Write-On
Markers

E4.
Permanent
Identification





E5.
Lockout/
Tagout/
& Safety
Solutions

F.
Index

| Part Number | Components | | Wire Strand Type | Copper Conductor Size Range AWG (mm ²) | | | | Std. Pkg. Qty. |
|-----------------|-----------------|----------------------|------------------|--|---------------------------------|--|-------------------------|----------------|
| | HTAP Part No. | Clear Cover Part No. | | Run | Tap 1 | Tap 2 | Tap 3 | |
| HTWC500-250-1 | HTCT500-250-1 | CLRCVR5-1 | Code | 500 kcmil – 4/0 AWG (240 – 120) | 250 kcmil – 1/0 AWG (120 – 70) | #1 – #6 AWG SOL (35 – 16 STR or SOL) | #8 – #14 AWG (6 – 2.5) | 1 |
| | | | Flex | 373 kcmil – 4/0 AWG (185 – 120) | 4/0 – 1/0 AWG (95 – 70) | #1 – #8 AWG (95 – 70) | #8 – #14 AWG (6 – 2.5) | |
| HTWC500-500-1 | HTCT500-500-1 | CLRCVR5-1 | Code | 500 – 250 kcmil (240 – 150) | 500 kcmil – 4/0 AWG (240 – 120) | — | — | 1 |
| | | | Flex | 373 kcmil – 4/0 AWG (185 – 120) | 373 kcmil – 4/0 AWG (185 – 120) | (185 – 120) | — | |
| HTWC750-4/0-1 | HTCT750-4/0-1 | CLRCVR6-1 | Code | 750 – 350 kcmil (300 – 185) | 4/0 – 1/0 AWG (95 – 70) | #1 – #6 AWG STR/SOL (35 – 16 STR or SOL) | #2 – #14 AWG (25 – 2.5) | 1 |
| | | | Flex | 550 – 500 kcmil (300) | 250 kcmil – 1/0 AWG (120 – 70) | #1 – #8 AWG (120 – 70) | #2 – #14 AWG (25 – 2.5) | |
| HTWC750-750-1 | HTCT750-750-1 | CLRCVR6-1 | Code | 750 – 500 kcmil (300) | 750 – 350 kcmil (300 – 185) | — | — | 1 |
| | | | Flex | 550 – 444 kcmil (240) | 550 – 313 kcmil (240 – 185) | (240 – 185) | — | |
| HTWC1000-250-1 | HTCT1000-250-1 | CLRCVR6-1 | Code | 1000 – 750 kcmil (500 – 400) | 250 kcmil – 1/0 AWG (120 – 70) | #1 – #2 AWG (35) | — | 1 |
| | | | Flex | 4/0 – 1/0 AWG (95 – 70) | 4/0 – 1/0 AWG (95 – 70) | #1 – #2 AWG (95 – 70) | — | |
| HTWC1000-1000-1 | HTCT1000-1000-1 | CLRCVR6-1 | Code | 1000 – 750 kcmil (500 – 400) | 1000 – 750 kcmil (500 – 400) | — | — | 1 |
| | | | Flex | 777 – 500 kcmil (400) | 777 – 500 kcmil (185) | (185) | — | |
| | | | Flex | 777 – 500 kcmil (400) | 350 kcmil (185) | (185) | — | |

See pages D3.8 – D3.10 for more information on HTAPs and clear covers, including tap sizes and locations.
Note: HTCT parts are UL Listed and CSA Certified with AWG wire only.

Features and Benefits – STRUCTUREDGROUND™ Mechanical Connectors

| | |
|---|---|
| <h3>Bronze Grounding Clamp</h3>  <p>Made from high strength, electrolytic cast bronze</p> <p>Provides two options: attachment of grounding conductor to clamp either parallel or perpendicular to axis of pipe or ground rod</p> <p>Provided with high strength, corrosion resistant silicon bronze hardware</p> <p>Part number, conductor range, rod and pipe size range and "DB" suitable for direct burial marked on part for easy identification</p> <p>UL LISTED</p> | <h3>Bronze Service Post Connector</h3>  <p>Part number, conductor range, and "DB" suitable for direct burial marked on part for easy identification</p> <p>Made from a single piece of hard drawn copper electrolytic rod – provides high strength</p> <p>Provided with high strength, corrosion resistant silicon bronze nut and pressure pad</p> <p>Available in configurations for use with one or two copper conductors with either a standard or long stud length</p> <p>UL LISTED</p> |
| <h3>Bronze Water Pipe Clamp</h3>  <p>Part number, conductor range, water pipe size range and "DB" suitable for direct burial marked on part for easy identification</p> <p>Provided with high strength steel hardware plated to inhibit corrosion</p> <p>Made from high strength, electrolytic cast bronze</p> <p>Each part accommodates a wide range of copper conductor sizes and water pipe sizes – minimizes inventory</p> <p>UL LISTED CSA CERTIFIED</p> | <h3>Bronze Grounding Clamp</h3>  <p>Provided with high strength, corrosion resistant silicon bronze hardware</p> <p>Part number, conductor range, and "DB" suitable for direct burial marked on part for easy identification</p> <p>Made from high strength, electrolytic cast bronze</p> <p>Spacer separates conductor from mounting surface</p> <p>UL LISTED</p> |

Aluminum Lay-In Lug

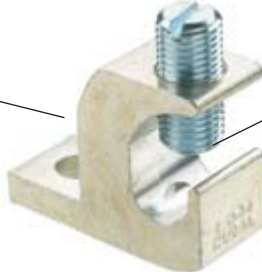

High-density aluminum alloy with tin-plating provides premium electrical and mechanical performance for long-term dependability

Wide wire range-taking supports multiple wires sizes minimizing inventory requirements with minimum parts

UL Listed and CSA Certified for use up to 600 V and UL temperature rated 90°C ensure a high level of safety and reliability

- A. System Overview
- B1. Cable Ties
- B2. Cable Accessories
- B3. Stainless Steel Ties
- C1. Wiring Duct
- C2. Surface Raceway
- C3. Abrasion Protection
- C4. Cable Management
- D1. Terminals
- D2. Power Connectors
- D3. Grounding Connectors
- E1. Labeling Systems
- E2. Labels
- E3. Pre-Printed & Write-On Markers
- E4. Permanent Identification
- E5. Lockout/ Tagout & Safety Solutions
- F. Index



A. System Overview

B1. Cable Ties

B2. Cable Accessories

B3. Stainless Steel Ties

C1. Wiring Duct

C2. Surface Raceway

C3. Abrasion Protection

C4. Cable Management

D1. Terminals

D2. Power Connectors

D3. Grounding Connectors

E1. Labeling Systems

E2. Labels





E3. Pre-Printed & Write-On Markers

E4. Permanent Identification

E5. Lockout/Tagout & Safety Solutions











F. Index

Selection Guide – STRUCTUREDGROUND™ Mechanical Connectors

| UL Listed Direct Burial | Service Post Type | Stud Size (In.) | Thread Length (In.) | Copper Code Conductor Size | | | | | | | | | | | | | | | | |
|---|---|-----------------|---------------------|----------------------------|-------------|-------------|--------|--------|--------|--------|--------|--------|---------|---------|---------|---------|-----------|-----------|-----------|-----------|
| | | | | #12 AWG | #10 AWG | #8 AWG | #7 AWG | #6 AWG | #4 AWG | #3 AWG | #2 AWG | #1 AWG | 1/0 AWG | 2/0 AWG | 3/0 AWG | 4/0 AWG | 250 kcmil | 300 kcmil | 350 kcmil | 400 kcmil |
| PANDUIT Part Number | | | | | | | | | | | | | | | | | | | | |
|  | Bronze Service Post One Conductor SP1 | 1/4-20 | 1/2 | SP1-8-C* | | | | | | | | | | | | | | | | |
| | | | 1 | SP1-8L-C* | | | | | | | | | | | | | | | | |
| | | | 1/2 | | SP1-7-C* | | | | | | | | | | | | | | | |
| | | | 1 | | SP1-7L-C* | | | | | | | | | | | | | | | |
| | | 5/16-18 | 9/16 | SP1-4-C* | | | | | | | | | | | | | | | | |
| | | | 1 | SP1-4L-C* | | | | | | | | | | | | | | | | |
| | | 3/8-16 | 5/8 | | SP1-3-C* | | | | | | | | | | | | | | | |
| | | | 1 1/8 | | SP1-3L-C* | | | | | | | | | | | | | | | |
| | | | 5/8 | | SP1-2-C | | | | | | | | | | | | | | | |
| | | 1/2-13 | 1 1/8 | | SP1-2L-C | | | | | | | | | | | | | | | |
| | | | 3/4 | | SP1-1/0-L* | | | | | | | | | | | | | | | |
| | | 5/8-11 | 1 1/4 | | SP1-1/0L-L* | | | | | | | | | | | | | | | |
| | | | 3/4 | | | SP1-2/0-Q* | | | | | | | | | | | | | | |
| | | 3/4-10 | 1 1/4 | | | SP1-2/0L-Q* | | | | | | | | | | | | | | |
| | | | 1 | | | SP1-4/0-Q* | | | | | | | | | | | | | | |
| | | | 1 1/2 | | | SP1-4/0L-Q* | | | | | | | | | | | | | | |
| | | | 1 | | | SP1-350-12 | | | | | | | | | | | | | | |
| | | 3/4-10 | 1 1/2 | | | SP1-350L-12 | | | | | | | | | | | | | | |
| 1 3/8 | | | | SP1-500-12 | | | | | | | | | | | | | | | | |
| 1 3/4 | | | | SP1-500L-12 | | | | | | | | | | | | | | | | |
| 1 3/4 | | | | SP1-500L-12 | | | | | | | | | | | | | | | | |
|  | Bronze Service Post Two Conductors SP2 | 1/4-20 | 1/2 | SP2-8-C* | | | | | | | | | | | | | | | | |
| | | | 1 | SP2-8L-C* | | | | | | | | | | | | | | | | |
| | | | 1/2 | | SP2-7-C* | | | | | | | | | | | | | | | |
| | | | 1 | | SP2-7L-C* | | | | | | | | | | | | | | | |
| | | 5/16-18 | 9/16 | | SP2-4-C* | | | | | | | | | | | | | | | |
| | | | 1 | | SP2-4L-C* | | | | | | | | | | | | | | | |
| | | 3/8-16 | 5/8 | | SP2-3-C* | | | | | | | | | | | | | | | |
| | | | 1 1/8 | | SP2-3L-C* | | | | | | | | | | | | | | | |
| | | | 5/8 | | SP2-2-C* | | | | | | | | | | | | | | | |
| | | 1/2-13 | 1 1/8 | | SP2-2L-C* | | | | | | | | | | | | | | | |
| | | | 3/4 | | | SP2-1/0-L* | | | | | | | | | | | | | | |
| | | 5/8-11 | 1 1/4 | | SP2-1/0L-L* | | | | | | | | | | | | | | | |
| | | | 3/4 | | | SP2-2/0-Q* | | | | | | | | | | | | | | |
| | | 3/4-10 | 1 1/4 | | | SP2-2/0L-Q* | | | | | | | | | | | | | | |
| | | | 1 | | | SP2-4/0-Q* | | | | | | | | | | | | | | |
| | | | 1 1/2 | | | SP2-4/0L-Q* | | | | | | | | | | | | | | |
| | | | 1 | | | SP2-350-12 | | | | | | | | | | | | | | |
| | | 3/4-10 | 1 1/2 | | | SP2-350L-12 | | | | | | | | | | | | | | |
| 1 3/8 | | | | SP2-500-12 | | | | | | | | | | | | | | | | |
| 1 3/4 | | | | SP2-500L-12 | | | | | | | | | | | | | | | | |
| 1 3/4 | | | | SP2-500L-12 | | | | | | | | | | | | | | | | |
|  | Bronze Service Post One Conductor SPF1 | 1/4-20 | 1/4 | SPF1-8-C* | | | | | | | | | | | | | | | | |
| | | | | SPF1-7-C* | | | | | | | | | | | | | | | | |
| | | 5/16-18 | 5/16 | | SPF1-4-C* | | | | | | | | | | | | | | | |
| | | | 3/8 | | SPF1-3-C | | | | | | | | | | | | | | | |
| | | 1/2-13 | 7/16 | | SPF1-2-C | | | | | | | | | | | | | | | |
| | | | 1/2 | | SPF1-1/0-L* | | | | | | | | | | | | | | | |
| 5/8-11 | 5/8 | | SPF1-2/0-Q* | | | | | | | | | | | | | | | | | |
| | 3/4 | | | SPF1-4/0-Q | | | | | | | | | | | | | | | | |
| 3/4-10 | 3/4 | | | SPF1-350-12 | | | | | | | | | | | | | | | | |
| | 3/4 | | | SPF1-500-12 | | | | | | | | | | | | | | | | |
|  | Bronze Service Post Two Conductors SPF2 | 1/4-20 | 1/4 | SPF2-8-C* | | | | | | | | | | | | | | | | |
| | | | | SPF2-7-C* | | | | | | | | | | | | | | | | |
| | | 5/16-18 | 5/16 | | SPF2-4-C* | | | | | | | | | | | | | | | |
| | | | 3/8 | | SPF2-3-C* | | | | | | | | | | | | | | | |
| | | 1/2-13 | 7/16 | | SPF2-2-C* | | | | | | | | | | | | | | | |
| | | | 1/2 | | | SPF2-1/0-L* | | | | | | | | | | | | | | |
| 5/8-11 | 5/8 | | SPF2-2/0-Q* | | | | | | | | | | | | | | | | | |
| | 3/4 | | | SPF2-4/0-Q* | | | | | | | | | | | | | | | | |
| 3/4-10 | 3/4 | | | SPF2-350-12 | | | | | | | | | | | | | | | | |
| | 3/4 | | | SPF2-500-12 | | | | | | | | | | | | | | | | |

*Denotes minimum conductor size is solid conductor.

Selection Guide – STRUCTUREDGROUND™ Mechanical Connectors (continued)

| UL Listed Direct Burial | Ground Clamp Type | Ground Rod Size (In.) | Pipe Size (In.) | Copper Code Conductor Size | | | | | | | | | | | | | | | | | | | | | |
|---|---------------------------------------|---|---------------------------------------|----------------------------|------------|-----------|--------|----------|--------|-----------|--------|----------|--------|-----------|---------|---------|---------|-----------|-----------|-----------|-----------|-----------|--|--|--|
| | | | | #14 AWG | #12 AWG | #10 AWG | #8 AWG | #7 AWG | #6 AWG | #4 AWG | #3 AWG | #2 AWG | #1 AWG | 1/0 AWG | 2/0 AWG | 3/0 AWG | 4/0 AWG | 250 kcmil | 300 kcmil | 350 kcmil | 400 kcmil | 500 kcmil | | | |
| | | | | PANDUIT Part Number | | | | | | | | | | | | | | | | | | | | | |
|  | One Barrel, One-Hole LI | — | — | LI-50s-C@ #10 stud hole | | | | | | | | | | | | | | | | | | | | | |
| | | | | LI-112S-L@ 1/4" stud hole | | | | | | | | | | | | | | | | | | | | | |
| | | | | LI-252S-Q@ 5/16" stud hole | | | | | | | | | | | | | | | | | | | | | |
|  | Bronze Ground Clamp One Conductor GPL | 5/8 or 3/4 | 3/8 | GPL-4-Q* | | | | GPL-5-Q* | | | | GPL-6-Q* | | | | | | | | | | | | | |
| | | | | 7/8 or 1 | 1/2 or 3/4 | GPL-8-Q* | | | | GPL-9-Q* | | | | GPL-10-Q* | | | | | | | | | | | |
| | | — | 1 | | | GPL-14-X* | | | | GPL-15-X* | | | | GPL-16-X* | | | | | | | | | | | |
| | | | | — | 1 1/4 | GPL-20-X* | | | | GPL-21-X* | | | | GPL-22-X* | | | | | | | | | | | |
| | | — | 1 1/2 | | | GPL-26-X* | | | | GPL-27-X* | | | | GPL-28-X* | | | | | | | | | | | |
| | | | | — | 2 | GPL-32-3* | | | | GPL-33-3* | | | | GPL-34-3* | | | | | | | | | | | |
| | | — | 2 1/2 | | | GPL-39-3* | | | | GPL-40-3* | | | | | | | | | | | | | | | |
| | | | | — | 3 | GPL-44-1* | | | | GPL-45-1* | | | | GPL-46-1* | | | | | | | | | | | |
| | | — | 3 1/2 | | | GPL-51-1* | | | | GPL-52-1* | | | | | | | | | | | | | | | |
| | | | | — | 4 | GPL-57-1* | | | | GPL-58-1* | | | | | | | | | | | | | | | |
| | |  | Bronze Ground Clamp Two Conductors GU | | | — | 1 | GU-2-X*‡ | | | | | | | | | | | | | | | | | |
| | | | | 1 1/4 | GU-4-X*‡ | | | | | | | | | | | | | | | | | | | | |
| | | | | 2 | | | | | | | | | | | | | | | | | GU-13-3‡ | | | | |
|  | Bronze Ground Clamp KP | — | 1/2-#1 | KP1-C*® | | | | | | | | | | | | | | | | | | | | | |
| | | | 1 1/4-#2 | KP2-L*® | | | | | | | | | | | | | | | | | | | | | |
|  | Bronze Ground Clamp KLS | — | 1/2-1 | KLS-0-Q*‡ 1/2" hub size | | | | | | | | | | | | | | | | | | | | | |
| | | | | KLS-1-Q*‡ 3/4" hub size | | | | | | | | | | | | | | | | | | | | | |
| | | | | KLS-1A-X*‡ 1" hub size | | | | | | | | | | | | | | | | | | | | | |
|  | Bronze Ground Clamp KH | — | 1/2-1 | KH-1-L*‡ 1/2" hub size | | | | | | | | | | | | | | | | | | | | | |
| | | | 1 1/4-2 | KH-2-L*‡ 1/2" hub size | | | | | | | | | | | | | | | | | | | | | |
|  | Aluminum Ground Clamp GC | — | 1/2-3/4-1 | GC-15A-Q@DR | | | | | | | | | | | | | | | | | | | | | |
| | | | 1 1/4-1 1/2-2 | GC-18A-X@DR | | | | | | | | | | | | | | | | | | | | | |
| | | | 2 1/2-3-3 1/2-4 | GC-22A-4@DR | | | | | | | | | | | | | | | | | | | | | |
|  | Bronze Ground Rod Clamp WB | — | 1/2 | WB12-L* | | | | | | | | | | | | | | | | | | | | | |
| | | | 5/8 | WB34-X | | | | | | | | | | | | | | | | | | | | | |
| | | | 3/4 | WB34-X | | | | | | | | | | | | | | | | | | | | | |
| | | | 5/8 | WB58-Q | | | | | | | | | | | | | | | | | | | | | |
|  | Bronze Ground Clamp GMS | — | — | GMS-1-X* | | | | | | | | | | | | | | | | | | | | | |
| | | | | GMS-2-Q* | | | | | | | | | | | | | | | | | | | | | |
| | | | | GMS-3-Q* | | | | | | | | | | | | | | | | | | | | | |
|  | Bronze Ground Clamp GM | — | — | GM-2-Q* | | | | | | | | | | | | | | | | | | | | | |
| | | | | GM-3-Q* | | | | | | | | | | | | | | | | | | | | | |

*Denotes minimum conductor size is solid conductor. @Denotes not UL Listed for Direct Burial.

DR Denotes Dual Rated for use with copper or aluminum conductors. ‡Denotes not UL Listed or CSA Certified.

A. System Overview

B1. Cable Ties

B2. Cable Accessories

B3. Stainless Steel Ties

C1. Wiring Duct

C2. Surface Raceway

C3. Abrasion Protection

C4. Cable Management

D1. Terminals

D2. Power Connectors

D3. Grounding Connectors

E1. Labeling Systems

E2. Labels

E3. Pre-Printed & Write-On Markers

E4. Permanent Identification

E5. Lockout/Tagout & Safety Solutions

F. Index

A.
System
Overview

B1.
Cable Ties

B2.
Cable
Accessories

B3.
Stainless
Steel Ties

C1.
Wiring
Duct

C2.
Surface
Raceway

C3.
Abrasion
Protection

C4.
Cable
Management

D1.
Terminals

D2.
Power
Connectors

D3.
Grounding
Connectors

E1.
Labeling
Systems

E2.
Labels

E3.
Pre-Printed
& Write-On
Markers

E4.
Permanent
Identification

E5.
Lockout/
Tagout/
& Safety
Solutions

F.
Index

PANDUIT Grounding Connector Approvals



| Logo (Symbol) | Agency | Spec/Approval | Applicable Products |
|---------------|-----------------------------------|--|---|
| | Underwriters Laboratories, Inc. | UL 486A Wire Connectors and Soldering Lugs for use in US and Canada | CLRCVR, HTCT, CTAPF, CTAP |
| | Underwriters Laboratories, Inc. | UL 486A – 486B Wire Connectors and Soldering Lugs for use in US | LI |
| | Underwriters Laboratories, Inc. | UL 467 Grounding and Bonding Equipment for use in US and Canada | SP1, SP2, SPF1, SPF2, GPL, GMS, GM |
| | Underwriters Laboratories, Inc. | UL 467 Grounding and Bonding Equipment for use in US | GPQC, CTAP, KP, WB |
| | Canadian Standards Association | C22.2 No. 65-03 Wire Connectors | Copper and aluminum compression connectors (except: TAPC and CTAP) |
| | Canadian Standards Association | C22.2 No. 41-M1987 (R1999) Grounding and Bonding Equipment | GPQC, WB, KP |



Service Post Connector, Male Stud, Single Conductor, Bronze

Type SP1

- For grounding one copper code conductor to steel structures, busbars, or transformers or for tapping from busbar with hex nut and washer
- Made from high copper content, hard drawn copper rod provides high strength
- Offered with standard and long stud lengths to accommodate a variety of mounting applications
- Wide wire range-taking capability minimizes inventory requirements
- True hex design for body and nut hex provides correct fit with socket, box, or open end wrenches resulting in proper torquing of electrical connection
- Pressure bar provides secure connection on a full range of conductor combinations used with each connector providing premium wire pull-out strength
- UL Listed for grounding and bonding and suitable for direct burial in earth or concrete

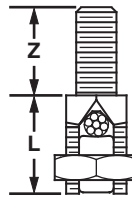

| Part Number | Conductor Size Range | Stud Size* | Figure Dimensions In. (mm) | | Nut Hex (In.) | Body Hex (In.) | Tightening Torque (In.-Lbs.) | Std. Pkg. Qty. |
|-------------|-----------------------|------------|----------------------------|-------------|---------------|----------------|------------------------------|----------------|
| | | | L | Z | | | | |
| SP1-8-C | #12 SOL – #8 STR | 1/4 – 20 | .63 (16.0) | .50 (12.7) | .50 | .38 | 80 | 100 |
| SP1-8L-C | | | .63 (16.0) | 1.00 (25.4) | | | | |
| SP1-7-C | #8 SOL – #7 STR | 1/4 – 20 | .88 (22.4) | .50 (12.7) | .69 | .50 | 165 | 100 |
| SP1-7L-C | | | .88 (22.4) | 1.00 (25.4) | | | | |
| SP1-4-C | #10 SOL – #4 STR | 5/16 – 18 | .94 (23.9) | .56 (14.2) | .75 | .56 | 240 | 100 |
| SP1-4L-C | | | .94 (23.9) | 1.00 (25.4) | | | | |
| SP1-3-C | #6 SOL – #3 STR | 3/8 – 16 | 1.06 (26.9) | .63 (16) | .81 | .63 | 275 | 100 |
| SP1-3L-C | | | 1.06 (26.9) | 1.13 (28.7) | | | | |
| SP1-2-C | #4 STR – #2 STR | 3/8 – 16 | 1.06 (26.9) | .63 (16) | .88 | .69 | 385 | 100 |
| SP1-2L-C | | | 1.06 (26.9) | 1.13 (28.7) | | | | |
| SP1-1/0-L | #6 SOL – 1/0 STR | 1/2 – 13 | 1.31 (33.3) | .75 (19.1) | 1.00 | .75 | 385 | 50 |
| SP1-1/0L-L | | | 1.31 (33.3) | 1.25 (31.8) | | | | |
| SP1-2/0-Q | #1 SOL – 2/0 STR | 1/2 – 13 | 1.44 (36.6) | .75 (19.1) | 1.13 | .88 | 500 | 25 |
| SP1-2/0L-Q | | | 1.44 (36.6) | 1.25 (31.8) | | | | |
| SP1-4/0-Q | 3/0 SOL – 4/0 STR | 5/8 – 11 | 1.69 (42.9) | 1.00 (25.4) | 1.38 | 1.13 | 650 | 25 |
| SP1-4/0L-Q | | | 1.69 (42.9) | 1.50 (38.1) | | | | |
| SP1-350-12 | 4/0 STR – 350 kcmil | 5/8 – 11 | 2.00 (50.8) | 1.00 (25.4) | 1.50 | 1.25 | 650 | 12 |
| SP1-350L-12 | | | 2.00 (50.8) | 1.50 (38.1) | | | | |
| SP1-500-12 | 250 kcmil – 500 kcmil | 3/4 – 10 | 2.31 (58.7) | 1.38 (35.1) | 1.81 | 1.50 | 825 | 12 |
| SP1-500L-12 | | | 2.31 (58.7) | 1.75 (44.5) | | | | |

*UNC threads.

A. System Overview

B1. Cable Ties

B2. Cable Accessories

B3. Stainless Steel Ties

C1. Wiring Duct

C2. Surface Raceway

C3. Abrasion Protection

C4. Cable Management

D1. Terminals

D2. Power Connectors

D3. Grounding Connectors

E1. Labeling Systems

E2. Labels

E3. Pre-Printed & Write-On Markers

E4. Permanent Identification

E5. Lockout/Tagout & Safety Solutions

F. Index

A. System Overview

B1. Cable Ties

B2. Cable Accessories

B3. Stainless Steel Ties

C1. Wiring Duct

C2. Surface Raceway

C3. Abrasion Protection

C4. Cable Management

D1. Terminals

D2. Power Connectors

D3. Grounding Connectors

E1. Labeling Systems

E2. Labels

E3. Pre-Printed & Write-On Markers

E4. Permanent Identification

E5. Lockout/Tagout & Safety Solutions

F. Index

UL LISTED **Service Post Connector, Male Stud, Two Conductor, Bronze**
Type SP2

- For grounding two copper code conductors to steel structures, busbars, or transformers or for tapping from busbar with hex nut and washer
- Made from high copper content, hard drawn copper rod provides high strength
- Offered with standard and long stud lengths to accommodate a variety of mounting applications
- Wide wire range-taking capability minimizes inventory requirements
- True hex design for body and nut hex provides correct fit with socket, box, or open end wrenches resulting in proper torquing of electrical connection
- Pressure bar provides secure connection on a full range of conductor combinations used with each connector providing premium wire pull-out strength
- UL Listed for grounding and bonding and suitable for direct burial in earth or concrete

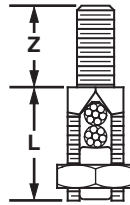

| Part Number | Conductor Size Range | Stud Size* | Figure Dimensions In. (mm) | | Nut Hex (In.) | Body Hex (In.) | Tightening Torque (In.-Lbs.) | Std. Pkg. Qty. |
|--------------------|----------------------|------------|----------------------------|-------------|---------------|----------------|------------------------------|----------------|
| | | | L | Z | | | | |
| SP2-8-C | #12 SOL – #8 STR | 1/4 – 20 | .75 (19.0) | .50 (12.7) | .50 | .38 | 80 | 100 |
| SP2-8L-C | | | .75 (19.0) | 1.00 (25.4) | | | | |
| SP2-7-C | #10 SOL – #7 STR | 1/4 – 20 | 1.00 (25.4) | .50 (12.7) | .69 | .50 | 165 | 100 |
| SP2-7L-C | | | 1.00 (25.4) | 1.00 (25.4) | | | | |
| SP2-4-C | #10 SOL – #4 STR | 5/16 – 18 | 1.16 (29.5) | .56 (14.2) | .75 | .56 | 240 | 100 |
| SP2-4L-C | | | 1.16 (29.5) | 1.00 (25.4) | | | | |
| SP2-3-C | #10 SOL – #3 STR | 3/8 – 16 | 1.09 (27.7) | .63 (16) | .81 | .63 | 275 | 100 |
| SP2-3L-C | | | 1.09 (27.7) | 1.13 (28.7) | | | | |
| SP2-2-C | #10 SOL – #2 STR | 3/8 – 16 | 1.38 (35.1) | .63 (16) | .88 | .69 | 385 | 100 |
| SP2-2L-C | | | 1.28 (32.5) | 1.13 (28.7) | | | | |
| SP2-1/0-L | #2 SOL – 1/0 STR | 1/2 – 13 | 1.69 (42.9) | .75 (19.1) | 1.00 | .75 | 385 | 50 |
| SP2-1/0L-L | | | 1.69 (42.9) | 1.25 (31.8) | | | | |
| SP2-2/0-Q | #2 SOL – 2/0 STR | 1/2 – 13 | 1.88 (47.8) | .75 (19.1) | 1.13 | .88 | 500 | 25 |
| SP2-2/0L-Q | | | 1.88 (47.8) | 1.25 (31.8) | | | | |
| SP2-4/0-Q | #1 SOL – 4/0 STR | 5/8 – 11 | 2.25 (57.2) | 1.00 (25.4) | 1.38 | 1.13 | 650 | 25 |
| SP2-4/0L-Q | | | 2.25 (57.2) | 1.50 (38.1) | | | | |
| SP2-350-12 | #1 STR – 350 kcmil | 5/8 – 11 | 2.69 (68.3) | 1.00 (25.4) | 1.50 | 1.25 | 650 | 12 |
| SP2-350L-12 | | | 2.69 (68.3) | 1.50 (38.1) | | | | |
| SP2-500-12 | 3/0 STR – 500 kcmil | 3/4 – 10 | 3.19 (81.0) | 1.38 (35.1) | 1.81 | 1.50 | 825 | 12 |
| SP2-500L-12 | | | 3.19 (81.0) | 1.75 (44.5) | | | | |

*UNC threads.



Service Post Connector, Female Thread, Single Conductor, Bronze

Type SPF1

- For grounding one copper code conductor to steel structures, busbars, or transformers or for tapping from busbar using external studs, screws, or bolts
- Made from high copper content, hard drawn copper rod provides high strength
- Wide wire range-taking capability minimizes inventory requirements
- True hex design for body and nut hex provides correct fit with socket, box, or open end wrenches resulting in proper torquing of electrical connection
- Pressure bar provides secure connection on a full range of conductor combinations used with each connector providing premium wire pull-out strength
- UL Listed for grounding and bonding and suitable for direct burial in earth or concrete

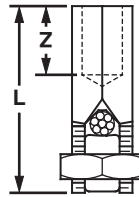

| Part Number | Conductor Size Range | Thread Size* | Figure Dimensions In. (mm) | | Nut Hex (In.) | Body Hex (In.) | Tightening Torque (In.-Lbs.) | Std. Pkg. Qty. |
|-------------|-----------------------|--------------|----------------------------|---------------|---------------|----------------|------------------------------|----------------|
| | | | L | Z | | | | |
| SPF1-8-C | #12 SOL – #8 STR | 1/4 – 20 | .91 (23.1) | .25 (6.4) | .50 | .38 | 80 | 100 |
| SPF1-7-C | #10 SOL – #7 STR | 1/4 – 20 | 1.13 (28.7) | .25 (6.4) | .69 | .50 | 165 | 100 |
| SPF1-4-C | #8 SOL – #4 STR | 5/16 – 18 | 1.44 (36.6) | .31 (7.9) | .75 | .56 | 240 | 100 |
| SPF1-3-C | #6 STR – #3 STR | 3/8 – 16 | 1.50 (38.1) | .38 (9.7) | .81 | .63 | 275 | 100 |
| SPF1-2-C | #6 STR – #2 STR | 3/8 – 16 | 1.63 (41.4) | .38 (9.7) | .88 | .69 | 385 | 100 |
| SPF1-1/0-L | #2 SOL – 1/0 STR | 1/2 – 13 | 1.88 (47.8) | .44 (11.2) | 1.00 | .75 | 385 | 50 |
| SPF1-2/0-Q | #1 SOL – 2/0 STR | 1/2 – 13 | 2.06 (52.3) | .50 (12.7) | 1.13 | .88 | 500 | 25 |
| SPF1-4/0-Q | 1/0 STR – 4/0 STR | 5/8 – 11 | 2.38 (60.5) | .63 (16) | 1.38 | 1.13 | 650 | 25 |
| SPF1-350-12 | 4/0 STR – 350 kcmil | 5/8 – 11 | 2.63 (66.8) | .63 (16) | 1.50 | 1.25 | 650 | 12 |
| SPF1-500-12 | 300 kcmil – 500 kcmil | 3/4 – 10 | 3.13 (79.5) | .75 (19.1) | 1.81 | 1.50 | 825 | 12 |

*UNC threads.

A.
System
Overview

B1.
Cable Ties

B2.
Cable
Accessories

B3.
Stainless
Steel Ties

C1.
Wiring
Duct

C2.
Surface
Raceway

C3.
Abrasion
Protection

C4.
Cable
Management

D1.
Terminals

D2.
Power
Connectors

D3.
Grounding
Connectors

E1.
Labeling
Systems

E2.
Labels

E3.
Pre-Printed
& Write-On
Markers

E4.
Permanent
Identification

E5.
Lockout/
Tagout
& Safety
Solutions

F.
Index

A.
System
Overview

B1.
Cable Ties

B2.
Cable
Accessories

B3.
Stainless
Steel Ties

C1.
Wiring
Duct

C2.
Surface
Raceway

C3.
Abrasion
Protection

C4.
Cable
Management

D1.
Terminals

D2.
Power
Connectors

D3.
Grounding
Connectors

E1.
Labeling
Systems

E2.
Labels

E3.
Pre-Printed
& Write-On
Markers

E4.
Permanent
Identification

E5.
Lockout/
Tagout/
& Safety
Solutions

F.
Index

cUL[®] LISTED Service Post Connector, Female Thread, Two Conductor, Bronze

Type SPF2

- For grounding two copper code conductors to steel structures, busbars, or transformers or for tapping from busbar using external threaded studs, screws, or bolts
- Made from high copper content, hard drawn copper rod provides high strength
- Wide wire range-taking capability minimizes inventory requirements
- True hex design for body and nut hex provides correct fit with socket, box, or open end wrenches resulting in proper torquing of electrical connection
- Pressure bar provides secure connection on a full range of conductor combinations used with each connector providing premium wire pull-out strength
- UL Listed for grounding and bonding and suitable for direct burial in earth or concrete

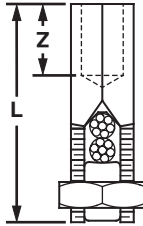

| Part Number | Conductor Size Range | Thread Size* | Figure Dimensions In. (mm) | | Nut Hex (In.) | Body Hex (In.) | Tightening Torque (In.-Lbs.) | Std. Pkg. Qty. |
|--------------------|----------------------|--------------|----------------------------|---------------|---------------|----------------|------------------------------|----------------|
| | | | L | Z | | | | |
| SPF2-8-C | #12 SOL – #8 STR | 1/4 – 20 | 1.13 (1.13) | .25 (6.4) | .50 | .38 | 80 | 100 |
| SPF2-7-C | #10 SOL – #7 STR | 1/4 – 20 | 1.44 (1.44) | .25 (6.4) | .69 | .50 | 165 | 100 |
| SPF2-4-C | #10 SOL – #4 STR | 5/16 – 18 | 1.56 (1.56) | .31 (7.9) | .75 | .56 | 240 | 100 |
| SPF2-3-C | #10 SOL – #3 STR | 3/8 – 16 | 1.63 (1.63) | .38 (9.7) | .81 | .63 | 275 | 100 |
| SPF2-2-C | #10 SOL – #2 STR | 3/8 – 16 | 1.94 (1.94) | .38 (9.7) | .88 | .69 | 385 | 100 |
| SPF2-1/0-L | #2 SOL – 1/0 STR | 1/2 – 13 | 2.13 (2.13) | .44 (11.2) | 1.00 | .75 | 385 | 50 |
| SPF2-2/0-Q | #2 SOL – 2/0 STR | 1/2 – 13 | 2.31 (2.31) | .50 (12.7) | 1.13 | .88 | 500 | 25 |
| SPF2-4/0-Q | #1 SOL – 4/0 STR | 5/8 – 11 | 2.50 (2.50) | .63 (16) | 1.38 | 1.13 | 650 | 25 |
| SPF2-350-12 | #1 STR – 350 kcmil | 5/8 – 11 | 2.69 (2.69) | .63 (16) | 1.50 | 1.25 | 650 | 12 |
| SPF2-500-12 | 3/0 STR – 500 kcmil | 3/4 – 10 | 3.31 (3.31) | .75 (19.1) | 1.81 | 1.50 | 825 | 12 |

*UNC threads.



One-Hole Aluminum Lay-In Lug



Type LI

- Used for quick installation of a continuous grounding conductor
- Made from high strength, extruded aluminum alloy to provide premium electrical and mechanical performance
- Tin-plated to inhibit corrosion
- Wide wire range-taking capability minimizes inventory requirements
- UL Listed and CSA Certified for use up to 600 V and UL temperature rated 90°C

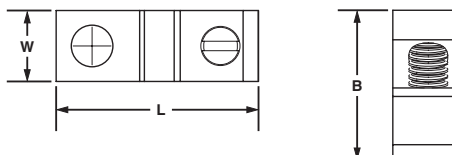

| Part Number | Conductor Size Range | Stud Hole Size In. | Hex Key Size (In.) | Figure Dimensions In. (mm) | | | Tightening Torque (In.-Lbs) | Std. Pkg. Qty. |
|-------------|----------------------|--------------------|--------------------|----------------------------|---------------|----------------|-----------------------------|----------------|
| | | | | L | W | H | | |
| LI-50S-C | #14 – 4 AWG | .22 | ** | 1.07 (27.2) | .38 (9.7) | .78 (19.8) | 275 | 100 |
| LI-112S-L | #14 – 1/0 AWG | .27 | ** | 1.50 (38.1) | .60 (15.2) | 1.17 (19.8) | 275 | 50 |
| LI-252S-Q | #6 AWG – 250 kcmil | .33 | 9/16 | 2.20 (55.9) | .80 (20.3) | 1.79 (45.5) | 275 | 25 |

The use of PANDUIT oxide inhibiting joint compound (CMP) is recommended for pad to pad and conductor connections. See page D3.21.

**Uses slotted head set screw.

Joint Compounds

Type CMP

- Oxide inhibitor for compression conductor connections lowers electrical resistance of compression joint while sealing out air and moisture to prevent the formation of surface oxides
- Wide operating temperature range; can be used in a wide range of electrical and environmental conditions
- Packaged in convenient dispenser bottles



| Part Number | Part Description | Std. Pkg. Qty. |
|-------------|--|----------------|
| CMP-100-1 | Contact aid for pad-to-pad or thread-to-thread aluminum connections, 8 oz. Operating temperature range -60°F (-51°C) to 400°F (204°C). | 1 |
| CMP-200-1 | Contact aid for cable connections with compression connections made on aluminum conductor, 8 oz. Operating temperature range -40°F (-40°C) to 400°F (204°C). Compatible with all insulating materials. | 1 |
| CMP-300-1 | Contact aid for copper-to-copper and copper-to-steel connections, 8 oz. Operating temperature range -40°F (-40°C) to 350°F (177°C). Good for all voltages and suitable for grounding. Also used for anti-seizing thread lubricant. | 1 |
| CMP-300-4-1 | Contact aid for copper-to-copper and copper-to-steel connections, 4 oz. Operating temperature range -40°F (-40°C) to 350°F (177°C). Good for all voltages and suitable for grounding. Also used for anti-seizing thread lubricant. | 1 |

A. System Overview

B1. Cable Ties

B2. Cable Accessories

B3. Stainless Steel Ties

C1. Wiring Duct

C2. Surface Raceway

C3. Abrasion Protection

C4. Cable Management

D1. Terminals

D2. Power Connectors

D3. Grounding Connectors

E1. Labeling Systems

E2. Labels

E3. Pre-Printed & Write-On Markers

E4. Permanent Identification

E5. Lockout/Tagout & Safety Solutions

F. Index

A. System Overview

B1. Cable Ties

B2. Cable Accessories

B3. Stainless Steel Ties

C1. Wiring Duct

C2. Surface Raceway

C3. Abrasion Protection

C4. Cable Management

D1. Terminals

D2. Power Connectors

D3. Grounding Connectors

E1. Labeling Systems

E2. Labels

E3. Pre-Printed & Write-On Markers

E4. Permanent Identification

E5. Lockout/Tagout & Safety Solutions

F. Index

UL LISTED Grounding Clamp, U-Bolt, Bronze

Type GPL

- Used to ground copper conductor parallel or at a right angle to a rod, tube, or pipe
- Made from high strength, electrolytic cast bronze
- High strength silicon bronze hardware provides long term reliable assembly
- Accommodates a wide range of pipe, tube, rod and conductor sizes – minimizes inventory requirements
- UL Listed for grounding and bonding and suitable for direct burial in earth or concrete

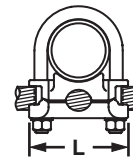
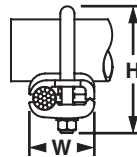

| Part Number | Ground Rod Size (In.) | Iron Pipe Size (In.) | Conductor Size Range | Figure Dimensions In. (mm) | | | Bolt Dia. (In.) | Hex Size (In.) | Tightening Torque (In.-Lbs.) | Std. Pkg. Qty. |
|-----------------|-----------------------|----------------------|----------------------|----------------------------|-------------|--------------|-----------------|----------------|------------------------------|----------------|
| | | | | L | W | H | | | | |
| GPL-4-Q | 5/8 or 3/4 | 3/8 | #8 SOL – #4 STR | 2.00 (50.8) | 1.38 (35.1) | 2.75 (69.9) | 3/8 | 9/16 | 110 | 25 |
| GPL-5-Q | 5/8 or 3/4 | 3/8 | #4 SOL – 2/0 STR | 2.00 (50.8) | 1.63 (41.4) | 2.75 (69.9) | 3/8 | 9/16 | 180 | 25 |
| GPL-6-Q | 5/8 or 3/4 | 3/8 | 2/0 SOL – 250 kcmil | 2.00 (50.8) | 1.88 (47.8) | 2.75 (69.9) | 3/8 | 9/16 | 240 | 25 |
| GPL-8-Q | 7/8 or 1 | 1/2 or 3/4 | #8 SOL – #4 STR | 2.38 (60.5) | 1.38 (35.1) | 2.63 (66.8) | 3/8 | 9/16 | 110 | 25 |
| GPL-9-Q | 7/8 or 1 | 1/2 or 3/4 | #4 SOL – 2/0 STR | 2.38 (60.5) | 1.63 (41.4) | 2.63 (66.8) | 3/8 | 9/16 | 180 | 25 |
| GPL-10-Q | 7/8 or 1 | 1/2 or 3/4 | 2/0 SOL – 250 kcmil | 2.38 (60.5) | 1.88 (47.8) | 3.00 (76.2) | 3/8 | 9/16 | 240 | 25 |
| GPL-14-X | — | 1 | #8 SOL – #4 STR | 2.63 (66.8) | 1.38 (35.1) | 2.75 (69.9) | 3/8 | 9/16 | 110 | 10 |
| GPL-15-X | — | 1 | #4 SOL – 2/0 STR | 2.63 (66.8) | 1.63 (41.4) | 2.75 (69.9) | 3/8 | 9/16 | 180 | 10 |
| GPL-16-X | — | 1 | 2/0 SOL – 250 kcmil | 2.63 (66.8) | 1.88 (47.8) | 3.25 (82) | 3/8 | 9/16 | 180 | 10 |
| GPL-20-X | — | 1 1/4 | #8 SOL – #4 STR | 3.00 (76.2) | 1.38 (35.1) | 3.50 (88.9) | 3/8 | 9/16 | 110 | 10 |
| GPL-21-X | — | 1 1/4 | #4 SOL – 2/0 STR | 3.00 (76.2) | 1.63 (41.4) | 3.50 (88.9) | 3/8 | 9/16 | 180 | 10 |
| GPL-22-X | — | 1 1/4 | 2/0 SOL – 250 kcmil | 3.00 (76.2) | 1.88 (47.8) | 3.50 (88.9) | 3/8 | 9/16 | 240 | 10 |
| GPL-26-X | — | 1 1/2 | #8 SOL – #4 STR | 3.25 (82.6) | 1.38 (35.1) | 4.00 (101.6) | 3/8 | 9/16 | 110 | 10 |
| GPL-27-X | — | 1 1/2 | #4 SOL – 2/0 STR | 3.25 (82.6) | 1.63 (41.4) | 4.00 (101.6) | 3/8 | 9/16 | 180 | 10 |
| GPL-28-X | — | 1 1/2 | 2/0 SOL – 250 kcmil | 3.25 (82.6) | 1.88 (47.8) | 4.00 (101.6) | 3/8 | 9/16 | 240 | 10 |
| GPL-32-3 | — | 2 | #8 SOL – #4 STR | 3.75 (95.3) | 1.38 (35.1) | 4.25 (107.9) | 3/8 | 9/16 | 110 | 3 |
| GPL-33-3 | — | 2 | #4 SOL – 2/0 STR | 3.75 (95.3) | 1.63 (41.4) | 4.25 (107.9) | 3/8 | 9/16 | 180 | 3 |
| GPL-34-3 | — | 2 | 2/0 SOL – 250 kcmil | 3.75 (95.3) | 1.88 (47.8) | 4.25 (107.9) | 3/8 | 9/16 | 240 | 3 |
| GPL-39-3 | — | 2 1/2 | #4 SOL – 2/0 STR | 4.25 (107.9) | 1.63 (41.4) | 5.00 (127) | 3/8 | 9/16 | 180 | 3 |
| GPL-40-3 | — | 2 1/2 | 2/0 SOL – 250 kcmil | 4.25 (107.9) | 1.88 (47.8) | 5.00 (127) | 3/8 | 9/16 | 240 | 3 |
| GPL-44-1 | — | 3 | #8 SOL – #4 STR | 4.75 (120.6) | 1.38 (35.1) | 5.50 (140) | 3/8 | 9/16 | 180 | 1 |
| GPL-45-1 | — | 3 | #4 SOL – 2/0 STR | 4.75 (120.6) | 1.63 (41.4) | 5.50 (139.7) | 3/8 | 9/16 | 180 | 1 |
| GPL-46-1 | — | 3 | 2/0 SOL – 250 kcmil | 4.75 (120.6) | 1.88 (47.8) | 5.50 (139.7) | 3/8 | 9/16 | 240 | 1 |
| GPL-51-1 | — | 3 1/2 | #4 SOL – 2/0 STR | 5.25 (133.4) | 1.63 (41.4) | 6.25 (158.8) | 3/8 | 9/16 | 180 | 1 |
| GPL-52-1 | — | 3 1/2 | 2/0 SOL – 250 kcmil | 5.25 (133.4) | 1.88 (47.8) | 6.25 (158) | 3/8 | 9/16 | 180 | 1 |
| GPL-57-1 | — | 4 | #4 SOL – 2/0 STR | 5.75 (146.0) | 1.63 (41.4) | 6.38 (162.1) | 3/8 | 9/16 | 180 | 1 |
| GPL-58-1 | — | 4 | 2/0 SOL – 250 kcmil | 5.75 (146.0) | 1.88 (47.8) | 6.38 (162.1) | 3/8 | 9/16 | 240 | 1 |

Grounding Clamp, U-Bolt, for Two Cables, Bronze

Type GU

- Used to ground two copper code conductors parallel to a rod, tube, or pipe
- Made from high strength, electrolytic cast bronze
- High strength silicon bronze hardware provides long term reliable assembly
- Accommodates a wide range of pipe, tube, rod and conductor sizes – minimizes inventory requirements

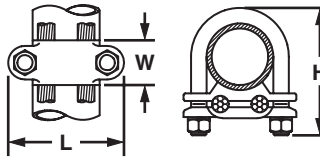

| Part Number | Iron Pipe Size (In.) | Conductor Size Range | Figure Dimensions In. (mm) | | | Bolt Dia. (In.) | Hex Size (In.) | Tightening Torque (In.-Lbs.) | Std. Pkg. Qty. |
|-------------|----------------------|----------------------|----------------------------|-------------|--------------|-----------------|----------------|------------------------------|----------------|
| | | | L | W | H | | | | |
| GU-2-X | 1 | #4 SOL – 2/0 STR | 2.75 (70.0) | 1.13 (28.6) | 3.25 (82.6) | 3/8 | 9/16 | 240 | 10 |
| GU-4-X | 1 1/4 | #8 SOL – #4 STR | 3.00 (76.2) | 1.13 (28.6) | 3.25 (82.6) | 3/8 | 9/16 | 240 | 10 |
| GU-13-3 | 2 | 300 – 500 kcmil | 4.00 (102.0) | 1.50 (38.1) | 4.63 (118.0) | 1/2 | 3/4 | 480 | 3 |



Grounding Clamp for Water Pipes, Bronze

Type KP

- Used to ground copper code conductor to water pipe or copper tube
- Cast from high strength, electrolytic bronze to provide reliable grounding connections
- Plated steel screws provide high strength and inhibit corrosion
- Accommodates a wide range of pipe, tube, rod and conductor sizes – minimizes inventory requirements
- UL Listed for grounding and bonding and suitable for direct burial in earth or concrete

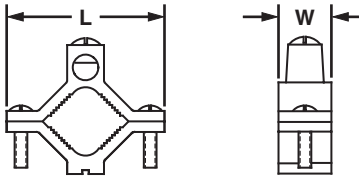

| Part Number | Water Pipe Range (In.) | Conductor Size Range | Figure Dimensions In. (mm) | | Tightening Torque (In.-Lbs.) | | Std. Pkg. Qty. |
|-------------|------------------------|----------------------|----------------------------|------------|------------------------------|-------|----------------|
| | | | L | W | Conductor | Clamp | |
| KP1-C | 1/2 – 1 | #10 SOL – #2 STR | 2.28 (57.9) | .66 (16.8) | 50 | 50 | 100 |
| KP2-L | 1 1/4 – 2 | #10 SOL – #2 STR | 3.58 (90.9) | .73 (18.5) | 50 | 50 | 50 |

A. System Overview

B1. Cable Ties

B2. Cable Accessories

B3. Stainless Steel Ties

C1. Wiring Duct

C2. Surface Raceway

C3. Abrasion Protection

C4. Cable Management

D1. Terminals

D2. Power Connectors

D3. Grounding Connectors

E1. Labeling Systems

E2. Labels

E3. Pre-Printed & Write-On Markers

E4. Permanent Identification

E5. Lockout/Tagout & Safety Solutions

F. Index

A. System Overview

Grounding Clamp for Water Pipe with Copper Strap, Bronze

B1. Cable Ties

Type KLS

- Used to ground copper code conductor to rigid conduit systems
- Cast from high strength, electrolytic bronze to provide reliable grounding connections
- Plated steel screws provide high strength and inhibit corrosion
- Pure copper contact strip included to isolate conduit system from water pipe vibrations
- High strength bronze conduit hub also included to provide durable connection of conduit to copper strap
- Accommodates a wide range of pipe, tube, and conductor sizes – minimizes inventory requirements

B2. Cable Accessories

B3. Stainless Steel Ties

C1. Wiring Duct

C2. Surface Raceway

C3. Abrasion Protection

C4. Cable Management

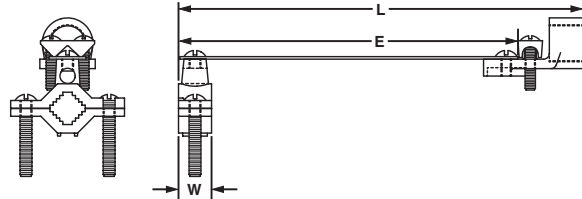

| Part Number | Conduit Hub Size | Water Pipe Range (In.) | Conductor Size Range | Figure Dimensions In. (mm) | | | Tightening Torque (In.-Lbs.) | | Std. Pkg. Qty. |
|-----------------|------------------|------------------------|----------------------|----------------------------|-------------|---------------|------------------------------|-------|----------------|
| | | | | L | W | E | Conductor | Clamp | |
| KLS-0-Q | 1/2 | 1/2 – 1 | #10 SOL – 2/0 STR | 8.22 (58.7) | .66 (16.8) | 6 7/8 (174.8) | 50 | 50 | 25 |
| KLS-1-Q | 3/4 | 1/2 – 1 | #10 SOL – 2/0 STR | 8.22 (58.7) | .66 (16.80) | 6 7/8 (174.8) | 50 | 50 | 25 |
| KLS-1A-X | 1 | 1/2 – 1 | #10 SOL – 2/0 STR | 8.38 (58.7) | .66 (16.8) | 6 7/8 (174.8) | 50 | 50 | 10 |

D1. Terminals

Grounding Clamp for Conduit, Bronze

D2. Power Connectors

Type KH

- Used to ground copper code conductor to rigid conduit systems
- Cast from high strength, electrolytic bronze to provide reliable grounding connections
- Plated steel screws provide high strength and inhibit corrosion
- Includes high strength bronze conduit hub to ensure a durable connection of conduit to copper strap
- Accommodates a wide range of pipe, tube, and conductor sizes – minimizes inventory requirements

D3. Grounding Connectors

E1. Labeling Systems

E2. Labels

E3. Pre-Printed & Write-On Markers

E4. Permanent Identification

E5. Lockout/Tagout & Safety Solutions

F. Index

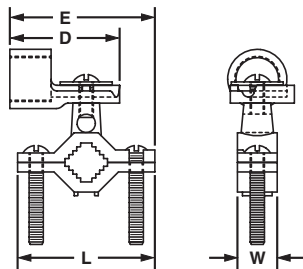

| Part Number | Conduit Hub Size | Water Pipe Range (In.) | Conductor Size Range | Figure Dimensions In. (mm) | | | | Tightening Torque (In.-Lbs.) | | Std. Pkg. Qty. |
|---------------|------------------|------------------------|----------------------|----------------------------|------------|-------------|-----------|------------------------------|-------|----------------|
| | | | | L | W | E | D | Conductor | Clamp | |
| KH-1-L | 1/2 | 1/2 – 1 | #10 SOL – #4 STR | 2.31 (58.7) | .66 (16.8) | 2.54 (64.5) | 1.85 (47) | 50 | 50 | 50 |
| KH-2-L | 1/2 | 1 1/4 – 2 | #10 SOL – #4 STR | 3.60 (91.4) | .79 (20.1) | 3.02 (76.7) | 1.85 (47) | 50 | 50 | 50 |

UL LISTED **Grounding Clamp for Water Pipes, Aluminum**

Type GC

- Dual-rated for grounding aluminum or copper code conductors to copper water pipe, galvanized pipe, or steel conduit
- Made from high strength, extruded aluminum alloy to provide long term durability
- Tin-plated to inhibit corrosion and oxidation and for low contact resistance
- Plated steel screws provide high strength and inhibit corrosion
- Accommodates a wide range of pipe, tube, and conductor sizes – minimizes inventory requirements
- UL Listed for grounding and bonding

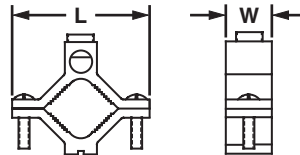

| Part Number | Conduit Pipe or Water Tube Size | Conductor Size Range | Figure Dimensions In. (mm) | | Tightening Torque (In.-Lbs.) | | Std. Pkg. Qty. |
|-------------|---------------------------------|----------------------|----------------------------|-------------|------------------------------|-------|----------------|
| | | | L | W | Conductor | Clamp | |
| GC-15A-Q | 1/2 – 3/4 – 1 | #14 – 1/0 AWG | 2.25 (57.2) | .69 (17.5) | 50 | 50 | 25 |
| GC-18A-X | 1 1/4 – 1, 1/2 – 2 | #6 AWG – 250 kcmil | 3.75 (95.3) | .81 (20.6) | 50 | 50 | 10 |
| GC-22A-4 | 2 1/2 – 3 – 3 1/2 – 4 | #6 AWG – 250 kcmil | 6.31 (95.3) | 1.00 (25.4) | 50 | 50 | 4 |

UL LISTED CERTIFIED **Grounding Rod Clamp, Bronze**

Type WB

- Used for grounding copper conductor parallel to ground rods
- Made from high strength, seamless electrolytic bronze to provide long term durability
- High strength silicon bronze hardware provides long term reliable assembly
- Accommodates a wide range of rod and conductor sizes – minimizes inventory requirements
- UL Listed and CSA Certified for grounding and bonding and suitable for direct burial in earth and concrete

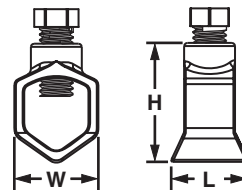

| Part Number | Ground Rod Size | Conductor Size Range | Figure Dimensions In. (mm) | | | Hex Size (In.) | Tightening Torque (In.-Lbs.) | Std. Pkg. Qty. |
|-------------|-----------------|-----------------------------|----------------------------|-------------|-------------|----------------|------------------------------|----------------|
| | | | L | W | H | | | |
| WB12-L | 1/2 | #2 – #10 STR, #10 SOL | .88 (22.4) | .84 (21.3) | 1.28 (32.5) | 1/2 | 180 | 50 |
| WB34-X | 5/8 3/4 | 1/0 – #8 STR #2 – #8 STR | 1.03 (26.2) | 1.06 (26.9) | 1.54 (39.1) | 1/2 | 180 | 10 |
| WB58-Q | 5/8 | 1/0 – #8 STR | 1.04 (26.4) | .92 (23.4) | 1.40 (35.6) | 1/2 | 180 | 25 |

A. System Overview

B1. Cable Ties

B2. Cable Accessories

B3. Stainless Steel Ties

C1. Wiring Duct

C2. Surface Raceway

C3. Abrasion Protection

C4. Cable Management

D1. Terminals

D2. Power Connectors

D3. Grounding Connectors

E1. Labeling Systems

E2. Labels

E3. Pre-Printed & Write-On Markers

E4. Permanent Identification

E5. Lockout/Tagout & Safety Solutions

F. Index

A. System Overview

B1. Cable Ties

B2. Cable Accessories

B3. Stainless Steel Ties

C1. Wiring Duct

C2. Surface Raceway

C3. Abrasion Protection

C4. Cable Management

D1. Terminals

D2. Power Connectors

D3. Grounding Connectors

E1. Labeling Systems

E2. Labels

E3. Pre-Printed & Write-On Markers

E4. Permanent Identification

E5. Lockout/Tagout & Safety Solutions

F. Index

UL LISTED **Grounding Clamp with Spacer for Flat Surfaces, Bronze**

Type GM

- Used to ground copper code conductor to flat surfaces
- Cast from high strength, electrolytic bronze to provide reliable grounding connections
- High strength silicon bronze hardware for long term reliable assembly
- Accommodates a wide range of conductor sizes – minimizes inventory requirements
- Incorporates spacer plate to separate conductor from mounting surface
- UL Listed for grounding and bonding and suitable for direct burial in earth or concrete

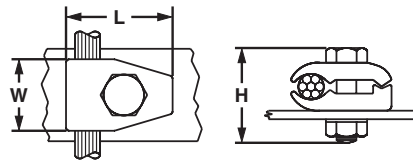

| Part Number | Conductor Size Range | Figure Dimensions In. (mm) | | | Hex Size (In.) | | Tightening Torque (In.-Lbs.) | Std. Pkg. Qty. |
|---------------|----------------------|----------------------------|-------------|-------------|----------------|------|------------------------------|----------------|
| | | L | W | H | Bolt | Nut | | |
| GM-2-Q | #4 SOL – 2/0 STR | 1.63 (41.4) | 1.13 (28.7) | 1.75 (44.5) | 9/16 | 9/16 | 240 | 25 |
| GM-3-Q | 2/0 SOL – 250 kcmil | 2.13 (54.1) | 1.50 (38.1) | 2.00 (50.8) | 3/4 | 3/4 | 480 | 25 |

UL LISTED **Grounding Clamp for Flat Surfaces, Bronze**

Type GMS

- Used to ground copper code conductor to flat surfaces
- Cast from high strength, electrolytic bronze to provide reliable grounding connections
- High strength silicon bronze hardware for long term reliable assembly
- Accommodates a wide range of conductor sizes – minimizes inventory requirements
- UL Listed for grounding and bonding and suitable for direct burial in earth or concrete

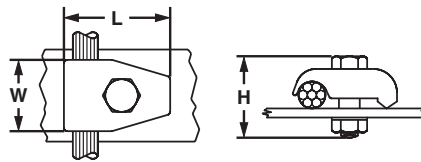

| Part Number | Conductor Size Range | Figure Dimensions In. (mm) | | | Hex Size (In.) | | Tightening Torque (In.-Lbs.) | Std. Pkg. Qty. |
|----------------|----------------------|----------------------------|-------------|-------------|----------------|------|------------------------------|----------------|
| | | L | W | H | Bolt | Nut | | |
| GMS-1-X | #8 SOL – #4 STR | 1.25 (31.8) | 1.00 (25.4) | 1.63 (41.4) | 9/16 | 9/16 | 240 | 10 |
| GMS-2-Q | #4 SOL – 2/0 STR | 1.63 (41.4) | 1.13 (28.7) | 1.75 (44.5) | 9/16 | 9/16 | 240 | 25 |
| GMS-3-Q | 2/0 SOL – 250 kcmil | 2.13 (54.1) | 1.50 (38.1) | 2.00 (50.8) | 3/4 | 3/4 | 480 | 25 |

COMPRESSION CONNECTOR CRIMPING TOOLS

PANDUIT offers a wide range of tools to provide solutions for installing compression lugs and splices. *PANDUIT* installation tools provide quality performance, ease of installation, and lowest installed cost. The long-term reliability of *PANDUIT* installation tools provides the highest level of service to meet and surpass customer requirements.



- Ergonomic design to minimize operator effort
- Controlled cycle mechanisms ensuring reliability and repeatability in every crimp made
- Crimping dies are color-coded to easily match the compression connector to the proper die
- UL Listed and CSA Certified terminations with *PANDUIT* compression connectors, as noted

PANDUIT compression connector crimping tools are available in an assortment of styles including manually operated mechanical and hydraulic, battery operated hydraulic, and AC powered hydraulic to meet a variety of installation needs. *UNI-DIE*[™] Dieless Crimping Tools crimp a variety of sizes and eliminate the need to purchase crimping dies. Fully self-contained battery powered crimping tools provide the ease of push button crimping.

A.
System
Overview

B1.
Cable Ties

B2.
Cable
Accessories

B3.
Stainless
Steel Ties

C1.
Wiring
Duct

C2.
Surface
Raceway

C3.
Abrasion
Protection

C4.
Cable
Management

D1.
Terminals

D2.
Power
Connectors

D3.
Grounding
Connectors

E1.
Labeling
Systems

E2.
Labels

E3.
Pre-Printed
& Write-On
Markers

E4.
Permanent
Identification

E5.
Lockout/
Tagout
& Safety
Solutions

F.
Index

A. System Overview

B1. Cable Ties

B2. Cable Accessories

B3. Stainless Steel Ties

C1. Wiring Duct

C2. Surface Raceway

C3. Abrasion Protection

C4. Cable Management

D1. Terminals

D2. Power Connectors

D3. Grounding Connectors

E1. Labeling Systems

E2. Labels

E3. Pre-Printed & Write-On Markers

E4. Permanent Identification

E5. Lockout/Tagout & Safety Solutions

F. Index

Crimping Guidelines for PANDUIT® PAN-LUG™ Compression Lugs and Splices

1. Select the proper PANDUIT compression connector for the conductor type and size being used.

- PANDUIT compression connectors are identified with the proper conductor size and conductor type marked on the tongue or barrel of the connector



• The proper conductor size and type to be used with each connector can also be found in the installation instructions included with PANDUIT product packaging and in the tool charts* in this catalog

| PANDUIT PART NUMBER | STUD WIRE SIZE | WIRE RANGE TAKING WITH MIN-DIE TOOLS (AWG MIN) | WIRE STRIP LENGTH (IN.) | CT-1700 |
|-----------------------------|----------------|--|-------------------------|---------------|
| LCB4, LCC4 SCL4 | 6 AWG | — | 1-1/4 1-1/8 | RED P21 (3) |
| LCB4, LCC4 SCL4 | 6 AWG | — | 1-1/4 1-1/8 | BLUE P24 (3) |
| LCB4, LCC4, LCC4-12*** SCL4 | 2 AWG SCL | 4 AWG | 1-1/8 1-3/8 | GRAY P29 (3) |
| LCB2, LCC2 SCL2 | 2 AWG | 6-2 AWG | 1-1/4 1-1/4 | BROWN P33 (3) |
| LCB1, LCC1 SCL1 | 1 AWG | 6-1 AWG | 1-3/8 1-3/8 | GREEN P37 (3) |
| LCB1B, LCC1B SCL1B | 1/0 AWG | 6-1/0 AWG | 1-3/2 1-3/8 | — |
| LCB2B, LCC2B SCL2B | 2/0 AWG | 4-2/0 AWG | 1-5/8 1-3/2 | — |
| LCB3B, LCC3B SCL3B | 3/0 AWG | 2-3/0 AWG | 1-9/16 1-1/2 | — |

2. Strip the conductor to the proper strip length. As specified:

- On the PANDUIT product packaging label or
- On the installation instructions included with PANDUIT product packaging or
- In the tool charts* in this catalog



Make sure the conductor is not stripped too long, which would result in exposed wire between the barrel of the connector and the cable insulation.

Make sure the conductor is not stripped too short, which would result in a less than complete contact area with the connector when the conductor is inserted in the barrel.

Do not nick or cut strands of conductor during crimping, which would result in a less than premium conductor termination.



Make sure conductor strands are free from corrosion.

3. Select the proper crimping die and crimping tool to be used with the connector.

Use crimping tools and dies that provide a UL Listed and/or CSA Certified electrical termination, to assure a safe and reliable connection.

Many PANDUIT compression connectors are UL Listed and CSA Certified when crimped with PANDUIT and specified competitor crimping tools and dies. These tools and dies are listed in the tool charts* in this catalog. PANDUIT crimping tools and dies to be used with each connector are also listed on the installation instructions included with PANDUIT product packaging.

PANDUIT compression connectors are color-coded and marked with PANDUIT and specified competitor die index numbers. Select the proper crimping die to be used by matching the color code and die index number marked on the connector to the same markings on the crimping die.



4. Crimp the connector.

Insert the conductor into the barrel of the connector. The conductor should stop against the end of the barrel of the lug, or wire stop in the butt splice, upon complete insertion of the conductor in the barrel. Some lugs are offered with inspection windows that provide visual inspection of the complete conductor insertion.



Review the installation instructions included with the PANDUIT product packaging or the tool charts* for the proper number of crimps to be placed in the connector. Make the first crimp in the barrel nearest

| WIR. PWR. (L2) | (L2) | PWR. PWR. (L2) |
|----------------|------|----------------|
| JD-920-2/0 | STD | CD-2001-2/0 |
| ADK P45 (3) | (2) | BLACK P45 (3) |
| JD-920-3/0 | STD | CD-2001-3/0 |
| ANGE P50 (3) | (2) | ORANGE P50 (3) |
| JD-920-4/0 | STD | CD-2001-4/0 |
| RPE P54 (3) | (2) | PURPLE P54 (3) |
| JD-920-250 | STD | CD-2001-250 |
| LOW P62 (3) | (3) | YELLOW P62 (3) |
| JD-920-300 | STD | CD-2001-300 |
| HTE P65 (3) | (2) | WHITE P65 (3) |
| JD-920-350 | STD | CD-2001-350 |
| ED P71 (3) | (3) | RED P71 (3) |
| JD-920-400 | STD | CD-2001-400 |

the tongue of the lug, or wire stop in a butt splice, and make successive crimps in the barrel working towards the



conductor entry at the end of the barrel. Use the color-coded or knurled band markings on the barrel of the connector to evenly space the placement of the crimps in the barrel.

When properly crimped, the die index number engraved in the crimping die will be embossed into the barrel of the connector. The crimp should be placed in the connector so the die index number can be easily read when the connector is installed.



* See tool charts on pages D3.52 – D3.90.

Crimping Guidelines for PANDUIT® STRUCTUREDGROUND™ Compression Connectors

TAP Installation

1. Locate desired position of TAP along main wire run. Allow clearance for tap wires (and cover installation if applicable). See clear cover table on page D3.8.
2. Strip insulation from wires to the length shown in the TAP tables on pages D3.9 – D3.10. Use care to avoid damaging the conductors.
3. Position wires in the appropriate tap grooves.
4. For easier installation, apply one of the flame retardant cable ties (provided) around the wires and through the slots in the TAP. **The head of the cable tie must be positioned along the side of the TAP as shown in Figure A.** Tension and cut off excess length of tie. Additional cable ties may be used adjacent to the TAP to secure the wires.
5. Install the correct dies (see page D3.87) into the crimping tool. Position the locator die into the stationary die holder. **Note: The color code and die index number shown on the HTAP and crimping dies must match.**
6. Position the TAP against the locator in the stationary die holder of the crimping tool.
7. After crimping, if desired, cut off the cable tie head or remove the entire cable tie. **Note: In some cases, the cable tie head must be cut off in order for the crimped connector to fit inside the insulating cover.**

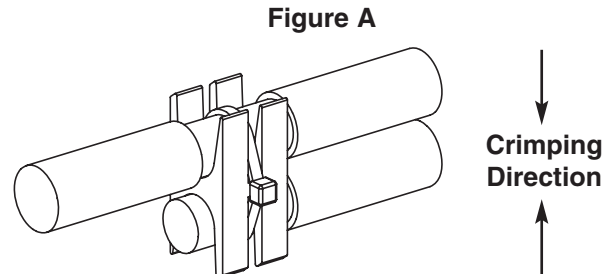

HTAP Cover Installation

1. If labels are being utilized, cut labels to the dimensions shown below. **Note: When using a PANDUIT® PAN-THER™ LS8E printer, the length dimensions can be easily programmed to provide cut-off marks.**
2. Position the label(s) in the pockets inside the cover and snap in the label retainer(s) as shown in Figure B. Information can be marked on the matte finish label retainers in lieu of using a separate label.
3. Position one cover half around the crimped connector assembly. Align the second cover half with the first and snap together.
4. Install the two flame retardant cable ties (provided) in the grooved areas on the cover. Tension and cut off excess lengths of ties.

Label Size Information

| Clear Cover Part Number | Label Height (Max.) | Label Length (Wrap-Around Style) | Label Length (Flat Style) |
|-------------------------|---------------------|----------------------------------|---------------------------|
| CLRCVR1-1 | .38 | 1.56 | 1.00 |
| CLRCVR2-1 | .38 | 1.87 | 1.25 |
| CLRCVR3-1 | .38 | 2.37 | 1.75 |
| CLRCVR5-1 | .38 | 3.37 | 2.06 |
| CLRCVR6-1 | .38 | 4.31 | 2.94 |

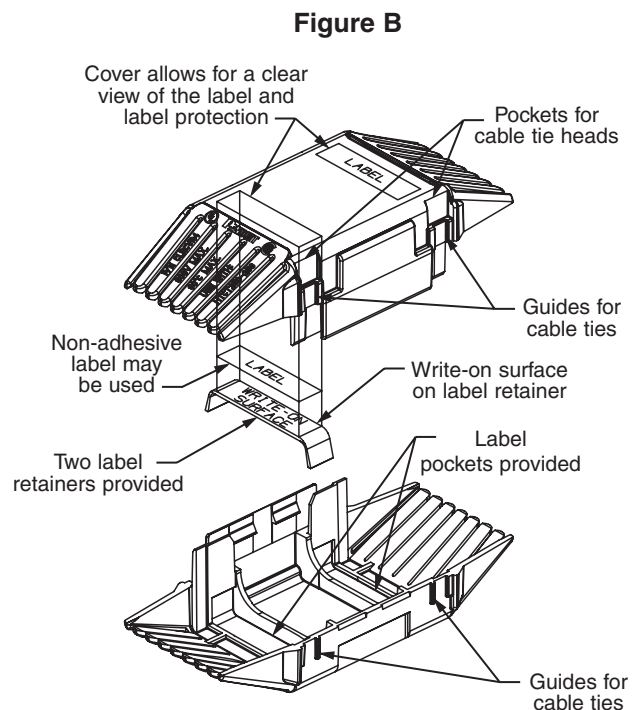

Note: Configuration of cover may differ slightly from illustration.

A. System Overview

B1. Cable Ties

B2. Cable Accessories

B3. Stainless Steel Ties

C1. Wiring Duct

C2. Surface Raceway

C3. Abrasion Protection

C4. Cable Management

D1. Terminals

D2. Power Connectors

D3. Grounding Connectors

E1. Labeling Systems

E2. Labels

E3. Pre-Printed & Write-On Markers

E4. Permanent Identification

E5. Lockout/Tagout & Safety Solutions

F. Index

Selection Guide – Compression Connector Tools (continued)

| Tool Selection Guide for Crimping PANDUIT Copper Compression Lugs and Splices for use with Copper Flex Conductor | | | | | | | | | | | | | | | | | | | | | | | | | | | | | | |
|--|---|--|-----------------------------|--|---------------------|--------|--------|--------|---------|---------|---------|---------|-----------|-----------|-----------|-----------|-----------|-----------|-----------|-----------|-----------|-----------|-----------|-----------|-----------|-----------|--|--|--|--|
| Conductor Type | Connector Type | Tool Type | Copper Conductor Range | | | | | | | | | | | | | | | | | | | | | | | | | | | |
| | | | #8 AWG | #6 AWG | #4 AWG | #3 AWG | #2 AWG | #1 AWG | 1/0 AWG | 2/0 AWG | 3/0 AWG | 4/0 AWG | 250 kcmil | 262 kcmil | 300 kcmil | 313 kcmil | 350 kcmil | 373 kcmil | 400 kcmil | 450 kcmil | 500 kcmil | 535 kcmil | 600 kcmil | 646 kcmil | 750 kcmil | 777 kcmil | | | | |
| Copper Code and Flex Conductor | LCAX LCAXN LCBX LCDX LCDXN LCCX Maximum Code Conductor Size 4/0 AWG | Manual Crimping Tool | CT-1700 (pg. D1.84) | | | | | | | | | | | | | | | | | | | | | | | | | | | |
| | | Manual Hydraulic Crimping Tool | CT-930 (pg. D3.35) | | | | | | | | | | | | | | | | | | | | | | | | | | | |
| | | Battery Powered Hydraulic Crimping Tools | CT-2001 (pg. D3.36) | | | | | | | | | | | | | | | | | | | | | | | | | | | |
| | | | CT-2002 (pg. D3.37) | | | | | | | | | | | | | | | | | | | | | | | | | | | |
| | | | CT-2931 (pg. D3.39) | | | | | | | | | | | | | | | | | | | | | | | | | | | |
| | | | CT-2940 (pg. D3.40) | | | | | | | | | | | | | | | | | | | | | | | | | | | |
| | | Remote Crimp Heads | CT-930CH (pg. D3.41) | | | | | | | | | | | | | | | | | | | | | | | | | | | |
| | | | CT-940CH (pg. D3.42) | | | | | | | | | | | | | | | | | | | | | | | | | | | |
| | | Copper Flex Conductor | LCAF LCCF SCSF RSC | Manual Hydraulic Crimping Tool | CT-930 (pg. D3.35) | | | | | | | | | | | | | | | | | | | | | | | | | |
| | | | | Battery Powered Hydraulic Crimping Tools | CT-2931 (pg. D3.39) | | | | | | | | | | | | | | | | | | | | | | | | | |
| CT-2940 (pg. D3.40) | | | | | | | | | | | | | | | | | | | | | | | | | | | | | | |
| Remote Crimp Heads | CT-930CH (pg. D3.41) | | | | | | | | | | | | | | | | | | | | | | | | | | | | | |
| | CT-940CH (pg. D3.42) | | | | | | | | | | | | | | | | | | | | | | | | | | | | | |

See tool charts on pages D3.52 – D3.90 for selection of crimping dies and number of crimps used with specific tool and connector combinations.

Selection guide continues on page D3.32

A. System Overview

B1. Cable Ties

B2. Cable Accessories

B3. Stainless Steel Ties

C1. Wiring Duct

C2. Surface Raceway

C3. Abrasion Protection

C4. Cable Management

D1. Terminals

D2. Power Connectors

D3. Grounding Connectors

E1. Labeling Systems

E2. Labels

E3. Pre-Printed & Write-On Markers

E4. Permanent Identification

E5. Lockout/Tagout & Safety Solutions

F. Index

A.
System
Overview

Selection Guide – Compression Connector Tools (continued)

B1.
Cable Ties

Tool Selection Guide for Crimping PANDUIT Aluminum Compression Lugs and Splices for use with Copper or Aluminum Code Conductor

| Conductor Type | Connector Type | Tool Type | Copper or Aluminum Conductor Range | | | | | | | | | | | | | | | | | |
|-----------------------------------|------------------|--|------------------------------------|--------|--------|--------|--------|---------|---------|---------|---------|-----------|-----------|-----------|-----------|-----------|-----------|-----------|-----------|------------|
| | | | #6 AWG | #4 AWG | #3 AWG | #2 AWG | #1 AWG | 1/0 AWG | 2/0 AWG | 3/0 AWG | 4/0 AWG | 250 kcmil | 300 kcmil | 350 kcmil | 400 kcmil | 500 kcmil | 600 kcmil | 750 kcmil | 800 kcmil | 1000 kcmil |
| Copper or Aluminum Code Conductor | LAA LAB SA | Manual Crimping Tools | CT-1700 (pg. D1.84) | | | | | | | | | | | | | | | | | |
| | | | CT-720 (pgs. D3.34, D1.87) | | | | | | | | | | | | | | | | | |
| | | Manual Hydraulic Crimping Tool | CT-930 (pg. D3.35) | | | | | | | | | | | | | | | | | |
| | | Battery Powered Hydraulic Crimping Tools | CT-2931 (pg. D3.39) | | | | | | | | | | | | | | | | | |
| | | | CT-2940 (pg. D3.40) | | | | | | | | | | | | | | | | | |
| | | Remote Crimp Heads | CT-930CH (pg. D3.41) | | | | | | | | | | | | | | | | | |
| CT-940CH (pg. D3.42) | | | | | | | | | | | | | | | | | | | | |

See tool charts on pages D3.52 – D3.90 for selection of crimping dies and number of crimps used with specific tool and connector combinations.

D1.
Terminals

D2.
Power
Connectors

D3.
Grounding
Connectors

E1.
Labeling
Systems

E2.
Labels

E3.
Pre-Printed
& Write-On
Markers

E4.
Permanent
Identification

E5.
Lockout/
Tagout/
& Safety
Solutions

F.
Index

Die Type, Manual, Crimping Tool

- High quality, durable tool construction provides long term dependability



- Develops 6 tons of crimping force, crimps copper compression lugs and splices up to 500 kcmil
- Provides UL Listed and CSA Certified connections on *PANDUIT* copper and aluminum lugs, splices, and insulated terminals

| Part Number | Part Description | Std. Pkg. Qty. |
|-------------|---|----------------|
| CT-720 | Manual crimping tool for UL Listed or Recognized and CSA Certified terminations of <i>PANDUIT</i> ® <i>PAN-LUG</i> ™ copper compression lugs and splices for #8 AWG – 500 kcmil copper code conductor and aluminum compression lugs and splices for #6 AWG – 350 kcmil copper and aluminum code conductors. Provides UL Listed terminations of <i>PANDUIT</i> ® <i>PAN-TERM</i> ® #8 – #2 AWG vinyl insulated terminals. Color-coded CD-720 crimping dies, carrying/storage case and controlled cycle mechanism must be purchased separately. Specifications: Output: 6 tons Weight: 7.7 lbs. Length: 26" Handle span: 58" (open), 2.5" (closed) Warranty: 90 days | 1 |
| CC-720 | Optional controlled cycle mechanism only. Total weight of tool with CC-720 is 8.25 lbs. | 1 |
| C-720 | Black steel carrying case for CT-720 crimping tool. | 1 |

For battery powered crimping tools, see compression connector tools selection guide on pages D3.30 – D3.32.

CD-720 Crimping Dies

- Color-coded for easy matching to color-coding marked on connectors
- Embosses die index number on connector barrels to provide post crimp inspection except CD-720PV8-2
- Part number permanently marked on crimping die for easy identification
- Provides 5-sided crimp results in terminations with premium electrical and mechanical performance



| Part Number | Used to Install <i>PANDUIT</i> Compression Lug and Splice Sizes | | | | Std. Pkg. Qty. |
|-------------|---|--|-------------------------|--|----------------|
| | Copper Conductor Size | Copper Die Color and Die No. | Aluminum Conductor Size | Aluminum Die Color and Die No. | |
| CD-720-1 | #8 – #2 AWG | Red P21, Blue P24, Gray P29, Brown P33 | #6 AWG | Gray P29 | 1 |
| CD-720-2 | #1 – 3/0 AWG | Green P37, Pink P42, Black P45, Orange P50 | #4 – 1/0 AWG | Green P37, Pink P42, Gold P45, Tan P50 | 1 |
| CD-720-3 | 4/0 AWG – 250 kcmil | Purple P54, Yellow P62 | 2/0 – 3/0 AWG | Olive P54, Ruby P62 | 1 |
| CD-720-4 | 300 kcmil | White P66 | 4/0 AWG | White P66 | 1 |
| CD-720-5 | 350 kcmil | Red P71 | 250 kcmil | Red P71 | 1 |
| CD-720-6 | 400 kcmil | Blue P76 | 300 kcmil | Blue P76 | 1 |
| CD-720-7 | 500 kcmil | Brown P87 | 350 kcmil | Brown P87 | 1 |
| CD-720PV8-2 | #8 – #2 AWG, vinyl insulated <i>PAN-TERM</i> ® Terminals | Red, Blue, Yellow | — | — | 1 |

See pages D3.30 – D3.32 for connector and tool selection information.

A. System Overview

B1. Cable Ties

B2. Cable Accessories

B3. Stainless Steel Ties

C1. Wiring Duct

C2. Surface Raceway

C3. Abrasion Protection

C4. Cable Management

D1. Terminals

D2. Power Connectors

D3. Grounding Connectors

E1. Labeling Systems

E2. Labels

E3. Pre-Printed & Write-On Markers

E4. Permanent Identification

E5. Lockout/Tagout & Safety Solutions

F. Index

A.
System
Overview

Die Type, Manual, Crimping Tool and Die Kits

B1.
Cable Ties

- Available with or without controlled cycle feature to meet specific applications

- Kits available with three or full set of seven dies for crimping partial or full range of connector sizes

B2.
Cable
Accessories



B3.
Stainless
Steel Ties

C1.
Wiring
Duct

C2.
Surface
Raceway

C3.
Abrasion
Protection

C4.
Cable
Management

| Part Number | Part Description | Std. Pkg. Qty. |
|-------------|--|----------------|
| CT-720-7 | Basic tool kit with seven dies. Includes: <ul style="list-style-type: none"> • Seven dies (CD-720-1 through CD-720-7) for installing #8 AWG – 500 kcmil copper compression connectors • Carrying/storage case (C-720) | 1 |
| CT-720-7CC | Controlled cycle tool kit with seven dies. Controlled cycle mechanism factory installed on crimping tool. Includes: <ul style="list-style-type: none"> • Seven dies (CD-720-1 through CD-720-7) for installing #8 AWG – 500 kcmil copper compression connectors • Carrying/storage case (C-720) | 1 |
| CT-720-3 | Basic tool kit with three dies. Includes: <ul style="list-style-type: none"> • Three dies (CD-720-1 through CD-720-3) for installing #8 AWG – 250 kcmil copper compression connectors • Carrying/storage case (C-720) | 1 |
| CT-720-3CC | Controlled cycle tool kit with three dies. Controlled cycle mechanism factory installed on crimping tool. Includes: <ul style="list-style-type: none"> • Three dies (CD-720-1 through CD-720-3) for installing #8 AWG – 250 kcmil copper compression connectors • Carrying/storage case (C-720) | 1 |

D1.
Terminals

Cable Stripping Tool for Large Cable Sizes

D2.
Power
Connectors

- Provides safe and easy stripping of cable insulation for cables 3/16" to 1 9/16" diameter
- Cutting blade provides circular, spiral, and in-line insulation cutting
- Spiral cut mode, tough/hard insulations peel off easily
- In-line cut mode for use with softer insulation like neoprene
- Unique blade profile for long life, low friction stripping of difficult insulations like rubber and silicon

- Cutting blade easily adjusts to proper height to cut insulation without nicking conductor strands
- Ergonomic shape for safe comfortable use
- Compact design
- Easy-fit replacement blade, one spare blade included with tool

D3.
Grounding
Connectors



| Part Number | Wire Range (O.D.) | Part Description | Std. Pkg. Qty. |
|-------------|-------------------|--|----------------|
| CST114-157 | .18" – 1.57" | Cable stripping tool for stripping insulation from cables 3/16" to 1 9/16" diameter. Includes replacement cutting blade. Warranty: 90 days | 1 |

E1.
Labeling
Systems

E2.
Labels

Wire and Cable Stripping Tools

E3.
Pre-Printed
& Write-On
Markers

- Strips and cuts #20 – #10 AWG wire
- Lightweight and durable for comfortable long use

- Rust resistant coating included to improve durability of tool

E4.
Permanent
Identification



CST101

E5.
Lockout/
Tagout/
& Safety
Solutions



CST115

F.
Index

| Part Number | Wire Range (O.D.) | Part Description | Std. Pkg. Qty. |
|-------------|-------------------|---------------------------|----------------|
| CST101 | #20 – #10 AWG | V notch wire stripper. | 1 |
| CST115 | #20 – #10 AWG | Plier nose wire stripper. | 1 |

Die Type, Manual Hydraulic, 14 Ton, Crimping Tool

- Develops 14 tons of crimping force, crimps copper compression lugs and splices up to 750 kcmil
- Two-stage rapid advance hydraulic system minimizes number of pumps required to complete a crimp, saves time
- High quality, durable tool construction provides long-term dependability
- Cushioned grip prevents hands from slipping on tool, reduces fatigue
- Provides UL Listed and CSA Certified connections on *PANDUIT® PAN-LUG™* Copper and Aluminum Lugs and Splices and Copper Taps
- Open “C-Head” design allows easy loading of crimping dies and connectors, saves time
- Uses color-coded crimping dies to provide easy matching of crimping die to connector
- Embosses die index number on connector barrels to provide post crimp inspection
- Dies installed using spring loaded die retention pins, no need for tools
- Rubber boot on crimp head provides abrasion protection
- Audible “pop-off” valve indicates crimp completion
- Crimp head rotates 180 degrees, provides versatility for use in restricted spaces



| Part Number | Part Description | Std. Pkg. Qty. |
|-------------|--|----------------|
| CT-930 | <p>Terminates <i>PANDUIT® PAN-LUG™</i> Compression Connectors:</p> <ul style="list-style-type: none"> • Copper compression lugs and splices for #8 AWG – 750 kcmil code conductor • Copper compression lugs and splices for #8 AWG – 600 kcmil flex conductor • Copper compression CTAPF taps for #10 – 3/0 AWG code conductor • Copper compression CTAP taps for #8 – 4/0 AWG code conductor • Copper compression HTCT taps for #14 AWG – 250 kcmil code conductor, #14 – 4/0 AWG flex conductor • Aluminum compression lugs and splices for #6 AWG – 600 kcmil code conductor • Aluminum compression HTAPs for #14 AWG – 500 kcmil code conductor • <i>PANDUIT® PAN-TERM®</i> Tubular Terminals for #8 AWG – 250 kcmil code conductor <p>Specifications: Output: 14 tons Jaw opening: 1.65" Weight: 16.5 lbs. Length: 25" Handle span: 17 1/2" (open), 6" (closed) Warranty: 5 years</p> <p>CT-930 includes: • Tool • Plastic tool case with die storage</p> | 1 |

Uses CD-920 and CD-930 color-coded crimping dies. Dies must be purchased separately, see pages D3.46. CG-920 crimp force measurement gauge available, sold separately see page D3.51.

A.
System
Overview

B1.
Cable Ties

B2.
Cable
Accessories

B3.
Stainless
Steel Ties

C1.
Wiring
Duct

C2.
Surface
Raceway

C3.
Abrasion
Protection

C4.
Cable
Management

D1.
Terminals

D2.
Power
Connectors

D3.
Grounding
Connectors

E1.
Labeling
Systems

E2.
Labels

E3.
Pre-Printed
& Write-On
Markers

E4.
Permanent
Identification

E5.
Lockout/
Tagout
& Safety
Solutions

F.
Index

A.
System
Overview

Die Type, Battery Powered Hydraulic, 6 Ton, Crimping Tool with Closed Head

B1.
Cable Ties

- Battery powered, provides fingertip operation
- Self-contained unit, completely portable
- Lightweight and ergonomically balanced for easy operation without fatigue
- Develops 6 tons of crimping force, crimps copper compression lugs and splices up to 500 kcmil
- Provides UL Listed and CSA Certified connections on *PANDUIT® PAN-LUG™* Copper Lugs, Splices, and Taps
- Audible "pop-off" valve indicates crimp completion
- Tool provided with two, NiCd rechargeable batteries and battery charger to allow for continuous operation
- High productivity, up to 80 crimps on 500 kcmil copper lugs and splices on a single battery charge
- Six to eight second crimp cycle time provides quick terminations, saves time

- Battery charger charges expended batteries completely in 25 minutes
- Battery charger includes battery reconditioner feature which prevents battery memory build-up and provides over 1,000 battery recharge cycles resulting in long life
- Uses color-coded crimping dies to provide easy matching of crimping die to connector
- Embosses die index number on connector barrels to provide post crimp inspection
- Dies installed using spring loaded die retention pins, no need for tools
- Crimp head rotates 180 degrees to provide versatility for use in restricted spaces

B2.
Cable
Accessories

B3.
Stainless
Steel Ties

C1.
Wiring
Duct

C2.
Surface
Raceway

C3.
Abrasion
Protection

C4.
Cable
Management



D1.
Terminals

D2.
Power
Connectors

D3.
Grounding
Connectors

E1.
Labeling
Systems

E2.
Labels

E3.
Pre-Printed
& Write-On
Markers

E4.
Permanent
Identification

E5.
Lockout/
Tagout/
& Safety
Solutions

F.
Index

| Part Number | Part Description | Std. Pkg. Qty. |
|-------------|---|----------------|
| CT-2001 | <p>Terminates <i>PANDUIT® PAN-LUG™</i> Compression Connectors:</p> <ul style="list-style-type: none"> • Copper compression lugs and splices for #8 AWG – 500 kcmil code conductor • Copper compression lugs for #8 AWG – 350 kcmil flex conductor • Copper compression CTAPF taps for #10 – 3/0 AWG code conductor • Copper compression CTAP taps for #8 – #2 AWG code conductor • <i>PANDUIT® PAN-TERM®</i> Tubular Terminals for #8 AWG – 250 kcmil code conductor <p>Specifications: Output: 6 tons Jaw opening: 1.8" Weight: 8.5 lbs. with battery Length: 13" Height: 12" Width: 3" Warranty: 3 years on tool, 5 years on batteries</p> <p>CT-2001 includes:</p> <ul style="list-style-type: none"> • Tool • Two CT-NLBC25, 14.4 VDC rechargeable batteries (non-LED) • One CT-CHR25 battery charger • One shoulder strap • Plastic tool case with storage for batteries, charger, shoulder strap and crimping dies • Tool incorporates D3 die pocket (included with tool) | 1 |

Uses color-coded CD-2001 crimping dies. Dies must be purchased separately, see page D3.38.
 For battery charger and battery accessories, see page D3.51.

Die Type, Battery Powered Hydraulic, 6 Ton, Crimping Tool with Open “C-Head”

- Battery powered, provides fingertip operation
- Self-contained unit, completely portable
- Lightweight and ergonomically balanced for easy operation without fatigue
- Develops 6 tons of crimping force, crimps copper compression lugs and splices up to 500 kcmil
- Provides UL Listed and CSA Certified connections on *PANDUIT® PAN-LUG™* Copper Lugs, Splices, and Taps
- Open “C-Head” design allows easy loading of crimping dies and connectors, saves time
- Rubber boot on crimp head provides abrasion protection
- Audible “pop-off” valve indicates crimp completion
- Tool provided with two, NiCd rechargeable batteries and battery charger to allow for continuous operation
- High productivity, up to 80 crimps on 500 kcmil copper lugs and splices on a single battery charge
- Six to eight second crimp cycle time provides quick terminations, saves time
- Battery charger charges expended batteries completely in 25 minutes
- Batteries include LED battery charge indicators for visual indication of current battery charge
- Battery charger includes battery reconditioner feature which prevents battery memory build-up and provides over 1,000 battery recharge cycles resulting in long life
- Uses color-coded crimping dies to provide easy matching of crimping die to connector
- Embosses die index number on connector barrels to provide post crimp inspection
- Dies installed using spring loaded die retention pins, no need for tools
- Crimp head rotates 180 degrees to provide versatility for use in restricted spaces



| Part Number | Part Description | Std. Pkg. Qty. |
|-------------|--|----------------|
| CT-2002 | <p>Terminates <i>PANDUIT® PAN-LUG™</i> Compression Connectors:</p> <ul style="list-style-type: none"> • Copper compression lugs and splices for #8 AWG – 500 kcmil code conductor • Copper compression lugs for #8 AWG – 350 kcmil flex conductor • Copper compression CTAPF taps for #10 – 3/0 AWG code conductor • Copper compression CTAP taps for #8 – #2 AWG code conductor • <i>PANDUIT® PAN-TERM®</i> Tubular Terminals for #8 AWG – 250 kcmil code conductor <p>Specifications: Output: 6 tons Jaw opening: .95" Weight: 9.0 lbs. with battery Length: 13" Height: 12" Width: 3" Warranty: 5 years tool, 1 year on batteries</p> <p>CT-2002 includes:</p> <ul style="list-style-type: none"> • Tool • Two CT-BC25, 14.4 VDC rechargeable batteries with LED display • One CT-CHR25 battery charger • One shoulder strap • Plastic tool case with storage for batteries, shoulder strap, and crimping dies • Tool incorporates D3 die pocket (included with tool) | 1 |

Uses color-coded CD-2001 crimping dies. Dies must be purchased separately, see page D3.38. For battery charger and battery accessories, see page D3.51.

A.
System
Overview

B1.
Cable Ties

B2.
Cable
Accessories

B3.
Stainless
Steel Ties

C1.
Wiring
Duct

C2.
Surface
Raceway

C3.
Abrasion
Protection

C4.
Cable
Management

D1.
Terminals

D2.
Power
Connectors

D3.
Grounding
Connectors

E1.
Labeling
Systems

E2.
Labels

E3.
Pre-Printed
& Write-On
Markers

E4.
Permanent
Identification

E5.
Lockout/
Tagout
& Safety
Solutions

F.
Index

A.
System
Overview

CD-2001 Crimping Dies

B1.
Cable Ties

- Color-coded to provide easy matching to color-coding marked on connectors
- Embosses die index number on connector barrels to provide post crimp inspection

- Part number permanently marked on crimping die for easy identification
- Provide circumferential crimp results in terminations with premium electrical and mechanical performance

B2.
Cable
Accessories



CD-2001

B3.
Stainless
Steel Ties

C1.
Wiring
Duct

C2.
Surface
Raceway

C3.
Abrasion
Protection

C4.
Cable
Management

D1.
Terminals

D2.
Power
Connectors

D3.
Grounding
Connectors

E1.
Labeling
Systems

E2.
Labels

E3.
Pre-Printed
& Write-On
Markers

E4.
Permanent
Identification

E5.
Lockout/
Tagout
& Safety
Solutions

F.
Index

| Part Number | Used to Install <i>PANDUIT</i> Compression Lug and Splice Sizes | | | | Std. Pkg. Qty. |
|-------------|---|------------------------------|------------------------------|--------------------------------|----------------|
| | Copper Code Conductor Size | Copper Die Color and Die No. | Aluminum Code Conductor Size | Aluminum Die Color and Die No. | |
| CD-2001-8 | #8 AWG | Red P21 | — | — | 1 |
| CD-2001-6 | #6 AWG | Blue P24 | — | — | 1 |
| CD-2001-4 | #4 AWG STR #3 AWG STR #2 AWG SOL | Gray P29 | #6 AWG | Gray P29 | 1 |
| CD-2001-2 | #2 AWG | Brown P33 | — | — | 1 |
| CD-2001-1 | #1 AWG | Green P37 | #4 AWG | Green P37 | 1 |
| CD-2001-1/0 | 1/0 AWG | Pink P42 | #2 AWG | Pink P42 | 1 |
| CD-2001-2/0 | 2/0 AWG | Black P45 | #1 AWG | Gold P45 | 1 |
| CD-2001-3/0 | 3/0 AWG | Orange P50 | 1/0 AWG | Tan P50 | 1 |
| CD-2001-4/0 | 4/0 AWG | Purple P54 | 2/0 AWG | Olive P54 | 1 |
| CD-2001-250 | 250 kcmil | Yellow P62 | 3/0 AWG | Ruby P62 | 1 |
| CD-2001-300 | 300 kcmil | White P66 | 4/0 AWG | White P66 | 1 |
| CD-2001-350 | 350 kcmil | Red P71 | 250 kcmil | Red P71 | 1 |
| CD-2001-400 | 400 kcmil | Blue P76 | 300 kcmil | Blue P76 | 1 |
| CD-2001-500 | 500 kcmil | Brown P87 | — | — | 1 |

| Part Number | Used to Install <i>PANDUIT</i> Tap Part Numbers | | | Std. Pkg. Qty. |
|--------------------------|---|-----------------------|--------------------------|----------------|
| | Copper Tap | Die Color and Die No. | Aluminum Tap | |
| Single Crimp Dies | | | | |
| CD-2001-8 | CTAPF10-16-C | Red P21 | — | 1 |
| CD-2001-6 | CTAPF8-12-C | Blue P24 | — | 1 |
| CD-2001-4 | CTAPF6-12-C | Gray P29 | — | 1 |
| CD-2001-2 | CTAPF4-12-C | Brown P33 | — | 1 |
| CD-2001-1 | CTAPF3-12-C | Green P37 | — | 1 |
| CD-2001-1/0 | CTAPF2-12-C | Pink P42 | — | 1 |
| CD-2001-2/0 | CTAPF1-12-C | Black P45 | — | 1 |
| CD-2001-3/0 | CTAPF1/0-12-L | Orange P50 | HTAP2-8-L | 1 |
| CD-2001-4/0 | CTAPF2/0-12-Q | Purple P54 | — | 1 |
| CD-2001-250 | CTAPF3/0-12-Q | Yellow P62 | — | 1 |
| CD-2001-BG | CTAP4-4-L to CTAP4-8-L | PBG | — | 1 |
| CD-2001-C | CTAP2-4-Q to CTAP2-2-X | PC | — | 1 |
| CD-2001-O | — | Green PO | HTAP1-1-Q to HTAP2/0-1-Q | 1 |

Multi-Crimp Dies

| | | | | |
|--------------|---------------|-------------|---|---|
| CDM-2001-2 | CTAPF4-12-C | Brown P33M | — | 1 |
| CDM-2001-1 | CTAPF3-12-C | Green P37M | — | 1 |
| CDM-2001-1/0 | CTAPF2-12-C | Pink P42M | — | 1 |
| CDM-2001-2/0 | CTAPF1-12-C | Black P45M | — | 1 |
| CDM-2001-3/0 | CTAPF1/0-12-L | Orange P50M | — | 1 |

See pages D3.52 – D3.90 for connector and tool selection information.



CDM-2001

Die Type, Battery Powered Hydraulic, 12 Ton, Crimping Tool

- Battery powered, provides fingertip operation
- Self-contained unit, completely portable
- Develops 12 tons of crimping force, crimps copper compression lugs and splices up to 750 kcmil
- 2-stage rapid advance hydraulic system minimizes cycle time
- Provides UL Listed and CSA Certified connections on *PANDUIT® PAN-LUG™* Copper and Aluminum Lugs and Splices and Copper Taps
- Open “C-Head” design allows easy loading of crimping dies and connectors, saves time
- Rubber boot on crimp head provides abrasion protection
- Ram automatically retracts when crimp cycle is complete
- Tool provided with two, high capacity 12 VDC rechargeable nickel-metal hydride batteries to provide for continuous operation and eliminate “memory” build-up, one hour charge time
- Eight second crimp cycle time provides quick terminations, saves time
- Uses industry standard MAKITA® batteries and charger, industry proven reliability easy to obtain from local retail sources
- Uses color-coded crimping dies to provide easy matching of crimping die to connector
- Embosses die index number on connector barrels to provide post crimp inspection
- Dies installed using spring loaded die retention pins, no need for tools
- Crimp head rotates 360 degrees to provide versatility for use in restricted spaces



| Part Number | Part Description | Std. Pkg. Qty. |
|-------------|---|----------------|
| CT-2931 | <p>Terminates <i>PANDUIT® PAN-LUG™</i> Compression Connectors:</p> <ul style="list-style-type: none"> • Copper compression lugs and splices for #8 AWG – 750 kcmil code conductor • Copper compression lugs and splices for #8 AWG – 600 kcmil flex conductor • Copper compression CTAPF taps for #10 – 3/0 AWG code conductor • Copper compression CTAP taps for #8 – 4/0 AWG code conductor • Copper compression HTCT taps for #14 AWG – 250 kcmil code conductor, #14 – 4/0 AWG flex conductor • Aluminum compression lugs and splices for #6 AWG – 600 kcmil code conductor • Aluminum compression HTAPs for #14 AWG – 500 kcmil code conductor • <i>PANDUIT® PAN-TERM®</i> Tubular Terminals for #8 AWG – 250 kcmil code conductor <p>Specifications: Output: 12 tons Jaw opening: 1.65" Weight: 15.2 lbs with battery Length: 15 5/8" Height: 12" Width: 3 3/16" Warranty: 3 years</p> <p>CT-2931 includes: • Tool • Two 12 VDC, rechargeable NiMH batteries • One battery charger, 115 VAC • Steel tool case with storage for batteries, charger, and crimping dies</p> | 1 |

Uses CD-920 and CD-930 color-coded crimping dies. Dies must be purchased separately, see page D3.46. CG-920 crimp force measurement gauge available, sold separately, see page D3.51.

*MAKITA is a registered trademark of Makita Corporation.

A. System Overview

B1. Cable Ties

B2. Cable Accessories

B3. Stainless Steel Ties

C1. Wiring Duct

C2. Surface Raceway

C3. Abrasion Protection

C4. Cable Management

D1. Terminals

D2. Power Connectors

D3. Grounding Connectors

E1. Labeling Systems

E2. Labels

E3. Pre-Printed & Write-On Markers

E4. Permanent Identification

E5. Lockout/Tagout & Safety Solutions

F. Index

A.
System
Overview

Die Type, Battery Powered Hydraulic, 15 Ton, Crimping Tool

B1.
Cable Ties

- Battery powered, provides fingertip operation
- Self-contained unit, completely portable
- Develops 15 tons of crimping force, crimps copper compression lugs and splices up to 1,000 kcmil

- Battery charger charges expended batteries completely in 25 minutes
- Batteries include LED battery charge indicators for visual indication of current battery charge

B2.
Cable
Accessories

- Provides UL Listed and CSA Certified connections on *PANDUIT® PAN-LUG™* Copper and Aluminum Lugs and Splices and Copper Taps

- Battery charger includes battery reconditioner feature which prevents battery memory build-up and provides over 1,000 battery recharge cycles resulting in long life

B3.
Stainless
Steel Ties

- Flip-top crimp head design allows easy loading of crimping dies and connectors, saves time
- Rubber boot on crimp head provides abrasion protection
- Audible “pop-off” valve indicates crimp completion

- Uses color-coded crimping dies to provide easy matching of crimping die to connector
- Embosses die index number on connector barrels to provide post crimp inspection

C1.
Wiring
Duct

- Tool provided with two, NiCd rechargeable batteries and battery charger to allow for continuous operation
- High productivity, up to 35 crimps on 500 kcmil copper lugs and splices on a single battery charge

- Dies installed using spring loaded die retention pins, no need for tools

C2.
Surface
Raceway

- Eight second crimp cycle time provides quick terminations, saves time

- Crimp head rotates 180 degrees to provide versatility for use in restricted spaces

C3.
Abrasion
Protection



C4.
Cable
Management

D1.
Terminals

D2.
Power
Connectors

D3.
Grounding
Connectors

E1.
Labeling
Systems

E2.
Labels

E3.
Pre-Printed
& Write-On
Markers

E4.
Permanent
Identification

E5.
Lockout/
Tagout
& Safety
Solutions

F.
Index

| Part Number | Part Description | Std. Pkg. Qty. |
|----------------|---|----------------|
| CT-2940 | <p>Terminates <i>PANDUIT® PAN-LUG™</i> Compression Connectors:</p> <ul style="list-style-type: none"> • Copper compression lugs and splices for #8 AWG – 1000 kcmil code conductor • Copper compression lugs and splices for #8 AWG – 777.7 kcmil flex conductor • Copper compression CTAPF taps for #10 – 3/0 AWG code conductor • Copper compression CTAP taps for #8 – 4/0 AWG code conductor • Copper compression HTCT taps for #14 AWG – 1000 kcmil code conductor and #14 AWG – 777.7 kcmil flex conductor • Aluminum compression lugs and splices for #6 AWG – 1000 kcmil code conductor • Aluminum compression HTAP taps for #14 AWG – 500 kcmil code conductor • <i>PANDUIT® PAN-TERM®</i> Tubular Terminals for #8 AWG – 250 kcmil code conductor <p>Specifications: Output: 15 tons Jaw opening: 2" Weight: 24.25 lbs. with battery Length: 21" Height: 10.5" Width: 3.75" Warranty: 5 years tool, 1 year on batteries</p> <p>CT-2940 includes:</p> <ul style="list-style-type: none"> • Tool • Two CT-BC25, 14.4 VDC rechargeable batteries with LED display • One CT-CHR25 battery charger • Shoulder strap • Plastic case for storage of crimping dies • Plastic tool case with storage for batteries, charger, shoulder strap and crimping die storage case | 1 |

Uses CD-920 and CD-930 color-coded crimping dies with CD-940-DA die adapter. Uses CD-940 color-coded crimping dies. Dies and die adapter must be purchased separately, see pages D3.46, D3.47. For battery charger and battery accessories, see page D3.51.

Die Type, Remote Hydraulic, 14 Ton, Crimp Head

- Develops 14 tons of crimping force when used with 10,000 psi hydraulic pump and hose, crimps copper compression lugs and splices up to 750 kcmil
- Incorporates Parker type quick-connect fittings to ease installation and save time
- High quality, durable tool construction provides long-term dependability
- Provides UL Listed and CSA Certified connections on *PANDUIT® PAN-LUG™* Copper and Aluminum Lugs and Splices and Copper Taps
- Open “C-Head” design allows easy loading of crimping dies and connectors, saves time
- Uses color-coded crimping dies to provide easy matching of crimping die to connector
- Embosses die index number on connector barrels for post crimp inspection
- Dies installed using spring loaded die retention pins, no need for tools
- Cast in handle allows crimp head to be mounted in a bench vice



| Part Number | Part Description | Std. Pkg. Qty. |
|-------------|--|----------------|
| CT-930CH | <p>Terminates <i>PANDUIT® PAN-LUG™</i> Compression Connectors:</p> <ul style="list-style-type: none"> • Copper compression lugs and splices for #8 AWG – 750 kcmil code conductor • Copper compression lugs and splices for #8 AWG – 600 kcmil flex conductor • Copper compression CTAPF taps for #10 – 3/0 AWG code conductor • Copper compression CTAP taps for #8 – 4/0 AWG code conductor • Copper compression HTCT taps for #14 AWG – 250 kcmil code conductor, #14 – 4/0 AWG flex conductor • Aluminum compression lugs and splices for #6 AWG – 600 kcmil code conductor • Aluminum compression HTAPs for #14 AWG – 500 kcmil code conductor • <i>PANDUIT® PAN-TERM®</i> Tubular Terminals for #8 AWG – 250 kcmil code conductor <p>Use with <i>PANDUIT</i> CT-901 hydraulic pump and CT-900HPH 10' hydraulic hose.*</p> <p>Specifications: Output: 14 tons Jaw opening: 1.65" Weight: 11 lbs. Length: 12 1/4" Height: 5" Width: 3" Warranty: 5 years</p> <p>CT-930CH includes: • Tool • Steel tool case • Supplied with female Parker type quick-connect fitting assembled to tool</p> | 1 |

Uses CD-920 and CD-930 color-coded crimping dies. Dies must be purchased separately, see page D3.46.
 *CT-901RCH remote control handle available, offering one hand operation of crimp head with *PANDUIT* CT-901HP hydraulic pump and CT-900HPH hose, sold separately, see page D3.43. CG-920 crimp force measurement gauge available, sold separately, see page D3.51.

A.
System
Overview

B1.
Cable Ties

B2.
Cable
Accessories

B3.
Stainless
Steel Ties

C1.
Wiring
Duct

C2.
Surface
Raceway

C3.
Abrasion
Protection

C4.
Cable
Management

D1.
Terminals

D2.
Power
Connectors

D3.
Grounding
Connectors

E1.
Labeling
Systems

E2.
Labels

E3.
Pre-Printed
& Write-On
Markers

E4.
Permanent
Identification

E5.
Lockout/
Tagout
& Safety
Solutions

F.
Index

A.
System
Overview

Die Type, Remote Hydraulic, 15 Ton, Crimp Head

B1.
Cable Ties

- Develops 15 tons of crimping force when used with 10,000 psi hydraulic pump and hose, crimps copper compression lugs and splices up to 1,000 kcmil

- Open “C-Head” design allows easy loading of crimping dies and connectors, saves time

B2.
Cable
Accessories

- Incorporates Parker type quick-connect fittings to ease installation and save time
- High quality, durable tool construction provides long-term dependability

- Uses color-coded crimping dies to provide easy matching of crimping die to connector

B3.
Stainless
Steel Ties

- Provides UL Listed and CSA Certified connections on *PANDUIT® PAN-LUG™* Copper and Aluminum Lugs and Splices and Copper Taps

- Embosses die index number on connector barrels for post crimp inspection
- Dies installed using spring loaded die retention pins, no need for tools
- Cast in handle allows crimp head to be mounted in a bench vice

C1.
Wiring
Duct



C2.
Surface
Raceway

C3.
Abrasion
Protection

C4.
Cable
Management

D1.
Terminals

D2.
Power
Connectors

D3.
Grounding
Connectors

E1.
Labeling
Systems

E2.
Labels

E3.
Pre-Printed
& Write-On
Markers

E4.
Permanent
Identification

E5.
Lockout/
Tagout/
& Safety
Solutions

F.
Index

| Part Number | Part Description | Std. Pkg. Qty. |
|-----------------|--|----------------|
| CT-940CH | <p>Terminates <i>PANDUIT® PAN-LUG™</i> Compression Connectors:</p> <ul style="list-style-type: none"> • Copper compression lugs and splices for #8 AWG – 1000 kcmil code conductor • Copper compression lugs and splices for #8 AWG – 777.7 kcmil flex conductor • Copper compression CTAPF taps for #10 – 3/0 AWG code conductor • Copper compression CTAP taps for #8 – 4/0 AWG code conductor • Copper compression HTCT taps for #14 AWG – 1000 kcmil code conductor and #14 AWG – 777.7 kcmil flex conductor • Aluminum compression lugs and splices for #6 AWG – 1000 kcmil code conductor • Aluminum compression HTAP taps for #14 AWG – 500 kcmil code conductor • <i>PANDUIT® PAN-TERM®</i> Tubular Terminals for #8 AWG – 250 kcmil code conductor <p>Use with <i>PANDUIT</i> CT-901 hydraulic pump and CT-900HPH 10' hydraulic hose.*</p> <p>Specifications: Output: 15 tons</p> <p>Jaw opening: 2" Weight: 14.5 lbs. Length: 14.5" Height: 4.1" Width: 2.5" Warranty: 5 years</p> <p>CT-940CH includes:</p> <ul style="list-style-type: none"> • Tool • Steel tool case • Supplied with female Parker type quick-connect fitting assembled to tool | 1 |

Uses CD-920 and CD-930 color-coded crimping dies with CD-940-DA die adapter. Uses color-coded CD-940 crimping dies. Crimping dies and die adapter must be purchased separately, see pages D3.46 and D3.47. CG-940 crimp force measurement gauge available, sold separately, see page D3.51.

*CT-901RCH remote control handle available, offering one hand operation of crimp head with *PANDUIT* CT-901HP hydraulic pump and CT-900HPH hose, sold separately, see page D3.43.

Hydraulic Pump and Accessories, Electric, 10,000 PSI

- Develops 10,000 psi of hydraulic pressure
- Easy to operate using manual switch or remote pendant supplied; or optional CT-901RFS foot switch or CT-901RCH remote controlled handle
- Factory set relief valve, pump stops when crimp is complete
- Convenient 120 VAC operation
- Incorporates Parker type quick-connect fittings to ease installation and save time
- Versatile, can be used with *PANDUIT* CT-930CH, CT-940CH, or CT-980CH crimp heads



CT-901HP



CT-900HPH



CT-901RCH



CT-901RFS

| Part Number | Part Description | Std. Pkg. Qty. |
|-------------|---|----------------|
| CT-901HP | <p>Hydraulic pump. Develops 10,000 PSI output. Pump shuts off when cycle is complete. Will not release until down switch is activated. Compatible with CT-900HPH hydraulic hose, CT-930CH, CT-940CH, and CT-980CH crimp heads sold separately.*</p> <p>Specifications: Pump output: 10,000 psi Tank capacity: 2.5L incorporates sight gauge for visual inspection of fluid level Fluid type: Aero Shell #4 or equal Motor: 120 VAC 50/50Hz Current: 6.5 Amps Horsepower: 1/2 hp Weight: 34 lbs. Length: 7" Height: 14" Width: 6" Warranty: 5 years</p> <p>CT-901HP pump includes: • On/off pendant switch on 10' electric cord • Three prong A/C plug on 10' electric cord • Supplied with female Parker type quick-connect fitting assembled to pump</p> | 1 |
| CT-900HPH | Electrically non-conductive 10' hose compatible with <i>PANDUIT</i> CT-901HP hydraulic pump and CT-930CH, CT-940CH, and CT-980CH crimp heads, supplied pre-filled with hydraulic fluid for fast start up. Supplied with two male Parker type quick-connect fittings. Warranty: 5 years | 1 |
| CT-901RCH | Remote control handle provides plastic carrying handle incorporating on/off activation switch that allows operator to hold crimp head and activate CT-901HP hydraulic pump with one hand. Use with <i>PANDUIT</i> remote hydraulic crimp heads CT-930CH, CT-940CH, and CT-980CH. Equipped with 3/8" Parker type quick-connect coupler for attaching crimp heads to <i>PANDUIT</i> CT-900HPH hydraulic hose. Includes a 10', three wire control cable that can be directly connected to the CT-901HP pump. Warranty: 5 years | 1 |
| CT-901RFS | Dual electrical foot switch that allows convenient "hands free" operation of the <i>PANDUIT</i> CT-901HP or CT-8250HP electric hydraulic pumps used with <i>PANDUIT</i> remote hydraulic crimp heads. Supplied with 10' electric cord that can be directly connected to <i>PANDUIT</i> hydraulic pumps. Warranty: 5 years | 1 |

Contact *PANDUIT* Customer Service for use in production environments.
 *For information on crimp heads, see pages D3.41, D3.42, and D3.50.

A. System Overview

B1. Cable Ties

B2. Cable Accessories

B3. Stainless Steel Ties

C1. Wiring Duct

C2. Surface Raceway

C3. Abrasion Protection

C4. Cable Management

D1. Terminals

D2. Power Connectors

D3. Grounding Connectors

E1. Labeling Systems

E2. Labels

E3. Pre-Printed & Write-On Markers

E4. Permanent Identification

E5. Lockout/Tagout & Safety Solutions

F. Index

A.
System
Overview

Die Type, Remote Hydraulic, 10.5 Ton, Crimp Head

B1.
Cable Ties

- Low pressure system extends life of crimp head for high volume crimping applications

- Open “C-Head” design allows easy loading of crimping dies and connectors, saves time

B2.
Cable
Accessories

- Develops 10.5 tons of crimping force when used with 7,500 psi hydraulic pump and hose, crimps copper compression lugs and splices up to 250 kcmil
- Incorporates Parker type quick-connect fittings to ease installation and save time

- Uses color-coded crimping dies to provide easy matching of crimping die to connector

B3.
Stainless
Steel Ties

- High quality, durable tool construction and low pressure hydraulic requirements provide long-term dependability and tool life
- Provides UL Listed and CSA Certified connections on *PANDUIT® PAN-LUG™* Copper Lugs and Splices

- Embosses die index number on connector barrels for post crimp inspection

- Dies installed using spring loaded die retention pins, no need for tools

- Cast in handle allows crimp head to be mounted in a bench vice

C1.
Wiring
Duct



C2.
Surface
Raceway

C3.
Abrasion
Protection

C4.
Cable
Management

D1.
Terminals

D2.
Power
Connectors

D3.
Grounding
Connectors

E1.
Labeling
Systems

E2.
Labels

E3.
Pre-Printed
& Write-On
Markers

E4.
Permanent
Identification

E5.
Lockout/
Tagout/
& Safety
Solutions

F.
Index

| Part Number | Part Description | Std. Pkg. Qty. |
|-------------------|--|----------------|
| CT-930LPCH | <p>Remote hydraulic crimp head provides UL Listed or Recognized terminations of <i>PANDUIT® PAN-LUG™</i> Copper Compression Lugs and Splices for #8 AWG – 250 kcmil copper code conductor.</p> <p>Use with <i>PANDUIT</i> CT-8250HP hydraulic pump and CT-900LPHPH 10' hydraulic hose.*</p> <p>Specifications: Output: 10.5 tons Jaw opening: 1.65" Weight: 11 lbs. Length: 12 1/4" Height: 5" Width: 3" Warranty: 5 years</p> <p>CT-930LPCH includes: • Tool • Steel tool case • Supplied with male Parker type quick-connect fitting assembled to tool</p> | 1 |

Uses CD-920 color-coded crimping dies. Dies must be purchased separately, see page D3.46. PG-1 in-line pressure gauge provides visual measurement of hydraulic output pressure, sold separately, see page D3.51.

*For information on hydraulic pump and hose, see page D3.45.

Hydraulic Pump and Accessories, Electric, 7,500 PSI

- Develops 7,500 psi of hydraulic pressure
- Easy to operate using manual switch or remote pendant supplied; or optional CT-901RFS foot switch
- Factory set relief valve, pump stops when crimp is complete
- Convenient 120 VAC operation
- Incorporates Parker type quick-connect fittings to ease installation and save time
- Versatile, can be used with *PANDUIT* CT-930LPCH or CT-980LPCH crimp heads



CT-8250HP



CT-900LPHPH



CT-901RFS

| Part Number | Part Description | Std. Pkg. Qty. |
|-------------|--|----------------|
| CT-8250HP | <p>Hydraulic pump. Develops 7,500 psi output. Pump shuts off when cycle is complete. Will not release until down switch is activated. Compatible with CT-900LPHPH hydraulic hose, CT-930LPCH, and CT-980LPCH crimp heads sold separately.*</p> <p>Specifications: Pump output: 7,500 psi Tank capacity: 2.5L incorporates sight gauge for visual inspection of fluid level Fluid type: Aero Shell #4 or equal Motor: 120 VAC 50/50Hz Current: 6.5 Amps Horsepower: 1/2 hp Warranty: 5 years</p> <p>Weight: 34 lbs. Length: 7" Height: 14" Width: 6"</p> <p>CT-8250HP pump includes: • On/off pendant switch on 10' electric cord • Three prong A/C plug on 10' electric cord • Supplied with male Parker type quick-connect fitting assembled to pump</p> | 1 |
| CT-900LPHPH | Electrically non-conductive 10' hose compatible with <i>PANDUIT</i> CT-8250HP hydraulic pump and CT-930LPCH and CT-980LPCH crimp heads, supplied pre-filled with hydraulic fluid for fast start up. Supplied with two female Parker type quick-connect fittings. Warranty: 5 years | 1 |
| CT-901RFS | Dual electrical foot switch that allows convenient "hands free" operation of the <i>PANDUIT</i> CT-901HP or CT-8250HP electric hydraulic pumps used with <i>PANDUIT</i> remote hydraulic crimp heads. Supplied with 10' electric cord that can be directly connected to <i>PANDUIT</i> hydraulic pumps. Warranty: 5 years | 1 |

*For more information on crimp heads, see pages D3.44 and D3.50.

PG-1 in-line pressure gauge provides visual measurement of hydraulic output pressure, sold separately, see page D3.51.

A. System Overview

B1. Cable Ties

B2. Cable Accessories

B3. Stainless Steel Ties

C1. Wiring Duct

C2. Surface Raceway

C3. Abrasion Protection

C4. Cable Management

D1. Terminals

D2. Power Connectors

D3. Grounding Connectors

E1. Labeling Systems

E2. Labels

E3. Pre-Printed & Write-On Markers

E4. Permanent Identification

E5. Lockout/Tagout & Safety Solutions

F. Index

A. System Overview

CD-920 Crimping Dies

B1. Cable Ties

- Color-coded for easy matching to color-coding marked on connectors
- Embosses die index number on connector barrels for post crimp inspection

- Part number permanently marked on crimping die for easy identification
- Provides circumferential crimp results in terminations with premium electrical and mechanical performance

B2. Cable Accessories



CD-920

B3. Stainless Steel Ties

C1. Wiring Duct

C2. Surface Raceway



C3. Abrasion Protection

C4. Cable Management

D1. Terminals



CD-930H

D2. Power Connectors

D3. Grounding Connectors

E1. Labeling Systems



E2. Labels

E3. Pre-Printed & Write-On Markers

E4. Permanent Identification



CDM-920

E5. Lockout/Tagout & Safety Solutions

F. Index

| Part Number | Used to Install <i>PANDUIT</i> Compression Lug and Splice Sizes | | | | Std. Pkg. Qty. |
|--------------------|---|------------------------------|-------------------------|--------------------------------|----------------|
| | Copper Conductor Size Code | Copper Die Color and Die No. | Aluminum Code Size Code | Aluminum Die Color and Die No. | |
| CD-920-8 | #8 AWG | Red P21 | — | — | 1 |
| CD-920-6 | #6 AWG | Blue P24 | — | — | 1 |
| CD-920-4 | #4 AWG | Gray P29 | #6 AWG | Gray P29 | 1 |
| CD-920-2 | #2 AWG | Brown P33 | — | — | 1 |
| CD-920-1 | #1 AWG | Green P37 | #4 AWG | Green P37 | 1 |
| CD-920-1/0 | 1/0 AWG | Pink P42 | #2 AWG | Pink P42 | 1 |
| CD-920-2/0 | 2/0 AWG | Black P45 | #1 AWG | Gold P45 | 1 |
| CD-920-3/0 | 3/0 AWG | Orange P50 | 1/0 AWG | Tan P50 | 1 |
| CD-920-4/0 | 4/0 AWG | Purple P54 | 2/0 AWG | Olive P54 | 1 |
| CD-920-250 | 250 kcmil | Yellow P62 | 3/0 AWG | Ruby P62 | 1 |
| CD-920-300 | 300 kcmil | White P66 | 4/0 AWG | White P66 | 1 |
| CD-920-350 | 350 kcmil | Red P71 | 250 kcmil | Red P71 | 1 |
| CD-920-400 | 400 kcmil | Blue P76 | 300 kcmil | Blue P76 | 1 |
| CD-920-500 | 500 kcmil | Brown P87 | 350 kcmil | Brown P87 | 1 |
| CD-920-600 | 600 kcmil | Green P94 | 400 kcmil | Green P94 | 1 |
| CD-920-500A | 500 kcmil flex, 600 kcmil flex | Pink P99 | 500 kcmil | Pink P99 | 1 |
| CD-920-750 | 750 kcmil | Black P106 | 600 kcmil | Black P106 | 1 |

| Part Number | Used to Install <i>PANDUIT</i> Tap Part Numbers | | | | Std. Pkg. Qty. |
|--------------------------|---|------------------------------|---|----------------------------|----------------|
| | Copper Tap | Copper Die Color and Die No. | Aluminum Tap | Aluminum Die Color and No. | |
| Single Crimp Dies | | | | | |
| CD-920H-8 | HTCT8-8-1 | Green PH8 | — | — | 1 |
| CD-920H-6 | HTCT6-6-1 | Orange PH6 | — | — | 1 |
| CD-920H-2 | HTCT2-2-1 | Brown PH2 | — | — | 1 |
| CD-930H-250 | HTCT250-8-1, HTCT250-2-1, HTCT250-250-1 | Purple PH25 | — | — | 1 |
| CD-920-3/0 | — | — | HTAP2-8-L | Tan P50 | 1 |
| CD-920-BG | CTAP4-8-L, CTAP4-6-L, CTAP4-4-L | PBG | — | — | 1 |
| CD-920-C | CTAP2-4-Q, CTAP2-2-X | PC | — | — | 1 |
| CD-920-D3 | CTAP4/0-2-X, CTAP4/0-2/0-X, CTAP4/0-4/0-X | PD3 | HTAP3/0-1-Q, HTAP3/0-3/0-Q, HTAP4/0-2-Q, HTAP4/0-3/0-Q, HTAP4/0-4/0-Q | PD3 | 1 |
| CD-920-O | CTAP2/0-2-X, CTAP2/0-2/0-X | PO | HTAP1-1-Q, HTAP1/0-1-Q, HTAP2/0-1-Q | PO | 1 |

Multi-Crimp Dies

| | | | | | |
|--------------------|---------------|-------------|---|---|---|
| CDM-920-2 | CTAPF4-12-C | Brown P33M | — | — | 1 |
| CDM-920-1 | CTAPF3-12-C | Green P37M | — | — | 1 |
| CDM-920-1/0 | CTAPF2-12-C | Pink P42M | — | — | 1 |
| CDM-920-2/0 | CTAPF1-12-C | Black P45M | — | — | 1 |
| CDM-920-3/0 | CTAPF1/0-12-L | Orange P50M | — | — | 1 |
| CDM-920-4/0 | CTAPF2/0-12-Q | Purple P54M | — | — | 1 |
| CDM-920-250 | CTAPF3/0-12-Q | Yellow P62M | — | — | 1 |

See pages D3.52 – D3.90 for connector and tool selection information.

CD-940 Crimping Dies

- Color-coded for easy matching to color-coding marked on connectors
- Embosses die index number on connector barrels for post crimp inspection
- Part number permanently marked on crimping die for easy identification
- Provides circumferential crimp results in terminations with premium electrical and mechanical performance



CD-940



CD-940-DA

| Part Number | Used to Install <i>PANDUIT</i> Compression Lug and Splice Sizes | | | | Std. Pkg. Qty. |
|--------------|---|------------------------------|-------------------------|--------------------------------|----------------|
| | Copper Conductor Size | Copper Die Color and Die No. | Aluminum Conductor Size | Aluminum Die Color and Die No. | |
| CD-940-750 | 750 kcmil | Black P106 | — | — | 1 |
| CD-940-800 | 800 kcmil | Orange P107 | — | — | 1 |
| CD-940-1000 | 1000 kcmil | White P125 | — | — | 1 |
| CD-940-750X | 777.7 kcmil flex | Yellow P115 | — | — | 1 |
| CD-940-750A | — | — | 750 kcmil | Red P125 | 1 |
| CD-940-800A | — | — | 800 kcmil | Gray P140 | 1 |
| CD-940-1000A | — | — | 1000 kcmil | Brown P161 | 1 |

| Part Number | Used to Install <i>PANDUIT</i> Tap Part Numbers | | | | Std. Pkg. Qty. |
|--------------|---|------------------------------|------------------------------|--------------------------------|----------------|
| | Copper Tap | Copper Die Color and Die No. | Aluminum Tap | Aluminum Die Color and Die No. | |
| CD-940-N | — | — | HTAP500-500-X, HTAP500-4/0-X | PN | 1 |
| CD-940H-500 | HTCT500-250-1, HTCT500-500-1 | Brown PH50 | — | — | 1 |
| CD-940H-750 | HTCT750-4/0-1, HTCT750-750-1, HTCT1000-250-1 | Yellow PH75 | — | — | 1 |
| CD-940H-1000 | HTCT1000-1000-1 | White PH10 | — | — | 1 |

See pages D3.52 – D3.90 for connector and tool selection information.

| Part Number | Part Description | Std. Pkg. Qty. |
|-------------|---|----------------|
| CD-940-DA | Die adapter for use with <i>PANDUIT</i> CT-940CH and CT-2940 crimping tools required for installation of <i>PANDUIT</i> CD-920, CDM-920, and CD-930 crimping dies in these tools. | 1 |

A. System Overview

B1. Cable Ties

B2. Cable Accessories

B3. Stainless Steel Ties

C1. Wiring Duct

C2. Surface Raceway

C3. Abrasion Protection

C4. Cable Management

D1. Terminals

D2. Power Connectors

D3. Grounding Connectors

E1. Labeling Systems

E2. Labels

E3. Pre-Printed & Write-On Markers

E4. Permanent Identification

E5. Lockout/Tagout & Safety Solutions

F. Index

A.
System
Overview

UNI-DIE™ Dieless, Manual Hydraulic, 6.2 Ton, Crimping Tool

B1.
Cable Ties

- Dieless crimping tool design eliminates purchase or lost crimping dies, saves cost

- Provides UL Listed and CSA Certified connections on *PANDUIT® PAN-LUG™* Copper Lugs and Splices

B2.
Cable
Accessories

- Develops 6.2 tons of crimping force with four point indenter system, crimps copper compression lugs and splices up to 750 kcmil

- Provides UL Listed and CSA Certified wire range-taking capability on *PANDUIT® PAN-LUG™* Copper Lugs and Splices, minimizes connector inventory and saves cost

B3.
Stainless
Steel Ties

- Two-stage rapid advance hydraulic system minimizes number of pumps required to complete a crimp

- Flip-top crimp head design allows easy loading of connectors, saves time

- High quality, durable tool construction provides long-term dependability

- Audible “pop-off” valve indicates crimp completion

- Cushioned grips prevent hands from slipping on tool, reduces fatigue

- Crimp head rotates 360 degrees, provides versatility for use in restricted spaces

C1.
Wiring
Duct

- Incorporates aluminum crimp head and fiberglass handles, results in lightweight tool and ease of operation

C2.
Surface
Raceway



C3.
Abrasion
Protection

C4.
Cable
Management

D1.
Terminals

D2.
Power
Connectors

D3.
Grounding
Connectors

E1.
Labeling
Systems

E2.
Labels

E3.
Pre-Printed
& Write-On
Markers

E4.
Permanent
Identification

E5.
Lockout/
Tagout/
& Safety
Solutions

F.
Index

| Part Number | Part Description | Std. Pkg. Qty. |
|-------------|---|----------------|
| CT-980 | <p>Manual hydraulic <i>UNI-DIE™</i> Dieless Crimping Tool provides UL Listed or Recognized and CSA Certified terminations of <i>PANDUIT® PAN-LUG™</i> Copper Compression Lugs and Splices for #4 AWG – 750 kcmil copper code conductor.</p> <p>Specifications: Output: 6.2 tons Jaw opening: 1.46" Weight: 10.5 lbs. Length: 13" Height: 12" Width: 3" Handle span: 15" (open), 5.75" (closed) Warranty: 5 years</p> <p>CT-980 includes: • Tool • Plastic tool case</p> | 1 |

CG-980 pressure gauge for measuring tool output force available, sold separately, see page D3.51.

UNI-DIE™ Dieless, Battery Powered Hydraulic, 6.2 Ton, Crimping Tool, 12 VDC

- Dieless crimping tool design eliminates purchase or lost crimping dies, saves cost
- Battery powered, provides fingertip operation
- Self-contained unit, completely portable
- Develops 6.2 tons of crimping force with four point indenter system, crimps copper compression lugs and splices up to 750 kcmil
- Two-stage rapid advance hydraulic system minimizes cycle time
- Ram automatically retracts when crimp cycle is complete
- Tool provided with two, high capacity 12 VDC rechargeable nickel-metal hydride batteries to provide for continuous operation and eliminate "memory" build-up, one hour charge time
- Uses industry standard MAKITA* batteries and charger, industry proven reliability and easy to obtain from local retail sources
- Provides UL Listed and CSA Certified connections on PANDUIT® PAN-LUG™ Copper Lugs and Splices
- Provides UL Listed and CSA Certified wire range-taking capability on PANDUIT® PAN-LUG™ Copper Lugs and Splices, minimizes connector inventory and saves cost
- Flip-top crimp head design allows easy loading of splices, saves time
- Crimp head rotates 360 degrees, provides versatility for use in restricted spaces



| Part Number | Part Description | Std. Pkg. Qty. |
|-------------|--|----------------|
| CT-2981 | <p>Battery powered hydraulic UNI-DIE™ Dieless Crimping Tool provides UL Listed or Recognized and CSA Certified terminations of PANDUIT® PAN-LUG™ Copper Compression Lugs and Splices for #4 AWG – 750 kcmil copper code conductor.</p> <p>Specifications: Output: 6.2 tons Jaw opening: 1.46" Weight: 10.8 lbs. with battery Length: 13" Height: 12" Width: 3" Warranty: 3 years</p> <p>CT-2981 includes: • Tool • Two 12 VDC, NiMH rechargeable batteries • One battery charger • Steel tool case with storage for batteries, charger, and crimping dies</p> | 1 |
| SS-1 | Test solder slugs. | 1 |
| SS-1GAGE | Solder slug measurement gauge. | 1 |

CG-980 crimp force measurement gauge available, sold separately, see page D3.51.

*MAKITA is a registered trademark of Makita Corporation.

A.
System
Overview

B1.
Cable Ties

B2.
Cable
Accessories

B3.
Stainless
Steel Ties

C1.
Wiring
Duct

C2.
Surface
Raceway

C3.
Abrasion
Protection

C4.
Cable
Management

D1.
Terminals

D2.
Power
Connectors

D3.
Grounding
Connectors

E1.
Labeling
Systems

E2.
Labels

E3.
Pre-Printed
& Write-On
Markers

E4.
Permanent
Identification

E5.
Lockout/
Tagout
& Safety
Solutions

F.
Index

A. System Overview

UNI-DIE™ Dieless, Remote Hydraulic, 6.2 Ton, Crimp Head

B1. Cable Ties

- Dieless crimping tool design eliminates purchase or lost crimping dies, saves cost
- Develops 6.2 tons of crimping force when used with 10,000 psi hydraulic pump and hose, crimps copper compression lugs and splices up to 750 kcmil

- Provides UL Listed and CSA Certified connections on *PANDUIT® PAN-LUG™* Copper Lugs and Splices
- Provides UL Listed and CSA Certified wire range-taking capability on *PANDUIT® PAN-LUG™* Copper Lugs and Splices, minimizes connector inventory and saves cost

B2. Cable Accessories

- Incorporates Parker type quick-connect fittings to ease installation and save time

- Flip-top crimp head design allows easy loading of splices, saves time

B3. Stainless Steel Ties



C1. Wiring Duct

C2. Surface Raceway

C3. Abrasion Protection

C4. Cable Management

| Part Number | Part Description | Std. Pkg. Qty. |
|-------------|--|----------------|
| CT-980CH | Remote hydraulic <i>UNI-DIE™</i> dieless crimp head provides UL Listed or Recognized and CSA Certified terminations of <i>PANDUIT® PAN-LUG™</i> Copper Compression Lugs and Splices for #4 AWG – 750 kcmil copper code conductor. Use with <i>PANDUIT</i> CT-901HP hydraulic pump and CT-900HPH 10' hydraulic hose.* Specifications: Output: 6.2 tons Jaw opening: 1.46" Weight: 6.5 lbs. Length: 10.5" Height: 5.3" Width: 2.5" Warranty: 5 years CT-980CH includes: • Tool • Steel tool case • Supplied with female Parker type quick-connect fitting assembled to tool | 1 |

*CT-901RCH remote control handle available, offering one hand operation of crimp head with *PANDUIT* CT-901HP hydraulic pump and CT-900HPH hose, sold separately, see page D3.43. CG-980 crimp force measurement gauge available, sold separately, see page D3.51.

D1. Terminals

UNI-DIE™ Dieless, Remote Hydraulic, 4.7 Ton, Crimp Head

D2. Power Connectors

- Low pressure system extends life of crimp head for high volume crimping application

- Incorporates Parker type quick-connect fittings to ease installation and save time

D3. Grounding Connectors

- Dieless crimping tool design eliminates purchase or lost crimping dies, saves cost
- Develops 4.7 tons of crimping force when used with 7,500 psi hydraulic pump and hose, crimps copper compression lugs and splices up to 250 kcmil

- Provides UL Listed and CSA Certified connections on *PANDUIT® PAN-LUG™* Copper Lugs and Splices
- Flip-top crimp head design allows easy loading of splices, saves time

E1. Labeling Systems



E2. Labels

E3. Pre-Printed & Write-On Markers

E4. Permanent Identification

E5. Lockout/Tagout & Safety Solutions

| Part Number | Part Description | Std. Pkg. Qty. |
|-------------|---|----------------|
| CT-980LPCH | Remote hydraulic crimp head provides UL Listed or Recognized and CSA Certified terminations of <i>PANDUIT® PAN-LUG™</i> Copper Compression Lugs and Splices for #4 AWG – 250 kcmil code conductor. Use with <i>PANDUIT</i> CT-8250HP hydraulic pump and CT-900LPHPH 10' hydraulic hose.* Specifications: Output: 4.7 tons Weight: 6.5 lbs. Length: 10.5" with coupler Height: 5.3" Width: 2.5" Warranty: 5 years CT-980LPCH includes: • Tool • Steel tool case • Supplied with male Parker type quick-connect fitting assembled to tool | 1 |

PG-1SC in-line pressure gauge provides visual measurement of hydraulic output pressure, sold separately, see page D3.51.

*For information on hydraulic pump and hose, see page D3.45.

F. Index

Pressure Gauges

- Provide easy visual reading of output force for hydraulic crimping tools
- Factory calibrated to provide accuracy and quality assurance control of crimping tools in the field
- Easy-to-read crimp force tolerance zone for applicable tools marked on gauge
- Blank dies for fixture supplied with test gauge for easy mounting and operation of gauge with crimping tool

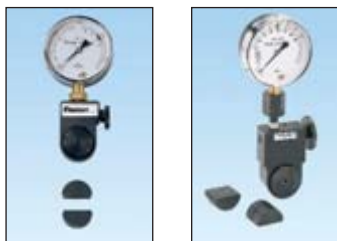

CG-920

CG-940



CG-980



PG-1

| Part Number | Part Description | Std. Pkg. Qty. |
|-------------|--|----------------|
| CG-920 | Compression gauge – used to measure crimping force generated by <i>PANDUIT</i> crimping tools: CT-930, CT-930CH, CT-930LPCH, CT-2930 and CT-2931. CG-920 includes: • Pressure gauge • Blank die set • Steel storage case • Warranty: 90 days | 1 |
| CG-940 | Compression gauge – used to measure output force generated by <i>PANDUIT</i> crimping tools: CT-940CH and CT-2940. CG-940 includes: • Pressure gauge • Blank die set • Steel storage case • Warranty: 90 days | 1 |
| CG-980 | Compression gauge – used to insure proper compression force for <i>UNI-DIE™</i> Dieless Crimping Tools: CT-980, CT-980CH, CT-2980 and CT-2981. CG-980 includes: • Pressure gauge • Fixture for mounting gauge in crimping tool • Steel storage case • Warranty: 90 days | 1 |
| PG-1 | In-line pressure gauge provides visual identification of hydraulic output pressure when used with <i>PANDUIT</i> CT-930CH, CT-940CH, and CT-980CH crimp heads, CT-901HP pump and CT-900HPH hose. Includes steel storage case. Warranty: 90 days | 1 |
| PG-1SC | In-line pressure gauge provides visual identification of hydraulic output pressure when used with <i>PANDUIT</i> CT-930LPCH and CT-980LPCH crimp heads, CT-8250HP pump and CT-900LPHPH hose. Includes steel storage case. Warranty: 90 days | 1 |

Accessories for Battery Powered Hydraulic Crimping Tools



CT-BC25



CT-NLBC25



CT-CHR25

| Part Number | Part Description | Std. Pkg. Qty. |
|-------------|---|----------------|
| CT-BC25 | Rechargeable 14.4 VDC NiCd battery with LED display to monitor remaining power and number of charge cycles. Battery life is approximately 1,000 recharge cycles. Use with <i>PANDUIT</i> battery operated crimping tools: CT-2001, CT-2002, CT-2930, CT-2980 and CT-2940. Warranty: 1 year | 1 |
| CT-NLBC25 | Rechargeable 14.4 VDC NiCd battery without LED display. Battery life is approximately 1,000 recharge cycles. Use with <i>PANDUIT</i> battery operated crimping tools: CT-2001, CT-2002, CT-2930, CT-2980 and CT-2940. Warranty: 5 years | 1 |
| CT-CHR25 | Battery charger designed to charge the CT-BC25 and CT-NLBC25 batteries in 25 minutes. Includes battery reconditioning feature to maximize battery life. LED display to visually indicate battery charge status. 120 VAC, 50/60Hz UL Listed. Use with <i>PANDUIT</i> battery powered crimping tools: CT-2001, CT-2002, CT-2930, CT-2980 and CT-2940. Warranty: 5 years | 1 |
| C-2001 | High impact strength, blow molded plastic case for CT-2001 crimping tool. Includes storage for CT-CHR25 battery charger, two CT-NLBC25 batteries, shoulder strap and crimping dies. | 1 |

A. System Overview

B1. Cable Ties

B2. Cable Accessories

B3. Stainless Steel Ties

C1. Wiring Duct

C2. Surface Raceway

C3. Abrasion Protection

C4. Cable Management

D1. Terminals

D2. Power Connectors

D3. Grounding Connectors

E1. Labeling Systems

E2. Labels

E3. Pre-Printed & Write-On Markers

E4. Permanent Identification

E5. Lockout/Tagout & Safety Solutions

F. Index

A. System Overview

B1. Cable Ties

For use with Copper Conductors

Installation Tooling and Die Selections for: Types LCAS and SCSS

How to read this chart

For LCA6 lug and CT-2001 crimping tool:

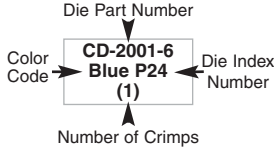

B2. Cable Accessories

B3. Stainless Steel Ties

PANDUIT (See Compression Connector Tools Selection Guide, Pages D3.30 – D3.32)

Thomas and Betts

C1. Wiring Duct

C2. Surface Raceway

C3. Abrasion Protection

C4. Cable Management

D1. Terminals

D2. Power Connectors

D3. Grounding Connectors

E1. Labeling Systems

E2. Labels

E3. Pre-Printed & Write-On Markers

E4. Permanent Identification

E5. Lockout/Tagout & Safety Solutions

F. Index

| PANDUIT Part Number | Std. Wire Size | Wire Strip Length (In.) | PANDUIT (See Compression Connector Tools Selection Guide, Pages D3.30 – D3.32) | | | | Thomas and Betts | | | | |
|-----------------------|----------------|-------------------------|--|-------------------------|---|--|----------------------------|----------------|---------------|---------------|--|
| | | | CT-1700 ^① | CT-720 | CT-920, CT-920CH, CT-930, CT-930CH, CT-2930, CT-930LPCH, CT-2931, CT-2940 ^③ , CT-2920, CT-940CH ^③ | Uni-Die™ CT-980, CT-2980, CT-980CH, CT-2981, CT-980LPCH, CT-2950 | CT-2001, CT-2002 | TBM20S, TBM25S | TBM5 | TBM8 | |
| L = Lug S = Splice | | | Die Part Number/Color Code and Die Index Number/(Number of Crimps) | | | | | | | | |
| LCAS8 | #8 AWG | 1/2 | Red P21 (2) | CD-720-1 Red P21 (1) | CD-920-8 Red P21 (1) | — | CD-2001-8 Red P21 (1) | Red 21 (2) | Red 21 (1) | Red 21 (1) | |
| SCSS8 | | 7/16 | | | | | | | | | |
| LCAS6 | #6 AWG | 9/16 | Blue P24 (2) | CD-720-1 Blue P24 (1) | CD-920-6 Blue P24 (1) | — | CD-2001-6 Blue P24 (1) | Blue 24 (2) | Blue 24 (1) | Blue 24 (1) | |
| SCSS6 | | 7/16 | | | | | | | | | |
| LCAS4 | #4 AWG | 5/8 | Gray P29 (2) | CD-720-1 Gray P29 (1) | CD-920-4 Gray P29 (1) | (1) | CD-2001-4 Gray P29 (1) | Gray 29 (2) | Gray 29 (2) | Gray 29 (2) | |
| SCSS4 | | 7/16 | | | | | | | | | |
| LCAS2 | #2 AWG | 5/8 | Brown P33 (2) | CD-720-1 Brown P33 (1) | CD-920-2 Brown P33 (1) | (1) | CD-2001-2 Brown P33 (1) | Brown 33 (2) | Brown 33 (2) | Brown 33 (2) | |
| SCSS2 | | 9/16 | | | | | | | | | |
| LCAS1 | #1 AWG | 11/16 | Green P37 (3) | CD-720-2 Green P37 (1) | CD-920-1 Green P37 (1) | (1) | CD-2001-1 Green P37 (1) | — | Green 37 (1) | Green 37 (1) | |
| SCSS1 | | | | | | | | | | | |
| LCAS1/0 | 1/0 AWG | 3/4 | — | CD-720-2 Pink P42 (1) | CD-920-1/0 Pink P42 (1) | (1) | CD-2001-1/0 Pink P42 (1) | — | Pink 42 (1) | Pink 42 (1) | |
| SCSS1/0 | | 11/16 | | | | | | | | | |
| LCAS2/0 | 2/0 AWG | 3/4 | — | CD-720-2 Black P45 (2) | CD-920-2/0 Black P45 (1) | (1) | CD-2001-2/0 Black P45 (2) | — | Black 45 (2) | Black 45 (2) | |
| SCSS2/0 | | | | | | | | | | | |
| LCAS3/0 | 3/0 AWG | 7/8 | — | CD-720-2 Orange P50 (2) | CD-920-3/0 Orange P50 (1) | (1) | CD-2001-3/0 Orange P50 (2) | — | Orange 50 (2) | Orange 50 (2) | |
| SCSS3/0 | | 3/4 | | | | | | | | | |
| LCAS4/0 | 4/0 AWG | 1 | — | CD-720-3 Purple P54 (2) | CD-920-4/0 Purple P54 (1) | (1) | CD-2001-4/0 Purple P54 (2) | — | Purple 54 (2) | Purple 54 (2) | |
| SCSS4/0 | | 13/16 | | | | | | | | | |
| LCAS250 | 250 kcmil | 1-1/8 | — | CD-720-3 Yellow P62 (2) | CD-920-250 Yellow P62 (1) | (1) | CD-2001-250 Yellow P62 (2) | — | Yellow 62 (2) | Yellow 62 (2) | |
| SCSS250 | | 1-1/16 | | | | | | | | | |

①The CT-1700 crimp die pockets are integrated into the tool frame.
 ③CD-920 dies can be used with CT-940CH and CT-2940 tools with the CD-940-DA adapter.

For use with
Copper
Conductors

Installation Tooling and Die Selections for: Types LCAS and SCSS (continued)

| Thomas and Betts | | | | Burndy | | | | Anderson | Penn-Union | Greenlee |
|--|-----------------------------|--|---------------------------------------|--------------------|---------|---|--|----------|------------|------------|
| TBM12, 13642M | TBM15, TBM15I, TBM15BSCR | TBM8-750M-I, TBM8-750, TBM8-750BSCR, TBM750BSCR ^④ | TBM14M, TBM14BSCR, BPLT14BSCR, 13100A | Y2MR, Y1MRTC, Y1MR | MY29 | Y35, Y35BH, Y39, Y39BH, Y45, Y46, Y750, Y750-2, Y750BH, Y750BH-2, Y750HS, PAT750, BAT750, BAT35 | Y644M, Y644HS, Y644MBH, PAT644, BAT644 | VC6 | TDY-1 | 1989 |
| Die Part Number/Color Code and Die Index Number/(Number of Crimps) | | | | | | | | | | |
| Red 21 (1) | Red 21 (1) | STD (1) | Red 21 (1) | Red (2) | #8 (1) | U8CRT Red 49 (1) | — | — | — | — |
| Blue 24 (1) | Blue 24 (1) | STD (1) | Blue 24 (1) | Blue (2) | #6 (1) | U5CRT Blue 7 (1) | STD (1) | STD (1) | — | — |
| Gray 29 (1) | Gray 29 (1) | STD (1) | Gray 29 (1) | Gray (2) | #4 (1) | U4CRT Gray 8 (1) | STD (1) | STD (1) | STD (1) | STD (1) |
| Brown 33 (1) | Brown 33 (1) | STD (1) | Brown 33 (1) | Brown (2) | #2 (1) | U2CRT Brown 10 (1) | STD (1) | STD (1) | STD (1) | STD (1) |
| Green 37 (1) | Green 37 (1) | STD (1) | Green 37 (1) | — | #1 (1) | U1CRT Green 11 (1) | STD (1) | STD (1) | STD (1) | STD (1) |
| Pink 42 (1) | Pink 42H ^② (2) | STD (1) | Pink 42H ^② (2) | — | 1/0 (1) | U25RT Pink 12 (1) | STD (1) | STD (1) | STD (1) | STD (1) |
| Black 45 (1) | Black 45 (1) | STD (1) | Black 45 (1) | — | 2/0 (1) | U26RT Black 13 (1) | STD (1) | STD (1) | STD (1) | STD (1) |
| Orange 50 (1) | Orange 50 (1) | STD (1) | Orange 50 (1) | — | 3/0 (1) | U27RT Orange 14 (1) | STD (1) | STD (1) | STD (1) | STD (1) |
| Purple 54 (1) | Purple 54H ^② (2) | STD (1) | Purple 54H ^② (2) | — | 4/0 (1) | U28RT Purple 15 (1) | STD (1) | STD (1) | STD (1) | STD (1) |
| Yellow 62 (1) | Yellow 62 (1) | STD (1) | Yellow 62 (1) | — | 250 (1) | U29RT Yellow 16 (1) | STD (1) | STD (2) | — | Yellow (2) |

②Half width dies.

④Minimum size: #4 AWG lugs and splices.

A.
System
Overview

B1.
Cable
Ties

B2.
Cable
Accessories

B3.
Stainless
Steel Ties

C1.
Wiring
Duct

C2.
Surface
Raceway

C3.
Abrasion
Protection

C4.
Cable
Management

D1.
Terminals

D2.
Power
Connectors

D3.
Grounding
Connectors

E1.
Labeling
Systems

E2.
Labels

E3.
Pre-Printed
& Write-On
Markers

E4.
Permanent
Identification

E5.
Lockout/
Tagout
& Safety
Solutions

F.
Index

A. System Overview

B1. Cable Ties

B2. Cable Accessories

B3. Stainless Steel Ties

C1. Wiring Duct

C2. Surface Raceway

C3. Abrasion Protection

C4. Cable Management

D1. Terminals

D2. Power Connectors

D3. Grounding Connectors

E1. Labeling Systems

E2. Labels

E3. Pre-Printed & Write-On Markers

E4. Permanent Identification

E5. Lockout/Tagout & Safety Solutions

F. Index

For use with Copper Conductors

Installation Tooling and Die Selections for: Types LCA, LCA^N, LCD, LCD^N and SCS

How to read this chart

For LCA6 lug and CT-2001 crimping tool:

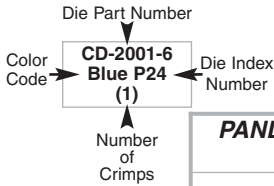

PANDUIT (See Compression Connector Tools Selection Guide, Pages D3.30 – D3.32)

Thomas and Betts

| PANDUIT Part Number | Std. Wire Size | Wire Strip Length (In.) | PANDUIT (See Compression Connector Tools Selection Guide, Pages D3.30 – D3.32) | | | | | | | Thomas and Betts | | | | |
|---|--------------------------------------|-------------------------|--|----------------------|----------------------|-------------------------|---|--|------------------|----------------------------|--------------|---------------|---------------|---|
| | | | CT-1570 | CT-1701 ^① | CT-1700 ^① | CT-720 | CT-920, CT-920CH, CT-930, CT-930CH, CT-930LPCH ^⑤ , CT-2920, CT-2930, CT-2931, CT-940CH ^③ , CT-2940 ^③ | UNI-DIE™ Dieless CT-980, CT-2980, CT-980LPCH ^⑥ , CT-980CH, CT-2950 ^⑤ , CT-2981 Extended Wire Range | CT-2001, CT-2002 | TBM20S, TBM25S | TBM5, TBM8 | TBM12, 13642M | | |
| L = Lug S = Splice | | | Die Part Number/Color Code and Die Index Number/(Number of Crimps) | | | | | | | | | | | |
| LCA10 LCD10 | #14 – #10 AWG STR, #12 – #10 AWG SOL | 7/16 | 12-10 (1) | P10 (1) | — | — | — | — | — | — | — | — | — | — |
| LCA8 LCA ^N 8 LCD8 LCD ^N 8 | #8 AWG | 5/8 | — | — | Red P21 (2) | CD-720-1 Red P21 (1) | CD-920-8 Red P21 (1) | — | — | CD-2001-8 Red P21 (1) | Red 21 (2) | Red 21 (1) | Red 21 (1) | — |
| SCS8 | | 11/16 | — | — | — | — | — | — | — | — | — | — | — | — |
| LCA6 LCA ^N 6 LCD6 LCD ^N 6 | #6 AWG | 7/8 | — | — | Blue P24 (2) | CD-720-1 Blue P24 (1) | CD-920-6 Blue P24 (1) | — | — | CD-2001-6 Blue P24 (1) | Blue 24 (2) | Blue 24 (1) | Blue 24 (1) | — |
| SCS6 | | 13/16 | — | — | — | — | — | — | — | — | — | — | — | — |
| LCA4 LCA ^N 4 LCD4 LCD ^N 4 | #4 – #3 AWG STR, #2 AWG SOL | 7/8 | — | — | Gray P29 (2) | CD-720-1 Gray P29 (1) | CD-920-4 Gray P29 (1) | #4 – #2 AWG STR Only (1) | — | CD-2001-4 Gray P29 (1) | Gray 29 (2) | Gray 29 (1) | Gray 29 (1) | — |
| SCS4 | | 13/16 | — | — | — | — | — | — | — | — | — | — | — | — |
| LCA2 LCA ^N 2 ^② LCD2 LCD ^N 2 | #2 AWG | 15/16 | — | — | Brown P33 (2) | CD-720-1 Brown P33 (1) | CD-920-2 Brown P33 (1) | #6 – #2 AWG (1) | — | CD-2001-2 Brown P33 (1) | Brown 33 (2) | Brown 33 (1) | Brown 33 (1) | — |
| SCS2 | | 7/8 | — | — | — | — | — | — | — | — | — | — | — | — |
| LCA1 LCA ^N 1 LCD1 LCD ^N 1 | #1 AWG | 15/16 | — | — | Green P37 (3) | CD-720-2 Green P37 (1) | CD-920-1 Green P37 (1) | #6 – #1 AWG (1) | — | CD-2001-1 Green P37 (1) | — | Green 37 (1) | Green 37 (1) | — |
| SCS1 | | 7/8 | — | — | — | — | — | — | — | — | — | — | — | — |
| LCA1/0 LCA ^N 1/0 LCD1/0 LCD ^N 1/0 | 1/0 AWG | 1 | — | — | — | CD-720-2 Pink P42 (1) | CD-920-1/0 Pink P42 (1) | #6 – 1/0 AWG (1) | — | CD-2001-1/0 Pink P42 (1) | — | Pink 42 (1) | Pink 42 (1) | — |
| SCS1/0 | | 7/8 | — | — | — | — | — | — | — | — | — | — | — | — |
| LCA2/0 LCA ^N 2/0 LCD2/0 LCD ^N 2/0 | 2/0 AWG | 1-1/16 | — | — | — | CD-720-2 Black P45 (2) | CD-920-2/0 Black P45 (2) | #4 – 2/0 AWG (1) | — | CD-2001-2/0 Black P45 (2) | — | Black 45 (2) | Black 45 (1) | — |
| SCS2/0 | | 15/16 | — | — | — | — | — | — | — | — | — | — | — | — |
| LCA3/0 LCA ^N 3/0 LCD3/0 LCD ^N 3/0 | 3/0 AWG | 1-3/16 | — | — | — | CD-720-2 Orange P50 (2) | CD-920-3/0 Orange P50 (2) | #2 – 3/0 AWG (1) | — | CD-2001-3/0 Orange P50 (2) | — | Orange 50 (2) | Orange 50 (1) | — |
| SCS3/0 | | 1 | — | — | — | — | — | — | — | — | — | — | — | — |

①The CT-1700 and CT-1701 crimp die pockets are integrated into the tool frame.
 ②CD-920 dies can be used with CT-940CH and CT-2940 tools with CD-940-DA adapter.
 ③Maximum size: 500 kcmil lugs and 250 kcmil splices.
 ④Maximum size: 250 kcmil lugs and splices. No extended wire range.

For use with
Copper
Conductors

Installation Tooling and Die Selections for: Types LCA, LCA, LCD, LCDN and SCS (continued)

A.
System
Overview

B1.
Cable
Ties

B2.
Cable
Accessories

B3.
Stainless
Steel Ties

C1.
Wiring
Duct

C2.
Surface
Raceway

C3.
Abrasion
Protection

C4.
Cable
Management

D1.
Terminals

D2.
Power
Connectors

D3.
Grounding
Connectors

E1.
Labeling
Systems

E2.
Labels

E3.
Pre-Printed
& Write-On
Markers

E4.
Permanent
Identification

E5.
Lockout/
Tagout
& Safety
Solutions

F.
Index

| Thomas and Betts | | | Burndy | | | | | Anderson | Penn-Union | Greenlee |
|---|---|--|--------------------------|------------|---|---|--|------------|------------|------------|
| TBM15, TBM15I, TBM15BSCR | TBM8-750M-1, TBM8-750, TBM8-750BSCR, TBM750BSCR® | TBM14M, TBM14BSCR, BPLT14BSCR, 13100A | Y2MR, Y1MR, Y1MRTC | MY29 | BAT35, Y39BH, Y35BH, Y750, Y750BH, Y750-2, Y750HS, Y750BH-2, Y39, PAT750, Y35, BAT750 | Y45 ^⑦ , Y46 ^⑦ | Y644M, Y644HS, PAT644, BAT644, Y644MBH | VC6 | TDY-1 | 1989 |
| Die Part Number/Color Code and Die Index Number/(Number of Crimps) | | | | | | | | | | |
| — | — | — | — | — | — | — | — | — | — | — |
| Red 21 (1) | STD (1) | Red 21 (1) | Red 49 (1) | #8 (1) | U8CRT Red 49 (1) | U8CRT Red 49 (1) | — | — | — | — |
| Blue 24 (1) | STD (1) | Blue 24 (1) | Blue 7 (2) | #6 (1) | U5CRT Blue 7 (1) | U5CRT Blue 7 (1) | STD (1) | STD (1) | — | — |
| Gray 29 (1) | STD (1) | Gray 29 (1) | Gray 8 (2) | #4 (1) | U4CRT Gray 8 (1) | U4CRT Gray 8 (1) | STD (1) | STD (1) | — | STD (1) |
| Brown 33 (1) | STD (1) | Brown 33 (1) | Brown 10 (2) | #2 (1) | U2CRT Brown 9 [solid]/ Brown 10 [stranded] (1) | U2CRT Brown 9 [solid]/ Brown 10 [stranded] (1) | STD (1) | STD (1) | STD (1) | STD (1) |
| Green 37 (1) | STD (1) | Green 37 (1) | — | #1 (1) | U1CRT Green 11 (1) | U1CRT Green 11 (1) | STD (1) | STD (1) | STD (1) | STD (1) |
| Pink 42H [®] (2) | STD (1) | Pink 42H [®] (2) | — | 1/0 (1) | U25RT Pink 12 (1) | U25RT Pink 12 (1) | STD (1) | STD (1) | STD (1) | STD (1) |
| Black 45 (1) | STD (1) | Black 45 (1) | — | 2/0 (1) | U26RT Black 13 (1) | U26RT Black 13 (1) | STD (1) | STD (1) | STD (1) | STD (1) |
| Orange 50 (1) | STD (1) | Orange 50 (1) | — | 3/0 (1) | U27RT Orange 14 (1) | U27RT Orange 14 (1) | STD (1) | STD (1) | STD (1) | STD (1) |

®Half width dies.

⑦Requires U die adapter.

®Minimum size: #4 AWG lugs and splices.

Chart continues on pages D3.56 – D3.57

**For use with
Copper
Conductors**

Installation Tooling and Die Selections for: Types LCA, LCA, LCD, LCDN and SCS (continued)

| PANDUIT Part Number | Std. Wire Size | Wire Strip Length (In.) | PANDUIT (See Compression Connector Tools Selection Guide, Pages D3.30 – D3.32) | | | | Thomas and Betts | | |
|--|----------------|-------------------------|--|---|---|----------------------------------|------------------|------------------|-----------------------------------|
| | | | CT-720 | CT-920, CT-920CH, CT-930, CT-930CH, CT-930LPCH®, CT-2920, CT-2930, CT-2931, CT-940CH®, CT-2940® | CT-980, CT-2980, CT-980LPCH®, CT-980CH, CT-2950®, CT-2981 Extended Wire Range | CT-2001, CT-2002 | TBM5 | TBM8 | TBM12, 13642M |
| L = Lug S = Splice | | | Die Part Number/Color Code and Die Index Number/(Number of Crimps) | | | | | | |
| LCA4/0 LCAN4/0 LCD4/0 LCDN4/0 SCS4/0 | 4/0 AWG | 1-1/4 1 | CD-720-3 Purple P54 (2) | CD-920-4/0 Purple P54 (2) | 1 – 4/0 AWG (1) | CD-2001-4/0 Purple P54 (2) | Purple 54 (2) | Purple 54 (2) | Purple 54 (1) |
| LCA250 LCAN250 LCD250 LCDN250 SCS250 | 250 kcmil | 1-5/16 1-1/16 | CD-720-3 Yellow P62 (2) | CD-920-250 Yellow P62 (2) | 1/0 AWG – 250 kcmil (2) | CD-2001-250 Yellow P62 (2) | Yellow 62 (2) | Yellow 62 (2) | Yellow 62 (1) |
| LCA300 LCAN300 LCD300 LCDN300 SCS300 | 300 kcmil | 1-1/2 1-1/16 | CD-720-4 White P66 (2) | CD-920-300 White P66 (2) | 2/0 AWG – 300 kcmil (2) | CD-2001-300 White P66 (2) | — | White 66 (2) | White 66H ^② (1) |
| LCA350 LCAN350 LCD350 LCDN350 SCS350 | 350 kcmil | 1-1/2 1-1/8 | CD-720-5 Red P71 (2) | CD-920-350 Red P71 (2) | 3/0 AWG – 350 kcmil (2) | CD-2001-350 Red P71 (2) | — | Red 71 (2) | Red 71H ^② (2) |
| LCA400 LCAN400 LCD400 LCDN400 SCS400 | 400 kcmil | 1-9/16 1-3/16 | CD-720-6 Blue P76 (2) | CD-920-400 Blue P76 (2) | 4/0 AWG – 400 kcmil (2) | CD-2001-400 Blue P76 (3) | — | Blue 76 (2) | Blue 76H ^② (2) |
| LCA500 LCAN500 LCD500 LCDN500 SCS500 | 500 kcmil | 1-13/16 1-3/8 | CD-720-7 Brown P87 (2) | CD-920-500 Brown P87 (2) | 4/0 AWG – 500 kcmil (2) | CD-2001-500 Brown P87 (3) | — | Brown 87 (2) | Brown 87H ^② (2) |
| LCA600 LCAN600 LCD600 LCDN600 SCS600 | 600 kcmil | 1-13/16 1-3/8 | — | CD-920-600 Green P94 (2) | 250 – 600 kcmil (2) | — | — | — | Green 94H ^② (2) |
| LCA750 LCAN750 LCD750 LCDN750 SCS750 | 750 kcmil | 1-15/16 1-5/8 | — | CD920-750 CD-940-750 ^④ Black P106 (2) | 500 – 750 kcmil (2) | — | — | — | Black 106H ^② (2) |
| LCD1000 SCS1000 | 1000 kcmil | 1-15/16 1-7/8 | — | CD-940-1000 ^④ White P125 (4) | — | — | — | — | — |

②Half width dies.
 ③CD-920 dies can be used with CT-940CH and CT-2940 tools with CD-940-DA adapter.
 ④CD-940 dies to be used exclusively with CT-940CH and CT-2940 tools.
 ⑤Maximum size: 500 kcmil lugs and 250 kcmil splices.
 ⑥Maximum size: 250 kcmil lugs and splices. No extended wire range.

**For use with
Copper
Conductors**

Installation Tooling and Die Selections for: Types LCA, LCA, LCD, LCDN and SCS (continued)

| Thomas and Betts | | | Burndy | | | | | Anderson | Penn-Union | Greenlee |
|--|---|--|--------------------------|------------|---|--|--|------------|------------|------------|
| TBM15, TBM15I, TBM15BSCR | TBM8-750M-1, TBM8-750, TBM8-750BSCR, TBM750BSCR ^③ | TBM14M, TBM14BSCR, BPLT14BSCR, 13100A | Y2MR, Y1MR, Y1MRTC | MY29 | BAT35, Y35BH, Y750, Y39BH, Y750BH, Y750-2, Y750HS, Y750BH-2, Y39, PAT750, Y35, BAT750 | Y45 ^② , Y46 ^② | Y644M, Y644HS, PAT644, BAT644, Y644MBH | VC6 | TDY-1 | 1989 |
| Die Part Number/Color Code and Die Index Number/(Number of Crimps) | | | | | | | | | | |
| Purple 54H ^② (2) | STD (1) | Purple 54H ^② (2) | — | 4/0 (1) | U28RT Purple 15 (1) | U28RT Purple 15 (1) | STD (1) | STD (1) | STD (1) | STD (1) |
| Yellow 62 (1) | STD (1) | Yellow 62 (1) | — | 250 (1) | U29RT Yellow 16 (1) | U29RT Yellow 16 (1) | STD (1) | STD (2) | STD (1) | STD (1) |
| White 66 (1) | STD (1) | White 66 (1) | — | — | U30RT White 17 (2) | U30RT White 17 (2) | STD (1) | STD (2) | STD (1) | STD (1) |
| Red 71H ^② (2) | STD (1) | Red 71H ^② (2) | — | — | U31RT Red 18 (2) | U31RT Red 18 (2) | STD (1) | STD (2) | STD (1) | STD (1) |
| Blue 76H ^② (2) | STD (1) | Blue 76 (1) | — | — | U32RT Blue 19 (2) | U32RT Blue 19 (2) | STD (1) | STD (2) | STD (1) | STD (1) |
| Brown 87H ^② (2) | STD (1) | Brown 87H ^② (2) | — | — | U34RT Brown 20 (2) | U34RT Brown 20 (2) | STD (1) | STD (2) | STD (1) | STD (1) |
| Green 94H ^② (2) | STD (1) | Green 94H ^② (2) | — | — | U36RT Green 22 (2) | U36RT Green 22 (2) | STD (1) | — | STD (1) | — |
| Black 106H ^② (2) | STD (1) | Black 106H ^② (2) | — | — | U39RT Black 24 (3) | U39RT Black 24 (3) | STD (1) | — | STD (1) | — |
| 125H ^② (2) | — | 125H ^② (2) | — | — | — | S44RT White 27 (4) | — | — | — | — |

②Half width dies.

⑦Requires U die adapter.

③Minimum size: #4 AWG lugs and splices.

A.
System
Overview

B1.
Cable Ties

B2.
Cable
Accessories

B3.
Stainless
Steel Ties

C1.
Wiring
Duct

C2.
Surface
Raceway

C3.
Abrasion
Protection

C4.
Cable
Management

D1.
Terminals

D2.
Power
Connectors

D3.
Grounding
Connectors

E1.
Labeling
Systems

E2.
Labels

E3.
Pre-Printed
& Write-On
Markers

E4.
Permanent
Identification

E5.
Lockout/
Tagout
& Safety
Solutions

F.
Index

A. System Overview

B1. Cable Ties

For use with Copper Conductors

Installation Tooling and Die Selections for: Types LCB, LCBN, LCC, LCCN and SCL

How to read this chart
For LCB6 lug and CT-2001 crimping tool:

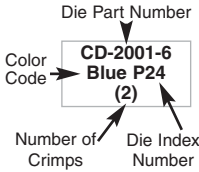

PANDUIT (See Compression Connector Tools Selection Guide, Pages D3.30 – D3.32)

Thomas and Betts

| PANDUIT Part Number | Std. Wire Size | Wire Strip Length (In.) | PANDUIT (See Compression Connector Tools Selection Guide, Pages D3.30 – D3.32) | | | | | | | | | | Thomas and Betts | | | | | |
|--|--------------------------------------|-------------------------|--|----------------------|----------------------|-------------------------|---|---|----------------------------|----------------|---------------|---------------|------------------|---|---|---|---|---|
| | | | CT-1570 | CT-1701 ^① | CT-1700 ^① | CT-720 | CT-920, CT-920CH, CT-930, CT-930CH, CT-2920, CT-2930, CT-2931, CT-930LPCH ^⑥ , CT-940CH ^③ , CT-2940 ^③ | Uni-DIE™ CT-980, CT-980CH, CT-2950 ^⑤ , CT-2980, CT-2981, CT-980LPCH ^⑥ Extended Wire Range | CT-2001, CT-2002 | TBM20S, TBM25S | TBM5 | TBM8 | TBM12, 13642M | | | | | |
| L = Lug S = Splice | | | Die Part Number/Color Code and Die Index Number/(Number of Crimps) | | | | | | | | | | | | | | | |
| LCB10 LCC10 | #14 – #10 AWG STR, #12 – #10 AWG SOL | 9/16 | 12-10 (2) | P10 (2) | — | — | — | — | — | — | — | — | — | — | — | — | — | — |
| LCB8 LCBN8 LCC8 LCCN8 | #8 AWG | 3/4 | — | — | Red P21 (3) | CD-720-1 Red P21 (2) | CD-920-8 Red P21 (1) | — | CD-2001-8 Red P21 (2) | Red 21 (3) | Red 21 (1) | Red 21 (1) | Red 21 (1) | — | — | — | — | — |
| SCL8 | | 1-1/16 | — | — | — | — | — | — | — | — | — | — | — | — | — | — | — | — |
| LCB6 LCBN6 LCC6 LCCN6 | #6 AWG | 1-1/8 | — | — | Blue P24 (3) | CD-720-1 Blue P24 (2) | CD-920-6 Blue P24 (1) | — | CD-2001-6 Blue P24 (2) | Blue 24 (3) | Blue 24 (1) | Blue 24 (1) | Blue 24 (1) | — | — | — | — | — |
| SCL6 | | — | — | — | — | — | — | — | — | — | — | — | — | — | — | — | — | — |
| LCB4 LCBN4 LCC4 LCCN4 | #4 – #3 AWG STR, #2 AWG SOL | 1-1/8 | — | — | Gray P29 (3) | CD-720-1 Gray P29 (2) | CD-920-4 Gray P29 (1) | #4 – #2 AWG #2 AWG SOL Only (1) | CD-2001-4 Gray P29 (2) | Gray 29 (3) | Gray 29 (1) | Gray 29 (1) | Gray 29 (1) | — | — | — | — | — |
| SCL4 | | — | — | — | — | — | — | — | — | — | — | — | — | — | — | — | — | — |
| LCB2 LCBN2 LCC2 LCCN2 | #2 AWG | 1-1/4 | — | — | Brown P33 (3) | CD-720-1 Brown P33 (2) | CD-920-2 Brown P33 (1) | #6 – #2 AWG (1) | CD-2001-2 Brown P33 (2) | Brown 33 (3) | Brown 33 (1) | Brown 33 (1) | Brown 33 (1) | — | — | — | — | — |
| SCL2 | | — | — | — | — | — | — | — | — | — | — | — | — | — | — | — | — | — |
| LCB1 LCBN1 LCC1 LCCN1 | #1 AWG | 1-7/16 | — | — | Green P37 (4) | CD-720-2 Green P37 (2) | CD-920-1 Green P37 (1) | #6 – #1 AWG (1) | CD-2001-1 Green P37 (2) | — | Green 37 (1) | Green 37 (1) | Green 37 (1) | — | — | — | — | — |
| SCL1 | | 1-3/8 | — | — | — | — | — | — | — | — | — | — | — | — | — | — | — | — |
| LCB1/0 LCBN1/0 LCC1/0 LCCN1/0 | 1/0 AWG | 1-1/2 | — | — | — | CD-720-2 Pink P42 (2) | CD-920-1/0 Pink P42 (2) | #6 – 1/0 AWG (2) | CD-2001-1/0 Pink P42 (2) | — | Pink 42 (2) | Pink 42 (2) | Pink 42 (2) | — | — | — | — | — |
| SCL1/0 | | 1-3/8 | — | — | — | — | — | — | — | — | — | — | — | — | — | — | — | — |
| LCB2/0 LCBN2/0 LCC2/0 LCCN2/0 | 2/0 AWG | 1-9/16 | — | — | — | CD-720-2 Black P45 (3) | CD-920-2/0 Black P45 (3) | #4 – 2/0 AWG (2) | CD-2001-2/0 Black P45 (3) | — | Black 45 (3) | Black 45 (3) | Black 45 (2) | — | — | — | — | — |
| SCL2/0 | | 1-1/2 | — | — | — | — | — | — | — | — | — | — | — | — | — | — | — | — |
| LCB3/0 LCBN3/0 LCC3/0 LCCN3/0 | 3/0 AWG | 1-9/16 | — | — | — | CD-720-2 Orange P50 (3) | CD-920-3/0 Orange P50 (3) | #2 – 3/0 AWG (2) | CD-2001-3/0 Orange P50 (3) | — | Orange 50 (3) | Orange 50 (3) | Orange 50 (2) | — | — | — | — | — |
| SCL3/0 | | 1-1/2 | — | — | — | — | — | — | — | — | — | — | — | — | — | — | — | — |
| LCB4/0 LCBN4/0 LCC4/0 LCCN4/0 | 4/0 AWG | 1-5/8 | — | — | — | CD-720-3 Purple P54 (3) | CD-920-4/0 Purple P54 (3) | #1 – 4/0 AWG (2) | CD-2001-4/0 Purple P54 (3) | — | Purple 54 (3) | Purple 54 (3) | Purple 54 (2) | — | — | — | — | — |
| SCL4/0 | | — | — | — | — | — | — | — | — | — | — | — | — | — | — | — | — | — |
| LCB250 LCBN250 LCC250 LCCN250 | 250 kcmil | 1-11/16 | — | — | — | CD-720-3 Yellow P62 (4) | CD-920-250 Yellow P62 (3) | 1/0 AWG – 250 kcmil (3) | CD-2001-250 Yellow P62 (3) | — | Yellow 62 (4) | Yellow 62 (4) | Yellow 62 (2) | — | — | — | — | — |
| SCL250 | | 1-5/8 | — | — | — | — | — | — | — | — | — | — | — | — | — | — | — | — |

①The CT-1700 and CT-1701 crimp die pockets are integrated into the tool frame.
 ③CD-920 dies can be used with CT-940CH and CT-2940 tools with CD-940-DA adapter.
 ⑤Maximum size: 500 kcmil lugs and 250 kcmil splices.
 ⑥Maximum size: 250 kcmil lugs and splices. No extended wire range.

**For use with
Copper
Conductors**

Installation Tooling and Die Selections for: Types LCB, LCBN, LCC, LCCN and SCL (continued)

| Thomas and Betts | | | Burndy | | | | | Anderson | Penn-Union | Greenlee |
|--|--|--|--------------------------|------------|---|--|--|------------|------------|------------|
| TBM15, TBM15I, TBM15BSCR | TBM8-750M-1, TBM8-750, TBM750BSCR [®] , TBM8-750BSCR | TBM14M, TBM14BSCR, BPLT14BSCR, 13100A | Y2MR, Y1MR, Y1MRTC | MY29 | Y35, Y35BH, Y39, Y39BH, Y750, Y750-2, Y750BH, Y750HS, Y750BH-2, PAT750, BAT750, BAT35 | Y45 ^⑦ , Y46 ^⑦ | Y644M, Y644HS, Y644MBH, PAT644, BAT644 | VC6 | TDY-1 | 1989 |
| Die Part Number/Color Code and Die Index Number/(Number of Crimps) | | | | | | | | | | |
| — | — | — | — | — | — | — | — | — | — | — |
| Red 21 (1) | STD (1) | Red 21 (1) | Red 49 (2) | #8 (1) | U8CRT Red 49 (1) | U8CRT Red 49 (1) | — | — | — | — |
| Blue 24 (1) | STD (1) | Blue 24 (1) | Blue 7 (2) | #6 (1) | U5CRT Blue 7 (1) | U5CRT Blue 7 (1) | STD (1) | STD (1) | — | — |
| Gray 29 (1) | STD (1) | Gray 29 (1) | Gray 8 (2) | #4 (1) | U4CRT Gray 8 (1) | U4CRT Gray 8 (1) | STD (1) | STD (1) | — | STD (1) |
| Brown 33 (1) | STD (1) | Brown 33 (1) | Brown 10 (2) | #2 (1) | U2CRT Brown 9 (solid)/ Brown 10 (stranded) (2) | U2CRT Brown 9 (solid)/ Brown 10 (stranded) (2) | STD (1) | STD (1) | STD (1) | STD (1) |
| Green 37 (1) | STD (1) | Green 37 (1) | — | #1 (1) | U1CRT Green 11 (2) | U1CRT Green 11 (2) | STD (1) | STD (1) | STD (1) | STD (1) |
| Pink 42H ^② (4) | STD (2) | Pink 42H ^② (4) | — | 1/0 (2) | U25RT Pink 12 (2) | U25RT Pink 12 (2) | STD (1) | STD (1) | STD (1) | STD (1) |
| Black 45 (2) | STD (2) | Black 45 (2) | — | 2/0 (2) | U26RT Black 13 (2) | U26RT Black 13 (2) | STD (1) | STD (1) | STD (1) | STD (1) |
| Orange 50 (2) | STD (2) | Orange 50 (2) | — | 3/0 (2) | U27RT Orange 14 (2) | U27RT Orange 14 (2) | STD (1) | STD (2) | STD (1) | STD (1) |
| Purple 54H ^② (4) | STD (2) | Purple 54H ^② (4) | — | 4/0 (2) | U28RT Purple 15 (2) | U28RT Purple 15 (2) | STD (1) | STD (2) | STD (1) | STD (1) |
| Yellow 62 (2) | STD (2) | Yellow 62 (2) | — | 250 (2) | U29RT Yellow 16 (2) | U29RT Yellow 16 (2) | STD (1) | STD (2) | STD (1) | STD (1) |

②Half width dies.

⑦Requires U die adapter.

⑧Minimum size: #4 AWG lugs and splices.

Chart continues on pages D3.60 – D3.61

A.
System
Overview

B1.
Cable
Ties

B2.
Cable
Accessories

B3.
Stainless
Steel Ties

C1.
Wiring
Duct

C2.
Surface
Raceway

C3.
Abrasion
Protection

C4.
Cable
Management

D1.
Terminals

D2.
Power
Connectors

D3.
Grounding
Connectors

E1.
Labeling
Systems

E2.
Labels

E3.
Pre-Printed
& Write-On
Markers

E4.
Permanent
Identification

E5.
Lockout/
Tagout
& Safety
Solutions

F.
Index

**For use with
Copper
Conductors**

Installation Tooling and Die Selections for: Types LCB, LCBN, LCC, LCCN and SCL (continued)

| PANDUIT Part Number L = Lug S = Splice | Std. Wire Size | Wire Strip Length (In.) | PANDUIT (See Compression Connector Tools Selection Guide, Pages D3.30 – D3.32) | | | | Thomas and Betts | |
|--|----------------|-------------------------|--|---|--|---------------------------|------------------|------------------------------|
| | | | CT-720 | CT-920, CT-920CH, CT-930, CT-930CH, CT-2920, CT-2930, CT-2931, CT-930LPCH ^② , CT-940CH ^③ , CT-2940 ^③ | UNI-DIE™ CT-980, CT-980CH, CT-2950 ^⑤ , CT-2980, CT-2981, CT-980LPCH ^⑥ Extended Wire Range ^⑦ | CT-2001, CT-2002 | TBM8 | TBM12, 13642M |
| Die Part Number/Color Code and Die Index Number/(Number of Crimps) | | | | | | | | |
| LCB300 LCBN300 LCC300 LCCN300 SCL300 | 300 kcmil | 2-5/16 2 | CD-720-4 White P66 (4) | CD-920-300 White P66 (3) | 2/0 AWG – 300 kcmil (3) | CD-2001-300 White P66 (3) | White 66 (4) | White 66 ^② (4) |
| LCB350 LCBN350 LCC350 LCCN350 SCL350 | 350 kcmil | 2-5/16 2 | CD-720-5 Red P71 (4) | CD-920-350 Red P71 (3) | 3/0 AWG – 350 kcmil (3) | CD-2001-350 Red P71 (3) | Red 71 (4) | Red 71H ^② (4) |
| LCB400 LCBN400 LCC400 LCCN400 SCL400 | 400 kcmil | 2-3/8 2-1/8 | CD-720-6 Blue P76 (4) | CD-920-400 Blue P76 (3) | 4/0 AWG – 400 kcmil (3) | CD-2001-400 Blue P76 (4) | Blue 76 (4) | Blue 76H ^② (4) |
| LCB500 LCBN500 LCC500 LCCN500 SCL500 | 500 kcmil | 2-9/16 2-1/4 | CD-720-7 Brown P87 (4) | CD-920-500 Brown P87 (3) | 4/0 AWG – 500 kcmil (3) | CD-2001-500 Brown P87 (4) | Brown 87 (4) | Brown 87H ^② (4) |
| LCB600 LCBN600 LCC600 LCCN600 SCL600 | 600 kcmil | 2-3/4 2-11/16 | — | CD-920-600 Green P94 (4) | 250 – 600 kcmil (3) | — | — | Green 94H ^② (4) |
| LCB750 LCBN750 LCC750 LCCN750 SCL750 | 750 kcmil | 2-15/16 2-7/8 | — | CD-920-750 CD-940-750 ^④ Black P106 (4) | 500 – 750 kcmil (3) | — | — | Black 106H ^② (4) |
| LCB800 LCBN800 LCC800 LCCN800 | 800 kcmil | 3 | — | CD-940-800 ^④ Orange P107 (4) | — | — | — | — |
| LCB1000 LCBN1000 LCC1000 LCCN1000 SCL1000 | 1000 kcmil | 3-1/16 3 | — | CD-940-1000 ^④ White P125 (4) | — | — | — | Yellow 125H ^② (4) |

②Half width dies.
 ③CD-920 dies can be used with CT-940CH and CT-2940 tools with CD-940-DA adapter.
 ④CD-940 dies to be used exclusively with CT-940CH and CT-2940 tools.
 ⑤Maximum size: 500 kcmil lugs and 250 kcmil splices.
 ⑥Maximum size: 250 kcmil lugs and splices. No extended wire range.
 ⑦Maximum size: 500 kcmil lugs and splices.

**For use with
Copper
Conductors**

Installation Tooling and Die Selections for: Types LCB, LCBN, LCC, LCCN and SCL (continued)

| Thomas and Betts | | | Burdny | | | Anderson | Penn-Union | Greenlee |
|--|---|--|--|--|--|------------|------------|------------|
| TBM15, TBM15I, TBM15BSCR | TBM8-750M-1, TBM8-750, TBM750BSCR®, TBM8-750BSCR | TBM14M, TBM14BSCR, BPLT14BSCR, 13100A | Y35, Y35BH, Y39, Y39BH, Y750, Y750-2, Y750BH, Y750HS, Y750BH-2, PAT750, BAT750, BAT35 | Y45 ^⑦ , Y46 ^⑦ | Y644M, Y644HS, Y644MBH, PAT644, BAT644 | VC6 | TDY-1 | 1989 |
| Die Part Number/Color Code and Die Index Number/(Number of Crimps) | | | | | | | | |
| White 66 (3) | STD (3) | White 66 (3) | U30RT White 17 (3) | U30RT White 17 (3) | STD (1) | STD (3) | STD (2) | STD (1) |
| Red 71H ^② (4) | STD (3) | Red 71 (4) | U31RT Red 18 (3) | U31RT Red 18 (3) | STD (1) | STD (3) | STD (2) | STD (1) |
| Blue 76H ^② (4) | STD (3) | Blue 76 (4) | U32RT Blue 19 (3) | U32RT Blue 19 (3) | STD (1) | STD (3) | STD (2) | STD (1) |
| Brown 87H ^② (4) | STD (3) | Brown 87 (4) | U34RT Brown 20 (3) | U34RT Brown 20 (3) | STD (1) | STD (3) | STD (2) | STD (1) |
| Green 94H ^② (4) | STD (4) | Green 94 (4) | U36RT Green 22 (4) | U36RT Green 22 (4) | STD (1) | — | STD (4) | — |
| Black 106H ^② (4) | STD (4) | Black 106 (4) | U39RT Black 24 (5) | U39RT Black 24 (5) | STD (1) | — | STD (2) | — |
| — | — | — | — | — | — | — | — | — |
| 125H ^② (4) | — | 125H ^② (4) | — | S44RT White 27 (6) | — | — | — | — |

②Half width dies.

⑦Requires U die adapter.

⑧Minimum size: #4 AWG lugs and splices.

A.
System
Overview

B1.
Cable Ties

B2.
Cable
Accessories

B3.
Stainless
Steel Ties

C1.
Wiring
Duct

C2.
Surface
Raceway

C3.
Abrasion
Protection

C4.
Cable
Management

D1.
Terminals

D2.
Power
Connectors

D3.
Grounding
Connectors

E1.
Labeling
Systems

E2.
Labels

E3.
Pre-Printed
& Write-On
Markers

E4.
Permanent
Identification

E5.
Lockout/
Tagout
& Safety
Solutions

F.
Index

A. System Overview

B1. Cable Ties

B2. Cable Accessories

B3. Stainless Steel Ties

C1. Wiring Duct

C2. Surface Raceway

C3. Abrasion Protection

C4. Cable Management

D1. Terminals

D2. Power Connectors

D3. Grounding Connectors

E1. Labeling Systems

E2. Labels

E3. Pre-Printed & Write-On Markers

E4. Permanent Identification

E5. Lockout/Tagout & Safety Solutions

F. Index

For use with Copper Conductors

Installation Tooling and Die Selections for: Types LCBH, LCCH, and SCH

How to read this chart

For LCBH6 lug and CT-2001 crimping tool:

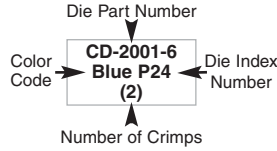

PANDUIT (See Compression Connector Tools Selection Guide, Pages D3.30 – D3.32)

Thomas and Betts

| PANDUIT Part Number | Std. Wire Size | Wire Strip Length (In.) | PANDUIT (See Compression Connector Tools Selection Guide, Pages D3.30 – D3.32) | | | | | Thomas and Betts | | |
|-----------------------|----------------|-------------------------|--|-------------------------|--|---|----------------------------|------------------|---------------|-----------------------------|
| | | | CT-1700 ^① | CT-720 | CT-920, CT-920CH, CT-2920, CT-930, CT-930CH, CT-2930, CT2931, CT-930LPCH ^⑤ , CT-940CH ^② , CT-2940 ^③ | UNI-DIE™ CT-980, CT-980CH, CT-2950 ^⑤ , CT-2980 ^⑥ , CT-2981 ^⑥ , CT-980LPCH ^⑥ Extended Wire Range | CT-2001, CT-2002 | TBM5 | TBM8 | TBM12 13642M |
| L = Lug S = Splice | | | Die Part Number/Color Code and Die Index Number/(Number of Crimps) | | | | | | | |
| LCBH6 LCCH6 | #6 AWG | 1-1/8 | Blue P24 (3) | CD-720-1 Blue P24 (2) | CD-920-6 Blue P24 (1) | — | CD-2001-6 Blue P24 (2) | Blue 24 (1) | Blue 24 (1) | Blue 24 (1) |
| SCH6 | | 15/16 | | | | | | | | |
| LCBH4 LCCH4 | #4 AWG | 1-1/8 | Gray P29 (3) | CD-720-1 Gray P29 (2) | CD-920-4 Gray P29 (1) | #2 AWG SOL, #3 AWG STR (1) | CD-2001-4 Gray P29 (2) | Gray 29 (1) | Gray 29 (1) | Gray 29 (1) |
| SCH4 | | 15/16 | | | | | | | | |
| LCBH2 LCCH2 | #2 AWG | 1-1/4 | Brown P33 (3) | CD-720-1 Brown P33 (2) | CD-920-2 Brown P33 (1) | #6 – #4 AWG (1) | CD-2001-2 Brown P33 (2) | Brown 33 (1) | Brown 33 (1) | Brown 33 (1) |
| SCH2 | | 1 | | | | | | | | |
| LCBH1 LCCH1 | #1 AWG | 1-7/16 | Green P37 (3) | CD-720-2 Green P37 (2) | CD-920-1 Green P37 (1) | #6 – #2 AWG (1) | CD-2001-1 Green P37 (2) | Green 37 (1) | Green 37 (1) | Green 37 (1) |
| SCH1 | | 1 | | | | | | | | |
| LCBH1/0 LCCH1/0 | 1/0 AWG | 1-1/2 | — | CD-720-2 Pink P42 (2) | CD-920-1/0 Pink P42 (2) | #6 – #1 AWG (2) | CD-2001-1/0 Pink P42 (2) | Pink 42 (2) | Pink 42 (2) | Pink 42 (2) |
| SCH1/0 | | 1 | | | | | | | | |
| LCBH2/0 LCCH2/0 | 2/0 AWG | 1-9/16 | — | CD-720-2 Black P45 (3) | CD-920-2/0 Black P45 (3) | #4 – 1/0 AWG (2) | CD-2001-2/0 Black P45 (3) | Black 45 (3) | Black 45 (3) | Black 45 (2) |
| SCH2/0 | | 1-1/16 | | | | | | | | |
| LCBH3/0 LCCH3/0 | 3/0 AWG | 1-9/16 | — | CD-720-2 Orange P50 (3) | CD-920-3/0 Orange P50 (3) | #2 – 2/0 AWG (2) | CD-2001-3/0 Orange P50 (3) | Orange 50 (3) | Orange 50 (3) | Orange 50 (2) |
| SCH3/0 | | 1-3/16 | | | | | | | | |
| LCBH4/0 LCCH4/0 | 4/0 AWG | 1-5/8 | — | CD-720-3 Purple P54 (3) | CD-920-4/0 Purple P54 (3) | #1 – 3/0 AWG (2) | CD-2001-4/0 Purple P54 (3) | Purple 54 (3) | Purple 54 (3) | Purple 54 (3) |
| SCH4/0 | | 1-3/16 | | | | | | | | |
| LCBH250 LCCH250 | 250 kcmil | 1-11/16 | — | CD-720-3 Yellow P62 (4) | CD-920-250 Yellow P62 (3) | 1/0 – 4/0 AWG (3) | CD-2001-250 Yellow P62 (3) | Yellow 62 (4) | Yellow 62 (4) | Yellow 62 (2) |
| SCH250 | | 1-1/4 | | | | | | | | |
| LCBH300 LCCH300 | 300 kcmil | 2-5/16 | — | CD-720-4 White P66 (4) | CD-920-300 White P66 (3) | 2/0 AWG – 250 kcmil (3) | CD-2001-300 White P66 (3) | — | White 66 (4) | White 66H ^② (4) |
| SCH300 | | 2 | | | | | | | | |
| LCBH350 LCCH350 | 350 kcmil | 2-5/16 | — | CD-720-5 Red P71 (4) | CD-920-350 Red P71 (3) | 3/0 AWG – 300 kcmil (3) | CD-2001-350 Red P71 (3) | — | Red 71 (4) | Red 71H ^② (4) |
| SCH350 | | 2 | | | | | | | | |
| LCBH400 LCCH400 | 400 kcmil | 2-3/8 | — | CD-720-6 Blue P76 (4) | CD-920-400 Blue P76 (3) | 4/0 AWG – 350 kcmil (3) | CD-2001-400 Blue P76 (4) | — | Blue 76 (4) | Blue 76H ^② (4) |
| SCH400 | | 2-1/8 | | | | | | | | |
| LCBH500 LCCH500 | 500 kcmil | 2-9/16 | — | CD-720-7 Brown P87 (4) | CD-920-500 Brown P87 (3) | 4/0 AWG – 400 kcmil (3) | CD-2001-500 Brown P87 (4) | — | Brown 87 (4) | Brown 87H ^② (4) |
| SCH500 | | 2-1/4 | | | | | | | | |
| LCBH600 LCCH600 | 600 kcmil | 2-3/4 | — | — | CD-920-600 Green P94 (4) | 250 – 500 kcmil (3) | — | — | — | Green 94H ^② (4) |
| SCH600 | | 2-11/16 | | | | | | | | |
| LCBH750 LCCH750 | 750 kcmil | 2-15/16 | — | — | CD-920-750, CD-940-750 ^④ Black P106 (4) | 500 – 600 kcmil (3) | — | — | — | Black 106H ^② (4) |
| SCH750 | | 2-7/8 | | | | | | | | |
| LCBH1000 LCCH1000 | 1000 kcmil | 3-1/16 | — | — | CD-940-1000 ^④ Green P125 (4) | — | — | — | — | 125H ^② (4) |
| SCH1000 | | 3 | | | | | | | | |

①The CT-1700 crimp die pockets are integrated into the tool frame.
 ②Half width dies.
 ③CD-920 dies can be used with CT-940CH and CT-2940 tools with CD-940-DA adapter.
 ④CD-940 dies to be used exclusively with CT-940CH and CT-2940 tools.

⑤Maximum size: 500 kcmil lugs and 250 kcmil splices.
 ⑥Maximum size: 250 kcmil lugs and splices. No extended wire range.
 ⑦Maximum size: 500 kcmil lugs and splices.

**For use with
Copper
Conductors**

Installation Tooling and Die Selections for: Types LCBH, LCCH, and SCH (continued)

| Thomas and Betts | | | Burndy | | | | Anderson | Penn-Union | Greenlee |
|--|---|---|------------|---|---------------------------|---|------------|------------|------------|
| TBM15, TBM15I, TBM15BSCR | TBM8-750M-1, TBM8-750, TBM8-750BSCR, TBM750BSCR® | TBM14M, TBM14BSCR, BPL14BSCR, 13100A | MY29 | Y39, Y35, Y35BH, BAT35, Y750, Y750BH-2, Y750HS, Y750-2, BAT750, PAT750, Y39BH, Y750BH | Y45Ⓣ, Y46Ⓣ | Y644, Y644HS, PAT644, BAT644, Y644MBH | VC6 | TDY-1 | 1989 |
| Die Part Number/Color Code and Die Index Number/(Number of Crimps) | | | | | | | | | |
| Blue 24 (1) | STD (1) | Blue 24 (1) | 6 (1) | U5CRT Blue 7 (1) | U5CRT Blue 7 (1) | STD (1) | STD (1) | — | — |
| Gray 29 (1) | STD (1) | Gray 29 (1) | 4 (1) | U4CRT Gray 8 (1) | U4CRT Gray 8 (1) | STD (1) | STD (1) | — | STD (1) |
| Brown 33 (1) | STD (1) | Brown 33 (1) | 2 (1) | U2CRT Brown 10 (2) | U2CRT Brown 10 (2) | STD (1) | STD (1) | STD (1) | STD (1) |
| Green 37 (1) | STD (1) | Green 37 (1) | 1 (1) | U1CRT Green 11 (2) | U1CRT Green 11 (2) | STD (1) | STD (1) | STD (1) | STD (1) |
| Pink 42H [Ⓣ] (4) | STD (2) | Pink 42H [Ⓣ] (4) | 1/0 (2) | U25RT Pink 12 (2) | U25RT Pink 12 (2) | STD (1) | STD (1) | STD (1) | STD (1) |
| Black 45 (2) | STD (2) | Black 45 (2) | 2/0 (2) | U26RT Black 13 (2) | U26RT Black 13 (2) | STD (1) | STD (1) | STD (1) | STD (1) |
| Orange 50 (2) | STD (2) | Orange 50 (2) | 3/0 (2) | U27RT Orange 14 (2) | U27RT Orange 14 (2) | STD (1) | STD (2) | STD (1) | STD (1) |
| Purple 54H [Ⓣ] (4) | STD (2) | Purple 54H [Ⓣ] (4) | 4/0 (2) | U28RT Purple 15 (2) | U28RT Purple 15 (2) | STD (1) | STD (2) | STD (1) | STD (1) |
| Yellow 62 (2) | STD (2) | Yellow 62 (2) | 250 (2) | U29RT Yellow 16 (2) | U29RT Yellow 16 (2) | STD (1) | STD (2) | STD (2) | STD (1) |
| White 66H [Ⓣ] (4) | STD (3) | White 66 (4) | — | U30RT White 17 (3) | U30RT White 17 (3) | STD (1) | STD (3) | STD (2) | STD (1) |
| Red 71H [Ⓣ] (4) | STD (3) | Red 71H [Ⓣ] (4) | — | U31RT Red 18 (3) | U31RT Red 18 (3) | STD (1) | STD (3) | STD (2) | STD (1) |
| Blue 76H [Ⓣ] (4) | STD (3) | Blue 76 (4) | — | U32RT Blue 19 (3) | U32RT Blue 19 (3) | STD (1) | STD (3) | STD (2) | STD (1) |
| Brown 87H [Ⓣ] (4) | STD (3) | Brown 87H [Ⓣ] (4) | — | U34RT Brown 20 (3) | U34RT Brown 20 (3) | STD (1) | STD (3) | STD (2) | STD (1) |
| Green 94H [Ⓣ] (4) | STD (4) | Green 94H [Ⓣ] (4) | — | U36RT Green 22 (4) | U36RT Green 22 (4) | STD (1) | — | STD (2) | — |
| Black 106H [Ⓣ] (4) | STD (4) | Black 106H [Ⓣ] (4) | — | U39RT Black 24 (5) | U39RT Black 24 (5) | STD (1) | — | STD (2) | — |
| 125H [Ⓣ] (4) | — | 125H [Ⓣ] (4) | — | — | S44RT White 27 (6) | — | — | — | — |

ⓉHalf width dies.

ⓉRequires U die adapter.

ⓉMinimum size: #4 AWG lugs and splices.

A.
System
Overview

B1.
Cable Ties

B2.
Cable
Accessories

B3.
Stainless
Steel Ties

C1.
Wiring
Duct

C2.
Surface
Raceway

C3.
Abrasion
Protection

C4.
Cable
Management

D1.
Terminals

D2.
Power
Connectors

D3.
Grounding
Connectors

E1.
Labeling
Systems

E2.
Labels

E3.
Pre-Printed
& Write-On
Markers

E4.
Permanent
Identification

E5.
Lockout/
Tagout
& Safety
Solutions

F.
Index

A. System Overview

B1. Cable Ties

For use with Copper Conductors

Installation Tooling and Die Selections for: Type SCT

How to read this chart

For SCT2-2 splice and CT-2001 crimping tool:

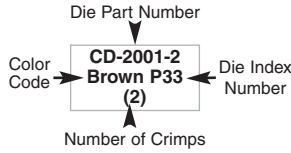

B2. Cable Accessories

B3. Stainless Steel Ties

C1. Wiring Duct

C2. Surface Raceway

C3. Abrasion Protection

C4. Cable Management

D1. Terminals

D2. Power Connectors

D3. Grounding Connectors

E1. Labeling Systems

E2. Labels

E3. Pre-Printed & Write-On Markers

E4. Permanent Identification

E5. Lockout/Tagout & Safety Solutions

F. Index

| PANDUIT (See Compression Connector Tools Selection Guide, Pages D3.30 – D3.32) | | | Thomas and Betts | | | | | | |
|--|----------------|-------------------------|----------------------|-------------------------|---|---|----------------------------|---------------|---------------|
| PANDUIT Part Number | Std. Wire Size | Wire Strip Length (In.) | CT-1700 ^① | CT-720 | CT-920, CT-920CH, CT-2920, CT-930, CT-930CH, CT-2930, CT-2931, CT-940CH ^③ , CT-2940 ^③ | CT-980, CT-980CH, CT-2950 ^④ , CT-2980, CT-2981 | CT-2001, CT-2002 | TBM5 | TBM8 |
| Die Part Number/Color Code and Die Index Number/(Number of Crimps) | | | | | | | | | |
| SCT2-2 | #2 AWG | 2 | Brown P33 (3) | CD-720-1 Brown P33 (2) | CD-920-2 Brown P33 (1) | STD (1) | CD-2001-2 Brown P33 (2) | Brown 33 (1) | Brown 33 (1) |
| | #2 AWG | 1-9/16 | | | | | | | |
| SCT1/0-1/0 | 1/0 AWG | 2-1/16 | Pink P42 (3) | CD-720-2 Pink P42 (2) | CD-920-1/0 Pink P42 (2) | STD (1) | CD-2001-1/0 Pink P42 (2) | Pink 42 (2) | Pink 43 (2) |
| | 1/0 AWG | 1-9/16 | | | | | | | |
| SCT2/0-2/0 | 2/0 AWG | 2-1/16 | — | CD-720-2 Black P45 (3) | CD-920-2/0 Black P45 (3) | STD (1) | CD-2001-2/0 Black P45 (3) | Black 45 (3) | Black 45 (3) |
| | 2/0 AWG | 1-9/16 | | | | | | | |
| SCT4/0-1/0 | 4/0 AWG | 2-1/16 | — | CD-720-2 Orange P50 (3) | CD-920-3/0 Orange P50 (3) | STD (1) | CD-2001-3/0 Orange P50 (3) | Orange 50 (3) | Orange 50 (3) |
| | 1/0 AWG | 1-9/16 | | CD-720-2 Pink P42 (3) | CD-920-1/0 Pink P42 (3) | | CD-2001-1/0 Pink P42 (3) | Pink 42 (3) | Pink42 (3) |
| SCT4/0-4/0 | 4/0 AWG | 2-1/8 | — | CD-720-3 Purple P54 (3) | CD-920-4/0 Purple P54 (3) | STD (1) | CD-2001-4/0 Purple P54 (3) | Purple 54 (3) | Purple 54 (3) |
| | 4/0 AWG | 1-11/16 | | | | | | | |
| SCT250-250 | 250 kcmil | 2-3/16 | — | CD-720-3 Yellow P62 (4) | CD-920-250 Yellow P62 (3) | STD (1) | CD-2001-250 Yellow P62 (3) | Yellow 62 (4) | Yellow 62 (4) |
| | 250 kcmil | 1-11/16 | | | | | | | |
| SCT300-300 | 300 kcmil | 2-13/16 | — | CD-720-4 White P65 (4) | CD-920-300 White P65 (3) | STD (1) | CD-2001-300 White P66 (3) | — | White 66 (4) |
| | 300 kcmil | 2-1/16 | | | | | | | |
| SCT350-350 | 350 kcmil | 2-13/16 | — | CD-720-5 Red P71 (4) | CD-920-350 Red P71 (3) | STD (1) | CD-2001-350 Red P71 (3) | — | Red 71 (4) |
| | 350 kcmil | 2-1/16 | | | | | | | |
| SCT500-4/0 | 500 kcmil | 2-15/16 | — | CD-720-7 Brown P87 (4) | CD-920-500 Brown P87 (3) | STD (1) | CD-2001-500 Brown P87 (4) | — | Brown 87 (4) |
| | 4/0 AWG | 2-15/16 | | CD-720-3 Purple P54 (4) | CD-920-4/0 Purple P54 (4) | | CD-2001-4/0 Purple P54 (4) | — | Purple 54 (4) |
| SCT500-500 | 500 kcmil | 3-1/8 | — | CD-720-7 Brown P87 (4) | CD-920-500 Brown P87 (3) | STD (1) | CD-2001-500 Brown P87 (4) | — | Brown 87 (4) |
| | 500 kcmil | 2-9/16 | | | | | | | |

① The CT-1700 crimp die pockets are integrated into the tool frame.
 ③ CD-920 dies can be used with CT-940CH and CT-2940 tools with CD-940-DA adapter.
 ④ Maximum size: 250 kcmil.

For use with
Copper
Conductors

Installation Tooling and Die Selections for: Type SCT (continued)

| Thomas and Betts | | | | Burndy | | | Anderson | Penn-Union | Greenlee |
|--|----------------------------|-------------------------------------|---------------------------------------|---------|---|---------------------------------------|----------|------------|----------|
| TBM12, 13642M | TBM15, TBM15I, TBM15BSCR | TBM8-750M-1, TBM8-750, TBM8-750BSCR | TBM14M, TBM14BSCR, BPLT14BSCR, 13100A | MY29 | Y39, Y35, Y35BH, Y750HS, Y750, BAT35, Y45, Y39BH, Y46, Y750-2, BAT750, PAT750, Y750BH-2, Y750BH | Y644, Y644HS, PAT644, BAT644, Y644MBH | VC6 | TDY-1 | 1989 |
| Die Part Number/Color Code and Die Index Number/(Number of Crimps) | | | | | | | | | |
| Brown 33 (1) | Brown 33 (1) | STD (1) | Brown 33 (1) | 2 (1) | U2CRT Brown 10 (2) | STD (1) | STD (1) | STD (1) | STD (1) |
| Pink 42H [Ⓜ] (2) | Pink 42H [Ⓜ] (4) | STD (2) | Pink 42H [Ⓜ] (4) | 1/0 (2) | U25RT Pink 12 (2) | STD (1) | STD (1) | STD (1) | STD (1) |
| Black 45 (2) | Black 45 (2) | STD (2) | Black 45 (2) | 2/0 (2) | U26RT Black 13 (2) | STD (1) | STD (1) | STD (1) | STD (1) |
| Orange 50 (2) | Orange 50 (2) | STD (2) | Orange 50 (2) | 3/0 (2) | U27RT Orange 14 (2) | STD (1) | STD (2) | STD (1) | STD (1) |
| Pink 42 (2) | Pink 42H [Ⓜ] (4) | | Pink 42H [Ⓜ] (4) | 1/0 (2) | U25RT Pink 12 (2) | | | | |
| Purple 54 (2) | Purple 54H (4) | STD (2) | Purple 54H [Ⓜ] (4) | 4/0 (2) | U28RT Purple 15 (2) | STD (1) | STD (2) | STD (1) | STD (1) |
| Yellow 62 (2) | Yellow 62 (2) | STD (2) | Yellow 62 (2) | 250 (2) | U29RT Yellow 16 (2) | STD (1) | STD (2) | STD (1) | STD (1) |
| White 66H [Ⓜ] (4) | White 66H [Ⓜ] (4) | STD (3) | White 66H [Ⓜ] (4) | — | U30RT White 17 (3) | STD (1) | STD (3) | STD (2) | STD (1) |
| Red 71H [Ⓜ] (4) | Red 71H [Ⓜ] (4) | STD (3) | Red 71 (3) | — | U31RT Red 18 (3) | STD (1) | STD (3) | STD (2) | STD (1) |
| Brown 87H [Ⓜ] (4) | Brown 87H [Ⓜ] (4) | STD (3) | Brown 87 (3) | — | U34RT Brown 20 (3) | STD (1) | STD (3) | STD (2) | STD (1) |
| Olive 54 (4) | Olive 54H [Ⓜ] (4) | | Olive 54H [Ⓜ] (3) | — | U28RT Purple 15 (3) | | | | |
| Brown 87H [Ⓜ] (4) | Brown 87H [Ⓜ] (4) | STD (3) | Brown 87H [Ⓜ] (4) | — | U34RT Brown 20 (3) | STD (1) | STD (3) | STD (2) | STD (1) |

ⓂHalf width dies.

A. System Overview

B1. Cable Ties

B2. Cable Accessories

B3. Stainless Steel Ties

C1. Wiring Duct

C2. Surface Raceway

C3. Abrasion Protection

C4. Cable Management

D1. Terminals

D2. Power Connectors

D3. Grounding Connectors

E1. Labeling Systems

E2. Labels

E3. Pre-Printed & Write-On Markers

E4. Permanent Identification

E5. Lockout/Tagout & Safety Solutions

F. Index

A. System Overview

B1. Cable Ties

B2. Cable Accessories

B3. Stainless Steel Ties

C1. Wiring Duct

C2. Surface Raceway

C3. Abrasion Protection

C4. Cable Management

D1. Terminals

D2. Power Connectors

D3. Grounding Connectors

E1. Labeling Systems

E2. Labels

E3. Pre-Printed & Write-On Markers

E4. Permanent Identification

E5. Lockout/Tagout & Safety Solutions

F. Index

For use with Copper Conductors

Installation Tooling and Die Selections for: Types LCAX, LCAXN, LCBX, LCDX, LCDXN and LCCX

How to read this chart

For LCAX6 lug and CT-2001 crimping tool:

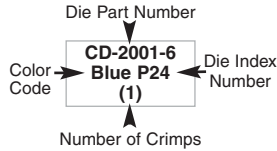

PANDUIT (See Compression Connector Tools Selection Guide, Pages D3.30 – D3.32)

| PANDUIT Part Number | Std. Wire Size | Cable Classes | Wire Strip Length (In.) | Die Part Number/Color Code and Die Index Number (Number of Crimps) | | |
|--|----------------|---|------------------------------------|--|---|---|
| | | | | CT-1700 ^① | CT-2001, CT-2002 | CT-920, CT-920CH, CT-2920, CT-930, CT-930CH, CT-2930, CT-2931, CT-2940 ^③ , CT-940CH ^③ |
| LCAX8, LCDX8, LCDXN8, LCEX8, LCJX8 | #8 AWG | Compact, B, G, H, I, K, M, Locomotive (DLO) | 1/2 | Red P21 (2) | CD-2001-8 Red P21 (1) | CD-920-8 Red P21 (1) |
| | | | 3/4 | Red P21 (3) | CD-2001-8 Red P21 (2) | |
| LCAX6, LCDX6, LCDXN6, LCEX6, LCJX6 | #6 AWG | Compact, B, G, H, I, K, M, Locomotive (DLO) | 9/16 | Blue P24 (2) | CD-2001-6 Blue P24 (1) | CD-920-6 Blue P24 (1) |
| | | | 1-1/8 | Blue P24 (3) | CD-2001-6 Blue P24 (2) | |
| LCAX4, LCDX4, LCDXN4, LCEX4, LCJX4 | #4 AWG | Compact, B, G, H, I, K, M Locomotive (DLO) | 5/8 | Gray P29 (2) | CD-2001-4 Gray P29 (1) | CD-920-4 Gray P29 (1) |
| | | | 1-1/8 | Gray P29 (3) | CD-2001-4 Gray P29 (2) | |
| LCBX4, LCCX4 | #5, #4, #3 | Locomotive (DLO) | | | | 1-1/8 |
| | | | LCAX2, LCDX2, LCDXN2, LCEX2, LCJX2 | #2 AWG | Compact, B, G, H, I, K, M, Locomotive (DLO) | |
| 1-7/16 | Brown P33 (3) | CD-2001-2 Brown P33 (2) | | | | |
| LCAX1, LCDX1, LCDXN1, LCEX1, LCJX1 | #1 AWG | Compact, B, G, H, I, K, M, Locomotive (DLO) | 3/4 | — | CD-2001-1 Green P37 (1) | CD-920-1 Green P37 (1) |
| | | | 1-1/2 | — | CD-2001-1 Green P37 (2) | CD-920-1 Green P37 (2) |
| LCAX1/0, LCDX1/0, LCDXN1/0, LCEX1/0, LCJX1/0 | 1/0 AWG | Compact, B, G, H, I, K, M, Locomotive (DLO) | 3/4 | — | CD-2001-1/0 Pink P42 (2) | CD-920-1/0 Pink P42 (1) |
| | | | 1-9/16 | — | CD-2001-1/0 Pink P42 (3) | CD-920-1/0 Pink P42 (3) |
| LCAX2/0, LCDX2/0, LCDXN2/0, LCEX2/0, LCJX2/0 | 2/0 AWG | Compact, B, G, H, I, K, M, Locomotive (DLO) | 7/8 | — | CD-2001-2/0 Black P45 (2) | CD-920-2/0 Black P45 (1) |
| | | | 1-9/16 | — | CD-2001-2/0 Black P45 (3) | CD-920-2/0 Black P45 (3) |
| LCAX3/0, LCDX3/0, LCDXN3/0, LCEX3/0, LCJX3/0 | 3/0 AWG | Compact, B, G, H, I, K, M, Locomotive (DLO) | 1 | — | CD-2001-3/0 Orange P50 (2) | CD-920-3/0 Orange P50 (1) |
| | | | 1-5/8 | — | CD-2001-3/0 Orange P50 (3) | CD-920-3/0 Orange P50 (3) |

①The CT-1700 crimp die pockets are integrated into the tool frame.
 ③CD-920 dies can be used with CT-940CH and CT-2940 tools with CD-940-DA adapter.
 ⑥Does not include class K flex conductor with Burndy tools.
 ⑦Does not include class M flex conductor with Thomas and Betts tools.
 ⑧Does not include class K and M flex conductor with Thomas and Betts tools.
 ⑨Does not include class K flex conductor with Thomas and Betts tools.

For use with
Copper
Conductors

Installation Tooling and Die Selections for: Types LCAX, LCAXN, LCBX, LCDX, LCDXN and LCCX (continued)

| Thomas and Betts | | | | | Burndy | | | | |
|--|---------------------------|-----------------------------------|----------------------------|--------------------------|--------------------------------|----------------------------|-------|--|---------------|
| TBM12 | TBM8 | TBM6, 25000 | TBM6BSCR, TBM6H | TBM8-750, TBM8-750M-1 | TBM14BSCR, TBM14M, TBM15 | BCT500HS, Y500CT-HS | Y644M | Y35, Y39, Y750, Y46®, Y750-2, Y750BH, BAT35-14V, BAT750-14V, Pat750-18V | MRC840 |
| Die Part Number/Color Code and Die Index Number/(Number of Crimps) | | | | | | | | | |
| TBM12D-1 Red 21 (1) | 13461 Red 21 (1) | 13475 & 13477 Red 21 (1) | 6TON21 Red 21 (1) | STD (1) | 15520 Red 21 (1) | W8CRT Red 49 (1) | — | U8CRT Red 49 (1) | Red 49 (1) |
| TBM12D-1 Red 21 (2) | 13461 Red 21 (2) | 13475 & 13477 Red 21 (2) | 6TON21 Red 21 (2) | STD (2) | 15520 Red 21 (2) | W8CRT Red 49 (2) | — | U8CRT Red 49 (2) | Red 49 (2) |
| TBM12D-1 Blue 24 (1) | 13461 Blue 24 (1) | 13475 & 13477 Blue 24 (1) | 6TON24 Blue 24 (1) | STD (1) | 15522 Blue 24 (1) | W5CRT Blue 7 (1) | (1) | U5CRT Blue 7 (1) | Blue 7 (1) |
| TBM12D-1 Blue 24 (2) | 13461 Blue 24 (2) | 13475 & 13477 Blue 24 (2) | 6TON24 Blue 24 (2) | STD (2) | 15522 Blue 24 (2) | W5CRT Blue 7 (2) | (2) | U5CRT Blue 7 (2) | Blue 7 (2) |
| TBM12D-2 Gray 29 (1) | 13461 Gray 29 (1) | 13472 & 13476 Gray 29 (1) | 6TON29 Gray 29 (1) | STD (1) | 15527-CK Gray 29 (1) | W4CRT Gray 8 (1) | (1) | U4CRT Gray 8 (1) | — |
| TBM12D-2 Gray 29 (3) | 13461 Gray 29 (2) | 13472 & 13476 Gray 29 (3) | 6TON29 Gray 29 (2) | STD (3) | 15527-CK Gray 29 (2) | W4CRT Gray 8 (2) | (2) | U4CRT Gray 8 (2) | — |
| TBM12D-2 Brown 33 (1) | 13461 Brown 33 (1) | 13474 & 13477 Brown 33 (1) | 6TON33 Brown 33 (1) | STD (1) | 15528 Brown 33 (1) | W2CRT Brown 10 (1) | (1) | U2CRT Brown 10 (1) | — |
| TBM12D-2 Brown 33 (3) | 13461 Brown 33 (3) | 13474 & 13477 Brown 33 (3) | 6TON33 Brown 33 (2) | STD (3) | 15528 Brown 33 (2) | W2CRT Brown 10 (2) | (2) | U2CRT Brown 10 (2) | — |
| TBM12D-1 Green 37 (1) | 13462 Green 37 (1) | 13474 & 13477 Green 37 (1) | 6TON37 Green 37 (1) | STD (1) | 15513-CK Green 37 (1) | W1CRT-1 Green 11 (1) | (1) | U1CRT Green 11 (1) | — |
| TBM12D-3 Green 37 (3) | 13462 Green 37 (3) | 13474 & 13477 Green 37 (3) | 6TON37 Green 37 (2) | STD (3) | 15513-CK Green 37 (2) | W1CRT-1 Green 11 (2) | (2) | U1CRT Green 11 (2) | — |
| TBM12D-3 Pink 42 (1) | 13462 Pink 42 (1) | 13475 & 13477 Pink 42 (2) | 6TON42 Pink 42 (2) | STD (1) | 15508 Pink 42 (2) | W25RT Pink 12 (2) | (1) | U25RT Pink 12 (1) | — |
| TBM12D-3 Pink 42 (3) | 13462 Pink 42 (3) | 13475 & 13477 Pink 42 (3) | 6TON42 Pink 42 (3) | STD (3) | 15508 Pink 42 (3) | W25RT Pink 12 (3) | (2) | U25RT Pink 12 (2) | — |
| TBM12D-4 Blk/Gold 45 (1) | 13462 Black 45 (2) | 13474 & 13477 Black 45 (2) | 6TON45 Black 45 (2) | STD (1) | 15526 Black 45 (1) | W26RT Black 13 (2) | (1) | U26RT Black 13 (1) | — |
| TBM12D-4 Blk/Gold 45 (3) | 13462 Black 45 (4) | 13474 & 13477 Black 45 (3) | 6TON45 Black 45 (3) | STD (3) | 15526 Black 45 (2) | W26RT Black 13 (3) | (2) | U26RT Black 13 (2) | — |
| TBM12D-4 Org/Tan 50 (1) | 13462 Orange 50 (2) | 13474 & 13477 Orange 50 (2) | 6TON50 Orange 50 (2) | STD (1) | 15530 Orange 50 (2) | W27RT Orange 14 (2) | (1) | U27RT Orange 14 (1) | — |
| TBM12D-4 Org/Tan 50 (3) | 13462 Orange 50 (4) | 13474 & 13477 Orange 50 (3) | 6TON50 Orange 50 (3) | STD (3) | 15530 Orange 50 (3) | W27RT Orange 14 (4) | (2) | U27RT Orange 14 (2) | — |

⑤Requires U die adapter.

Chart continues on pages D3.68–D3.69

A.
System
Overview

B1.
Cable Ties

B2.
Cable
Accessories

B3.
Stainless
Steel Ties

C1.
Wiring
Duct

C2.
Surface
Raceway

C3.
Abrasion
Protection

C4.
Cable
Management

D1.
Terminals

D2.
Power
Connectors

D3.
Grounding
Connectors

E1.
Labeling
Systems

E2.
Labels

E3.
Pre-Printed
& Write-On
Markers

E4.
Permanent
Identification

E5.
Lockout/
Tagout
& Safety
Solutions

F.
Index

A. System Overview

B1. Cable Ties

B2. Cable Accessories

B3. Stainless Steel Ties

C1. Wiring Duct

C2. Surface Raceway

C3. Abrasion Protection

C4. Cable Management

D1. Terminals

D2. Power Connectors

D3. Grounding Connectors

E1. Labeling Systems

E2. Labels

E3. Pre-Printed & Write-On Markers

E4. Permanent Identification

E5. Lockout/Tagout & Safety Solutions

F. Index

For use with Copper Conductors

Installation Tooling and Die Selections for: Types LCAX, LCAXN, LCBX, LCDX, LCDXN and LCCX (continued)

| | | | | PANDUIT (See Compression Connector Tools Selection Guide, Pages D3.30 – D3.32) | | |
|--|-----------------------|--|--------------------------------|---|----------------------------|---|
| | | | | CT-1700 ^① | CT-2001, CT-2002 | CT-920, CT-920CH, CT-2920, CT-930, CT-930CH, CT-2930, CT-2931, CT-2940 ^③ , CT-940CH ^③ |
| | | | | Die Part Number/Color Code and Die Index Number/(Number of Crimps) | | |
| PANDUIT Part Number | Std. Wire Size | Cable Classes | Wire Strip Length (In.) | | | |
| LCAX4/0, LCDX4/0, LCDXN4/0, LCEX4/0, LCJX4/0 | 4/0 AWG | Compact, B, G, H, I, K, M, Locomotive (DLO) ^⑦ | 1-1/16 | — | CD-2001-4/0 Purple P54 (2) | CD-920-4/0 Purple P54 (1) |
| LCBX4/0, LCCX4/0 | | | 2-5/16 | | CD-2001-4/0 Purple P54 (3) | CD-920-4/0 Purple P54 (3) |
| LCAX250, LCAXN250, LCDX250, LCDXN250, LCEX250, LCJX250 | 250 kcmil | G, H, I, K, M | 1-1/16 | — | CD-2001-250 Yellow P62 (2) | CD-920-250 Yellow P62 (1) |
| LCBX250, LCCX250 | 262.6 kcmil | Locomotive (DLO) | 2-5/16 | | CD-2001-250 Yellow P62 (3) | CD-920-250 Yellow P62 (3) |
| LCAX300, LCDX300, LCDXN300, LCEX300, LCJX300 | 300 kcmil | G, H, I, K, M | 1-1/4 | — | CD-2001-350 Red P71 (2) | CD-920-350 Red P71 (2) |
| | 313.1 kcmil | Locomotive (DLO) | | | CD-2001-350 Red P71 (4) | CD-920-350 Red P71 (3) |
| LCBX300, LCCX300 | 300 kcmil | G, H, I, K, M | 2-3/8 | — | CD-2001-350 Red P71 (4) | CD-920-350 Red P71 (3) |
| | 313.1 kcmil | Locomotive (DLO) | | | CD-2001-400 Blue P76 (2) | CD-920-400 Blue P76 (2) |
| LCAX350, LCDX350, LCDXN350, LCEX350, LCJX350 | 350 kcmil | G, H, I, K, M | 1-3/8 | — | CD-2001-400 Blue P76 (2) | CD-920-400 Blue P76 (2) |
| | 373.7 kcmil | Locomotive (DLO) | | | CD-2001-400 Blue P76 (4) | CD-920-400 Blue P76 (3) |
| LCBX350, LCCX350 | 350 kcmil | G, H, I, K, M | 2-9/16 | — | CD-2001-400 Blue P76 (4) | CD-920-400 Blue P76 (3) |
| | 373.7 kcmil | Locomotive (DLO) | | | — | — |
| LCAX450, LCDX450, LCDXN450, LCEX450, LCJX450 | 450 kcmil | G, H, I, K, M | 1-7/16 | — | — | CD-920-500 Brown P87 (2) |
| | 444.4 kcmil | Locomotive (DLO) | | | — | — |
| LCBX450, LCCX450 | 450 kcmil | G, H, I, K, M | 2-3/4 | — | — | CD-920-500 Brown P87 (4) |
| | 444.4 kcmil | Locomotive (DLO) | | | — | — |
| LCAX500, LCDX500, LCDXN500, LCEX500, LCJX500 | 500 kcmil | G, H, I, K, M | 1-9/16 | — | — | CD-920-500A Pink P99 (2) |
| LCBX500, LCCX500 | 535.3 kcmil | Locomotive (DLO) | 2-15/16 | | | CD-920-500A Pink P99 (4) |
| LCAX600, LCDX600, LCDXN600, LCEX600, LCJX600 | 600 kcmil | G, H, I | 1-9/16 | — | — | CD-920-500A Pink P99 (2) |
| LCAX650, LCDX650, LCDXN650, LCEX650, LCJX650 | 646.4 kcmil | Locomotive (DLO) | 1-1/2 | — | — | CD-940-750 ^④ Black P106 (2) |
| LCAX750, LCDX750, LCDXN750, LCEX750, LCJX750 | 777.7 kcmil | Locomotive (DLO) | 1-3/4 | — | — | CD-940-750X ^④ Yellow (2) |

①The CT-1700 crimp die pockets are integrated into the tool frame.
 ③CD-920 dies can be used with CT-940CH and CT-2940 tools with CD-940-DA adapter.
 ④CD-940 dies to be used exclusively with CT-940CH and CT-2940 tools.
 ⑦Does not include class M flex conductor with Thomas and Betts tools.

For use with
Copper
Conductors

Installation Tooling and Die Selections for: Types LCAX, LCAXN, LCBX, LCDX, LCDXN and LCCX (continued)

| Thomas and Betts | | | | | | Burndy | | | |
|---|------|----------------|---|--------------------------|--|---------------------------|-------|--|--------|
| TBM12 | TBM8 | TBM6, 25000 | TBM6BSCR, TBM6H | TBM8-750, TBM8-750M-1 | TBM14BSCR, TBM14M, TBM15 | BCT500HS, Y500CT-HS | Y644M | Y35, Y39, Y750, Y46 [Ⓢ] , Y750-2, Y750BH, BAT35-14V, BAT750-14V, PAT750-18V | MRC840 |
| Die Part Number/Color Code and Die Index Number (Number of Crimps) | | | | | | | | | |
| TBM12D-5 Purp/Olive 54 (1) | — | — | 6TON54 Purple 54 (2) | STD (1) | 15511 Purple 54 (2) | W28RT Purple 15 (2) | (1) | U28RT Purple 15 (1) | — |
| TBM12D-5 Purp/Olive 54 (4) | — | — | 6TON54 Purple 54 (4) | STD (4) | 15511 Purple 54 (4) | W28RT Purple 15 (4) | (3) | U28RT Purple 15 (3) | — |
| TBM12D-5 Yellow 62 (1) | — | — | 6TON62 Yellow 62 (2) | STD (1) | 15510-CK Yellow 62 (1) | W29RT Yellow 16 (2) | (1) | U29RT Yellow 16 (1) | — |
| TBM12D-5 Yellow 62 (3) | — | — | 6TON62 Yellow 62 (4) | STD (4) | 15510-CK Yellow 62 (2) | W29RT Yellow 16 (4) | (3) | U29RT Yellow 16 (3) | — |
| TBM12D-4 Red 71H [Ⓢ] (2) | — | — | 6TON71 Red 71H [Ⓢ] (2) | STD (2) | 15514-CK Red 71H [Ⓢ] (2) | W31RT Red 18 (2) | (1) | U31RT Red 18 (2) | — |
| TBM12D-4 Red 71H [Ⓢ] (4) | — | — | 6TON71 Red 71H [Ⓢ] (4) | STD (4) | 15514-CK Red 71H [Ⓢ] (4) | W31RT Red 18 (4) | (3) | U31RT Red 18 (4) | — |
| TBM12D-4 Blue 76H [Ⓢ] (2) | — | — | 6TON76 Blue 76H [Ⓢ] (2) | STD (2) | 15512 Blue 76H [Ⓢ] (2) | W32RT Blue 19 (3) | (1) | U32RT Blue 19 (2) | — |
| TBM12D-4 Blue 76H [Ⓢ] (4) | — | — | 6TON76 Blue 76H [Ⓢ] (4) | STD (4) | 15512 Blue 76H [Ⓢ] (4) | W32RT Blue 19 (4) | (3) | U32RT Blue 19 (4) | — |
| TBM12D-3 Brown 87H [Ⓢ] (2) | — | — | 6TON87 Brown 87H [Ⓢ] (2) | STD (2) | 15506 Brown 87H [Ⓢ] (2) | — | (1) | U34RT Brown 20 (2) | — |
| TBM12D-3 Brown 87H [Ⓢ] (4) | — | — | 6TON87 Brown 87H [Ⓢ] (4) | STD (4) | 15506 Brown 87H [Ⓢ] (4) | — | (4) | U34RT Brown 20 (4) | — |
| TBM12D-2 Pink 99H [Ⓢ] (2) | — | — | — | STD (2) | 15505 Pink 99H [Ⓢ] (2) | — | (1) | U38XRT Pink L99 (2) | — |
| TBM12D-2 Pink 99H [Ⓢ] (4) | — | — | — | STD (4) | 15505 Pink 99H [Ⓢ] (4) | — | (4) | U38XRT Pink L99 (4) | — |
| TBM12D-2 Pink 99H [Ⓢ] (2) | — | — | — | STD (2) | 15505 Pink 99H [Ⓢ] (2) | — | (1) | U38RT Pink 400 (2) | — |
| TBM12D-2 Black 106H [Ⓢ] (2) | — | — | — | — | 15515-CK Black 106H [Ⓢ] (2) | — | (1) | U39RT Black 24 (2) | — |
| TBM12D-1 Yellow 115H [Ⓢ] (2) | — | — | — | — | 15504 Yellow 115H [Ⓢ] (2) | — | (1) | U44XRT Yellow L115 (2) | — |

ⓈHalf width dies.

ⓈRequires U die adapter.

A.
System
Overview

B1.
Cable
Ties

B2.
Cable
Accessories

B3.
Stainless
Steel Ties

C1.
Wiring
Duct

C2.
Surface
Raceway

C3.
Abrasion
Protection

C4.
Cable
Management

D1.
Terminals

D2.
Power
Connectors

D3.
Grounding
Connectors

E1.
Labeling
Systems

E2.
Labels

E3.
Pre-Printed
& Write-On
Markers

E4.
Permanent
Identification

E5.
Lockout/
Tagout
& Safety
Solutions

F.
Index

A. System Overview

B1. Cable Ties

B2. Cable Accessories

B3. Stainless Steel Ties

C1. Wiring Duct

C2. Surface Raceway

C3. Abrasion Protection

C4. Cable Management

D1. Terminals

D2. Power Connectors

D3. Grounding Connectors

E1. Labeling Systems

E2. Labels

E3. Pre-Printed & Write-On Markers

E4. Permanent Identification

E5. Lockout/Tagout & Safety Solutions

F. Index

For use with Copper Conductors

Installation Tooling and Die Selections for: Types LCAF, LCCF, and SCSF

How to read this chart

For LCAF6 lug and CT-2931 crimping tool:

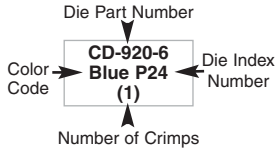

PANDUIT (See Compression Connector Tools Selection Guide, Pages D3.30 – D3.32)

CT-930, CT-930CH, CT-2930, CT-2931, CT-920, CT-920CH, CT-2920, CT-940CH^①, CT-2940^①

Die Part Number/Color Code and Die Index Number/ (Number of Crimps)

| PANDUIT Part Number | Std. Wire Size | Cable Classes | Wire Strip Length (In.) | Die Part Number/Color Code and Die Index Number/ (Number of Crimps) | |
|-------------------------------|----------------|---------------------------|-----------------------------|---|-------------------------------|
| | | | | for LCAF, SCSF Parts | for LCCF Parts |
| LCAF8 LCCF8 SCSF8 | #8 AWG | Locomotive (DLO) | 13/16 11/16 | CD-920-8 Red P21 (1) | |
| LCAF6 LCCF6 SCSF6 | #6 AWG | K, M, Locomotive (DLO) | 7/8 1-5/16 13/16 | CD-920-6 Blue P24 (1) | CD-920-6 Blue P24 (2) |
| LCAF4 LCCF4 SCSF4 | #4 AWG | K, M, Locomotive (DLO) | 7/8 1-5/16 13/16 | CD-920-4 Gray P29 (1) | CD-920-4 Gray P29 (2) |
| LCAF2 LCCF2 SCSF2 | #2 AWG | K, M, Locomotive (DLO) | 15/16 1-7/16 7/8 | CD-920-2 Brown P33 (1) | CD-920-2 Brown P33 (2) |
| LCAF1 LCCF1 SCSF1 | #1 AWG | K, M, Locomotive (DLO) | 1 1-1/2 7/8 | CD-920-1/0 Pink P42 (1) | CD-920-1/0 Pink P42 (2) |
| LCAF1/0 LCCF1/0 SCSF1/0 | 1/0 AWG | K, M, Locomotive (DLO) | 1-7/16 1-9/16 1-3/16 | CD-920-2/0 Black P45 (2) | |
| LCAF2/0 LCCF2/0 SCSF2/0 | 2/0 AWG | K, M, Locomotive (DLO) | 1-7/16 1-9/16 1-3/16 | CD-920-3/0 Orange P50 (2) | |
| LCAF3/0 LCCF3/0 SCSF3/0 | 3/0 AWG | K, M, Locomotive (DLO) | 1-7/16 1-5/8 1-3/16 | CD-920-4/0 Purple P54 (2) | |
| LCAF4/0 LCCF4/0 SCSF4/0 | 4/0 AWG | K, M, Locomotive (DLO) | 1-7/16 1-11/16 1-3/16 | CD-920-250 Yellow P62 (2) | |

^① CD-920 dies can be used with CT-940CH and CT-2940 tools with CD-940-DA adapter.

For use with
Copper
Conductors

Installation Tooling and Die Selections for: Types LCAF, LCCF, and SCSF (continued)

**PANDUIT (See Compression Connector Tools Selection Guide,
Pages D3.30 – D3.32)**

**CT-930, CT-930CH, CT-2930,
CT-2931, CT-920, CT-920CH,
CT-2920, CT-940CH^①, CT-2940^①**

**Die Part Number/Color Code and Die Index Number/
(Number of Crimps)**

| PANDUIT Part Number L = Lug S = Splice | Std. Wire Size | Cable Classes | Wire Strip Length (In.) | Die Part Number/Color Code and Die Index Number/ (Number of Crimps) | |
|--|--------------------------|---------------------------|-------------------------|--|---|
| | | | | for LCAF, SCSF Parts | for LCCF Parts |
| LCAF250 | 250 kcmil 262.6 kcmil | K, M, Locomotive (DLO) | 1-3/4 | CD-920-300 White P66 (2) | CD-920-300 White P66 (3) |
| LCCF250 | | | 2-5/16 | | |
| SCSF250 | | | 1-3/16 | | |
| LCAF300 | 300 kcmil 313.1 kcmil | K, M, Locomotive (DLO) | 1-3/4 | CD-920-350 Red P71 (2) | CD-920-350 Red P71 (3) |
| LCCF300 | | | 2-3/8 | | |
| SCSF300 | | | 1-1/4 | | |
| LCAF350 | 350 kcmil 373.7 kcmil | K, M, Locomotive (DLO) | 1-15/16 | CD-920-400 Blue P76 (2) | CD-920-400 Blue P76 (3) |
| LCCF350 | | | 2-9/16 | | |
| SCSF350 | | | 1-1/2 | | |
| LCAF400 | 400 kcmil 444.4 kcmil | K, M, Locomotive (DLO) | 2-1/4 | CD-920-500 Brown P87 (2) | CD-920-500 Brown P87 (3) |
| LCCF400 | | | 2-3/4 | | |
| SCSF400 | | | 1-11/16 | | |
| LCAF500 | 500 kcmil 535.3 kcmil | K, M, Locomotive (DLO) | 2-5/16 | CD-920-500A Pink P99 (2) | CD-920-500A Pink P99 (3) |
| LCCF500 | | | 2-15/16 | | |
| SCSF500 | | | 1-5/8 | | |
| LCAF600 ^③ | 646.4 kcmil | Locomotive (DLO) | 2-3/8 | CD-920-750 Black P106 (2) | CD-920-750 Black P106 (3) |
| LCCF600 ^③ | | | 3 | | |
| SCSF600 ^③ | | | 1-5/8 | | |
| LCAF750 ^③ | 777.7 kcmil | Locomotive (DLO) | 2-7/16 | CD-940-800 ^② Orange P107 (2) | CD-940-800 ^② Orange P107 (4) |
| LCCF750 ^③ | | | 3-1/16 | | |
| SCSF750 ^③ | | | 1-5/8 | | |

① CD-920 dies can be used with CT-940CH and CT-2940 tools with CD-940-DA adapter.

② CD-940 dies to be used exclusively with CT-940CH and CT-2940 tools.

③ Can only be crimped with CT-940CH and CT-2940 tools.

A.
System
Overview

B1.
Cable Ties

B2.
Cable
Accessories

B3.
Stainless
Steel Ties

C1.
Wiring
Duct

C2.
Surface
Raceway

C3.
Abrasion
Protection

C4.
Cable
Management

D1.
Terminals

D2.
Power
Connectors

D3.
Grounding
Connectors

E1.
Labeling
Systems

E2.
Labels

E3.
Pre-Printed
& Write-On
Markers

E4.
Permanent
Identification

E5.
Lockout/
Tagout
& Safety
Solutions

F.
Index

A. System Overview

B1. Cable Ties

B2. Cable Accessories

B3. Stainless Steel Ties

C1. Wiring Duct

C2. Surface Raceway

C3. Abrasion Protection

C4. Cable Management

D1. Terminals

D2. Power Connectors

D3. Grounding Connectors

E1. Labeling Systems

E2. Labels

E3. Pre-Printed & Write-On Markers

E4. Permanent Identification

E5. Lockout/Tagout & Safety Solutions

F. Index

For use with Copper Conductors

Installation Tooling and Die Selections for: Type RSC In-Line Reducing Splice

How to read this chart

For RSC4-6 splice and CT-2001 crimping tool:

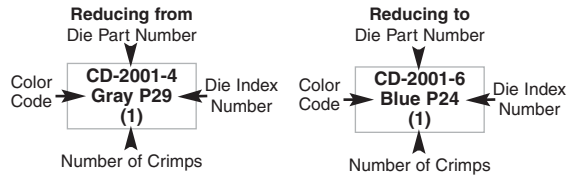

| PANDUIT Part Number | Reducing From | | | Reducing To | | |
|---------------------|-----------------------------|---------------|-------------------------|-----------------------------|---------------|-------------------------|
| | Standard Wire Size | Cable Classes | Wire Strip Length (In.) | Standard Wire Size | Cable Classes | Wire Strip Length (In.) |
| RSC4-6 | #4 – #3 AWG STR, #2 AWG SOL | B, C, Compact | 1 | #6 AWG | B, C, Compact | 1-5/16 |
| RSC2-6 | #2 AWG | B, C, Compact | 1 | #6 AWG | B, C, Compact | 1-5/16 |
| RSC2-4 | #2 AWG | B, C, Compact | 1 | #4 – #3 AWG STR, #2 AWG SOL | B, C, Compact | 1-5/16 |
| RSC1/0-6 | 1/0 AWG | B, C, Compact | 1 | #6 AWG | B, C, Compact | 1-5/16 |
| RSC1/0-4 | 1/0 AWG | B, C, Compact | 1 | #4 – #3 AWG STR, #2 AWG SOL | B, C, Compact | 1-5/16 |
| RSC2/0-6 | 2/0 AWG | B, C, Compact | 1-1/16 | #6 AWG | B, C, Compact | 1-5/16 |
| RSC2/0-4 | 2/0 AWG | B, C, Compact | 1-1/16 | #4 – #3 AWG STR, #2 AWG SOL | B, C, Compact | 1-5/16 |
| RSC4/0-6 | 4/0 AWG | B, C, Compact | 1-1/16 | #6 AWG | B, C, Compact | 1-5/16 |
| RSC4/0-4 | 4/0 AWG | B, C, Compact | 1-1/16 | #4 – #3 AWG STR, #2 AWG SOL | B, C, Compact | 1-5/16 |
| RSC4/0-1/0 | 4/0 AWG | B, C, Compact | 1-1/16 | 1/0 AWG | B, C, Compact | 1-9/16 |
| RSC4/0-2/0 | 4/0 AWG | B, C, Compact | 1-1/16 | 2/0 AWG | B, C, Compact | 1-7/16 |
| RSC500-X4/0 | 500 kcmil | B, C, Compact | 1-7/8 | 4/0 AWG | I | 1-7/16 |
| RSC500-X350 | 500 kcmil | B, C, Compact | 1-7/8 | 350 kcmil | I | 1-7/8 |
| RSC750-4/0 | 750 kcmil | B, C, Compact | 2 | 4/0 AWG | B, C, Compact | 1-5/8 |
| RSC750-X4/0 | 750 kcmil | B, C, Compact | 2 | 4/0 AWG | I | 1-7/16 |
| RSC750-X350 | 750 kcmil | B, C, Compact | 2 | 350 kcmil | I | 1-7/8 |
| RSC750-500 | 750 kcmil | B, C, Compact | 2 | 500 kcmil | B, C, Compact | 1-7/8 |
| RSC750-X500 | 750 kcmil | B, C, Compact | 2 | 500 kcmil | I | 2 |
| RSC750-750 | 750 kcmil | B, C, Compact | 2 | 750 kcmil | B, C, Compact | 2 |
| RSCX750-4/0 | 750 kcmil | I | 2 | 4/0 AWG | B, C, Compact | 1-5/8 |
| RSCX750-750 | 750 kcmil | I | 2 | 750 kcmil | B, C, Compact | 2 |

For use with
Copper
Conductors

Installation Tooling and Die Selections for: Type RSC In-Line Reducing Splice (continued)

| PANDUIT (See Compression Connector Tools Selection Guide, Pages D3.30 – D3.32) | | | | | | | |
|--|--------------|-------------------------|-------------------------|----------------------------|----------------------------|--|--|
| CT-1700 ^① | | CT-720 | | CT-2001, CT-2000 | | CT-930 ^⑤ , CT-930CH ^⑤ , CT-920 ^⑥ , CT-920CH ^⑥ , CT-2920 ^⑥ , CT-2940 ^③ , CT-940CH ^③ , CT-2930 ^⑤ , CT-2931 ^⑤ | |
| Reducing From | Reducing To | Reducing From | Reducing To | Reducing From | Reducing To | Reducing From | Reducing To |
| Die Part Number/Color Code and Die Index Number (Number of Crimps) | | | | | | | |
| Gray P29 (2) | Blue P24 (2) | CD-720-1 Gray P29 (1) | CD-720-1 Blue P24 (1) | CD-2001-4 Gray P29 (1) | CD-2001-6 Blue P24 (1) | CD-920-4 Gray P29 (1) | CD-920-6 Blue P24 (1) |
| Brown P33 (2) | Blue P24 (2) | CD-720-1 Brown P33 (1) | CD-720-1 Blue P24 (1) | CD-2001-2 Brown P33 (1) | CD-2001-6 Blue P24 (1) | CD-920-2 Brown P33 (1) | CD-920-6 Blue P24 (1) |
| Brown P33 (2) | Gray P29 (2) | CD-720-1 Brown P33 (1) | CD-720-1 Gray P29 (1) | CD-2001-2 Brown P33 (1) | CD-2001-4 Gray P29 (1) | CD-920-2 Brown P33 (1) | CD-920-4 Gray P29 (1) |
| — | — | CD-720-2 Pink P42 (1) | CD-720-1 Blue P24 (1) | CD-2001-1/0 Pink P42 (1) | CD-2001-6 Blue P24 (1) | CD-920-1/0 Pink P42 (1) | CD-920-6 Blue P24 (1) |
| — | — | CD-720-2 Pink P42 (1) | CD-720-1 Gray P29 (1) | CD-2001-1/0 Pink P42 (1) | CD-2001-4 Gray P29 (1) | CD-920-1/0 Pink P42 (1) | CD-920-4 Gray P29 (1) |
| — | — | CD-720-2 Black P45 (2) | CD-720-1 Blue P24 (1) | CD-2001-2/0 Black P45 (2) | CD-2001-6 Blue P24 (1) | CD-920-2/0 Black P45 (1) | CD-920-6 Blue P24 (1) |
| — | — | CD-720-2 Black P45 (2) | CD-720-1 Gray P29 (1) | CD-2001-2/0 Black P45 (2) | CD-2001-4 Gray P29 (1) | CD-920-2/0 Black P45 (1) | CD-920-4 Gray P29 (1) |
| — | — | CD-720-3 Purple P54 (2) | CD-720-1 Blue P24 (1) | CD-2001-4/0 Purple P54 (2) | CD-2001-6 Blue P24 (1) | CD-920-4/0 Purple P54 (1) | CD-920-6 Blue P24 (1) |
| — | — | CD-720-3 Purple P54 (2) | CD-720-1 Gray P29 (1) | CD-2001-4/0 Purple P54 (2) | CD-2001-4 Gray P29 (1) | CD-920-4/0 Purple P54 (1) | CD-920-4 Gray P29 (1) |
| — | — | CD-720-3 Purple P54 (2) | CD-720-2 Pink P42 (2) | CD-2001-4/0 Purple P54 (2) | CD-2001-1/0 Pink P42 (2) | CD-920-4/0 Purple P54 (1) | CD-920-1/0 Pink P42 (2) |
| — | — | CD-720-3 Purple P54 (2) | CD-720-2 Black P45 (2) | CD-2001-4/0 Purple P54 (2) | CD-2001-2/0 Black P45 (2) | CD-920-4/0 Purple P54 (1) | CD-920-2/0 Black P45 (2) |
| — | — | CD-720-7 Brown P87 (2) | CD-720-3 Yellow P62 (2) | CD-2001-500 Brown P87 (3) | CD-2001-250 Yellow P62 (2) | CD-920-500 Brown P87 (2) | CD-920-250 Yellow P62 (2) |
| — | — | CD-720-7 Brown P87 (2) | CD-720-6 Blue P76 (2) | CD-2001-500 Brown P87 (3) | CD-2001-400 Blue P76 (3) | CD-920-500 Brown P87 (2) | CD-920-400 Blue P76 (2) |
| — | — | — | — | — | — | CD-920-750, CD-940-750 ^④ Black P106 (2) | CD-920-4/0 Purple P54 (1) |
| — | — | — | — | — | — | CD-920-750, CD-940-750 ^④ Black P106 (2) | CD-920-250 Yellow P62 (1) |
| — | — | — | — | — | — | CD-920-750, CD-940-750 ^④ Black P106 (2) | CD-920-400 Blue P76 (2) |
| — | — | — | — | — | — | CD-920-750, CD-940-750 ^④ Black P106 (2) | CD-920-500 Brown P87 (2) |
| — | — | — | — | — | — | CD-920-750, CD-940-750 ^④ Black P106 (2) | CD-920-500A Pink P99 (2) |
| — | — | — | — | — | — | CD-920-750, CD-940-750 ^④ Black P106 (2) | CD-920-750 CD-940-750 Black P106 (2) |
| — | — | — | — | — | — | CD-940-750X ^④ Yellow P115 (2) | CD-920-4/0 Purple P54 (1) |
| — | — | — | — | — | — | CD-940-750X ^④ Yellow P115 (2) | CD-940-750 ^④ Black P106 (2) |

①The CT-1700 crimp die pockets are integrated into the tool frame.
 ②CD-920 dies can be used with CT-940CH and CT-2940 tools with CD-940-DA adapter.
 ③CD-940 dies to be used with CT-940CH and CT-2940 tools.
 ④Maximum conductor size: 500 kcmil class I and 750 kcmil class I, B, C, Compact.
 ⑤Maximum conductor size: 250 kcmil class I and 400 kcmil class I, B, C, Compact.

For Burndy tooling, see pages D3.74 – D3.75
 For Thomas and Betts tooling, see pages D3.76 – D3.77

- A. System Overview
- B1. Cable Ties
- B2. Cable Accessories
- B3. Stainless Steel Ties
- C1. Wiring Duct
- C2. Surface Raceway
- C3. Abrasion Protection
- C4. Cable Management
- D1. Terminals
- D2. Power Connectors
- D3. Grounding Connectors
- E1. Labeling Systems
- E2. Labels
- E3. Pre-Printed & Write-On Markers
- E4. Permanent Identification
- E5. Lockout/Tagout & Safety Solutions
- F. Index

A.
System
Overview

B1.
Cable Ties

B2.
Cable
Accessories

B3.
Stainless
Steel Ties

C1.
Wiring
Duct

C2.
Surface
Raceway

C3.
Abrasion
Protection

C4.
Cable
Management

D1.
Terminals

D2.
Power
Connectors

D3.
Grounding
Connectors

E1.
Labeling
Systems

E2.
Labels

E3.
Pre-Printed
& Write-On
Markers

E4.
Permanent
Identification

E5.
Lockout/
Tagout/
& Safety
Solutions

F.
Index

**For use with
Copper
Conductors**

Installation Tooling and Die Selections for: Type RSC In-Line Reducing Splice (continued)

| PANDUIT Part Number | Reducing From | | | Reducing To | | |
|------------------------|--------------------------------|------------------|-------------------------------|--------------------------------|------------------|-------------------------------|
| | Standard Wire Size | Cable Classes | Wire Strip Length (In.) | Standard Wire Size | Cable Classes | Wire Strip Length (In.) |
| RSC4-6 | #4 – #3 AWG STR, #2 AWG SOL | B, C, Compact | 1 | #6 AWG | B, C, Compact | 1-5/16 |
| RSC2-6 | #2 AWG | B, C, Compact | 1 | #6 AWG | B, C, Compact | 1-5/16 |
| RSC2-4 | #2 AWG | B, C, Compact | 1 | #4 – #3 AWG STR, #2 AWG SOL | B, C, Compact | 1-5/16 |
| RSC1/0-6 | 1/0 AWG | B, C, Compact | 1 | #6 AWG | B, C, Compact | 1-5/16 |
| RSC1/0-4 | 1/0 AWG | B, C, Compact | 1 | #4 – #3 AWG STR, #2 AWG SOL | B, C, Compact | 1-5/16 |
| RSC2/0-6 | 2/0 AWG | B, C, Compact | 1-1/16 | #6 AWG | B, C, Compact | 1-5/16 |
| RSC2/0-4 | 2/0 AWG | B, C, Compact | 1-1/16 | #4 – #3 AWG STR, #2 AWG SOL | B, C, Compact | 1-5/16 |
| RSC4/0-6 | 4/0 AWG | B, C, Compact | 1-1/16 | #6 AWG | B, C, Compact | 1-5/16 |
| RSC4/0-4 | 4/0 AWG | B, C, Compact | 1-1/16 | #4 – #3 AWG STR, #2 AWG SOL | B, C, Compact | 1-5/16 |
| RSC4/0-1/0 | 4/0 AWG | B, C, Compact | 1-1/16 | 1/0 AWG | B, C, Compact | 1-9/16 |
| RSC4/0-2/0 | 4/0 AWG | B, C, Compact | 1-1/16 | 2/0 AWG | B, C, Compact | 1-7/16 |
| RSC500-X4/0 | 500 kcmil | B, C, Compact | 1-7/8 | 4/0 AWG | I | 1-7/16 |
| RSC500-X350 | 500 kcmil | B, C, Compact | 1-7/8 | 350 kcmil | I | 1-7/8 |
| RSC750-4/0 | 750 kcmil | B, C, Compact | 2 | 4/0 AWG | B, C, Compact | 1-5/8 |
| RSC750-X4/0 | 750 kcmil | B, C, Compact | 2 | 4/0 AWG | I | 1-7/16 |
| RSC750-X350 | 750 kcmil | B, C, Compact | 2 | 350 kcmil | I | 1-7/8 |
| RSC750-500 | 750 kcmil | B, C, Compact | 2 | 500 kcmil | B, C, Compact | 1-7/8 |
| RSC750-X500 | 750 kcmil | B, C, Compact | 2 | 500 kcmil | I | 2 |
| RSC750-750 | 750 kcmil | B, C, Compact | 2 | 750 kcmil | B, C, Compact | 2 |
| RSCX750-4/0 | 750 kcmil | I | 2 | 4/0 AWG | B, C, Compact | 1-5/8 |
| RSCX750-750 | 750 kcmil | I | 2 | 750 kcmil | B, C, Compact | 2 |

For use with
Copper
Conductors

Installation Tooling and Die Selections for: Type RSC In-Line Reducing Splice (continued)

| Burdny | | | | | |
|---|----------------|------------------|----------------|--|------------------------|
| Y1MR, Y2MR | | Y1MRTC | | Y35, Y35BH, Y39, Y39BH, Y45, Y46, Y750, Y750HS, Y750-2, Y750BH-2, BAT35, BAT750, PAT644, PAT750 | |
| Reducing From | Reducing To | Reducing From | Reducing To | Reducing From | Reducing To |
| Die Part Number/Color Code and Die Index Number (Number of Crimps) | | | | | |
| Gray (2) | Blue (3) | White (2) | Blue (3) | U4CR Gray 8 (1) | U5CRT Blue 7 (1) |
| Brown (2) | Blue (3) | Brown (2) | Blue (3) | U2CRT Brown 10 (1) | U5CRT Blue 7 (1) |
| Brown (2) | Gray (3) | Brown (2) | White (3) | U2CRT Brown 10 (1) | U4CRT Gray 8 (1) |
| — | — | — | — | U25RT Pink 12 (1) | U5CRT Blue 7 (1) |
| — | — | — | — | U25RT Pink 12 (1) | U4CRT Gray 8 (1) |
| — | — | — | — | U26RT Black 13 (1) | U5CRT Blue 7 (1) |
| — | — | — | — | U26RT Black 13 (1) | U4CRT Gray 8 (1) |
| — | — | — | — | U28RT Purple 15 (1) | U5CRT Blue 7 (1) |
| — | — | — | — | U28RT Purple 15 (1) | U4CRT Gray 8 (1) |
| — | — | — | — | U28RT Purple 15 (1) | U25RT Pink 12 (2) |
| — | — | — | — | U28RT Purple 15 (1) | U26RT Black 13 (1) |
| — | — | — | — | U34RT Brown 20 (2) | U29RT Yellow 16 (1) |
| — | — | — | — | U34RT Brown 20 (2) | U32RT Blue 19 (2) |
| — | — | — | — | U39RT Black 24 (3) | U28RT Purple 15 (1) |
| — | — | — | — | U39RT Black 24 (3) | U29RT Yellow 16 (1) |
| — | — | — | — | U39RT Black 24 (3) | U32RT Blue 19 (2) |
| — | — | — | — | U39RT Black 24 (3) | U34RT Brown 20 (2) |
| — | — | — | — | U39RT Black 24 (3) | U38XRT Pink L99 (3) |
| — | — | — | — | U39RT Black 24 (3) | U39RT Black 24 (3) |
| — | — | — | — | — | — |
| — | — | — | — | — | — |

A.
System
Overview

B1.
Cable Ties

B2.
Cable
Accessories

B3.
Stainless
Steel Ties

C1.
Wiring
Duct

C2.
Surface
Raceway

C3.
Abrasion
Protection

C4.
Cable
Management

D1.
Terminals

D2.
Power
Connectors

D3.
Grounding
Connectors

E1.
Labeling
Systems

E2.
Labels

E3.
Pre-Printed
& Write-On
Markers

E4.
Permanent
Identification

E5.
Lockout/
Tagout
& Safety
Solutions

F.
Index

For PANDUIT tooling, see pages D3.72 – D3.73
For Thomas and Betts tooling, see pages D3.76 – D3.77

**For use with
Copper
Conductors**

Installation Tooling and Die Selections for: Type RSC In-Line Reducing Splice (continued)

| PANDUIT Part Number | Reducing From | | | Reducing To | | |
|---------------------|---------------------------------|---------------|-------------------|----------------------|---------------|-------------------|
| | Standard Wire Size | Cable Classes | Wire Strip Length | Standard Wire Size | Cable Classes | Wire Strip Length |
| RSC4-6 | #4 – #3 AWG STR #2 AWG Solid | B, C, Compact | 1 | 6 AWG | B, C, Compact | 1-5/16 |
| RSC2-6 | #2 AWG | B, C, Compact | 1 | 6 AWG | B, C, Compact | 1-5/16 |
| RSC2-4 | #2 AWG | B, C, Compact | 1 | 4-3 AWG 2 Solid | B, C, Compact | 1-5/16 |
| RSC1/0-6 | 1/0 AWG | B, C, Compact | 1 | 6 AWG | B, C, Compact | 1-5/16 |
| RSC1/0-4 | 1/0 AWG | B, C, Compact | 1 | 4 – 3 AWG 2 Solid | B, C, Compact | 1-5/16 |
| RSC2/0-6 | 2/0 AWG | B, C, Compact | 1-1/16 | 6 AWG | B, C, Compact | 1-5/16 |
| RSC2/0-4 | 2/0 AWG | B, C, Compact | 1-1/16 | 4 – 3 AWG 2 Solid | B, C, Compact | 1-5/16 |
| RSC4/0-6 | 4/0 AWG | B, C, Compact | 1-1/16 | 6 AWG | B, C, Compact | 1-5/16 |
| RSC4/0-4 | 4/0 AWG | B, C, Compact | 1-1/16 | 4 – 3 AWG 2 Solid | B, C, Compact | 1-5/16 |
| RSC4/0-1/0 | 4/0 AWG | B, C, Compact | 1-1/16 | 1/0 AWG | B, C, Compact | 1-9/16 |
| RSC4/0-2/0 | 4/0 AWG | B, C, Compact | 1-1/16 | 2/0 AWG | B, C, Compact | 1-7/16 |
| RSC500-X4/0 | 500 kcmil | B, C, Compact | 1-7/8 | 4/0 AWG | I | 1-7/16 |
| RSC500-X350 | 500 kcmil | B, C, Compact | 1-7/8 | 350 kcmil | I | 1-7/8 |
| RSC750-4/0 | 750 kcmil | B, C, Compact | 2 | 4/0 AWG | B, C, Compact | 1-5/8 |
| RSC750-X4/0 | 750 kcmil | B, C, Compact | 2 | 4/0 AWG | I | 1-7/16 |
| RSC750-X350 | 750 kcmil | B, C, Compact | 2 | 350 AWG | I | 1-7/8 |
| RSC750-500 | 750 kcmil | B, C, Compact | 2 | 500 kcmil | B, C, Compact | 1-7/8 |
| RSC750-X500 | 750 kcmil | B, C, Compact | 2 | 500 kcmil | I | 2 |
| RSC750-750 | 750 kcmil | B, C, Compact | 2 | 750 kcmil | B, C, Compact | 2 |
| RSCX750-4/0 | 750 kcmil | I | 2 | 4/0 AWG | B, C, Compact | 1-5/8 |
| RSCX750-750 | 750 kcmil | I | 2 | 750 kcmil | B, C, Compact | 2 |

For use with
Copper
Conductors

Installation Tooling and Die Selections for: Type RSC In-Line Reducing Splice (continued)

| Thomas and Betts | | | | | | | |
|---|----------------|---------------------|----------------|---------------------------------------|---------------------------------------|--|-----------------------------|
| TBM20S, TBM25S | | TBM5, TBM6, TBM8 | | TBM12, 13642M | | TBM14BSCR, BPLT14BSCR, 13100A, TBM14M | |
| Reducing From | Reducing To | Reducing From | Reducing To | Reducing From | Reducing To | Reducing From | Reducing To |
| Color Code/Die Index Number (Number of Crimps) | | | | | | | |
| Gray 29 (2) | Blue 24 (3) | Gray 29 (1) | Blue 24 (1) | Gray 29 (1) | Blue 24 (1) | Gray 29 (1) | Blue 24 (1) |
| Brown 33 (2) | Blue 24 (3) | Brown 33 (1) | Blue 24 (1) | Brown 33 (1) | Blue 24 (1) | Brown 33 (1) | Blue 24 (1) |
| Brown 33 (2) | Gray 29 (3) | Brown 33 (1) | Gray 29 (1) | Brown 33 (1) | Gray 29 (1) | Brown 33 (1) | Gray 29 (1) |
| — | — | Pink 42 (1) | Blue 24 (1) | Pink 42 (1) | Blue 24 (1) | Pink 42H [®] (2) | Blue 24 (1) |
| — | — | Pink 42 (1) | Gray 29 (1) | Pink 42 (1) | Gray 29 (1) | Pink 42H [®] (2) | Gray 29 (1) |
| — | — | Black 45 (2) | Blue 24(1) | Black/Gold 45 (1) | Blue 24 (1) | Black 45 (1) | Blue 24 (1) |
| — | — | Black 45 (2) | Gray 29 (1) | Black/Gold 45 (1) | Gray 29 (1) | Black 45 (1) | Gray 29 (1) |
| — | — | Purple 54 (2) | Blue 24 (1) | Purple/Olive 54 (1) | Blue 24 (1) | Olive 54H [®] (2) | Blue 24 (1) |
| — | — | Purple 54 (2) | Gray 29 (1) | Purple/Olive 54 (1) | Gray 29 (1) | Olive 54H [®] (2) | Gray 29 (1) |
| — | — | Purple 54 (2) | Pink 42 (2) | Purple/Olive 54 (1) | Pink 42 (2) | Olive 54H [®] (2) | Pink 42H [®] (4) |
| — | — | Purple 54 (2) | Black 45 (2) | Purple/Olive 54 (1) | Black/Gold 45 (1) | Olive 54H [®] (2) | Black 45 (1) |
| — | — | — | — | Brown 87H [®] (2) | Yellow 62 (1) | Brown 87H [®] (2) | Yellow 62 (1) |
| — | — | — | — | Brown 87H [®] (2) | Blue 76H [®] (2) | Brown 87H [®] (2) | Blue 76 (1) |
| — | — | — | — | Black/Orange 106H [®] (2) | Purple/Olive 54 (1) | Black 106H [®] (2) | Olive 54H [®] (2) |
| — | — | — | — | Black/Orange 106H [®] (2) | Yellow 62 (1) | Black 106H [®] (2) | Yellow 62 (1) |
| — | — | — | — | Black/Orange 106H [®] (2) | Blue 76H [®] (2) | Black 106H [®] (2) | Blue 76 (1) |
| — | — | — | — | Black/Orange 106H [®] (2) | Brown 87H [®] (2) | Black 106H [®] (2) | Brown 87H [®] (2) |
| — | — | — | — | Black/Orange 106H [®] (2) | Pink 99H (2) | Black 106H [®] (2) | Pink 99H (2) |
| — | — | — | — | Black/Orange 106H [®] (2) | Black/Orange 106H [®] (2) | Black 106H [®] (2) | Black 106H [®] (2) |
| — | — | — | — | — | — | — | — |
| — | — | — | — | — | — | — | — |

©Half width dies.

For PANDUIT tooling, see pages D3.72 – D3.73
For Burndy tooling, see pages D3.74 – D3.75

A.
System
Overview

B1.
Cable
Ties

B2.
Cable
Accessories

B3.
Stainless
Steel Ties

C1.
Wiring
Duct

C2.
Surface
Raceway

C3.
Abrasion
Protection

C4.
Cable
Management

D1.
Terminals

D2.
Power
Connectors

D3.
Grounding
Connectors

E1.
Labeling
Systems

E2.
Labels

E3.
Pre-Printed
& Write-On
Markers

E4.
Permanent
Identification

E5.
Lockout/
Tagout
& Safety
Solutions

F.
Index

A. System Overview

For use with Copper Conductors

Installation Tooling and Die Selections for: Type PSC

B1. Cable Ties

How to read this chart

For PSCBRN-L parallel splice and CT-2001 crimping tool:

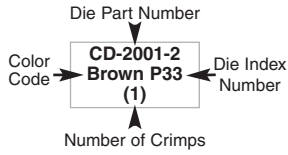

B2. Cable Accessories

B3. Stainless Steel Ties

C1. Wiring Duct

C2. Surface Raceway

C3. Abrasion Protection

C4. Cable Management

D1. Terminals

D2. Power Connectors

D3. Grounding Connectors

E1. Labeling Systems

E2. Labels

E3. Pre-Printed & Write-On Markers

E4. Permanent Identification

E5. Lockout/Tagout & Safety Solutions

F. Index

| | | PANDUIT Crimping Tool Part Number (See Compression Connector Tools Selection Guide, pages D3.30-D3.32) | | |
|-----------------------------------|--------------------------------|--|----------------------------------|--|
| PANDUIT Splice Part Number | Wire Strip Length (In.) | <i>Uni-Die™</i> Dieless CT-980, CT-980CH, CT-2950, CT-2980, CT-2981 | CT-2001, CT-2002 | CT-920, CT-930, CT-2940*, CT-920CH, CT-930CH, CT-940CH*, CT-2920, CT-2930, CT-2931 |
| | | Die Part Number/Color Code and Die Index Number (Number of Crimps) | | |
| PSCRED-L | 7/16 | — | CD-2001-8 Red P2 (1) | CD-920-8 Red P21 (1) |
| PSCBLU-L | 7/16 | — | CD-2001-6 Blue P2 (1) | CD-920-6 Blue P24 (1) |
| PSCGRY-L | 7/16 | (1) | CD-2001-4 Gray P29 (1) | CD-920-4 Gray P29 (1) |
| PSCBRN-L | 11/16 | (1) | CD-2001-2 Brown P33 (1) | CD-920-2 Brown P33 (1) |
| PSCGRN-L | 11/16 | (1) | CD-2001-1 Green P37 (1) | CD-920-1 Green P37 (1) |
| PSCPNK-L | 11/16 | (1) | CD-2001-1/0 Pink P42 (1) | CD-920-1/0 Pink P42 (1) |
| PSCBLK-Q | 7/8 | (1) | CD-2001-2/0 Black P45 (1) | CD-920-2/0 Black P45 (1) |
| PSCORG-Q | 7/8 | (1) | CD-2001-3/0 Orange P50 (1) | CD-920-3/0 Orange P50 (1) |
| PSCPUR-Q | 1 | (1) | CD-2001-4/0 Purple P54 (1) | CD-920-4/0 Purple P54 (1) |
| PSCYEL-Q | 1 1/16 | (1) | CD-2001-250 Yellow P62 (1) | CD-920-250 Yellow P62 (1) |

*CD-920 dies can be used with CT-940CH and CT-2940 tools with the CD-940-DA die adapter.

For use with
Copper
Conductors

Installation Tooling and Die Selections for: Type LCMA, LCMD, and SCMS

How to read this chart

For LCMA16
lug and CT-2001
crimping tool:

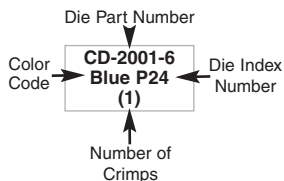

| PANDUIT Tool P/N | |
|---|--|
| Color and Die Index Number (Crimps Per Wire) | |
| CT-2001, CT-2002 (6 Ton Hyd.) | CT-930LPCH***, (10.5 Ton Hyd.) CT-920, CT-920CH, CT-2931, CT2931/E CT-2920 (12 Ton Hyd.) CT-930, CT-930CH, CT-2930 (14 Ton Hyd.) CT-940CH*, CT-2940* (15 Ton Hyd.) |

| PANDUIT Part Number | Wire Size | Wire Type | Wire Strip Length (mm) | CT-100, CT-200, CT-1570 (Manual) | CT-600 (Air) | CT-1701 (Manual) |
|---------------------------------|--------------------|-----------|------------------------------|---|-----------------------|---------------------|
| LCMA6, LCMD6 | 4-6mm ² | Class 2R | 11 | 22-10 (1) | CT-570CH 12-10 (1) | P10 (1) |
| LCMA10, LCMD10, SCMS10 | 10mm ² | Class 2R | 12 | – | – | – |
| LCMA16, LCMA16, SCMS16 | 16mm ² | Class 2R | 16 | – | – | – |
| LCMA25, LCMD25, SCMS25 | 25mm ² | Class 2R | 16.5 | – | – | – |
| LCMA35, LCMD35, SCMS35 | 35mm ² | Class 2R | 19 | – | – | – |
| LCMA50, LCMD50, SCMS50 | 50mm ² | Class 2R | 21.8 | – | – | – |
| LCMA70, LCMD70, SCMS70 | 70mm ² | Class 2R | 24.8 | – | – | – |
| LCMA95, LCMD95, SCMS95 | 95mm ² | Class 2R | 26 | – | – | – |
| LCMA120, LCMD120, SCMS120 | 120mm ² | Class 2R | 26 | – | – | – |
| LCMA150, LCMD150, SCMS150 | 150mm ² | Class 2R | 29 | – | – | – |
| LCMA185, LCMD185, SCMS185 | 185mm ² | Class 2R | 29.7 | – | – | – |
| LCMA240 LCMD240, SCMS240 | 240mm ² | Class 2R | 36.5 | – | – | – |
| LCMA300 LCMD300, SCMS300 | 300mm ² | Class 2R | 41.8 | – | – | – |
| LCMA400 LCMD400, SCMS400 | 400mm ² | Class 2R | 46.3 | – | – | – |
| LCMA500 LCMD500, SCMS500 | 500mm ² | Class 2R | 48 | – | – | – |
| LCMA630, LCMD630, SCMS630 | 630mm ² | Class 2R | 57.7 | – | – | – |

*CD-920 dies can be used with CT-940CH and CT-2940 tools with CD-940-DA adapter.

**CD-940 dies to be used exclusively with CT940CH and CT-2940 tools.

***Maximum size: 120mm² lugs and splices.

A.
System
Overview

B1.
Cable
Ties

B2.
Cable
Accessories

B3.
Stainless
Steel Ties

C1.
Wiring
Duct

C2.
Surface
Raceway

C3.
Abrasion
Protection

C4.
Cable
Management

D1.
Terminals

D2.
Power
Connectors

D3.
Grounding
Connectors

E1.
Labeling
Systems

E2.
Labels

E3.
Pre-Printed
& Write-On
Markers

E4.
Permanent
Identification

E5.
Lockout/
Tagout
& Safety
Solutions

F.
Index

A. System Overview

B1. Cable Ties

B2. Cable Accessories

B3. Stainless Steel Ties

C1. Wiring Duct

C2. Surface Raceway

C3. Abrasion Protection

C4. Cable Management

D1. Terminals

D2. Power Connectors

D3. Grounding Connectors

E1. Labeling Systems

E2. Labels

E3. Pre-Printed & Write-On Markers

E4. Permanent Identification

E5. Lockout/Tagout & Safety Solutions

F. Index

For use with Copper or Aluminum Conductors

Installation Tooling and Die Selections for: Types LAA, LAB, and SA

How to read this chart

For LAA6 and CT-2931 crimping tool:

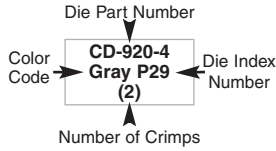

PANDUIT (See Compression Connector Tools Selection Guide, Pages D3.30 – D3.32)

| PANDUIT Part Number | Std. Wire Size | Wire Strip Length (In.) | PANDUIT (See Compression Connector Tools Selection Guide, Pages D3.30 – D3.32) | | |
|------------------------|----------------|-------------------------|--|------------------------|---|
| | | | CT-1700 ^① | CT-720 | CT-930, CT-930CH, CT-920, CT-920CH, CT-2920, CT-2930, CT-2931, CT-2940 ^③ , CT-940CH ^④ |
| L = Lugs S = Splice | | | Die Part Number/Color Code and Die Index Number/(Number of Crimps) | | |
| LAA6 | #6 AWG | 1 | Gray P29 (5) | CD-720-1 Gray P29 (2) | CD-920-4 Gray P29 (2) |
| SA6 | | 3/4 | | | |
| LAA4 | #4 AWG | 1-1/16 | Green P37 (5) | CD-720-2 Green P37 (2) | CD-920-1 Green P37 (2) |
| SA4 | | 7/8 | | | |
| LAA2 | #2 AWG | 1 | — | CD-720-2 Pink P42 (2) | CD-920-1/0 Pink P42 (2) |
| SA2 | | 7/16 | | | |
| LAA1 | #1 AWG | 1 | — | CD-720-2 Gold P45 (3) | CD-920-2/0 Gold P45 (2) |
| SA1 | | 7/16 | | | |
| LAA1/0 | 1/0 AWG | 1-9/16 | — | CD-720-2 Tan P50 (3) | CD-920-3/0 Tan P50 (2) |
| LAB1/0 | | 1 | | | |
| SA1/0 | 1 | | | | |
| LAA2/0 | 2/0 AWG | 1-9/16 | — | CD-720-3 Olive P54 (3) | CD-920-4/0 Olive P54 (2) |
| LAB2/0 | | 1-1/8 | | | |
| SA2/0 | 1-1/8 | | | | |
| LAA3/0 | 3/0 AWG | 1-9/16 | — | CD-720-3 Ruby P60 (4) | CD-920-250 Ruby P60 (2) |
| LAB3/0 | | 1-1/4 | | | |
| SA3/0 | 1-1/4 | | | | |
| LAA4/0 | 4/0 AWG | 1-3/4 | — | CD-720-4 White P66 (4) | CD-920-300 White P66 (2) |
| LAB4/0 | | 1-5/16 | | | |
| SA4/0 | 1-5/16 | | | | |
| LAA250 | 250 kcmil | 1-3/4 | — | CD-720-5 Red P71 (4) | CD-920-350 Red P71 (2) |
| LAB250 | | 1-7/16 | | | |
| SA250 | 1-7/16 | | | | |
| LAA300 | 300 kcmil | 2-5/16 | — | CD-720-6 Blue P76 (4) | CD-920-400 Blue P76 (2) |
| LAB300 | | 1-1/2 | | | |
| SA300 | 1-1/2 | | | | |
| LAA350 | 350 kcmil | 2-5/16 | — | CD-720-7 Brown P87 (4) | CD-920-500 Brown P87 (2) |
| LAB350 | | 1-5/8 | | | |
| SA350 | 1-5/8 | | | | |
| LAA400 | 400 kcmil | 2-9/16 | — | — | CD-920-800 Green P94 (4) |
| LAB400 | | 1-13/16 | | | |
| SA400 | 1-13/16 | | | | |
| LAA500 | 500 kcmil | 3-1/16 | — | — | CD-920-500A Pink P99 (4) |
| LAB500 | | 1-7/8 | | | |
| SA500 | 1-7/8 | | | | |
| LAA600 | 600 kcmil | 3-1/16 | — | — | CD-920-750, CD-940-750 ^④ Black P106 (4) |
| LAB600 | | 2 | | | |
| SA600 | 2 | | | | |
| LAA750 | 750 kcmil | 3-7/16 | — | — | CD-940-750A ^④ Red P125 (4) |
| LAB750 | | 2-1/4 | | | |
| SA750 | 2-1/4 | | | | |
| LAA800 | 800 kcmil | 3-7/16 | — | — | CD-940-800A ^④ Gray P140 (4) |
| LAB800 | | 2-5/16 | | | |
| SA800 | 2-5/16 | | | | |
| LAA1000 | 1000 kcmil | 4-3/4 | — | — | CD-940-1000A ^④ Brown P161 (4) |
| LAB1000 | | 2-9/16 | | | |
| SA1000 | 2-9/16 | | | | |

①The CT-1700 crimp die pockets are integrated into the tool frame.

③CD-920 dies can be used with CT-940CH and CT-2940 tools with CD-940-DA die adapter. Maximum size splice is 250 kcmil with CT-920, CT-920CH, and CT-2920 tools.

④CD-940 dies to be used exclusively with CT-940CH and CT-2940 tools.

For use with
Copper or
Aluminum
Conductors

Installation Tooling and Die Selections for: Types LAA, LAB, and SA (continued)

| PANDUIT Part Number L = Lug S = Splice | Std. Wire Size | Wire Strip Length (In.) | Thomas and Betts | | | Burndy | | | | Anderson |
|--|----------------|-------------------------|--|----------|--------------------------|--------|------------------|------------------|------------------|----------|
| | | | TBM5 | TBM8 | TBM15, TBMISI, TBMISBSCR | MY29 | Y35 | Y39 | Y45, Y46 | VC8 |
| | | | Die Part Number/Color Code and Die Index Number/(Number of Crimps) | | | | | | | |
| LAA6 | #6 AWG | 1 | Gray 29 | Gray 29 | Gray 29 | 6AL | U6CABT Gray 346 | U6CABT Gray 346 | U6CABT Gray 346 | STD |
| SA6 | | 3/4 | (2) | (2) | (2) | (1) | (1) | (1) | (1) | (1) |
| LAA4 | #4 AWG | 1-1/16 | Green 37 | Green 37 | Green 37 | 4AL | U4CABT Green 375 | U4CABT Green 375 | U4CABT Green 375 | STD |
| SA4 | | 7/8 | (2) | (2) | (2) | (1) | (1) | (1) | (1) | (1) |
| LAA2 | #2 AWG | 1 | Pink 42 | Pink 42 | Pink 42 | 2AL | U2CABT Pink 348 | U2CABT Pink 348 | U2CABT Pink 348 | STD |
| SA2 | | 7/16 | (3) | (3) | (2) | (1) | (2) | (2) | (2) | (1) |
| LAA1 | #1 AWG | 1 | Gold 45 | Gold 45 | Gold 45 | 1AL | U1CART Gold 471 | U1CART Gold 471 | U1CART Gold 471 | STD |
| SA1 | | 7/16 | (3) | (3) | (2) | (1) | (2) | (2) | (2) | (1) |
| LAA1/0 | 1/0 AWG | 1-9/16 | Tan 50 | Tan 50 | Tan 50 | 1/0AL | U25ART Tan 298 | U25ART Tan 298 | U25ART Tan 298 | STD |
| LAB1/0 | | 1 | (3) | (3) | (2) | (1) | (2) | (2) | (2) | (2) |
| SA1/0 | | | | | | | | | | |
| LAA2/0 | 2/0 AWG | 1-9/16 | Olive 54 | Olive 54 | Olive 54 | 2/0AL | U26ART Olive 297 | U26ART Olive 297 | U26ART Olive 297 | STD |
| LAB2/0 | | 1-1/8 | (3) | (3) | (3) | (2) | (2) | (2) | (2) | (2) |
| SA2/0 | | | | | | | | | | |
| LAA3/0 | 3/0 AWG | 1-9/16 | Ruby 60 | Ruby 60 | Ruby 60 | 3/0AL | U27ART Ruby 467 | U27ART Ruby 467 | U27ART Ruby 467 | STD |
| LAB3/0 | | 1-1/4 | (4) | (4) | (2) | (2) | (2) | (2) | (2) | (2) |
| SA3/0 | | | | | | | | | | |
| LAA4/0 | 4/0 AWG | 1-3/4 | — | White 66 | White 66 | 4/0AL | U28ART White 298 | U28ART White 298 | U28ART White 298 | STD |
| LAB4/0 | | 1-5/16 | — | (4) | (2) | (2) | (2) | (2) | (2) | (2) |
| SA4/0 | | | | | | | | | | |
| LAA250 | 250 kcmil | 1-3/4 | — | Red 71 | Red 71H [®] | — | U29ART Red 324 | U29ART Red 324 | U29ART Red 324 | STD |
| LAB250 | | 1-7/16 | — | (4) | (4) | — | (2) | (2) | (2) | (2) |
| SA250 | | | | | | | | | | |
| LAA300 | 300 kcmil | 2-5/16 | — | Blue 76 | Blue 76 | — | U30ART Blue 470 | U30ART Blue 470 | U30ART Blue 470 | STD |
| LAB300 | | 1-1/2 | — | (4) | (2) | — | (2) | (2) | (2) | (2) |
| SA300 | | | | | | | | | | |
| LAA350 | 350 kcmil | 2-5/16 | — | Brown 87 | Brown 87H [®] | — | U31ART Brown 299 | U31ART Brown 299 | U31ART Brown 299 | STD |
| LAB350 | | 1-5/8 | — | (4) | (4) | — | (2) | (2) | (2) | (2) |
| SA350 | | | | | | | | | | |
| LAA400 | 400 kcmil | 2-9/16 | — | — | Green 94H [®] | — | U32ART Green 472 | U32ART Green 472 | U32ART Green 472 | — |
| LAB400 | | 1-13/16 | — | — | (4) | — | (4) | (4) | (4) | — |
| SA400 | | | | | | | | | | |
| LAA500 | 500 kcmil | 3-1/16 | — | — | Pink 99H [®] | — | U34ART Pink 300 | U34ART Pink 300 | U34ART Pink 300 | — |
| LAB500 | | 1-7/8 | — | — | (4) | — | (4) | (4) | (4) | — |
| SA500 | | | | | | | | | | |
| LAA600 | 600 kcmil | 3-1/16 | — | — | Black 106 | — | U36ART Black 473 | U36ART Black 473 | U36ART Black 473 | — |
| LAB600 | | 2 | — | — | (3) | — | (4) | (4) | (4) | — |
| SA600 | | | | | | | | | | |
| LAA750 | 750 kcmil | 3-7/16 | — | — | Yellow 115H [®] | — | — | S39ART Red 301 | S39ART Red 301 | — |
| LAB750 | | 2-1/4 | — | — | (4) | — | — | (4) | (4) | — |
| SA750 | | | | | | | | | | |
| LAA800 | 800 kcmil | 3-7/16 | — | — | 125H [®] | — | — | Gray 474 | Gray 474 | — |
| LAB800 | | 2-5/16 | — | — | (4) | — | — | (4) | (4) | — |
| SA800 | | | | | | | | | | |
| LAA1000 | 1000 kcmil | 4-3/4 | — | — | 161 | — | — | S44ART Brown 302 | S44ART Brown 302 | — |
| LAB1000 | | 2-9/16 | — | — | (5) | — | — | (4) | (4) | — |
| SA1000 | | | | | | | | | | |

®Half width dies.

A. System Overview

B1. Cable Ties

B2. Cable Accessories

B3. Stainless Steel Ties

C1. Wiring Duct

C2. Surface Raceway

C3. Abrasion Protection

C4. Cable Management

D1. Terminals

D2. Power Connectors

D3. Grounding Connectors

E1. Labeling Systems

E2. Labels

E3. Pre-Printed & Write-On Markers

E4. Permanent Identification

E5. Lockout/Tagout & Safety Solutions

F. Index

For use with
Copper or
Aluminum
Conductors

Installation Tooling and Die Selections for: Type SAR (continued)

| Thomas and Betts | | | Burndy | | | Anderson |
|--|-----------------|---------------------------------|---------------|---|----------------------------|------------|
| TBM5 | TBM8 | TBM15, TBM15I, TBM15BSCR | MY29 | Y35, Y39, Y750, Y750-HS, BAT35, BAT750, PAT750, Y35BH, Y39BH, Y750BH, Y750-2, Y750BH-2 | Y45, Y46 | VC6 |
| Die Part Number/Color Code and Die Index Number/ (Number of Crimps) | | | | | | |
| Tan 50 (3) | Tan 50 (3) | Tan 50 (2) | 1/0 AL (1) | U25ART Tan 296 (2) | U25ART Tan 296 (2) | STD (1) |
| Tan 50 (3) | Tan 50 (3) | Tan 50 (2) | 1/0 AL (1) | U25ART Tan 296 (2) | U25ART Tan 296 (2) | STD (1) |
| — | Red 71 (4) | Red 71H ^① (4) | — | U29ART Red 324 (2) | U29ART Red 324 (2) | STD (2) |
| — | Red 71 (4) | Red 71H ^① (4) | — | U29ART Red 324 (2) | U29ART Red 324 (2) | STD (2) |
| — | Brown 87 (4) | Brown 87H ^① (4) | — | U31ART Brown 299 (2) | U31ART Brown 299 (2) | STD (2) |
| — | — | Pink 99H ^① (4) | — | U34ART Pink 300 (4) | U34ART Pink 300 (4) | — |
| — | — | Black 106 (3) | — | U36ART Black 473 (4) | U36ART Black 473 (4) | — |
| — | — | Yellow 115H ^① (4) | — | — | P39ART Red 301 (4) | — |

①Half width dies.

A.
System
Overview

B1.
Cable Ties

B2.
Cable
Accessories

B3.
Stainless
Steel Ties

C1.
Wiring
Duct

C2.
Surface
Raceway

C3.
Abrasion
Protection

C4.
Cable
Management

D1.
Terminals

D2.
Power
Connectors

D3.
Grounding
Connectors

E1.
Labeling
Systems

E2.
Labels

E3.
Pre-Printed
& Write-On
Markers

E4.
Permanent
Identification

E5.
Lockout/
Tagout
& Safety
Solutions

F.
Index

A. System Overview

B1. Cable Ties

B2. Cable Accessories

B3. Stainless Steel Ties

C1. Wiring Duct

C2. Surface Raceway

C3. Abrasion Protection

C4. Cable Management

D1. Terminals

D2. Power Connectors

D3. Grounding Connectors

E1. Labeling Systems

E2. Labels

E3. Pre-Printed & Write-On Markers

E4. Permanent Identification

E5. Lockout/Tagout & Safety Solutions

F. Index

For use with Copper or Aluminum Conductors

Installation Tooling and Die Selections for: Type BPC

How to read this chart

For BPC6 connector and CT-2001 crimping tool:

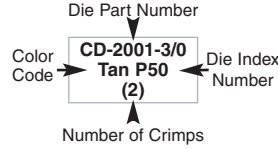

PANDUIT (See Compression Connector Tools Selection Guide, Pages D3.30 – D3.32)

| PANDUIT Part Number | Standard Wire Size | Wire Strip Length (In.) | PANDUIT (See Compression Connector Tools Selection Guide, Pages D3.30 – D3.32) | | |
|--|--------------------|-------------------------|--|-------------------------------|---|
| | | | CT-720 | CT-2001, CT-2002 | CT-930, CT-930CH, CT-2930, CT-2931, CT-920, CT-920CH, CT-2940 ^② , CT-2920, CT-940CH ^② |
| Die Part Number/Color Code and Die Index Number/(Number of Crimps) | | | | | |
| BPC6 | #6 AWG | 1-1/16 | CD-720-2 Tan P50 (2) | CD-2001-3/0 Tan P50 (2) | CD-920-3/0 Tan P50 (2) |
| BPC4 | #4 AWG | 1-1/16 | CD-720-2 Tan P50 (2) | CD-2001-3/0 Tan P50 (2) | CD-920-3/0 Tan P50 (2) |
| BPC2 | #2 AWG | 1-1/16 | CD-720-2 Tan P50 (2) | CD-2001-3/0 Tan P50 (2) | CD-920-3/0 Tan P50 (2) |
| BPC1 | #1 AWG | 1-1/16 | CD-720-2 Tan P50 (2) | CD-2001-3/0 Tan P50 (2) | CD-920-3/0 Tan P50 (2) |
| BPC1/0 | 1/0 AWG | 1-5/16 | CD-720-5 Red P71 (2) | CD-2001-350 Red P71 (3) | CD-920-350 Red P71 (2) |
| BPC2/0 | 2/0 AWG | 1-5/16 | CD-720-5 Red P71 (2) | CD-2001-350 Red P71 (3) | CD-920-350 Red P71 (2) |
| BPC3/0 | 3/0 AWG | 1-5/16 | CD-720-5 Red P71 (2) | CD-2001-350 Red P71 (3) | CD-920-350 Red P71 (2) |
| BPC4/0 | 4/0 AWG | 1-5/16 | CD-720-5 Red P71 (2) | CD-2001-350 Red P71 (3) | CD-920-350 Red P71 (2) |
| BPC250 | 250 kcmil | 1-7/16 | — | — | CD-920-800 Green P94 (2) |
| BPC300 | 300 kcmil | 1-7/16 | — | — | CD-920-800 Green P94 (2) |
| BPC350 | 350 kcmil | 1-7/16 | — | — | CD-920-800 Green P94 (2) |
| BPC400 | 400 kcmil | 1-7/16 | — | — | CD-920-750, CD-940-750 ^③ Black P106 (2) |
| BPC500 | 500 kcmil | 1-7/16 | — | — | CD-920-750, CD-940-750 ^③ Black P106 (2) |
| BPC600 | 600 kcmil | 1-15/16 | — | — | CD-940-750A ^③ Red P125 (2) |
| BPC750 | 750 kcmil | 1-15/16 | — | — | CD-940-750A ^③ Red P125 (2) |

②CD-920 dies can be used with CT-940CH and CT-2940 tools with CD-940-DA die adapter. Maximum size splice is 250 kcmil with CT-920, CT-920CH, and CT-2920 tools.

③CD-940 dies to be used exclusively with CT-940CH and CT-2940 tools.

For use with
Copper or
Aluminum
Conductors

Installation Tooling and Die Selections for: Type BPC (continued)

| Thomas and Betts | | | Burndy | |
|--|-----------------|---------------------------------|----------------------------|-------------------------------|
| 13642M | TBM8 | TBM15, TBM15I, TBM15BSCR | Y35, BAT35 | Y39, Y45, Y46, Y39BH |
| Die Part Number/Color Code and Die Index Number/(Number of Crimps) | | | | |
| Orange 50 (2) | Tan 50 (2) | Orange 50 (2) | U25ART Tan 296 (2) | U25ART Tan 296 (2) |
| Orange 50 (2) | Tan 50 (2) | Orange 50 (2) | U25ART Tan 296 (2) | U25ART Tan 296 (2) |
| Orange 50 (2) | Tan 50 (2) | Orange 50 (2) | U25ART Tan 296 (2) | U25ART Tan 296 (2) |
| Orange 50 (2) | Tan 50 (2) | Orange 50 (2) | U25ART Tan 296 (2) | U25ART Tan 296 (2) |
| Blue 76H ^① (2) | Blue 76 (2) | Blue 76 (2) | U28ART White 298 (2) | U28ART White 298 (2) |
| Blue 76H ^① (2) | Blue 76 (2) | Blue 76 (2) | U28ART White 298 (2) | U28ART White 298 (2) |
| Blue 76H ^① (2) | Blue 76 (2) | Blue 76 (2) | U28ART White 298 (2) | U28ART White 298 (2) |
| Blue 76H ^① (2) | Blue 76 (2) | Blue 76 (2) | U28ART White 298 (2) | U28ART White 298 (2) |
| Pink 99H ^① (2) | Brown 87 (3) | Brown 87H ^① (2) | U31ART Brown 299 (2) | U31ART Brown 299 (2) |
| Pink 99H ^① (2) | Brown 87 (3) | Brown 87H ^① (2) | U31ART Brown 299 (2) | U31ART Brown 299 (2) |
| Pink 99H ^① (2) | Brown 87 (3) | Brown 87H ^① (2) | U31ART Brown 299 (2) | U31ART Brown 299 (2) |
| Black 106H ^① (3) | — | Black 106H ^① (3) | U34ART Pink 300 (3) | U34ART Pink 300 (3) |
| Black 106H ^① (3) | — | Black 106H ^① (3) | U34ART Pink 300 (3) | U34ART Pink 300 (3) |
| Yellow 115H ^① (3) | — | Yellow 115H ^① (3) | — | U39ART-2 Yellow 936 (3) |
| Yellow 115H ^① (3) | — | Yellow 115H ^① (3) | — | U39ART-2 Yellow 936 (3) |

① Half width dies.

A.
System
Overview

B1.
Cable
Ties

B2.
Cable
Accessories

B3.
Stainless
Steel Ties

C1.
Wiring
Duct

C2.
Surface
Raceway

C3.
Abrasion
Protection

C4.
Cable
Management

D1.
Terminals

D2.
Power
Connectors

D3.
Grounding
Connectors

E1.
Labeling
Systems

E2.
Labels

E3.
Pre-Printed
& Write-On
Markers

E4.
Permanent
Identification

E5.
Lockout/
Tagout
& Safety
Solutions

F.
Index

A. System Overview

B1. Cable Ties

B2. Cable Accessories

B3. Stainless Steel Ties

C1. Wiring Duct

C2. Surface Raceway

C3. Abrasion Protection

C4. Cable Management

D1. Terminals

D2. Power Connectors

D3. Grounding Connectors

E1. Labeling Systems

E2. Labels

E3. Pre-Printed & Write-On Markers

E4. Permanent Identification

E5. Lockout/Tagout & Safety Solutions

F. Index

For use with Copper or Aluminum Conductors

Installation Tooling and Die Selections for: Type HTAP

How to read this chart

For HTAP2-8 tap and CT-2001 crimping tool:

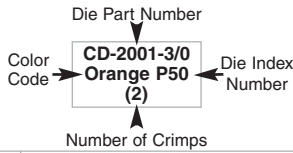

PANDUIT (See Compression Connector Tools Selection Guide, Pages D3.30 – D3.32)

| PANDUIT Part Number | Conductor Sizes | | CT-2001 CT-2002 | CT-920, CT-920CH, CT-930, CT-930CH, CT-2920, CT-2930, CT-2931, CT-2940 ^① , CT-940CH ^① |
|---------------------|--|--|----------------------------------|--|
| | Run | Tap | | |
| HTAP2-8 | #2 – #6 AWG STR #1 – #6 AWG SOL | #8 – #14 AWG STR #7 – #14 AWG SOL | CD-2001-3/0 Orange P50 (2) | CD-920-3/0 (1) |
| HTAP1-1 | #1 – #6 AWG STR #2 – #6 AWG SOL | #1 – #6 AWG STR #2 – #6 AWG SOL | CD-2001-0 Green P0 (4) | CD-920-0 (1) |
| HTAP1/0-1 | 1/0 – #6 AWG STR #2 – #6 AWG SOL | #1 – #6 AWG STR #2 – #6 AWG SOL | CD-2001-0 Green P0 (4) | CD-920-0 (1) |
| HTAP2/0-1 | 2/0 – #2 AWG STR #2 AWG SOL | #1 – #6 AWG STR #2 – #6 AWG SOL | CD-2001-0 Green P0 (4) | CD-920-0 (1) |
| HTAP3/0-1 | 3/0 – 1/0 AWG STR 4/0 – 3/0 AWG SOL | #1 – #6 AWG STR #2 – #6 AWG SOL | CD-2001-D3 ^③ (4) | CD-920-D3 (1) |
| HTAP3/0-3/0 | 3/0 – 1/0 AWG STR 4/0 – 3/0 AWG SOL | 3/0 – 1/0 AWG STR 4/0 – 3/0 AWG SOL | CD-2001-D3 ^③ (5) | CD-920-D3 (1) |
| HTAP4/0-2 | 4/0 – 3/0 AWG STR | #1 – #6 AWG STR #2 – #6 AWG SOL | CD-2001-D3 ^③ (4) | CD-920-D3 (1) |
| HTAP4/0-3/0 | 4/0 – 3/0 AWG STR | 3/0 – #1 AWG STR | CD-2001-D3 ^③ (6) | CD-920-D3 (1) |
| HTAP4/0-4/0 | 4/0 – 3/0 AWG STR | 4/0 – 3/0 AWG STR | CD-2001-D3 ^③ (7) | CD-920-D3 (2) |
| HTAP500-4/0 | 500 kcmil STR – 4/0 AWG STR | 4/0 – 1/0 AWG STR | — | CD-930-N CD-940-N ^② (3) |
| HTAP500-500 | 500 kcmil STR – 4/0 AWG STR | 500 kcmil STR – 4/0 – 1/0 AWG STR | — | CD-930-N CD-940-N ^② (2) |

①CD-920 and CD-930 dies can be used with CT-940CH and CT-2940 tools with CD-940-DA adapter.

②CD-940 dies to be used exclusively with CT-940CH and CT-2940 tools.

③Built into the CT-2001 crimping tool.

**For use with
Copper
Conductors**

Installation Tooling and Die Selections for: Type HTCT

**How to read
this chart**

For
HTCT6-6 tap
and CT-2931
crimping tool:

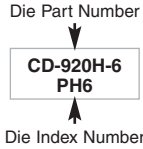

| Installation Tools | | |
|---|---------------------------------|--|
| 15 Ton | 14 Ton | 12 Ton |
| PANDUIT (See Compression Connector Tools Selection Guide, Pages D3.30 – D3.32) | | |
| CT-940CH ^① , CT-2940 ^① , | CT-930, CT-930CH, CT-2930 | CT-920, CT-920CH, CT-2920, CT-2931 |
| Burndy | | |
| Y46 ^① , Y46C ^① | — | Y35, Y35-2, Y35BH, Y35BH-4, Y750, Y39, Y39BH, Y750-2, Y750BH, Y750BH-2, Y750HS, BAT35, BAT750, PAT750, PAT750C |

| Thomas and Betts | | |
|----------------------|--|---|
| TBM15I, TBM15BSCR | TBM14M, TBM14BSCR, BPLT14BSCR, 13100A | — |

| PANDUIT Part Number | Copper Conductor Sizes (Code Cable) | | | | Copper Conductor Sizes (Flex Cable) Types G, H, I, K, M and Locomotive (DLO) | | | | Crimp Die Color Code | PANDUIT Crimp Die Part Number/Die Index No. (Number of Crimps = 1) | | |
|---------------------|-------------------------------------|---------------------|---------------------|--------------|--|------------------------------|--------------|--------------|----------------------|--|--|------------------|
| | Run | Tap 1 | Tap 2 | Tap 3 | Main | Tap 1 | Tap 2 | Tap 3 | | TBM15I, TBM15BSCR | TBM14M, TBM14BSCR, BPLT14BSCR, 13100A | — |
| HTCT8-8 | #8 – #14 AWG | #8 – #14 AWG | — | — | #8 – #14 AWG | #8 – #14 AWG | — | — | Green | CD-920H-8 PH8 | CD-920H-8 PH8 | CD-920H-8 PH8 |
| HTCT6-6 | #6 – #10 AWG | #6 – #14 AWG | — | — | #6 – #10 AWG | #6 – #14 AWG | — | — | Orange | CD-920H-6 PH6 | CD-920H-6 PH6 | CD-920H-6 PH6 |
| HTCT2-2 | #2 – #6 AWG | #2 – #6 AWG | #8 – #14 AWG | #8 – #14 AWG | #2 – #8 AWG | #2 – #8 AWG | #8 – #14 AWG | #8 – #14 AWG | Brown | CD-920H-2 PH2 | CD-920H-2 PH2 | CD-920H-2 PH2 |
| HTCT250-8 | 250 kcmil – #2 AWG | #8 – #14 AWG | #8 – #14 AWG | — | 4/0 – #2 AWG | #8 – #14 AWG | #8 – #14 AWG | — | Purple | CD-930H-250 PH25 | CD-930H-250 PH25 | CD-930H-250 PH25 |
| HTCT250-2 | 250 kcmil – #2 AWG | #2 – #6 AWG | #8 – #14 AWG | — | 4/0 – #2 AWG | #2 – #8 AWG | #8 – #14 AWG | — | Purple | CD-930H-250 PH25 | CD-930H-250 PH25 | CD-930H-250 PH25 |
| HTCT250-250 | 250 kcmil – #2 AWG | 250 kcmil – #2 AWG | — | — | 4/0 – #2 AWG | 4/0 – #2 AWG | — | — | Purple | CD-930H-250 PH25 | CD-930H-250 PH25 | CD-930H-250 PH25 |
| HTCT500-250 | 500 kcmil – 4/0 AWG | 250 kcmil – 1/0 AWG | #1 – #6 AWG STR/SOL | #8 – #14 AWG | 373 kcmil – 4/0 AWG | 4/0 – 1/0 AWG | #1 – #8 AWG | #8 – #14 AWG | Brown | CD-940H-500 PH50 | — | — |
| HTCT500-500 | 500 – 250 kcmil | 500 kcmil – 4/0 AWG | — | — | 373 kcmil – 4/0 AWG | 373 kcmil – 4/0 AWG | — | — | Brown | CD-940H-500 PH50 | — | — |
| HTCT750-4/0 | 750 – 350 kcmil | 4/0 – 1/0 AWG | #1 – #6 AWG | #2 – #14 AWG | 550 – 500 kcmil | 250 kcmil – 1/0 AWG | #1 – #8 AWG | #2 – #14 AWG | Yellow | CD-940H-750 PH75 | — | — |
| HTCT750-750 | 750 – 500 kcmil | 750 – 350 kcmil | — | — | 550 – 444 kcmil | 550 – 313 kcmil | — | — | Yellow | CD-940H-750 PH75 | — | — |
| HTCT1000-250 | 1000 – 750 kcmil | 250 kcmil – 1/0 AWG | #1 – #2 AWG | — | 777 – 500 kcmil | 4/0 – 1/0 AWG | #1 – #2 AWG | — | Yellow | CD-940H-750 PH75 | — | — |
| HTCT1000-1000 | 1000 – 750 kcmil | 1000 – 750 kcmil | — | — | 777 – 750 kcmil 777 – 500 kcmil | 777 – 500 kcmil 350 kcmil | — | — | White | CD-940H-1000 PH10 | — | — |

①CD-920H and CD-930H dies can be used with CT-940CH and CT-2940 PANDUIT tools and Y46 and Y46C Burndy tools with CD-940-DA adapter. PANDUIT crimping dies must be used with all tooling (PANDUIT and competitor) to maintain UL/CSA certifications for applications up to 600 V.

A.
System
Overview

B1.
Cable
Ties

B2.
Cable
Accessories

B3.
Stainless
Steel Ties

C1.
Wiring
Duct

C2.
Surface
Raceway

C3.
Abrasion
Protection

C4.
Cable
Management

D1.
Terminals

D2.
Power
Connectors

D3.
Grounding
Connectors

E1.
Labeling
Systems

E2.
Labels

E3.
Pre-Printed
& Write-On
Markers

E4.
Permanent
Identification

E5.
Lockout/
Tagout
& Safety
Solutions

F.
Index

A. System Overview

B1. Cable Ties

B2. Cable Accessories

B3. Stainless Steel Ties

C1. Wiring Duct

C2. Surface Raceway

C3. Abrasion Protection

C4. Cable Management

D1. Terminals

D2. Power Connectors

D3. Grounding Connectors

E1. Labeling Systems

E2. Labels

E3. Pre-Printed & Write-On Markers

E4. Permanent Identification

E5. Lockout/Tagout & Safety Solutions

F. Index

For use with Copper Conductors

Installation Tooling and Die Selections for: Type CTAPF

How to read this chart

For CTAPF6-12 tap and CT-2001 crimping tool:

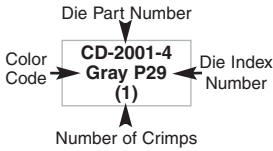

PANDUIT (See Compression Connector Tools Selection Guide, Pages D3.30 – D3.32)

| PANDUIT Part Number | Stranded Wire Size | | Die Part Number/Color Code and Die Index Number/ (Number of Crimps) | | | |
|---------------------|--------------------|---------------|---|---|------------------------------|----------------------------|
| | Main | Tap | 1700 ^① | CT-920, CT-920CH, CT-2920, CT-930, CT-930CH, CT-2930, CT-2931, CT-940CH ^② , CT-2940 ^② | CT-2001, CT-2002 | |
| CTAPF10-16 | #14 AWG | #16 – #14 AWG | Red P21 (2) | — | — | CD-2001-8 Red P21 (1) |
| | #12 AWG | #16 – #12 AWG | | | | |
| | #10 AWG | #14 AWG | | | | |
| CTAPF8-12 | #10 AWG | #10 AWG | Blue P24 (2) | — | — | CD-2001-6 Blue P24 (1) |
| | #8 AWG | #12 AWG | | | | |
| CTAPF6-12 | #8 AWG | #8 – #12 AWG | Gray P29 (2) | — | — | CD-2001-4 Gray P29 (1) |
| | #6 AWG | #12 – #10 AWG | | | | |
| CTAPF4-12 | #6 AWG | #8 – #6 AWG | Brown P33 (4) | CDM-920-2 Brown P33M (1) | CDM-2001-2 Brown P33M (1) | CD-2001-2 Brown P33 (2) |
| | #5, #4 AWG | #12 – #8 AWG | | | | |
| CTAPF3-12 | #5, #4 AWG | #6 – #5 AWG | Green P37 (4) | CDM-920-1 Green P37M (1) | CDM-2001-1 Green P37M (1) | CD-2001-1 Green P37 (2) |
| | #3 AWG | #12 – #6 AWG | | | | |
| CTAPF2-12 | #4 AWG | #4 AWG | — | CDM-920-1/0 Pink P42M (1) | CDM-2001-1/0 Pink P42M (1) | CD-2001-1/0 Pink P42 (2) |
| | #3 AWG | #5 AWG | | | | |
| | #2 AWG | #12 – #6 AWG | | | | |
| CTAPF1-12 | #3 AWG | #4 – #3 AWG | — | CDM-920-2/0 Black P45M (1) | CDM-2001-2/0 Black P45M (2) | CD-2001-2/0 Black P45 (3) |
| | #2 AWG | #5 – #4 AWG | | | | |
| | #1 AWG | #12 – #5 AWG | | | | |
| CTAPF1/0-12 | #2 AWG | #4 – #2 AWG | — | CDM-920-3/0 Orange P50M (1) | CDM-2001-3/0 Orange P50M (2) | CD-2001-3/0 Orange P50 (3) |
| | #1 AWG | #4 – #3 AWG | | | | |
| | 1/0 AWG | #12 – #4 AWG | | | | |
| CTAPF2/0-12 | #1 AWG | #2 – #1 AWG | — | CDM-920-4/0 Purple P54M (1) | — | CD-2001-4/0 Purple P54 (3) |
| | 1/0 AWG | #3 – #2 AWG | | | | |
| | 2/0 AWG | #12 – #3 AWG | | | | |
| CTAPF3/0-12 | 1/0 AWG | #1 – 1/0 AWG | — | CDM-920-250 Yellow P62M (1) | — | CD-2001-250 Yellow P62 (3) |
| | 2/0 AWG | #2 – #1 AWG | | | | |
| | 3/0 AWG | #12 – #2 AWG | | | | |

①The CT-1700 crimp die pockets are integrated into the tool frame.
 ②CDM-920 dies can be used with CT-940CH and CT-2940 tools with CD-940-DA adapter.

For use with
Copper
Conductors

Installation Tooling and Die Selections for: Type CTAPF (continued)

| PANDUIT Part Number | Stranded Wire Size | | Burndy | Thomas and Betts | |
|------------------------|--|---------------|---|--|---|
| | Run | Tap | Y35, Y39, Y45, Y46, Y750BH-2 Y750, BAT35, BAT750, Y35BH, Y39BH, Y750BH, Y750HS, PAT750, Y750-2 | Y500CT-HS, BCT500-HS, BCT500, Y500CT | TBM8-750, TBM8-750M-1, TBM8-750BSCR |
| | Die Part Number/Color Code and Die Index Number/ (Number of Crimps) | | | | |
| CTAPF10-16 | #14 AWG | #16 – #14 AWG | — | — | |
| | #12 AWG | #16 – #12 AWG | — | — | |
| | #10 AWG | #14 AWG | — | — | |
| CTAPF8-12 | #10 AWG | #10 AWG | — | — | |
| | #8 AWG | #12 AWG | — | — | |
| CTAPF6-12 | #8 AWG | #8 – #12 AWG | — | — | |
| | #6 AWG | #12 – #10 AWG | — | — | |
| CTAPF4-12 | #6 AWG | #8 – #6 AWG | UC4 Brown 10M (1) | WC4 Brown 10M (1) | TBM8-750C20 (1) |
| | #5, #4 AWG | #12 – #8 AWG | — | — | TBM8-750C2530 (1) |
| CTAPF3-12 | #5, #4 AWG | #6 – #5 AWG | — | — | TBM8-750C2530 (1) |
| | #3 AWG | #12 – #6 AWG | — | — | TBM8-750C2530 (1) |
| CTAPF2-12 | #4 AWG | #4 AWG | UC2 Pink 12M (1) | WC2 Pink 12M (1) | TBM8-750C2530 (1) |
| | #3 AWG | #5 AWG | — | — | — |
| | #2 AWG | #12 – #6 AWG | — | — | — |
| CTAPF1-12 | #3 AWG | #4 – #3 AWG | UC1 Black 13M (1) | WC1 Black 13M (2) | TBM8-750C3540 (1) |
| | #2 AWG | #5 – #4 AWG | — | — | — |
| | #1 AWG | #12 – #5 AWG | — | — | — |
| CTAPF1/0-12 | #2 AWG | #4 – #2 AWG | UC25 Orange 14M (1) | WC25 Orange 14M (2) | TBM8-750C3540 (1) |
| | #1 AWG | #4 – #3 AWG | — | — | — |
| | 1/0 AWG | #12 – #4 AWG | — | — | — |
| CTAPF2/0-12 | #1 AWG | #2 – #1 AWG | — | — | TBM8-750C4550 (1) |
| | 1/0 AWG | #3 – #2 AWG | — | — | — |
| | 2/0 AWG | #12 – #3 AWG | — | — | — |
| CTAPF3/0-12 | 1/0 AWG | #1 – 1/0 AWG | — | — | TBM8-750C4550 (1) |
| | 2/0 AWG | #2 – #1 AWG | — | — | — |
| | 3/0 AWG | #12 – #2 AWG | — | — | — |

A.
System
Overview

B1.
Cable Ties

B2.
Cable
Accessories

B3.
Stainless
Steel Ties

C1.
Wiring
Duct

C2.
Surface
Raceway

C3.
Abrasion
Protection

C4.
Cable
Management

D1.
Terminals

D2.
Power
Connectors

D3.
Grounding
Connectors

E1.
Labeling
Systems

E2.
Labels

E3.
Pre-Printed
& Write-On
Markers

E4.
Permanent
Identification

E5.
Lockout/
Tagout
& Safety
Solutions

F.
Index

A. System Overview

B1. Cable Ties

B2. Cable Accessories

B3. Stainless Steel Ties

C1. Wiring Duct

C2. Surface Raceway

C3. Abrasion Protection

C4. Cable Management

D1. Terminals

D2. Power Connectors

D3. Grounding Connectors

E1. Labeling Systems

E2. Labels

E3. Pre-Printed & Write-On Markers

E4. Permanent Identification

E5. Lockout/Tagout & Safety Solutions

F. Index

For use with Copper Conductors

Installation Tooling and Die Selections for: Type CTAP

How to read this chart

For CTAPF4-6 tap and CT-2001 crimping tool:

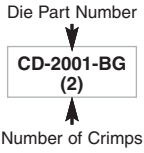

PANDUIT (See Compression Connector Tools Selection Guide, Pages D3.30 – D3.32)

Burndy

CT-920, CT-920CH, CT-930, CT-2920, CT-930CH, CT-2930, CT-2931, CT-940CH^①, CT-2940^①

CT-2001, CT-2002

MD6, MD7

BAT35, BAT750, PAT750, Y35, Y35BH, Y39, Y39BH, Y45, Y46, Y750, Y750HS, Y750BH

| PANDUIT Part Number | Conductor Size | | Wire Strip Length (In.) | Crimp Die Number/Index No. or Color Code/(No. of Crimps) | | | |
|---------------------|-------------------------------|------------------------|-------------------------|--|----------------|--------------------|---------------------|
| | Main | Tap | | PANDUIT | | Burndy | |
| CTAP4-8 | #6 – #4 AWG SOL or STR | #8 AWG SOL or STR | 3/4 | CD-920-BG (1) | CD-2001-BG (1) | W-BG (1) BG (2) | U-BG (1) |
| CTAP4-6 | #6 AWG STR, #4 AWG SOL or STR | #6 AWG SOL or STR | 3/4 | CD-920-BG (1) | CD-2001-BG (2) | W-BG (1) BG (2) | U-BG (1) |
| CTAP4-4 | #4 AWG SOL or STR | #4 AWG STR | 3/4 | CD-920-BG (1) | CD-2001-BG (1) | W-BG (1) BG (2) | U-BG (1) |
| CTAP2-4 | #2 AWG SOL or STR | #8 – #4 AWG SOL or STR | 7/8 | CD-920-C (1) | CD-2001-C (2) | W-C Brown (2) | U-C (1) |
| CTAP2-2 | #2 AWG SOL or STR | #2 AWG SOL or STR | 7/8 | CD-920-C (1) | CD-2001-C (2) | W-C Brown (2) | U-C (1) |
| CTAP2/0-2 | 1/0 – 2/0 AWG | #8 – #2 AWG SOL or STR | 1-1/16 | CD-920-0 Green (1) | — | — | U-O (1) U-E (3) |
| CTAP2/0-2/0 | 1/0 – 2/0 AWG STR | 1/0 – 2/0 AWG STR | 1-1/16 | CD-920-0 Green (1) | — | — | U-O (1) U-E (3) |
| CTAP4/0-2 | 3/0 – 4/0 AWG STR | #6 – #2 AWG SOL or STR | 1-1/4 | CD-920-D3 Blue (1) | — | — | U-F (2) U-D3 (1) |
| CTAP4/0-2/0 | 3/0 – 4/0 AWG STR | 1/0 – 2/0 AWG STR | 1-1/4 | CD-920-D3 Blue (1) | — | — | U-F (2) U-D3 (1) |
| CTAP4/0-4/0 | 3/0 – 4/0 AWG STR | 3/0 – 4/0 AWG STR | 1-1/4 | CD-920-D3 Blue (1) | — | — | U-F (2) U-D3 (1) |

①CD-920 dies can be used with CT-940CH and CT-2940 tools with CD-940-DA adapter.

NOTES

A.
System
Overview

B1.
Cable Ties

B2.
Cable
Accessories

B3.
Stainless
Steel Ties

C1.
Wiring
Duct

C2.
Surface
Raceway

C3.
Abrasion
Protection

C4.
Cable
Management

D1.
Terminals

D2.
Power
Connectors

D3.
Grounding
Connectors

E1.
Labeling
Systems

E2.
Labels

E3.
Pre-Printed
& Write-On
Markers

E4.
Permanent
Identification

E5.
Lockout/
Tagout/
& Safety
Solutions

F.
Index

A. System Overview

B1. Cable Ties

B2. Cable Accessories

B3. Stainless Steel Ties

C1. Wiring Duct

C2. Surface Raceway

C3. Abrasion Protection

C4. Cable Management

D1. Terminals

D2. Power Connectors

D3. Grounding Connectors

E1. Labeling Systems

E2. Labels

E3. Pre-Printed & Write-On Markers

E4. Permanent Identification

E5. Lockout/Tagout & Safety Solutions

F. Index

LABELING SYSTEMS

PANDUIT is a global leader in reliable and innovative solutions for identification and safety. Products are engineered for a wide variety of industries and applications – including electrical, electronics, industrial and network. *PANDUIT* provides enhanced productivity, reliability, and value with leading-edge software development, materials and equipment by designing and manufacturing a full line of labeling products, software and printers to assist you with your labeling requirements.



- World-class quality – ISO 9001 and ISO 14001
- High performance and reliability
- Wide variety of system solutions to meet the most demanding requirements
- Meet and exceed the requirements of UL, CSA, ISO, NEC and OSHA
- Strong service and support network – distributor partners, knowledgeable sales people, expert technical support and world-class customer service



PANDUIT provides a complete range of industrial products and tools – including hand-held labeling systems, desktop labeling systems, pre-printed labels and safety systems. Use *PANDUIT* for all your identification needs for wire and cable, electrical and electronic devices, agency compliance, workplace safety and more.



PRINTERS: THERMAL TRANSFER DESKTOP AND HAND-HELD

PANDUIT desktop thermal transfer printers enable fast, high quality label production for all your identification requirements. Use *PANDUIT* labeling software and desktop thermal transfer printers to produce on demand identification solutions quickly and economically. *PANDUIT* hand-held printers are designed for flexibility. Programmed with advanced functionality, *PANDUIT* printers make custom labeling easy.



Hand-Held Printers

- Create labels at remote job sites
- Provide crisp, clear, high quality thermal transfer print
- Easily identify moves, adds, or changes

Desktop Printers

- Compatible with *PANDUIT® EASY-MARK™* Labeling Software
- Provide crisp, clear, high quality thermal transfer print
- Compatible with *WINDOWS^* based PC operating systems

PANDUIT printers and our wide variety of labels provide solutions for all your project labeling needs.

^WINDOWS is a registered trademark of Microsoft Corporation in the United States and/or other countries.

A. System Overview

B1. Cable Ties

B2. Cable Accessories

B3. Stainless Steel Ties

C1. Wiring Duct

C2. Surface Raceway

C3. Abrasion Protection

C4. Cable Management

D1. Terminals

D2. Power Connectors

D3. Grounding Connectors

E1. Labeling Systems

E2. Labels

E3. Pre-Printed & Write-On Markers

E4. Permanent Identification

E5. Lockout/Tagout & Safety Solutions

F. Index

A.
System
Overview



PANTHER™ LS8E Hand-Held Thermal Transfer Printer and Accessories

B1.
Cable Ties

- Cut-to-length functionality eliminates label waste and label trimming labor
- Partial cut feature available to provide tear-apart strips of labels
- P1™ Label Cassette contains an integrated memory device for automatic formatting, recall of last legend used, and number of labels remaining in the cassette
- Market specific labeling tools simplify label creation for electrical components, panel building, and construction and maintenance

- USB interface for importing data, system upgrades, and printing from a wireless laptop or desktop computer
- Prints self-laminating labels, heat shrink tubing, die-cut component labels and continuous tapes
- Fast loading label cassette includes both label material and ribbon to make changing labels easy
- Large graphic display with backlight for improved visibility

B2.
Cable
Accessories

B3.
Stainless
Steel Ties

C1.
Wiring
Duct

C2.
Surface
Raceway



LS8E-KIT

C3.
Abrasion
Protection

C4.
Cable
Management



LS8E

D1.
Terminals

D2.
Power
Connectors

D3.
Grounding
Connectors

E1.
Labeling
Systems

- Economical identification system provides premium quality solutions at the lowest installed cost
- Cut-to-length functionality eliminates label waste and label trimming labor
- Partial cut feature available to provide tear-apart strips of labels
- P1™ Label Cassette contains an integrated memory device for automatic formatting, recall of last legend used, and number of labels remaining in the cassette

- Prints continuous military grade heat shrink tubing
- Prints a wide variety of continuous tapes for marking of wire marking, component labeling, and safety/facility identification
- Fast loading label cassette includes both label material and ribbon to make changing labels easy

E2.
Labels

E3.
Pre-Printed
& Write-On
Markers

E4.
Permanent
Identification

E5.
Lockout/
Tagout
& Safety
Solutions



F.
Index

| Part Number | Part Description | Std. Pkg. Qty. |
|------------------|--|----------------|
| LS8E-KIT | Includes LS8E printer, one cassette of S100X150VAC self-laminating labels, six AA alkaline batteries, LS8-CASE, LS8-PCKIT, LS8-WS, quick reference card and operator's manual. | 1 |
| LS8E | Includes LS8E printer, one cassette of S100X150VAC self-laminating labels, six AA alkaline batteries and quick reference card. | 1 |
| LS8E-ACS* | 120 VAC power adapter for North America. | 1 |
| LS8-CASE | Rigid carrying case. | 1 |
| LS8-PCKIT | Includes USB cable and PC interface software for importing data, system upgrades, or printing from a wireless laptop or desktop computer. | 1 |
| LS8-IB | Protective impact bumper. | 1 |
| LS8-WS | Wrist strap. | 1 |
| LS8-CLN | Cleaning kit. | 1 |

*Cannot be used to charge batteries.
Other adapters available, replace S with A (Australia), C (China), E (Europe) and U (UK).



COUGAR™ LS9 Hand-Held Thermal Transfer Printer and Accessories

| Part Number | Part Description | Std. Pkg. Qty. |
|-----------------|---|----------------|
| LS9 | Includes LS9 printer, one cassette of T100X000VPC-BK continuous tape, six AA alkaline batteries and quick reference card. | 1 |
| LS9-ACS* | 120 VAC power adapter for North America. | 1 |
| LS9-CASE | Rigid carrying case. | 1 |
| LS9-IB | Protective impact bumper. | 1 |
| LS9-WS | Wrist strap. | 1 |
| LS9-CLN | Cleaning kit. | 1 |

*Cannot be used to charge batteries.
Other adapters available, replace S with A (Australia), C (China), E (Europe) and U (UK).



Hand-Held Thermal Transfer Printing Solutions



PANTHER™ LS8E

COUGAR™ LS9

| | | |
|--------------------------------------|-----------|-----------|
| Die-Cut Component Labels | Page E1.8 | |
| Self-Laminating Labels | Page E1.3 | |
| Die-Cut Heat Shrink Tubing | Page E1.7 | |
| Continuous Heat Shrink Tubing | Page E1.6 | Page E1.6 |
| Vinyl Cloth Continuous Tapes | Page E1.5 | Page E1.5 |
| Continuous Tapes | Page E1.9 | Page E1.9 |

P1™ Self-Laminating Label Cassettes for PANTHER™ LS8E Hand-Held Thermal Transfer Printer

- P1™ Label Cassette contains an integrated memory device for automatic formatting, recall of last legend used, and number of labels remaining in the cassette
- Fast loading label cassette includes both label material and ribbon to make changing labels easy
- Self-laminating adhesive labels for wire/cable identification include a colored print-on area and clear overlamine
- Labels are available in a large range of wire/cable sizes



Part Number System for Wire/Cable Labeling

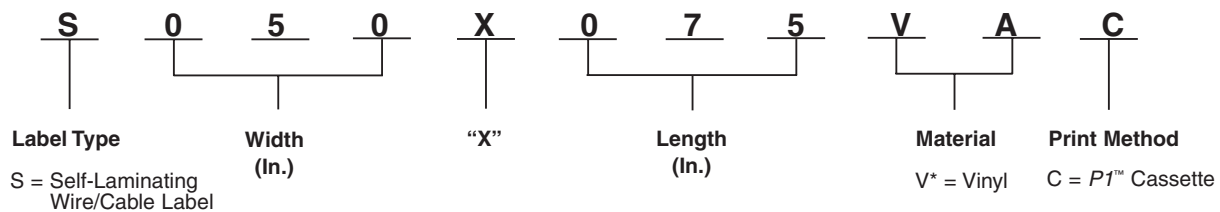

Material/Print Method Selection Chart

| Material | Print Method | Temperature Range | Features |
|--|--------------|-----------------------------------|--|
| Self-Laminating Vinyl, Colored Print-On (V*) | P1™ Cassette | -40°F to 200°F (-40°C to 93°C) | Indoor/outdoor rated; thin and conformable; preferred material for most general wire/cable labeling. |

Table continues on page E1.4

A. System Overview

B1. Cable Ties

B2. Cable Accessories

B3. Stainless Steel Ties

C1. Wiring Duct

C2. Surface Raceway

C3. Abrasion Protection

C4. Cable Management

D1. Terminals

D2. Power Connectors

D3. Grounding Connectors

E1. Labeling Systems

E2. Labels

E3. Pre-Printed & Write-On Markers

E4. Permanent Identification

E5. Lockout/Tagout & Safety Solutions

F. Index

A.
System
Overview

P1™ Self-Laminating Label Cassettes for PANTHER™ LS8E Hand-Held Thermal Transfer Printer (continued)

B1.
Cable Ties

B2.
Cable
Accessories

B3.
Stainless
Steel Ties

C1.
Wiring
Duct

C2.
Surface
Raceway

C3.
Abrasion
Protection

C4.
Cable
Management

D1.
Terminals

D2.
Power
Connectors

D3.
Grounding
Connectors

E1.
Labeling
Systems

E2.
Labels

E3.
Pre-Printed
& Write-On
Markers

E4.
Permanent
Identification

E5.
Lockout/
Tagout
& Safety
Solutions

F.
Index

| Part Number | Part Description | Width | | Length | | Print-On Height | | Min. Cable O.D. | | Max. Cable O.D. | | Std. Pkg. Qty. | Std. Ctn. Qty. |
|--------------------|--|-------|-------|--------|--------|-----------------|-------|-----------------|-------|-----------------|-------|----------------|----------------|
| | | In. | mm | In. | mm | In. | mm | In. | mm | In. | mm | | |
| S050X075VAC | White print-on area, vinyl label for 18 – 14 AWG wires, 450/cassette. | .50 | 12.70 | .75 | 19.05 | .25 | 6.35 | .08 | 2.02 | .16 | 4.04 | 1 | 10 |
| S050X125VAC | White print-on area, vinyl label for 12 – 10 AWG wires, 225/cassette. | .50 | 12.70 | 1.25 | 31.75 | .38 | 9.65 | .12 | 3.07 | .28 | 7.03 | 1 | 10 |
| S050X150VAC | White print-on area, vinyl label for 12 – 10 AWG wires, 225/cassette. | .50 | 12.70 | 1.50 | 38.10 | .50 | 12.70 | .16 | 4.04 | .32 | 8.09 | 1 | 10 |
| S075X075VAC | White print-on area, vinyl label for 18 – 14 AWG wires, 350/cassette. | .75 | 19.05 | .75 | 19.05 | .25 | 6.35 | .08 | 2.02 | .16 | 4.04 | 1 | 10 |
| S075X100VAC | White print-on area, vinyl label for 12 – 10 AWG wires, 275/cassette. | .75 | 19.05 | 1.00 | 25.40 | .38 | 9.65 | .12 | 3.05 | .20 | 5.08 | 1 | 10 |
| S075X125VAC | White print-on area, vinyl label for 12 – 10 AWG wires, 225/cassette. | .75 | 19.05 | 1.25 | 31.75 | .38 | 9.65 | .12 | 3.07 | .28 | 7.03 | 1 | 10 |
| S075X150VAC | White print-on area, vinyl label for Cat. 5e/Cat. 6 cables, 200/cassette. | .75 | 19.05 | 1.50 | 38.10 | .50 | 12.70 | .16 | 4.04 | .32 | 8.09 | 1 | 10 |
| S100X075VAC | White print-on area, vinyl label for 18 – 14 AWG wires, 350/cassette. | 1.00 | 25.40 | .75 | 19.05 | .25 | 6.35 | .08 | 2.02 | .16 | 4.04 | 1 | 10 |
| S100X125VAC | White print-on area, vinyl label for 12 – 10 AWG wires, 225/cassette. | 1.00 | 25.40 | 1.25 | 31.75 | .38 | 9.65 | .12 | 3.07 | .28 | 7.03 | 1 | 10 |
| S100X150VAC | White print-on area, vinyl label for Cat. 5e/Cat. 6 cables, 200/cassette. | 1.00 | 25.40 | 1.50 | 38.10 | .50 | 12.70 | .16 | 4.04 | .32 | 8.09 | 1 | 10 |
| S100X150VBC | Blue print-on area, vinyl label for Cat. 5e/Cat. 6 cables, 200/cassette. | 1.00 | 25.40 | 1.50 | 38.10 | .50 | 12.70 | .16 | 4.04 | .32 | 8.09 | 1 | 10 |
| S100X150VDC | Green print-on area, vinyl label for Cat. 5e/Cat. 6 cables, 200/cassette. | 1.00 | 25.40 | 1.50 | 38.10 | .50 | 12.70 | .16 | 4.04 | .32 | 8.09 | 1 | 10 |
| S100X150VHC | Red print-on area, vinyl label for Cat. 5e/Cat. 6 cables, 200/cassette. | 1.00 | 25.40 | 1.50 | 38.10 | .50 | 12.70 | .16 | 4.04 | .32 | 8.09 | 1 | 10 |
| S100X150VIC | Yellow print-on area, vinyl label for Cat. 5e/Cat. 6 cables, 200/cassette. | 1.00 | 25.40 | 1.50 | 38.10 | .50 | 12.70 | .16 | 4.04 | .32 | 8.09 | 1 | 10 |
| S100X225VAC | White print-on area, vinyl label for 8 – 4 AWG wires, 125/cassette. | 1.00 | 25.40 | 2.25 | 57.15 | .75 | 19.05 | .24 | 6.06 | .48 | 12.19 | 1 | 10 |
| S100X225VBC | Blue print-on area, vinyl label for 8 – 4 AWG wires, 125/cassette. | 1.00 | 25.40 | 2.25 | 57.15 | .75 | 19.05 | .24 | 6.06 | .48 | 12.19 | 1 | 10 |
| S100X225VDC | Green print-on area, vinyl label for 8 – 4 AWG wires, 125/cassette. | 1.00 | 25.40 | 2.25 | 57.15 | .75 | 19.05 | .24 | 6.06 | .48 | 12.19 | 1 | 10 |
| S100X225VHC | Red print-on area, vinyl label for 8 – 4 AWG wires, 125/cassette. | 1.00 | 25.40 | 2.25 | 57.15 | .75 | 19.05 | .24 | 6.06 | .48 | 12.19 | 1 | 10 |
| S100X225VIC | Yellow print-on area, vinyl label for 8 – 4 AWG wires, 125/cassette. | 1.00 | 25.40 | 2.25 | 57.15 | .75 | 19.05 | .24 | 6.06 | .48 | 12.19 | 1 | 10 |
| S100X400VAC | White print-on area, vinyl label for 2 – 1 AWG wires, 75/cassette. | 1.00 | 25.40 | 4.00 | 101.60 | 1.00 | 25.40 | .32 | 8.09 | .95 | 24.26 | 1 | 10 |
| S100X650VAC | White print-on area, vinyl label for 1/0 – 250 MCM wires, 50/cassette. | 1.00 | 25.40 | 6.50 | 165.10 | 1.50 | 38.10 | .48 | 12.19 | 1.59 | 40.39 | 1 | 10 |

Order number of cassettes required.
Other colors available, replace A with B (Blue), D (Green), H (Red) and I (Yellow).
Order number of cassettes required.

P1™ Non-Laminated Label Cassettes

- P1™ Label Cassette contains an integrated memory device for automatic formatting, recall of last legend used, and number of labels remaining in the cassette

- Fast loading label cassette includes both label material and ribbon to make changing labels easy
- Non-laminated adhesive labels for wire/cable identification



Part Number System for Wire/Cable Labeling

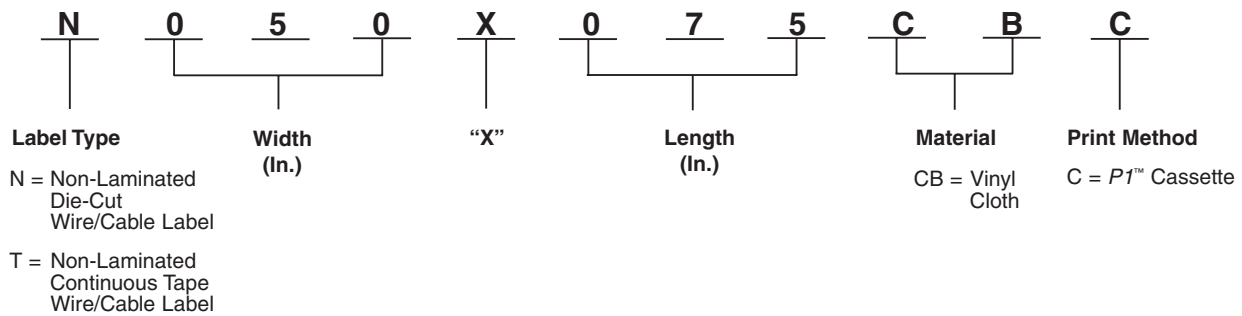

Material/Print Method Selection Chart

| Material | Print Method | Temperature Range | Features |
|------------------------------------|--------------|-----------------------------------|--|
| Vinyl Cloth White Print-On (CB) | P1™ Cassette | -50°F to 170°F (-46°C to 77°C) | General purpose material, vinyl impregnated cloth resists oil and abrasion; material can be removed, repositioned, and reused. |

| Part Number | Part Description | Height | | Length | | Std. Pkg. Qty. | Std. Ctn. Qty. |
|-------------|------------------|--------|----|--------|---|----------------|----------------|
| | | In. | mm | Ft. | m | | |

Continuous – For Use in PANTHER™ LS8E and COUGAR™ LS9 Hand-Held Thermal Transfer Printers

| | | | | | | | |
|----------------|-----------------------------------|------|-------|------|-----|---|----|
| T050X000CBC-BK | Black on white, vinyl cloth tape. | .50 | 12.70 | 12.5 | 3.8 | 1 | 10 |
| T100X000CBC-BK | Black on white, vinyl cloth tape. | 1.00 | 25.40 | 12.5 | 3.8 | 1 | 10 |

| Part Number | Part Description | Width | | Length | | Min. Cable O.D. | | Max. Cable O.D. | | Std. Pkg. Qty. | Std. Ctn. Qty. |
|-------------|------------------|-------|----|--------|----|-----------------|----|-----------------|----|----------------|----------------|
| | | In. | mm | In. | mm | In. | mm | In. | mm | | |

Die-Cut – For Use in PANTHER™ LS8E Hand-Held Thermal Transfer Printers

| | | | | | | | | | | | |
|-------------|--|------|-------|------|-------|-----|-------|------|-------|---|----|
| N050X075CBC | White, perforated vinyl cloth label for 18 – 14 AWG wires, 125/cassette. | .50 | 12.70 | .75 | 19.05 | .24 | 6.10 | .51 | 12.95 | 1 | 10 |
| N050X150CBC | White, perforated vinyl cloth label for Cat. 5e/Cat. 6 cable, 75/cassette. | .50 | 12.70 | 1.50 | 38.10 | .48 | 12.19 | 1.02 | 25.91 | 1 | 10 |
| N100X125CBC | White, perforated vinyl cloth label for 12 – 10 AWG wires, 75/cassette. | 1.00 | 25.40 | 1.25 | 31.75 | .40 | 10.16 | .85 | 21.59 | 1 | 10 |
| N100X150CBC | White, vinyl cloth label for Cat. 5e/Cat. 6 cable, 75/cassette. | 1.00 | 25.40 | 1.50 | 38.10 | .48 | 12.19 | 1.02 | 25.91 | 1 | 10 |
| N100X175CBC | White, perforated vinyl cloth label for 8 – 4 AWG wires, 50/cassette. | 1.00 | 25.40 | 1.75 | 44.45 | .56 | 14.22 | 1.19 | 30.23 | 1 | 10 |

Order number of rolls required.

A. System Overview

P1™ Military Grade Continuous Heat Shrink Label Cassettes for *PANTHER™* LS8E or *COUGAR™* LS9 Hand-Held Thermal Transfer Printers

B1. Cable Ties

- P1™ Label Cassette contains an integrated memory device for automatic formatting, recall of last legend used, and number of labels remaining in the cassette
- Fast loading label cassette includes both label material and ribbon to make changing labels easy

- Meets print performance requirements of MIL-M-81531 and MIL-STD-202F Method 215A, Solution A, C, and D
- Meets UL Standard 224 for flammability
- Shrink ratio 3:1
- Each cassette contains a continuous roll of non-adhesive flattened polyolefin that can be cut-to-length

B2. Cable Accessories

B3. Stainless Steel Ties



C1. Wiring Duct

C2. Surface Raceway

C3. Abrasion Protection

Part Number System for Wire/Cable Labeling

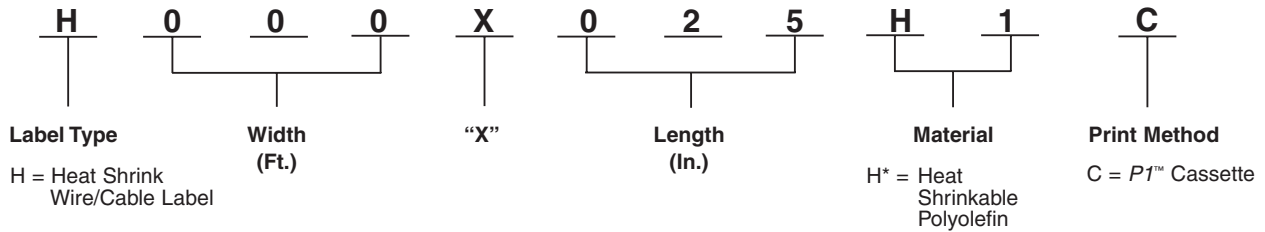

C4. Cable Management

D1. Terminals

D2. Power Connectors

D3. Grounding Connectors

Material/Print Method Selection Chart

| Material | Print Method | Temperature Range | Features |
|--|--------------|------------------------------------|---|
| Heat Shrinkable Polyolefin, White (H*) | P1™ Cassette | -22°F to 220°F (-30°C to 105°C) | Durable flattened polyolefin, high quality heat shrink wire/cable labels. |

E1. Labeling Systems

E2. Labels

E3. Pre-Printed & Write-On Markers

E4. Permanent Identification

E5. Lockout/Tagout & Safety Solutions

| Part Number | Part Description | Width | | Length | | Min. Cable Diameter | | Max. Cable Diameter | | Std. Pkg. Qty. | Std. Ctn. Qty. |
|--------------------|---|-------|-------|--------|------|---------------------|------|---------------------|-------|----------------|----------------|
| | | In. | mm | Ft. | m | In. | mm | In. | mm | | |
| H000X025H1C | White, 1/8" diameter heat shrinkable polyolefin, 22 – 16 AWG. | .25 | 6.35 | 8.0 | 2.44 | .04 | 1.02 | .13 | 3.30 | 1 | 10 |
| H000X025H2C | Yellow, 1/8" diameter heat shrinkable polyolefin, 22 – 16 AWG. | .25 | 6.35 | 8.0 | 2.44 | .04 | 1.02 | .13 | 3.30 | 1 | 10 |
| H000X034H1C | White, 3/16" diameter heat shrinkable polyolefin, 18 – 12 AWG. | .34 | 8.64 | 8.0 | 2.44 | .06 | 1.52 | .19 | 4.83 | 1 | 10 |
| H000X034H2C | Yellow, 3/16" diameter heat shrinkable polyolefin, 18 – 12 AWG. | .34 | 8.64 | 8.0 | 2.44 | .06 | 1.52 | .19 | 4.83 | 1 | 10 |
| H000X044H1C | White, 1/4" diameter heat shrinkable polyolefin, 16 – 10 AWG. | .44 | 11.18 | 6.0 | 1.83 | .08 | 2.03 | .25 | 6.35 | 1 | 10 |
| H000X044H2C | Yellow, 1/4" diameter heat shrinkable polyolefin, 16 – 10 AWG. | .44 | 11.18 | 6.0 | 1.83 | .08 | 2.03 | .25 | 6.35 | 1 | 10 |
| H000X084H1C | White, 1/2" diameter heat shrinkable polyolefin, 8 – 1 AWG. | .84 | 21.34 | 6.0 | 1.83 | .17 | 4.32 | .50 | 12.70 | 1 | 10 |
| H000X084H2C | Yellow, 1/2" diameter heat shrinkable polyolefin, 8 – 1 AWG. | .84 | 21.34 | 6.0 | 1.83 | .17 | 4.32 | .50 | 12.70 | 1 | 10 |

Order number of cassettes required.

F. Index

P1™ Military Grade Die-Cut Heat Shrink Label Cassettes for PANTHER™ LS8E Hand-Held Thermal Transfer Printer

- P1™ Label Cassette contains an integrated memory device for automatic formatting, recall of last legend used, and number of labels remaining in the cassette
- Fast loading label cassette includes both label material and ribbon to make changing labels easy
- Meets print performance requirements of MIL-M-81531 and MIL-STD-202F Method 215A, Solution A, C, and D
- Meets UL Standard 224 for flammability
- Shrink ratio 3:1
- Each cassette contains a roll of die-cut non-adhesive flattened polyolefin



Part Number System for Wire/Cable Labeling

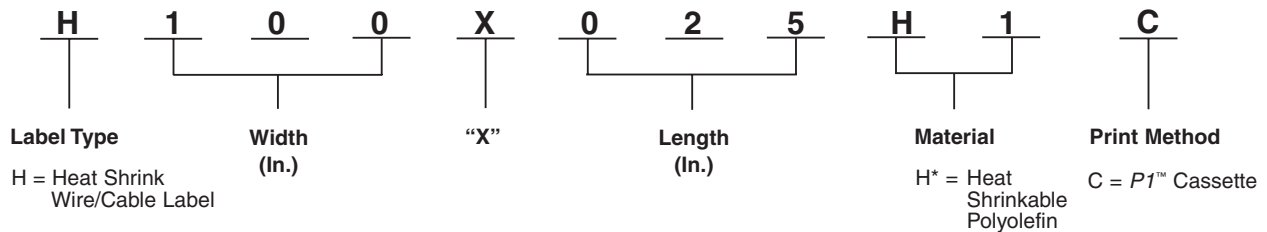

Material/Print Method Selection Chart

| Material | Print Method | Temperature Range | Features |
|---------------------------------|--------------|------------------------------------|---|
| Heat Shrinkable Polyolefin (H*) | P1™ Cassette | -22°F to 220°F (-30°C to 105°C) | Durable flattened polyolefin, high quality heat shrink wire/cable labels. |

| Part Number | Part Description | Width | | Length | | Min. Cable Diameter | | Max. Cable Diameter | | Std. Pkg. Qty. | Std. Ctn. Qty. |
|-------------|---|-------|-------|--------|-------|---------------------|------|---------------------|-------|----------------|----------------|
| | | In. | mm | In. | mm | In. | mm | In. | mm | | |
| H100X025H1C | White, 1/8" diameter heat shrinkable polyolefin, 22 – 16 AWG, 100/cassette. | .25 | 6.35 | 1.00 | 25.40 | .04 | 1.02 | .13 | 3.30 | 1 | 10 |
| H100X025H2C | Yellow, 1/8" diameter heat shrinkable polyolefin, 22 – 16 AWG, 100/cassette. | .25 | 6.35 | 1.00 | 25.40 | .04 | 1.02 | .13 | 3.30 | 1 | 10 |
| H100X034H1C | White, 3/16" diameter heat shrinkable polyolefin, 18 – 12 AWG, 100/cassette. | .34 | 8.64 | 1.00 | 25.40 | .06 | 1.52 | .19 | 4.83 | 1 | 10 |
| H100X034H2C | Yellow, 3/16" diameter heat shrinkable polyolefin, 18 – 12 AWG, 100/cassette. | .34 | 8.64 | 1.00 | 25.40 | .06 | 1.52 | .19 | 4.83 | 1 | 10 |
| H100X044H1C | White, 1/4" diameter heat shrinkable polyolefin, 16 – 10 AWG, 100/cassette. | .44 | 11.18 | 1.00 | 25.40 | .08 | 2.03 | .25 | 6.35 | 1 | 10 |
| H100X044H2C | Yellow, 1/4" diameter heat shrinkable polyolefin, 16 – 10 AWG, 100/cassette. | .44 | 11.18 | 1.00 | 25.40 | .08 | 2.03 | .25 | 6.35 | 1 | 10 |
| H100X084H1C | White, 1/2" diameter heat shrinkable polyolefin, 8 – 1 AWG, 75/cassette. | .84 | 21.34 | 1.00 | 25.40 | .17 | 4.32 | .50 | 12.70 | 1 | 10 |
| H100X084H2C | Yellow, 1/2" diameter heat shrinkable polyolefin, 8 – 1 AWG, 75/cassette. | .84 | 21.34 | 1.00 | 25.40 | .17 | 4.32 | .50 | 12.70 | 1 | 10 |

Order number of cassettes required.

A. System Overview

P1™ General Component Label Cassettes for PANTHER™ LS8E Hand-Held Thermal Transfer Printers

B1. Cable Ties

- P1™ Label Cassette contains an integrated memory device for automatic formatting, recall of last legend used, and number of labels remaining in the cassette
- Fast loading label cassette includes both label material and ribbon to make changing labels easy

- Use for identifying flat surfaces such as components, control panels, circuit boards and general labeling
- Die-cut labels designed to provide maximum aesthetic quality and appearance
- Available in polyester and vinyl cloth materials

B2. Cable Accessories

B3. Stainless Steel Ties



LS8E

C1. Wiring Duct

C2. Surface Raceway

C3. Abrasion Protection

Part Number System for Component Labeling

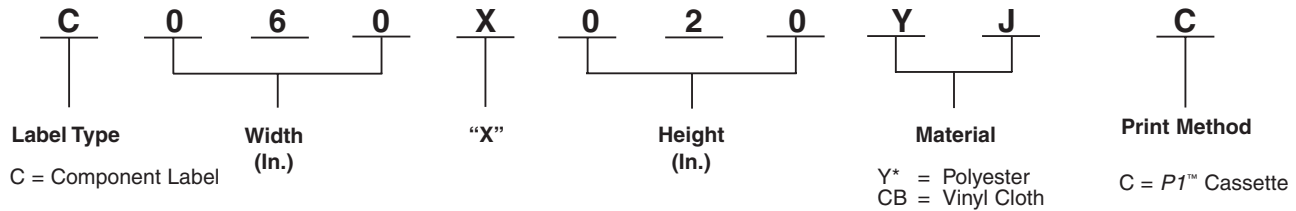

C4. Cable Management

D1. Terminals

D2. Power Connectors

D3. Grounding Connectors

| Material | Print Method | Temperature Range | Features |
|--------------------------------------|--------------|------------------------------------|---|
| Polyester, White (YJ) Silver (YM) | P1™ Cassette | -40°F to 302°F (-40°C to 150°C) | Indoor/outdoor rated; provides durability, high temperature resistance, and dimensional stability, does not stretch or easily tear. |
| Vinyl Cloth, White (CB) | | -50°F to 170°F (-46°C to 77°C) | General purpose material, vinyl impregnated cloth resists oil and abrasion; material can be removed, repositioned, and reused. |

E1. Labeling Systems

E2. Labels

E3. Pre-Printed & Write-On Markers

E4. Permanent Identification

E5. Lockout/Tagout & Safety Solutions

F. Index

| Part Number | Part Description | Width | | Height | | Std. Pkg. Qty. | Std. Ctn. Qty. |
|--------------------|---|-------|-------|--------|-------|----------------|----------------|
| | | In. | mm | In. | mm | | |
| C060X020YJC | White, polyester label, 750/cassette. | .60 | 15.24 | .20 | 5.08 | 1 | 10 |
| C100X025YJC | White, polyester label, 500/cassette. | 1.00 | 25.40 | .25 | 6.35 | 1 | 10 |
| C100X050CBC | White, vinyl cloth label, 175/cassette. | 1.00 | 25.40 | .50 | 12.70 | 1 | 10 |
| C100X050YJC | White, polyester label, 500/cassette. | 1.00 | 25.40 | .50 | 12.70 | 1 | 10 |
| C100X050YMC | Silver, polyester label, 500/cassette. | 1.00 | 25.40 | .50 | 12.70 | 1 | 10 |
| C150X075YJC | White, polyester label, 250/cassette. | 1.50 | 38.10 | .75 | 19.05 | 1 | 10 |
| C200X050CBC | White, vinyl cloth label, 50/cassette. | 2.00 | 50.80 | .50 | 12.70 | 1 | 10 |
| C200X050YJC | White, polyester label, 200/cassette. | 2.00 | 50.80 | .50 | 12.70 | 1 | 10 |
| C200X100YJC | White, polyester label, 200/cassette. | 2.00 | 50.80 | 1.00 | 25.40 | 1 | 10 |
| C200X100YMC | Silver, polyester label, 150/cassette. | 2.00 | 50.80 | 1.00 | 25.40 | 1 | 10 |

Order number of cassettes required.

P1™ Continuous Tape Cassettes for PANTHER™ LS8E and COUGAR™ LS9 Hand-Held Thermal Transfer Printers

- P1™ Label Cassette contains an integrated memory device for automatic formatting, recall of last legend used, and number of labels remaining in the cassette
- Fast loading label cassette includes both label material and ribbon to make changing labels easy
- Print custom pipe markers, voltage markers, signs and bin marker labels on demand
- Available in a variety of colors, widths, and adhesive materials including continuous polyolefin, polyester, and vinyl
- For flat label applications only



Part Number System for Continuous Tapes

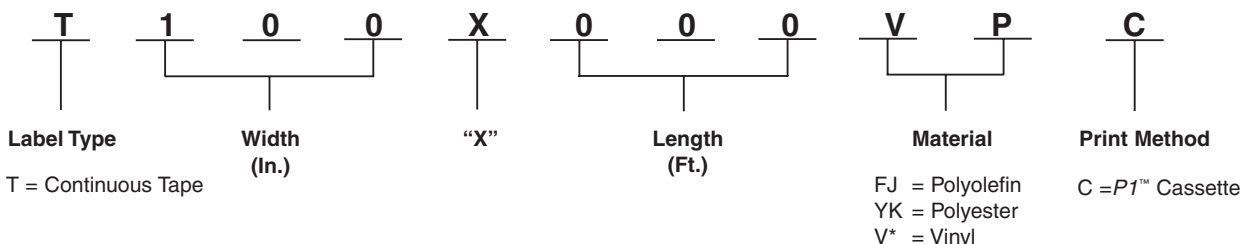

Material/Print Method Selection Chart

| Material | Print Method | Temperature Range | Features |
|--|--------------|------------------------------------|---|
| Polyolefin, White (FJ) | P1™ Cassette | -50°F to 120°F (-46°C to 49°C) | Indoor/outdoor rated; thin conformable material for general identification; excellent print quality. |
| Polyester, Clear (YK) | | -40°F to 302°F (-40°C to 150°C) | Indoor/outdoor rated; laminated label material protects legend from abrasion and chemicals; resistant to UV light chemical atmosphere and abrasion; excellent life and adhesion properties. |
| Vinyl, White (VP) Blue (VQ) Green (VS) Orange (VU) Red (VW) Yellow (VX) Black (VY) | | -40°F to 176°F (-40°C to 80°C) | Indoor/outdoor rated; conformable material for flat applications and safety and facility identification; can be overlaminated to increase durability. |

| Part Number | Part Description | Height | | Length | | Std. Pkg. Qty. | Std. Ctn. Qty. |
|-----------------------|--|--------|------|--------|-----|----------------|----------------|
| | | In. | mm | Ft. | m | | |
| T019X000FJC-BK | Black on white, polyolefin module label tape. | .19 | 4.83 | 25.0 | 7.6 | 1 | 10 |
| T024X000FJC-BK | Black on white, polyolefin tape, terminal block label. | .24 | 6.10 | 25.0 | 7.6 | 1 | 10 |
| T031X000FJC-BK | Black on white, polyolefin tape, terminal block label. | .31 | 7.87 | 25.0 | 7.6 | 1 | 10 |
| T038X000FJC-BK | Black on white, polyolefin tape, terminal block label. | .38 | 9.65 | 25.0 | 7.6 | 1 | 10 |

Order number of cassettes required.

Table continues on page E1.10

A. System Overview

B1. Cable Ties

B2. Cable Accessories

B3. Stainless Steel Ties

C1. Wiring Duct

C2. Surface Raceway

C3. Abrasion Protection

C4. Cable Management

D1. Terminals

D2. Power Connectors

D3. Grounding Connectors

E1. Labeling Systems

E2. Labels

E3. Pre-Printed & Write-On Markers

E4. Permanent Identification

E5. Lockout/Tagout & Safety Solutions

F. Index

A.
System
Overview

P1™ Continuous Tape Cassettes for PANTHER™ LS8E and COUGAR™ LS9 Hand-Held Thermal Transfer Printers (continued)

B1.
Cable Ties

B2.
Cable
Accessories

B3.
Stainless
Steel Ties

C1.
Wiring
Duct

C2.
Surface
Raceway

C3.
Abrasion
Protection

C4.
Cable
Management

D1.
Terminals

D2.
Power
Connectors

D3.
Grounding
Connectors

E1.
Labeling
Systems

E2.
Labels

E3.
Pre-Printed
& Write-On
Markers

E4.
Permanent
Identification

E5.
Lockout/
Tagout/
& Safety
Solutions

F.
Index

| Part Number | Part Description | Height | | Length | | Std. Pkg. Qty. | Std. Ctn. Qty. |
|----------------|---------------------------------|--------|-------|--------|-----|----------------|----------------|
| | | In. | mm | Ft. | m | | |
| T038X000VPC-BK | Black on white, vinyl tape. | .38 | 9.65 | 25.0 | 7.6 | 1 | 10 |
| T038X000VYC-WH | White on black, vinyl tape. | .38 | 9.65 | 25.0 | 7.6 | 1 | 10 |
| T038X000YKC-BK | Black on clear, polyester tape. | .38 | 9.65 | 25.0 | 7.6 | 1 | 10 |
| T050X000VPC-BK | Black on white, vinyl tape. | .50 | 12.70 | 25.0 | 7.6 | 1 | 10 |
| T050X000VQC-BK | Black on blue, vinyl tape. | .50 | 12.70 | 25.0 | 7.6 | 1 | 10 |
| T050X000VQC-WH | White on blue, vinyl tape. | .50 | 12.70 | 25.0 | 7.6 | 1 | 10 |
| T050X000VSC-BK | Black on green, vinyl tape. | .50 | 12.70 | 25.0 | 7.6 | 1 | 10 |
| T050X000VSC-WH | White on green, vinyl tape. | .50 | 12.70 | 25.0 | 7.6 | 1 | 10 |
| T050X000VUC-BK | Black on orange, vinyl tape. | .50 | 12.70 | 25.0 | 7.6 | 1 | 10 |
| T050X000VWC-BK | Black on red, vinyl tape. | .50 | 12.70 | 25.0 | 7.6 | 1 | 10 |
| T050X000VWC-WH | White on red, vinyl tape. | .50 | 12.70 | 25.0 | 7.6 | 1 | 10 |
| T050X000VXC-BK | Black on yellow, vinyl tape. | .50 | 12.70 | 25.0 | 7.6 | 1 | 10 |
| T050X000VYC-WH | White on black, vinyl tape. | .50 | 12.70 | 25.0 | 7.6 | 1 | 10 |
| T050X000YKC-BK | Black on clear, polyester tape. | .50 | 12.70 | 25.0 | 7.6 | 1 | 10 |
| T050X000YKC-WH | White on clear, polyester tape. | .50 | 12.70 | 25.0 | 7.6 | 1 | 10 |
| T075X000VPC-BK | Black on white, vinyl tape. | .75 | 19.05 | 25.0 | 7.6 | 1 | 10 |
| T075X000YKC-BK | Black on clear, polyester tape. | .75 | 19.05 | 25.0 | 7.6 | 1 | 10 |
| T100X000VPC-BK | Black on white, vinyl tape. | 1.00 | 25.40 | 25.0 | 7.6 | 1 | 10 |
| T100X000VQC-BK | Black on blue, vinyl tape. | 1.00 | 25.40 | 25.0 | 7.6 | 1 | 10 |
| T100X000VQC-WH | White on blue, vinyl tape. | 1.00 | 25.40 | 25.0 | 7.6 | 1 | 10 |
| T100X000VSC-BK | Black on green, vinyl tape. | 1.00 | 25.40 | 25.0 | 7.6 | 1 | 10 |
| T100X000VSC-WH | White on green, vinyl tape. | 1.00 | 25.40 | 25.0 | 7.6 | 1 | 10 |
| T100X000VUC-BK | Black on orange, vinyl tape. | 1.00 | 25.40 | 25.0 | 7.6 | 1 | 10 |
| T100X000VUC-WH | White on orange, vinyl tape. | 1.00 | 25.40 | 25.0 | 7.6 | 1 | 10 |
| T100X000VWC-BK | Black on red, vinyl tape. | 1.00 | 25.40 | 25.0 | 7.6 | 1 | 10 |
| T100X000VWC-WH | White on red, vinyl tape. | 1.00 | 25.40 | 25.0 | 7.6 | 1 | 10 |
| T100X000VXC-BK | Black on yellow, vinyl tape. | 1.00 | 25.40 | 25.0 | 7.6 | 1 | 10 |
| T100X000VXC-WH | White on yellow, vinyl tape. | 1.00 | 25.40 | 25.0 | 7.6 | 1 | 10 |
| T100X000VYC-WH | White on black, vinyl tape. | 1.00 | 25.40 | 25.0 | 7.6 | 1 | 10 |
| T100X000YKC-BK | Black on clear, polyester tape. | 1.00 | 25.40 | 25.0 | 7.6 | 1 | 10 |
| T100X000YKC-WH | White on clear, polyester tape. | 1.00 | 25.40 | 25.0 | 7.6 | 1 | 10 |

Order number of cassettes required.

TDP43MY Thermal Transfer Desktop Printer and Accessories

- Compact, lightweight design enables use in office or remote locations
- 300 dpi thermal transfer printer creates crisp, clear legends with superior legibility
- Up to 2.00 inches per second print speed for fast label production

- Use to print a wide variety of self-laminating labels, component labels, non-laminated labels, heat shrink labels, marker plates and continuous tapes up to 4.00 inches wide
- *EASY-MARK™* Labeling Software and hybrid ribbon included with printer



| Part Number | Description | Std. Pkg. Qty. |
|-------------|--|----------------|
| TDP43MY | 300 dpi printer; includes printer, <i>PANDUIT® EASY-MARK™</i> Labeling Software, RMH4BL hybrid black ribbon, AC power adapter with US and Europlug power cords, manual and quick start card. | 1 |
| TDP43M-RS | External label roll stand – used to rear feed labels that are supplied on 3.00" cores, such as photoluminescent tape. | 1 |
| TDP43M-CASE | Hardside carrying case. Accommodates printer, AC power adapter, ribbons, printer cable, labels and tools. | 1 |
| TDP43M-AC | Replacement AC power adapter with power cord (US cord only). | 1 |
| PTR-CLN | Printer cleaning kit – contains bottle of cleaning solution with MSDS, cleaning pen, swabs, alcohol wipes and cleaning instructions. | 1 |

Ribbons for Use with the TDP43MY Thermal Transfer Desktop Printer

- **Hybrid** – Recommended for use with self-laminating, heat shrink, component and non-laminated labels
- **Wax** – Recommended for use with self-laminating and non-laminated labels

- **Resin** – Recommended for use with component labels, marker plates, and continuous tape



| Part Number | Part Description | Height | | Length | | Std. Pkg. Qty. | Std. Ctn. Qty. |
|-------------|---|--------|--------|--------|------|----------------|----------------|
| | | In. | mm | Ft. | m | | |
| RMH2BL | Black, hybrid thermal transfer ribbon. For use with self-laminating, component, heat shrink and non-laminated labels. | 2.52 | 63.50 | 240.00 | 73.0 | 1 | 12 |
| RMH4BL | Black, hybrid thermal transfer ribbon. For use with self-laminating, component, heat shrink and non-laminated labels. | 4.33 | 110.00 | 240.00 | 73.0 | 1 | 12 |
| RMW2BL | Black, wax thermal transfer ribbon. For use with self-laminating vinyl and non-laminated labels. | 2.52 | 63.50 | 240.00 | 73.0 | 1 | 12 |
| RMW4BL | Black, wax thermal transfer ribbon. For use with self-laminating and non-laminated labels. | 4.33 | 110.00 | 240.00 | 73.0 | 1 | 12 |
| RMR2BL | Black, resin thermal transfer ribbon. For use with component labels, marker plates, and continuous tape. | 2.52 | 63.50 | 240.00 | 73.0 | 1 | 12 |
| RMR2WH | White, resin thermal transfer ribbon. For use with component labels, marker plates, and continuous tape. | 2.52 | 63.50 | 240.00 | 73.0 | 1 | 12 |
| RMR4BL* | Black, resin thermal transfer ribbon. For use with component labels, marker plates, and continuous tape. | 4.33 | 110.00 | 240.00 | 73.0 | 1 | 12 |

Order number of ribbons required.

*Other colors available, replace BL (Black) with WH (White), BU (Blue), GR (Green) or RD (Red).

A. System Overview

B1. Cable Ties

B2. Cable Accessories

B3. Stainless Steel Ties

C1. Wiring Duct

C2. Surface Raceway

C3. Abrasion Protection

C4. Cable Management

D1. Terminals

D2. Power Connectors

D3. Grounding Connectors

E1. Labeling Systems

E2. Labels

E3. Pre-Printed & Write-On Markers

E4. Permanent Identification

E5. Lockout/Tagout & Safety Solutions

F. Index

A. System Overview

TDP42HY, TDP43HY, TDP46HY Thermal Transfer Desktop Printers

B1. Cable Ties

- Rugged, high speed industrial printer
- 203, 305, or 609 dpi thermal transfer printers create crisp, clear legends with superior legibility
- Up to 10.00 inches per second print speed for fast label production
- Use to print a wide variety of self-laminating labels, component labels, non-laminated labels, marker plate, continuous tapes and heat shrink labels up to 4.00 inches wide
- *EASY-MARK™* Labeling Software and hybrid ribbon included with printer

B2. Cable Accessories

B3. Stainless Steel Ties



| Part Number | Part Description | Std. Pkg. Qty. |
|----------------|--|----------------|
| TDP42HY | 203 dpi printer for high volume applications, <i>PANDUIT® EASY-MARK™</i> Labeling Software, RHH4BL-S hybrid black ribbon, AC power adapter and manual. | 1 |
| TDP43HY | 305 dpi printer for high volume applications, <i>PANDUIT® EASY-MARK™</i> Labeling Software, RHH4BL-S hybrid black ribbon, AC power adapter and manual. | 1 |
| TDP46HY | 609 dpi printer for high volume applications, <i>PANDUIT® EASY-MARK™</i> Labeling Software, RHH4BL-S hybrid black ribbon, AC power adapter and manual. | 1 |

C1. Wiring Duct

C2. Surface Raceway

C3. Abrasion Protection

C4. Cable Management

D1. Terminals

Ribbons for use with the TDP42HY, TDP43HY and TDP46HY Thermal Transfer Desktop Printers

D2. Power Connectors

- **Hybrid** – Recommended for use with self-laminating, heat shrink, component and non-laminated labels
- **Wax** – Recommended for use with self-laminating and non-laminated labels
- **Resin** – Recommended for use with component labels, marker plates, and continuous tape

D3. Grounding Connectors



| Part Number | Part Description | Height | | Length | | Std. Pkg. Qty. | Std. Ctn. Qty. |
|-----------------|---|--------|--------|--------|--------|----------------|----------------|
| | | In. | mm | Ft. | m | | |
| RHH4BL-S | Black, hybrid thermal transfer ribbon. Recommended for use with self-laminating, heat shrink, component and non-laminated labels. | 4.33 | 109.98 | 1181.0 | 359.96 | 1 | 2 |
| RHW4BL-S | Black, wax thermal transfer ribbon. Recommended for use with self-laminating and non-laminated labels. | 4.33 | 109.98 | 1181.0 | 359.96 | 1 | 2 |
| RHR4BL-S | Black, resin thermal transfer ribbon. Recommended for use with component labels and continuous tape. | 4.33 | 109.98 | 1181.0 | 359.96 | 1 | 2 |

Order number of ribbons required.

E1. Labeling Systems

E2. Labels

E3. Pre-Printed & Write-On Markers

E4. Permanent Identification

E5. Lockout/Tagout & Safety Solutions

F. Index

LABELING SOFTWARE

PANDUIT labeling software is custom designed to address your requirements for wire/cable labeling, component identification, network administration, as well as, safety and facility identification. From control panel wire identification, terminal block and facility pipe marking to patch panel, faceplate and wire/cable marking, *PANDUIT* software is the solution for your on-demand identification requirements.



- *EASY-MARK™* Labeling Software is an easy-to-use, intuitive general purpose labeling software
- *CAD-CONNECT™* Labeling Software generates labels quickly and easily directly from an electronic CAD file

PANDUIT user-friendly software packages meet the unique requirements of your applications.

A.
System
Overview

B1.
Cable
Ties

B2.
Cable
Accessories

B3.
Stainless
Steel Ties

C1.
Wiring
Duct

C2.
Surface
Raceway

C3.
Abrasion
Protection

C4.
Cable
Management

D1.
Terminals

D2.
Power
Connectors

D3.
Grounding
Connectors

E1.
Labeling
Systems

E2.
Labels

E3.
Pre-Printed
& Write-On
Markers

E4.
Permanent
Identification

E5.
Lockout/
Tagout
& Safety
Solutions

F.
Index

A.
System
Overview

EASY-MARK™ Labeling Software

B1.
Cable Ties

- EASY-MARK™ Labeling Software simplifies label creation for the specific needs of your applications

- EASY-MARK™ Labeling Software is part of a complete line of innovative identification solutions from PANDUIT

B2.
Cable
Accessories

- Instructions and user interface are available in English, French, German, Italian, Spanish, Korean, Japanese, Chinese and Portuguese

- Supports most WINDOWS^ fonts drivers for standard thermal transfer, dot matrix, laser and ink jet, including PANDUIT thermal transfer printers

B3.
Stainless
Steel Ties

- Intuitive interview process allows automatic generation of labels and signs

System Requirements:

- Software selects and formats the optimum label for your specific application

- WINDOWS^ 2000, NT4.x, XP, or Vista; 64 MB hard drive space and 64 MB RAM (256 MB RAM recommended)

- **WYSIWYG** (What You See Is What You Get) user interface, alpha/numeric serialization, data import, symbol import

C1.
Wiring
Duct



| Part Number | Part Description | Std. Pkg. Qty. | Std. Ctn. Qty. |
|-------------------|--|----------------|----------------|
| PROG-EMCD3 | EASY-MARK™ Labeling Software supplied on CD-ROM. | 1 | 10 |

^WINDOWS is a registered trademark of Microsoft Corporation in the United States and/or other countries.

C2.
Surface
Raceway

C3.
Abrasion
Protection

CAD-CONNECT™ Labeling Software

C4.
Cable
Management

- Generates labels quickly and easily directly from electronic CAD files

- Exports to alternative formats such as EXCEL^ (XLS) or Text (CSV) files for future use and documentation

D1.
Terminals

- Eliminates steps and time spent manually copying CAD identifiers into labeling software

System Requirements:

- Program combines the power of an innovative wizard interview and EASY-MARK™ Labeling Software to capture and organize identifiers from electronic CAD files to automatically create and print labels

- WINDOWS^ 2000, NT4.x, XP, or Vista; 64 MB hard drive space and 64 MB RAM (256 MB RAM recommended)

D2.
Power
Connectors

- Compatible with full versions of AutoCAD* 2000i or newer, AutoCAD Mechanical 2007, and Visio^ 2002 or newer

D3.
Grounding
Connectors



| Part Number | Part Description | Std. Pkg. Qty. | Std. Ctn. Qty. |
|------------------|---|----------------|----------------|
| PROG-CCCD | CAD-CONNECT™ Labeling Software, including EASY-MARK™ Labeling Software, supplied on CD-ROM. | 1 | 10 |

*AutoCAD is a registered trademark of Autodesk, Inc.

^Visio, WINDOWS, and EXCEL are registered trademarks of Microsoft Corporation in the United States and/or other countries.

E1.
Labeling
Systems

E2.
Labels

E3.
Pre-Printed
& Write-On
Markers

E4.
Permanent
Identification

E5.
Lockout/
Tagout/
& Safety
Solutions

F.
Index

LABELS: LASER, INK JET, THERMAL TRANSFER AND DOT MATRIX

PANDUIT provides a full line of on demand printable labels designed to meet all of your identification needs.

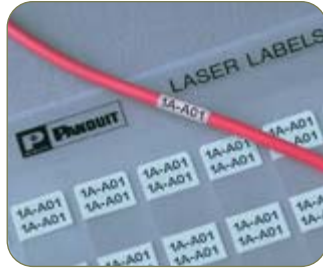

- Laser/ink jet labels supplied on 8.50" x 11.00" sheets and can be printed in commercially available laser and ink jet printers not sold by *PANDUIT*
- Thermal transfer labels supplied on rolls offer crisp, clear legends with superior legibility and can be printed on *PANDUIT* thermal transfer desktop printers or commercially available models
- Dot matrix labels supplied on pin feed sheets are a high quality, economical solution and can be printed on commercially available dot matrix printers not sold by *PANDUIT*
- Size illustrations are provided for reference

PANDUIT labeling solutions meet customer needs at the lowest total installed cost.

A.
System
Overview

B1.
Cable
Ties

B2.
Cable
Accessories

B3.
Stainless
Steel Ties

C1.
Wiring
Duct

C2.
Surface
Raceway

C3.
Abrasion
Protection

C4.
Cable
Management

D1.
Terminals

D2.
Power
Connectors

D3.
Grounding
Connectors

E1.
Labeling
Systems

E2.
Labels

E3.
Pre-Printed
& Write-On
Markers

E4.
Permanent
Identification

E5.
Lockout/
Tagout
& Safety
Solutions

F.
Index

Laser/Ink Jet Non-Laminated Labels

- Labels can be printed in both laser/ink jet printers
- Use as a wrap around label or flag style labels for wire/cable labeling

- Available in polyolefin material and supplied on 8.50" x 11.00" sheets
- *PANDUIT* labeling software packages include all label formats for quick and easy label production



Part Number System for Non-Laminated Labels

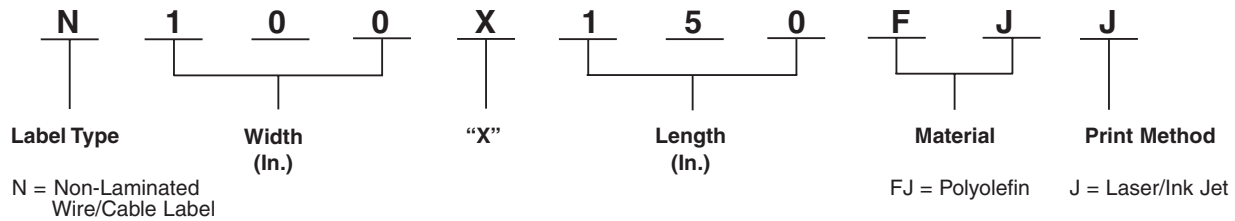

Material/Print Method Selection Guide

| Material | Print Method | Temperature Range | Features |
|------------------------|-------------------|-------------------------------|--|
| Polyolefin, White (FJ) | Laser/Ink Jet (J) | -50°F to 120°F (-46°C to 49°) | Indoor/outdoor rated; conformable material for general identification; excellent print quality |

| Part Number | Part Description | Width | | Length | | Min. Cable O.D. | | Max. Cable O.D. | | Std. Pkg. Qty. | Std. Ctn. Qty. |
|-------------|--------------------------|-------|-------|--------|-------|-----------------|-------|-----------------|-------|----------------|----------------|
| | | In. | mm | In. | mm | In. | mm | In. | mm | | |
| N025X075FJJ | White, polyolefin label. | .25 | 6.35 | .75 | 19.05 | .24 | 6.10 | .51 | 12.95 | 10000 | 50000 |
| N025X125FJJ | White, polyolefin label. | .25 | 6.35 | 1.25 | 31.75 | .40 | 10.16 | .85 | 21.95 | 10000 | 50000 |
| N050X075FJJ | White, polyolefin label. | .50 | 12.70 | .75 | 19.05 | .24 | 6.10 | .51 | 12.95 | 10000 | 50000 |
| N050X125FJJ | White, polyolefin label. | .50 | 12.70 | 1.25 | 31.75 | .40 | 10.16 | .85 | 21.59 | 10000 | 50000 |
| N050X150FJJ | White, polyolefin label. | .50 | 12.70 | 1.50 | 38.10 | .48 | 12.19 | 1.02 | 25.91 | 5000 | 25000 |
| N100X075FJJ | White, polyolefin label. | 1.00 | 25.40 | .75 | 19.05 | .24 | 6.10 | .51 | 12.95 | 5000 | 25000 |
| N100X125FJJ | White, polyolefin label. | 1.00 | 25.40 | 1.25 | 31.75 | .40 | 10.16 | .85 | 21.95 | 5000 | 25000 |
| N100X150FJJ | White, polyolefin label. | 1.00 | 25.40 | 1.50 | 38.10 | .48 | 12.19 | 1.02 | 25.91 | 2500 | 10000 |

Order number of labels required in multiples of Std. Pkg. Qty.

A. System Overview

B1. Cable Ties

B2. Cable Accessories

B3. Stainless Steel Ties

C1. Wiring Duct

C2. Surface Raceway

C3. Abrasion Protection

C4. Cable Management

D1. Terminals

D2. Power Connectors

D3. Grounding Connectors

E1. Labeling Systems

E2. Labels

E3. Pre-Printed & Write-On Markers

E4. Permanent Identification

E5. Lockout/Tagout & Safety Solutions

F. Index

Laser/Ink Jet Component Labels (continued)

| Part Number | Part Description | Width | | Height | | Std. Pkg. Qty. | Std. Ctn. Qty. |
|--------------|---|-------|--------|--------|--------|----------------|----------------|
| | | In. | mm | In. | mm | | |
| C038X038YJJ | White, polyester label. | .38 | 9.65 | .38 | 9.65 | 10000 | 50000 |
| C038X038YLJ | Yellow, polyester label. | .38 | 9.65 | .38 | 9.65 | 10000 | 50000 |
| C050X044YJJ | White, polyester label. | .50 | 12.70 | .44 | 11.18 | 10000 | 50000 |
| C060X020YJJ | White, polyester label. | .60 | 15.24 | .20 | 5.08 | 10000 | 50000 |
| C075X025YJJ | White, polyester label. | .75 | 19.05 | .25 | 6.35 | 10000 | 50000 |
| C075X025YLJ | Yellow, polyester label. | .75 | 19.05 | .25 | 6.35 | 10000 | 50000 |
| C080X020YJJ | White, polyester label. | .80 | 20.32 | .20 | 5.08 | 10000 | 50000 |
| C100X025YJJ | White, polyester label. | 1.00 | 25.40 | .25 | 6.35 | 10000 | 50000 |
| C100X050YJJ | White, polyester label. | 1.00 | 25.40 | .50 | 12.70 | 10000 | 50000 |
| C100X050YLJ | Yellow, polyester label. | 1.00 | 25.40 | .50 | 12.70 | 5000 | 25000 |
| C150X075YJJ | White, polyester label. | 1.50 | 38.10 | .75 | 19.05 | 2500 | 12500 |
| C160X020YJJ | White, polyester label. | 1.60 | 40.64 | .20 | 5.08 | 5000 | 20000 |
| C200X050YJJ | White, polyester label. | 2.00 | 50.80 | .50 | 12.70 | 1000 | 5000 |
| C200X100FJJ | White, polyolefin label, SLCT bundle marker identifier. | 2.00 | 50.80 | 1.00 | 25.40 | 1000 | 5000 |
| C200X100YJJ | White, polyester label. | 2.00 | 50.80 | 1.00 | 25.40 | 1000 | 5000 |
| C200X100YLJ | Yellow, polyester label. | 2.00 | 50.80 | 1.00 | 25.40 | 1000 | 5000 |
| C225X450FJJ | White, polyolefin label. | 2.25 | 57.15 | 4.50 | 114.30 | 150 | 750 |
| C350X500FJJ | White, polyolefin label. | 3.50 | 88.90 | 5.00 | 127.00 | 100 | 500 |
| C400X100YJJ | White, polyester label. | 4.00 | 101.60 | 1.00 | 25.40 | 1000 | 5000 |
| C400X200YJJ | White, polyester label. | 4.00 | 101.60 | 2.00 | 50.80 | 1000 | 5000 |
| C400X400YJJ | White, polyester label. | 4.00 | 101.60 | 4.00 | 101.60 | 250 | 1000 |
| C500X700FJJ | White, polyolefin label. | 5.00 | 127.00 | 7.00 | 177.80 | 50 | 250 |
| C850X1100YJJ | White, polyester label. | 8.50 | 215.90 | 11.00 | 279.40 | 25 | 100 |
| C850X1100YLJ | Yellow, polyester label. | 8.50 | 215.90 | 11.00 | 279.40 | 25 | 100 |

Order number of labels required in multiples of Std. Pkg. Qty.

A.
System
Overview

B1.
Cable Ties

B2.
Cable
Accessories

B3.
Stainless
Steel Ties

C1.
Wiring
Duct

C2.
Surface
Raceway

C3.
Abrasion
Protection

C4.
Cable
Management

D1.
Terminals

D2.
Power
Connectors

D3.
Grounding
Connectors

E1.
Labeling
Systems

E2.
Labels

E3.
Pre-Printed
& Write-On
Markers

E4.
Permanent
Identification

E5.
Lockout/
Tagout
& Safety
Solutions

F.
Index

A. System Overview

Thermal Transfer Self-Laminating Labels

B1. Cable Ties

- Self-laminating adhesive labels supplied on rolls, include a colored print-on area and clear overlamine
- Use with *PANDUIT* RMH4BL hybrid thermal transfer ribbon

B2. Cable Accessories



B3. Stainless Steel Ties

C1. Wiring Duct

Material/Print Method Selection Guide

| Material | Print Method | Temperature Range | Features |
|--|----------------------|---------------------------------|--|
| Self-Laminating TEDLAR®, White Print-On (TA) | Thermal Transfer (1) | -40°F to 275°F (-40°C to 135°C) | Indoor/outdoor rated; self-extinguishing; ideal for wire and cable labeling in harsh environments. |
| Self-Laminating Vinyl, White Print-On (VA) | Thermal Transfer (T) | -40°F to 200°F (-40°C to 93°C) | Indoor/outdoor rated; thin and conformable; preferred material for most general wire/cable labeling. |

*Tedlar is a registered trademark of E. I. DuPont de Nemours Co.

C4. Cable Management

Part Number System for Self-Laminating Labels

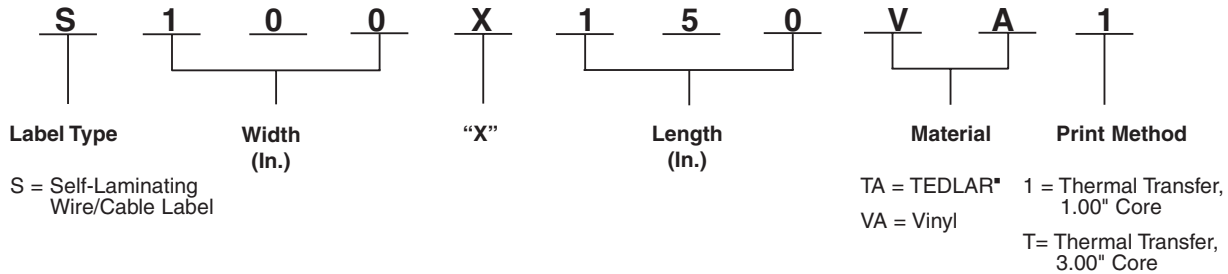

D1. Terminals

D2. Power Connectors

D3. Grounding Connectors

E1. Labeling Systems

| Part Number | Part Description | Width | | Length | | Print-On Area Height | | Min. Cable O.D. | | Max. Wire O.D. | | Std. Pkg. Qty. | Std. Ctn. Qty. |
|---------------------|---|-------|-------|--------|-------|----------------------|-------|-----------------|------|----------------|------|----------------|----------------|
| | | In. | mm | In. | mm | In. | mm | In. | mm | In. | mm | | |
| S050X075VA1Y | White print-on area, vinyl label for 18 – 14 AWG wires. | .50 | 12.70 | .75 | 19.05 | .25 | 6.35 | .12 | 3.07 | .16 | 4.04 | 5000 | 20000 |
| S050X075VATY | White print-on area, vinyl label for 18 – 14 AWG wires. | .50 | 12.70 | .75 | 19.05 | .25 | 6.35 | .12 | 3.07 | .16 | 4.04 | 5000 | 40000 |
| S050X125VA1Y | White print-on area, vinyl label for 12 – 10 AWG wires. | .50 | 12.70 | 1.25 | 31.75 | .38 | 9.65 | .12 | 3.07 | .28 | 7.03 | 5000 | 20000 |
| S050X125VATY | White print-on area, vinyl label for 12 – 10 AWG wires. | .50 | 12.70 | 1.25 | 31.75 | .38 | 9.65 | .12 | 3.07 | .28 | 7.03 | 5000 | 10000 |
| S050X150VA1Y | White print-on area, vinyl label. | .50 | 12.70 | 1.50 | 38.10 | .50 | 12.70 | .16 | 4.04 | .32 | 8.09 | 5000 | 60000 |
| S050X150VATY | White print-on area, vinyl label for Cat. 5e/Cat. 6 cables. | .50 | 12.70 | 1.50 | 38.10 | .50 | 12.70 | .16 | 4.04 | .32 | 8.09 | 5000 | 40000 |
| S075X075VATY | White print-on area, vinyl label for 18 – 14 AWG wires. | .75 | 19.05 | .75 | 19.05 | .25 | 6.35 | .12 | 3.07 | .16 | 4.04 | 5000 | 20000 |

*TEDLAR is a registered trademark of E.I. du Pont de Nemours and Company.

Order number of labels required in multiples of Std. Pkg. Qty.

Use with *PANDUIT* thermal transfer hybrid or wax ribbons.

Labels are roll mounted on 3.00" cores; when using the TDP43MY printer and 3.00" cores, the roll stand (TDP43M-RS) is required.

F. Index

Thermal Transfer Self-Laminating Labels (continued)

| Part Number | Part Description | Width | | Length | | Print-On Area Height | | Min. Cable O.D. | | Max. Wire O.D. | | Std. Pkg. Qty. | Std. Ctn. Qty. |
|--------------|---|-------|-------|--------|-------|----------------------|-------|-----------------|------|----------------|-------|----------------|----------------|
| | | In. | mm | In. | mm | In. | mm | In. | mm | In. | mm | | |
| S075X125VATY | White print-on area, vinyl label for 12 – 10 AWG wires. | .75 | 19.05 | 1.25 | 31.75 | .38 | 9.65 | .12 | 3.07 | .28 | 7.03 | 5000 | 20000 |
| S075X150VATY | White print-on area, vinyl label for Cat. 5e/Cat. 6 cables. | .75 | 19.05 | 1.50 | 38.10 | .50 | 12.70 | .16 | 4.04 | .32 | 8.09 | 5000 | 20000 |
| S100X075TAT | White print-on area, TEDLAR® label for 18 – 14 AWG wires. | 1.00 | 25.40 | .75 | 19.05 | .25 | 6.35 | .08 | 2.02 | .16 | 4.04 | 2500 | 10000 |
| S100X075VA1Y | White print-on area, vinyl label for 18 – 14 AWG wires. | 1.00 | 25.40 | .75 | 19.05 | .25 | 6.35 | .08 | 2.02 | .16 | 4.04 | 2500 | 10000 |
| S100X075VATY | White print-on area, vinyl label for 18 – 14 AWG wires. | 1.00 | 25.40 | .75 | 19.05 | .25 | 6.35 | .08 | 2.02 | .16 | 4.04 | 5000 | 10000 |
| S100X125TAT | White print-on area, TEDLAR® label for 12 – 10 AWG wires. | 1.00 | 25.40 | 1.25 | 31.75 | .38 | 9.65 | .12 | 3.07 | .28 | 7.03 | 2500 | 10000 |
| S100X125VA1Y | White print-on area, vinyl label. | 1.00 | 25.40 | 1.25 | 31.75 | .38 | 9.65 | .12 | 3.07 | .28 | 7.03 | 2500 | 10000 |
| S100X125VATY | White print-on area, vinyl label for 12 – 10 AWG wires. | 1.00 | 25.40 | 1.25 | 31.75 | .38 | 9.65 | .12 | 3.07 | .28 | 7.03 | 5000 | 10000 |
| S100X150TAT | White print-on area, TEDLAR® label for Cat. 5e/Cat. 6 cables. | 1.00 | 25.40 | 1.50 | 38.10 | .50 | 12.70 | .16 | 4.04 | .32 | 8.09 | 2500 | 10000 |
| S100X150VA1Y | White print-on area, vinyl label for Cat. 5e/Cat. 6 cables. | 1.00 | 25.40 | 1.50 | 38.10 | .50 | 12.70 | .16 | 4.04 | .32 | 8.09 | 2500 | 30000 |
| S100X150VATY | White print-on area, vinyl label for Cat. 5e/Cat. 6 cables. | 1.00 | 25.40 | 1.50 | 38.10 | .50 | 12.70 | .16 | 4.04 | .32 | 8.09 | 5000 | 20000 |
| S100X150VBTY | Blue print-on area, vinyl label for Cat. 5e/Cat. 6 cables. | 1.00 | 25.40 | 1.50 | 38.10 | .50 | 12.70 | .16 | 4.04 | .32 | 8.09 | 5000 | 20000 |
| S100X150VCTY | Brown print-on area, vinyl label for Cat. 5e/Cat. 6 cables. | 1.00 | 25.40 | 1.50 | 38.10 | .50 | 12.70 | .16 | 4.04 | .32 | 8.09 | 5000 | 20000 |
| S100X150VDTY | Green print-on area, vinyl label for Cat. 5e/Cat. 6 cables. | 1.00 | 25.40 | 1.50 | 38.10 | .50 | 12.70 | .16 | 4.04 | .32 | 8.09 | 5000 | 20000 |
| S100X150VETY | Gray print-on area, vinyl label for Cat. 5e/Cat. 6 cables. | 1.00 | 25.40 | 1.50 | 38.10 | .50 | 12.70 | .16 | 4.04 | .32 | 8.09 | 5000 | 20000 |
| S100X150VFTY | Orange print-on area, vinyl label for Cat. 5e/Cat. 6 cables. | 1.00 | 25.40 | 1.50 | 38.10 | .50 | 12.70 | .16 | 4.04 | .32 | 8.09 | 5000 | 20000 |
| S100X150VGTY | Purple print-on area, vinyl label for Cat. 5e/Cat. 6 cables. | 1.00 | 25.40 | 1.50 | 38.10 | .50 | 12.70 | .16 | 4.04 | .32 | 8.09 | 5000 | 20000 |
| S100X150VHTY | Red print-on area, vinyl label for Cat. 5e/Cat. 6 cables. | 1.00 | 25.40 | 1.50 | 38.10 | .50 | 12.70 | .16 | 4.04 | .32 | 8.09 | 5000 | 20000 |
| S100X150VITY | Yellow print-on area, vinyl label for Cat. 5e/Cat. 6 cables. | 1.00 | 25.40 | 1.50 | 38.10 | .50 | 12.70 | .16 | 4.04 | .32 | 8.09 | 5000 | 20000 |
| S100X150V0TY | Black print-on area, vinyl label for Cat. 5e/Cat. 6 cables. | 1.00 | 25.40 | 1.50 | 38.10 | .50 | 12.70 | .16 | 4.04 | .32 | 8.09 | 5000 | 20000 |
| S100X150V9TY | Gold print-on area, vinyl label for Cat. 5e/Cat. 6 cables. | 1.00 | 25.40 | 1.50 | 38.10 | .50 | 12.70 | .16 | 4.04 | .32 | 8.09 | 5000 | 20000 |
| S100X225TAT | White print-on area, TEDLAR® label for 8 – 4 AWG wires. | 1.00 | 25.40 | 2.25 | 57.15 | .75 | 19.05 | .24 | 6.06 | .48 | 12.13 | 1500 | 6000 |
| S100X225VA1Y | White print-on area, vinyl label for 8 – 4 AWG wires. | 1.00 | 25.40 | 2.25 | 57.15 | .75 | 19.05 | .24 | 6.06 | .48 | 12.13 | 1500 | 18000 |
| S100X225VATY | White print-on area, vinyl label for 8 – 4 AWG wires. | 1.00 | 25.40 | 2.25 | 57.15 | .75 | 19.05 | .24 | 6.06 | .48 | 12.13 | 5000 | 20000 |
| S100X225VBTY | Blue print-on area, vinyl label for 8 – 4 AWG wires. | 1.00 | 25.40 | 2.25 | 57.15 | .75 | 19.05 | .24 | 6.06 | .48 | 12.13 | 5000 | 20000 |
| S100X225VCTY | Brown print-on area, vinyl label for 8 – 4 AWG wires. | 1.00 | 25.40 | 2.25 | 57.15 | .75 | 19.05 | .24 | 6.06 | .48 | 12.13 | 5000 | 20000 |

*TEDLAR is a registered trademark of E.I. du Pont de Nemours and Company.
 Order number of labels required in multiples of Std. Pkg. Qty.
 Use with PANDUIT thermal transfer hybrid or wax ribbons.
 Labels are roll mounted on 3.00" cores; when using the TDP43MY printer and 3.00" cores, the roll stand (TDP43M-RS) is required.

Table continues on page E2.8

A.
System
Overview

B1.
Cable Ties

B2.
Cable
Accessories

B3.
Stainless
Steel Ties

C1.
Wiring
Duct

C2.
Surface
Raceway

C3.
Abrasion
Protection

C4.
Cable
Management

D1.
Terminals

D2.
Power
Connectors

D3.
Grounding
Connectors

E1.
Labeling
Systems

E2.
Labels

E3.
Pre-Printed
& Write-On
Markers

E4.
Permanent
Identification

E5.
Lockout/
Tagout
& Safety
Solutions

F.
Index

A.
System
Overview

Thermal Transfer Self-Laminating Labels (continued)

B1.
Cable Ties

B2.
Cable
Accessories

B3.
Stainless
Steel Ties

C1.
Wiring
Duct

C2.
Surface
Raceway

C3.
Abrasion
Protection

C4.
Cable
Management

D1.
Terminals

D2.
Power
Connectors

D3.
Grounding
Connectors

E1.
Labeling
Systems

E2.
Labels

E3.
Pre-Printed
& Write-On
Markers

E4.
Permanent
Identification

E5.
Lockout/
Tagout/
& Safety
Solutions

F.
Index

| Part Number | Part Description | Width | | Length | | Print-On Area Height | | Min. Cable O.D. | | Max. Wire O.D. | | Std. Pkg. Qty. | Std. Ctn. Qty. |
|---------------------|---|-------|-------|--------|--------|----------------------|-------|-----------------|-------|----------------|-------|----------------|----------------|
| | | In. | mm | In. | mm | In. | mm | In. | mm | In. | mm | | |
| S100X225VDTY | Green print-on area, vinyl label for 8 – 4 AWG wires. | 1.00 | 25.40 | 2.25 | 57.15 | .75 | 19.05 | .24 | 6.06 | .48 | 12.13 | 5000 | 20000 |
| S100X225VETY | Gray print-on area, vinyl label for 8 – 4 AWG wires. | 1.00 | 25.40 | 2.25 | 57.15 | .75 | 19.05 | .24 | 6.06 | .48 | 12.13 | 5000 | 20000 |
| S100X225VFTY | Orange print-on area, vinyl label for 8 – 4 AWG wires. | 1.00 | 25.40 | 2.25 | 57.15 | .75 | 19.05 | .24 | 6.06 | .48 | 12.13 | 5000 | 20000 |
| S100X225VGTY | Purple print-on area, vinyl label for 8 – 4 AWG wires. | 1.00 | 25.40 | 2.25 | 57.15 | .75 | 19.05 | .24 | 6.06 | .48 | 12.13 | 5000 | 20000 |
| S100X225VHTY | Red print-on area, vinyl label for 8 – 4 AWG wires. | 1.00 | 25.40 | 2.25 | 57.15 | .75 | 19.05 | .24 | 6.06 | .48 | 12.13 | 5000 | 20000 |
| S100X225VITY | Yellow print-on area, vinyl label for 8 – 4 AWG wires. | 1.00 | 25.40 | 2.25 | 57.15 | .75 | 19.05 | .24 | 6.06 | .48 | 12.13 | 5000 | 20000 |
| S100X225V0TY | Black print-on area, vinyl label for 8 – 4 AWG wires. | 1.00 | 25.40 | 2.25 | 57.15 | .75 | 19.05 | .24 | 6.06 | .48 | 12.13 | 5000 | 20000 |
| S100X225V9TY | Gold print-on area, vinyl label for 8 – 4 AWG wires. | 1.00 | 25.40 | 2.25 | 57.15 | .75 | 19.05 | .24 | 6.06 | .48 | 12.13 | 5000 | 20000 |
| S100X400VA1Y | White print-on area, vinyl label for 2 – 1 AWG wires. | 1.00 | 25.40 | 4.00 | 101.60 | 1.00 | 25.40 | .32 | 8.09 | .95 | 24.26 | 1000 | 4000 |
| S100X400VATY | White print-on area, vinyl label for 2 – 1 AWG wires. | 1.00 | 25.40 | 4.00 | 101.60 | 1.00 | 25.40 | .32 | 8.09 | .95 | 24.26 | 2500 | 12500 |
| S100X650VA1Y | White print-on area, vinyl label for 1/0 – 250 MCM wires. | 1.00 | 25.40 | 6.50 | 165.10 | 1.50 | 38.10 | .48 | 12.13 | 1.59 | 40.43 | 250 | 1000 |
| S100X650VATY | White print-on area, vinyl label for 1/0 – 250 MCM wires. | 1.00 | 25.40 | 6.50 | 165.10 | 1.50 | 38.10 | .48 | 12.13 | 1.59 | 40.43 | 1000 | 2000 |
| S150X150VATY | White print-on area, vinyl label for Cat 5e/Cat 6 cables. | 1.50 | 38.10 | 1.50 | 38.10 | .50 | 12.70 | .16 | 4.04 | .32 | 8.09 | 5000 | 20000 |
| S150X225VATY | White print-on area, vinyl label for 8 – 4 AWG wires. | 1.50 | 38.10 | 2.25 | 57.15 | .75 | 19.05 | .24 | 6.06 | .48 | 12.13 | 5000 | 20000 |
| S150X400VATY | White print-on area, vinyl label for 2 – 1 AWG wires. | 1.50 | 38.10 | 4.00 | 101.60 | 1.00 | 25.40 | .32 | 8.09 | .95 | 24.26 | 2500 | 10000 |
| S200X225VA1Y | White print-on area, vinyl label for 8 – 4 AWG wires. | 2.00 | 50.80 | 2.25 | 57.15 | .75 | 19.05 | .24 | 6.06 | .48 | 12.13 | 500 | 2000 |
| S200X225VATY | White print-on area, vinyl label for 8 – 4 AWG wires. | 2.00 | 50.80 | 2.25 | 57.15 | .75 | 19.05 | .24 | 6.06 | .48 | 12.13 | 1000 | 4000 |
| S200X400TAT | White print-on area, TEDLAR® label for 2 – 1 AWG wires. | 2.00 | 50.80 | 4.00 | 101.60 | 1.00 | 25.40 | .32 | 8.09 | .95 | 24.26 | 500 | 2000 |
| S200X400VA1Y | White print-on area, vinyl label for 2 – 1 AWG wires. | 2.00 | 50.80 | 4.00 | 101.60 | 1.00 | 25.40 | .32 | 8.09 | .95 | 24.26 | 500 | 2000 |
| S200X400VATY | White print-on area, vinyl label for 2 – 1 AWG wires. | 2.00 | 50.80 | 4.00 | 101.60 | 1.00 | 25.40 | .32 | 8.09 | .95 | 24.26 | 1000 | 3000 |
| S200X650VA1Y | White print-on area, vinyl label for 1/0 – 250 MCM wires. | 2.00 | 50.80 | 6.50 | 165.10 | 1.50 | 38.10 | .48 | 12.13 | 1.59 | 40.43 | 250 | 1000 |
| S200X650VATY | White print-on area, vinyl label for 1/0 – 250 MCM wires. | 2.00 | 50.80 | 6.50 | 165.10 | 1.50 | 38.10 | .48 | 12.13 | 1.59 | 40.43 | 1000 | 2000 |

*TEDLAR is a registered trademark of E.I. du Pont de Nemours and Company.
Order number of labels required in multiples of Std. Pkg. Qty.
Use with *PANDUIT* thermal transfer hybrid or wax ribbons.
Labels are roll mounted on 3.00" cores; when using the TDP43MY printer and 3.00" cores, the roll stand (TDP43M-RS) is required.

Thermal Transfer Marker Plates



- Non-adhesive marker plates offer crisp, clear legends with superior legibility
- Attachable in a horizontal or vertical orientation
- Available in a variety of colors and sizes
- Use with *PANDUIT* RMR4BL resin thermal transfer ribbon

| Part Number | Part Description | Width | | Height | | Print-On Area Width | | Std. Pkg. Qty. | Std. Ctn. Qty. |
|-------------|--|-------|-------|--------|-------|---------------------|-------|----------------|----------------|
| | | In. | mm | In. | mm | In. | mm | | |
| M300X100Y6T | Yellow, thermal transfer marker plate. | 3.00 | 76.20 | 1.00 | 25.40 | 1.80 | 45.70 | 1 | 4 |
| M300X100Y7T | White, thermal transfer marker plate. | 3.00 | 76.20 | 1.00 | 25.40 | 1.80 | 45.70 | 1 | 4 |
| M300X050Y6T | Yellow, thermal transfer marker plate. | 3.00 | 76.20 | .50 | 12.70 | 1.80 | 45.70 | 1 | 4 |
| M300X050Y7T | White, thermal transfer marker plate. | 3.00 | 76.20 | .50 | 12.70 | 1.80 | 45.70 | 1 | 4 |
| M200X100Y6T | Yellow, thermal transfer marker plate. | 2.00 | 50.80 | 1.00 | 25.40 | .80 | 20.30 | 1 | 4 |
| M200X100Y7T | White, thermal transfer marker plate. | 2.00 | 50.80 | 1.00 | 25.40 | .80 | 20.30 | 1 | 4 |
| M200X050Y6T | Yellow, thermal transfer marker plate. | 2.00 | 50.80 | .50 | 12.70 | 1.07 | 27.30 | 1 | 4 |
| M200X050Y7T | White, thermal transfer marker plate. | 2.00 | 50.80 | .50 | 12.70 | 1.07 | 27.30 | 1 | 4 |

Order number of marker plates required in multiples of Std. Pkg. Qty.

A.
System
Overview

B1.
Cable Ties

B2.
Cable
Accessories

B3.
Stainless
Steel Ties

C1.
Wiring
Duct

C2.
Surface
Raceway

C3.
Abrasion
Protection

C4.
Cable
Management

D1.
Terminals

D2.
Power
Connectors

D3.
Grounding
Connectors

E1.
Labeling
Systems

E2.
Labels

E3.
Pre-Printed
& Write-On
Markers

E4.
Permanent
Identification

E5.
Lockout/
Tagout/
& Safety
Solutions

F.
Index

A. System Overview

Thermal Transfer Non-Laminated Labels

- Labels offer crisp, clear legends with superior legibility
- Use as a wrap-around label or flag style marker for wire/cable labeling
- Available in vinyl cloth material for long-term or temporary labeling and supplied on rolls
- *PANDUIT* labeling software packages include all label formats for quick and easy label production

B1. Cable Ties

B2. Cable Accessories



B3. Stainless Steel Ties

C1. Wiring Duct

Part Number System for Non-Laminated Labels

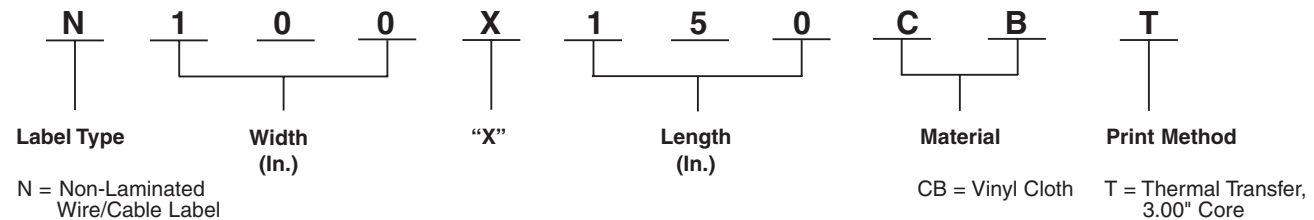

C2. Surface Raceway

C3. Abrasion Protection

C4. Cable Management

Material/Print Method Selection Guide

| Material | Print Method | Temperature Range | Features |
|-------------------------|----------------------|--------------------------------|---|
| Vinyl Cloth, White (CB) | Thermal Transfer (T) | -50°F to 170°F (-46°C to 77°C) | Indoor/outdoor rated; thin conformable material with repositionable adhesive allows label to be removed and reused or used in temporary applications; provides durability, high temperature resistance, and dimensional stability for rough or textured surfaces; resists oil and abrasion. |

D1. Terminals

D2. Power Connectors

D3. Grounding Connectors

| Part Number | Part Description | Width | | Length | | Min. Cable O.D. | | Max. Cable O.D. | | Std. Pkg. Qty. | Std. Ctn. Qty. |
|--------------------|---------------------------|-------|-------|--------|-------|-----------------|-------|-----------------|-------|----------------|----------------|
| | | In. | mm | In. | mm | In. | mm | In. | mm | | |
| N025X075CBT | White, vinyl cloth label. | .25 | 6.35 | .75 | 19.05 | .24 | 6.10 | .51 | 12.95 | 10000 | 40000 |
| N025X125CBT | White, vinyl cloth label. | .25 | 6.35 | 1.25 | 31.75 | .40 | 10.16 | .85 | 21.59 | 10000 | 40000 |
| N025X150CBT | White, vinyl cloth label. | .25 | 6.35 | 1.50 | 38.10 | .48 | 12.19 | 1.02 | 25.91 | 2500 | 10000 |
| N025X175CBT | White, vinyl cloth label. | .25 | 6.35 | 1.75 | 44.45 | .56 | 14.22 | 1.19 | 30.23 | 10000 | 40000 |
| N050X075CBT | White, vinyl cloth label. | .50 | 12.70 | .75 | 19.05 | .24 | 6.10 | .51 | 12.95 | 10000 | 40000 |
| N050X100CBT | White, vinyl cloth label. | .50 | 12.70 | 1.00 | 25.40 | .32 | 8.13 | .68 | 17.27 | 10000 | 40000 |
| N050X125CBT | White, vinyl cloth label. | .50 | 12.70 | 1.25 | 31.75 | .40 | 10.16 | .85 | 21.59 | 10000 | 40000 |
| N050X150CBT | White, vinyl cloth label. | .50 | 12.70 | 1.50 | 38.10 | .48 | 12.19 | 1.02 | 25.91 | 2500 | 10000 |
| N050X175CBT | White, vinyl cloth label. | .50 | 12.70 | 1.75 | 44.45 | .56 | 14.12 | 1.19 | 30.23 | 2500 | 10000 |
| N100X075CBT | White, vinyl cloth label. | 1.00 | 25.40 | .75 | 19.05 | .24 | 6.10 | .51 | 12.95 | 10000 | 40000 |
| N100X125CBT | White, vinyl cloth label. | 1.00 | 25.40 | 1.25 | 31.75 | .40 | 10.16 | .85 | 21.59 | 5000 | 20000 |
| N100X150CBT | White, vinyl cloth label. | 1.00 | 25.40 | 1.50 | 38.10 | .48 | 12.19 | 1.02 | 25.91 | 5000 | 20000 |
| N100X175CBT | White, vinyl cloth label. | 1.00 | 25.40 | 1.75 | 44.45 | .56 | 14.22 | 1.19 | 30.23 | 2500 | 10000 |

E1. Labeling Systems

E2. Labels

E3. Pre-Printed & Write-On Markers

E4. Permanent Identification

E5. Lockout/Tagout & Safety Solutions

F. Index

Order number of labels required in multiples of Std. Pkg. Qty.
 Use with *PANDUIT* thermal transfer hybrid or wax ribbons found on page E1.14.
 *Labels are roll mounted on 3.00" cores; when using the TDP43M printer and 3.00" cores, the roll stand (TDP43M-RS) is required.

Thermal Transfer Commercial Grade Heat Shrink Labels

- Labels offer crisp, clear legends with superior legibility
- Meets UL Standard 224 for flammability and UL Standard 2043 suitable for use in air handling spaces
- Shrink ratio 3:1
- Pre-cut flattened polyolefin is both thermal transfer and dot matrix printable and supplied roll mounted on plastic carrier
- **PANDUIT** labeling software packages include all label formats for quick and easy label production



Part Number System for Heat Shrink Labels

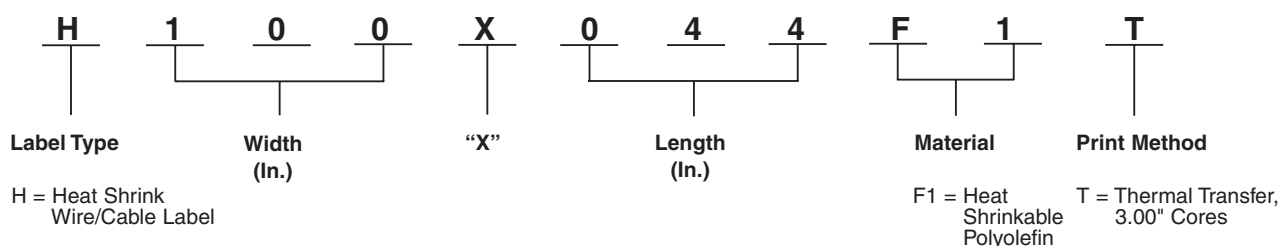

Material/Print Method Selection Guide

| Material | Print Method | Temperature Range | Features |
|---|----------------------|------------------------------------|---|
| Heat Shrinkable Polyolefin, White (F1) Yellow (F2) | Thermal Transfer (T) | -22°F to 220°F (-30°C to 105°C) | Durable flattened polyolefin, high quality heat shrink wire/cable labels. |

| Part Number | Part Description | Width | | Length | | Min. Cable O.D. | | Max. Cable O.D. | | Std. Pkg. Qty. |
|---------------|---|-------|-------|--------|-------|-----------------|------|-----------------|------|----------------|
| | | In. | mm | In. | mm | In. | mm | In. | mm | |
| H050X025F1T | White, 1/8" diameter polyolefin, 2000/roll. | .50 | 12.70 | .25 | 6.35 | .04 | 1.02 | .13 | 3.30 | 1 |
| H050X025F1T-B | White, 1/8" diameter polyolefin, 10000/roll. | .50 | 12.70 | .25 | 6.35 | .04 | 1.02 | .13 | 3.30 | 1 |
| H050X025F2T | Yellow, 1/8" diameter polyolefin, 2000/roll. | .50 | 12.70 | .25 | 6.35 | .04 | 1.02 | .13 | 3.30 | 1 |
| H050X034F1T | White, 3/16" diameter polyolefin, 2000/roll. | .50 | 12.70 | .34 | 8.64 | .06 | 1.52 | .19 | 4.83 | 1 |
| H050X034F1T-B | White, 3/16" diameter polyolefin, 10000/roll. | .50 | 12.70 | .34 | 8.64 | .06 | 1.52 | .19 | 4.83 | 1 |
| H050X034F2T | Yellow, 3/16" diameter polyolefin, 2000/roll. | .50 | 12.70 | .34 | 8.64 | .06 | 1.52 | .19 | 4.83 | 1 |
| H050X044F1T | White, 1/4" diameter polyolefin, 2000/roll. | .50 | 12.70 | .44 | 11.18 | .08 | 2.03 | .25 | 6.35 | 1 |
| H050X044F1T-B | White, 1/4" diameter polyolefin, 10000/roll. | .50 | 12.70 | .44 | 11.18 | .08 | 2.03 | .25 | 6.35 | 1 |
| H050X044F2T | Yellow, 1/4" diameter polyolefin, 2000/roll. | .50 | 12.70 | .44 | 11.18 | .08 | 2.03 | .25 | 6.35 | 1 |
| H050X064F1T | White, 3/8" diameter polyolefin, 2000/roll. | .50 | 12.70 | .64 | 16.26 | .13 | 3.30 | .38 | 9.65 | 1 |
| H050X064F1T-B | White, 3/8" diameter polyolefin, 10000/roll. | .50 | 12.70 | .64 | 16.26 | .13 | 3.30 | .38 | 9.65 | 1 |
| H075X025F1T | White, 1/8" diameter polyolefin, 1000/roll. | .75 | 19.05 | .25 | 6.35 | .04 | 1.02 | .13 | 3.30 | 1 |
| H075X034F1T | White, 3/16" diameter polyolefin, 1000/roll. | .75 | 19.05 | .34 | 8.64 | .06 | 1.52 | .19 | 4.57 | 1 |
| H075X044F1T | White, 1/4" diameter polyolefin, 1000/roll. | .75 | 19.05 | .44 | 11.18 | .08 | 2.03 | .25 | 6.35 | 1 |
| H100X025F1T | White, 1/8" diameter polyolefin, 1000/roll. | 1.00 | 25.40 | .25 | 6.35 | .04 | 1.02 | .13 | 3.30 | 1 |
| H100X025F1T-B | White, 1/8" diameter polyolefin, 5000/roll. | 1.00 | 25.40 | .25 | 6.35 | .04 | 1.02 | .13 | 3.30 | 1 |
| H100X025F2T | Yellow, 1/8" diameter polyolefin, 1000/roll. | 1.00 | 25.40 | .25 | 6.35 | .04 | 1.02 | .13 | 3.30 | 1 |

Order number of rolls required.

Table continues on page E2.12.

A.
System
Overview

Thermal Transfer Commercial Grade Heat Shrink Labels (continued)

B1.
Cable Ties

B2.
Cable
Accessories

B3.
Stainless
Steel Ties

C1.
Wiring
Duct

C2.
Surface
Raceway

C3.
Abrasion
Protection

C4.
Cable
Management

D1.
Terminals

D2.
Power
Connectors

D3.
Grounding
Connectors

E1.
Labeling
Systems

E2.
Labels

E3.
Pre-Printed
& Write-On
Markers

E4.
Permanent
Identification

E5.
Lockout/
Tagout
& Safety
Solutions

F.
Index

| Part Number | Part Description | Width | | Length | | Min. Cable O.D. | | Max. Cable O.D. | | Std. Pkg. Qty. |
|----------------------|---|-------|-------|--------|-------|-----------------|------|-----------------|-------|----------------|
| | | In. | mm | In. | mm | In. | mm | In. | mm | |
| H100X034F1T | White, 3/16" diameter polyolefin, 1000/roll. | 1.00 | 25.40 | .34 | 8.64 | .06 | 1.52 | .19 | 4.83 | 1 |
| H100X034F1T-B | White, 3/16" diameter polyolefin, 5000/roll. | 1.00 | 25.40 | .34 | 8.64 | .06 | 1.52 | .19 | 4.83 | 1 |
| H100X034F2T | Yellow, 3/16" diameter polyolefin, 1000/roll. | 1.00 | 25.40 | .34 | 8.64 | .06 | 1.52 | .19 | 4.83 | 1 |
| H100X044F1T | White, 1/4" diameter polyolefin, 1000/roll. | 1.00 | 25.40 | .44 | 11.18 | .08 | 2.03 | .25 | 6.35 | 1 |
| H100X044F1T-B | White, 1/4" diameter polyolefin, 5000/roll. | 1.00 | 25.40 | .44 | 11.18 | .08 | 2.03 | .25 | 6.35 | 1 |
| H100X044F2T | Yellow, 1/4" diameter polyolefin, 1000/roll. | 1.00 | 25.40 | .44 | 11.18 | .08 | 2.03 | .25 | 6.35 | 1 |
| H100X064F1T | White, 3/8" diameter polyolefin, 1000/roll. | 1.00 | 25.40 | .64 | 16.26 | .13 | 3.30 | .38 | 9.65 | 1 |
| H100X064F1T-B | White, 3/8" diameter polyolefin, 5000/roll. | 1.00 | 25.40 | .64 | 16.26 | .13 | 3.30 | .38 | 9.65 | 1 |
| H100X084F1T | White, 1/2" diameter polyolefin, 1000/roll. | 1.00 | 25.40 | .84 | 21.34 | .17 | 4.32 | .50 | 12.70 | 1 |
| H100X084F2T | Yellow, 1/2" diameter polyolefin, 1000/roll. | 1.00 | 25.40 | .84 | 21.34 | .17 | 4.32 | .50 | 12.70 | 1 |
| H100X165F1T | White, 1" diameter polyolefin, 500/roll. | 1.00 | 25.40 | 1.65 | 41.91 | .33 | 8.38 | 1.00 | 25.40 | 1 |
| H100X165F2T | Yellow, 1" diameter polyolefin, 500/roll. | 1.00 | 25.40 | 1.65 | 41.91 | .33 | 8.38 | 1.00 | 25.40 | 1 |
| H150X025F1T | White, 1/8" diameter polyolefin, 500/roll. | 1.50 | 38.10 | .25 | 6.35 | .04 | 1.02 | .13 | 3.30 | 1 |
| H150X034F1T | White, 3/16" diameter polyolefin, 500/roll. | 1.50 | 38.10 | .34 | 8.64 | .06 | 1.52 | .19 | 4.83 | 1 |
| H150X044F1T | White, 1/4" diameter polyolefin, 500/roll. | 1.50 | 38.10 | .44 | 11.18 | .08 | 2.03 | .25 | 6.35 | 1 |
| H200X025F1T | White, 1/8" diameter polyolefin, 500/roll. | 2.00 | 50.80 | .25 | 6.35 | .04 | 1.02 | .13 | 3.30 | 1 |
| H200X025F1T-B | White, 1/8" diameter polyolefin, 2500/roll. | 2.00 | 50.80 | .25 | 6.35 | .04 | 1.02 | .13 | 3.20 | 1 |
| H200X025F2T | Yellow, 1/8" diameter polyolefin, 500/roll. | 2.00 | 50.80 | .25 | 6.35 | .04 | 1.02 | .13 | 3.20 | 1 |
| H200X034F1T | White, 3/16" diameter polyolefin, 500/roll. | 2.00 | 50.80 | .34 | 8.64 | .06 | 1.52 | .19 | 4.83 | 1 |
| H200X034F1T-B | White, 3/16" diameter polyolefin, 2500/roll. | 2.00 | 50.80 | .34 | 8.64 | .06 | 1.52 | .19 | 4.80 | 1 |
| H200X034F2T | Yellow, 3/16" diameter polyolefin, 500/roll. | 2.00 | 50.80 | .34 | 8.61 | .06 | 1.52 | .19 | 4.80 | 1 |
| H200X044F1T | White, 1/4" diameter polyolefin, 500/roll. | 2.00 | 50.80 | .44 | 11.18 | .08 | 2.03 | .25 | 6.35 | 1 |
| H200X044F1T-B | White, 1/4" diameter polyolefin, 2500/roll. | 2.00 | 50.80 | .44 | 11.18 | .08 | 2.03 | .25 | 6.35 | 1 |
| H200X044F2T | Yellow, 1/4" diameter polyolefin, 500/roll. | 2.00 | 50.80 | .44 | 11.18 | .08 | 2.03 | .25 | 6.35 | 1 |
| H200X064F1T | White, 3/8" diameter polyolefin, 500/roll. | 2.00 | 50.80 | .64 | 16.26 | .13 | 3.30 | .38 | 9.65 | 1 |
| H200X064F1T-B | White, 3/8" diameter polyolefin, 2500/roll. | 2.00 | 50.80 | .64 | 16.26 | .13 | 3.30 | .38 | 9.65 | 1 |
| H200X084F1T | White, 1/2" diameter polyolefin, 500/roll. | 2.00 | 50.80 | .84 | 21.34 | .17 | 4.32 | .50 | 12.70 | 1 |
| H200X084F2T | Yellow, 1/2" diameter polyolefin, 500/roll. | 2.00 | 50.80 | .84 | 21.34 | .17 | 4.32 | .50 | 12.70 | 1 |
| H200X165F1T | White, 1" diameter polyolefin, 250/roll. | 2.00 | 50.80 | 1.65 | 41.91 | .33 | 8.38 | 1.00 | 25.40 | 1 |
| H200X165F2T | Yellow, 1" diameter polyolefin, 250/roll. | 2.00 | 50.80 | 1.65 | 41.91 | .33 | 8.38 | 1.00 | 25.40 | 1 |

Order number of rolls required.

Thermal Transfer Military Grade Heat Shrink Labels

- Labels offer crisp, clear legends with superior legibility
- Meets UL Standard 224 for flammability and AMS-DTL-23053/5C (Class 1 and Class 3)
- Will meet MIL-M-81531, MIL-STD202F, and MIL-STD-883E when printed with RMH4BL or RHH4BL-S ribbons
- Shrink ratio 3:1
- Pre-cut flattened polyolefin is both thermal transfer and dot matrix printable and supplied roll mounted on plastic carrier
- PANDUIT labeling software packages include all label formats for quick and easy label production



Part Number System for Heat Shrink Labels

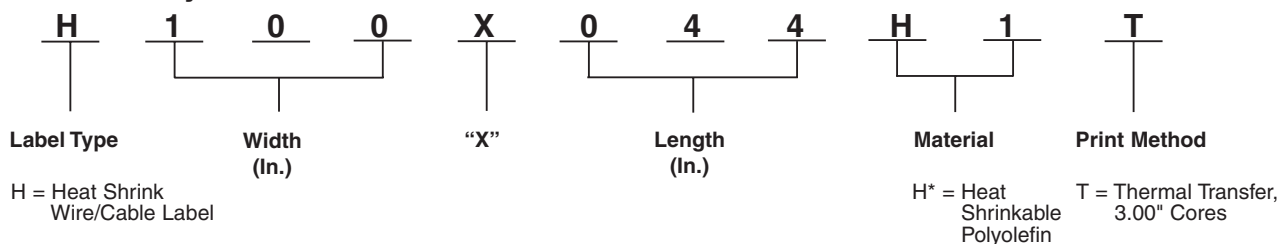

Material/Print Method Selection Guide

| Material | Print Method | Temperature Range | Features |
|---|----------------------|------------------------------------|---|
| Heat Shrinkable Polyolefin, White (H1) Yellow (H2) | Thermal Transfer (T) | -67°F to 275°F (-55°C to 135°C) | Durable flattened polyolefin, high quality heat shrink wire/cable labels. |

| Part Number | Part Description | Width | | Length | | Min. Cable | | Max. Cable O.D. | | Std. Pkg. Qty. |
|---------------|---|-------|-------|--------|-------|------------|------|-----------------|------|----------------|
| | | In. | mm | In. | mm | In. | mm | In. | mm | |
| H050X025H1T | White, 1/8" diameter polyolefin, 2000/roll. | .50 | 12.70 | .25 | 6.35 | .04 | 1.02 | .13 | 3.30 | 1 |
| H050X025H1T-B | White, 1/8" diameter polyolefin, 10000/roll. | .50 | 12.70 | .25 | 6.35 | .04 | 1.02 | .13 | 3.30 | 1 |
| H050X025H2T | Yellow, 1/8" diameter polyolefin, 2000/roll. | .50 | 12.70 | .25 | 6.35 | .04 | 1.02 | .13 | 3.30 | 1 |
| H050X034H1T | White, 3/16" diameter polyolefin, 2000/roll. | .50 | 12.70 | .34 | 8.64 | .06 | 1.52 | .19 | 4.83 | 1 |
| H050X034H1T-B | White, 3/16" diameter polyolefin, 10000/roll. | .50 | 12.70 | .34 | 8.64 | .06 | 1.52 | .19 | 4.83 | 1 |
| H050X034H2T | Yellow, 3/16" diameter polyolefin, 2000/roll. | .50 | 12.70 | .34 | 8.64 | .06 | 1.52 | .19 | 4.83 | 1 |
| H050X044H1T | White, 1/4" diameter polyolefin, 2000/roll. | .50 | 12.70 | .44 | 11.18 | .08 | 2.03 | .25 | 6.35 | 1 |
| H050X044H1T-B | White, 1/4" diameter polyolefin, 10000/roll. | .50 | 12.70 | .44 | 11.18 | .08 | 2.03 | .25 | 6.35 | 1 |
| H050X044H2T | Yellow, 1/4" diameter polyolefin, 2000/roll. | .50 | 12.70 | .44 | 11.18 | .08 | 2.03 | .25 | 6.35 | 1 |
| H050X064H1T | White, 3/8" diameter polyolefin, 2000/roll. | .50 | 12.70 | .64 | 16.26 | .13 | 3.30 | .38 | 9.65 | 1 |
| H050X064H1T-B | White, 3/8" diameter polyolefin, 10000/roll. | .50 | 12.70 | .64 | 16.26 | .13 | 3.30 | .38 | 9.65 | 1 |
| H075X025H1T | White, 1/8" diameter polyolefin, 1000/roll. | .75 | 19.05 | .25 | 6.35 | .04 | 1.02 | .13 | 3.30 | 1 |
| H075X034H1T | White, 1/8" diameter polyolefin, 1000/roll. | .75 | 19.05 | .25 | 6.35 | .04 | 1.02 | .13 | 3.30 | 1 |
| H075X044H1T | White, 1/8" diameter polyolefin, 5000/roll. | .75 | 19.05 | .25 | 6.35 | .04 | 1.02 | .13 | 3.30 | 1 |
| H100X025H1T | White, 1/8" diameter polyolefin, 1000/roll. | 1.00 | 25.40 | .25 | 6.35 | .04 | 1.02 | .13 | 3.30 | 1 |
| H100X025H1T-B | White, 1/8" diameter polyolefin, 5000/roll. | 1.00 | 25.40 | .25 | 6.35 | .04 | 1.02 | .13 | 3.30 | 1 |
| H100X025H2T | Yellow, 1/8" diameter polyolefin, 1000/roll. | 1.00 | 25.40 | .25 | 6.35 | .04 | 1.02 | .13 | 3.30 | 1 |
| H100X034H1T | White, 3/16" diameter polyolefin, 1000/roll. | 1.00 | 25.40 | .34 | 8.64 | .06 | 1.52 | .19 | 4.83 | 1 |
| H100X034H1T-B | White, 3/16" diameter polyolefin, 5000/roll. | 1.00 | 25.40 | .34 | 8.64 | .06 | 1.52 | .19 | 4.83 | 1 |
| H100X034H2T | Yellow, 3/16" diameter polyolefin, 1000/roll. | 1.00 | 25.40 | .34 | 8.64 | .06 | 1.52 | .19 | 4.83 | 1 |

Table continues on page E2.14

A. System Overview

B1. Cable Ties

B2. Cable Accessories

B3. Stainless Steel Ties

C1. Wiring Duct

C2. Surface Raceway

C3. Abrasion Protection

C4. Cable Management

D1. Terminals

D2. Power Connectors

D3. Grounding Connectors

E1. Labeling Systems

E2. Labels

E3. Pre-Printed & Write-On Markers

E4. Permanent Identification

E5. Lockout/Tagout & Safety Solutions

F. Index

A.
System
Overview

Thermal Transfer Military Grade Heat Shrink Labels (continued)

B1.
Cable Ties

B2.
Cable
Accessories

B3.
Stainless
Steel Ties

C1.
Wiring
Duct

C2.
Surface
Raceway

C3.
Abrasion
Protection

C4.
Cable
Management

D1.
Terminals

D2.
Power
Connectors

D3.
Grounding
Connectors

E1.
Labeling
Systems

E2.
Labels

E3.
Pre-Printed
& Write-On
Markers

E4.
Permanent
Identification

E5.
Lockout/
Tagout
& Safety
Solutions

F.
Index

| Part Number | Part Description | Width | | Length | | Min. Cable | | Max. Cable O.D. | | Std. Pkg. Qty. |
|---------------|--|-------|-------|--------|-------|------------|------|-----------------|-------|----------------|
| | | In. | mm | In. | mm | In. | mm | In. | mm | |
| H100X044H1T | White, 1/4" diameter polyolefin, 1000/roll. | 1.00 | 25.40 | .44 | 11.18 | .08 | 2.03 | .25 | 6.35 | 1 |
| H100X044H1T-B | White, 1/4" diameter polyolefin, 5000/roll. | 1.00 | 25.40 | .44 | 11.18 | .08 | 2.03 | .25 | 6.35 | 1 |
| H100X044H2T | Yellow, 1/4" diameter polyolefin, 1000/roll. | 1.00 | 25.40 | .44 | 11.18 | .08 | 2.03 | .25 | 6.35 | 1 |
| H100X064H1T | White, 3/8" diameter polyolefin, 1000/roll. | 1.00 | 25.40 | .64 | 16.26 | .13 | 3.30 | .38 | 9.65 | 1 |
| H100X064H1T-B | White, 3/8" diameter polyolefin, 5000/roll. | 1.00 | 25.40 | .64 | 16.26 | .13 | 3.30 | .38 | 9.65 | 1 |
| H100X084H1T | White, 1/2" diameter polyolefin, 1000/roll. | 1.00 | 25.40 | .84 | 21.34 | .17 | 4.32 | .50 | 12.70 | 1 |
| H100X084H2T | Yellow, 1/2" diameter polyolefin, 1000/roll. | 1.00 | 25.40 | .84 | 21.34 | .17 | 4.32 | .50 | 12.70 | 1 |
| H100X165H1T | White, 1" diameter polyolefin, 500/roll. | 1.00 | 25.40 | 1.65 | 41.91 | .33 | 8.38 | 1.00 | 25.40 | 1 |
| H100X165H2T | Yellow, 1" diameter polyolefin, 500/roll. | 1.00 | 25.40 | 1.65 | 41.91 | .33 | 8.38 | 1.00 | 25.40 | 1 |
| H150X025H1T | White, 1/8" diameter polyolefin, 500/roll. | 1.50 | 38.10 | .25 | 6.35 | .04 | 1.02 | .13 | 3.30 | 1 |
| H150X034H1T | White, 3/16" diameter polyolefin, 500/roll. | 1.50 | 38.10 | .34 | 8.64 | .06 | 1.52 | .19 | 4.83 | 1 |
| H150X044H1T | White, 1/4" diameter polyolefin, 500/roll. | 1.50 | 38.10 | .44 | 11.18 | .08 | 2.03 | .25 | 6.35 | 1 |
| H200X025H1T | White, 1/8" diameter polyolefin, 500/roll. | 2.00 | 50.80 | .25 | 6.35 | .04 | 1.02 | .13 | 3.20 | 1 |
| H200X025H1T-B | White, 1/8" diameter polyolefin, 2500/roll. | 2.00 | 50.80 | .25 | 6.35 | .04 | 1.02 | .13 | 3.20 | 1 |
| H200X025H2T | Yellow, 1/8" diameter polyolefin, 500/roll. | 2.00 | 50.80 | .25 | 6.35 | .04 | 1.02 | .13 | 3.20 | 1 |
| H200X034H1T | White, 3/16" diameter polyolefin, 500/roll. | 2.00 | 50.80 | .34 | 8.61 | .06 | 1.52 | .19 | 4.80 | 1 |
| H200X034H1T-B | White, 3/16" diameter polyolefin, 2500/roll. | 2.00 | 50.80 | .34 | 8.61 | .06 | 1.52 | .19 | 4.83 | 1 |
| H200X034H2T | Yellow, 3/16" diameter polyolefin, 500/roll. | 2.00 | 50.80 | .34 | 8.61 | .06 | 1.52 | .19 | 4.83 | 1 |
| H200X044H1T | White, 1/4" diameter polyolefin, 500/roll. | 2.00 | 50.80 | .44 | 11.18 | .08 | 2.03 | .25 | 6.35 | 1 |
| H200X044H1T-B | White, 1/4" diameter polyolefin, 2500/roll. | 2.00 | 50.80 | .44 | 11.18 | .08 | 2.03 | .25 | 6.35 | 1 |
| H200X044H2T | Yellow, 1/4" diameter polyolefin, 500/roll. | 2.00 | 50.80 | .44 | 11.18 | .08 | 2.03 | .25 | 6.35 | 1 |
| H200X064H1T | White, 3/8" diameter polyolefin, 500/roll. | 2.00 | 50.80 | .64 | 16.26 | .13 | 3.30 | .38 | 9.65 | 1 |
| H200X064H1T-B | White, 3/8" diameter polyolefin, 2500/roll. | 2.00 | 50.80 | .64 | 16.26 | .13 | 3.30 | .38 | 9.65 | 1 |
| H200X084H1T | White, 1/2" diameter polyolefin, 500/roll. | 2.00 | 50.80 | .84 | 21.34 | .17 | 4.32 | .50 | 12.70 | 1 |
| H200X084H2T | Yellow, 1/2" diameter polyolefin, 500/roll. | 2.00 | 50.80 | .84 | 21.34 | .17 | 4.32 | .50 | 12.70 | 1 |
| H200X165H1T | White, 1" diameter polyolefin, 250/roll. | 2.00 | 50.80 | 1.65 | 41.91 | .33 | 8.38 | 1.00 | 25.40 | 1 |
| H200X165H2T | Yellow, 1" diameter polyolefin, 250/roll. | 2.00 | 50.80 | 1.65 | 41.91 | .33 | 8.38 | 1.00 | 25.40 | 1 |

Order number of rolls required.

UL LISTED SP Heat Shrink Tools and Accessories

- Adjustable air intake regulator provides variable temperature adjustment within the units rated heat range
- Toggle type control switch provides hot/cold/off operation
- Replaceable brushes are easy to service and extend the operating life of the gun
- Unique suspended quick change heating element design prolongs life and eases servicing



| Part Number | Part Description | Std. Pkg. Qty. | Std. Ctn. Qty. |
|---------------------|--|----------------|----------------|
| HSG-115V-650 | Heat gun with temperature range of 650°F (344°C) to 900°F (482°C). | 1 | — |
| HSG-A1 | Shrink tube reflector for tubing up to 3/4" inside diameter. Directs heat around tubing to reduce shrink time. | 1 | 10 |
| HSG-A2 | Shrink tube reflector for tubing up to 1 1/2" inside diameter. Directs heat around tubing to reduce shrink time. | 1 | 10 |
| HSG-A3 | Shrink tube concentrator. Directs heat toward tubing and away from heat sensitive items. | 1 | 10 |
| HSG-A4 | Black polyethylene case stores heat gun, stand, and all three accessories. | 1 | — |
| HSG-P1 | Replacement brush/spring kit. | 1 | 5 |
| HSG-P2 | Replacement switch 20 Amps. | 1 | 5 |
| HSG-P3 | Replacement bearing kit. | 1 | 5 |
| HSG-P7 | Replacement heat element 650°F. | 1 | — |

Thermal Transfer Component Labels

- Labels offer crisp, clear legends with superior legibility
- Available in polyester, vinyl cloth, and polyimide materials and supplied on rolls

- Designed for use with thermal transfer desktop printers, including the TDP43MY and TDP42HY printers
- PANDUIT labeling software packages include all label formats for quick and easy label production



Part Number System for Component Labels

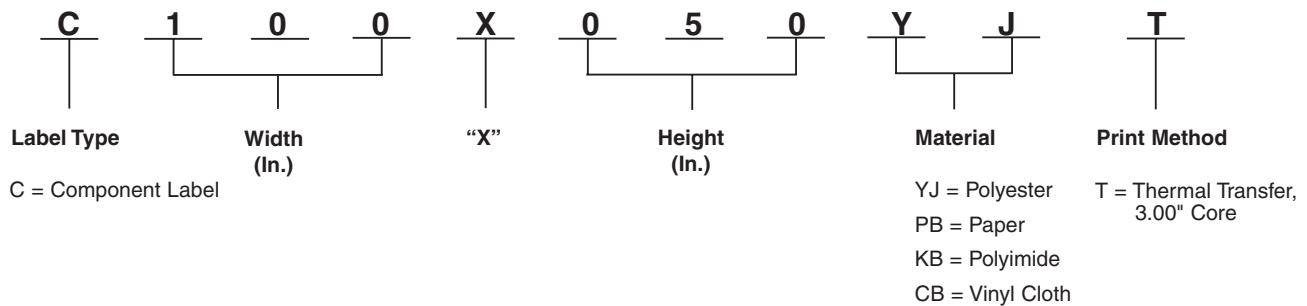

Material/Print Method Selection Guide

| Material | Print Method | Temperature Range | Features |
|-------------------------|----------------------|------------------------------------|---|
| Polyester, White (YJ) | Thermal Transfer (T) | -40°F to 302°F (-40°C to 150°C) | Indoor/outdoor rated; provides durability, high temperature resistance and dimensional stability; does not stretch or easily tear. |
| Paper, White (PB) | | -65°F to 200°F (-54°C to 93°C) | Indoor rated; general purpose material; excellent adhesion properties when applied to a clean dry surface. |
| Polyimide, White (KB) | | -40°F to 350°F (-40°C to 177°C) | Indoor rated; ideal for electronic components and internal circuitry applications; material is intended for applications requiring solvent and high temperature resistance performance, such as the wave solder process. |
| Vinyl Cloth, White (CB) | | -50°F to 170°F (-46°C to 77°C) | Indoor/outdoor rated; thin conformable material with repositionable adhesive allows label to be removed and reused or used in temporary applications; provides durability, high temperature resistance, and dimensional stability for rough or textured surfaces; resists oil and abrasion. |

A.
System
Overview

B1.
Cable Ties

B2.
Cable
Accessories

B3.
Stainless
Steel Ties

C1.
Wiring
Duct

C2.
Surface
Raceway

C3.
Abrasion
Protection

C4.
Cable
Management

D1.
Terminals

D2.
Power
Connectors

D3.
Grounding
Connectors

E1.
Labeling
Systems

E2.
Labels

E3.
Pre-Printed
& Write-On
Markers

E4.
Permanent
Identification

E5.
Lockout/
Tagout/
& Safety
Solutions

F.
Index

A.
System
Overview

Thermal Transfer Component Labels (continued)

B1.
Cable Ties

B2.
Cable
Accessories

B3.
Stainless
Steel Ties

C1.
Wiring
Duct

C2.
Surface
Raceway

C3.
Abrasion
Protection

C4.
Cable
Management

D1.
Terminals

D2.
Power
Connectors

D3.
Grounding
Connectors

E1.
Labeling
Systems

E2.
Labels

E3.
Pre-Printed
& Write-On
Markers

E4.
Permanent
Identification

E5.
Lockout/
Tagout
& Safety
Solutions

F.
Index

| Part Number | Part Description | Width | | Height | | Std. Pkg. Qty. | Std. Ctn. Qty. |
|--------------------|---------------------------|-------|-------|--------|-------|----------------|----------------|
| | | In. | mm | In. | mm | | |
| C025X025KBT | White, polyimide label. | .25 | 6.35 | .25 | 6.35 | 10000 | 40000 |
| C025X025KCT | Tan, polyimide label. | 0.25 | 6.35 | .25 | 6.35 | 10000 | 40000 |
| C025X025YJT | White, polyester label. | .25 | 6.35 | .25 | 6.35 | 10000 | 40000 |
| C038X038KBT | White, polyimide label. | .38 | 9.65 | .38 | 9.65 | 10000 | 40000 |
| C038X038KCT | Tan, polyimide label. | 0.38 | 9.65 | .38 | 9.65 | 10000 | 40000 |
| C038X038YJT | White, polyester label. | .38 | 9.65 | .38 | 9.65 | 10000 | 40000 |
| C050X013KBT | White, polyimide label.. | 0.50 | 12.70 | .13 | 3.30 | 10000 | 40000 |
| C050X013KCT | Tan, polyimide label. | 0.50 | 12.70 | .13 | 3.30 | 10000 | 40000 |
| C050X044KCT | Tan, polyimide label. | 0.50 | 12.70 | .44 | 11.18 | 10000 | 40000 |
| C050X044CBT | White, vinyl cloth label. | .50 | 12.70 | .44 | 11.18 | 10000 | 40000 |
| C050X044KBT | White, polyimide label. | .50 | 12.70 | .44 | 11.18 | 10000 | 40000 |
| C050X044YJT | White, polyester label. | .50 | 12.70 | .44 | 11.18 | 10000 | 40000 |
| C060X020CBT | White, vinyl cloth label. | .60 | 15.24 | .20 | 5.08 | 10000 | 40000 |
| C060X020KBT | White, polyimide label. | .60 | 15.24 | .20 | 5.08 | 10000 | 40000 |
| C060X020KCT | Tan, polyimide label. | 0.60 | 15.24 | .20 | 5.08 | 10000 | 40000 |
| C060X020TJT | White, TEDLAR® label. | .60 | 15.24 | .20 | 5.08 | 10000 | 40000 |
| C060X020YJT | White, polyester label. | .60 | 15.24 | .20 | 5.08 | 10000 | 40000 |
| C065X019KBT | White, polyimide label. | 0.65 | 16.51 | .19 | 4.83 | 10000 | 40000 |
| C065X019KCT | Tan, polyimide label. | 0.65 | 16.51 | .19 | 4.83 | 10000 | 40000 |
| C075X025CBT | White, vinyl cloth label. | .75 | 19.05 | .25 | 6.35 | 10000 | 40000 |
| C075X025KBT | White, polyimide label. | .75 | 19.05 | .25 | 6.35 | 10000 | 40000 |
| C075X025KCT | Tan, polyimide label. | 0.75 | 19.05 | .25 | 6.35 | 10000 | 40000 |
| C075X025YJT | White, polyester label. | .75 | 19.05 | .25 | 6.35 | 10000 | 40000 |
| C080X020KBT | White, polyimide label. | .80 | 20.32 | .20 | 5.08 | 10000 | 40000 |
| C080X020KCT | Tan, polyimide label. | 0.80 | 20.32 | .20 | 5.08 | 10000 | 40000 |
| C080X020YJT | White, polyester label. | .80 | 20.32 | .20 | 5.08 | 10000 | 40000 |
| C090X025KBT | White, polyimide label.. | 0.90 | 22.86 | .25 | 6.35 | 10000 | 40000 |
| C090X025KCT | Tan, polyimide label. | 0.90 | 22.86 | .25 | 6.35 | 10000 | 40000 |
| C100X019KBT | White, polyimide label. | 1.00 | 25.40 | .19 | 4.83 | 10000 | 40000 |
| C100X019KCT | Tan, polyimide label. | 1.00 | 25.40 | .19 | 4.83 | 10000 | 40000 |
| C100X025CBT | White, vinyl cloth label. | 1.00 | 25.40 | .25 | 6.35 | 10000 | 40000 |
| C100X025KBT | White, polyimide label. | 1.00 | 25.40 | .25 | 6.35 | 10000 | 40000 |
| C100X025KCT | Tan, polyimide label. | 1.00 | 25.40 | .25 | 6.35 | 10000 | 40000 |
| C100X025YJT | White, polyester label. | 1.00 | 25.40 | .25 | 6.35 | 10000 | 40000 |
| C100X038KBT | White, polyimide label. | 1.00 | 25.40 | .38 | 9.65 | 10000 | 40000 |
| C100X038KCT | Tan, polyimide label. | 1.00 | 25.40 | .38 | 9.65 | 10000 | 40000 |
| C100X050CBT | White, vinyl cloth label. | 1.00 | 25.40 | .50 | 12.70 | 10000 | 40000 |
| C100X050YJT | White, polyester label. | 1.00 | 25.40 | .50 | 12.70 | 10000 | 40000 |
| C125X025KBT | White, polyimide label. | 1.25 | 31.75 | .25 | 6.35 | 10000 | 40000 |
| C125X025KCT | Tan, polyimide label. | 1.25 | 31.75 | .25 | 6.35 | 10000 | 40000 |
| C150X025KBT | White, polyimide label. | 1.50 | 38.10 | .25 | 6.35 | 5000 | 20000 |
| C150X025KCT | Tan, polyimide label. | 1.50 | 38.10 | .25 | 6.35 | 5000 | 20000 |
| C150X075YJT | White, polyester label. | 1.50 | 38.10 | .75 | 19.05 | 5000 | 20000 |

*TEDLAR is a registered trademark of E.I. du Pont de Nemours and Company.
 Order number of labels required in multiples of Std. Pkg. Qty.
 Use with PANDUIT thermal transfer ribbons.
 Labels roll mounted on 3.00" cores; when using the TDP43MY printer and 3.00" cores, the roll stand (TDP43M-RS) is required.

Thermal Transfer Component Labels (continued)

| Part Number | Part Description | Width | | Height | | Std. Pkg. Qty. | Std. Ctn. Qty. |
|-------------|---------------------------|-------|--------|--------|--------|----------------|----------------|
| | | In. | mm | In. | mm | | |
| C160X020CBT | White, vinyl cloth label. | 1.60 | 40.64 | .20 | 5.08 | 10000 | 40000 |
| C160X020KBT | White, polyimide label. | 1.60 | 40.64 | .20 | 5.08 | 10000 | 40000 |
| C160X020KCT | Tan, polyimide label. | 1.60 | 40.64 | .20 | 5.08 | 10000 | 40000 |
| C160X020YJT | White, polyester label. | 1.60 | 40.64 | .20 | 5.08 | 10000 | 40000 |
| C200X025KBT | White, polyimide label. | 2.00 | 50.80 | .25 | 6.35 | 5000 | 20000 |
| C200X025KCT | Tan, polyimide label. | 2.00 | 50.80 | .25 | 6.35 | 5000 | 20000 |
| C200X050CBT | White, vinyl cloth label. | 2.00 | 50.80 | .50 | 12.70 | 5000 | 20000 |
| C200X050YJT | White, polyester label. | 2.00 | 50.80 | .50 | 12.70 | 5000 | 20000 |
| C200X100YJT | White, polyester label. | 2.00 | 50.80 | 1.00 | 25.40 | 2500 | 10000 |
| C300X025KBT | White, polyimide label. | 3.00 | 76.20 | .25 | 6.35 | 5000 | 20000 |
| C300X025KCT | Tan, polyimide label. | 3.00 | 76.20 | .25 | 6.35 | 5000 | 20000 |
| C400X100CBT | White, vinyl cloth label. | 4.00 | 101.60 | 1.00 | 25.40 | 2500 | 10000 |
| C400X100YJT | White, polyester label. | 4.00 | 101.60 | 1.00 | 25.40 | 2500 | 10000 |
| C400X200YJT | White, polyester label. | 4.00 | 101.60 | 2.00 | 50.80 | 1000 | 4000 |
| C400X400YJT | White, polyester label. | 4.00 | 101.60 | 4.00 | 101.60 | 1000 | 4000 |
| C400X600PBT | White, paper label. | 4.00 | 101.60 | 6.00 | 152.40 | 1000 | 4000 |
| C400X600YJT | White, polyester label. | 4.00 | 101.60 | 6.00 | 152.40 | 1000 | 4000 |

*TEDLAR is a registered trademark of E.I. du Pont de Nemours and Company.

Order number of labels required in multiples of Std. Pkg. Qty.

Use with PANDUIT thermal transfer ribbons.

Labels roll mounted on 3.00" cores; when using the TDP43MY printer and 3.00" cores, the roll stand (TDP43M-RS) is required.

A.
System
Overview

B1.
Cable Ties

B2.
Cable
Accessories

B3.
Stainless
Steel Ties

C1.
Wiring
Duct

C2.
Surface
Raceway

C3.
Abrasion
Protection

C4.
Cable
Management

D1.
Terminals

D2.
Power
Connectors

D3.
Grounding
Connectors

E1.
Labeling
Systems

E2.
Labels

E3.
Pre-Printed
& Write-On
Markers

E4.
Permanent
Identification

E5.
Lockout/
Tagout
& Safety
Solutions

F.
Index

A.
System
Overview

Thermal Transfer Continuous Tapes

B1.
Cable
Ties

- Tapes offer crisp, clear legends with superior legibility
- Available in continuous vinyl or polyester and supplied on rolls

- *PANDUIT* labeling software packages include all label formats for quick and easy label production

B2.
Cable
Accessories



B3.
Stainless
Steel Ties

C1.
Wiring
Duct

Part Number System for Continuous Tapes

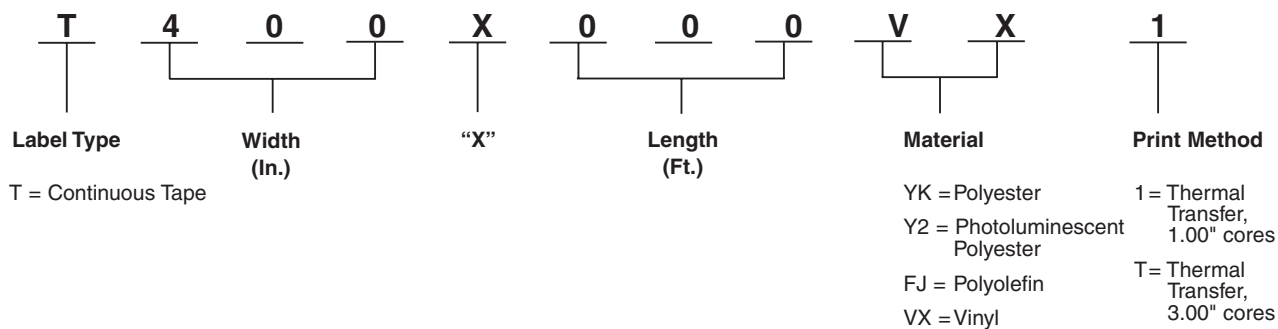

C2.
Surface
Raceway

C3.
Abrasion
Protection

C4.
Cable
Management

D1.
Terminals

Material/Print Method Selection Guide

| Material | Print Method | Temperature Range | Features |
|--|----------------------|------------------------------------|--|
| Polyester, Clear (YK) | Thermal Transfer (T) | -40°F to 257°F (-40°C to 125°C) | Indoor/outdoor rated; provides durability, high temperature resistance, and dimensional stability; does not stretch or easily tear |
| Vinyl, Yellow (VX) Black (VY) Blue (VQ) Brown (VR) Gray (VT) Green (VS) Orange (VU) Purple (VV) Red (VW) White (VP) | | -40°F to 200°F (40°C to 93°C) | Indoor/outdoor rated; conformable material for flat applications and safety and facility identification; can be overlaminated to increase durability |

D2.
Power
Connectors

D3.
Grounding
Connectors

E1.
Labeling
Systems

E2.
Labels

E3.
Pre-Printed
& Write-On
Markers

E4.
Permanent
Identification

E5.
Lockout/
Tagout
& Safety
Solutions

F.
Index

Thermal Transfer Continuous Tapes (continued)

| Part Number | Part Description | Height | | Length | | Std. Pkg. Qty. | Std. Ctn. Qty. |
|--------------|------------------------|--------|--------|--------|------|----------------|----------------|
| | | In. | mm | Ft. | m | | |
| T100X000VP1Y | White, vinyl tape. | 1.00 | 25.40 | 100.0 | 30.5 | 1 | 4 |
| T100X000VQ1Y | Blue, vinyl tape. | 1.00 | 25.40 | 100.0 | 30.5 | 1 | 4 |
| T100X000VS1Y | Green, vinyl tape. | 1.00 | 25.40 | 100.0 | 30.5 | 1 | 4 |
| T100X000VU1Y | Orange, vinyl tape. | 1.00 | 25.40 | 100.0 | 30.5 | 1 | 4 |
| T100X000VW1Y | Red, vinyl tape. | 1.00 | 25.40 | 100.0 | 30.5 | 1 | 4 |
| T100X000VX1Y | Yellow, vinyl tape. | 1.00 | 25.40 | 100.0 | 30.5 | 1 | 4 |
| T100X000VY1Y | Black, vinyl tape. | 1.00 | 25.40 | 100.0 | 30.5 | 1 | 4 |
| T200X000VP1Y | White, vinyl tape. | 2.00 | 50.80 | 100.0 | 30.5 | 1 | 4 |
| T200X000VQ1Y | Blue, vinyl tape. | 2.00 | 50.80 | 100.0 | 30.5 | 1 | 4 |
| T200X000VS1Y | Green, vinyl tape. | 2.00 | 50.80 | 100.0 | 30.5 | 1 | 4 |
| T200X000VT1Y | Gray, vinyl tape. | 2.00 | 50.80 | 100.0 | 30.5 | 1 | 4 |
| T200X000VU1Y | Orange, vinyl tape. | 2.00 | 50.80 | 100.0 | 30.5 | 1 | 4 |
| T200X000VV1Y | Purple, vinyl tape. | 2.00 | 50.80 | 100.0 | 30.5 | 1 | 4 |
| T200X000VW1Y | Red, vinyl tape. | 2.00 | 50.80 | 100.0 | 30.5 | 1 | 4 |
| T200X000VX1Y | Yellow, vinyl tape. | 2.00 | 50.80 | 100.0 | 30.5 | 1 | 4 |
| T200X000VY1Y | Black, vinyl tape. | 2.00 | 50.80 | 100.0 | 30.5 | 1 | 4 |
| T200X000YK1 | Clear, polyester tape. | 2.00 | 50.80 | 100.0 | 30.5 | 1 | 4 |
| T225X000YK1 | Clear, polyester tape. | 2.25 | 57.15 | 100.0 | 30.5 | 1 | 4 |
| T400X000VP1Y | White, vinyl tape. | 4.00 | 101.60 | 100.0 | 30.5 | 1 | 4 |
| T400X000VQ1Y | Blue, vinyl tape. | 4.00 | 101.60 | 100.0 | 30.5 | 1 | 4 |
| T400X000VS1Y | Green, vinyl tape. | 4.00 | 101.60 | 100.0 | 30.5 | 1 | 4 |
| T400X000VT1Y | Gray, vinyl tape. | 4.00 | 101.60 | 100.0 | 30.5 | 1 | 4 |
| T400X000VU1Y | Orange, vinyl tape. | 4.00 | 101.60 | 100.0 | 30.5 | 1 | 4 |
| T400X000VV1Y | Purple, vinyl tape. | 4.00 | 101.60 | 100.0 | 30.5 | 1 | 4 |
| T400X000VW1Y | Red, vinyl tape. | 4.00 | 101.60 | 100.0 | 30.5 | 1 | 4 |
| T400X000VX1Y | Yellow, vinyl tape. | 4.00 | 101.60 | 100.0 | 30.5 | 1 | 4 |
| T400X000VY1Y | Black, vinyl tape. | 4.00 | 101.60 | 100.0 | 30.5 | 1 | 4 |
| T425X000YK1 | Clear, polyester tape. | 4.25 | 107.95 | 100.0 | 30.5 | 1 | 4 |

Order number of rolls required.

Use with *PANDUIT* thermal transfer ribbons.

‡Labels roll mounted on 3.00" cores; when using the TDP43MY printer and 3.00" cores, the roll stand (TDP43M-RS) is required.

A.
System
Overview

B1.
Cable
Ties

B2.
Cable
Accessories

B3.
Stainless
Steel Ties

C1.
Wiring
Duct

C2.
Surface
Raceway

C3.
Abrasion
Protection

C4.
Cable
Management

D1.
Terminals

D2.
Power
Connectors

D3.
Grounding
Connectors

E1.
Labeling
Systems

E2.
Labels

E3.
Pre-Printed
& Write-On
Markers

E4.
Permanent
Identification

E5.
Lockout/
Tagout
& Safety
Solutions

F.
Index

A.
System
Overview

Dot Matrix Self-Laminating Labels

B1.
Cable Ties

- High quality, economical solution for wire/cable labeling
- Meets UL 2043 suitable for use in air handling spaces
- Self-laminating labels include a colored print-on area and clear overlaminates to protect the legend for clear and durable identification

- Available in vinyl and TEDLAR® material and supplied on pin fed sheets
- PANDUIT labeling software packages include all label formats for quick and easy label production

B2.
Cable
Accessories



B3.
Stainless
Steel Ties

C1.
Wiring
Duct

C2.
Surface
Raceway

Part Number System for Self-Laminating Labels

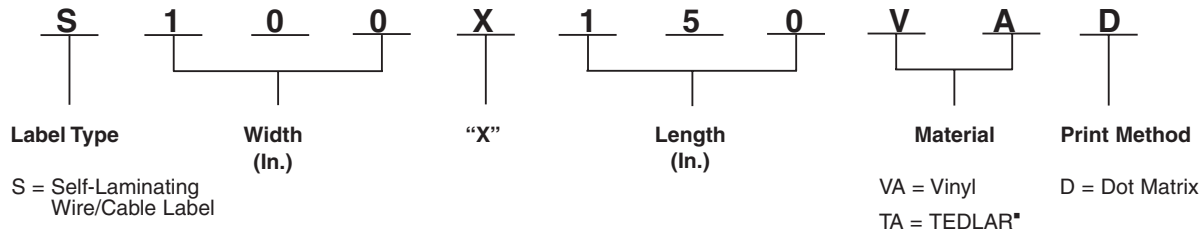

C3.
Abrasion
Protection

C4.
Cable
Management

Material/Print Method Selection Guide

| Material | Print Method | Temperature Range | Features |
|--|----------------|--------------------------------|--|
| Self-Laminating Vinyl, White Print-On (VA) | Dot Matrix (D) | -40°F to 200°F (-40°C to 93°C) | Indoor/outdoor rated; thin and conformable; preferred material for most general wire/cable labeling. |
| Self-Laminating TEDLAR®, White Print-On (TA) | Dot Matrix (D) | 0°F to 275°F (-18°C to 135°C) | Indoor/outdoor rated; self-extinguishing; ideal for wire/cable labeling in harsh environments. |

D1.
Terminals

D2.
Power
Connectors

D3.
Grounding
Connectors

| Part Number | Part Description | Width | | Length | | Print-On Height | | Min. Cable O.D. | | Max. Cable O.D. | | Std. Pkg. Qty. | Std. Ctn. Qty. |
|---------------------|-------------------------------------|-------|-------|--------|-------|-----------------|-------|-----------------|------|-----------------|------|----------------|----------------|
| | | In. | mm | In. | mm | In. | mm | In. | mm | In. | mm | | |
| S050X075TAD | White print-on area, TEDLAR® label. | .50 | 12.70 | .75 | 19.05 | .25 | 6.35 | .12 | 3.07 | .16 | 4.04 | 5000 | 25000 |
| S050X075VADY | White print-on area, vinyl label. | .50 | 12.70 | .75 | 19.05 | .25 | 6.35 | .12 | 3.07 | .16 | 4.04 | 5000 | 25000 |
| S050X125TAD | White print-on area, TEDLAR® label. | .50 | 12.70 | 1.25 | 31.75 | .38 | 9.65 | .12 | 3.07 | .28 | 7.03 | 5000 | 20000 |
| S050X125VADY | White print-on area, vinyl label. | .50 | 12.70 | 1.25 | 31.75 | .38 | 9.65 | .12 | 3.07 | .28 | 7.03 | 5000 | 20000 |
| S050X150TAD | White print-on area, TEDLAR® label. | .50 | 12.70 | 1.50 | 38.10 | .50 | 12.70 | .16 | 4.04 | .32 | 8.09 | 5000 | 20000 |
| S050X150VADY | White print-on area, vinyl label. | .50 | 12.70 | 1.50 | 38.10 | .50 | 12.70 | .16 | 4.04 | .32 | 8.09 | 5000 | 20000 |
| S100X075TAD | White print-on area, TEDLAR® label. | 1.00 | 25.40 | .75 | 19.05 | .25 | 6.35 | .08 | 2.02 | .16 | 4.04 | 5000 | 20000 |
| S100X075VADY | White print-on area, vinyl label. | 1.00 | 25.40 | .75 | 19.05 | .25 | 6.35 | .08 | 2.02 | .16 | 4.04 | 5000 | 20000 |
| S100X125TAD | White print-on area, TEDLAR® label. | 1.00 | 25.40 | 1.25 | 31.75 | .38 | 9.65 | .12 | 3.07 | .28 | 7.03 | 5000 | 20000 |
| S100X125VADY | White print-on area, vinyl label. | 1.00 | 25.40 | 1.25 | 31.75 | .38 | 9.65 | .12 | 3.07 | .28 | 7.03 | 5000 | 20000 |
| S100X150TAD | White print-on area, TEDLAR® label. | 1.00 | 25.40 | 1.50 | 38.10 | .50 | 12.70 | .16 | 4.04 | .32 | 8.09 | 5000 | 20000 |
| S100X150VADY | White print-on area, vinyl label. | 1.00 | 25.40 | 1.50 | 38.10 | .50 | 12.70 | .16 | 4.04 | .32 | 8.09 | 5000 | 20000 |

E1.
Labeling
Systems

E2.
Labels

E3.
Pre-Printed
& Write-On
Markers

E4.
Permanent
Identification

E5.
Lockout/
Tagout
& Safety
Solutions

F.
Index

Order number of labels required in multiples of Std. Pkg. Qty.
 *TEDLAR is a registered trademark of E.I. du Pont de Nemours and Company.

Dot Matrix Self-Laminating Labels (continued)

| Part Number | Part Description | Width | | Length | | Print-On Height | | Min. Cable O.D. | | Max. Cable O.D. | | Std. Pkg. Qty. | Std. Ctn. Qty. |
|--------------|-------------------------------------|-------|-------|--------|--------|-----------------|-------|-----------------|-------|-----------------|-------|----------------|----------------|
| | | In. | mm | In. | mm | In. | mm | In. | mm | In. | mm | | |
| S100X225TAD | White print-on area, TEDLAR® label. | 1.00 | 25.40 | 2.25 | 57.15 | .75 | 19.05 | .24 | 6.06 | .48 | 12.13 | 5000 | 25000 |
| S100X225VADY | White print-on area, vinyl label. | 1.00 | 25.40 | 2.25 | 57.15 | .75 | 19.05 | .24 | 6.06 | .48 | 12.13 | 5000 | 25000 |
| S100X400TAD | White print-on area, TEDLAR® label. | 1.00 | 25.40 | 4.00 | 101.60 | 1.00 | 25.40 | .32 | 8.09 | .95 | 24.26 | 1000 | 4000 |
| S100X400VADY | White print-on area, vinyl label. | 1.00 | 25.40 | 4.00 | 101.60 | 1.00 | 25.40 | .32 | 8.09 | .95 | 24.26 | 1000 | 4000 |
| S100X650TAD | White print-on area, TEDLAR® label. | 1.00 | 25.40 | 6.50 | 165.10 | 1.50 | 38.10 | .48 | 12.13 | 1.59 | 40.43 | 1000 | 2000 |
| S100X650VADY | White print-on area, vinyl label. | 1.00 | 25.40 | 6.50 | 165.10 | 1.50 | 38.10 | .48 | 12.13 | 1.59 | 40.43 | 1000 | 2000 |
| S200X225TAD | White print-on area, TEDLAR® label. | 2.00 | 50.80 | 2.25 | 57.15 | .75 | 19.05 | .24 | 6.06 | .48 | 12.13 | 5000 | 20000 |
| S200X225VADY | White print-on area, vinyl label. | 2.00 | 50.80 | 2.25 | 57.15 | .75 | 19.05 | .24 | 6.06 | .48 | 12.13 | 5000 | 20000 |
| S200X400TAD | White print-on area, TEDLAR® label. | 2.00 | 50.80 | 4.00 | 101.60 | 1.00 | 25.40 | .32 | 8.09 | .95 | 24.26 | 1000 | 4000 |
| S200X400VADY | White print-on area, vinyl label. | 2.00 | 50.80 | 4.00 | 101.60 | 1.00 | 25.40 | .32 | 8.09 | .95 | 24.26 | 1000 | 4000 |
| S200X650TAD | White print-on area, TEDLAR® label. | 2.00 | 50.80 | 6.50 | 165.10 | 1.50 | 38.10 | .48 | 12.13 | 1.59 | 40.43 | 1000 | 4000 |
| S200X650VADY | White print-on area, vinyl label. | 2.00 | 50.80 | 6.50 | 165.10 | 1.50 | 38.10 | .48 | 12.13 | 1.59 | 40.43 | 1000 | 4000 |

Order number of labels required in multiples of Std. Pkg. Qty.

*TEDLAR is a registered trademark of E.I. du Pont de Nemours and Company.

A.
System
Overview

B1.
Cable Ties

B2.
Cable
Accessories

B3.
Stainless
Steel Ties

C1.
Wiring
Duct

C2.
Surface
Raceway

C3.
Abrasion
Protection

C4.
Cable
Management

D1.
Terminals

D2.
Power
Connectors

D3.
Grounding
Connectors

E1.
Labeling
Systems

E2.
Labels

E3.
Pre-Printed
& Write-On
Markers

E4.
Permanent
Identification

E5.
Lockout/
Tagout/
& Safety
Solutions

F.
Index

A. System Overview

Dot Matrix Non-Laminated Labels

B1. Cable Ties

- High quality, economical solution for wire/cable labeling
- Use as a wrap-around label or flag style marker for wire/cable labeling

- Available in vinyl cloth material and supplied on pin fed sheets
- **PANDUIT** labeling software packages include all label formats for quick and easy label production

B2. Cable Accessories



B3. Stainless Steel Ties

C1. Wiring Duct

Part Number System for Non-Laminated Labels

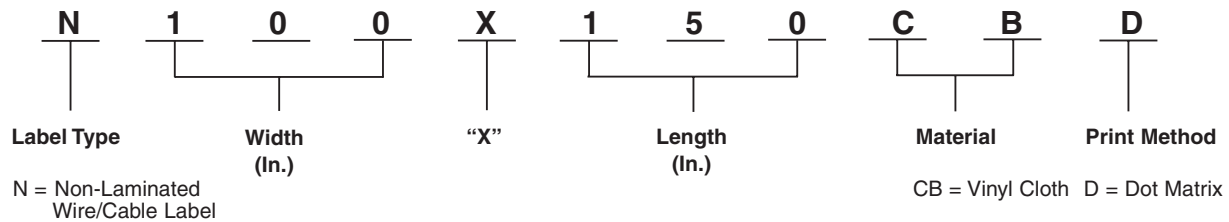

C2. Surface Raceway

C3. Abrasion Protection

C4. Cable Management

Material/Print Method Selection Guide

| Material | Print Method | Temperature Range | Features |
|-------------------------|----------------|-----------------------------------|--|
| Vinyl Cloth, White (CB) | Dot Matrix (D) | -50°F to 170°F (-46°C to 77°C) | Indoor/outdoor rated; thin conformable material with repositionable adhesive allows label to be removed and reused or used in temporary applications; provides durability, high temperature resistance, and dimensional stability for rough or textured surface. |

D1. Terminals

D2. Power Connectors

D3. Grounding Connectors

| Part Number | Part Description | Width | | Length | | Min. Cable O.D. | | Max. Cable O.D. | | Std. Pkg. Qty. | Std. Ctn. Qty. |
|--------------------|---------------------------|-------|-------|--------|-------|-----------------|-------|-----------------|-------|----------------|----------------|
| | | In. | mm | In. | mm | In. | mm | In. | mm | | |
| N025X075CBD | White, vinyl cloth label. | .25 | 6.35 | .75 | 19.05 | .24 | 6.10 | .51 | 12.95 | 5000 | 20000 |
| N025X125CBD | White, vinyl cloth label. | .25 | 6.35 | 1.25 | 31.75 | .40 | 10.16 | .85 | 21.59 | 5000 | 20000 |
| N025X150CBD | White, vinyl cloth label. | .25 | 6.35 | 1.50 | 38.10 | .48 | 12.19 | 1.02 | 25.91 | 5000 | 20000 |
| N025X175CBD | White, vinyl cloth label. | .25 | 6.35 | 1.75 | 44.45 | .56 | 14.22 | 1.19 | 30.23 | 5000 | 20000 |
| N050X075CBD | White, vinyl cloth label. | .50 | 12.70 | .75 | 19.05 | .24 | 6.10 | .51 | 12.95 | 5000 | 15000 |
| N050X100CBD | White, vinyl cloth label. | .50 | 12.70 | 1.00 | 25.40 | .32 | 8.13 | .68 | 17.27 | 5000 | 20000 |
| N050X125CBD | White, vinyl cloth label. | .50 | 12.70 | 1.25 | 31.75 | .40 | 10.16 | .85 | 21.59 | 5000 | 20000 |
| N050X150CBD | White, vinyl cloth label. | .50 | 12.70 | 1.50 | 38.10 | .48 | 12.19 | 1.02 | 25.91 | 5000 | 10000 |
| N050X175CBD | White, vinyl cloth label. | .50 | 12.70 | 1.75 | 44.45 | .56 | 14.22 | 1.19 | 30.23 | 5000 | 10000 |
| N100X075CBD | White, vinyl cloth label. | 1.00 | 25.40 | .75 | 19.05 | .24 | 6.10 | .51 | 12.95 | 5000 | 20000 |
| N100X125CBD | White, vinyl cloth label. | 1.00 | 25.40 | 1.25 | 31.75 | .40 | 10.16 | .85 | 21.59 | 5000 | 20000 |
| N100X150CBD | White, vinyl cloth label. | 1.00 | 25.40 | 1.50 | 38.10 | .48 | 12.19 | 1.02 | 25.91 | 5000 | 15000 |
| N100X175CBD | White, vinyl cloth label. | 1.00 | 25.40 | 1.75 | 44.45 | .56 | 14.22 | 1.19 | 30.23 | 5000 | 15000 |

E1. Labeling Systems

E2. Labels

E3. Pre-Printed & Write-On Markers

E4. Permanent Identification

E5. Lockout/Tagout & Safety Solutions

F. Index

Order number of labels required in multiples of Std. Pkg. Qty.

A.
System
Overview

Dot Matrix Component Labels (continued)

B1.
Cable Ties



B2.
Cable
Accessories

B3.
Stainless
Steel Ties

C1.
Wiring
Duct

C2.
Surface
Raceway

C3.
Abrasion
Protection

C4.
Cable
Management

D1.
Terminals

D2.
Power
Connectors

D3.
Grounding
Connectors

E1.
Labeling
Systems

E2.
Labels

E3.
Pre-Printed
& Write-On
Markers

E4.
Permanent
Identification

E5.
Lockout/
Tagout/
& Safety
Solutions

F.
Index

| Part Number | Part Description | Width | | Height | | Std. Pkg. Qty. | Std. Ctn. Qty. |
|--------------------|---------------------------|-------|--------|--------|--------|----------------|----------------|
| | | In. | mm | in. | mm | | |
| C025X025YJD | White, polyester label. | .25 | 6.35 | .25 | 6.35 | 5000 | 25000 |
| C038X038YJD | White, polyester label. | .38 | 9.65 | .38 | 9.65 | 5000 | 25000 |
| C050X044CBD | White, vinyl cloth label. | .50 | 12.70 | .44 | 11.18 | 5000 | 25000 |
| C050X044YJD | White, polyester label. | .50 | 12.70 | .44 | 11.18 | 5000 | 25000 |
| C060X020CBD | White, vinyl cloth label. | .60 | 15.24 | .20 | 5.08 | 5000 | 25000 |
| C060X020YJD | White, polyester label. | .60 | 15.24 | .20 | 5.08 | 5000 | 25000 |
| C075X025CBD | White, vinyl cloth label. | .75 | 19.05 | .25 | 6.35 | 5000 | 25000 |
| C075X025YJD | White, polyester label. | .75 | 19.05 | .25 | 6.35 | 5000 | 25000 |
| C080X020YJD | White, polyester label. | .80 | 20.32 | .20 | 5.08 | 5000 | 25000 |
| C100X025CBD | White, vinyl cloth label. | 1.00 | 25.40 | .25 | 6.35 | 5000 | 20000 |
| C100X025YJD | White, polyester label. | 1.00 | 25.40 | .25 | 6.35 | 5000 | 25000 |
| C100X050CBD | White, vinyl cloth label. | 1.00 | 25.40 | .50 | 12.70 | 5000 | 20000 |
| C100X050YJD | White, polyester label. | 1.00 | 25.40 | .50 | 12.70 | 5000 | 20000 |
| C150X075YJD | White, polyester label. | 1.50 | 38.10 | .75 | 19.05 | 5000 | 10000 |
| C160X020CBD | White, vinyl cloth label. | 1.60 | 40.64 | .20 | 5.08 | 5000 | 10000 |
| C160X020YJD | White, polyester label. | 1.60 | 40.64 | .20 | 5.08 | 5000 | 25000 |
| C200X050CBD | White, vinyl cloth label. | 2.00 | 50.80 | .50 | 12.70 | 5000 | 10000 |
| C200X050YJD | White, polyester label. | 2.00 | 50.80 | .50 | 12.70 | 5000 | 10000 |
| C200X100YJD | White, polyester label. | 2.00 | 50.80 | 1.00 | 25.40 | 1000 | 5000 |
| C400X100CBD | White, vinyl cloth label. | 4.00 | 101.60 | 1.00 | 25.40 | 1000 | 3000 |
| C400X100YJD | White, polyester label. | 4.00 | 101.60 | 1.00 | 25.40 | 1000 | 3000 |
| C400X200YJD | White, polyester label. | 4.00 | 101.60 | 2.00 | 50.80 | 1000 | 3000 |
| C400X400YJD | White, polyester label. | 4.00 | 101.60 | 4.00 | 101.60 | 1000 | 3000 |

Order number of labels required in multiples of Std. Pkg. Qty.

Size Illustrations of Self-Laminating Labels

The image displays 14 different sizes of self-laminating labels, each represented by a rectangular box with a white header and a grey body. The labels are arranged in three rows:

- Row 1:** S050X075*, S050X125*, S050X150*, S075X075*, S075X125*, S075X150*, S100X075*, S100X125*
- Row 2:** S100X150*, S100X225*, S100X400*, S150X150*, S150X225*
- Row 3:** S150X400*

*Represents material type and print method of part number.

A.
System
Overview

B1.
Cable Ties

B2.
Cable
Accessories

B3.
Stainless
Steel Ties

C1.
Wiring
Duct

C2.
Surface
Raceway

C3.
Abrasion
Protection

C4.
Cable
Management

D1.
Terminals

D2.
Power
Connectors

D3.
Grounding
Connectors

E1.
Labeling
Systems

E2.
Labels

E3.
Pre-Printed
& Write-On
Markers

E4.
Permanent
Identification

E5.
Lockout/
Tagout/
& Safety
Solutions

F.
Index

A.
System
Overview

Size Illustrations of Self-Laminating Labels (continued)

B1.
Cable Ties

S100X650*

S200X225*

S200X650*

B2.
Cable
Accessories

B3.
Stainless
Steel Ties

C1.
Wiring
Duct

C2.
Surface
Raceway

C3.
Abrasion
Protection

S200X400*

C4.
Cable
Management

D1.
Terminals

D2.
Power
Connectors

D3.
Grounding
Connectors

E1.
Labeling
Systems

E2.
Labels

E3.
Pre-Printed
& Write-On
Markers

E4.
Permanent
Identification

E5.
Lockout/
Tagout/
& Safety
Solutions

F.
Index

*Represents material type and print method of part number.

Size Illustrations of Non-Laminated and Flag Style Labels

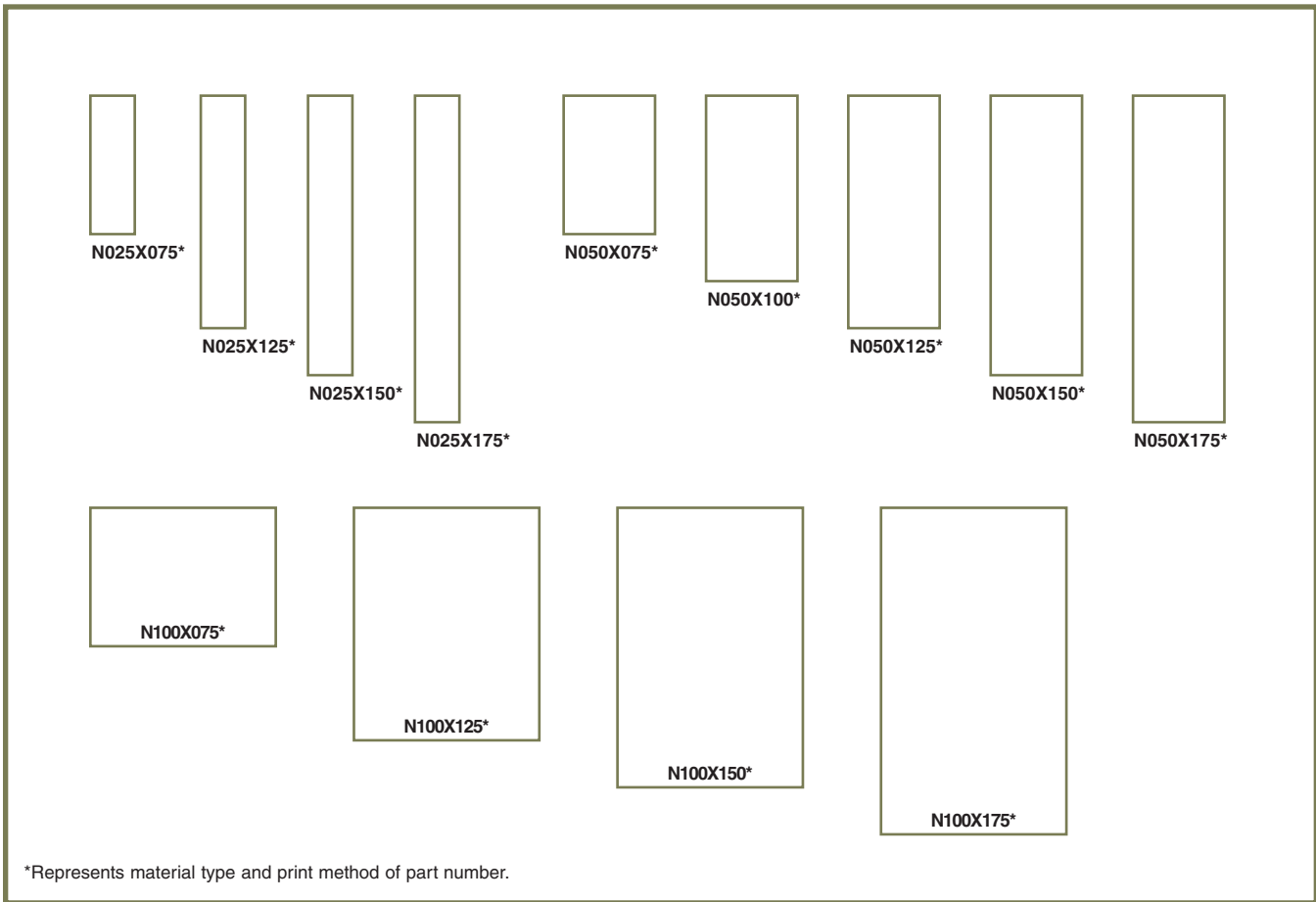

A.
System
Overview

B1.
Cable Ties

B2.
Cable
Accessories

B3.
Stainless
Steel Ties

C1.
Wiring
Duct

C2.
Surface
Raceway

C3.
Abrasion
Protection

C4.
Cable
Management

D1.
Terminals

D2.
Power
Connectors

D3.
Grounding
Connectors

E1.
Labeling
Systems

E2.
Labels

E3.
Pre-Printed
& Write-On
Markers

E4.
Permanent
Identification

E5.
Lockout/
Tagout
& Safety
Solutions

F.
Index

Size Illustrations of Flattened Heat Shrink Labels

A.
System
Overview

B1.
Cable Ties

B2.
Cable
Accessories

B3.
Stainless
Steel Ties

C1.
Wiring
Duct

C2.
Surface
Raceway

C3.
Abrasion
Protection

C4.
Cable
Management

D1.
Terminals

D2.
Power
Connectors

D3.
Grounding
Connectors

E1.
Labeling
Systems

E2.
Labels

E3.
Pre-Printed
& Write-On
Markers

E4.
Permanent
Identification

E5.
Lockout/
Tagout/
& Safety
Solutions

F.
Index

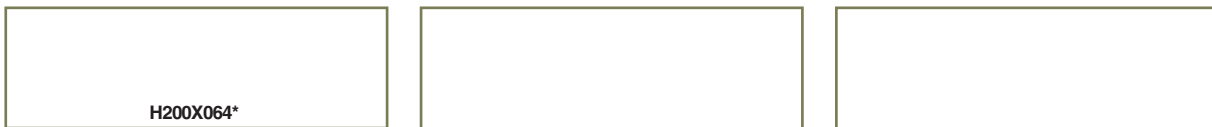
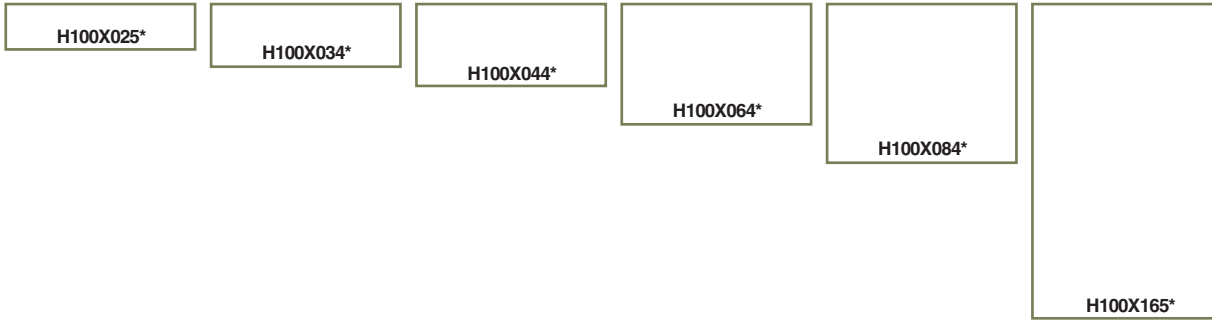

*Represents material type and print method of part number.

Size Illustrations for Component Labels

C025X025* **C038X038*** **C050X044*** **C060X020*** **C075X025*** **C080X020*** **C100X025*** **C100X050***

C150X075* **C160X020*** **C200X050***

C200X075* **C200X100***

C300X100*

C400X100* **C225X450***

C400X200*

*Represents material type and print method of part number.

A.
System
Overview

B1.
Cable
Ties

B2.
Cable
Accessories

B3.
Stainless
Steel Ties

C1.
Wiring
Duct

C2.
Surface
Raceway

C3.
Abrasion
Protection

C4.
Cable
Management

D1.
Terminals

D2.
Power
Connectors

D3.
Grounding
Connectors

E1.
Labeling
Systems

E2.
Labels

E3.
Pre-Printed
& Write-On
Markers

E4.
Permanent
Identification

E5.
Lockout/
Tagout/
& Safety
Solutions

F.
Index

Size Illustrations for Component Labels (continued)

A.
System
Overview

B1.
Cable Ties

B2.
Cable
Accessories

B3.
Stainless
Steel Ties

C1.
Wiring
Duct

C2.
Surface
Raceway

C3.
Abrasion
Protection

C4.
Cable
Management

D1.
Terminals

D2.
Power
Connectors

D3.
Grounding
Connectors

E1.
Labeling
Systems

E2.
Labels

E3.
Pre-Printed
& Write-On
Markers

E4.
Permanent
Identification

E5.
Lockout/
Tagout/
& Safety
Solutions

F.
Index

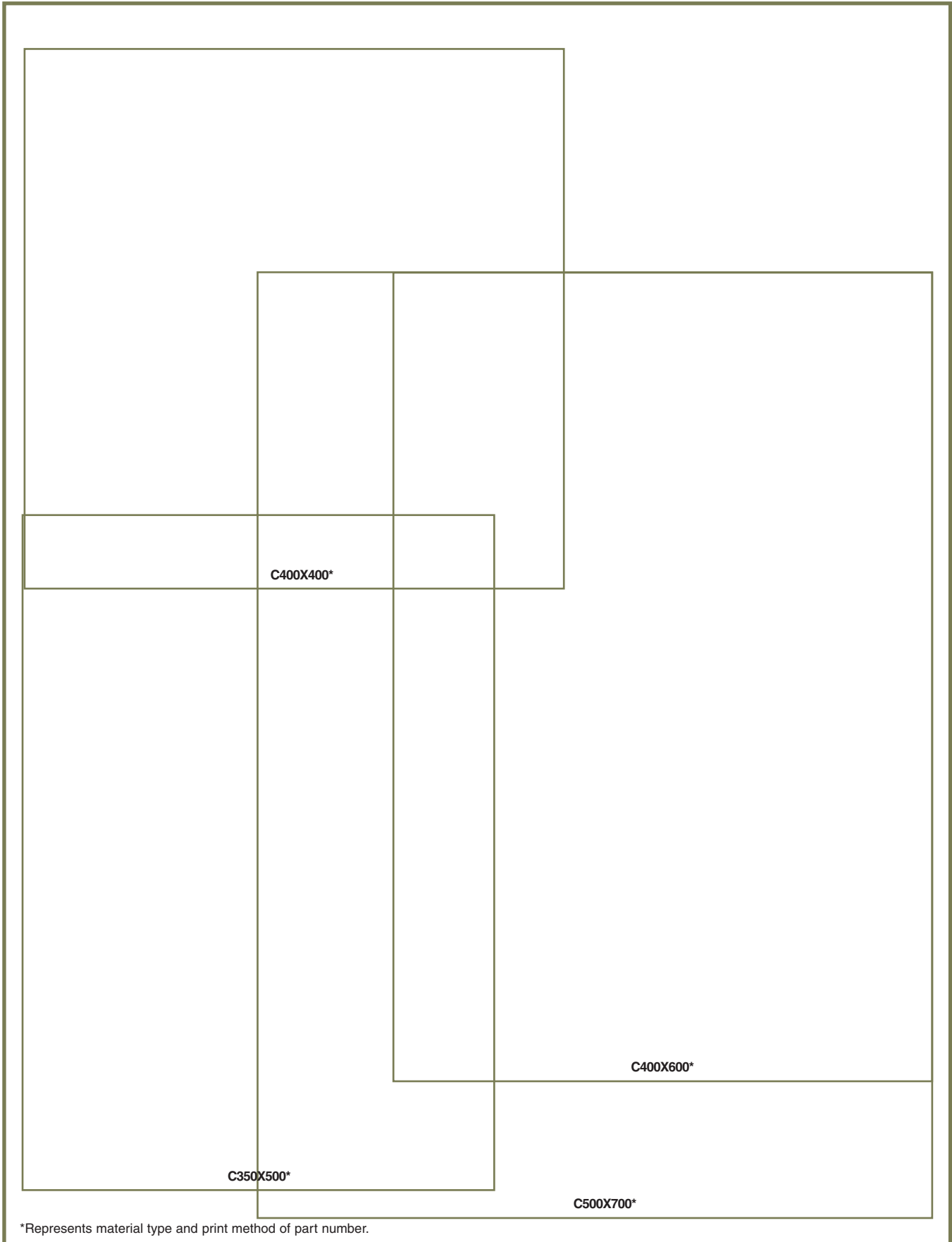

*Represents material type and print method of part number.

PRE-PRINTED AND WRITE-ON MARKERS

PANDUIT offers a variety of pre-printed and write-on marker solutions in multiple formats to meet your specific requirements.



- Marker books are a convenient pocket-sized method to identify many electrical and network components
- Marker cards are available in a variety of legends and combination packs
- Dispensers are available in both pre-printed and write-on formats for quick identification of wire/cable
- Clip-on markers provide a fast, convenient, non-adhesive method to identify wire/cable

PANDUIT offers a variety of innovative books, cards, clip-ons and dispensers to provide you with the wire/cable label that best fits your needs.

A.
System
Overview

B1.
Cable Ties

B2.
Cable
Accessories

B3.
Stainless
Steel Ties

C1.
Wiring
Duct

C2.
Surface
Raceway

C3.
Abrasion
Protection

C4.
Cable
Management

D1.
Terminals

D2.
Power
Connectors

D3.
Grounding
Connectors

E1.
Labeling
Systems

E2.
Labels

E3.
Pre-Printed
& Write-On
Markers

E4.
Permanent
Identification

E5.
Lockout/
Tagout/
& Safety
Solutions

F.
Index

A. System Overview

Pre-Printed Marker Books

B1. Cable Ties

- Convenient, pocket-sized book
- Markers are perforated and can be torn in half to mark both ends of conductors
- Terminal block markers are included to properly identify connectors
- Ten pages of markers per book

B2. Cable Accessories

B3. Stainless Steel Ties

C1. Wiring Duct

C2. Surface Raceway

C3. Abrasion Protection

C4. Cable Management

D1. Terminals

D2. Power Connectors

D3. Grounding Connectors

E1. Labeling Systems

E2. Labels

E3. Pre-Printed & Write-On Markers

E4. Permanent Identification

E5. Lockout/Tagout & Safety Solutions

F. Index

Material Chart

| Material | Print Method | Temperature Range | Features |
|--------------------|--------------|--------------------------------|--|
| Vinyl Cloth, White | Pre-Printed | -50°F to 170°F (-46°C to 77°C) | Indoor/outdoor rated; conformable material with repositionable adhesive allows label to be removed and reused or used in temporary applications; provides durability, high temperature resistance, and dimensional stability for rough or textured surfaces; resists oil and abrasion. |

Perforation for half marker

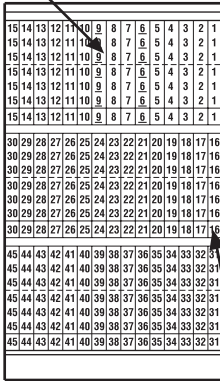

Terminal Block Marker

| Part Number | Legend | Total Markers Each Legend | Std. Pkg. Book(s) | Std. Ctn. Book(s) |
|----------------|---|---------------------------|-------------------|-------------------|
| PCMB-1 | 0 thru 9 | 45 | 1 | 10 |
| PCMB-2 | A thru Z, 0 thru 15, +, -, / | 10 | 1 | 10 |
| PCMB-3 | 1 thru 45 | 10 | 1 | 10 |
| PCMB-4 | 1, 2, 3 | 150 | 1 | 10 |
| PCMB-5 | A, B, C | 150 | 1 | 10 |
| PCMB-6 | T1, T2, T3 | 150 | 1 | 10 |
| PCMB-7 | L1, L2, L3 | 150 | 1 | 10 |
| PCMB-8 | 1 thru 15 16 thru 90 A thru Z, +, -, /, 0 | 6 4 2 | 1 | 10 |
| PCMB-9 | 1, 2, 3, A, B, C L1, L2, L3, T1, T2, T3 | 45 30 | 1 | 10 |
| PCMB-10 | Solid NEMA colors red, yellow, white, light blue, light green, black, brown, orange, gray, dark green | 45 | 1 | 10 |
| PCMB-11 | 1 thru 30 | 15 | 1 | 10 |
| PCMB-12 | A thru Z + - Blank (write-on) | 15 8 7 21 | 1 | 10 |
| PCMB-13 | + , - , AC, DC POS, NEG, GND NEUT SPARE, Blank (write-on) | 45 33 27 21 | 1 | 10 |
| PCMB-14 | 46 thru 90 | 10 | 1 | 10 |
| PCMB-15 | 0 thru 45, +, - | 10 | 1 | 10 |
| PCMB-16 | 0 thru 33, A, B, C, +, -, L1, L2, L3, T1, T2, T3 | 10 | 1 | 10 |
| PCMB-25 | 0 thru 9 L1, L2, L3, T1, T2, T3 | 45 15 | 1 | 10 |

Legend: Black Background: White
 Marker sizes:
 Full size marker – .22" x 1.38" (5.60mm x 34.90mm). Maximum wire O.D., .38" (9.50mm).
 Half size marker – .22" x .69" (5.60mm x 17.40mm). Maximum wire O.D., .19" (4.70mm).
 Terminal block marker – .22" x .25" (5.60mm x 6.30mm).

A. System Overview

Pre-Printed Marker Cards PCM Type

B1. Cable Ties

- Marker cards printed in a variety of legends allows “kitting” for project builds

- Plastic liner provides easy removal of markers while protecting unused markers

B2. Cable Accessories



B3. Stainless Steel Ties

C1. Wiring Duct

Material Chart

| Material | Print Method | Temperature Range | Features |
|--------------------|--------------|-----------------------------------|--|
| Vinyl Cloth, White | Pre-Printed | -50°F to 170°F (-46°C to 77°C) | Indoor/outdoor rated; conformable material with repositionable adhesive allows label to be removed and reused or used in temporary applications; provides durability, high temperature resistance, and dimensional stability for rough or textured surfaces; resists oil and abrasion. |

C2. Surface Raceway

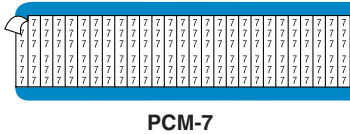

PCM-7

C3. Abrasion Protection

C4. Cable Management

D1. Terminals

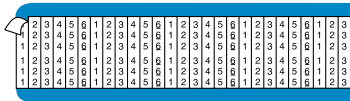

PCM-1-6

D2. Power Connectors

D3. Grounding Connectors

E1. Labeling Systems

E2. Labels

E3. Pre-Printed & Write-On Markers

E4. Permanent Identification

E5. Lockout/Tagout & Safety Solutions

F. Index

| Part Number | Legend | Width | | Length | | Markers Per Card | Std. Pkg. Card(s) | Std. Ctn. Card(s) | |
|----------------------|--------------|-------|------|--------|-------|------------------|-------------------|-------------------|-----|
| | | In. | mm | In. | mm | | | | |
| PCM-0 thru PCM-99 | 0 thru 99 | .25 | 6.40 | 1.50 | 38.10 | 36 | 25 | 100 | |
| PCM-100 thru PCM-202 | 100 thru 202 | .36 | 9.10 | 1.50 | 38.10 | 25 | 25 | 100 | |
| PCMH-0 thru PCMH-25 | 0 thru 25 | .25 | 6.40 | 1.50 | 38.10 | 72 | 25 | 100 | |
| PCM-1-3 | 1 thru 3 | .25 | 6.40 | 1.50 | 38.10 | 36 | 25 | 100 | |
| PCM-1-4 | 1 thru 4 | .25 | 6.40 | 1.50 | 38.10 | | 25 | 100 | |
| PCM-1-5 | 1 thru 5 | .25 | 6.40 | 1.50 | 38.10 | | 25 | 100 | |
| PCM-1-6 | 1 thru 6 | .25 | 6.40 | 1.50 | 38.10 | | 25 | 100 | |
| PCM-1-8 | 1 thru 8 | .25 | 6.40 | 1.50 | 38.10 | | 25 | 100 | |
| PCM-1-9 | 1 thru 9 | .25 | 6.40 | 1.50 | 38.10 | | 25 | 100 | |
| PCM-0-9 | 0 thru 9 | .25 | 6.40 | 1.50 | 38.10 | | 25 | 100 | |
| PCM-1-10 | 1 thru 10 | .25 | 6.40 | 1.50 | 38.10 | | 25 | 100 | |
| PCM-1-12 | 1 thru 12 | .25 | 6.40 | 1.50 | 38.10 | | 25 | 100 | |
| PCM-1-16 | 1 thru 16 | .25 | 6.40 | 1.50 | 38.10 | | 25 | 100 | |
| PCM-1-18 | 1 thru 18 | .25 | 6.40 | 1.50 | 38.10 | | 25 | 100 | |
| PCM-19-36 | 19 thru 36 | .25 | 6.40 | 1.50 | 38.10 | | 25 | 100 | |
| PCM-1-33 | 1 thru 33 | .25 | 6.40 | 1.50 | 38.10 | | 33 | 25 | 100 |
| PCM-34-66 | 34 thru 66 | .25 | 6.40 | 1.50 | 38.10 | | | 25 | 100 |
| PCM-67-99 | 67 thru 99 | .25 | 6.40 | 1.50 | 38.10 | | | 25 | 100 |
| PCM-100-124 | 100 thru 124 | .36 | 9.10 | 1.50 | 38.10 | | 25 | 25 | 100 |
| PCM-125-149 | 125 thru 149 | .36 | 9.10 | 1.50 | 38.10 | 25 | | 100 | |
| PCM-150-174 | 150 thru 174 | .36 | 9.10 | 1.50 | 38.10 | 25 | | 100 | |
| PCM-175-199 | 175 thru 199 | .36 | 9.10 | 1.50 | 38.10 | 25 | | 100 | |

Pre-Printed Marker Cards PCM Type (continued)



PCM-A1

| Part Number | Legend | Width | | Length | | Markers Per Card | Std. Pkg. Card(s) | Std. Ctn. Card(s) |
|--------------------------|----------------------|-------|------|--------|-------|------------------|-------------------|-------------------|
| | | In. | mm | In. | mm | | | |
| PCM-A thru PCM-Z | A thru Z | .25 | 6.40 | 1.50 | 38.10 | 36 | 25 | 100 |
| PCM-A-Z | A thru Z | .25 | 6.40 | 1.50 | 38.10 | | 25 | 100 |
| PCM-A-Z-0-9 | A thru Z 0 thru 9 | .25 | 6.40 | 1.50 | 38.10 | | 25 | 100 |
| PCM-A1 thru PCM-A4 | A1 thru A4 | .25 | 6.40 | 1.50 | 38.10 | | 25 | 100 |
| PCM-A1 thru PCM-B5 | B1 thru B5 | .25 | 6.40 | 1.50 | 38.10 | | 25 | 100 |
| PCM-C1 thru PCM-C4 | C1 thru C4 | .25 | 6.40 | 1.50 | 38.10 | | 25 | 100 |
| PCM-E1 thru PCM-E3 | E1 thru E3 | .25 | 6.40 | 1.50 | 38.10 | | 25 | 100 |
| PCM-F1 thru PCM-F4 | F1 thru F4 | .25 | 6.40 | 1.50 | 38.10 | | 25 | 100 |
| PCM-H1 thru PCM-H5 | H1 thru H5 | .25 | 6.40 | 1.50 | 38.10 | | 25 | 100 |
| PCM-L1 thru PCM-L5 | L1 thru L5 | .25 | 6.40 | 1.50 | 38.10 | | 25 | 100 |
| PCM-M1 thru PCM-M2 | M1 thru M2 | .25 | 6.40 | 1.50 | 38.10 | | 25 | 100 |
| PCM-P1 thru PCM-P3 | P1 thru P3 | .25 | 6.40 | 1.50 | 38.10 | | 25 | 100 |
| PCM-R1 thru PCM-R5 | R1 thru R5 | .25 | 6.40 | 1.50 | 38.10 | | 25 | 100 |
| PCM-S1 thru PCM-S5 | S1 thru S5 | .25 | 6.40 | 1.50 | 38.10 | | 25 | 100 |
| PCM-T1 thru PCM-T9 | T1 thru T9 | .25 | 6.40 | 1.50 | 38.10 | | 25 | 100 |
| PCM-X1 thru PCM-X4 | X1 thru X4 | .25 | 6.40 | 1.50 | 38.10 | | 25 | 100 |

A.
System
Overview

B1.
Cable Ties

B2.
Cable
Accessories

B3.
Stainless
Steel Ties

C1.
Wiring
Duct

C2.
Surface
Raceway

C3.
Abrasion
Protection

C4.
Cable
Management

D1.
Terminals

D2.
Power
Connectors

D3.
Grounding
Connectors

E1.
Labeling
Systems

E2.
Labels

E3.
Pre-Printed
& Write-On
Markers

E4.
Permanent
Identification

E5.
Lockout/
Tagout
& Safety
Solutions

F.
Index

Table continues on page E3.6

A. System Overview

Pre-Printed Marker Cards PCM Type (continued)

B1. Cable Ties

B2. Cable Accessories

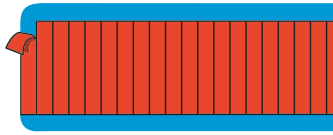

B3. Stainless Steel Ties

C1. Wiring Duct

C2. Surface Raceway

C3. Abrasion Protection

C4. Cable Management

D1. Terminals

D2. Power Connectors

D3. Grounding Connectors

E1. Labeling Systems

E2. Labels

E3. Pre-Printed & Write-On Markers

E4. Permanent Identification

E5. Lockout/Tagout & Safety Solutions

F. Index

| Part Number | Color | Width | | Length | | Markers Per Card | Std. Pkg. Card(s) | Std. Ctn. Card(s) |
|-------------|-------------|-------|------|--------|-------|------------------|-------------------|-------------------|
| | | In. | mm | In. | mm | | | |
| PCM-BLK | Black | .25 | 6.40 | 1.50 | 38.10 | 36 | 25 | 100 |
| PCM-BRN | Brown | .25 | 6.40 | 1.50 | 38.10 | | 25 | 100 |
| PCM-DBL | Dark Blue | .25 | 6.40 | 1.50 | 38.10 | | 25 | 100 |
| PCM-DGN | Dark Green | .25 | 6.40 | 1.50 | 38.10 | | 25 | 100 |
| PCM-GRY | Gray | .25 | 6.40 | 1.50 | 38.10 | | 25 | 100 |
| PCM-LBL | Light Blue | .25 | 6.40 | 1.50 | 38.10 | | 25 | 100 |
| PCM-LGN | Light Green | .25 | 6.40 | 1.50 | 38.10 | | 25 | 100 |
| PCM-ORN | Orange | .25 | 6.40 | 1.50 | 38.10 | | 25 | 100 |
| PCM-PNK | Pink | .25 | 6.40 | 1.50 | 38.10 | | 25 | 100 |
| PCM-PUR | Purple | .25 | 6.40 | 1.50 | 38.10 | | 25 | 100 |
| PCM-RED | Red | .25 | 6.40 | 1.50 | 38.10 | | 25 | 100 |
| PCM-TAN | Tan | .25 | 6.40 | 1.50 | 38.10 | | 25 | 100 |
| PCM-WHT | White | .25 | 6.40 | 1.50 | 38.10 | | 25 | 100 |
| PCM-YEL | Yellow | .25 | 6.40 | 1.50 | 38.10 | | 25 | 100 |

Marker size:

Full size marker – 1.50" (38.10mm). Maximum wire O.D., .38" (9.50mm).

Wire Marker Card Number Combination Packs



Numbers



Letters

| Part Number | Legend | Cards Per Legend | Markers Per Card | Std. Pkg. Qty. | Std. Ctn. Qty. |
|----------------|--------------|------------------|------------------|----------------|----------------|
| PCMCP-1-25* | 1 thru 25 | 1 each | 36 | 1 | 4 |
| PCMCP-26-50* | 26 thru 50 | 1 each | | 1 | 4 |
| PCMCP-51-75* | 51 thru 75 | 1 each | | 1 | 4 |
| PCMCP-76-100* | 76 thru 100 | 1 each | | 1 | 4 |
| PCMCP-101-125* | 101 thru 125 | 1 each | 25 | 1 | 4 |
| PCMCP-126-150* | 126 thru 150 | 1 each | | 1 | 4 |
| PCMCP-A-Z** | A thru Z | 1 each | | 36 | 1 |

Marker size:

Full size marker – 1.50" (38.10mm). Maximum wire O.D. .38" (9.50mm).

*One card each number, 25 cards per package.

**One card each letter, 26 cards per package.

Pre-Printed Marker Cards

- Choose from the many legends available in general purpose vinyl cloth, or from special materials available to meet a variety of application environments
- All markers are offered in full size – 1.50" (38.1mm) long for wire outside diameter up to 0.38" (9.5mm); half size markers for wire outside diameter up to 0.19" (4.7mm) can be ordered
- Each marker on card has a different legend

Material Chart



PSM-7

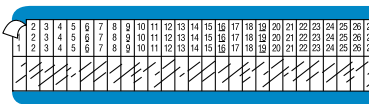

PSM-1-33

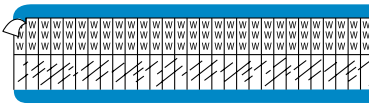

PSM-W

| Material | Print Method | Temperature Range | Features |
|---------------------------------------|--------------|--------------------------------|--|
| Self-Laminating Vinyl, White Print-On | Pre-Printed | -40°F to 150°F (-40°C to 66°C) | Indoor/outdoor rated; thin and conformable; preferred material for most general wire/cable labeling. |

| Part Number | Legend | Width | | Length | | Markers Per Card | Std. Pkg. Card(s) | Std. Ctn. Card(s) |
|-----------------------|------------|-------|------|--------|-------|------------------|-------------------|-------------------|
| | | In. | mm | In. | mm | | | |
| PSM-0-Y thru PSM-52-Y | 0 thru 52 | .25 | 6.40 | .75 | 19.10 | 36 | 25 | 100 |
| PSM-0-9-Y | 0 thru 9 | .25 | 6.40 | .75 | 19.10 | | 25 | 100 |
| PSM-1-33-Y | 1 thru 33 | .25 | 6.40 | .75 | 19.10 | 33 | 25 | 100 |
| PSM-34-66-Y | 34 thru 66 | .25 | 6.40 | .75 | 19.10 | | 25 | 100 |
| PSM-67-99-Y | 67 thru 99 | .25 | 6.40 | .75 | 19.10 | 36 | 25 | 100 |
| PSM-A-Y thru PSM-Z | A thru Z | .25 | 6.40 | .75 | 19.10 | | 25 | 100 |
| PSM-A-Z-Y | A thru Z | .25 | 6.40 | .75 | 19.10 | | 25 | 100 |

Legend: Black Background: White

Marker sizes:

Full size marker – 1.50" (38.10mm). Maximum wire O.D., .38" (9.50mm).

Half size marker – .75" (19.10mm). Maximum wire O.D., .19" (4.70mm).

A. System Overview

B1. Cable Ties

B2. Cable Accessories

B3. Stainless Steel Ties

C1. Wiring Duct

C2. Surface Raceway

C3. Abrasion Protection

C4. Cable Management

D1. Terminals

D2. Power Connectors

D3. Grounding Connectors

E1. Labeling Systems

E2. Labels

E3. Pre-Printed & Write-On Markers

E4. Permanent Identification

E5. Lockout/Tagout & Safety Solutions

F. Index

A. System Overview

Pre-Printed Marker Cards PPM Type

B1. Cable Ties

B2. Cable Accessories

B3. Stainless Steel Ties

Material Chart



PPM-7

| Material | Print Method | Temperature Range | Features |
|----------------|--------------|------------------------------------|---|
| TEDLAR®, White | Pre-Printed | -40°F to 275°F (-40°C to 135°C) | Indoor/outdoor rated; self-extinguishing; ideal for component labeling in harsh environments. |

*TEDLAR is a registered trademark of E.I. du Pont de Nemours and Company.

C1. Wiring Duct



PPM-1-33

| Part Number | Legend | Width | | Length | | Markers Per Card | Std. Pkg. Card(s) | Std. Ctn. Card(s) |
|---------------------------------|-----------|-------|------|--------|-------|------------------|-------------------|-------------------|
| | | In. | mm | In. | mm | | | |
| PPM-0 thru PPM-25 | 0 thru 25 | .25 | 6.40 | 1.50 | 38.10 | 36 | 25 | 100 |
| PPM-1-33 | 1 thru 33 | .25 | 6.40 | 1.50 | 38.10 | 33 | 25 | 100 |
| PPM-A thru PPM-C | A thru C | .25 | 6.40 | 1.50 | 38.10 | 36 | 25 | 100 |

Legend: Black Background: White
 Marker sizes:
 Half size marker – 1.50" (38.10mm). Maximum wire O.D., .38" (9.50mm).

C4. Cable Management

D1. Terminals

D2. Power Connectors

D3. Grounding Connectors

E1. Labeling Systems

E2. Labels

E3. Pre-Printed & Write-On Markers

E4. Permanent Identification

E5. Lockout/Tagout & Safety Solutions

F. Index

Write-On Marker Cards – Self-Laminating

- Clear section of marker overlaminates and protects write-on legend
- Markers have ink receptive area to allow hand-written legends

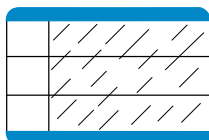

Type PSCC



Type PSWM



Type PSWMH

| Part Number | Width | | Length | | Print-On Height | | Min. Cable O.D. | | Max. Cable O.D. | | Markers Per Card | Std. Pkg. Card(s) | Std. Ctn. Card(s) |
|-------------|-------|-------|--------|--------|-----------------|-------|-----------------|------|-----------------|-------|------------------|-------------------|-------------------|
| | In. | mm | In. | mm | In. | mm | In. | mm | In. | mm | | | |
| PSCC-3Y | 1.00 | 25.40 | 3.00 | 76.20 | .75 | 19.10 | .24 | 6.06 | .72 | 18.19 | 3 | 25 | 100 |
| PSCC-5Y | 1.00 | 25.40 | 5.00 | 127.00 | 1.00 | 25.40 | .32 | 8.09 | 1.27 | 32.34 | 3 | 25 | 100 |
| PSWMH-375Y | .38 | 9.50 | .75 | 19.10 | .38 | 9.50 | .12 | 3.07 | .12 | 2.99 | 50 | 25 | 100 |
| PSWM-375Y | .38 | 9.50 | 1.5 | 38.10 | .75 | 19.10 | .24 | 6.06 | .24 | 6.06 | 25 | 25 | 100 |
| PSWM-750Y | .75 | 19.10 | 1.5 | 38.10 | .75 | 19.10 | .24 | 6.06 | .24 | 6.06 | 12 | 25 | 100 |
| PSWMH-750Y | .75 | 19.10 | .75 | 19.10 | .38 | 9.50 | .12 | 3.07 | .12 | 2.99 | 24 | 25 | 100 |
| PSWM-1500Y | 1.5 | 38.10 | 1.5 | 38.10 | .75 | 19.10 | .24 | 6.06 | .24 | 6.06 | 6 | 25 | 100 |

Pre-Printed Marker Tape Dispenser

- Flexible polyester marker tape conforms tightly to wires/cables
- Dispenser allows marker tape to be cut to the exact length required for marking any size wire/cable
- Durable plastic dispenser can be attached to tool belt for industrial use



Material Chart

| Material | Print Method | Temperature Range | Features |
|------------------|--------------|------------------------------------|---|
| Polyester, White | Pre-Printed | -40°F to 250°F (-40°C to 121°C) | Indoor/outdoor rated; laminated label material protects legend from abrasion and chemicals; resistant to UV light chemical atmosphere and abrasion; excellent life and adhesion properties. |

| Part Number | Part Description | Roll | | Rolls Per Legend Per Pkg. | Std. Pkg. Qty. | Std. Ctn. Qty. |
|-------------|---|------|-----|---------------------------|----------------|----------------|
| | | Ft. | m | | | |
| PMD | Empty dispenser. | — | — | — | 1 | 10 |
| PMD-0-9 | Dispenser filled with one roll each legend 0 thru 9. | 8.0 | 2.4 | 1 | 1 | 10 |
| PMD-NEMA | Dispenser filled with one roll each of solid NEMA colors: black, light blue, brown, gray, light green, orange, purple, red, white and yellow. | 8.0 | 2.4 | 1 | 1 | 10 |

A. System Overview

B1. Cable Ties

B2. Cable Accessories

B3. Stainless Steel Ties

C1. Wiring Duct

C2. Surface Raceway

C3. Abrasion Protection

C4. Cable Management

D1. Terminals

D2. Power Connectors

D3. Grounding Connectors

E1. Labeling Systems

E2. Labels

E3. Pre-Printed & Write-On Markers

E4. Permanent Identification

E5. Lockout/Tagout & Safety Solutions

F. Index

A.
System
Overview

Pre-Printed Marker Tape Refills

B1.
Cable Ties



B2.
Cable
Accessories

B3.
Stainless
Steel Ties



C1.
Wiring
Duct

C2.
Surface
Raceway

C3.
Abrasion
Protection

C4.
Cable
Management

D1.
Terminals

D2.
Power
Connectors

D3.
Grounding
Connectors

E1.
Labeling
Systems

E2.
Labels

E3.
Pre-Printed
& Write-On
Markers

E4.
Permanent
Identification

E5.
Lockout/
Tagout/
& Safety
Solutions

F.
Index

| Part Number | Legend | Roll Length | | Rolls Per Legend Per Pkg. | Std. Pkg. Roll(s) | Std. Ctn. Roll(s) | | | |
|--|---|-------------|-----|---------------------------|-------------------|-------------------|----|----|-----|
| | | Ft. | m | | | | | | |
| PMDR-0-9 thru PMDR-90-99 | 0 thru 9 thru 90 thru 99 | 8.0 | 2.4 | 10 | 1 | 10 | | | |
| PMDR-0 thru PMDR-9 | 0 thru 9 | | | | 10 | 100 | | | |
| PMDR-A thru PMDR-Z | A thru Z | | | | 10 | 100 | | | |
| PMDR-L1 thru PMDR-L3 | L1 thru L3 | | | | 10 | 100 | | | |
| PMDR-T1 thru PMDR-T3 | T1 thru T3 | | | | 10 | 100 | | | |
| PMDR-GRS | Ground symbol | | | | 8.0 | 2.4 | 10 | 10 | 100 |
| PMDR-MIN | Minus symbol | | | | | | | 10 | 100 |
| PMDR-PLS | Plus symbol | | | | | | | 10 | 100 |
| PMDR-BLK | Black | | | | | | | 10 | 100 |
| PMDR-BL | Light Blue | | | | | | | 10 | 100 |
| PMDR-BRN | Brown | 10 | 100 | | | | | | |
| PMDR-GRN | Light Green | 10 | 100 | | | | | | |
| PMDR-GRY | Gray | 10 | 100 | | | | | | |
| PMDR-ORN | Orange | 10 | 100 | | | | | | |
| PMDR-PUR | Purple | 10 | 100 | | | | | | |
| PMDR-RED | Red | 10 | 100 | | | | | | |
| PMDR-WHT | White | 10 | 100 | | | | | | |
| PMDR-YEL | Yellow | 10 | 100 | | | | | | |
| PMDR-NEMA | One of each of the NEMA colors featured above | 1 | 1 | 10 | | | | | |

Self-Laminating Wire Marker Dispenser

- Self-laminating labels are provided in handy dispenser which protects markers when not in use
- Clear section of marker overlaminates and protects write-on legend
- Quick, easy to use for smaller installations and maintenance



Material Chart

| Material | Print Method | Temperature Range | Features |
|---------------------------------------|--------------|--------------------------------|--|
| Self-Laminating Vinyl, White Print-On | Pre-Printed | -40°F to 150°F (-40°C to 66°C) | Indoor/outdoor rated; thin and conformable; preferred material for most general wire/cable labeling. |

| Part Number | Part Description | Width | | Length | | Print-On Height | | Min. Cable O.D. | | Max. Cable O.D. | | Std. Pkg. Qty. | Std. Ctn. Qty. |
|----------------------|--|-------|-------|--------|-------|-----------------|-------|-----------------|------|-----------------|-------|----------------|----------------|
| | | In. | mm | In. | mm | In. | mm | In. | mm | In. | mm | | |
| Dispenser Kit | | | | | | | | | | | | | |
| S100X125VARY | (1) Dispenser. (1) Roll, white write-on, vinyl label, 200/roll. (1) PFX-0 pen. | 1.00 | 25.40 | 1.25 | 31.75 | .38 | 9.65 | .12 | 3.07 | .28 | 7.03 | 1 | 10 |
| S100X225VARY | (1) Dispenser. (1) Roll, white write-on, vinyl label, 100/roll. (1) PFX-0 pen. | 1.00 | 25.40 | 2.25 | 57.15 | .75 | 19.05 | .24 | 6.06 | .48 | 12.13 | 1 | 10 |
| Refill Rolls | | | | | | | | | | | | | |
| S100X125VAFY | Replacement roll. White write-on, vinyl label, 200/roll. | 1.00 | 25.40 | 1.25 | 31.75 | .38 | 9.65 | .12 | 3.07 | .28 | 7.03 | 1 | 10 |
| S100X225VAFY | Replacement roll. White write-on, vinyl label 100/roll. | 1.00 | 25.40 | 2.25 | 57.15 | .75 | 19.05 | .24 | 6.06 | .48 | 12.13 | 1 | 10 |

Can be clearly identified with *PANDUIT* permanent marking pens shown on page E5.19.

Pre-Printed Clip-On Wire Markers

- Non-adhesive markers grip tightly to wire/cable
- Markers supplied on application wand tool
- Chevron cut keeps multiple markers aligned
- Black legend is embossed into wire marker clip



Material Chart

| Material | Print Method | Temperature Range | Features |
|---------------------|--------------|--------------------------------|--|
| Non-Adhesive Acetal | Pre-Printed | -22°F to 194°F (-30°C to 90°C) | Indoor/outdoor rated; durable material that has excellent resiliency to oils and solvents. |

| Part Number | Legend | No. of Markers Per Wand | Markers Per Pkg. | Std. Pkg. Qty. | Std. Ctn. Qty. |
|-------------|--------|-------------------------|------------------|----------------|----------------|
|-------------|--------|-------------------------|------------------|----------------|----------------|

Wire/Cable Diameter .08" – .10" (2.00mm – 2.50mm)

| | | | | | |
|------------------------------------|----------|----|-----|---|----|
| PCA07-A thru PCA07-Z | A thru Z | 30 | 300 | 1 | 10 |
| PCA07-A-J | A-J | | | 1 | 10 |
| PCA07-K-T | K-T | | | 1 | 10 |
| PCA07-U-Z | U-Z | | | 1 | 10 |
| PCA07-0 thru PCA07-9 | 0 thru 9 | 30 | 300 | 1 | 10 |
| PCA07-0-9 | 0-9 | | | 1 | 10 |
| PCA07-MIN | — | | | 1 | 10 |
| PCA07-PLS | + | | | 1 | 10 |

Table continues on page E3.12

Pre-Printed Clip-On Wire Markers (continued)

| | |
|-----|-----------------------------------|
| A. | System Overview |
| B1. | Cable Ties |
| B2. | Cable Accessories |
| B3. | Stainless Steel Ties |
| C1. | Wiring Duct |
| C2. | Surface Raceway |
| C3. | Abrasion Protection |
| C4. | Cable Management |
| D1. | Terminals |
| D2. | Power Connectors |
| D3. | Grounding Connectors |
| E1. | Labeling Systems |
| E2. | Labels |
| E3. | Pre-Printed & Write-On Markers |
| E4. | Permanent Identification |
| E5. | Lockout/Tagout & Safety Solutions |
| F. | Index |

| Part Number | Legend | No. of Markers Per Wand | Markers Per Pkg. | Std. Pkg. Qty. | Std. Ctn. Qty. | | |
|--|------------|-------------------------|------------------|----------------|----------------|---|----|
| Wire/Cable Diameter .11" – .13" (2.80mm – 3.30mm) | | | | | | | |
| PCA11-A thru PCA11-Z | A thru Z | 30 | 300 | 1 | 10 | | |
| PCA11-A-J | A-J | | | 1 | 10 | | |
| PCA11-K-T | K-T | | | 1 | 10 | | |
| PCA11-U-Z | U-Z | | | 1 | 10 | | |
| PCA11-0 thru PCA11-9 | 0 thru 9 | | | 1 | 10 | | |
| PCA11-0-9 | 0-9 | | | 1 | 10 | | |
| PCA11-MIN | — | | | 1 | 10 | | |
| PCA11-PLS | + | | | 1 | 10 | | |
| Wire/Cable Diameter .13" – .15" (3.30mm – 3.80mm) | | | | | | | |
| PCA13-A thru PCA13-Z | A thru Z | | | 30 | 300 | 1 | 10 |
| PCA13-A-J | A-J | 1 | 10 | | | | |
| PCA13-K-T | K-T | 1 | 10 | | | | |
| PCA13-U-Z | U-Z | 1 | 10 | | | | |
| PCA13-0 thru PCA13-9 | 0 thru 9 | 1 | 10 | | | | |
| PCA13-0-9 | 0-9 | 1 | 10 | | | | |
| PCA13-MIN | — | 1 | 10 | | | | |
| PCA13-PLS | + | 1 | 10 | | | | |
| Wire/Cable Diameter .19" – .23" (4.80mm – 5.80mm) | | | | | | | |
| PCA18-A thru PCA18-Z | A thru Z | 30 | 300 | | | 1 | 10 |
| PCA18-A-J | A-J | | | 1 | 10 | | |
| PCA18-K-T | K-T | | | 1 | 10 | | |
| PCA18-U-Z | U-Z | | | 1 | 10 | | |
| PCA18-0 thru PCA18-9 | 0 thru 9 | | | 1 | 10 | | |
| PCA18-0-9 | 0-9 | | | 1 | 10 | | |
| PCA18-MIN | — | | | 1 | 10 | | |
| PCA18-PLS | + | | | 1 | 10 | | |
| Wire/Cable Diameter .23" – .37" (5.80mm – 9.40mm) | | | | | | | |
| PCA23-A thru PCA23-Z | A thru Z | | | 20 | 60 | 1 | 10 |
| PCA23-A-D | A-D | 1 | 10 | | | | |
| PCA23-E-H | E-H | 1 | 10 | | | | |
| PCA23-I-L | I-L | 1 | 10 | | | | |
| PCA23-M-P | M-P | 1 | 10 | | | | |
| PCA23-Q-T | Q-T | 1 | 10 | | | | |
| PCA23-U-X | U-X | 1 | 10 | | | | |
| PCA23-Y-Z | Y-Z, +, - | 1 | 10 | | | | |
| PCA23-0 thru PCA23-9 | 0 thru 9 | 60 | 1 | | 10 | | |
| PCA23-0-3 | 0-3 | 80 | 1 | | 10 | | |
| PCA23-4-7 | 4-7 | | 1 | 10 | | | |
| PCA23-8-9 | 8, 9, +, - | | 1 | 10 | | | |
| PCA23-MIN | — | 60 | 1 | 10 | | | |
| PCA23-PLS | + | | 1 | 10 | | | |

PERMANENT IDENTIFICATION

PANDUIT offers the widest range of permanent identification solutions in the industry to withstand the test of time and provide legibility in harsh environments. Safe, quick, and easy to install, PANDUIT permanent identification solutions include stainless steel and aluminum marker plates, tags, marking tools and ties to deliver improved productivity and workplace safety.

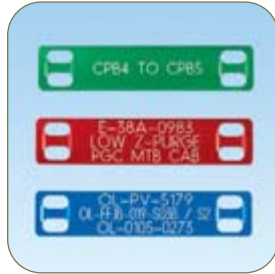
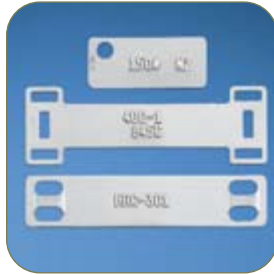

- Factory Custom Marking Service creates embossed or laser etched metal plates, tags, and ties to speed installation time and reduce labor costs
- Portable on-site marking tools for quick and easy identification on demand
- Large identification selection delivers maximum design flexibility to match your specific application requirements
- Optimized for easy use with PANDUIT self-locking stainless steel and aluminum ties; for details, refer to PAN-STEEL® System Section B3

PANDUIT continues to design permanent identification products for harsh environments by addressing customer problems with innovative solutions and reliable tooling to achieve lowest installed cost.

A.
System
Overview

B1.
Cable
Ties

B2.
Cable
Accessories

B3.
Stainless
Steel
Ties

C1.
Wiring
Duct

C2.
Surface
Raceway

C3.
Abrasion
Protection

C4.
Cable
Management

D1.
Terminals

D2.
Power
Connectors

D3.
Grounding
Connectors

E1.
Labeling
Systems

E2.
Labels

E3.
Pre-Printed
& Write-On
Markers

E4.
Permanent
Identification

E5.
Lockout/
Tagout/
& Safety
Solutions

F.
Index

A. System Overview

PANDUIT Factory Custom Marking Service

B1. Cable Ties

PANDUIT Factory Custom Marking Service simplifies identification with high quality, made-to-order custom embossed marker plates and tags or laser etched cable ties, marker plates, and tags. PANDUIT offers rapid direct shipment with fast turn around on custom marking orders worldwide. Work with PANDUIT to create an effectively identified workplace.

B2. Cable Accessories

B3. Stainless Steel Ties

C1. Wiring Duct

C2. Surface Raceway

C3. Abrasion Protection

C4. Cable Management

D1. Terminals

D2. Power Connectors

D3. Grounding Connectors

E1. Labeling Systems

E2. Labels

E3. Pre-Printed & Write-On Markers

E4. Permanent Identification

E5. Lockout/Tagout & Safety Solutions

F. Index

EMBOSSING SERVICE

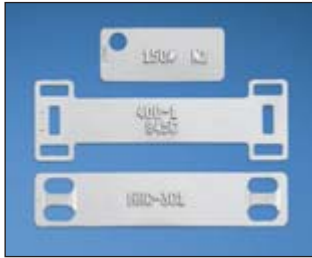

- Used on rectangular metal marker plates and tags which are a maximum of .020 inches (.5mm) thick and minimum .38 inches (10mm) width
- Excellent for applications that are exposed to dirt and paint
- Upper case "raised" character
- Alphanumeric and sequential numbering

LASER MARKING SERVICE



- Used on all metal marker plates, tags, and cable ties
- BOLD block letters
- Upper and lower case character capability
- Ability to create text and graphics
- Alphanumeric and sequential numbering

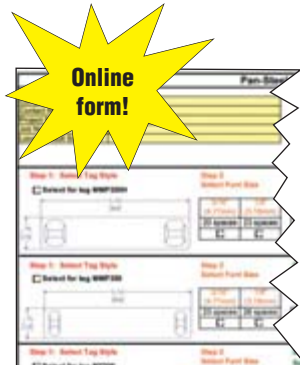

To select and order custom embossed marker plates and tags:

- Use online order form (C2-0677) at www.panduit.com/permanentID to select the proper marker plate or tag for your application. Email order form to your Authorized PANDUIT Distributor for order placement or contact PANDUIT Customer Service for assistance.

To order laser etched plates and tags – Contact PANDUIT

Character sizes available:

- 1/8" (3.18mm)
- 3/16" (4.77mm)
- 1/4" (6.35mm)
- 5/16" (7.94mm)
- 1/2" (12.7mm) – Laser only



PANDUIT offers a full line of labeling products, software and printers to assist you with your labeling requirements.

See pages E1.0 – E2.30.



PANDUIT permanent identification products are optimized for easy use with PANDUIT self-locking stainless steel and aluminum ties. For details, refer to PAN-STEEL® System Section B3.

Stainless Steel and Brass Marker Plates and Tags

- Provides permanent identification of pipes, conduit, valves, cables and equipment in harsh environments
- Designed for use with *PANDUIT® PAN-STEEL®* Stainless Steel Cable Ties for fast installation at lowest installed cost
- All marker plates/tags can be embossed or laser etched with *PANDUIT* Factory Custom Marking Service
- For on-site custom marking use the *PANDUIT* Metal Indenting Machine (MIM) for details, see page E4.6
- Designated plates feature easy feed design with a raised slot to simplify cable tie installation and improve productivity



MMP350-C



MMP350H-C



MMP350DB-C



MMP350W38-C



MMP172-C



MMP172W38-C



MMP350W17-Q



MMP338W21-Q

| Part Number | Material | Color | Length/ Diameter | | Width | | Custom Marking Parameters* | | Used with <i>PAN-STEEL®</i> Cable Ties** | Thickness | | Std. Pkg. Qty. | Std. Ctn. Qty. |
|------------------------|---------------------|---------|---------------------|----|-------|----|---|-----------------------|--|-----------|-----|----------------------|----------------------|
| | | | In. | mm | In. | mm | Max. 3/16" (4.77mm) Character Per Line | Max. Lines of Text | | In. | mm | | |
| MMP350-C‡ | 304 Stainless Steel | Natural | 3.50 | 89 | .75 | 19 | 23 | 3 | MLT-S | .010 | .25 | 100 | 1000 |
| MMP350-C316‡ | 316 Stainless Steel | Natural | 3.50 | 89 | .75 | 19 | 23 | 3 | MLT-S | .010 | .25 | 100 | 1000 |
| MMP350H-C‡ | 304 Stainless Steel | Natural | 3.50 | 89 | .75 | 19 | 20 | 3 | MLT-H | .010 | .25 | 100 | 1000 |
| MMP350H-C316‡ | 316 Stainless Steel | Natural | 3.50 | 89 | .75 | 19 | 20 | 3 | MLT-H | .010 | .25 | 100 | 1000 |
| MMP350DB-C‡ | 304 Stainless Steel | Natural | 3.50 | 89 | 1.12 | 29 | 20 | 3 | MLT-H | .015 | .38 | 100 | 1000 |
| MMP350DB-C316‡ | 316 Stainless Steel | Natural | 3.50 | 89 | 1.12 | 29 | 20 | 3 | MLT-H | .015 | .38 | 100 | 1000 |
| MMP350W38-C‡ | 304 Stainless Steel | Natural | 3.50 | 89 | .38 | 10 | 23 | 1 | MLT-S | .010 | .25 | 100 | 1000 |
| MMP350W38-C316‡ | 316 Stainless Steel | Natural | 3.50 | 89 | .38 | 10 | 23 | 1 | MLT-S | .010 | .25 | 100 | 1000 |
| MMP172-C‡ | 304 Stainless Steel | Natural | 1.72 | 44 | .75 | 19 | 8 | 3 | MLT-S | .010 | .25 | 100 | 1000 |
| MMP172-C316‡ | 316 Stainless Steel | Natural | 1.72 | 44 | .75 | 19 | 8 | 3 | MLT-S | .010 | .25 | 100 | 1000 |
| MMP172W38-C‡ | 304 Stainless Steel | Natural | 1.72 | 44 | .38 | 10 | 8 | 1 | MLT-S | .010 | .25 | 100 | 1000 |
| MMP172W38-C316‡ | 316 Stainless Steel | Natural | 1.72 | 44 | .38 | 10 | 8 | 1 | MLT-S | .010 | .25 | 100 | 1000 |
| MMP350W17-Q | 304 Stainless Steel | Natural | 3.50 | 89 | 1.73 | 44 | 26 | 6 | MLT-S | .015 | .38 | 25 | 250 |
| MMP338W21-Q | 304 Stainless Steel | Natural | 3.38 | 86 | 2.13 | 54 | 22 | 6 | MLT-S | .015 | .38 | 25 | 250 |

*See page E4.2 for *PANDUIT* Factory Custom Marking Service information.

**See pages B3.5 – B3.7 for *PAN-STEEL®* Stainless Steel Cable Ties.

‡Easy feed marker plate with raised cable tie slot.

Table continues on page E4.4

A.
System
Overview

B1.
Cable Ties

B2.
Cable
Accessories

B3.
Stainless
Steel Ties

C1.
Wiring
Duct

C2.
Surface
Raceway

C3.
Abrasion
Protection

C4.
Cable
Management

D1.
Terminals

D2.
Power
Connectors

D3.
Grounding
Connectors

E1.
Labeling
Systems

E2.
Labels

E3.
Pre-Printed
& Write-On
Markers

E4.
Permanent
Identification

E5.
Lockout/
Tagout
& Safety
Solutions

F.
Index

A. System Overview

Stainless Steel and Brass Marker Plates and Tags (continued)

B1. Cable Ties

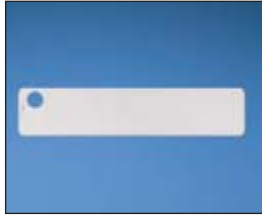

MT350-C



MT350W17-Q



MT338W21-Q



MT172-C

B2. Cable Accessories

B3. Stainless Steel Ties



MT172W38-C



MTB1D-Q



MTB150D-Q



MTB213D-Q



MT125S-Q

C1. Wiring Duct

C2. Surface Raceway

C3. Abrasion Protection

C4. Cable Management

D1. Terminals

D2. Power Connectors

D3. Grounding Connectors

E1. Labeling Systems

E2. Labels

E3. Pre-Printed & Write-On Markers

E4. Permanent Identification

E5. Lockout/Tagout & Safety Solutions

F. Index

| Part Number | Material | Color | Length/ Diameter | | Width | | Custom Marking Parameters* | | Used with PAN-STEEL® Cable Ties** | Thickness | | Std. Pkg. Qty. | Std. Ctn. Qty. |
|--------------------|---------------------|---------|---------------------|----|------------------|----|---|-----------------------|---|-----------|------|----------------------|----------------------|
| | | | In. | mm | In. | mm | Max. 3/16" (4.77mm) Character Per Line | Max. Lines of Text | | In. | mm | | |
| MT350-C | 304 Stainless Steel | Natural | 3.50 | 89 | .75 | 19 | 26 | 3 | MLT-S | .010 | .25 | 100 | 1000 |
| MT350-C316 | 316 Stainless Steel | Natural | 3.50 | 89 | .75 | 19 | 23 | 3 | MLT-S | .010 | .25 | 100 | 1000 |
| MT350W17-Q | 304 Stainless Steel | Natural | 3.50 | 89 | 1.73 | 44 | 23 | 6 | MLT-S | .015 | .38 | 25 | 250 |
| MT338W21-Q | 304 Stainless Steel | Natural | 3.38 | 86 | 2.13 | 54 | 22 | 6 | MLT-S | .015 | .38 | 25 | 250 |
| MT172-C | 304 Stainless Steel | Natural | 1.72 | 44 | .75 | 19 | 10 | 3 | MLT-S | .010 | .25 | 100 | 1000 |
| MT172-C316 | 316 Stainless Steel | Natural | 1.72 | 44 | .75 | 19 | 10 | 3 | MLT-S | .010 | .25 | 100 | 1000 |
| MT172W38-C | 304 Stainless Steel | Natural | 1.72 | 44 | .38 | 10 | 10 | 1 | MLT-S | .010 | .25 | 100 | 1000 |
| MT1D-Q | 304 Stainless Steel | Natural | — | — | 1.00 circular | 25 | 5 | 1 | MLT-S | .035 | .89 | 25 | 250 |
| MT1D-Q316 | 316 Stainless Steel | Natural | — | — | 1.00 circular | 25 | 5 | 1 | MLT-S | .035 | .89 | 25 | 250 |
| MTB1D-Q | Brass | Brass | — | — | 1.00 circular | 25 | 5 | 1 | MLT-S | .040 | 1.02 | 25 | 250 |
| MT150D-Q | 304 Stainless Steel | Natural | — | — | 1.50 circular | 38 | 5,6,5 | 3 | MLT-S | .035 | .89 | 25 | 250 |
| MT150D-Q316 | 316 Stainless Steel | Natural | — | — | 1.50 circular | 38 | 5,6,5 | 3 | MLT-S | .035 | .89 | 25 | 250 |
| MTB150D-Q | Brass | Brass | — | — | 1.50 circular | 38 | 5,6,5 | 3 | MLT-S | .040 | 1.02 | 25 | 250 |
| MT213D-Q | 304 Stainless Steel | Natural | — | — | 2.13 circular | 54 | 6,12,8 | 3 | MLT-S | .015 | .38 | 25 | 250 |
| MT213D-Q316 | 316 Stainless Steel | Natural | — | — | 2.13 circular | 54 | 6,12,8 | 3 | MLT-S | .015 | .38 | 25 | 250 |
| MTB213D-Q | Brass | Brass | — | — | 2.13 circular | 54 | 6,12,8 | 3 | MLT-S | .015 | .38 | 25 | 250 |
| MT125S-Q | 304 Stainless Steel | Natural | 1.25 square | 32 | 1.25 square | 32 | 5 | 2 | MLT-S | .035 | .89 | 25 | 250 |

*See page E4.2 for PANDUIT Factory Custom Marking Service information.

**See pages B3.5 – B3.7 for PAN-STEEL® Stainless Steel Cable Ties.

PAN-ALUM™ Aluminum Marker Plates



- Lightweight, aluminum construction for flexibility and ease of handling
- Five color options in addition to natural aluminum provide quick visual identification, ideal for applications requiring color-coding

- Easy feed marker plate design includes a raised slot to simplify cable tie installation and improve productivity

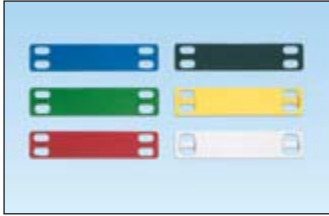

| Part Number | Material | Color | Length | | Width | | Custom Marking Parameters* | | Used with PAN-ALUM™ Cable Ties | Std. Pkg. Qty. | Std. Ctn. Qty. |
|---------------|-------------------|---------|--------|------|-------|------|---|------------|--|----------------|----------------|
| | | | In. | mm | In. | mm | Max. 3/16" (4.77mm) Characters per Line | Max. Lines | | | |
| MMP350H-CALBU | Anodized Aluminum | Blue | 3.50 | 88.9 | .75 | 19.1 | 20 | 3 | MLT1H-LPAL* MLT2H-LPAL* and MLT4H-LPAL* | 100 | 1000 |
| MMP350H-CALGR | | Green | | | | | | | | 100 | 1000 |
| MMP350H-CALRD | | Red | | | | | | | | 100 | 1000 |
| MMP350H-CALBL | | Black | | | | | | | | 100 | 1000 |
| MMP350H-CALYL | | Yellow | | | | | | | | 100 | 1000 |
| MMP350H-CAL | Aluminum | Natural | | | | | | | | 100 | 1000 |

*See PAN-ALUM™ Aluminum Ties on page B3.10 for matching natural finish and five colors.

**See page E4.2 for PANDUIT Factory Custom Marking Service.

Metal Embossing Tool and Tape System

- Creates custom length identification
- Embosses 3/16" (4.77mm) characters onto stainless steel or aluminum tape

- Ability to create a raised cable tie slot for fast installation



| Part Number | Part Description | Std. Pkg. Qty. |
|-----------------|---|----------------|
| Tool Kit | | |
| MEHT | Includes tool, carrying case, one roll each META (aluminum) and METS4 (stainless steel) tape. Characters include: A B C D E F G H I J K L M N O P Q R S T U V W X Y Z 2 3 4 5 6 7 8 9 . - | 1 |
| Tape | | |
| META-X | .50" x 16' (12.7mm x 4.9m) aluminum tape*. | 10 |
| METS3-X | .50" x 21' (12.7mm x 6.4m) 316 grade stainless steel tape. | 10 |
| METS4-X | .50" x 21' (12.7mm x 6.4m) 304 grade stainless steel tape. | 10 |

*Aluminum ties are recommended for use with aluminum tape to prevent galvanic reaction (corrosion that can occur between stainless steel and aluminum in certain environments).

A.
System
Overview

B1.
Cable Ties

B2.
Cable
Accessories

B3.
Stainless
Steel Ties

C1.
Wiring
Duct

C2.
Surface
Raceway

C3.
Abrasion
Protection

C4.
Cable
Management

D1.
Terminals

D2.
Power
Connectors

D3.
Grounding
Connectors

E1.
Labeling
Systems

E2.
Labels

E3.
Pre-Printed
& Write-On
Markers

E4.
Permanent
Identification

E5.
Lockout/
Tagout
& Safety
Solutions

F.
Index

A. System Overview



Metal Indenting Machine

B1. Cable Ties

- Provides quick, easy, and permanent identification with **PANDUIT® PAN-ALUM™** Marker Plates and Cable Ties and **PAN-STEEL®** Stainless Steel Marker Plates, Tags, Cable Ties and Straps
- Automatic table indexing advances material forward for convenience and improved productivity
- New, improved design features aluminum base and durable construction

B2. Cable Accessories



B3. Stainless Steel Ties

C1. Wiring Duct



C2. Surface Raceway

C3. Abrasion Protection

C4. Cable Management

Marker Stamp Kit

- Provides permanent identification of **PANDUIT® PAN-STEEL®** Stainless Steel Cable Ties, Straps, Marker Plates and Tags

D2. Power Connectors



D3. Grounding Connectors

E1. Labeling Systems

E2. Labels

E3. Pre-Printed & Write-On Markers

E4. Permanent Identification

E5. Lockout/Tagout & Safety Solutions

F. Index

| Part Number | Part Description | Std. Pkg. Qty. |
|-----------------------------------|---|----------------|
| Indenting Machine | | |
| MIM094 | Indenting machine with 3/32" (2.38mm) character wheel. | 1 |
| MIM125 | Indenting machine with 1/8" (3.18mm) character wheel. | 1 |
| MIM187 | Indenting machine with 3/16" (4.77mm) character wheel. | 1 |
| Interchangeable Wheel Kits | | |
| MIW094 | 3/32" (2.38mm) character wheel kit (wheel and indexing gear). | 1 |
| MIW125 | 1/8" (3.18mm) character wheel kit (wheel and indexing gear). | 1 |
| MIW187 | 3/16" (4.77mm) character wheel kit (wheel and indexing gear). | 1 |

| Part Number | Part Description | Std. Pkg. Qty. |
|--------------|---|----------------|
| STK12 | Marker stamp kit contains (100) character stamps, (1) holder and (1) carrying case. High quality 1/8" (3.18mm) nom. size steel character. Type holder keeps type aligned and provides uniform depth of impression. The holder takes up to nine characters – 1 1/8" (28.6mm) long. | 1 |

Characters include:
 A A A B B C C D D E E E E F F G G H H I I J J K K L L L M M N N N O O O P P Q R R R R S S S T T U U U V V
 W X X Y Z & // - - . . . , 1 1 1 1 2 2 2 2 3 3 3 3 4 4 4 4 5 5 5 5 6 6 6 6 7 7 7 7 8 8 8 8 9 9 0 0 0

LOCKOUT/TAGOUT

The Occupational Safety and Health Administration (OSHA) mandates that all energy sources be isolated and locked out to protect employees from injuries caused by the accidental startup of equipment under repair or service. OSHA 1910.147 outlines the control of this hazardous energy with an effective lockout/tagout program. *PANDUIT* offers a complete line of lockout/tagout products to aid in compliance with OSHA 1910.147 including:



- Training manuals and videos to help train employees on the requirements of lockout/tagout
- Extensive line of universal, high quality devices to lockout a variety of energy sources
- Lockout/tagout kits and stations that offer a convenient method to store and contain lockout devices, tags, and padlocks
- High quality, durable, secure padlocks in a variety of styles, colors, and keying configurations that ensure safety and security
- Extensive line of safety identification products that include tags, signs, and warning labels

PANDUIT offers everything you need to establish and maintain an effective lockout/tagout program. Ensure employee safety while conducting lockout/tagout procedures by utilizing *PANDUIT* innovative products and high quality materials.

A.
System
Overview

B1.
Cable Ties

B2.
Cable
Accessories

B3.
Stainless
Steel Ties

C1.
Wiring
Duct

C2.
Surface
Raceway

C3.
Abrasion
Protection

C4.
Cable
Management

D1.
Terminals

D2.
Power
Connectors

D3.
Grounding
Connectors

E1.
Labeling
Systems

E2.
Labels

E3.
Pre-Printed
& Write-On
Markers

E4.
Permanent
Identification

E5.
Lockout/
Tagout
& Safety
Solutions

F.
Index

A.
System
Overview

OSHA Lockout/Tagout Compliance Manual

• Takes you step-by-step through the process of bringing your company into compliance with OSHA Standard 1910.147; topics in the manual include background, scope, and purpose of the regulation

- This complete package includes:
 - Instructions for writing a company lockout/tagout policy
 - Establishing lockout/tagout procedures for equipment
 - Implementing a lockout/tagout training program
 - Forms, sample programs, and procedures to administer your program



| Part Number | Part Description | Std. Pkg. Qty. |
|-------------|--|----------------|
| PSL-LCM | OSHA lockout/tagout compliance manual. | 1 |

B1.
Cable Ties

B2.
Cable
Accessories

B3.
Stainless
Steel Ties

C1.
Wiring
Duct

C2.
Surface
Raceway

C3.
Abrasion
Protection

C4.
Cable
Management

Lockout/Tagout Regulations Training Video and Handbooks

• “A Life is on the Line” Lockout/Tagout Training Program (English or Spanish) is designed to protect your employees and assist in compliance with OSHA lockout/tagout general requirements quickly, easily, and at low cost

- This complete package includes:
 - Lockout/tagout video
 - Participant guides with quizzes
 - Certificate of completion cards
 - Leader’s guide complete with quiz key
 - Training log
 - Lockout/tagout samples
 - *PANDUIT* lockout/tagout bulletin



| Part Number | Part Description | Number of Guides and Cards Included | Std. Pkg. Qty. | Std. Ctn. Qty. |
|-------------|--|-------------------------------------|----------------|----------------|
| PSL-LTP | Lockout/tagout regulations video complete training program, English, VHS format. | 10 | 1 | — |
| PSL-LTM | Replacement lockout/tagout participant guides and cards, English. | 10 | 1 | 10 |
| PSL-LTPS | Lockout/tagout regulations video complete training program, Spanish, VHS format. | 10 | 1 | — |
| PSL-LTMS | Replacement lockout/tagout participant guides and cards, Spanish. | 10 | 1 | 10 |
| PSL-LTV | Lockout/tagout regulations training video, English, VHS format. | — | 1 | — |
| PSL-LTV-DVD | Lockout/tagout regulations training video, English, DVD format. | — | 1 | 10 |

D1.
Terminals

D2.
Power
Connectors

D3.
Grounding
Connectors

E1.
Labeling
Systems

Group Lockout/Tagout Training Video

• “Your Lock is Your Key to Life” Training Program provides thorough instruction on OSHA recommended safety practices and procedures for group lockout – multi-craft/multi-shift lockout operations

- This complete package includes:
 - Group lockout/tagout video
 - Participant guides with quizzes
 - Certificate of completion cards
 - Leader’s guide complete with quiz key
 - Training log
 - Lockout/tagout samples
 - *PANDUIT* lockout/tagout bulletin
 - Lockout steps wallet cards



| Part Number | Part Description | Number of Guides and Cards Included | Std. Pkg. Qty. | Std. Ctn. Qty. |
|-------------|--|-------------------------------------|----------------|----------------|
| PSL-LTPGP | Group lockout/tagout video complete training program, English, VHS format. | 10 | 1 | 5 |
| PSL-LTMGP | Replacement group lockout/tagout participant guides and cards, English. | 10 | 1 | 10 |

E2.
Labels

E3.
Pre-Printed
& Write-On
Markers

E4.
Permanent
Identification

E5.
Lockout/
Tagout
& Safety
Solutions

F.
Index

Lockout/Tagout Steps/Calendar Wallet Card

- Provides those employees responsible for lockout/tagout with a constant reminder of the OSHA recommended steps for shutdown and startup
- Current calendar year is printed on back side



| Part Number | Part Description | Width | | Height | | Number of Cards Included | Std. Pkg. Qty. | Std. Ctn. Qty. |
|-------------|--|-------|-------|--------|-------|--------------------------|----------------|----------------|
| | | In. | mm | In. | mm | | | |
| PSL-STEPS | Lockout/tagout steps/calendar wallet card. | 2.13 | 54.00 | 3.38 | 86.00 | 25 | 1 | 4 |

Circuit Breaker Lockout Devices

- Individual circuit breakers can be locked in the off position quickly and easily
- Compact, universal design fits a wide range of single, double, and triple handle circuit breakers
- Accommodates breaker handles .30 – .60 inches (7.62mm – 15.24mm) tall and .25 – .44 inches (6.35mm – 11.18mm) thick
- Easily attached with no modifications to panel or circuit breaker and does not require hole in circuit breaker handle
- Constructed of rugged nylon and stainless steel, providing strength, durability, added security and corrosion resistance



| Part Number | Part Description | Std. Pkg. Qty. | Std. Ctn. Qty. |
|-------------|--|----------------|----------------|
| PSL-CB | Universal circuit breaker lockout. | 1 | 10 |
| PSL-CBIL | Circuit breaker lockout device for use with Square D I-LINE^/Federal Pacific (FPE) circuit breakers. | 1 | 10 |

^I-LINE is a registered trademark of Square D Company.

“No Tool” Circuit Breaker Lockout Devices

- Individual circuit breaker can be locked in the off position quickly and easily without any tools
- Compact, universal design fits a wide range of single, double, and triple handle circuit breakers
- Accommodates breaker handle sizes ranging from .30 – .60 inches (7.62mm – 15.24mm) tall and .16 – .35 inches (4.06mm x 8.89mm) thick
- Easily attached with no modifications to panel or circuit breaker and does not require holes in circuit breaker handle
- Constructed of rugged nylon and stainless steel providing strength, durability, added security and corrosion resistance



| Part Number | Part Description | Std. Pkg. Qty. | Std. Ctn. Qty. |
|-------------|---|----------------|----------------|
| PSL-CBNT | “No Tool” universal circuit breaker lockout. | 1 | 10 |
| PSL-CBILNT | “No Tool” circuit breaker lockout for use with Square D I-LINE^/Federal Pacific (FPE) circuit breakers. | 1 | 10 |

^I-LINE is a registered trademark of Square D Company.

A. System Overview

B1. Cable Ties

B2. Cable Accessories

B3. Stainless Steel Ties

C1. Wiring Duct

C2. Surface Raceway

C3. Abrasion Protection

C4. Cable Management

D1. Terminals

D2. Power Connectors

D3. Grounding Connectors

E1. Labeling Systems

E2. Labels

E3. Pre-Printed & Write-On Markers

E4. Permanent Identification

E5. Lockout/Tagout & Safety Solutions

F. Index

A.
System
Overview

Large Handle Circuit Breaker Lockout Device

B1.
Cable Ties

- Individual circuit breakers can be locked in the off position quickly and easily without any tools
- Compact, universal design fits a wide range of large handle circuit breakers

- Easily attached with no modifications to panel or circuit breaker
- Constructed of rugged nylon and stainless steel providing strength, durability, added security and corrosion resistance

B2.
Cable
Accessories

- Accommodates breaker handle dimensions up to .80 inches thick x 3.00 inches wide (20.32mm x 76.20mm)



| Part Number | Part Description | Std. Pkg. Qty. | Std. Ctn. Qty. |
|----------------|---------------------------------------|----------------|----------------|
| PSL-CBL | Large handle circuit breaker lockout. | 1 | 10 |

C1.
Wiring
Duct

C2.
Surface
Raceway

C3.
Abrasion
Protection

Plug Lockout Device

C4.
Cable
Management

- Individual plugs in a wide range of sizes can be locked out to prevent energization
- Accommodates padlocks with shackle lengths of 1.50 inches (38.10mm) or greater and plugs with a hole in a blade

- Constructed of rugged polycarbonate providing strength, durability, added security and corrosion resistance

D1.
Terminals



| Part Number | Part Description | Std. Pkg. Qty. | Std. Ctn. Qty. |
|--------------|------------------|----------------|----------------|
| PSL-P | Plug lockout. | 1 | 10 |

D2.
Power
Connectors

D3.
Grounding
Connectors

E1.
Labeling
Systems

E2.
Labels

Cord Lockout Devices

E3.
Pre-Printed
& Write-On
Markers

- Individual corded plugs in a wide range of sizes can be locked out to prevent energization

- Constructed of rugged polypropylene providing strength, durability, and added security

E4.
Permanent
Identification



| Part Number | Part Description | Std. Pkg. Qty. | Std. Ctn. Qty. |
|------------------|--|----------------|----------------|
| PSL-CL110 | Lockout for 120 VAC corded plugs, 2.00" x 2.00" x 3.50" inside dimensions. | 1 | 10 |
| PSL-CL480 | Lockout for 240 – 480 VAC corded plugs, 3.25" x 3.25" x 6.50" inside dimensions. | 1 | 10 |

E5.
Lockout/
Tagout/
& Safety
Solutions

F.
Index

Receptacle Blockout Device

- Accommodates standard 120 V electrical receptacles
- Blockout receptacles to prevent equipment damage from overloading circuits or electrical interference

- Constructed of high density polyethylene providing strength, durability, and added security



| Part Number | Part Description | Std. Pkg. Qty. | Std. Ctn. Qty. |
|-------------|---|----------------|----------------|
| PSL-ERB | Blockout for 120 V electrical receptacle. | 1 | 25 |

Toggle Switch Lockout Device

- Compact secure design fits most toggle switches and some small circuit breakers
- Easily attached without removal of faceplate or screws

- Accommodates switches .45 – .78 inches (11.43mm – 19.81mm) tall x .25 – .38 inches (6.35mm – 9.65mm) wide x .25 – .40 inches (6.35mm – 10.16mm) thick
- Constructed of rugged nylon and stainless steel providing strength, durability, added security and corrosion resistance



| Part Number | Part Description | Std. Pkg. Qty. | Std. Ctn. Qty. |
|-------------|------------------------|----------------|----------------|
| PSL-WS | Toggle switch lockout. | 1 | 10 |

Toggle/Rocker Switch Lockout Device

- Toggle/rocker switches controlling electrical supply can be locked out
- Accommodates standard wall switch faceplates
- Install using faceplate screws

- Constructed of rugged polypropylene providing strength, durability, and added security



| Part Number | Part Description | Std. Pkg. Qty. | Std. Ctn. Qty. |
|-------------|-------------------------------|----------------|----------------|
| PSL-WS1A | Toggle/rocker switch lockout. | 1 | 10 |

Gate Valve Lockout Devices

- Gate valves regulating hydraulic, pneumatic, and chemical energy can be locked out quickly and easily
- Accommodates valve handles ranging from 1.00 inch (25.40mm) to 13.00 inches (330.20mm) in diameter

- Constructed of rugged polypropylene providing strength, durability, and added security



| Part Number | Part Description | Std. Pkg. Qty. | Std. Ctn. Qty. |
|-------------|---|----------------|----------------|
| PSL-V2A | Gate valve lockout, accommodates 1.00" – 2.50" diameter handle. | 1 | 10 |
| PSL-V6A | Gate valve lockout, accommodates 2.50" – 6.50" diameter handle. | 1 | 10 |
| PSL-V9 | Gate valve lockout, accommodates 6.50" – 10.00" diameter handle. | 1 | 10 |
| PSL-V13 | Gate valve lockout, accommodates 10.00" – 13.00" diameter handle. | 1 | — |

A.
System
Overview

B1.
Cable
Ties

B2.
Cable
Accessories

B3.
Stainless
Steel Ties

C1.
Wiring
Duct

C2.
Surface
Raceway

C3.
Abrasion
Protection

C4.
Cable
Management

D1.
Terminals

D2.
Power
Connectors

D3.
Grounding
Connectors

E1.
Labeling
Systems

E2.
Labels

E3.
Pre-Printed
& Write-On
Markers

E4.
Permanent
Identification

E5.
Lockout/
Tagout
& Safety
Solutions

F.
Index

A. System Overview

Ball Valve Lockout Devices

B1. Cable Ties

- Ball valves regulating hydraulic, pneumatic, and chemical energy can be locked out quickly and easily
- Accommodates valve diameters ranging from .25 inches (6.35mm) to 3.00 inches (76.20mm)
- Constructed of rugged polypropylene providing strength, durability, and added security

B2. Cable Accessories



B3. Stainless Steel Ties

| Part Number | Part Description | Std. Pkg. Qty. | Std. Ctn. Qty. |
|----------------|--|----------------|----------------|
| PSL-BV1 | Ball valve lockout, accommodates .25" – 1.00" valve diameter. | 1 | 10 |
| PSL-BV2 | Ball valve lockout, accommodates 1.25" – 3.00" valve diameter. | 1 | 10 |

C1. Wiring Duct

C2. Surface Raceway

Multiple Lockout Device

C3. Abrasion Protection

- Device can be used alone as a lockout hasp or with provided 0.19 inches (4.8mm) diameter cable to lockout electrical disconnects, gate valves, or large cumbersome devices
- Compact and easy to install
- Constructed of rugged polycarbonate and stainless steel providing strength, durability, added security and corrosion resistance

C4. Cable Management



D1. Terminals

| Part Number | Part Description | Std. Pkg. Qty. | Std. Ctn. Qty. |
|--------------------|---|----------------|----------------|
| PSL-MLD | Multiple lockout device; includes lockout hasp and 6.0' (1.8m) vinyl coated galvanized steel cable with loophole. | 1 | 20 |
| PSL-MLDH-X | Multiple lockout device (hasp only). | 10 | — |
| PSL-MLDC | 6.0' (1.8m) vinyl coated galvanized steel cable with loophole (cable only). | 1 | 5 |
| PSL-MLDC200 | 200.0' (61.0m) vinyl coated galvanized steel cable on roll without loophole (cable only). | 1 | — |

D2. Power Connectors

D3. Grounding Connectors



Lockout single or multiple electrical disconnects



Lockout gate valves



Immobilize large or cumbersome devices, such as forklifts

E1. Labeling Systems

E2. Labels

Pneumatic Energy Lockout Device

E3. Pre-Printed & Write-On Markers

- Pneumatic energy devices can be locked out quickly and easily without costly tool modifications or inconvenient in-line valves
- When installed on the male pneumatic fitting, prevents the ability to engage into the female fitting
- Universal compact design makes the pneumatic lockout device easy to transport and install on almost any fitting, even in tight spaces
- Rugged stainless steel construction offers superior strength, durability, added security and corrosion resistance

E4. Permanent Identification



E5. Lockout/Tagout & Safety Solutions

| Part Number | Part Description | Std. Pkg. Qty. | Std. Ctn. Qty. |
|----------------|--|----------------|----------------|
| PSL-PEL | Pneumatic energy lockout device, 3.50" (88.9mm) diameter x 0.10" (2.54mm) thick. | 1 | 20 |

F. Index



Jack Module Blockout Device

- Blocks unauthorized access to jacks and potentially harmful foreign objects, saving time and money associated with data security breaches, network downtime, repair and hardware replacement
- Compatible with most RJ45 jacks to accommodate a variety of applications and does not interfere with jack contacts

- Can be installed/removed without interfering with adjacent jacks or hardware
- May only be released with the special removal tool, ensuring the safety and security of your network infrastructure



| Part Number | Part Description | Color | Std. Pkg. Qty. | Std. Ctn. Qty. |
|--------------|---|---------------------|----------------|----------------|
| PSL-DCJB* | Package of ten jack module blockout devices and one removal tool. | Red | 1 | 20 |
| PSL-DCJB-BL* | Package of ten jack module blockout devices and one removal tool. | Black | 1 | 20 |
| PSL-DCJB-BU* | Package of ten jack module blockout devices and one removal tool. | Blue | 1 | 20 |
| PSL-DCJB-YL* | Package of ten jack module blockout devices and one removal tool. | Yellow | 1 | 20 |
| PSL-DCJB-IW* | Package of ten jack module blockout devices and one removal tool. | International White | 1 | 20 |
| PSL-DCJB-GR* | Package of ten jack module blockout devices and one removal tool. | Green | 1 | 20 |

*Available in bulk packages of 100 devices and five removal tools. To order bulk package add -C to the suffix of part number.

RJ45 Plug Lockin Device



- Tamper-resistant design blocks unauthorized removal of cable, IP phone, other networking equipment or critical connection

- Deters unauthorized users from moving or stealing VoIP phones helping to maintain E911 service
- Compact design does not interfere with adjacent jacks, even in high-density applications



| Part Number | Part Description | Color | Std. Pkg. Qty. | Std. Ctn. Qty. |
|---------------|---|---------------------|----------------|----------------|
| PSL-DCPL* | Package of ten RJ45 plug lockin devices and one installation/removal tool. | Red | 1 | 20 |
| PSL-DCPL-BL* | Package of ten RJ45 plug lockin devices and one installation/removal tool. | Black | 1 | 20 |
| PSL-DCPL-BU* | Package of ten RJ45 plug lockin devices and one installation/removal tool. | Blue | 1 | 20 |
| PSL-DCPL-YL* | Package of ten RJ45 plug lockin devices and one installation/removal tool. | Yellow | 1 | 20 |
| PSL-DCPL-IW* | Package of ten RJ45 plug lockin devices and one installation/removal tool. | International White | 1 | 20 |
| PSL-DCPL-GR* | Package of ten RJ45 plug lockin devices and one installation/removal tool. | Green | 1 | 20 |
| PSL-DCPLR* | Package of ten recessed RJ45 plug lockin devices and one installation/removal tool. | Red | 1 | 20 |
| PSL-DCPLR-BL* | Package of ten recessed RJ45 plug lockin devices and one installation/removal tool. | Black | 1 | 20 |
| PSL-DCPLR-BU* | Package of ten recessed RJ45 plug lockin devices and one installation/removal tool. | Blue | 1 | 20 |
| PSL-DCPLR-YL* | Package of ten recessed RJ45 plug lockin devices and one installation/removal tool. | Yellow | 1 | 20 |
| PSL-DCPLR-IW* | Package of ten recessed RJ45 plug lockin devices and one installation/removal tool. | International White | 1 | 20 |
| PSL-DCPLR-GR* | Package of ten recessed RJ45 plug lockin devices and one installation/removal tool. | Green | 1 | 20 |

*Available in bulk packages of 100 devices and five removal tools. To order bulk package add -C to the suffix of part number.

A. System Overview

B1. Cable Ties

B2. Cable Accessories

B3. Stainless Steel Ties

C1. Wiring Duct

C2. Surface Raceway

C3. Abrasion Protection

C4. Cable Management

D1. Terminals

D2. Power Connectors

D3. Grounding Connectors

E1. Labeling Systems

E2. Labels

E3. Pre-Printed & Write-On Markers

E4. Permanent Identification

E5. Lockout/Tagout & Safety Solutions

F. Index

A.
System
Overview

Electrician Lockout Kit

- Kit contains a variety of lockout/tagout devices commonly used by an individual electrician

B1.
Cable Ties



B2.
Cable
Accessories

B3.
Stainless
Steel Ties

| Part Number | Contents | Std. Pkg. Qty. | Std. Ctn. Qty. |
|------------------|--|----------------|----------------|
| PSL-PK-EA | (1) Screwdriver. (1) PSL-PK pouch. (1) PSL-3RED-LS long shackle padlock with red label. (1) PSL-MLD multiple lockout device. (1) PSL-WS wall switch lockout device. (1) PSL-CBNT "No Tool" universal circuit breaker lockout device. (1) PSL-P plug lockout device. (5) PVT-30 Electrician's blocking tags. | 1 | 5 |

C1.
Wiring
Duct

Contractor Lockout Kit

- Kit contains a variety of lockout/tagout devices commonly used by electrical contractors

C2.
Surface
Raceway



C3.
Abrasion
Protection

C4.
Cable
Management

| Part Number | Contents | Std. Pkg. Qty. |
|--------------------|--|----------------|
| PSL-KT-CONA | (1) Screwdriver. (1) PSL-KT carrying case – 5.0" x 3.5" x 11.0" (127mm x 89mm x 279mm). (3) PSL-3RED-LS long shackle padlocks with red labels. (3) PSL-3RED standard shackle padlocks with red labels. (1) PSL-1A lockout hasp – 1.0" (25mm) jaw diameter. (1) PSL-MLD multiple lockout device. (3) PSL-WS wall switch lockouts. (3) PSL-CBNT circuit breaker lockouts. (3) PSL-P plug lockouts. (15 Tags) PVT-98 "EQUIPMENT LOCKED OUT BY..." safety tags. | 1 |

D1.
Terminals

MRO Lockout Kit

- Kit contains a variety of lockout/tagout devices commonly used by maintenance and repair personnel

D2.
Power
Connectors



D3.
Grounding
Connectors

E1.
Labeling
Systems

E2.
Labels

E3.
Pre-Printed
& Write-On
Markers

E4.
Permanent
Identification

E5.
Lockout/
Tagout/
& Safety
Solutions

F.
Index

| Part Number | Contents | Std. Pkg. Qty. |
|--------------------|--|----------------|
| PSL-KT-MROA | (1) Screwdriver. (1) PSL-BX carrying case – 6.5" x 5.0" x 14.5" (32mm x 127mm x 368mm). (3) PSL-3RED-LS long shackle padlocks with red labels. (1) PSL-MLD multiple lockout device. (2) PSL-WS wall switch lockouts. (2) PSL-CBNT circuit breaker lockouts. (2) PSL-P plug lockouts. (1) PSL-V6A gate valve lockout – 6.5" (165mm). (1) PSL-V2A gate valve lockout – 2.5" (64mm). (1) PSL-BV2 ball valve lockout – 3.0" (76mm). (1) PSL-CL110 110V plug lockout. (10) PVT-44 "DO NOT OPERATE" maintenance tags. | 1 |

Power and Panel Distribution Lockout Kit

- Kit contains a variety of lockout/tagout devices commonly used to isolate electrical distribution panels
- Durable steel case can be wall mounted or used as a portable case



| Part Number | Contents | Std. Pkg. Qty. |
|-------------------|---|----------------|
| PSL-KT-PWR | (1) Screwdriver. (1) PSL-STATION metal wall mount cabinet. (2) PSL-3-RED-LS long shackle padlocks with red labels. (1) PSL-MLD multiple lockout device. (2) PSL-CBNT universal circuit breaker lockout device. (2) PSL-CBILNT circuit breaker lockout device for Square D I-LINE^/Federal Pacific (FPE) circuit breakers. (2) PSL-CBL large handle circuit breaker lockout devices. (1) PSL-P plug lockout. (25) PVT-23-Q "DO NOT OPERATE ELECTRICIANS AT WORK" tags. | 1 |

Order number required.

^I-LINE is a registered trademark of Square D Company.

Metal Wall Mount Cabinet

- Conveniently store lockout tools and accessories in one common area



- Durable steel case can be wall-mounted (nine mounting holes) or used as a portable case
- 14.75" x 10.25" x 4.63" (375.00mm x 260.00mm x 117.00mm)

| Part Number | Part Description | Std. Pkg. Qty. |
|-------------|---------------------------|----------------|
| PSL-STATION | Metal wall mount cabinet. | 1 |

Lockout Stations

- Conveniently store padlocks, tags, and lockout devices in one common area



| Part Number | Part Description | Width | | Height | | Std. Pkg. Qty. |
|-------------|--|-------|--------|--------|--------|----------------|
| | | In. | mm | In. | mm | |
| PSL-20S | Lockout station only, twenty person. | 24.00 | 610.00 | 19.00 | 483.00 | 1 |
| PSL-20SWC | Lockout station with components, twenty persons. Components include: (20) PSL-3RED padlocks (keyed differently) (6) PSL-1.5 lockout hasps (25 tags) PVT-98 safety tags (25 tags) PVT-41 safety tags | 24.00 | 610.00 | 19.00 | 483.00 | 1 |
| PSL-10S | Lockout station only, ten person. | 12.00 | 305.00 | 19.00 | 483.00 | 1 |
| PSL-10SWC | Lockout station with components, ten person. Components include: (10) PSL-3RED padlocks (keyed differently) (3) PSL-1.5 lockout hasps (15 tags) PVT-98 safety tags (10 tags) PVT-41 safety tags | 12.00 | 305.00 | 19.00 | 483.00 | 1 |
| PSL-4S | Lockout station only, four person. | 12.00 | 305.00 | 9.50 | 241.00 | 1 |
| PSL-4SWC | Lockout station with components, four person. Components include: (4) PSL-3RED padlocks (keyed differently) (3) PSL-1.5 lockout hasps (15 tags) PVT-98 safety tags | 12.00 | 305.00 | 9.50 | 241.00 | 1 |

Group Lock Box

- Manage multiple employees and energy sources involved in a group lockout procedure
- Accommodates up to thirteen padlocks (not included)



- Industrial powder coated steel construction
- Dimensions: 9.00"W x 6"H x 3.25"D (228.60mm x 152.40mm x 82.55mm)

| Part Number | Part Description | Std. Pkg. Qty. |
|-------------|------------------|----------------|
| PSL-GLB | Group lock box. | 1 |

A. System Overview

B1. Cable Ties

B2. Cable Accessories

B3. Stainless Steel Ties

C1. Wiring Duct

C2. Surface Raceway

C3. Abrasion Protection

C4. Cable Management

D1. Terminals

D2. Power Connectors

D3. Grounding Connectors

E1. Labeling Systems

E2. Labels

E3. Pre-Printed & Write-On Markers

E4. Permanent Identification

E5. Lockout/Tagout & Safety Solutions

F. Index

A. System Overview

Warning Label

B1. Cable Ties

- Warning label prohibits tampering with push buttons during repair or service
- Write-on area for adding your own warning message
- Made of vinyl cloth material that allows label to be removed easily after repairs are completed
- Features the international prohibition symbol for “Do Not Throw Switch”

B2. Cable Accessories

B3. Stainless Steel Ties



C1. Wiring Duct

Material Chart

| Material | Print Method | Temperature Range | Features |
|--------------------|--------------|--------------------------------|---|
| Vinyl Cloth, White | Pre-Printed | -50°F to 170°F (-46°C to 77°C) | Indoor/outdoor rated; thin conformable material with repositionable adhesive allows label to be removed and reused or used in temporary applications; provides durability, high temperature resistance, and dimensional stability for rough or textured surfaces. |

C2. Surface Raceway

C3. Abrasion Protection

C4. Cable Management

D1. Terminals

Circuit Breaker Directory Sign

D2. Power Connectors

- Adhesive paper sign designed to provide clear identification of circuit breaker connections, list up to 40 circuits
- Eliminate the guesswork when identifying power sources – a must for lockout/tagout compliance

D3. Grounding Connectors



Material Chart

| Material | Print Method | Temperature Range | Features |
|----------|--------------|--------------------------------|---|
| Paper | Pre-Printed | -65°F to 200°F (-54°C to 93°C) | Indoor rated; general purpose material; excellent adhesion properties when applied to a clean, dry surface. |

E1. Labeling Systems

E2. Labels

E3. Pre-Printed & Write-On Markers

E4. Permanent Identification

E5. Lockout/Tagout & Safety Solutions

F. Index

| Part Number | Part Description | Color (Legend/Background) | Labels Per Pkg. | Width | | Height | | Std. Pkg. Qty. | Std. Ctn. Qty. |
|---------------|---------------------------------|---------------------------|-----------------|-------|--------|--------|--------|----------------|----------------|
| | | | | In. | mm | In. | mm | | |
| PES-S1 | Circuit breaker directory sign. | Red and Black/White | 5 | 13.00 | 330.00 | 5.50 | 140.00 | 1 | 20 |

Can be clearly identified with *PANDUIT* permanent marking pens, page E5.20.

Safety Lockout Padlocks

- Rugged, lightweight XENYO‡ plastic body with steel shackle
- Each lock keyed differently and supplied with one key and padlock labels in English, Spanish, and French
- .25 inches (6.00mm) diameter shackle



| Part Number | Color | Std. Pkg. Qty. |
|-----------------------------------|--------|----------------|
| 1.50" (38.10mm) Short Body | | |
| PSL-4BLK | Black | 6 |
| PSL-4BLU | Blue | 6 |
| PSL-4GRN | Green | 6 |
| PSL-4ORG | Orange | 6 |
| PSL-4PRP | Purple | 6 |
| PSL-4RED | Red | 6 |
| PSL-4TEL | Teal | 6 |
| PSL-4YEL | Yellow | 6 |
| 3.00" (76.20mm) Long Body | | |
| PSL-4BLK-LB | Black | 6 |
| PSL-4BLU-LB | Blue | 6 |
| PSL-4GRN-LB | Green | 6 |
| PSL-4ORG-LB | Orange | 6 |
| PSL-4PRP-LB | Purple | 6 |
| PSL-4RED-LB | Red | 6 |
| PSL-4TEL-LB | Teal | 6 |
| PSL-4YEL-LB | Yellow | 6 |

These locks can be master keyed or keyed alike. These locks can also be custom engraved.
 ‡XENYO is a registered trademark of General Electric Company.
 See Custom Lock Options on page E5.20.

High Security Padlocks

- Aluminum padlock with hardened steel shackles
- Powder coated finish resists scratches
- Ideal for corrosive and tough environments
- 30% lighter than laminated steel
- Each lock keyed differently and supplied with two keys
- .25 inches (6.00mm) diameter shackle



| Part Number | Color | Std. Pkg. Qty. |
|--------------------------------|--------|----------------|
| 1.00" (25.40mm) Shackle | | |
| PSL-11BLK | Black | 6 |
| PSL-11BLU | Blue | 6 |
| PSL-11GRN | Green | 6 |
| PSL-11ORNG | Orange | 6 |
| PSL-11RED | Red | 6 |
| PSL-11YEL | Yellow | 6 |
| 3.00" (76.20mm) Shackle | | |
| PSL-11BLK-LS | Black | 6 |
| PSL-11BLU-LS | Blue | 6 |
| PSL-11GRN-LS | Green | 6 |
| PSL-11ORNG-LS | Orange | 6 |
| PSL-11RED-LS | Red | 6 |
| PSL-11YEL-LS | Yellow | 6 |

These locks can be master keyed or keyed alike and custom engraved.
 See Custom Lock Options on page E5.13.

A.
System
Overview

B1.
Cable Ties

B2.
Cable
Accessories

B3.
Stainless
Steel Ties

C1.
Wiring
Duct

C2.
Surface
Raceway

C3.
Abrasion
Protection

C4.
Cable
Management

D1.
Terminals

D2.
Power
Connectors

D3.
Grounding
Connectors

E1.
Labeling
Systems

E2.
Labels

E3.
Pre-Printed
& Write-On
Markers

E4.
Permanent
Identification

E5.
Lockout/
Tagout
& Safety
Solutions

F.
Index

A.
System
Overview

Laminated Steel Padlocks

B1.
Cable
Ties

- Laminated steel, pin tumbler lock
- Double-locking, case-hardened steel shackle
- Each lock keyed differently and supplied with two keys
- .28 inches (7.00mm) diameter shackle



B2.
Cable
Accessories

B3.
Stainless
Steel
Ties

C1.
Wiring
Duct

C2.
Surface
Raceway

C3.
Abrasion
Protection

C4.
Cable
Management

D1.
Terminals

D2.
Power
Connectors

D3.
Grounding
Connectors

E1.
Labeling
Systems

E2.
Labels

E3.
Pre-Printed
& Write-On
Markers

E4.
Permanent
Identification

E5.
Lockout/
Tagout/
& Safety
Solutions

F.
Index

| Part Number | Color | Std. Pkg. Qty. |
|--------------------------------|--------------------------|----------------|
| .75" (19.00mm) Shackle | | |
| PSL-3BLACK | Lock with black bumper. | 6 |
| PSL-3BLUE | Lock with blue bumper. | 6 |
| PSL-3GREEN | Lock with green bumper. | 6 |
| PSL-3RED | Lock with red bumper. | 6 |
| PSL-3WHITE | Lock with white bumper. | 6 |
| PSL-3YELLOW | Lock with yellow bumper. | 6 |
| 2.00" (51.00mm) Shackle | | |
| PSL-3BLACK-LS | Lock with black bumper. | 6 |
| PSL-3BLUE-LS | Lock with blue bumper. | 6 |
| PSL-3GREEN-LS | Lock with green bumper. | 6 |
| PSL-3RED-LS | Lock with red bumper. | 6 |
| PSL-3WHITE-LS | Lock with white bumper. | 6 |
| PSL-3YELLOW-LS | Lock with yellow bumper. | 6 |

These locks are not suitable for custom engraving.
See Custom Lock Options on page E5.20.

Value Line Padlocks

- Economical padlock has laminated steel body with case hardened, corrosion resistant steel shackle, and double steel ball locking system
- Each lock keyed differently and supplied with two keys and colored padlock label
- All locks have black bumpers and are supplied with color-coded self-laminating padlock labels
- .25 inches (6.00mm) diameter shackle



| Part Number | Color | Std. Pkg. Qty. |
|--------------------------------|-----------------------|----------------|
| .75" (19.00mm) Shackle | | |
| PSL-5BLK | Black padlock label. | 6 |
| PSL-5BLU | Blue padlock label. | 6 |
| PSL-5GRN | Green padlock label. | 6 |
| PSL-5RED | Red padlock label. | 6 |
| PSL-5WHT | White padlock label. | 6 |
| PSL-5YEL | Yellow padlock label. | 6 |
| 2.50" (63.50mm) Shackle | | |
| PSL-5RED-LS | Red padlock label. | 6 |

These locks not suitable for custom engraving and cannot be master keyed or keyed alike.
Labels are designed with blank write-on area for name and department designation and can be clearly identified with PANDUIT permanent marking pens on page E5.20.

Lockout Hasps

- Energy sources can be locked out quickly and easily by more than one worker for group lockout applications
- Heavy duty hasps with tamper-resistant designs to deter vandalism
- Variety of lockout hasp styles and sizes to accommodate a wide range of lockout applications

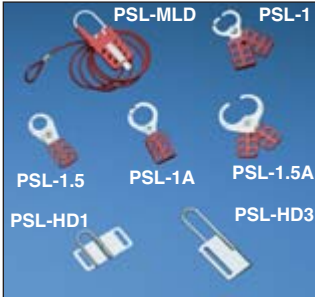

| Part Number | Part Description | Max. No. Locks | Std. Pkg. Qty. | Std. Ctn. Qty. |
|-------------|--|----------------|----------------|----------------|
| PSL-MLD | Multiple lockout device; includes lockout hasp and 6.0' (1.8m) vinyl coated galvanized steel cable with loop-hole. | 6 | 1 | 20 |
| PSL-MLDH-X | Multiple lockout device (hasp only). | 6 | 10 | — |
| PSL-1 | Hasp with 1.00" (25.40mm) diameter jaw and overlapping tabs. | 6 | 12 | 144 |
| PSL-1.5 | Hasp with 1.50" (38.10mm) diameter jaw and overlapping tabs. | 6 | 12 | 144 |
| PSL-1A | Hasp with 1.00" (25.40mm) diameter jaw. | 6 | 12 | 144 |
| PSL-1.5A | Hasp with 1.50" (38.10mm) diameter jaw. | 6 | 12 | 48 |
| PSL-HD1 | Heavy duty hasp with 1.00" x 1.00" (25.40mm x 25.40mm) clearance. | 5 | 12 | — |
| PSL-HD2.4 | Heavy duty hasp with 1.00" x 2.40" (25.40mm x 60.00mm) clearance. | 5 | 12 | — |
| PSL-HD3 | Heavy duty hasp with 1.00" x 3.00" (25.40mm x 76.00mm) clearance. | 7 | 12 | — |

Self-Laminating Padlock Labels

- Used to identify employees' locks; employees sign the label, attach it to the padlock, and overwrap with the clear vinyl to protect the legend
- Available in six colors for departmental coding
- One-piece design is easy to use



| Part Number | Color | Width | | Height | | Std. Pkg. Qty. | Std. Ctn. Qty. |
|-------------|--------|-------|--------|--------|-------|----------------|----------------|
| | | In. | mm | In. | mm | | |
| PSL-PL1BLKY | Black | 10.00 | 254.00 | .75 | 19.00 | 25 | 150 |
| PSL-PL1BLUY | Blue | 10.00 | 254.00 | .75 | 19.00 | 25 | 150 |
| PSL-PL1GRNY | Green | 10.00 | 254.00 | .75 | 19.00 | 25 | 150 |
| PSL-PL1REDY | Red | 10.00 | 254.00 | .75 | 19.00 | 25 | 150 |
| PSL-PL1WHTY | White | 10.00 | 254.00 | .75 | 19.00 | 25 | 150 |
| PSL-PL1YELY | Yellow | 10.00 | 254.00 | .75 | 19.00 | 25 | 150 |

Labels are designed with blank write-on area for name and department designation and can be clearly identified with *PANDUIT* permanent marking pens.

Custom Lock Options

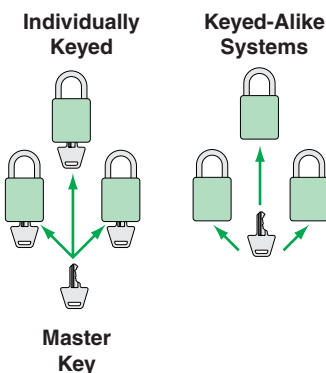

Padlocks are available with the following common lock options:

- Master keyed
- Keyed-alike
- Variety of lock sizes and shackle lengths
- Engraving available on PSL-4 Safety Lockout and PSL-11 High Security Padlocks

Note: Excludes PSL-5 Value Line Padlocks.

A. System Overview

B1. Cable Ties

B2. Cable Accessories

B3. Stainless Steel Ties

C1. Wiring Duct

C2. Surface Raceway

C3. Abrasion Protection

C4. Cable Management

D1. Terminals

D2. Power Connectors

D3. Grounding Connectors

E1. Labeling Systems

E2. Labels

E3. Pre-Printed & Write-On Markers

E4. Permanent Identification

E5. Lockout/Tagout & Safety Solutions

F. Index

A.
System
Overview

Metal I.D. Tags and Collars

B1.
Cable Ties



B2.
Cable
Accessories

B3.
Stainless
Steel Ties

| Part Number | Part Description | Std. Pkg. Qty. | Std. Ctn. Qty. |
|-------------------|---|----------------|----------------|
| PSL-TG1 | Brass padlock identification tag. | 12 | 48 |
| PSL-SC | Padlock shackle collar and rivet. | 12 | 48 |
| MTB1D-Q | Marker tag, 1.00" circular, brass. | 25 | 250 |
| MT172W38-C | Marker tag, one hole, 304 Stainless Steel, rectangle, 1.72" x .38". | 100 | 1000 |

C1.
Wiring
Duct

C2.
Surface
Raceway

Padlock Eyes

C3.
Abrasion
Protection

- Padlock eyes assist with compliance to OSHA standards requiring that equipment be modified to accept locks and lockout devices
- Surface mounted eyes are made of .13 inches (3.00mm) hard wrought steel
- Tamper resistant inside mounting eyes – 2.50 inches W (64.00mm), accept shackle diameters up to .63 inches (16.00mm)

C4.
Cable
Management



D1.
Terminals

D2.
Power
Connectors

D3.
Grounding
Connectors

| Part Number | Part Description | Std. Pkg. Qty. | Std. Ctn. Qty. |
|----------------|---|----------------|----------------|
| PSL-PE1 | Padlock eyes, angled (metal mounting screws included). | 1 | 10 |
| PSL-PE2 | Padlock eyes, straight (wood mounting screws included). | 1 | 10 |

E1.
Labeling
Systems

Chain Attachment

E2.
Labels

- Optional 9.00 inches (229.00mm) chain for permanently attaching lockouts at pre-designed locations

E3.
Pre-Printed
& Write-On
Markers



E4.
Permanent
Identification

E5.
Lockout/
Tagout/
& Safety
Solutions

| Part Number | Part Description | Std. Pkg. Qty. | Std. Ctn. Qty. |
|---------------|--|----------------|----------------|
| PSL-PC | Heavy duty zinc plated steel chain with chain holder attached. | 1 | 10 |

F.
Index

Write-On Safety Tags

- Meet OSHA Standard 1910.147 requirements for tagout applications
- Semi-rigid plastic tags are 3.00"W x 5.75"H (76.00mm x 146.00mm) with a .38" (9.00mm) brass grommet for greater strength and increased durability

- Tags can be attached with a lockout device or with a *PANDUIT* PLT2S nylon tie (50 lb. loop tensile strength) supplied with each tag
- PVT-* Package consists of five tags and five cable ties
- PVT*-Q Package consists of 25 tags and 25 cable ties
- Can be clearly identified with *PANDUIT* permanent marking pens



Material Chart

| Material | Print Method | Temperature Range | Features |
|-------------|--------------|-----------------------------------|---|
| Rigid Vinyl | Pre-Printed | -40°F to 150°F (-40°C to 66°C) | Indoor/outdoor rated; rigid material accepts ink; resistant to UV light, chemical atmosphere, and abrasion; excellent for applications where adhesives will not work. |

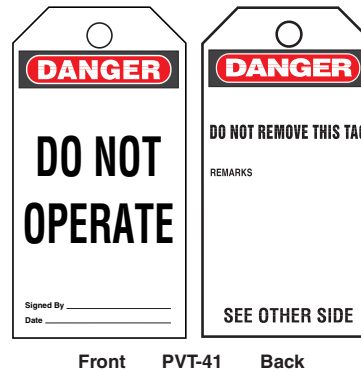
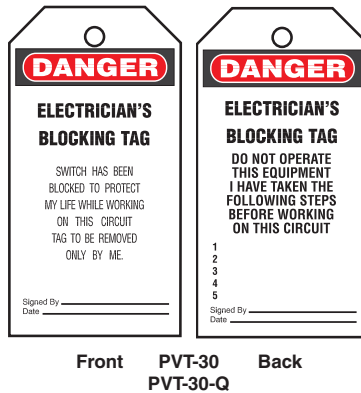
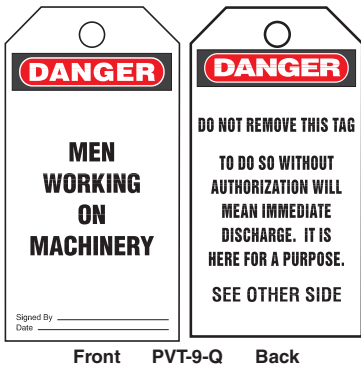

Tags continue on page E5.16.

A. System Overview

B1. Cable Ties

B2. Cable Accessories

B3. Stainless Steel Ties

C1. Wiring Duct

C2. Surface Raceway

C3. Abrasion Protection

C4. Cable Management

D1. Terminals

D2. Power Connectors

D3. Grounding Connectors

E1. Labeling Systems

E2. Labels

E3. Pre-Printed & Write-On Markers

E4. Permanent Identification

E5. Lockout/Tagout & Safety Solutions

F. Index

A. System Overview

Write-On Safety Tags (continued)

B1. Cable Ties

B2. Cable Accessories

B3. Stainless Steel Ties

C1. Wiring Duct

C2. Surface Raceway

C3. Abrasion Protection

C4. Cable Management

D1. Terminals

D2. Power Connectors

D3. Grounding Connectors

E1. Labeling Systems

E2. Labels

E3. Pre-Printed & Write-On Markers

E4. Permanent Identification

E5. Lockout/Tagout & Safety Solutions

F. Index



Front PVT-43 Back



Front PVT-44 Back PVT-44-Q



Front PVT-56-Q Back

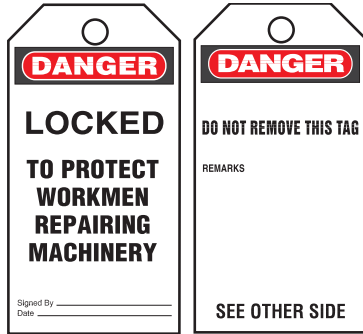

Front PVT-57-Q Back



Front PVT-62-Q Back

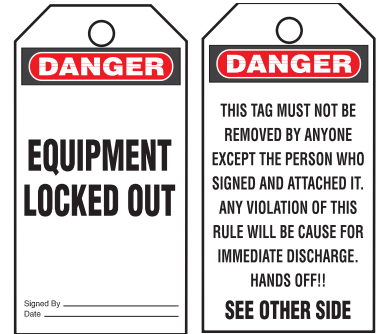

Front PVT-96 Back PVT-96-Q



Front PVT-97 Back PVT-97-Q



Front PVT-98 Back PVT-98-Q



Front PVT-99 Back

Write-On Safety Tags (continued)

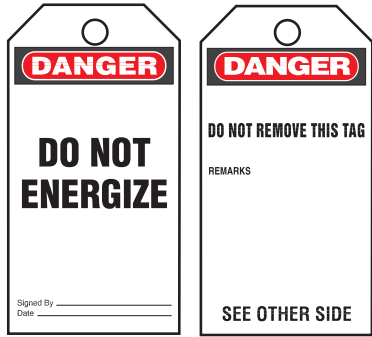

Front PVT-148-Q Back

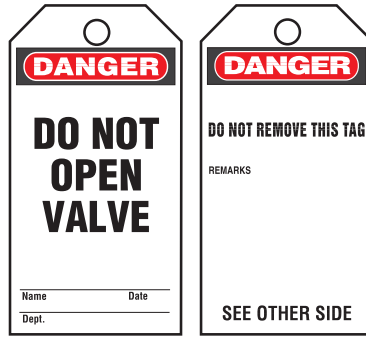

Front PVT-150-Q Back

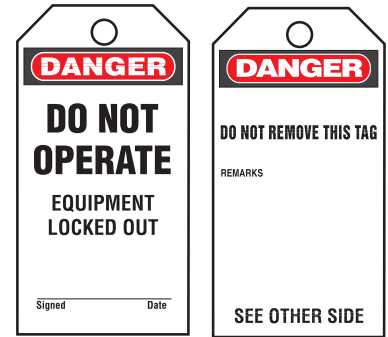

Front PVT-153-Q Back

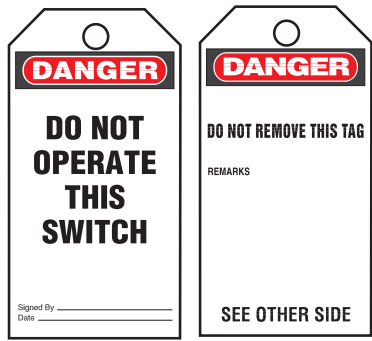

Front PVT-155-Q Back

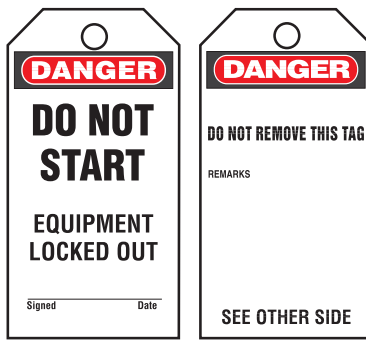

Front PVT-156-Q Back

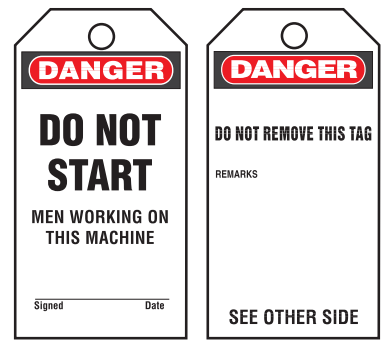

Front PVT-157-Q Back



Front PVT-158-Q Back



Front PVT-160-Q Back

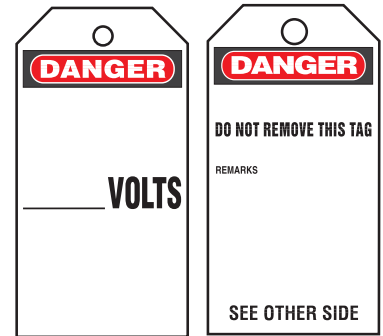

Front PVT-238-Q Back

A. System Overview

B1. Cable Ties

B2. Cable Accessories

B3. Stainless Steel Ties

C1. Wiring Duct

C2. Surface Raceway

C3. Abrasion Protection

C4. Cable Management

D1. Terminals

D2. Power Connectors

D3. Grounding Connectors

E1. Labeling Systems

E2. Labels

E3. Pre-Printed & Write-On Markers

E4. Permanent Identification

E5. Lockout/Tagout & Safety Solutions

F. Index

A.
System
Overview

Bilingual Write-On Safety Tags

B1.
Cable Ties

- Meet OSHA Standard 1910.147 requirements for tagout applications
- Semi-rigid plastic tags are 3.00"W x 5.75"H (76.00mm x 146.00mm) with a .38" (9.00mm) brass grommet for greater strength and increased durability

- Tags can be attached with a lockout device or with a *PANDUIT* PLT2S nylon tie (50 lb. loop tensile strength) supplied with each tag
- Package consists of 25 tags and 25 cable ties
- Can be clearly identified with *PANDUIT* permanent marking pens

B2.
Cable
Accessories

B3.
Stainless
Steel Ties

C1.
Wiring
Duct

C2.
Surface
Raceway



Front PVT-97S-Q Back



Front PVT-161-Q Back



Front PVT-165-Q Back

C3.
Abrasion
Protection

ISO Symbol Safety Tags

C4.
Cable
Management

- Meets International Organization for Standardization (ISO) to communicate safety information
- Semi-rigid plastic tags are 3.00"W x 5.75"H (76.00mm x 146.00mm) with a .38" (9.00mm) brass grommet for greater strength and durability

- Tags have write-on surface and can be attached with a lockout device or with a *PANDUIT* PLT2S nylon tie (50 lb. loop tensile strength) supplied with each tag
- Package consists of five tags and five cable ties
- Can be clearly identified with *PANDUIT* permanent marking pens

D1.
Terminals

D2.
Power
Connectors

D3.
Grounding
Connectors



Front PVT-110 Back
(Do Not Throw Switch)



Front PVT-111 Back
(Prohibition)



Front PVT-112 Back
(Warning of Dangerous
Electrical Voltage)

E1.
Labeling
Systems

E2.
Labels

Do It Yourself Tags

E3.
Pre-Printed
& Write-On
Markers

E4.
Permanent
Identification

E5.
Lockout/
Tagout/
& Safety
Solutions



PVT-94-Q

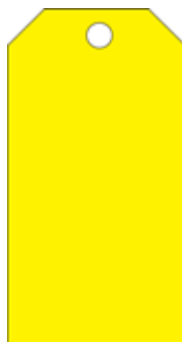

PVT-95-Q



PVT-113-Q



PVT-179-Q



PVT-118-Q

Self-Laminating Photo Tags

- Semi-rigid plastic tags with polyester laminate to protect photos and other written data are 3.00"W x 5.75"H (76.00mm x 146.00mm) with a .38" (9.00mm) brass grommet for greater strength and durability
- Tags have write-on surface and can be attached with a lockout device or with a *PANDUIT* PLT2S nylon tie (50 lb. loop tensile strength) supplied with each tag

- Package consists of five tags and five cable ties
- Can be clearly identified with *PANDUIT* permanent marking pens



Front PST-3 Back

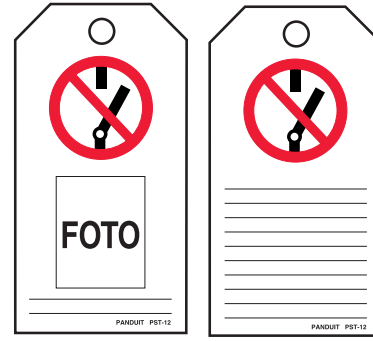

Front PST-12 Back

A. System Overview

B1. Cable Ties

B2. Cable Accessories

B3. Stainless Steel Ties

C1. Wiring Duct

C2. Surface Raceway

C3. Abrasion Protection

C4. Cable Management

D1. Terminals

D2. Power Connectors

D3. Grounding Connectors

E1. Labeling Systems

E2. Labels

E3. Pre-Printed & Write-On Markers

E4. Permanent Identification

E5. Lockout/Tagout & Safety Solutions

F. Index

A. System Overview

Permanent Marking Pens

- Fast drying, permanent ink – legible identification on nylon
- Used with marker ties, write-on labels and tags, where ordinary marking pens will not work



| Part Number | Part Description | Ink Color | Std. Pkg. Qty. | Std. Ctn. Qty. |
|-------------|-----------------------------------|-----------|----------------|----------------|
| PFX-0 | Permanent marking pen – fine tip. | Black | 12 | 144 |
| PFX-2 | Permanent marking pen – fine tip. | Red | 12 | 144 |

B1. Cable Ties

B2. Cable Accessories

B3. Stainless Steel Ties

Lockout/Tagout Safety Signs

Indoor/Outdoor Sub-Surface Printed Adhesive Polyester (Type PPS)

- High quality signs for use indoors and outdoors
- Excellent resistance to UV light, chemical atmosphere, and abrasion
- Excellent life and adhesion properties
- Printed graphics are protected by clear polyester laminate

Indoor/Outdoor Rigid Polyethylene (Type PRS)

- Rugged signs for indoors and outdoors
- Abrasion resistant
- Used where adhesives will not work

Indoor Adhesive Vinyl (Type PVS)

- Economical general purpose signs for use in most environments
- Very good adhesive properties when applied to a clean, dry surface

C1. Wiring Duct

C2. Surface Raceway

C3. Abrasion Protection

C4. Cable Management



D1. Terminals

D2. Power Connectors

Material Chart

| Material | Print Method | Temperature Range | Features |
|--------------------------|--------------|----------------------------------|---|
| Polyester (PPS) | Pre-Printed | -40°F to 275°F (-40°C to 135°C) | Indoor/outdoor rated; laminated label material protects legend from abrasion and chemicals; resistant to UV light, chemical atmosphere, and abrasion; excellent life and adhesion properties. |
| Rigid Polyethylene (PRS) | | -105°F to 250°F (-76°C to 121°C) | Indoor/outdoor rated; high quality, rugged material resistant to abrasion; use where adhesives will not work. |
| Vinyl (PVS) | | -40°F to 200°F (-40°C to 93°C) | Indoor rated; economical general purpose material; excellent adhesion properties when applied to a clean, dry surface. |

D3. Grounding Connectors

Size Reference Chart

| Part Number | Width | | Height | | Signs per Card |
|-------------|-------|--------|--------|--------|----------------|
| | In. | mm | In. | mm | |
| *0109* | 9.00 | 228.60 | 1.50 | 38.10 | 1 |
| *0204* | 4.50 | 114.30 | 2.25 | 57.15 | 2 |
| *0209* | 9.00 | 228.60 | 2.25 | 57.15 | 1 |
| *0305* | 5.00 | 127.00 | 3.50 | 88.90 | 1 |
| *0503* | 3.00 | 76.20 | 5.00 | 127.00 | 2 |
| *0507* | 7.00 | 177.80 | 5.00 | 127.00 | 1 |
| *0509* | 9.00 | 228.60 | 5.00 | 127.00 | 1 |
| *0710* | 10.00 | 254.00 | 7.00 | 177.80 | 1 |
| *1014* | 14.00 | 355.60 | 10.00 | 254.00 | 1 |

*Denotes the part numbers' prefix and suffix.



PPS0204W2100
PPS0305W2100
PPS0507W2100

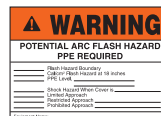

PVS0305W2101^
PVS0507W2101^



PRS1014B364
PVS0509B364Y
PVS0710B364Y
PPS0710B364
PRS0710B364



PPS0710D72
PRS0710D72
PRS1014D72
PVS0109D72Y
PVS0204D72Y
PVS0710D72Y

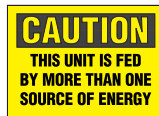

PVS0305C174Y
PVS0505C174Y
PPS0305C174



PVS0710C173Y



PVS0204D100Y



PVS0209D445Y



PVS0204C171Y



PVS0710C180Y

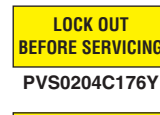

PVS0204C176Y



PVS0204C177Y



PVS0204C179Y



PVS0204W172Y



PVS0204C178Y

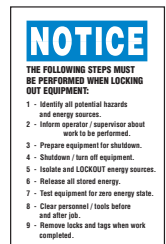

PVS0503N458Y

E1. Labeling Systems

E2. Labels

E3. Pre-Printed & Write-On Markers

E4. Permanent Identification

E5. Lockout/Tagout & Safety Solutions

F. Index

^Can be clearly identified with PANDUIT permanent marking pens.

SAFETY AND FACILITY IDENTIFICATION

PANDUIT offers a full line of safety and facility identification products to ensure employee safety with an effectively identified workplace.



- Safety signs and labels offered in a variety of materials, colors, sizes and legends
- Voltage markers in adhesive and snap-on style
- Utility tapes in a variety of materials, colors, sizes and legends
- Letters and numbers in a variety of materials and sizes
- Tags in a variety of materials, colors, sizes and legends

PANDUIT safety and facility identification products are designed to assist you with creating a safe, compliant, and efficient workplace.

A.
System
Overview

B1.
Cable Ties

B2.
Cable
Accessories

B3.
Stainless
Steel Ties

C1.
Wiring
Duct

C2.
Surface
Raceway

C3.
Abrasion
Protection

C4.
Cable
Management

D1.
Terminals

D2.
Power
Connectors

D3.
Grounding
Connectors

E1.
Labeling
Systems

E2.
Labels

E3.
Pre-Printed
& Write-On
Markers

E4.
Permanent
Identification

E5.
Lockout/
Tagout
& Safety
Solutions

F.
Index

A. System Overview

Electrical Hazard Safety Signs

B1. Cable Ties



B2. Cable Accessories

B3. Stainless Steel Ties

Material Chart

| Material | Print Method | Temperature Range | Features |
|--------------------------|--------------|----------------------------------|---|
| Polyester (PPS) | Pre-Printed | -40°F to 275°F (-40°C to 135°C) | Indoor/outdoor rated; laminated label material protects legend from abrasion and chemicals; resistant to UV light, chemical atmosphere, and abrasion; excellent life and adhesion properties. |
| Rigid Polyethylene (PRS) | | -105°F to 250°F (-76°C to 121°C) | Indoor/outdoor rated; high quality, rugged material resistant to abrasion; use where adhesives will not work. |
| Vinyl (PVS) | | -40°F to 200°F (-40°C to 93°C) | Indoor rated; economical general purpose material; excellent adhesion properties when applied to a clean, dry surface. |

C1. Wiring Duct

Size Reference Chart

| Part Number | Width | | Height | | Signs Per Card |
|-------------|-------|--------|--------|--------|----------------|
| | In. | mm | In. | mm | |
| *0109* | 9.00 | 228.60 | 1.50 | 38.10 | 1 |
| *0204* | 4.50 | 114.30 | 2.25 | 57.15 | 2 |
| *0305* | 5.00 | 127.00 | 3.50 | 88.90 | 1 |
| *0507* | 7.00 | 177.80 | 5.00 | 127.00 | 1 |
| *0509* | 9.00 | 228.60 | 5.00 | 127.00 | 1 |
| *0514* | 14.00 | 355.60 | 5.00 | 127.00 | 1 |
| *0710* | 10.00 | 254.00 | 7.00 | 177.80 | 1 |
| *1007* | 10.00 | 254.00 | 7.00 | 177.80 | 1 |
| *1014* | 14.00 | 355.60 | 10.00 | 254.00 | 1 |
| *1420* | 20.00 | 508.00 | 14.00 | 355.60 | 1 |

*Denotes the part numbers' prefix and suffix.

C2. Surface Raceway

C3. Abrasion Protection

C4. Cable Management

D1. Terminals

D2. Power Connectors

D3. Grounding Connectors

E1. Labeling Systems

E2. Labels

E3. Pre-Printed & Write-On Markers

E4. Permanent Identification

E5. Lockout/Tagout & Safety Solutions

F. Index



PPS0204W2100
PPS0305W2100
PPS0507W2100



PVS0305W2101Y^
PVS0507W2101Y^

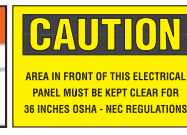

PPS0710C141



PPS0710D28^



PPS0710D66



PRS0710D68



PPS0710D70
PRS1014D70



PRS1014D71



PPS0710D101



PPS0710D72
PRS0710D72
PRS1014D72
PVS0109D72Y
PVS0204D72Y
PVS0710D72Y



PPS0305D73
PPS0710D73
PRS1014D73
PRS1014D73



PPS0305D75
PPS0710D75
PRS1420D75



PPS0710D77



PVS0204D100Y

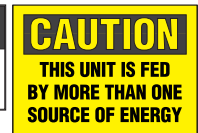

PPS0305C174
PVS0305C174Y
PVS0505C174Y



PPS100D72SE



PPS0710D24



PPS0514B363

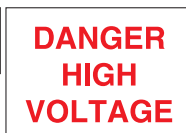

PPS0710B364
PRS0710B364
PRS1014B364
PVS0509B364Y
PVS0710B364Y



PRS1014D79



PRS0910D453



PPS0710N203

^ Can be clearly identified with PANDUIT permanent marking pens.



Short Circuit Warning Signs

- Aids in compliance with UL 508A requirement



PPS0305W2200
PPS0507W2200

Material Chart

| Material | Print Method | Temperature Range | Features |
|-----------------|--------------|---------------------------------|---|
| Polyester (PPS) | Pre-Printed | -40°F to 275°F (-40°C to 135°C) | Indoor/outdoor rated; laminated label material protects legend from abrasion and chemicals; resistant to UV light, chemical atmosphere, and abrasion; excellent life and adhesion properties. |

Size Reference Chart

| Part Number | Width | | Height | | Signs Per Card |
|-------------|-------|--------|--------|--------|----------------|
| | In. | mm | In. | mm | |
| *0305* | 5.00 | 127.00 | 3.00 | 76.20 | 5 |
| *0507* | 7.00 | 177.80 | 5.00 | 127.00 | 5 |
| *0710* | 10.00 | 254.00 | 7.00 | 177.80 | 1 |
| *1014* | 14.00 | 355.60 | 10.00 | 254.00 | 1 |
| *1209* | 9.00 | 228.60 | 12.00 | 304.80 | 1 |

*Denotes the part numbers' prefix and suffix.

Photoluminescent Safety Signs



- Used to mark egress routes, fire alarms, and fire equipment that is clearly visible for up to ten hours after power is lost
- Absorbs energy from ambient light and releases this energy in the form of a glow when power is lost
- *PANDUIT* Photoluminescent Signs meet or exceed the following safety standard specification for photoluminescent safety markings including: ASTM E 2072-00, ASTM E 2073-00, ASTM E 2030-99, DIN67510-1, IMO Resolution A.752.18, ISO/CD 15370, DIN 67510, UL 924, ASTM 162, ASTM 648, ASTM 662, MIL-L-3891 B,



PPS0710G001
PPS1014G002



PPS0710G020



PPS1209G010



PPS1209G011



PPS1209G012

Electrical Symbols on Cards

Material Chart

| Material | Print Method | Temperature Range | Features |
|-------------|--------------|--------------------------------|--|
| Vinyl Cloth | Pre-Printed | -50°F to 170°F (-46°C to 77°C) | Indoor/outdoor rated; conformable material with repositionable adhesive allows label to be removed and reused or used in temporary applications; provides durability, high temperature resistance, and dimensional stability for rough or textured surfaces. |

| Part Number | Symbol | Description | Marker Size | | Markers Per Card | Std. Pkg. Card(s) | Std. Ctn. Card(s) |
|-------------|--------|---|-------------|---------------|------------------|-------------------|-------------------|
| | | | In. | mm | | | |
| PESC-H-AT | | WARNING OF DANGEROUS ELECTRICAL VOLTAGE | .51 x .51 | 13.00 x 13.00 | 68 | 10 | 100 |
| PESC-J-AT | | | .75 x .75 | 19.00 x 19.00 | 36 | 10 | 100 |
| PESC-H-E | | EARTH (GROUND) | .51 x .51 | 13.00 x 13.00 | 68 | 10 | 200 |
| PESC-J-E | | | .75 x .75 | 19.00 x 19.00 | 36 | 10 | 100 |
| PESC-H-EC | | SAFETY FUNCTION | .51 x .51 | 13.00 x 13.00 | 68 | 10 | 200 |
| PESC-J-EC | | | .75 x .75 | 19.00 x 19.00 | 36 | 10 | 100 |
| PESC-H-HT | | STATIC SENSITIVE DEVICE - HANDLING PRECAUTIONS REQUIRED | .51 x .51 | 13.00 x 13.00 | 68 | 10 | 100 |
| PESC-J-HT | | | .75 x .75 | 19.00 x 19.00 | 36 | 10 | 100 |
| PESC-H-PE | | PROTECTIVE CONDUCTOR | .51 x .51 | 13.00 x 13.00 | 68 | 10 | 100 |
| PESC-J-PE | | | .75 x .75 | 19.00 x 19.00 | 36 | 10 | 100 |

Order number of cards required.

Order number of pieces required, in multiples of Standard Package Quantity.

Prime items appear in **BOLD**.

- A. System Overview
- B1. Cable Ties
- B2. Cable Accessories
- B3. Stainless Steel Ties
- C1. Wiring Duct
- C2. Surface Raceway
- C3. Abrasion Protection
- C4. Cable Management
- D1. Terminals
- D2. Power Connectors
- D3. Grounding Connectors
- E1. Labeling Systems
- E2. Labels
- E3. Pre-Printed & Write-On Markers
- E4. Permanent Identification
- E5. Lockout/Tagout & Safety Solutions
- F. Index

A.
System
Overview

Conductor Identification Labels

B1.
Cable Ties

Material Chart

| Material | Print Method | Temperature Range | Features |
|-----------|--------------|------------------------------------|--|
| Polyester | Pre-Printed | -40°F to 250°F (-40°C to 121°C) | Indoor/outdoor rated; laminated label material protects legend from abrasion and chemicals; resistant to UV light, chemical atmosphere, and abrasion; excellent life and adhesion properties |

B2.
Cable
Accessories

B3.
Stainless
Steel Ties

C1.
Wiring
Duct

C2.
Surface
Raceway

C3.
Abrasion
Protection

C4.
Cable
Management

D1.
Terminals

D2.
Power
Connectors

D3.
Grounding
Connectors

E1.
Labeling
Systems











E2.
Labels

E3.
Pre-Printed
& Write-On
Markers

E4.
Permanent
Identification

E5.
Lockout/
Tagout
& Safety
Solutions

F.
Index

| Part Number | Symbol | Legend | Marker Diameter | | Labels Per Sheet | Std. Pkg. Sheet(s) | Std. Ctn. Sheet(s) |
|--------------------|---|---------------------------|-----------------|-------|------------------|--------------------|--------------------|
| | | | In. | mm | | | |
| PESS-A-CE |  | CE SYMBOL | .49 | 12.50 | 20 | 10 | 100 |
| PESS-B-CE | | | .63 | 16.00 | 20 | 10 | 100 |
| PESS-C-CE | | | .79 | 20.00 | 10 | 10 | 100 |
| PESS-D-CE | | | .98 | 25.00 | 10 | 10 | 100 |
| PESS-E-CE | | | 1.24 | 31.50 | 10 | 10 | 100 |
| PESS-A-ES |  | EARTH (GROUND) | .49 | 12.50 | 20 | 10 | 100 |
| PESS-B-ES | | | .63 | 16.00 | 20 | 10 | 100 |
| PESS-C-ES | | | .79 | 20.00 | 10 | 10 | 100 |
| PESS-D-ES | | | .98 | 25.00 | 10 | 10 | 100 |
| PESS-E-ES | | | 1.24 | 31.50 | 10 | 10 | 100 |
| PESS-A-L1 |  | OUTER CONDUCTOR – L1 | .49 | 12.50 | 20 | 10 | 100 |
| PESS-B-L1 | | | .63 | 16.00 | 20 | 10 | 100 |
| PESS-C-L1 | | | .79 | 20.00 | 10 | 10 | 100 |
| PESS-D-L1 | | | .98 | 25.00 | 10 | 10 | 100 |
| PESS-E-L1 | | | 1.24 | 31.50 | 10 | 10 | 100 |
| PESS-A-L2 |  | OUTER CONDUCTOR 2 – L2 | .49 | 12.50 | 20 | 10 | 100 |
| PESS-B-L2 | | | .63 | 16.00 | 20 | 10 | 100 |
| PESS-C-L2 | | | .79 | 20.00 | 10 | 10 | 100 |
| PESS-D-L2 | | | .98 | 25.00 | 10 | 10 | 100 |
| PESS-E-L2 | | | 1.24 | 31.50 | 10 | 10 | 100 |
| PESS-A-L3 |  | OUTER CONDUCTOR 3 – L3 | .49 | 12.50 | 20 | 10 | 100 |
| PESS-B-L3 | | | .63 | 16.00 | 20 | 10 | 100 |
| PESS-C-L3 | | | .79 | 20.00 | 10 | 10 | 100 |
| PESS-D-L3 | | | .98 | 25.00 | 10 | 10 | 100 |
| PESS-E-L3 | | | 1.24 | 31.50 | 10 | 10 | 100 |
| PESS-A-LF |  | LEAD FREE SYMBOL | .49 | 12.50 | 20 | 10 | 100 |
| PESS-A-N |  | NEUTRAL CONDUCTOR – N | .49 | 12.50 | 20 | 10 | 100 |
| PESS-B-N | | | .63 | 16.00 | 20 | 10 | 100 |
| PESS-C-N | | | .79 | 20.00 | 10 | 10 | 100 |
| PESS-D-N | | | .98 | 25.00 | 10 | 10 | 100 |
| PESS-A-PE |  | PROTECTIVE CONDUCTOR – PE | .49 | 12.50 | 20 | 10 | 100 |
| PESS-A-ROHS |  | RoHS WHEELED BIN SYMBOL | .49 | 12.50 | 20 | 10 | 100 |
| PESS-A-SS |  | SAFETY FUNCTION | .49 | 12.50 | 20 | 10 | 100 |
| PESS-B-SS | | | .63 | 16.00 | 20 | 10 | 100 |
| PESS-C-SS | | | .79 | 20.00 | 10 | 10 | 100 |
| PESS-D-SS | | | .98 | 25.00 | 10 | 10 | 100 |

Order number of cards required.





ISO Warning Symbols

Material Chart







| Material | Print Method | Temperature Range | Features |
|--|--------------|--------------------------------|---|
| Paper (WL1, WL3) | Pre-Printed | -65°F to 200°F (-54°C to 80°C) | Indoor rated; general purpose and material; excellent adhesion properties when applied to a clean, dry surface. |
| Polyester (WL25) | | -40°F to 250°F (-54°C to 93°C) | Indoor/outdoor rated; laminated label material protects legend from abrasion and chemicals; resistant to UV light, chemical atmosphere, and abrasion; excellent life and adhesion properties. |
| Vinyl (PESW, WL32Y, WL33Y, WL35Y, WL36Y) | | -40°F to 176°F (-40°C to 80°C) | Indoor/outdoor rated; laminated label material protects legend from abrasion and chemicals; resistant to UV light, chemical atmosphere, and abrasion; excellent life and adhesion properties. |

| Part Number | Symbol | Description | Triangle Width | | Markers Per Card/Pkg | Std. Pkg. Card(s) | Std. Ctn. Card(s) |
|-------------|--------|-------------|----------------|----|----------------------|-------------------|-------------------|
| | | | In. | mm | | | |

Cards

| | | | | | | | |
|------------|---|---|------|--------|----|----|-----|
| PESW-A-1Y |  | CAUTION – RISK OF ELECTRIC SHOCK | .50 | 13.00 | 10 | 10 | 200 |
| PESW-B-1Y | | | 1.00 | 25.40 | 10 | 10 | 200 |
| PESW-C-1Y | | | 1.97 | 50.00 | 10 | 10 | 200 |
| PESW-D-1Y | | | 3.90 | 99.06 | 3 | 10 | 200 |
| PESW-E-1Y | | | 7.90 | 200.66 | 1 | 10 | 200 |
| PESW-A-6Y |  | CAUTION – RISK OF IONIZING RADIATION | .50 | 13.00 | 10 | 10 | 100 |
| PESW-B-6Y | | | 1.00 | 25.40 | 10 | 10 | 100 |
| PESW-C-6Y | | | 1.97 | 50.00 | 10 | 10 | 100 |
| PESW-D-6Y | | | 3.90 | 99.06 | 3 | 10 | 100 |
| PESW-E-6Y | | | 7.90 | 200.66 | 1 | 10 | 100 |
| PESW-A-8Y |  | CAUTION – LASER BEAM | .50 | 13.00 | 10 | 10 | 200 |
| PESW-B-8Y | | | 1.00 | 25.40 | 10 | 10 | 200 |
| PESW-C-8Y | | | 1.97 | 50.00 | 10 | 10 | 100 |
| PESW-D-8Y | | | 3.90 | 99.06 | 3 | 10 | 100 |
| PESW-E-8Y | | | 7.90 | 200.66 | 1 | 10 | 100 |
| PESW-A-9Y |  | CAUTION – GENERAL WARNING, RISK OF DANGER | .50 | 13.00 | 10 | 10 | 200 |
| PESW-B-9Y | | | 1.00 | 25.40 | 10 | 10 | 200 |
| PESW-C-9Y | | | 1.97 | 50.00 | 10 | 10 | 100 |
| PESW-D-9Y | | | 3.90 | 99.06 | 3 | 10 | 100 |
| PESW-E-9Y | | | 7.90 | 200.66 | 1 | 10 | 100 |
| PESW-A-11Y |  | WARNING OF STATIC SENSITIVE DEVICE | .50 | 13.00 | 10 | 10 | 100 |
| PESW-B-11Y | | | 1.00 | 25.40 | 10 | 10 | 100 |
| PESW-C-11Y | | | 1.97 | 50.00 | 10 | 10 | 100 |
| PESW-D-11Y | | | 3.90 | 99.06 | 3 | 10 | 100 |
| PESW-E-11Y | | | 7.90 | 200.66 | 1 | 10 | 100 |

Rolls

| | | | | | | | |
|-------|---|----------------------------------|------|--------|-----|---|----|
| WL1 |  | STATIC AWARENESS WARNING | 2.00 | 50.80 | 500 | 1 | 10 |
| WL3 |  | | 2.00 | 50.80 | 500 | 1 | 10 |
| WL25 |  | WARNING ACCESS TO THIS PANEL ... | 3.50 | 88.90 | 50 | 1 | 10 |
| WL32Y |  | RISK OF ELECTRIC SHOCK SYMBOL | 1.50 | 38.10 | 50 | 1 | 10 |
| WL33Y |  | | 4.50 | 114.30 | 50 | 1 | 10 |
| WL35Y |  | CAUTION – HOT SURFACE WARNING | 2.00 | 50.80 | 50 | 1 | 10 |
| WL36Y |  | WARNING – HOT SURFACE WARNING | 2.00 | 50.80 | 50 | 1 | 10 |

A. System Overview

Electrical Labels in Dispenser



Material Chart

| Material | Print Method | Temperature Range | Features |
|-----------|--------------|--------------------------------|---|
| Polyester | Pre-Printed | -40°F to 250°F (-40° to 121°C) | Indoor/outdoor rated; laminated label material protects legend from abrasion and chemicals; resistant to UV light chemical atmosphere and abrasion; excellent life and adhesion properties. |

B1. Cable Ties

B2. Cable Accessories

B3. Stainless Steel Ties

| Part Number | Symbol | Description | Width | | Height | | Labels Per Pkg. | Std. Pkg. Dispenser(s) | Std. Ctn. Dispenser(s) |
|-------------|--------|-------------|-------|----|--------|----|-----------------|------------------------|------------------------|
| | | | In. | mm | In. | mm | | | |

Dispensers

| | | | | | | | | | | |
|---------------------------------------|---------------------|--|--|------|-------|------|-------|-----|---|----|
| C1. Wiring Duct | PLD-12 [^] | | CIRCUIT NO., LOCATION | 1.50 | 38.10 | 1.00 | 25.40 | 200 | 1 | 10 |
| C2. Surface Raceway | PLD-30 [^] | | CAUTION | 1.50 | 38.10 | 1.00 | 25.40 | 200 | 1 | 10 |
| | PLD-36 | | CAUTION 120 V | 1.50 | 38.10 | 1.00 | 25.40 | 200 | 1 | 10 |
| C3. Abrasion Protection | PLD-37 | | CAUTION 220 V | 1.50 | 38.10 | 1.00 | 25.40 | 200 | 1 | 10 |
| | PLD-38 | | CAUTION 240 V | 1.50 | 38.10 | 1.00 | 25.40 | 200 | 1 | 10 |
| | PLD-43 [^] | | DANGER HIGH VOLTAGE | 1.50 | 38.10 | 1.00 | 25.40 | 200 | 1 | 10 |
| C4. Cable Management | PLD-45 | | CAUTION 230 V | 1.50 | 38.10 | 1.00 | 25.40 | 200 | 1 | 10 |
| | PLD-46 | | CAUTION 277 V | 1.50 | 38.10 | 1.00 | 25.40 | 200 | 1 | 10 |
| | PLD-47 | | CAUTION 277/480 V | 1.50 | 38.10 | 1.00 | 25.40 | 200 | 1 | 10 |
| | PLD-52 | | ATTENTION SYMBOL (ISO 3864) | 1.50 | 38.10 | 1.00 | 25.40 | 200 | 1 | 10 |
| D1. Terminals | PLD-56 | | HIGH VOLTAGE SYMBOL (ISO 3864) | 1.50 | 38.10 | 1.00 | 25.40 | 200 | 1 | 10 |
| D2. Power Connectors | PLD-57 | | GROUND SYMBOL (ISO 3864) | .75 | 19.10 | .75 | 19.10 | 300 | 1 | 10 |
| | PLD-58 | | STATIC AWARENESS WARNING | 1.50 | 38.10 | 1.00 | 25.40 | 200 | 1 | 10 |
| D3. Grounding Connectors | PLD-60 | | STATIC AWARENESS WARNING | 3.00 | 76.20 | 1.00 | 25.40 | 100 | 1 | 10 |
| | PLD-67 | | DANGER HIGH VOLTAGE | 1.50 | 38.10 | 1.00 | 25.40 | 200 | 1 | 10 |
| E1. Labeling Systems | PLD-68 [^] | | LOCKOUT BY _____ DATE _____ | 1.50 | 38.10 | 1.00 | 25.40 | 200 | 1 | 10 |
| E2. Labels | PLD-71 | | WARNING - FOR CONTINUED PROTECTION ... | 2.00 | 50.80 | 1.00 | 25.40 | 150 | 1 | 10 |
| | PLD-72 | | CAUTION LOCK OUT FOR SAFETY BEFORE ... | 1.50 | 38.10 | 1.00 | 25.40 | 200 | 1 | 10 |
| E3. Pre-Printed & Write-On Markers | PLD-74 | | CAUTION HAZARD OF ELECTRIC SHOCK ... | 1.50 | 38.10 | 1.00 | 25.40 | 200 | 1 | 10 |
| E4. Permanent Identification | PLD-80 | | INTRINSICALLY SAFE WIRING | 1.00 | 25.40 | 1.50 | 38.10 | 200 | 1 | 10 |
| | PLD-81 | | SERVICE DISCONNECT | 1.50 | 38.10 | 1.00 | 25.40 | 200 | 1 | 10 |
| E5. Lockout/Tagout & Safety Solutions | PLD-91 | | CAUTION 480 V | 1.50 | 38.10 | 1.00 | 25.40 | 200 | 1 | 10 |

F. Index







Order number of dispensers required in multiples of Std. Pkg.
[^]Can be clearly identified with PANDUIT permanent marking pens.

Write-On Labels on Cards



Material Chart

| Material | Print Method | Temperature Range | Features |
|-------------|--------------|-----------------------------------|--|
| Vinyl Cloth | Pre-Printed | -50°F to 170°F (-46°C to 77°C) | Indoor/outdoor rated; conformable material with repositionable adhesive allows label to be removed and reused or used in temporary applications; provides durability, high temperature resistance, and dimensional stability for rough or textured surfaces. |

| Part Number | Symbol | Description | Width | | Height | | Markers Per Card | Std. Pkg. Card(s) | Std. Ctn. Card(s) |
|-------------|---|-------------|-------|-------|--------|-------|------------------|-------------------|-------------------|
| | | | In. | mm | In. | mm | | | |
| PCWL-BL |  | BLANK | | | | | | 25 | 100 |
| PCWL-ACC |  | ACCEPTED | | | | | | 25 | 100 |
| PCWL-CAL |  | CALIBRATION | | | | | | 25 | 100 |
| PCWL-CALD |  | CALIBRATED | 1.50 | 38.10 | .63 | 15.90 | 14 | 25 | 100 |
| PCWL-ICAL |  | CALIBRATION | | | | | | 25 | 100 |
| PCWL-REJ |  | REJECTED | | | | | | 25 | 100 |

Order number of cards required.
Can be clearly identified with *PANDUIT* permanent marking pens.

A.
System
Overview

B1.
Cable Ties

B2.
Cable
Accessories

B3.
Stainless
Steel Ties

C1.
Wiring
Duct

C2.
Surface
Raceway

C3.
Abrasion
Protection

C4.
Cable
Management

D1.
Terminals

D2.
Power
Connectors

D3.
Grounding
Connectors

E1.
Labeling
Systems

E2.
Labels

E3.
Pre-Printed
& Write-On
Markers

E4.
Permanent
Identification

E5.
Lockout/
Tagout/
& Safety
Solutions

F.
Index

A.
System
Overview

Write-On Quality Labels in Dispenser

B1.
Cable Ties

B2.
Cable
Accessories

B3.
Stainless
Steel Ties



Material Chart

| Material | Print Method | Temperature Range | Features |
|-----------|--------------|-----------------------------------|---|
| Polyester | Pre-Printed | -40°F to 250°F (-40° to 121°C) | Indoor/outdoor rated; laminated label material protects legend from abrasion and chemicals; resistant to UV light, chemical atmosphere, and abrasion; excellent life and adhesion properties. |

C1.
Wiring
Duct

C2.
Surface
Raceway

C3.
Abrasion
Protection

C4.
Cable
Management

D1.
Terminals

D2.
Power
Connectors

D3.
Grounding
Connectors

E1.
Labeling
Systems

E2.
Labels

E3.
Pre-Printed
& Write-On
Markers

E4.
Permanent
Identification

E5.
Lockout/
Tagout/
& Safety
Solutions

F.
Index

| Part Number | Symbol | Legend | Width | | Height | | Labels Per Dispenser | Std. Pkg. Dispenser(s) | Std. Ctn. Dispenser(s) |
|-------------|--------|----------------------------|-------|-------|--------|-------|----------------------|------------------------|------------------------|
| | | | In. | mm | In. | mm | | | |
| PLD-17 | | BLANK | 1.50 | 38.10 | 1.00 | 25.40 | 200 | 1 | 10 |
| PLD-18 | | BLANK | | | | | | 1 | 10 |
| PLD-3 | | CALIBRATION, BY, DATE, DUE | | | | | | 1 | 10 |
| PLD-4 | | ACCEPTED, BY, DATE | | | | | | 1 | 10 |
| PLD-7 | | TESTED, DATE, BY | | | | | | 1 | 10 |
| PLD-11 | | DO NOT USE AFTER | | | | | | 1 | 10 |
| PLD-22 | | CALIBRATION, BY, DATE, DUE | | | | | | 1 | 10 |
| PLD-28 | | INSPECTED, DATE, INITIALS | | | | | | 1 | 10 |
| PLD-29 | | MAINTENANCE, BY, DATE | | | | | | 1 | 10 |

Order number of dispensers required in multiples of Std. Pkg.
Can be clearly identified with *PANDUIT* permanent marking pens.

Inspection Plates

Material Chart

| Material | Print Method | Temperature Range | Features |
|--------------------|--------------|------------------------------------|---|
| Destructible Vinyl | Pre-Printed | -50°F to 225°F (-46°C to 107°C) | Indoor/outdoor rated; label will destruct upon removal; for permanent and tamper resistant labeling applications. |

| Part Number | Symbol | Year | Marker Diameter | | Markers Per Card | Std. Pkg. Card(s) | Std. Ctn. Card(s) |
|-------------|--------|------|-----------------|-------|------------------|-------------------|-------------------|
| | | | In. | mm | | | |
| PEIP-A-08Y | | 08 | .59 | 15.00 | 10 | 10 | 100 |
| PEIP-A-09Y | | 09 | .59 | 15.00 | 10 | 10 | 100 |
| PEIP-A-10Y | | 10 | .59 | 15.00 | 10 | 10 | 100 |
| PEIP-A-11Y | | 11 | .59 | 15.00 | 10 | 10 | 100 |
| PEIP-D-08Y | | 2008 | 1.38 | 35.00 | 5 | 10 | 100 |
| PEIP-D-09Y | | 2009 | 1.38 | 35.00 | 5 | 10 | 100 |
| PEIP-D-10Y | | 2010 | 1.38 | 35.00 | 5 | 10 | 100 |
| PEIP-D-11Y | | 2011 | 1.38 | 35.00 | 5 | 10 | 100 |

Inspection Arrows

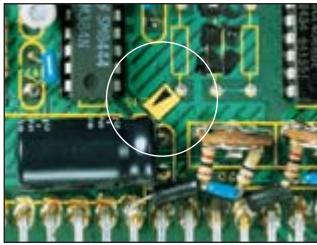

Material Chart

| Material | Print Method | Temperature Range | Features |
|-------------|--------------|-----------------------------------|--|
| Vinyl Cloth | Pre-Printed | -50°F to 170°F (-46°C to 77°C) | Indoor/outdoor rated; conformable material with repositionable adhesive allows label to be removed and reused or used in temporary applications; provides durability, high temperature resistance, and dimensional stability for rough or textured surfaces. |

| Part Number | Symbol | Width | | Height | | Markers Per Card | Std. Pkg. Card(s) | Std. Pkg. Card(s) |
|-------------|--------|-------|------|--------|------|------------------|-------------------|-------------------|
| | | In. | mm | In. | mm | | | |
| PARW125-RED | | .13 | 3.00 | .19 | 5.00 | 576 | 25 | — |
| PARW125-YEL | | .13 | 3.00 | .19 | 5.00 | 576 | 25 | 100 |

A.
System
Overview

B1.
Cable
Ties

B2.
Cable
Accessories

B3.
Stainless
Steel Ties

C1.
Wiring
Duct

C2.
Surface
Raceway

C3.
Abrasion
Protection

C4.
Cable
Management

D1.
Terminals

D2.
Power
Connectors

D3.
Grounding
Connectors

E1.
Labeling
Systems

E2.
Labels

E3.
Pre-Printed
& Write-On
Markers

E4.
Permanent
Identification

E5.
Lockout/
Tagout
& Safety
Solutions

F.
Index

A. System Overview

Voltage and Fiber Optic Markers

B1. Cable Ties



B2. Cable Accessories

B3. Stainless Steel Ties

C1. Wiring Duct

C2. Surface Raceway

C3. Abrasion Protection

C4. Cable Management

D1. Terminals

D2. Power Connectors

D3. Grounding Connectors

E1. Labeling Systems

E2. Labels

E3. Pre-Printed & Write-On Markers

E4. Permanent Identification

E5. Lockout/Tagout & Safety Solutions

F. Index

| Style | Width | | Length | | Pipe/Conduit O.D. Range | | Markers Per Card |
|-------|-------|--------|--------|-------|-------------------------|-----------------|------------------|
| | In. | mm | In. | mm | In. | mm | |
| A | 9.00 | 228.00 | 2.25 | 57.10 | 3.00 and Over | 76.20 and Over | 1 |
| B | 4.50 | 114.30 | 1.13 | 28.60 | 1.25 – 3.00 | 31.70 – 76.20 | 4 |
| C | 2.20 | 57.10 | .50 | 12.70 | 1.25 – Under | 31.70 and Under | 18 |

Material Chart

| Material | Print Method | Temperature Range | Features |
|-----------|--------------|--------------------------------|--|
| Polyester | Pre-Printed | -40°F to 275F (-40°C to 135°C) | Indoor/outdoor rated; pre-coiled material protects legend from abrasion and chemicals; resistant to UV light, chemical atmosphere, and abrasion. |

| Part Number | | | Legend | Color (Legend/Background) | Std. Pkg. Qty. | Std. Ctn. Qty. |
|---------------|---------------|---------------|-------------------|---------------------------|----------------|----------------|
| Style A | Style B | Style C | | | | |
| PCV-110AY | PCV-110BY | PCV-110CY | 110 Volts | Black/Orange | 5 | 50 |
| PCV-115AY | PCV-115BY | PCV-115CY | 115 Volts | | | |
| PCV-120/208AY | PCV-120/208BY | PCV-120/208CY | 120/208 Volts | | | |
| PCV-120AY | PCV-120BY | PCV-120CY | 120 Volts | | | |
| PCV-12470AY | PCV-12470BY | PCV-12470CY | 12470 Volts | | | |
| PCV-13200AY | PCV-13200BY | PCV-13200CY | 13200 Volts | | | |
| PCV-13800AY | PCV-13800BY | PCV-13800CY | 13800 Volts | | | |
| PCV-1PHAY | PCV-1PHBY | PCV-1PHCY | Single Phase | | | |
| PCV-208AY | PCV-208BY | PCV-208CY | 208 Volts | | | |
| PCV-220AY | PCV-220BY | PCV-220CY | 220 Volts | | | |
| PCV-2300AY | PCV-2300BY | PCV-2300CY | 2300 Volts | | | |
| PCV-230AY | PCV-230BY | PCV-230CY | 230 Volts | | | |
| PCV-2400AY | PCV-2400BY | PCV-2400CY | 2400 Volts | | | |
| PCV-240AY | PCV-240BY | PCV-240CY | 240 Volts | | | |
| PCV-277/480AY | PCV-277/480BY | PCV-277/480CY | 277/480 Volts | | | |
| PCV-277AY | PCV-277BY | PCV-277CY | 277 Volts | | | |
| PCV-380AY | PCV-380BY | PCV-380CY | 380 Volts | | | |
| PCV-3PHAY | PCV-3PHBY | PCV-3PHCY | Three Phase | | | |
| PCV-415AY | PCV-415BY | PCV-415CY | 415 Volts | | | |
| PCV-4160AY | PCV-4160BY | PCV-4160CY | 4160 Volts | | | |
| PCV-440AY | PCV-440BY | PCV-440CY | 440 Volts | | | |
| PCV-460AY | PCV-460BY | PCV-460CY | 460 Volts | | | |
| PCV-480AY | PCV-480BY | PCV-480CY | 480 Volts | | | |
| PCV-600AY | PCV-600BY | PCV-600CY | 600 Volts | | | |
| PCV-BLANKAY | PCV-BLANKBY | PCV-BLANKCY | Blank – No Legend | | | |
| PCV-ESAY | PCV-ESBY | PCV-ESCY | Emergency Service | | | |
| PCV-FAAY | PCV-FABY | PCV-FACY | Fire Alarm | | | |
| PCV-FOAY | PCV-FOBY | PCV-FOCY | Fiber Optic | | | |
| PCV-FOCAAY | PCV-FOCBY | PCV-FOCCY | Fiber Optic Cable | | | |
| PCV-MAINAY | PCV-MAINBY | PCV-MAINCY | Main | | | |
| PCV-TELEAY | PCV-TELEBY | PCV-TELECY | Telephone | | | |

| Style | Width | | Length | | Pipe/Conduit O.D. Range | | Markers Per Card |
|-------|-------|--------|--------|--------|-------------------------|----------------|------------------|
| | In. | mm | In. | mm | In. | mm | |
| M | 14.00 | 355.60 | 23.00 | 584.20 | 2.25 – 6.00 | 57.20 – 152.40 | 1 |
| R | 8.00 | 230.20 | 8.00 | 230.20 | .75 – 2.25 | 19.10 – 57.20 | 1 |

| Part Number | | Legend | Color (Legend/Background) | Std. Pkg. Qty. | Std. Ctn. Qty. |
|-------------|-----------|-------------|---------------------------|----------------|----------------|
| Style M | Style R | | | | |
| | PCV-120RY | 120 Volts | Black/Orange | 1 | 25 |
| | PCV-480RY | 480 Volts | | 1 | 25 |
| PCV-FOMY | PCV-FORY | Fiber Optic | | 1 | 25 |

RU Voltage and Safety Marker Books



Material Chart

| Material | Print Method | Temperature Range | Features |
|----------|--------------|--------------------------------|--|
| Vinyl | Pre-Printed | -40°F to 200°F (-40°C to 93°C) | Indoor rated; economical general purpose material; excellent adhesion properties when applied to a clean, dry surface. |

| Part Number | Legend | Markers Per Page | Markers Per Book | Std. Qty. Book(s) |
|-------------|--------|------------------|------------------|-------------------|
|-------------|--------|------------------|------------------|-------------------|

Voltage Markers

1.50" x 3.25" (38.00mm x 82.00mm)

| Part Number | Legend | Markers Per Page | Markers Per Book | Std. Qty. Book(s) |
|----------------|---------------|------------------|------------------|-------------------|
| PCVB-110-Y | 110 Volts | 3 | 30 | 1 |
| PCVB-220-Y | 220 Volts | | | |
| PCVB-277-Y | 277 Volts | | | |
| PCVB-277/480-Y | 277/480 Volts | | | |
| PCVB-440-Y | 440 Volts | | | |
| PCVB-480-Y | 480 Volts | | | |
| PCVB-4160-Y | 4160 Volts | | | |

Safety Markers

1.50" x 3.25" (38.00 mm x 82.00mm)

| Part Number | Legend | Markers Per Page | Markers Per Book | Std. Qty. Book(s) |
|-------------|---------------------|------------------|------------------|-------------------|
| PSSB-13 | Danger High Voltage | 3 | 30 | 1 |

RU Hazard Tape



Material Chart

| Material | Print Method | Temperature Range | Features |
|----------|--------------|--------------------------------|--|
| Vinyl | Pre-Printed | -20°F to 175°F (-29°C to 79°C) | Indoor rated; color-coded for quick identification; can be used in place of paint; excellent adhesion properties when applied to a clean, dry surface. |

| Part Number | Part Description | Width | | Length | | Std. Pkg. Qty. | Std. Ctn. Qty. |
|--------------|---|-------|-------|--------|------|----------------|----------------|
| | | In. | mm | Ft. | m | | |
| HT2S-BLK-YEL | Black/yellow stripe, adhesive continuous tape. | 2.00 | 50.80 | 54.0 | 16.5 | 1 | 12 |
| HT2S-RED-WHT | Red/white striped, adhesive continuous tape. | 2.00 | 50.80 | 54.0 | 16.5 | 1 | 12 |
| HT3S-BLK-YEL | Black/yellow striped, adhesive continuous tape. | 3.00 | 76.20 | 54.0 | 16.5 | 1 | 10 |
| HT3S-RED-WHT | Red/white striped, adhesive continuous tape. | 3.00 | 76.20 | 54.0 | 16.5 | 1 | 10 |

A. System Overview

B1. Cable Ties

B2. Cable Accessories

B3. Stainless Steel Ties

C1. Wiring Duct

C2. Surface Raceway

C3. Abrasion Protection

C4. Cable Management

D1. Terminals

D2. Power Connectors

D3. Grounding Connectors

E1. Labeling Systems

E2. Labels

E3. Pre-Printed & Write-On Markers

E4. Permanent Identification

E5. Lockout/Tagout & Safety Solutions

F. Index

A. System Overview

Solid Color Adhesive Warning Tape

B1. Cable Ties

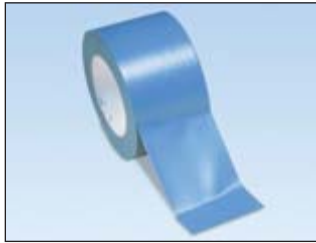

B2. Cable Accessories

B3. Stainless Steel Ties

C1. Wiring Duct

C2. Surface Raceway

C3. Abrasion Protection

C4. Cable Management

D1. Terminals

D2. Power Connectors

D3. Grounding Connectors

E1. Labeling Systems

E2. Labels

E3. Pre-Printed & Write-On Markers

E4. Permanent Identification

E5. Lockout/Tagout & Safety Solutions

F. Index

Material Chart

| Material | Temperature Range | Features |
|----------|-----------------------------------|--|
| Vinyl | -20°F to 175°F (-29°C to 79°C) | Indoor rated; color-coded for quick identification; can be used in place of paint; excellent adhesion properties when applied to a clean, dry surface. |

| Part Number | Color | Width | | Length | | Std. Pkg. Qty. | Std. Ctn. Qty. |
|----------------|--------|-------|-------|--------|------|----------------|----------------|
| | | In. | mm | Ft. | m | | |
| HT2-BLU | Blue | 2.00 | 50.80 | 180.0 | 55.0 | 1 | 5 |
| HT2-GRN | Green | 2.00 | 50.80 | 180.0 | 55.0 | 1 | 5 |
| HT2-ORN | Orange | 2.00 | 50.80 | 180.0 | 55.0 | 1 | 5 |
| HT2-RED | Red | 2.00 | 50.80 | 180.0 | 55.0 | 1 | 5 |
| HT2-WHT | White | 2.00 | 50.80 | 180.0 | 55.0 | 1 | 5 |
| HT2-YEL | Yellow | 2.00 | 50.80 | 180.0 | 55.0 | 1 | 5 |

Photoluminescent Tapes – Thermal Transfer Printable



Normal Lighting

- Used to mark egress routes, fire alarms, and fire equipment that is clearly visible for up to ten hours after power is lost
- Absorb energy from ambient light and releases this energy in the form of a glow when power is lost
- Can be used in the *PANDUIT* thermal transfer desktop printers to create direction arrow tape, striped tape, or safety signs on demand
- *PANDUIT* Photoluminescent Tapes meet or exceed the following safety standard specification for photoluminescent safety markings including: ASTM E 2072-00, ASTM E 2073-00, ASTM E 2030-99, DIN67510-1, IMO Resolution A.752.18, ISO/CD 15370, DIN 67510, UL 924, ASTM 162, ASTM 648, ASTM 662, MIL-L-3891 B, NFPA 101 Life Safety Code, OSHA 1910.137



Black Light

Material Chart

| Material | Print Method | Temperature Range | Features |
|----------------------------------|----------------------|------------------------------------|---|
| Polyester, Photoluminescent (Y2) | Thermal Transfer (T) | -40°F to 230°F (-40°C to 110°C) | Indoor/outdoor rated; provides durability, high temperature resistance, and dimensional stability; does not stretch or easily tear; After power is lost, material emits glow that is clearly visible for up to ten hours. |

| Part Number | Part Description | Width | | Length | | Std. Pkg. Qty. | Std. Ctn. Qty. |
|--------------------|---|-------|-------|--------|------|----------------|----------------|
| | | In. | mm | Ft. | m | | |
| Pre-Printed | | | | | | | |
| PT2S-ARW | Photoluminescent, polyester tape, black arrow. | 2.00 | 50.80 | 30.00 | 9.14 | 1 | 4 |
| PT2S-BLK | Photoluminescent, polyester tape, black stripe. | 2.00 | 50.80 | 30.00 | 9.14 | 1 | 4 |
| PT2S-RED | Photoluminescent, polyester tape, red stripe. | 2.00 | 50.80 | 30.00 | 9.14 | 1 | 4 |

Blank

| | | | | | | | |
|--------------------|-----------------------------------|------|--------|-------|-----|---|---|
| T200X000Y2T | Photoluminescent, polyester tape. | 2.00 | 50.80 | 15.00 | 4.5 | 1 | 4 |
| T400X000Y2T | Photoluminescent, polyester tape. | 4.00 | 101.60 | 15.0 | 4.5 | 1 | 4 |

Order number of rolls required.

Labels roll mounted on 3.00" cores; when using the TDP43MY thermal transfer desktop printer and 3.00" cores, the roll stand (TDP43M-RS) is required.



PT2S-ARW



PT2S-BLK



PT2S-RED

Underground Hazard Tape



Material Chart

| Material | Print Method | Temperature Range | Features |
|--------------------------------------|--------------|---------------------------------|--|
| Polyethylene (HTU, HTB) | Pre-Printed | -30°F to 200°F (-34°C to 93°C) | Indoor/outdoor rated; designed for direct burial; highly visible legend is protected from abrasion and chemicals; resistant to UV light, chemical atmosphere, and abrasion; will not biodegrade. |
| Detectible Laminated Aluminum (HTDU) | Pre-Printed | -30°F to 220°F (-34°C to 104°C) | Indoor/outdoor rated; aluminum embedded material is designed for direct burial; highly visible legend is protected from abrasion and chemicals; resistant to UV light, chemical atmosphere, and abrasion; will not biodegrade. |

| Part Number | Legend | Color (Legend/Background) | Height | | Length | | Std. Pkg. Qty. |
|--------------------------------------|---|------------------------------|--------|--------|---------|--------|----------------|
| | | | In. | mm | Ft. | m | |
| Laminated Detectable Aluminum | | | | | | | |
| HTDU2B-W | CAUTION WATER LINE BURIED BELOW | Black/Blue | 2.00 | 50.80 | 1000.00 | 305.00 | 1 |
| HTDU2O-FO | CAUTION FIBER OPTIC CABLE BURIED BELOW | Black/Orange | | | | | 1 |
| HTDU2O-T | CAUTION TELEPHONE LINE BURIED BELOW | Black/Orange | | | | | 1 |
| HTDU2R-E | CAUTION ELECTRIC LINE BURIED BELOW | Black/Red | | | | | 1 |
| HTDU3O-FO | CAUTION FIBER OPTIC CABLE BURIED BELOW | Black/Orange | 3.00 | 76.00 | 1000.00 | 305.00 | 1 |
| HTDU3O-T | CAUTION TELEPHONE LINE BURIED BELOW | Black/Orange | | | | | 1 |
| HTDU3R-E | CAUTION ELECTRIC LINE BURIED BELOW | Black/Red | | | | | 1 |
| HTDU6O-FO | CAUTION FIBER OPTIC CABLE BURIED BELOW | Black/Orange | 6.00 | 152.00 | 1000.00 | 305.00 | 1 |
| HTDU6O-T | CAUTION TELEPHONE LINE BURIED BELOW | Black/Orange | | | | | 1 |
| HTDU6R-E | CAUTION ELECTRIC LINE BURIED BELOW | Black/Red | | | | | 1 |
| Polyethylene | | | | | | | |
| HTU3G-T-M | CAUTION TELEPHONE LINE BURIED BELOW | Black/Green | 3.00 | 76.00 | 1000.00 | 305.00 | 1 |
| HTU3O-FO-M | CAUTION BURIED FIBER OPTIC CABLE | Black/Orange | | | | | 1 |
| HTU3O-T-M | CAUTION TELEPHONE LINE BURIED BELOW | Black/Orange | | | | | 1 |
| HTU3R-E-M | CAUTION ELECTRIC LINE BURIED BELOW | Black/Red | | | | | 1 |
| HTU3Y-E-M | CAUTION ELECTRIC LINE BURIED BELOW | Black/Yellow | | | | | 1 |
| HTU6R-E | CAUTION ELECTRIC LINE BURIED BELOW | Black/Red | 6.00 | 152.00 | 1000.00 | 305.00 | 1 |
| HTU6O-FO | CAUTION BURIED FIBER OPTIC CABLE | Black/Orange | | | | | 1 |
| HTU6O-T | CAUTION TELEPHONE LINE BURIED BELOW | Black/Orange | | | | | 1 |
| HTU6O-TV | CAUTION CABLE TV LINE BURIED BELOW | Black/Orange | | | | | 1 |
| HTU6Y-E | CAUTION ELECTRIC LINE BURIED BELOW | Black/Yellow | | | | | 1 |
| HTU6Y-G | CAUTION GAS LINE BURIED BELOW | Black/Yellow | | | | | 1 |

A.
System
Overview

B1.
Cable
Ties

B2.
Cable
Accessories

B3.
Stainless
Steel Ties

C1.
Wiring
Duct

C2.
Surface
Raceway

C3.
Abrasion
Protection

C4.
Cable
Management

D1.
Terminals

D2.
Power
Connectors

D3.
Grounding
Connectors

E1.
Labeling
Systems

E2.
Labels

E3.
Pre-Printed
& Write-On
Markers

E4.
Permanent
Identification

E5.
Lockout/
Tagout
& Safety
Solutions

F.
Index

A.
System
Overview

Barricade Tapes

B1.
Cable Ties



B2.
Cable
Accessories

B3.
Stainless
Steel Ties

| Part Number | Legend | Color (Legend/ Background) | Height | | Length | | Std. Pkg. Qty. |
|-------------|-------------------------|----------------------------------|--------|-------|---------|--------|----------------------|
| | | | In. | mm | Ft. | m | |
| HTB3-C-M | CAUTION | Black/Yellow | 3.00 | 76.20 | 1000.00 | 305.00 | 1 |
| HTB3-DNE-M | CAUTION DO NOT ENTER | Black/Yellow | 3.00 | 76.00 | 1000.00 | 305.00 | 1 |
| HTB3-HV-M | CAUTION HIGH VOLTAGE | Black/Yellow | 3.00 | 76.00 | 1000.00 | 305.00 | 1 |

C1.
Wiring
Duct

Vinyl Letters and Numbers

C2.
Surface
Raceway



C3.
Abrasion
Protection

C4.
Cable
Management

Material Chart

| Material | Print Method | Temperature Range | Features |
|----------------|--------------|------------------------------------|---|
| Vinyl (PVL) | Pre-Printed | -50°F to 225°F (-46°C to 107°C) | Indoor/outdoor rated; heavy duty material for flat applications and safety and facility identification; resistant to UV light, chemical atmosphere, and abrasion. |

D1.
Terminals

D2.
Power
Connectors

D3.
Grounding
Connectors

E1.
Labeling
Systems

E2.
Labels

E3.
Pre-Printed
& Write-On
Markers

E4.
Permanent
Identification

E5.
Lockout/
Tagout/
& Safety
Solutions

F.
Index

| Part Number | Legend | Legend Height | | Height | | Width | | Color (Legend/ Background) | Markers Per Card | Std. Pkg. Card(s) |
|--------------------------------------|----------------|---------------|-------|--------|-------|-------|-------|----------------------------------|------------------------|-------------------------|
| | | In. | mm | In. | mm | In. | mm | | | |
| PVL100BY-0-Y | 0 | 1.00 | 25.40 | 1.50 | 38.10 | .88 | 22.35 | Black/Yellow | 10 | 25 |
| PVL100BY-1-Y thru PVL100BY-9-Y | 1 thru 9 | | | | | | | | | 25 |
| PVL100BY-A-Y thru PVL100BY-Z-Y | A thru Z | | | | | | | | | 25 |
| PVL100BY-DSH-Y | — | | | | | | | | | 25 |
| PVL200BY-0-Y | 0 | | | | | | | | | 2.00 |
| PVL200BY-1-Y thru PVL200BY-9-Y | 1 thru 9 | 25 | | | | | | | | |
| PVL200BY-A-Y thru PVL200BY-Z-Y | A thru Z | 25 | | | | | | | | |
| PVL200BY-DSH-Y | — | 25 | | | | | | | | |

Vinyl Cloth Letters and Numbers



Material Chart

| Material | Print Method | Temperature Range | Features |
|--------------------------|--------------|--------------------------------|---|
| Vinyl Cloth, (PCL,PCLCP) | Pre-Printed | -50°F to 170°F (-46°C to 77°C) | Indoor/outdoor rated; thin conformable material with repositionable adhesive allows label to be removed and reused or used in temporary applications; provides durability, high temperature resistance, and dimensional stability for rough or textured surfaces. |

| Part Number | Legend | Legend Height | | Height | | Width | | Color (Legend/Background) | Markers Per Card | Std. Pkg. Card(s) | Std. Ctn. Card(s) |
|------------------------|----------------------|---------------|-------|--------|-------|-------|-------|---------------------------|------------------|-------------------|-------------------|
| | | In. | mm | In. | mm | In. | mm | | | | |
| PCL037-0 | 0 | | | | | | | | | 25 | 100 |
| PCL037-1 thru PCL037-9 | 1 thru 9 | | | | | | | | | 25 | 100 |
| PCL037-0-9 | 0 thru 9 | | | | | | | | | 25 | 100 |
| PCL037-A thru PCL037-Z | A thru Z | .38 | 9.65 | .75 | 19.05 | .34 | 8.64 | Black/Yellow | 78 | 25 | 100 |
| PCL037-A-Z | A thru Z | | | | | | | | | 25 | 100 |
| PCLCP037-A-Z | A thru Z | | | | | | | | | 1 | 4 |
| PCLCP037-0-9 | 0 thru 9 | | | | | | | | | 1 | 4 |
| PCL062-0 | 0 | | | | | | | | | 25 | 100 |
| PCL062-1 thru PCL062-9 | 1 thru 9 | | | | | | | | | 25 | 100 |
| PCL062-0-9 | 0 thru 9 | | | | | | | | | 1 | 4 |
| PCL062-A thru PCL062-Z | A thru Z | .63 | 16.00 | .75 | 19.05 | .56 | 14.22 | Black/Yellow | 32 | 25 | 100 |
| PCL062-A-Z | A thru Z | | | | | | | | | 25 | 100 |
| PCLCP062-0-9 | 1 thru 5 6 thru 0 | | | | | | | | | 1 | 4 |
| PCLCP062-A-Z | A thru Z | | | | | | | | | 1 | 4 |
| PCL062-DSH | — | | | | | | | | | 25 | 100 |
| PCL100-0 | 0 | | | | | | | | | 25 | 100 |
| PCL100-1 thru PCL100-9 | 1 thru 9 | | | | | | | | | 25 | 100 |
| PCL100-0-9 | 0 thru 9 | | | | | | | | | 25 | 100 |
| PCL100-A thru PCL100-Z | A thru Z | 1.00 | 25.40 | 1.50 | 38.10 | .88 | 22.35 | Black/Yellow | 10 | 25 | 100 |
| PCL100-A-J | A thru J | | | | | | | | | 25 | 100 |
| PCL100-K-T | K thru T | | | | | | | | | 25 | 100 |
| PCL100-U-Z | U thru Z | | | | | | | | | 25 | 100 |
| PCLCP100-0-9 | 1 thru 5 6 thru 0 | | | | | | | | | 1 | 4 |
| PCLCP100-A-Z | A thru Z | | | | | | | | | 1 | 4 |
| PCL100-DSH | — | | | | | | | | | 25 | 100 |
| PCL200-0 | 0 | | | | | | | | | 25 | 100 |
| PCL200-1 thru PCL200-9 | 1 thru 9 | | | | | | | | | 25 | 100 |
| PCL200-0-9 | 0 thru 9 | | | | | | | | | 25 | 100 |
| PCL200-A thru PCL200-Z | A thru Z | 2.00 | 50.80 | 2.25 | 57.15 | .88 | 22.35 | Black/Yellow | 10 | 25 | 100 |
| PCL200-A-J | A thru J | | | | | | | | | 25 | 100 |
| PCL200-K-T | K thru T | | | | | | | | | 25 | 100 |
| PCL200-U-Z | UK thru TZ | | | | | | | | | 25 | 100 |
| PCLCP200-0-9 | 1 thru 5 6 thru 0 | | | | | | | | | 1 | 4 |
| PCLCP200-A-Z | A thru Z | | | | | | | | | 1 | 4 |
| PCL200-DSH | — | | | | | | | | | 25 | 100 |

Table continues on page E5.36.

A. System Overview

B1. Cable Ties

B2. Cable Accessories

B3. Stainless Steel Ties

C1. Wiring Duct

C2. Surface Raceway

C3. Abrasion Protection

C4. Cable Management

D1. Terminals

D2. Power Connectors

D3. Grounding Connectors

E1. Labeling Systems

E2. Labels

E3. Pre-Printed & Write-On Markers

E4. Permanent Identification

E5. Lockout/Tagout & Safety Solutions

F. Index

A.
System
Overview

Vinyl Cloth Letters and Numbers (continued)

B1.
Cable Ties

B2.
Cable
Accessories

B3.
Stainless
Steel Ties

C1.
Wiring
Duct

| Part Number | Legend | Legend Height | | Height | | Width | | Color (Legend/Background) | Markers Per Card | Std. Pkg. Card(s) | Std. Ctn. Card(s) |
|------------------------------|----------------------|---------------|-------|--------|-------|-------|-------|------------------------------|------------------------|-------------------------|-------------------------|
| | | In. | mm | In. | mm | In. | mm | | | | |
| PCL300-0 | 0 | 3.00 | 76.20 | 3.50 | 88.90 | 1.50 | 38.10 | Black/Yellow | 6 | 25 | 100 |
| PCL300-1 thru PCL300-9 | 1 thru 9 | | | | | | | | | 25 | 100 |
| PCL300-A thru PCL300-Z | A thru Z | | | | | | | | | 25 | 100 |
| PCLCP300-0-9 | 1 thru 5 6 thru 0 | | | | | | | | | 1 | 4 |
| PCLCP300-A-Z | A thru Z | | | | | | | | | 1 | 4 |
| PCL300-DSH | — | | | | | | | | | 25 | 100 |

C2.
Surface
Raceway

Reflective Letters and Numbers

C3.
Abrasion
Protection

C4.
Cable
Management



Material Chart

| Material | Print Method | Temperature Range | Features |
|-------------------------|--------------|-----------------------------------|--|
| Reflective Vinyl, (PRL) | Pre-Printed | -30°F to 200°F (-34°C to 93°C) | Indoor/outdoor rated; heavy duty reflective material for flat applications and safety and facility identification; resistant to UV light, chemical atmosphere, and abrasion. |

D1.
Terminals

D2.
Power
Connectors

D3.
Grounding
Connectors

E1.
Labeling
Systems

E2.
Labels

E3.
Pre-Printed
& Write-On
Markers

E4.
Permanent
Identification

E5.
Lockout/
Tagout
& Safety
Solutions

F.
Index

| Part Number | Legend | Legend Height | | Height | | Width | | Color (Legend/Background) | Markers Per Pkg. | Std. Pkg. Qty. | Std. Ctn. Qty. | | | | | | | | | | | | |
|----------------------------------|--------------------------------------|---------------|-------|--------|-------|-------|-------|------------------------------|------------------------|----------------------|----------------------|----|---|---|----|---|---|-----|---|---|-----|---|---|
| | | In. | mm | In. | mm | In. | mm | | | | | | | | | | | | | | | | |
| PRL100BY-0 thru PRL100BY-9 | 0 thru 9 | 1.00 | 25.40 | 1.63 | 41.40 | 1.00 | 25.40 | Black/Yellow | 25 | 1 | 4 | | | | | | | | | | | | |
| PRL100BY-A thru PRL100BY-Z | A thru Z | | | | | | | | | | | 25 | 1 | 4 | | | | | | | | | |
| PRL100BY-DSH | — | | | | | | | | | | | | | | 25 | 1 | 4 | | | | | | |
| PRL100BY-18KIT | 0 thru 9, A thru D, L, P, R, S | | | | | | | | | | | | | | | | | 900 | 1 | — | | | |
| PRL100BY-36KIT | 0 thru 9, D, L, P, R, S, —, Blank | | | | | | | | | | | | | | | | | | | | 950 | 1 | — |
| PRL100BY-BLNK | BLANK | | | | | | | | | | | | | | | | | | | | | | |
| PRL150YB-0 thru PRL150YB-9 | 0 thru 9 | 1.50 | 38.10 | 1.88 | 47.75 | 1.38 | 35.05 | Yellow/Black | 25 | 1 | 4 | | | | | | | | | | | | |
| PRL150YB-A thru PRL150YB-Z | A thru Z | | | | | | | | | | | 25 | 1 | 4 | | | | | | | | | |
| PRL150YB-DSH | — | | | | | | | | | | | | | | 25 | 1 | 4 | | | | | | |
| PRL250YB-0 thru PRL250YB-9 | 0 thru 9 | | | | | | | | | | | | | | | | | 25 | 1 | 4 | | | |
| PRL250YB-A thru PRL250YB-Z | A thru Z | | | | | | | | | | | | | | | | | | | | 25 | 1 | 4 |
| PRL250YB-DSH | — | | | | | | | | | | | | | | | | | | | | | | |

Sign Panels – Blank Space for Custom Messages

Indoor/Outdoor Sub-Surface Printed Adhesive Polyester (Type PPS)

- High quality signs for use indoors and outdoors
- Excellent resistance to UV light, chemical atmosphere, and abrasion
- Excellent life and adhesion properties
- Printed graphics are protected by clear polyester laminate







Indoor/Outdoor Rigid Polyethylene (Type PRS)

- Rugged signs for indoors and outdoors
- Abrasion resistant
- Used where adhesives will not work

- Can be used with *PANDUIT* Thermal Transfer Desktop Printers and *EASY-MARK™* Labeling Software to create your own custom signs
- Print your own legend on clear polyester tape with the TDP43MY Thermal Transfer Desktop Printer and adhere label to adhesive or non-adhesive sign panel
- Can also be used with *PANDUIT* Die Cut Letter and Numbers

Material Chart

| Material | Print Method | Temperature Range | Features |
|--------------------------|--------------|-------------------------------------|---|
| Polyester (PPS) | Pre-Printed | -40°F to 275°F (-40°C to 135°C) | Indoor/outdoor rated; laminated label material protects legend from abrasion and chemicals; resistant to UV light, chemical atmosphere, and abrasion; excellent life and adhesion properties. |
| Rigid Polyethylene (PRS) | | -105°F to 250°F (-76°C to 121°C) | Indoor/outdoor rated; high quality, rugged material resistant to abrasion; use where adhesives will not work. |

| Part Number | Symbol | Header | Width | | Height | | Std. Pkg. Qty. | Std. Ctn. Qty. |
|-------------|---|---------|-------|--------|--------|--------|----------------|----------------|
| | | | In. | mm | In. | mm | | |
| PPS0710BWHT |  | BLANK | 10.00 | 254.00 | 7.00 | 177.80 | 1 | 25 |
| PPS1014BWHT | | | 14.00 | 355.60 | 10.00 | 254.00 | 1 | 25 |
| PPS1420BWHT | | | 20.00 | 508.00 | 14.00 | 355.60 | 1 | 25 |
| PRS0710BWHT | | | 10.00 | 254.00 | 7.00 | 177.80 | 1 | 10 |
| PRS1014BWHT | | | 14.00 | 355.60 | 10.00 | 254.00 | 1 | 10 |
| PRS1420BWHT | | | 20.00 | 508.00 | 14.00 | 355.60 | 1 | 10 |
| PPS0710BYEL |  | BLANK | 10.00 | 254.00 | 7.00 | 177.80 | 1 | 25 |
| PPS1014BYEL | | | 14.00 | 355.60 | 10.00 | 254.00 | 1 | 25 |
| PPS1420BYEL | | | 20.00 | 508.00 | 14.00 | 355.60 | 1 | 25 |
| PRS0710BYEL | | | 10.00 | 254.00 | 7.00 | 177.80 | 1 | 10 |
| PRS1014BYEL | | | 14.00 | 355.60 | 10.00 | 254.00 | 1 | 10 |
| PRS1420BYEL | | | 20.00 | 508.00 | 14.00 | 355.60 | 1 | 10 |
| PPS0710BYEL |  | CAUTION | 10.00 | 254.00 | 7.00 | 177.80 | 1 | 25 |
| PPS1014BYEL | | | 14.00 | 355.60 | 10.00 | 254.00 | 1 | 25 |
| PPS1420BYEL | | | 20.00 | 508.00 | 14.00 | 355.60 | 1 | 25 |
| PRS0710C442 | | | 10.00 | 254.00 | 7.00 | 177.80 | 1 | 25 |
| PPS1014C442 | | | 14.00 | 355.60 | 10.00 | 254.00 | 1 | 25 |
| PPS1420C442 | | | 20.00 | 508.00 | 14.00 | 355.60 | 1 | 25 |
| PRS0710C442 |  | DANGER | 10.00 | 254.00 | 7.00 | 177.80 | 1 | 10 |
| PRS1014C442 | | | 14.00 | 355.60 | 10.00 | 254.00 | 1 | 10 |
| PRS1420C442 | | | 20.00 | 508.00 | 14.00 | 355.60 | 1 | 10 |
| PPS0710D440 | | | 10.00 | 254.00 | 7.00 | 177.80 | 1 | 25 |
| PPS1014D440 | | | 14.00 | 355.60 | 10.00 | 254.00 | 1 | 25 |
| PPS1420D440 | | | 20.00 | 508.00 | 14.00 | 355.60 | 1 | 25 |
| PRS0710D440 |  | NOTICE | 10.00 | 254.00 | 7.00 | 177.80 | 1 | 10 |
| PRS1014D440 | | | 14.00 | 355.60 | 10.00 | 254.00 | 1 | 10 |
| PRS1420D440 | | | 20.00 | 508.00 | 14.00 | 355.60 | 1 | 10 |
| PPS0710N443 | | | 10.00 | 254.00 | 7.00 | 177.80 | 1 | 25 |
| PPS1014N443 | | | 14.00 | 355.60 | 10.00 | 254.00 | 1 | 25 |
| PPS1420N443 | | | 20.00 | 508.00 | 14.00 | 355.60 | 1 | 25 |
| PRS0710N443 |  | NOTICE | 10.00 | 254.00 | 7.00 | 177.80 | 1 | 10 |
| PRS1014N443 | | | 14.00 | 355.60 | 10.00 | 254.00 | 1 | 10 |
| PRS1420N443 | | | 20.00 | 508.00 | 14.00 | 355.60 | 1 | 10 |

Order number of Standard Packages required

A.
System
Overview

B1.
Cable Ties

B2.
Cable
Accessories

B3.
Stainless
Steel Ties

C1.
Wiring
Duct

C2.
Surface
Raceway

C3.
Abrasion
Protection

C4.
Cable
Management

D1.
Terminals

D2.
Power
Connectors

D3.
Grounding
Connectors

E1.
Labeling
Systems

E2.
Labels

E3.
Pre-Printed
& Write-On
Markers

E4.
Permanent
Identification

E5.
Lockout/
Tagout
& Safety
Solutions

F.
Index

A. System Overview



Thermal Transfer Printable Arc Flash Labels

B1. Cable Ties

- Provide employees with the highest degree of safety through proper identification and communication
- Clearly visible and recognizable hazard information to communicate arc flash hazards present

- Labels are constructed of durable polyester designed to withstand UV exposure, outdoor use, water, abrasion
- Custom Arc Flash Hazard Labels can be printed using *PANDUIT* labeling software and desktop thermal transfer printers

B2. Cable Accessories

B3. Stainless Steel Ties

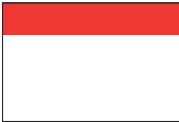

C400X600YX1

C1. Wiring Duct



C400X600YZ1

C2. Surface Raceway

C3. Abrasion Protection



T400X000YX1

C4. Cable Management

D1. Terminals

D2. Power Connectors

D3. Grounding Connectors



Laser Printable Adhesive Signs

- Signs can be printed with a standard laser printer
- Indoor polyolefin pressure sensitive signs with square corners on stay flat liner

- Signs are 8.50" x 11.00" (215.90mm x 279.40mm) in size
- 25 signs per package

E1. Labeling Systems



SEZ-1CLL



SEZ-1DLL

E2. Labels



SEZ-1NLL



SEZ-1WLL

E3. Pre-Printed & Write-On Markers

E4. Permanent Identification

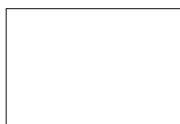

SEZ-1WHLL



SEZ-1YLL

E5. Lockout/Tagout & Safety Solutions

F. Index

| Part Number | Part Description | Std. Pkg. Qty. | Std. Ctn. Qty. |
|---------------------------------|---|----------------|----------------|
| Custom – Die-Cut | | | |
| C400X600YX1 | 4.00" x 6.00" (101.60mm x 152.40mm), polyester arc flash label, orange header, 100 labels per roll. | 1 | 4 |
| C400X600YZ1 | 4.00" x 6.00" (101.60mm x 152.40mm), polyester arc flash label, red/white danger header, 100 labels per roll. | 1 | 4 |
| Custom – Continuous Tape | | | |
| T400X000YX1 | 4.00" x 50.0' (101.60mm x 15.24m), polyester arc flash tape, orange header. | 1 | 4 |

| Part Number | Legend | Color (Legend/Background) | Width | | Height | | Signs Per Pkg. | Std. Pkg. Qty. | Std. Ctn. Qty. |
|-------------|---------|---------------------------|-------|--------|--------|--------|----------------|----------------|----------------|
| | | | In. | mm | In. | mm | | | |
| SEZ-1CLL | CAUTION | Black/Yellow | 8.50 | 216.00 | 11.00 | 279.00 | 25 | 1 | 5 |
| SEZ-1DLL | DANGER | Red and Black/White | 8.50 | 216.00 | 11.00 | 279.00 | 25 | 1 | 5 |
| SEZ-1NLL | NOTICE | Blue/White | 8.50 | 216.00 | 11.00 | 279.00 | 25 | 1 | 5 |
| SEZ-1WLL | WARNING | Black/Orange | 8.50 | 216.00 | 11.00 | 279.00 | 25 | 1 | 5 |
| SEZ-1WHLL | BLANK | White | 8.50 | 216.00 | 11.00 | 279.00 | 25 | 1 | 5 |
| SEZ-1YLL | BLANK | Yellow | 8.50 | 216.00 | 11.00 | 279.00 | 25 | 1 | 5 |

Self-Laminating Adhesive Sign Carriers



Material Chart

| Material | Print Method | Temperature Range | Features |
|-------------|--------------|-----------------------------------|---|
| Rigid Vinyl | Pre-Printed | -40°F to 150°F (-40°C to 66°C) | Indoor/outdoor rated; rigid material accepts ink; resistant to UV light, chemical atmosphere, and abrasion; excellent for applications where adhesives will not work. |

| Part Number | Height | | | | Carriers Per Pkg. | Std. Pkg. Qty. | Std. Ctn. Qty. |
|-------------|--------|----|-----|----|-------------------|----------------|----------------|
| | In. | mm | In. | mm | | | |

Adhesive

| | | | | | | | |
|----------|-------|--------|------|--------|---|---|----|
| SEZ-SNC4 | 7.00 | 178.00 | 6.00 | 152.00 | 5 | 1 | 10 |
| SEZ-SNC2 | 10.50 | 267.00 | 7.00 | 178.00 | 5 | 1 | 10 |
| SEZ-SNC3 | 12.00 | 305.00 | 6.00 | 152.00 | 5 | 1 | 10 |
| SEZ-SNC1 | 12.00 | 305.00 | 9.50 | 241.00 | 5 | 1 | 10 |

Non-Adhesive

| | | | | | | | |
|----------|-------|--------|------|--------|---|---|----|
| SEZ-RSC1 | 7.00 | 178.00 | 6.00 | 152.00 | 5 | 1 | 10 |
| SEZ-RSC2 | 10.50 | 267.00 | 7.00 | 178.00 | 5 | 1 | 10 |
| SEZ-RSC3 | 12.00 | 305.00 | 9.50 | 241.00 | 5 | 1 | 10 |
| SEZ-RSC4 | 12.00 | 305.00 | 6.00 | 152.00 | 5 | 1 | 10 |

Self-Laminating Cable Marker Holders for Large Cables or Cable Bundles



Material Chart

| Material | Print Method | Temperature Range | Features |
|------------------------------|--------------|---------------------------------|---|
| Rigid Vinyl, Self-Laminating | Pre-Printed | 0°F to 176°F (-18°C to 80°C) | Indoor/outdoor rated; high quality, rugged material resistant to abrasion; legend is protected by overlaminates; use where adhesives will not work. |

| Part Number | Color | Width | | Height | | Tags Per Pkg. | Std. Pkg. Qty. | Std. Ctn. Qty. |
|-------------|--------|-------|--------|--------|-------|---------------|----------------|----------------|
| | | In. | mm | In. | mm | | | |
| SLCT-IG | Gray | 3.00 | 76.20 | 1.31 | 33.30 | 25 | 1 | 4 |
| SLCT-OR | Orange | 3.00 | 76.20 | 1.31 | 33.30 | 25 | 1 | 4 |
| SLCT-WH | White | 3.00 | 76.20 | 1.31 | 33.30 | 25 | 1 | 4 |
| SLCT-YL | Yellow | 3.00 | 76.20 | 1.31 | 33.30 | 25 | 1 | 4 |
| SLCT-3 | White | 4.00 | 101.60 | .50 | 12.70 | 25 | 1 | 4 |
| SLCT-3OR | Orange | 4.00 | 101.60 | .50 | 12.70 | 25 | 1 | 4 |
| SLCT-3YL | Yellow | 4.00 | 101.60 | .50 | 12.70 | 25 | 1 | 4 |

Attach with PANDUIT Intermediate or Standard cross section cable ties.

Component Labels for Dot Matrix Printers Supplied on 8.5" x 11" Sheets

| | | | | | | | | |
|-------------|-------------------------|------|-------|------|-------|---|------|------|
| C200X100YJD | White, polyester label. | 2.00 | 50.80 | 1.00 | 25.40 | — | 1000 | 5000 |
|-------------|-------------------------|------|-------|------|-------|---|------|------|

Component Labels for Laser/Ink Jet Printers Supplied on 8.5" x 11" Sheets

| | | | | | | | | |
|-------------|-------------------------|------|-------|------|-------|---|------|------|
| C200X100YJJ | White, polyester label. | 2.00 | 50.80 | 1.00 | 25.40 | — | 1000 | 5000 |
|-------------|-------------------------|------|-------|------|-------|---|------|------|

Component Labels for Thermal Transfer Desktop Printers Supplied on Rolls

| | | | | | | | | |
|-------------|-------------------------|------|-------|------|-------|---|------|------|
| C200X100YJT | White, polyester label. | 2.00 | 50.80 | 1.00 | 25.40 | — | 1000 | 5000 |
|-------------|-------------------------|------|-------|------|-------|---|------|------|

Component Cassettes for PANTHER™ LS8E Hand-Held Thermal Transfer Printer

| | | | | | | | | |
|-------------|---------------------------------------|------|-------|------|-------|---|---|----|
| C200X100YJC | White, polyester label, 200/cassette. | 2.00 | 50.80 | 1.00 | 25.40 | — | 1 | 10 |
|-------------|---------------------------------------|------|-------|------|-------|---|---|----|

A.
System
Overview

B1.
Cable
Ties

B2.
Cable
Accessories

B3.
Stainless
Steel Ties

C1.
Wiring
Duct

C2.
Surface
Raceway

C3.
Abrasion
Protection

C4.
Cable
Management

D1.
Terminals

D2.
Power
Connectors

D3.
Grounding
Connectors

E1.
Labeling
Systems

E2.
Labels

E3.
Pre-Printed
& Write-On
Markers

E4.
Permanent
Identification

E5.
Lockout/
Tagout/
& Safety
Solutions

F.
Index

A.
System
Overview

Self-Laminating Fiber Optic Cable Marker Tags

B1.
Cable Ties

Material Chart



| Material | Print Method | Temperature Range | Features |
|------------------------------|--------------|------------------------------|--|
| Rigid Vinyl, Self-Laminating | Pre-Printed | 0°F to 176°F (-18°C to 80°C) | Indoor/outdoor rated; high quality, rugged material resistant to abrasion; legend is protected by overlamine; use where adhesives will not work. |

B2.
Cable
Accessories

B3.
Stainless
Steel Ties

C1.
Wiring
Duct

| Part Number | Legend | Color (Legend/Background) | Width | | Height | | Tags Per Pkg. | Std. Pkg. Qty. | Std. Ctn. Qty. |
|-------------|---|---------------------------|-------|-------|--------|-------|---------------|----------------|----------------|
| | | | In. | mm | In. | mm | | | |
| PST-FO | CAUTION FIBER OPTIC CABLE TYPE _____ COUNT _____ | Black/Yellow | 3.50 | 89.00 | 2.00 | 51.00 | 5 | 1 | 40 |
| PST-FOBLNK | BLANK | Yellow | 3.50 | 89.00 | 2.00 | 51.00 | 5 | 1 | 40 |

C2.
Surface
Raceway

Also available in Spanish and Portuguese. To order add part number suffix -E for Spanish or -P for Portuguese. Order number of packages required in multiples of Std. Pkg. Qty.

C3.
Abrasion
Protection

C4.
Cable
Management

D1.
Terminals

Ground Warning Tags

D2.
Power
Connectors

Material Chart



| Material | Print Method | Temperature Range | Features |
|--------------------|--------------|---------------------------------|---|
| Rigid Polyethylene | Pre-Printed | -30°F to 250°F (-34°C to 121°C) | Indoor/outdoor rated; high quality, rugged material resistant to abrasion; use where adhesives will not work. |

D3.
Grounding
Connectors

E1.
Labeling
Systems

| Part Number | Legend | Color (Legend/Background) | Width | | Height | | Tags Per Pkg. | Std. Pkg. Qty. | Std. Ctn. Qty. |
|-------------|--------------------------------------|---------------------------|-------|-------|--------|-------|---------------|----------------|----------------|
| | | | In. | mm | In. | mm | | | |
| PT-BGND | NETWORK BUILDING GROUND | Green/Yellow | 2.75 | 70.00 | 1.38 | 35.00 | 100 | 1 | 5 |
| PT-GND | WARNING GROUND WIRE DO NOT REMOVE | Black/Yellow | 2.75 | 70.00 | 1.38 | 35.00 | 100 | 1 | 5 |
| PT-TGND | WARNING TELEPHONE CO. REPAIR SERVICE | Black/Yellow | 2.75 | 70.00 | 1.38 | 35.00 | 100 | 1 | 5 |

E2.
Labels

E3.
Pre-Printed
& Write-On
Markers

E4.
Permanent
Identification

Attach with PANDUIT Intermediate or Standard cross section cable ties.

E5.
Lockout/
Tagout/
& Safety
Solutions

F.
Index

PANDUIT Corp. Generic Lock Order Form

One Form per Generic Lock Option
Fax orders to PANDUIT Corp., Attn: Customer Service (708) 570-3570
Generic Locks are Non-Returnable

Date: _____
 From: _____
 Telephone #: _____
 End User: _____

 Telephone#/Fax#: _____
 Account #: _____

PANDUIT Sales Rep: _____
 Distributor: _____

 Distributor Contact: _____
 Telephone#/Fax#: _____
 Account #: _____

Generic Padlock Options

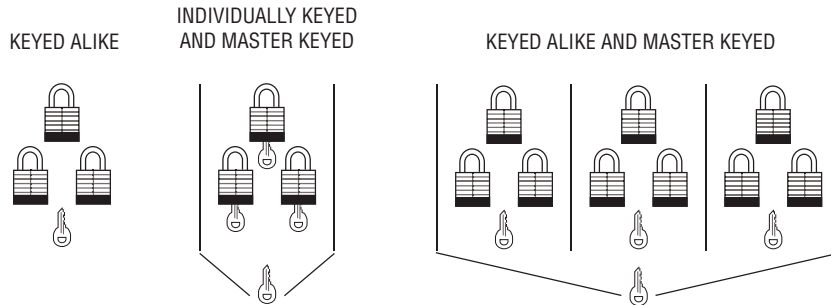

| Generic Lock Part Number | Description | Qty Min. 12/Lock Series | Notes (Colors, Key Numbers, Set Description) |
|--------------------------|-------------|-------------------------|--|
|--------------------------|-------------|-------------------------|--|

PSL-3 Laminated Steel Padlocks: (Select from red, yellow, blue, black, green or white bumper colors)

| | | | |
|--------------|---|--|--|
| GPSL-3KA | Keyed Alike Padlock – 3/4" Shackle | | |
| GPSL-3LSKA | Keyed Alike Padlock – 2" Shackle | | |
| GPSL-3MK | Master Keyed Padlock – 3/4" Shackle | | |
| GPSL-3LSMK | Master Keyed Padlock – 2" Shackle | | |
| GPSL-3MKEY | Master Key for a PSL-3 Master Keyed Padlock | | |
| GPSL-3KAMK | Keyed Alike and Master Keyed Padlock – 3/4" Shackle | | |
| GPSL-3LSKAMK | Keyed Alike and Master Keyed Padlock – 2" Shackle | | |

PSL-4 Safety Lockout Padlocks: (Select from red, yellow, blue, black, green, orange or teal body colors)

| | | | |
|--------------|--|--|--|
| GPSL-4KA | Keyed Alike Padlock | | |
| GPSL-4LBKA | Keyed Alike Padlock – Long Body | | |
| GPSL-4MK | Master Keyed Padlock | | |
| GPSL-4LBMK | Master Keyed Padlock – Long Body | | |
| GPSL-4MKEY | Master Key for a PSL-4 Master Keyed Padlock | | |
| GPSL-4KAMK | Keyed Alike and Master Keyed Padlock | | |
| GPSL-4LBKAMK | Keyed Alike and Master Keyed Padlock – Long Body | | |

PSL-11 Coated Aluminum Padlocks: (Select from red, yellow, blue, black, green or orange body colors)

| | | | |
|----------------|---|--|--|
| GPSL-11KA | Keyed Alike Padlock – 1" Shackle | | |
| GPSL-11LKSA | Keyed Alike Padlock – 3" Shackle | | |
| GPSL-11MK | Master Keyed Padlock – 1" Shackle | | |
| GPSL-11LSMK | Master Keyed Padlock – 3" Shackle | | |
| GPSL-11MKEY | Master Key for a PSL-11 Master Keyed Padlock | | |
| GPSL-11KAMK | Keyed Alike and Master Keyed Padlock – 1" Shackle | | |
| GPSL-11-LSKAMK | Keyed Alike and Master Keyed Padlock – 3" Shackle | | |

For Pricing and Lead Time Information, Contact PANDUIT Customer Service at 800-777-3300

PANDUIT Corp. Generic PVT Vinyl Tag Order Form

One Form per Generic Tag Option

Fax orders to PANDUIT Corp., Attn: Customer Service (708) 570-3570

Generic Tags are Non-Returnable

Date: _____ PANDUIT Sales Rep: _____
 From: _____ Distributor: _____
 Telephone #: _____
 End User: _____

 Telephone#/Fax#: _____ Telephone#/Fax#: _____
 Account #: _____ Account #: _____

Select the Generic Vinyl Tag Part Number and Quantity:

| Number of Sides Printed | DANGER Black on White | CAUTION Black on Yellow | NOTICE Black on White | "No Header" Black on White | "No Header" Black on Yellow | "No Header" Black on Red | "No Header" Black on Green |
|-------------------------|---------------------------------|-----------------------------------|---------------------------------|-------------------------------|--------------------------------|-----------------------------|-------------------------------|
| 1 | GPVT-RBW1 | GPVT-BY1 | GPVT-BBW1 | GPVT-W1-1 | GPVT-Y1-1 | GPVT-R1-1 | GPVT-G1-1 |
| 2 | GPVT-RBW2 | GPVT-BY2 | GPVT-BBW2 | GPVT-W1-2 | GPVT-Y1-2 | GPVT-R1-2 | GPVT-G1-2 |

Quantity In Packs (min. of 4 packs, 25 tags and ties/pack): _____ Part Number: _____

Use this space to create a rough sketch of your tag.
 Please indicate colors and legend. Please print.
 Attach an additional page or customer sketch if needed.

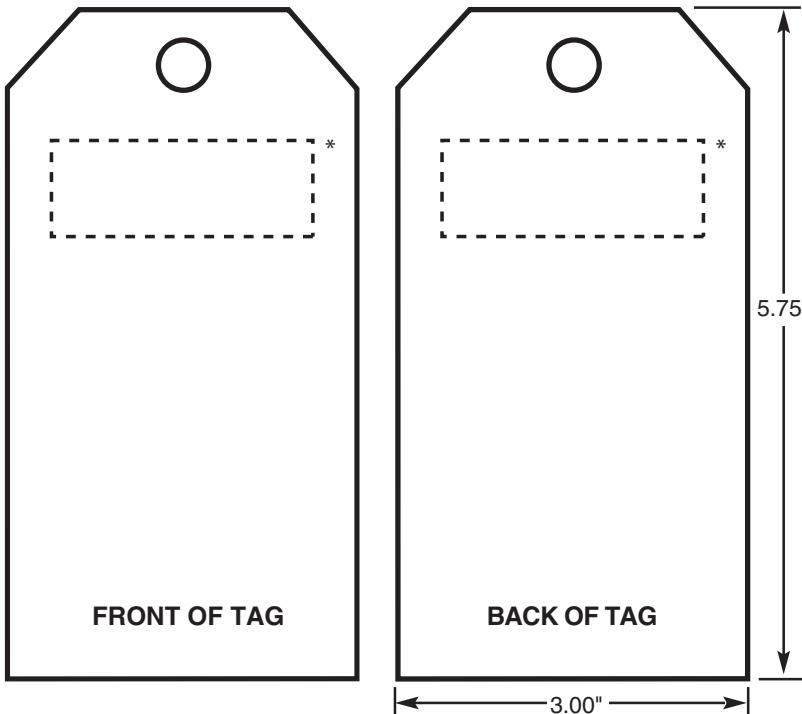

Check Applicable Order Requirements:

Pictogram (type _____)
Logo Required (camera ready artwork must accompany the order form)

Character Height (legend will be formatted to fit the size of the tag unless otherwise specified)

Logo Required _____
 (PANDUIT reserves the right to assign artwork approval when necessary)

*Normal position of header. Hole size = .375" with grommet.

One PANDUIT tie is included per tag.

For Pricing and Lead Time Information, Contact PANDUIT Customer Service at 800-777-3300

PANDUIT Corp. Generic Adhesive PPS Safety Sign Order Form

One Form per Generic Sign Option

Fax orders to PANDUIT Corp., Attn: Customer Service (708) 570-3570





Generic Signs are Non-Returnable

Date: _____ PANDUIT Sales Rep: _____
 From: _____ Distributor: _____
 Telephone #: _____
 End User: _____

 Telephone#/Fax#: _____ Distributor Contact: _____
 Account #: _____ Telephone#/Fax#: _____
 Account #: _____

Generic PPS Sign Options

Select the Generic Polyester Sign Part Number and Quantity

| Size |  Black on White |  Black on Yellow |  Black on White |  Black on White |  Black on Orange | "No Header" Black on Orange | "No Header" Black on White | "No Header" Black on Yellow | "No Header" Red on White |
|-----------|--|---|--|--|---|--------------------------------|-------------------------------|--------------------------------|-----------------------------|
| 3" x 5" | GPPS0305D | GPPS0305C | GPPS0305N | GPPS0305SF | GPPS0305W | GPPS0305B-BO | GPPS0305B-BW | GPPS0305B-BY | GPPS0305B-RW |
| 7" x 10" | GPPS0710D | GPPS0710C | GPPS0710N | GPPS0710SF | GPPS0710W | GPPS0710B-BO | GPPS0710B-BW | GPPS0710B-BY | GPPS0710B-RW |
| 10" x 14" | GPPS1014D | GPPS1014C | GPPS1014N | GPPS1014SF | GPPS1014W | GPPS1014B-BO | GPPS1014B-BW | GPPS1014B-BY | GPPS1014B-RW |

Quantity Per Legend Per Size (Minimum of 10): _____ Part Number: _____

Print Legend in the Format Required:

Include Logos and/or Pictograms



Check Applicable Order Requirements

_____ Pictogram (type _____)
 _____ Logo Required (camera ready artwork must accompany order form)
 _____ Character Height (legend will be formatted to fit the size of the sign unless otherwise specified): _____

ARTWORK APPROVAL (PANDUIT reserves the right to assign artwork approval when necessary)

Notes: _____

For Pricing and Lead Time Information, Contact PANDUIT Customer Service at 800-777-3300

A. System Overview

B1. Cable Ties

B2. Cable Accessories

B3. Stainless Steel Ties

C1. Wiring Duct

C2. Surface Raceway

C3. Abrasion Protection

C4. Cable Management

D1. Terminals

D2. Power Connectors

D3. Grounding Connectors

E1. Labeling Systems

E2. Labels

E3. Pre-Printed & Write-On Markers

E4. Permanent Identification

E5. Lockout/Tagout & Safety Solutions

F. Index

| |
|--|
| A. System Overview |
| B1. Cable Ties |
| B2. Cable Accessories |
| B3. Stainless Steel Ties |
| C1. Wiring Duct |
| C2. Surface Raceway |
| C3. Abrasion Protection |
| C4. Cable Management |
| D1. Terminals |
| D2. Power Connectors |
| D3. Grounding Connectors |
| E1. Labeling Systems |
| E2. Labels |
| E3. Pre-Printed & Write-On Markers |
| E4. Permanent Identification |
| E5. Lockout/Tagout & Safety Solutions |
| F. Index |

PANDUIT Corp. Generic Semi-Rigid PRS Safety Sign Order Form

One Form per Generic Sign Option
Fax orders to PANDUIT Corp., Attn: Customer Service (708) 570-3570
Generic Signs are Non-Returnable

Date: _____ PANDUIT Sales Rep: _____
 From: _____ Distributor: _____
 Telephone #: _____
 End User: _____

 Telephone#/Fax#: _____ Telephone#/Fax#: _____
 Account #: _____ Account #: _____

Generic PRS Sign Options

Select the Generic Semi-Rigid GMPE1 Polyethylene Sign Part Number and Quantity

| | DANGER | CAUTION | NOTICE | SAFETY FIRST | WARNING | "No Header" | "No Header" | "No Header" | "No Header" |
|-----------|----------------|-----------------|----------------|---------------------|-----------------|-----------------|----------------|-----------------|--------------|
| Size | Black on White | Black on Yellow | Black on White | Black on White | Black on Orange | Black on Orange | Black on White | Black on Yellow | Red on White |
| 7" x 10" | GPRS0710D | GPRS0710C | GPRS0710N | GPRS0710SF | GPRS0710W | GPRS0710B-BO | GPRS0710B-BW | GPRS0710B-BY | GPRS0710B-RW |
| 10" x 14" | GPRS1014D | GPRS1014C | GPRS1014N | GPRS1014SF | GPRS1014W | GPRS1014B-BO | GPRS1014B-BW | GPRS1014B-BY | GPRS1014B-RW |
| 14" x 20" | GPRS1420D | GPRS1420C | GPRS1420N | GPRS1420SF | GPRS1420W | GPRS1420B-BO | GPRS1420B-BW | GPRS1420B-BY | GPRS1420B-RW |

Quantity Per Legend Per Size (Minimum of 10): _____ Part Number: _____

Print Legend in the Format Required:
 Include Logos and/or Pictograms



Each sign will have (1) .1875" hole in each corner and .375" radius corners.

Check Applicable Order Requirements

_____ Pictogram (type _____)
 _____ Logo Required (camera ready artwork must accompany order form)
 _____ Character Height (legend will be formatted to fit the size of the sign unless otherwise specified): _____

ARTWORK APPROVAL (PANDUIT reserves the right to assign artwork approval when necessary)

Notes: _____

For Pricing and Lead Time Information, Contact PANDUIT Customer Service at 800-777-3300

PANDUIT Corp. Generic Conduit and Voltage Marker Order Form

One Form per Generic Marker Option
Fax orders to PANDUIT Corp., Attn: Customer Service (708) 570-3570
Generic Markers are Non-Returnable

Date: _____
 From: _____
 Telephone #: _____
 End User: _____

 Telephone#/Fax#: _____
 Account #: _____

PANDUIT Sales Rep: _____
 Distributor: _____

 Distributor Contact: _____
 Telephone#/Fax#: _____
 Account #: _____

Generic Conduit and Voltage Marker Options

Pressure Sensitive Adhesive GMV1 Vinyl Conduit and Voltage Markers

LEGEND

| | |
|---------------|---------------|
| LEGEND | LEGEND |
| LEGEND | LEGEND |

STYLE A

Marker size: 2.25" x 9"
 1 marker per card
 Character height: 1.75"

STYLE B

Marker size: 1.125" x 4.5"
 1 marker per card
 Character height: .75"



STYLE C

Marker size: .50" x 2.25" – 18 marker per card
 Character height: .3125"

Minimum Order Quantity: 10 cards per legend per size and in multiples of 5 cards

| Part Desired ✓ | Quantity of Cards | Part Number | Legend Color | Backgrnd Color | Style | Markers/ Card |
|----------------|-------------------|-------------|--------------|----------------|-------|---------------|
| | | GPCV-AOY | BLACK | ORANGE | A | 1 |
| | | GPCV-BOY | BLACK | ORANGE | B | 4 |
| | | GPCV-COY | BLACK | ORANGE | C | 18 |
| | | GPCV-AYY | BLACK | YELLOW | A | 1 |
| | | GPCV-BYY | BLACK | YELLOW | B | 4 |
| | | GPCV-CYY | BLACK | YELLOW | C | 18 |

Print Legend Required

Legend to fit on one line. Max. 17 characters including spaces.

*Note: In Style B and C, if you want several different legends on a card, draw the lines to signify label division on the legend area. Write in the different legends needed.

Semi-Rigid Snap-On GMPET Polyester Conduit and Voltage Markers



- Protected graphics
- Six reversible legends per marker
- Character height: Size M – .50"
Size R – .75"

Minimum Order Quantity: 10 markers per legend per size

| Part Desired ✓ | Quantity of Markers | Part Number | Legend Color | Backgrnd Color | Style | Length of Marker | Conduit O.D. Range (In.) |
|----------------|---------------------|-------------|--------------|----------------|-------|------------------|--------------------------|
| | | GPCV-ROY | BLACK | ORANGE | R | 8" | .75" - 2.25" |
| | | GPCV-MOY | BLACK | ORANGE | M | 14" | 2.50" - 6.00" |
| | | GPCV-RYY | BLACK | YELLOW | R | 8" | .75" - 2.25" |
| | | GPCV-MYY | BLACK | YELLOW | M | 14" | 2.50" - 6.00" |

Print Legend Required

Legend to fit on one line. Max. 19 characters including spaces.

For Pricing and Lead Time Information, Contact PANDUIT Customer Service at 800-777-3300

A. System Overview

B1. Cable Ties

B2. Cable Accessories

B3. Stainless Steel Ties

C1. Wiring Duct

C2. Surface Raceway

C3. Abrasion Protection

C4. Cable Management

D1. Terminals

D2. Power Connectors

D3. Grounding Connectors

E1. Labeling Systems

E2. Labels

E3. Pre-Printed & Write-On Markers

E4. Permanent Identification

E5. Lockout/Tagout & Safety Solutions

F. Index

PANDUIT Corp. Generic Utility Tapes Order Form

One Form per Generic Utility Tape Option

Fax orders to PANDUIT Corp., Attn: Customer Service (708) 570-3570

Generic Utility Tapes are Non-Returnable

Date: _____ PANDUIT Sales Rep: _____
 From: _____ Distributor: _____
 Telephone #: _____
 End User: _____

 Telephone#/Fax#: _____ Telephone#/Fax#: _____
 Account #: _____ Account #: _____

Generic Utility Tape Options

| Part Number | Material | Width | Length | Use | Min. Order Qty. | Order Increments |
|---------------|-------------------------------|--------------|---------------|------------------------|-----------------|------------------|
| GHTB3 | Polyethylene | 3.0" (76mm) | 1,000' (305m) | Barricade | 36 | 36 |
| GHTU3 | Polyethylene | 3.0" (76mm) | 1,000' (305m) | Underground | 36 | 36 |
| GHTU6 | Polyethylene | 6.0" (152mm) | 1,000' (305m) | Underground | 16 | 16 |
| GHTDU3 | Polyethylene Encased Aluminum | 3.0" (76mm) | 1,000' (305m) | Underground Detectable | 8 | 8 |
| GHTDU6 | Polyethylene Encased Aluminum | 6.0" (152mm) | 1,000' (305m) | Underground Detectable | 8 | 8 |

ALL LEGENDS ARE BLACK MAXIMUM OF TWO LINES OF TEXT ROLLS ARE ON 3 INCH CORE

Part Number: _____ Quantity: _____

Color: _____ (select from Blue, Green, Orange, Red or Yellow)

Sketch Legend and/or Artwork Below:

Comments: _____

For Pricing and Lead Time Information, Contact PANDUIT Customer Service at 800-777-3300

Wire Size Selection Guide

To use this guide place your wire or cable in the appropriate circle to determine wire, outside diameter.

| | |
|--------------------------|--|
| Diameter .10" (2.50mm) | |
| Diameter .20" (5.10mm) | |
| Diameter .28" (7.10mm) | |
| Diameter .54" (13.70mm) | |
| Diameter .94" (23.90mm) | |
| Diameter 1.40" (35.50mm) | |
| Diameter 1.90" (48.30mm) | |
| Diameter 2.40" (61.00mm) | |

The charts below indicate the approximate cable outside diameter or various electrical and communication cables.

Electrical Cables

| Size | Approximate Wire Outside Diameter In. (mm) | | | |
|----------|--|--------------|--------------|---------------|
| | TF | THW | TW | TFN/THHN/THWN |
| 18 AWG | .11 (2.80) | .11 (2.80) | .11 (2.80) | .09 (2.30) |
| 16 AWG | .12 (3.00) | .12 (3.00) | .12 (3.00) | .10 (2.50) |
| 14 AWG | .13 (3.30) | .16 (4.10) | .16 (4.10) | .10 (2.50) |
| 12 AWG | .15 (3.80) | .18 (4.60) | .18 (4.60) | .12 (3.00) |
| 10 AWG | .17 (4.30) | .20 (5.10) | .20 (5.10) | .15 (3.80) |
| 8 AWG | .24 (6.10) | .28 (7.10) | .28 (7.10) | .22 (5.60) |
| 6 AWG | .32 (8.10) | .32 (8.10) | .32 (8.10) | .26 (6.60) |
| 4 AWG | .37 (9.40) | .37 (9.40) | .37 (9.40) | .33 (8.40) |
| 3 AWG | .40 (10.20) | .40 (10.20) | .40 (10.20) | .36 (9.10) |
| 2 AWG | .43 (10.90) | .43 (10.90) | .43 (10.90) | .39 (9.90) |
| 1AWG | .51 (12.90) | .51 (12.90) | .51 (12.90) | .45 (11.40) |
| 1/0 | .55 (14.00) | .55 (14.00) | .55 (14.00) | .49 (12.40) |
| 2/0 | .59 (15.00) | .59 (15.00) | .59 (15.00) | .54 (13.70) |
| 3/0 | .65 (16.50) | .65 (16.50) | .65 (16.50) | .59 (15.00) |
| 4/0 | .70 (17.80) | .70 (17.80) | .70 (17.80) | .65 (16.50) |
| 250 MCM | .79 (20.10) | .79 (20.10) | .79 (20.10) | .72 (18.30) |
| 300 MCM | .84 (21.30) | .84 (21.30) | .84 (21.30) | .77 (19.60) |
| 350 MCM | .89 (22.60) | .89 (22.60) | .89 (22.60) | .82 (20.80) |
| 400 MCM | .94 (23.90) | .94 (23.90) | .94 (23.90) | .87 (22.10) |
| 500 MCM | 1.03 (26.20) | 1.03 (26.20) | 1.03 (26.20) | .95 (24.10) |
| 600 MCM | 1.14 (29.00) | 1.14 (29.00) | 1.14 (29.00) | 1.06 (26.90) |
| 700 MCM | 1.21 (30.70) | 1.21 (30.70) | 1.21 (30.70) | 1.13 (28.70) |
| 750 MCM | 1.25 (31.80) | 1.25 (31.80) | 1.25 (31.80) | 1.16 (29.50) |
| 800 MCM | 1.28 (32.50) | 1.28 (32.50) | 1.28 (32.50) | 1.20 (30.50) |
| 900 MCM | 1.34 (34.00) | 1.34 (34.00) | 1.34 (34.00) | 1.26 (32.00) |
| 1000 MCM | 1.40 (35.60) | 1.40 (35.60) | 1.40 (35.60) | 1.32 (33.50) |
| 1250 MCM | 1.58 (40.10) | 1.58 (40.10) | 1.58 (40.10) | |
| 1500 MCM | 1.70 (43.20) | 1.70 (43.20) | 1.70 (43.20) | |
| 1750 MCM | 1.82 (46.20) | 1.82 (46.20) | 1.82 (46.20) | |
| 2000 MCM | 1.92 (48.80) | 1.92 (48.80) | 1.92 (48.80) | |

Category 3, Category 5/5e/6 and 6a Cable

| Size | Category 3 | | Category 5/5e/6 | | |
|----------|------------------------|-----------------------|-----------------------|-----------------------|-----------------------|
| | Voice Grade 24 AWG UTP | Data Grade 24 AWG UTP | Data Grade 24 AWG STP | Data Grade 22 AWG UTP | Data Grade 22 AWG STP |
| 2-Pair | .12 (3.00) | | | | |
| 3-Pair | .15 (3.80) | | | | |
| 4-Pair | .19 (4.80) | .22 (5.60) | .25 (6.30) | .23 (5.80) | .29 (7.40) |
| 25-Pair | | .42 (10.70) | .51 (12.90) | .54 (13.70) | .63 (16.00) |
| 50-Pair | .46 (11.70) | .66 (16.80) | | | |
| 100-Pair | .63 (16.00) | .96 (24.40) | | | |
| 300-Pair | 1.07 (27.20) | | | | |

Coaxial Cable

| Size | Coax |
|---------|-------------|
| RG58/u | .19 (4.80) |
| RG59/u | .24 (6.10) |
| RG62A/u | .24 (6.10) |
| RG6/u | .27 (6.80) |
| RG11/u | .40 (10.20) |

Fiber Optic Distribution (62.5/125)

| Size | Non-Plenum | Plenum |
|-----------|-------------|-------------|
| 6 Strand | .26 (6.60) | .18 (4.60) |
| 8 Strand | .27 (6.90) | .18 (4.60) |
| 12 Strand | .28 (7.10) | .21 (5.30) |
| 18 Strand | .49 (12.4) | .47 (11.90) |
| 24 Strand | .54 (13.70) | .52 (13.2) |
| 36 Strand | .54 (13.70) | .52 (13.2) |
| 48 Strand | .59 (15.00) | .56 (14.2) |
| 72 Strand | .72 (18.30) | .71 (18.0) |

A. System Overview

B1. Cable Ties

B2. Cable Accessories

B3. Stainless Steel Ties

C1. Wiring Duct

C2. Surface Raceway

C3. Abrasion Protection

C4. Cable Management

D1. Terminals

D2. Power Connectors

D3. Grounding Connectors

E1. Labeling Systems

E2. Labels

E3. Pre-Printed & Write-On Markers

E4. Permanent Identification

E5. Lockout/Tagout & Safety Solutions

F. Index

PANDUIT® ELECTRICAL SOLUTIONS

| A. System Overview | Part Number | Page Number | Part Number | Page Number | Part Number | Page Number |
|---------------------------------------|-------------|-------------|--------------------|---------------|--------------------|--------------|
| B1. Cable Ties | C025X025YJT | E2.16 | C200X050YJT | E2.17 | CBR4I-M0 | B1.59 |
| | C038X038KBT | E2.16 | C200X100FJJ | E2.5 | CBR4LH-TL | B1.58 |
| | C038X038KCT | E2.16 | C200X100YJC | E1.8 | CBR4LH-TL0 | B1.59 |
| | C038X038YJD | E2.24 | C200X100YJD | E2.24 | CBR4LH-TL30 | B1.60 |
| | C038X038YJJ | E2.5 | C200X100YJJ | E2.5 | CBR4S-M | B1.58 |
| B2. Cable Accessories | C038X038YJT | E2.16 | C200X100YJT | E2.17 | CBR4S-M0 | B1.59 |
| | C038X038YLJ | E2.5 | C200X100YLJ | E2.5 | CBR4S-M30 | B1.60 |
| | C050X013KBT | E2.16 | C200X100YMC | E1.8 | CBR6LH-C | B1.58 |
| | C050X013KCT | E2.16 | C225X450FJJ | E2.5 | CBR6LH-C0 | B1.59 |
| | C050X044CBD | E2.24 | C2YL6 | C1.56 | CBR6LH-C30 | B1.60 |
| B3. Stainless Steel Ties | C050X044CBT | E2.16 | C300X025KBT | E2.17 | CC-720 | D1.87, D3.33 |
| | C050X044KBT | E2.16 | C300X025KCT | E2.17 | CCH100-S10-C | B2.40 |
| | C050X044KCT | E2.16 | C350X500FJJ | E2.5 | CCH112-S10-C | B2.40 |
| | C050X044YJD | E2.24 | C400X100CBD | E2.24 | CCH119-S10-C | B2.40 |
| | C050X044YJJ | E2.5 | C400X100CBT | E2.17 | CCH12-S10-C | B2.40 |
| C1. Wiring Duct | C050X044YJT | E2.16 | C400X100YJD | E2.24 | CCH125-S10-C | B2.40 |
| | C060X020CBD | E2.24 | C400X100YJJ | E2.5 | CCH138-S10-C | B2.40 |
| | C060X020CBT | E2.16 | C400X100YJT | E2.17 | CCH150-S10-C | B2.40 |
| | C060X020KBT | E2.16 | C400X200YJD | E2.24 | CCH19-S10-C | B2.40 |
| | C060X020KCT | E2.16 | C400X200YJJ | E2.5 | CCH25-S10-C | B2.40 |
| C2. Surface Raceway | C060X020TJT | E2.16 | C400X200YJT | E2.17 | CCH31-S10-C | B2.40 |
| | C060X020YJC | E1.8 | C400X400YJD | E2.24 | CCH38-S10-C | B2.40 |
| | C060X020YJD | E2.24 | C400X400YJJ | E2.5 | CCH44-S10-C | B2.40 |
| | C060X020YJJ | E2.5 | C400X400YJT | E2.17 | CCH50-S10-C | B2.40 |
| | C060X020YJT | E2.16 | C400X600PBT | E2.17 | CCH56-S10-C | B2.40 |
| C3. Abrasion Protection | C065X019KBT | E2.16 | C400X600YJT | E2.17 | CCH62-S10-C | B2.40 |
| | C065X019KCT | E2.16 | C400X600Y1 | E5.23 | CCH69-S10-C | B2.40 |
| | C075X025CBD | E2.24 | C400X600Y2 | E5.23 | CCH75-S10-C | B2.40 |
| | C075X025CBT | E2.16 | C4YL6 | C1.56 | CCH81-S10-C | B2.40 |
| | C075X025KBT | E2.16 | C500X700FJJ | E2.5 | CCH87-S10-C | B2.40 |
| C4. Cable Management | C075X025KCT | E2.16 | C850X1100YJJ | E2.5 | CCMKIT1 | C4.12 |
| | C075X025YJD | E2.24 | C850X1100YLJ | E2.5 | CCMKIT2 | C4.12 |
| | C075X025YJJ | E2.5 | CA-800EZ | D1.143 | CCS12-S8-C | B2.40 |
| | C075X025YJT | E2.16 | CA10 | D1.143 | CCS19-S8-C | B2.40 |
| | C075X025YLJ | E2.5 | CA3IW-X | C2.82 | CCS25-S10-C | B2.40 |
| D1. Terminals | C080X020KBT | E2.16 | CA5IW-X | C2.82 | CCS25-S8-C | B2.40 |
| | C080X020KCT | E2.16 | CA9 | D1.143 | CCS31-S8-C | B2.40 |
| | C080X020YJD | E2.24 | CAMT | B3.14 | CCS38-S8-C | B2.40 |
| | C080X020YJJ | E2.5 | CB125-14-QY | D2.145 | CCS44-S8-C | B2.40 |
| | C080X020YJT | E2.16 | CB175-38-QY | D2.145 | CCS50-S8-C | B2.40 |
| D2. Power Connectors | C090X025KBT | E2.16 | CB225-56-QY | D2.145 | CD125-14-QY | D2.144 |
| | C090X025KCT | E2.16 | CB25-18-CY | D2.145 | CD-2001-1 | D3.38 |
| | C100X019KBT | E2.16 | CB300-38-QY | D2.145 | CD-2001-1/0 | D3.38 |
| | C100X019KCT | E2.16 | CB35-36-CY | D2.145 | CD-2001-2 | D3.38 |
| | C100X025CBD | E2.24 | CB400-38-3Y | D2.145 | CD-2001-2/0 | D3.38 |
| D3. Grounding Connectors | C100X025CBT | E2.16 | CB650-12-3Y | D2.145 | CD-2001-250 | D3.38 |
| | C100X025KBT | E2.16 | CB70-14-CY | D2.145 | CD-2001-3/0 | D3.38 |
| | C100X025KCT | E2.16 | CBA70-14-CY | D2.145 | CD-2001-300 | D3.38 |
| | C100X025YJC | E1.8 | CBLS18-C | B2.46 | CD-2001-350 | D3.38 |
| | C100X025YJD | E2.24 | CBLS25-C | B2.46 | CD-2001-4 | D3.38 |
| E1. Labeling Systems | C100X025YJJ | E2.5 | CBLS37-C | B2.46 | CD-2001-4/0 | D3.38 |
| | C100X025YJT | E2.16 | CBLS50-C | B2.46 | CD-2001-400 | D3.38 |
| | C100X038KBT | E2.16 | CBLS62-C | B2.46 | CD-2001-500 | D3.38 |
| | C100X038KCT | E2.16 | CBLS75-C | B2.46 | CD-2001-6 | D3.38 |
| | C100X050CBC | E1.8 | CBP100-C | B2.46 | CD-2001-8 | D3.38 |
| E2. Labels | C100X050CBD | E2.24 | CBP12-C | B2.46 | CD-2001-BG | D3.38 |
| | C100X050CBT | E2.16 | CBP25-C | B2.46 | CD-2001-C | D3.38 |
| | C100X050YJC | E1.8 | CBP31-C | B2.46 | CD-2001-O | D3.38 |
| | C100X050YJD | E2.24 | CBP37-C | B2.46 | CD225-56-QY | D2.144 |
| | C100X050YJJ | E2.5 | CBP50-C | B2.46 | CD300-38-3Y | D2.144 |
| E3. Pre-Printed & Write-On Markers | C100X050YJT | E2.16 | CBP62-C | B2.46 | CD400-38-3Y | D2.144 |
| | C100X050YLJ | E2.5 | CBP75-C | B2.46 | CD650-12-3Y | D2.144 |
| | C100X050YMC | E1.8 | CBP87-C | B2.46 | CD70-14-QY | D2.144 |
| | C125X025KBT | E2.16 | CBR1.5I-M | B1.58 | CD-720-1 | D1.87, D3.33 |
| | C125X025KCT | E2.16 | CBR1.5I-M0 | B1.59 | CD-720-2 | D1.87, D3.33 |
| E4. Permanent Identification | C150X025KBT | E2.16 | CBR1.5I-M30 | B1.60 | CD-720-3 | D1.87, D3.33 |
| | C150X025KCT | E2.16 | CBR1.5M-M | B1.58 | CD-720-4 | D1.87, D3.33 |
| | C150X075YJC | E1.8 | CBR1.5M-M0 | B1.59 | CD-720-5 | D1.87, D3.33 |
| | C150X075YJD | E2.24 | CBR1M-M | B1.58 | CD-720-6 | D1.87, D3.33 |
| | C150X075YJJ | E2.5 | CBR1M-M0 | B1.59 | CD-720-7 | D1.87, D3.33 |
| E5. Lockout/Tagout & Safety Solutions | C150X075YJT | E2.16 | CBR1M-M30 | B1.60 | CD-720PV8-2 | D1.87, D3.33 |
| | C160X020CBD | E2.24 | CBR2HS-D | B1.58 | CD-800-1 | D1.145 |
| | C160X020CBT | E2.17 | CBR2HS-D0 | B1.59 | CD-800-10 | D1.145 |
| | C160X020KBT | E2.17 | CBR2M-M | B1.58 | CD-800-11 | D1.145 |
| | C160X020KCT | E2.17 | CBR2M-M0 | B1.59 | CD-800-12 | D1.145 |
| F. Index | C160X020YJD | E2.24 | CBR2S-M | B1.58 | CD-800-13 | D1.145 |
| | C160X020YJJ | E2.5 | CBR2S-M0 | B1.59 | CD-800-14 | D1.145 |
| | C160X020YJT | E2.17 | CBR2S-M30 | B1.60 | CD-800-15 | D1.145 |
| | C200X025KBT | E2.17 | CBR2S-M39 | B1.60 | CD-800-16 | D1.145 |
| | C200X025KCT | E2.17 | CBR3I-M | B1.58 | CD-800-17 | D1.145 |

PANDUIT® ELECTRICAL SOLUTIONS

| Part Number | Page Number | Part Number | Page Number | Part Number | Page Number |
|---------------|-----------------------|--------------------|-----------------------|---------------------|----------------------|
| CD-800-5 | D1.145 | CDM-920-4/0 | D3.46 | CO125-14-QY | D2.146 |
| CD-800-6 | D1.145 | CEFXIW-X | C2.81 | CO225-56-QY | D2.146 |
| CD-800-7 | D1.145 | CF10IW-X | C2.79 | CO300-38-3Y | D2.146 |
| CD-800-8 | D1.145 | CF382538F-Q | C3.12 | CO35-36-QY | D2.146 |
| CD-800-9 | D1.145 | CF3IW-E | C2.79 | CO400-38-3Y | D2.146 |
| CD-920-1 | D3.46 | CF502550F-Q | C3.12 | CO650-12-3Y | D2.146 |
| CD-920-1/0 | D3.46 | CF503850F-Q | C3.12 | CO70-14-QY | D2.146 |
| CD-920-2 | D3.46 | CF5IW-E | C2.79 | CP-871 | D1.144 |
| CD-920-2/0 | D3.46 | CF752575F-Q | C3.12 | CP106IW | C2.59 |
| CD-920-250 | D3.46 | CF753875F-Q | C3.12 | CP106IW-2G | C2.59 |
| CD-920-3/0 | D3.46 | CFX10IW-X | C2.75, C2.80, C2.81 | CPGIW | C2.59 |
| CD-920-300 | D3.46 | CFX3IW-X | C2.80, C2.81 | CPGIW-2G | C2.59 |
| CD-920-350 | D3.46 | CFX5IW-X | C2.80, C2.81 | CPH.75-S8-X | B2.48 |
| CD-920-4 | D3.46 | CG-920 | D3.51 | CPL.75-S8-X | B2.48 |
| CD-920-4/0 | D3.46 | CG-940 | D3.51 | CPM122S-C | B2.23 |
| CD-920-400 | D3.46 | CG-980 | D3.51 | CPM87S-C | B2.23 |
| CD-920-500 | D3.46 | CH105-A-C14 | B2.37 | CPNIW | C2.59 |
| CD-920-500A | D3.46 | CH105-S6-C14 | B2.37 | CPNIW-2G | C2.59 |
| CD-920-6 | D3.46 | CLRCVR1-1 | D3.8 | CR2-M | B2.26 |
| CD-920-600 | D3.46 | CLRCVR2-1 | D3.8 | CR4H-M | B2.26 |
| CD-920-750 | D3.46 | CLRCVR3-1 | D3.8 | CR4H-M0 | B2.26 |
| CD-920-8 | D3.46 | CLRCVR5-1 | D3.8 | CRFC5IW-X | C2.79, C2.80 |
| CD-920-BG | D3.46 | CLRCVR6-1 | D3.8 | CRFX5IW-X | C2.81 |
| CD-920-C | D3.46 | CLT100F-C20 | C3.11 | CROS-M | B2.26 |
| CD-920-D3 | D3.46 | CLT100F-C3 | C3.11 | CRS1-125-X | C4.9 |
| CD-920-O | D3.46 | CLT100N-C630 | C3.12 | CRS1-X | C4.9 |
| CD-920H-2 | D3.46 | CLT125F-L20 | C3.11 | CRS4-125-X | C4.9 |
| CD-920H-6 | D3.46 | CLT125F-L3 | C3.11 | CRS6-X | C4.9 |
| CD-920H-8 | D3.46 | CLT125F-L4 | C3.11 | CS125-14-QY | D2.143 |
| CD-930H-250 | D3.46 | CLT125N-L630 | C3.12 | CS175-38-QY | D2.143 |
| CD-940-1000 | D3.47 | CLT150F-T20 | C3.11 | CS1LG6 | C1.30 |
| CD-940-1000A | D3.47 | CLT150F-X20 | C3.11 | CS1WH6 | C1.30 |
| CD-940-750 | D3.47 | CLT150F-X3 | C3.11 | CS225-56-QY | D2.143 |
| CD-940-750A | D3.47 | CLT150F-X4 | C3.11 | CS25-18-CY | D2.143 |
| CD-940-750X | D3.47 | CLT150N-D630 | C3.12 | CS300-38-QY | D2.143 |
| CD-940-800 | D3.47 | CLT188F-X20 | C3.11 | CS35-36-CY | D2.143 |
| CD-940-800A | D3.47 | CLT188F-X3 | C3.11 | CS400-38-3Y | D2.143 |
| CD-940-DA | D3.47 | CLT188F-X4 | C3.11 | CS650-12-3Y | D2.143 |
| CD-940-N | D3.47 | CLT188N-6C630 | C3.12 | CS70-14-CY | D2.143 |
| CD-940H-1000 | D3.47 | CLT25F-C20 | C3.11 | CSA70-14-CY | D2.143 |
| CD-940H-500 | D3.47 | CLT25F-C3 | C3.11 | CSC1LG6 | C1.29 |
| CD-940H-750 | D3.47 | CLT25N-C630 | C3.12 | CSC1WH6 | C1.29 |
| CD10-1 | D1.143, D1.146 | CLT35N-C630 | C3.12 | CSCS-M | B2.27 |
| CD10-2 | D1.143, D1.146 | CLT38F-C20 | C3.11 | CSH-D0 | B2.26 |
| CD10-3 | D1.143, D1.146 | CLT38F-C3 | C3.11 | CSH-D20 | B2.26 |
| CD9-10A | D1.146 | CLT38N-C630 | C3.12 | CSP1.5LG-Q | C1.30 |
| CD9-10B | D1.146 | CLT50F-C20 | C3.11 | CSP1LG-Q | C1.30 |
| CD9-11A | D1.146 | CLT50F-C3 | C3.11 | CSP2LG-Q | C1.30 |
| CD9-11B | D1.146 | CLT50N-C630 | C3.12 | CSP3LG-Q | C1.30 |
| CD9-12A | D1.146 | CLT75F-C20 | C3.11 | CSP4LG-Q | C1.30 |
| CD9-13B | D1.146 | CLT75F-C3 | C3.11 | CSPC1.5LG-Q | C1.29 |
| CD9-14A | D1.146 | CLT75N-C630 | C3.12 | CSPC1LG-Q | C1.29 |
| CD9-15A | D1.146 | CLTS100F-C | C3.12 | CSPC2LG-Q | C1.29 |
| CD9-16A | D1.146 | CLTS100F-C3 | C3.12 | CSPC3LG-Q | C1.29 |
| CD9-17B | D1.146 | CLTS100N-C | C3.12 | CSPC4LG-Q | C1.29 |
| CD9-18B | D1.146 | CLTS125F-L | C3.12 | CST101 | D3.34 |
| CD9-1A | D1.146 | CLTS125F-L3 | C3.12 | CST114-157 | D3.34 |
| CD9-1AD | D1.146 | CLTS150F-D3 | C3.12 | CST115 | D1.83, D3.34 |
| CD9-1B | D1.146 | CLTS25F-C | C3.12 | CT-100 | D1.83 |
| CD9-2A | D1.146 | CLTS25F-C3 | C3.12 | CT-1000 | D1.86, D1.142 |
| CD9-2AD | D1.146 | CLTS25N-C | C3.12 | CT-1002 | D1.85 |
| CD9-2B | D1.146 | CLTS35N-C | C3.12 | CT-1003 | D1.85 |
| CD9-3B | D1.146 | CLTS38F-C | C3.12 | CT-1004 | D1.85 |
| CD9-4A | D1.146 | CLTS38F-C3 | C3.12 | CT-1005 | D1.85 |
| CD9-4B | D1.146 | CLTS38N-C | C3.12 | CT-1006 | D1.85 |
| CD9-5A | D1.146 | CLTS50F-C | C3.12 | CT-1014 | D1.84 |
| CD9-5B | D1.146 | CLTS50F-C3 | C3.12 | CT-1015 | D1.84 |
| CD9-6B | D1.146 | CLTS50N-C | C3.12 | CT-1104 | D1.85 |
| CD9-7A | D1.146 | CLTS75F-C | C3.12 | CT-1123 | D1.85 |
| CD9-8B | D1.146 | CLTS75F-C3 | C3.12 | CT-1525 | D1.84 |
| CD9-9C | D1.146 | CLTS75N-C | C3.12 | CT-1550 | D1.84 |
| CDCLP3 | C1.5 | CM4S-L2 | B1.80 | CT-1551 | D1.84 |
| CDCLP4 | C1.5 | CM4S-L8 | B1.80 | CT-1570 | D1.84 |
| CDLB3 | C1.5 | CMP-100-1 | D2.123, D2.161, D3.21 | CT-160 | D1.83 |
| CDLB4 | C1.5 | CMP-200-1 | D2.123, D3.21 | CT-1700 | D1.84 |
| CDM-2001-1 | D3.38 | CMP-300-1 | D3.21 | CT-1701 | D1.84 |
| CDM-2001-1/0 | D3.38 | CMP-300-4-1 | D3.21 | CT-200 | D1.83 |
| CDM-2001-2 | D3.38 | CMVDR1 | C4.10 | CT-2001 | D3.36 |
| CDM-2001-2/0 | D3.38 | CMVDR1S | C4.10 | CT-2002 | D3.37 |
| CDM-2001-3/0 | D3.38 | CMVDR2 | C4.10 | CT-2500 | D1.88 |
| CDM-920-1 | D3.46 | CMVDR2S | C4.10 | CT-2500/E | D1.88 |
| CDM-920-1/0 | D3.46 | CMVDRC | C4.10 | CT-2500BC | D1.88 |
| CDM-920-2 | D3.46 | CMW-KIT | C4.8 | CT-2500CASE | D1.88 |
| CDM-920-2/0 | D3.46 | CMW2B | C4.9 | CT-2500CHR | D1.88 |
| CDM-920-250 | D3.46 | CMWB | C4.8 | CT-2500CHR/E | D1.88 |
| CDM-920-3/0 | D3.46 | CMWW | C4.8 | CT-2525CH | D1.88 |

| |
|---------------------------------------|
| A. System Overview |
| B1. Cable Ties |
| B2. Cable Accessories |
| B3. Stainless Steel Ties |
| C1. Wiring Duct |
| C2. Surface Raceway |
| C3. Abrasion Protection |
| C4. Cable Management |
| D1. Terminals |
| D2. Power Connectors |
| D3. Grounding Connectors |
| E1. Labeling Systems |
| E2. Labels |
| E3. Pre-Printed & Write-On Markers |
| E4. Permanent Identification |
| E5. Lockout/Tagout & Safety Solutions |
| F. Index |

PANDUIT® ELECTRICAL SOLUTIONS

| A. System Overview | Part Number | Page Number | Part Number | Page Number | Part Number | Page Number |
|------------------------------------|------------------------|----------------|------------------------|---------------|------------------------|---------------|
| B1. Cable Ties | CT-2550CH | D1.88 | D10-250M-L | D1.53 | DMNF2-63FIB-3K | D1.133 |
| | CT-2570CH | D1.88 | D100H2 | C1.26 | DMNF2-63FIB-C | D1.57 |
| B2. Cable Accessories | CT-260 | D1.83 | D14-145M-C | D1.55 | DMNF2-63FIBX-2K | D1.134 |
| | CT-2931 | D3.39 | D14-187-C | D1.49 | DMNF2-63FIM-2K | D1.136 |
| | CT-2940 | D3.40 | D14-188-C | D1.49 | DMNF2-63FIM-C | D1.59 |
| | CT-2981 | D3.49 | D14-250-C | D1.49 | DMNF2-63FIMB-K | D1.136 |
| | CT-300-1 | D1.85 | D14-250MB-C | D1.53 | DMNF2-63FIMX-2K | D1.137 |
| | CT-310 | D1.85 | D18-145M-C | D1.55 | DMNF2-63M-3K | D1.137 |
| | CT-400 | D1.86 | D18-187-C | D1.49 | DMNF2-63M-C | D1.59 |
| | CT-460 | D1.86 | D18-188-C | D1.49 | DMNF2485FIBX-2K | D1.134 |
| | CT-500CH | D1.86 | D18-250-C | D1.49 | DMNF2488FIBX-2K | D1.134 |
| | CT-520CH | D1.86 | D18-250MB-C | D1.53 | DMNF6-63FI-L | D1.57 |
| B3. Stainless Steel Ties | CT-550CH | D1.86 | D1H6 | C1.26 | DMNF6-63FIB-2K | D1.133 |
| | CT-570CH | D1.86 | D1X2LG6 | C1.13 | DMNF6-63M-2K | D1.137 |
| | CT-600-A | D1.86 | D1X3LG6 | C1.13 | DMNF6-63M-L | D1.59 |
| | CT-720 | D1.87, D3.33 | D1X4LG6 | C1.13 | DMNFR1485FIB-KD | D1.134 |
| | CT-720-3 | D3.34 | D2.5X3LG6 | C1.13 | DMNFR1488FIB-KD | D1.134 |
| | CT-720-3CC | D3.34 | D2H6 | C1.26 | DMNFR163FIB-KD | D1.134 |
| | CT-720-7 | D3.34 | D2HWH6 | C1.26 | DMNFR2485FIB-KD | D1.134 |
| | CT-720-7CC | D3.34 | D2X2LG6 | C1.13 | DMNFR2488FIB-KD | D1.134 |
| | CT-8250HP | D3.45 | D2X3LG6 | C1.13 | DMNFR263FIB-KD | D1.134 |
| | CT-900HPH | D3.43 | D2X4LG6 | C1.13 | DMNG1-485FB-3K | D1.132 |
| C1. Wiring Duct | CT-900LPHPH | D3.45 | D3H6 | C1.26 | DMNG1-488FB-3K | D1.132 |
| | CT-901HP | D3.43 | D3HWH6 | C1.26 | DMNG1-63FB-3K | D1.132 |
| | CT-901RCH | D3.43 | D3X2LG6 | C1.13 | DMNG1-63FL-3K | D1.133 |
| | CT-901RFS | D3.43, D3.45 | D3X3LG6 | C1.13 | DMNG2-485FB-3K | D1.132 |
| | CT-930 | D3.35 | D3X4LG6 | C1.13 | DMNG2-488FB-3K | D1.132 |
| | CT-930CH | D3.41 | D4H6 | C1.26 | DMNG2-63FB-3K | D1.132 |
| | CT-930LPCH | D3.44 | D4HWH6 | C1.26 | DMNG2-63FL-3K | D1.133 |
| | CT-940CH | D3.42 | D4X2LG6 | C1.13 | DMPF1-285FIB-3K | D1.135 |
| | CT-980 | D3.48 | D4X3LG6 | C1.13 | DMPF1-288FIB-3K | D1.135 |
| | CT-980CH | D3.50 | D4X4LG6 | C1.13 | DMPF1-485FIB-3K | D1.135 |
| C2. Surface Raceway | CT-980LPCH | D3.50 | D50H2 | C1.26 | DMPF1-488FIB-3K | D1.135 |
| | CT-BC25 | D3.51 | D75H2 | C1.26 | DMPF1-63FIB-3K | D1.135 |
| | CT-CHR25 | D3.51 | DB-C | C1.26 | DMPF1-63FIM-2K | D1.136 |
| | CT-NLBC25 | D3.51 | DC450-38-3Y | D2.145 | DMPF1-63FIMB-K | D1.136 |
| | CTAP2-2-X | D3.7 | DC600-38-3Y | D2.145 | DMPF2-488FIB-3K | D1.135 |
| | CTAP2-4-Q | D3.7 | DC800-12-3Y | D2.145 | DMPF2-485FIB-3K | D1.135 |
| | CTAP2/0-2-X | D3.7 | DCEFXIW-X | C2.80, C2.81 | DMPF2-63FIB-3K | D1.135 |
| | CTAP2/0-2/0-X | D3.7 | DCF10IW-X | C2.79 | DMPF2-63FIM-2K | D1.136 |
| | CTAP4-4-L | D3.7 | DCF3IW-X | C2.79 | DMPF2-63FIMB-K | D1.136 |
| | CTAP4-6-L | D3.7 | DCF5IW-X | C2.79 | DMPF6-63FIB-2K | D1.135 |
| C3. Abrasion Protection | CTAP4-8-L | D3.7 | DCT | C1.34 | DMV1-37MB-3K | D1.139 |
| | CTAP4/0-2-X | D3.7 | DCT-BLD | C1.34 | DMV1-485B-3K | D1.135 |
| | CTAP4/0-2/0-X | D3.7 | DCT-RI | C1.34 | DMV1-488B-3K | D1.135 |
| | CTAP4/0-4/0-X | D3.7 | DFCT | C1.34 | DMV1-63B-3K | D1.135 |
| | CTAPF1-12-C | D3.6 | DHC1.12X1.75-D0 | B1.78 | DMV1-63MB-3K | D1.138 |
| | CTAPF1/0-12-L | D3.6 | DJS1LG6 | C1.30 | DMV1-63P-CY | D1.59 |
| | CTAPF10-16-C | D3.6 | DJS1WH6 | C1.30 | DMV2-37MB-3K | D1.139 |
| | CTAPF2-12-C | D3.6 | DM1-488-C | D1.58 | DMV2-485B-3K | D1.135 |
| | CTAPF2/0-12-Q | D3.6 | DM1-63-C | D1.58 | DMV2-488B-3K | D1.135 |
| | CTAPF3-12-C | D3.6 | DM1-63M-C | D1.60 | DMV2-63B-3K | D1.135 |
| C4. Cable Management | CTAPF3/0-12-Q | D3.6 | DM2-488-C | D1.58 | DMV2-63MB-3K | D1.138 |
| | CTAPF4-12-C | D3.6 | DM2-63-C | D1.58 | DMV2-63P-C | D1.59 |
| | CTAPF6-12-C | D3.6 | DM2-63M-C | D1.60 | DMV6-63-2K | D1.135 |
| | CTAPF8-12-C | D3.6 | DM6-63-L | D1.58 | DMV6-63-L | D1.58 |
| | CW-12-Q | D2.118, D2.161 | DM6-63M-L | D1.60 | DMV6-63M-2K | D1.138 |
| | CW-14-L | D2.118, D2.161 | DMNF1-283FIB-3K | D1.133 | DNF10-250FI-L | D1.44, D1.45 |
| | CW-38-L | D2.118, D2.161 | DMNF1-285-C | D1.58 | DNF10-250FIB-2K | D1.123 |
| | CW-56-L | D2.118, D2.161 | DMNF1-285FIB-3K | D1.133 | DNF10-250FIB-L | D1.45 |
| | CW-58-Q | D2.118, D2.161 | DMNF1-285FIB-C | D1.57 | DNF10-250FIMB-K | D1.128 |
| | CWD3LG6 | C1.5 | DMNF1-288-C | D1.58 | DNF10-250FIMB-L | D1.44 |
| D1. Terminals | CWD3WH6 | C1.5 | DMNF1-288FIB-3K | D1.133 | DNF10-250M-2K | D1.129 |
| | CWD4LG6 | C1.5 | DMNF1-288FIB-C | D1.57 | DNF10-250M-L | D1.52 |
| | CWD4WH6 | C1.5 | DMNF1-485FIB-3K | D1.133 | DNF10250FIBC-2K | D1.123 |
| | CWF400 | C4.8 | DMNF1-488-C | D1.58 | DNF14-110-C | D1.47 |
| | CX125-14-QY | D2.142 | DMNF1-488FIB-3K | D1.133 | DNF14-111-C | D1.47 |
| | CX125-56T-QY | D2.142 | DMNF1-488FIB-C | D1.57 | DNF14-187-C | D1.47 |
| | CX225-38T-QY | D2.142 | DMNF1-63-C | D1.58 | DNF14-187FIB-3K | D1.123 |
| | CX225-56-QY | D2.142 | DMNF1-63FIB-3K | D1.133 | DNF14-187FIB-C | D1.45 |
| | CX225-56T-QY | D2.142 | DMNF1-63FIB-C | D1.57 | DNF14-188-C | D1.47 |
| | CX35-36-CY | D2.142 | DMNF1-63FIBX-2K | D1.134 | DNF14-188FIB-3K | D1.123 |
| D2. Power Connectors | CX35-36T-CY | D2.142 | DMNF1-63FIM-2K | D1.136 | DNF14-188FIB-C | D1.45 |
| | CX400-12T-3Y | D2.142 | DMNF1-63FIM-C | D1.59 | DNF14-205-C | D1.47 |
| | CX400-38-3Y | D2.142 | DMNF1-63FIMB-K | D1.136 | DNF14-205FIB-3K | D1.123 |
| | CX70-14-CY | D2.142 | DMNF1-63FIMX-2K | D1.137 | DNF14-205FIB-C | D1.45 |
| | CX70-14T-CY | D2.142 | DMNF1-63M-3K | D1.137 | DNF14-206-C | D1.47 |
| | DMNF1-63M-C | D1.59 | DMNF1485FIBX-2K | D1.134 | DNF14-206FIB-3K | D1.123 |
| | DMNF1485FIBX-2K | D1.134 | DMNF1488FIBX-2K | D1.134 | DNF14-206FIB-C | D1.45 |
| | DMNF1488FIBX-2K | D1.134 | DMNF2-288-C | D1.58 | DNF14-250-C | D1.47 |
| | DMNF2-485FIB-3K | D1.133 | DMNF2-485FIB-3K | D1.133 | DNF14-250FI-C | D1.45 |
| | DMNF2-488-C | D1.58 | DMNF2-488FIB-3K | D1.133 | DNF14-250FIB-C | D1.45 |
| D3. Grounding Connectors | DMNF2-488FIB-3K | D1.58 | DMNF2-488FIB-C | D1.57 | DNF14-250FIM-2K | D1.128 |
| | DMNF2-63FIB-3K | D1.133 | DMNF2-488FIB-C | D1.57 | DNF14-250FIM-C | D1.44 |
| | DMNF2-63FIM-2K | D1.136 | DMNF2-485FIB-3K | D1.133 | DNF14-250FIM-L | D1.128 |
| | DMNF2-63FIMB-K | D1.136 | DMNF2-488FIB-3K | D1.133 | DNF14-250FIM-K | D1.128 |
| | DMNF2-63FIMX-2K | D1.137 | DMNF2-488FIB-C | D1.57 | DNF14-250FIMB-K | D1.128 |
| | DMNF2-63M-3K | D1.137 | DMNF2-488FIB-C | D1.57 | DNF14-250FIMB-L | D1.128 |
| | DMNF2-63M-C | D1.59 | DMNF2-488FIB-C | D1.57 | DNF14-250FIMB-K | D1.128 |
| | DMNF2-63M-L | D1.58 | DMNF2-488FIB-C | D1.57 | DNF14-250FIMB-L | D1.128 |
| | DMNF2-63M-L | D1.58 | DMNF2-488FIB-C | D1.57 | DNF14-250FIMB-K | D1.128 |
| | DMNF2-63M-L | D1.58 | DMNF2-488FIB-C | D1.57 | DNF14-250FIMB-L | D1.128 |
| E1. Labeling Systems | DMNF2-63M-L | D1.58 | DMNF2-488FIB-C | D1.57 | DNF14-250FIMB-K | D1.128 |
| | DMNF2-63M-L | D1.58 | DMNF2-488FIB-C | D1.57 | DNF14-250FIMB-L | D1.128 |
| | DMNF2-63M-L | D1.58 | DMNF2-488FIB-C | D1.57 | DNF14-250FIMB-K | D1.128 |
| | DMNF2-63M-L | D1.58 | DMNF2-488FIB-C | D1.57 | DNF14-250FIMB-L | D1.128 |
| | DMNF2-63M-L | D1.58 | DMNF2-488FIB-C | D1.57 | DNF14-250FIMB-K | D1.128 |
| | DMNF2-63M-L | D1.58 | DMNF2-488FIB-C | D1.57 | DNF14-250FIMB-L | D1.128 |
| | DMNF2-63M-L | D1.58 | DMNF2-488FIB-C | D1.57 | DNF14-250FIMB-K | D1.128 |
| | DMNF2-63M-L | D1.58 | DMNF2-488FIB-C | D1.57 | DNF14-250FIMB-L | D1.128 |
| | DMNF2-63M-L | D1.58 | DMNF2-488FIB-C | D1.57 | DNF14-250FIMB-K | D1.128 |
| | DMNF2-63M-L | D1.58 | DMNF2-488FIB-C | D1.57 | DNF14-250FIMB-L | D1.128 |
| E2. Labels | DMNF2-63M-L | D1.58 | DMNF2-488FIB-C | D1.57 | DNF14-250FIMB-K | D1.128 |
| | DMNF2-63M-L | D1.58 | DMNF2-488FIB-C | D1.57 | DNF14-250FIMB-L | D1.128 |
| | DMNF2-63M-L | D1.58 | DMNF2-488FIB-C | D1.57 | DNF14-250FIMB-K | D1.128 |
| | DMNF2-63M-L | D1.58 | DMNF2-488FIB-C | D1.57 | DNF14-250FIMB-L | D1.128 |
| | DMNF2-63M-L | D1.58 | DMNF2-488FIB-C | D1.57 | DNF14-250FIMB-K | D1.128 |
| | DMNF2-63M-L | D1.58 | DMNF2-488FIB-C | D1.57 | DNF14-250FIMB-L | D1.128 |
| | DMNF2-63M-L | D1.58 | DMNF2-488FIB-C | D1.57 | DNF14-250FIMB-K | D1.128 |
| | DMNF2-63M-L | D1.58 | DMNF2-488FIB-C | D1.57 | DNF14-250FIMB-L | D1.128 |
| | DMNF2-63M-L | D1.58 | DMNF2-488FIB-C | D1.57 | DNF14-250FIMB-K | D1.128 |
| | DMNF2-63M-L | D1.58 | DMNF2-488FIB-C | D1.57 | DNF14-250FIMB-L | D1.128 |
| E3. Pre-Printed & Write-On Markers | DMNF2-63M-L | D1.58 | DMNF2-488FIB-C | D1.57 | DNF14-250FIMB-K | D1.128 |
| | DMNF2-63M-L | D1.58 | DMNF2-488FIB-C | D1.57 | DNF14-250FIMB-L | D1.128 |
| | DMNF2-63M-L | D1.58 | DMNF2-488FIB-C | D1.57 | DNF14-250FIMB-K | D1.128 |
| | DMNF2-63M-L | D1.58 | DMNF2-488FIB-C | D1.57 | DNF14-250FIMB-L | D1.128 |
| | DMNF2-63M-L | D1.58 | DMNF2-488FIB-C | D1.57 | DNF14-250FIMB-K | D1.128 |
| | DMNF2-63M-L | D1.58 | DMNF2-488FIB-C | D1.57 | DNF14-250FIMB-L | D1.128 |
| | DMNF2-63M-L | D1.58 | DMNF2-488FIB-C | D1.57 | DNF14-250FIMB-K | D1.128 |
| | DMNF2-63M-L | D1.58 | DMNF2-488FIB-C | D1.57 | DNF14-250FIMB-L | D1.128 |
| | DMNF2-63M-L | D1.58 | DMNF2-488FIB-C | D1.57 | DNF14-250FIMB-K | D1.128 |
| | DMNF2-63M-L | D1.58 | DMNF2-488FIB-C | D1.57 | DNF14-250FIMB-L | D1.128 |
| E4. Permanent Identification | DMNF2-63M-L | D1.58 | DMNF2-488FIB-C | D1.57 | DNF14-250FIMB-K | D1.128 |
| | DMNF2-63M-L | D1.58 | DMNF2-488FIB-C | D1.57 | DNF14-250FIMB-L | D1.128 |
| | DMNF2-63M-L | D1.58 | DMNF2-488FIB-C | D1.57 | DNF14-250FIMB-K | D1.128 |
| | DMNF2-63M-L | D1.58 | DMNF2-488FIB-C | D1.57 | DNF14-250FIMB-L | D1.128 |
| | DMNF2-63M-L | D1.58 | DMNF2-488FIB-C | D1.57 | DNF14-250FIMB-K | D1.128 |
| | DMNF2-63M-L | D1.58 | DMNF2-488FIB-C | D1.57 | DNF14-250FIMB-L | D1.128 |
| | DMNF2-63M-L | | | | | |

PANDUIT® ELECTRICAL SOLUTIONS

| Part Number | Page Number |
|-----------------|--------------|
| DNF14-250FIMB-L | D1.44 |
| DNF14-250M-3K | D1.129 |
| DNF14-250M-C | D1.52 |
| DNF14205FIBX-2K | D1.124 |
| DNF14206FIBX-2K | D1.124 |
| DNF14250FIBX-2K | D1.124 |
| DNF14250FIMX-2K | D1.128 |
| DNF18-110-C | D1.47 |
| DNF18-110FIB-3K | D1.123 |
| DNF18-110FIB-C | D1.45 |
| DNF18-111-C | D1.47 |
| DNF18-111FIB-3K | D1.123 |
| DNF18-111FIB-C | D1.45 |
| DNF18-112FIB-3K | D1.123 |
| DNF18-187-C | D1.47 |
| DNF18-187FIB-3K | D1.123 |
| DNF18-187FIB-C | D1.45 |
| DNF18-188-C | D1.47 |
| DNF18-188FIB-3K | D1.123 |
| DNF18-188FIB-C | D1.45 |
| DNF18-205-C | D1.47 |
| DNF18-205FIB-3K | D1.123 |
| DNF18-205FIB-C | D1.45 |
| DNF18-206-C | D1.47 |
| DNF18-206FIB-3K | D1.123 |
| DNF18-206FIB-C | D1.45 |
| DNF18-250-C | D1.47 |
| DNF18-250FI-C | D1.45 |
| DNF18-250FIB-3K | D1.123 |
| DNF18-250FIB-C | D1.44, D1.45 |
| DNF18-250FIM-2K | D1.128 |
| DNF18-250FIM-C | D1.44 |
| DNF18-250FIMB-K | D1.128 |
| DNF18-250FIMB-L | D1.44 |
| DNF18-250M-3K | D1.129 |
| DNF18-250M-C | D1.52 |
| DNF18205FIBX-2K | D1.124 |
| DNF18206FIBX-2K | D1.124 |
| DNF18250FIBX-2K | D1.124 |
| DNF18250FIMX-2K | D1.128 |
| DNFR14-205B-C | D1.50 |
| DNFR14-205FIB-C | D1.49 |
| DNFR14-206B-C | D1.50 |
| DNFR14-206FIB-C | D1.49 |
| DNFR14-250B-C | D1.50 |
| DNFR14-250FIB-C | D1.49 |
| DNFR14205FIB-KD | D1.124 |
| DNFR14206FIB-KD | D1.124 |
| DNFR14250FIB-KD | D1.124 |
| DNFR18-205B-C | D1.50 |
| DNFR18-205FIB-C | D1.49 |
| DNFR18-206B-C | D1.50 |
| DNFR18-206FIB-C | D1.49 |
| DNFR18-250B-C | D1.50 |
| DNFR18-250FIB-C | D1.49 |
| DNFR18205FIB-KD | D1.124 |
| DNFR18206FIB-KD | D1.124 |
| DNFR18250FIB-KD | D1.124 |
| DNG14-187FB-3K | D1.122 |
| DNG14-187FB-C | D1.43 |
| DNG14-188FB-3K | D1.122 |
| DNG14-188FB-C | D1.43 |
| DNG14-250FB-3K | D1.122 |
| DNG14-250FB-C | D1.43 |
| DNG14-250FL-3K | D1.123 |
| DNG14-250FL-C | D1.44 |
| DNG18-187FB-3K | D1.122 |
| DNG18-187FB-C | D1.43 |
| DNG18-188FB-3K | D1.122 |
| DNG18-188FB-C | D1.43 |
| DNG18-250FB-3K | D1.122 |
| DNG18-250FB-C | D1.43 |
| DNG18-250FL-3K | D1.123 |
| DNG18-250FL-C | D1.44 |
| DNH10-250FI-E | D1.47 |
| DNH14-250FIB-Q | D1.47 |
| DNH14-250FIM-Q | D1.47 |
| DNH18-250FIB-Q | D1.47 |
| DNH18-250FIM-Q | D1.47 |
| DNT-100 | C1.34 |
| DPF10-250FI-L | D1.46 |
| DPF10-250FIB-2K | D1.126 |
| DPF10-250FIB-L | D1.46 |
| DPF14-187FIB-3K | D1.126 |
| DPF14-205FIB-3K | D1.126 |
| DPF14-205FIB-C | D1.46 |

| Part Number | Page Number |
|-----------------|--------------|
| DPF14-206FIB-3K | D1.126 |
| DPF14-206FIB-C | D1.46 |
| DPF14-250FIB-3K | D1.126 |
| DPF14-250FIB-C | D1.46 |
| DPF14-250FIM-2K | D1.127 |
| DPF14-250FIM-C | D1.46 |
| DPF14-250FIMB-K | D1.127 |
| DPF14-250FIMB-L | D1.46 |
| DPF18-110FIB-3K | D1.126 |
| DPF18-110FIB-C | D1.46 |
| DPF18-111FIB-3K | D1.126 |
| DPF18-111FIB-C | D1.46 |
| DPF18-187FIB-3K | D1.126 |
| DPF18-187FIB-C | D1.46 |
| DPF18-188FIB-3K | D1.126 |
| DPF18-205FIB-3K | D1.126 |
| DPF18-205FIB-C | D1.46 |
| DPF18-206FIB-3K | D1.126 |
| DPF18-206FIB-C | D1.46 |
| DPF18-250FIB-3K | D1.126 |
| DPF18-250FIB-C | D1.46 |
| DPF18-250FIM-2K | D1.127 |
| DPF18-250FIM-C | D1.46 |
| DPF18-250FIMB-K | D1.127 |
| DPF18-250FIMB-L | D1.46 |
| DR10-250-L | D1.50 |
| DR14-205-C | D1.50 |
| DR14-205B-C | D1.51 |
| DR14-206-C | D1.50 |
| DR14-206B-C | D1.51 |
| DR14-250-C | D1.50 |
| DR14-250B-C | D1.51 |
| DR18-205-C | D1.50 |
| DR18-205B-C | D1.51 |
| DR18-206-C | D1.50 |
| DR18-206B-C | D1.51 |
| DR18-250-C | D1.50 |
| DR18-250B-C | D1.51 |
| DS1 | C3.16 |
| DS5 | C3.16 |
| DSF-NP | D1.144 |
| DSF-RS | D1.144 |
| DT14EH-L0 | B1.53 |
| DT15EH-L0 | B1.53 |
| DT28EH-C0 | B1.53 |
| DT44EH-C0 | B1.53 |
| DT4EH-L0 | B1.53 |
| DT8EH-Q0 | B1.53 |
| DTHEH-Q0 | B1.53 |
| DTHH-Q0 | B1.53 |
| DTKEH-O | B1.53 |
| DTKH-O | B1.53 |
| DTREH-LR0 | B1.53 |
| DTRH-LR0 | B1.53 |
| DV10-250-2K | D1.125 |
| DV10-250-L | D1.48 |
| DV10-250C-2K | D1.125 |
| DV10-250M-2K | D1.129 |
| DV10-250M-L | D1.52 |
| DV14-145M-C | D1.55 |
| DV14-145MB-3K | D1.130 |
| DV14-187B-3K | D1.125 |
| DV14-187B-C | D1.48 |
| DV14-188B-3K | D1.125 |
| DV14-188B-C | D1.48 |
| DV14-205B-3K | D1.125 |
| DV14-205B-C | D1.48 |
| DV14-206B-3K | D1.125 |
| DV14-206B-C | D1.48 |
| DV14-250B-3K | D1.125 |
| DV14-250B-C | D1.48 |
| DV14-250MB-3K | D1.129 |
| DV14-250MB-C | D1.52 |
| DV14-250P-C | D1.51 |
| DV18-145M-CY | D1.55 |
| DV18-145MB-3K | D1.130 |
| DV18-187B-3K | D1.125 |
| DV18-187B-CY | D1.48 |
| DV18-188B-3K | D1.125 |
| DV18-188B-CY | D1.48 |
| DV18-205B-3K | D1.125 |
| DV18-205B-CY | D1.48 |
| DV18-206B-3K | D1.125 |
| DV18-206B-CY | D1.48 |
| DV18-250B-3K | D1.125 |
| DV18-250B-CY | D1.48 |
| DV18-250MB-3K | D1.129 |

| Part Number | Page Number |
|---------------|-------------|
| DV18-250MB-CY | D1.52 |
| DV18-250P-CY | D1.51 |
| DVF14-187-C | D1.48 |
| DVF14-188-C | D1.48 |
| DVF14-205-C | D1.48 |
| DVF14-206-C | D1.48 |
| DVF14-250-C | D1.48 |
| DVF18-187-CY | D1.48 |
| DVF18-188-CY | D1.48 |
| DVF18-205-CY | D1.48 |
| DVF18-206-CY | D1.48 |
| DVF18-250-CY | D1.48 |

| E | |
|----------------|---------------------|
| E2X2YL6 | C1.56 |
| E4X4YL6 | C1.56 |
| ECF10IW-X | C2.79 |
| ECF3IW-E | C2.79 |
| ECF5IW-E | C2.79 |
| ECFX10IW-X | C2.75, C2.80, C2.81 |
| ECFX3IW-X | C2.80, C2.81 |
| ECFX5IW-X | C2.80, C2.81 |
| EDU20IW-X | C2.60 |
| EEFXIW | C2.75 |
| EGU20IW-X | C2.60 |
| EMA-X | B2.8 |
| EMS-A-C | B2.7 |
| EMS-A-C0 | B2.7 |
| EMSK12-4-12-X0 | B2.8 |
| EMSK3-1-3-0 | B2.8 |
| EMSK3-1-X0 | B2.8 |
| ER.5-E4-X | B2.47 |
| ER1.25-E4-X | B2.47 |
| ERU20IW-X | C2.60 |
| ETU20IW-X | C2.60 |

| F | |
|-------------|--------------|
| F5X.5LG6 | C1.11 |
| F5X1LG6 | C1.11 |
| F.75X.75LG6 | C1.11, C1.13 |
| F.75X1.5LG6 | C1.11 |
| F1.5X1.5LG6 | C1.11 |
| F1.5X1LG6 | C1.11 |
| F1.5X2LG6 | C1.11 |
| F1.5X3LG6 | C1.11 |
| F1.5X4LG6 | C1.11 |
| F14PN-L | C1.59 |
| F14PWN-L | C1.59 |
| F1X1.5LG6 | C1.11 |
| F1X1LG6 | C1.11 |
| F1X2LG6 | C1.11 |
| F1X3LG6 | C1.11 |
| F1X4LG6 | C1.11 |
| F2.5X3LG6 | C1.11 |
| F2PCLB12 | C1.61 |
| F2PCLB58 | C1.61 |
| F2X1.5LG6 | C1.11 |
| F2X1LG6 | C1.11 |
| F2X2LG6 | C1.11 |
| F2X3LG6 | C1.11 |
| F2X4LG6 | C1.11 |
| F2X5LG6 | C1.11 |
| F3X1LG6 | C1.11 |
| F3X2LG6 | C1.11 |
| F3X3LG6 | C1.11 |
| F3X4LG6 | C1.11 |
| F3X5LG6 | C1.11 |
| F4X2LG6 | C1.11 |
| F4X3LG6 | C1.11 |
| F4X4LG6 | C1.11 |
| F4X5LG6 | C1.11 |
| F73-5-M | D1.76 |
| F73-7-M | D1.76 |
| F74-5-M | D1.76 |
| F74-7-M | D1.76 |
| F75-10-M | D1.76 |
| F75-6-M | D1.76 |
| F75-8-M | D1.76 |
| F76-10-M | D1.76 |
| F76-12-M | D1.76 |
| F76-6-M | D1.76 |
| F76-8-M | D1.76 |
| F77-10-M | D1.76 |
| F77-12-M | D1.76 |

| A. System Overview |
|---------------------------------------|
| B1. Cable Ties |
| B2. Cable Accessories |
| B3. Stainless Steel Ties |
| C1. Wiring Duct |
| C2. Surface Raceway |
| C3. Abrasion Protection |
| C4. Cable Management |
| D1. Terminals |
| D2. Power Connectors |
| D3. Grounding Connectors |
| E1. Labeling Systems |
| E2. Labels |
| E3. Pre-Printed & Write-On Markers |
| E4. Permanent Identification |
| E5. Lockout/Tagout & Safety Solutions |
| F. Index |

PANDUIT® ELECTRICAL SOLUTIONS

| A. System Overview | Part Number | Page Number | Part Number | Page Number | Part Number | Page Number |
|--------------------------|----------------|-------------|----------------------|----------------------|---------------------|----------------------|
| B1. Cable Ties | F77-6-M | D1.76 | FIDT2X2YL | C1.58 | FSD77-12-D | D1.73 |
| | F77-7-M | D1.76 | FIDT4X4BL | C1.58 | FSD77-6-D | D1.73 |
| | F77-8-M | D1.76 | FITF4X4B | C1.59 | FSD77-8-5K2 | D1.142 |
| | F78-10-M | D1.76 | FIV452X2YL | C1.57 | FSD77-8-D | D1.73 |
| | F78-12-M | D1.76 | FIV454X4YL | C1.57 | FSD77-8-DSL2 | D1.75, D1.141 |
| | F78-15-M | D1.76 | FIVRA2X2YL | C1.57 | FSD78-10-D | D1.73 |
| | F78-18-M | D1.76 | FIVRA4X4YL | C1.57 | FSD78-12-D | D1.73 |
| | F78-20-M | D1.76 | FL12X12LG-A | C1.26 | FSD78-18-D | D1.73 |
| | F78-7-M | D1.76 | FL25X25LG-A | C1.26 | FSD78-6-D | D1.73 |
| | F78-8-M | D1.76 | FL50X50LG-A | C1.26 | FSD78-8-5K0 | D1.142 |
| B2. Cable Accessories | F80-10-M | D1.76 | FLB | C1.60 | FSD78-8-D | D1.73 |
| | F80-12-M | D1.76 | FLB12X15 | C1.60 | FSD78-8-DSL0 | D1.75, D1.141 |
| | F80-15-M | D1.76 | FLB12X20 | C1.60 | FSD79-8-D | D1.73 |
| | F80-18-M | D1.76 | FLB58X15 | C1.60 | FSD80-12-D | D1.73 |
| | F80-20-M | D1.76 | FLB58X20 | C1.60 | FSD80-18-D | D1.73 |
| | F80-7-M | D1.76 | FLRB | C1.60 | FSD80-8-3K6 | D1.142 |
| | F80-8-M | D1.76 | FMWR-C | C1.29 | FSD80-8-D | D1.73 |
| | F81-10-M | D1.77 | FOV452X2YL | C1.57 | FSD80-8-DSL6 | D1.75, D1.141 |
| | F81-12-M | D1.77 | FOV454X4YL | C1.57 | FSD81-10-D | D1.73 |
| | F81-15-M | D1.77 | FOVRA2X2YL | C1.57 | FSD81-12-C | D1.73 |
| B3. Stainless Steel Ties | F81-18-M | D1.77 | FOVRA4X4YL | C1.57 | FSD81-18-C | D1.73 |
| | F81-20-M | D1.77 | FP2DCIW | C2.59 | FSD82-12-C | D1.73 |
| | F81-9-M | D1.77 | FP2RCIW | C2.59 | FSD82-18-C | D1.73 |
| | F82-10-M | D1.77 | FPC-600-A | D1.86 | FSD83-12-C | D1.73 |
| | F82-12-M | D1.77 | FRA2X2YL | C1.56 | FSD83-18-C | D1.73 |
| | F82-15-M | D1.77 | FRA4X4YL | C1.56 | FSD84-12-C | D1.73 |
| | F82-18-M | D1.77 | FRAFC58 | C1.61 | FSD84-18-C | D1.73 |
| | F82-20-M | D1.77 | FRF42YL | C1.57 | FSD85-16-L | D1.73 |
| | F83-12-D | D1.77 | FS.5X.5LG6NM | C1.17 | FSD85-18-L | D1.73 |
| | F83-15-D | D1.77 | FS.5X1LG6NM | C1.17 | FSD85-22-L | D1.73 |
| C1. Wiring Duct | F83-18-D | D1.77 | FS.75X.75LG6NM | C1.17 | FSD86-16-L | D1.73 |
| | F83-20-D | D1.77 | FS1.5X1.5LG6NM | C1.17 | FSD86-18-L | D1.73 |
| | F83-25-D | D1.77 | FS1.5X1LG6NM | C1.17 | FSD86-25-L | D1.73 |
| | F84-12-TL | D1.77 | FS1.5X2LG6NM | C1.17 | FSD87-20-L | D1.73 |
| | F84-15-TL | D1.77 | FS1.5X3LG6NM | C1.17 | FSD87-25-Q | D1.73 |
| | F84-18-TL | D1.77 | FS156-C | B2.50 | FSF72-6-D | D1.74 |
| | F84-20-TL | D1.77 | FS1X1.5LG6NM | C1.17 | FSF72-8-D | D1.74 |
| | F84-25-TL | D1.77 | FS1X1LG6NM | C1.17 | FSF73-6-D | D1.74 |
| | F84-32-TL | D1.77 | FS1X2LG6NM | C1.17 | FSF73-8-D | D1.74 |
| | F85-12-C | D1.77 | FS1X3LG6NM | C1.17 | FSF74-6-D | D1.74 |
| C2. Surface Raceway | F85-15-C | D1.77 | FS1X4LG6NM | C1.17 | FSF74-8-D | D1.74 |
| | F85-18-C | D1.77 | FS2X1.5LG6NM | C1.17 | FSF75-10-D | D1.74 |
| | F85-25-C | D1.77 | FS2X1LG6NM | C1.17 | FSF75-6-D | D1.74 |
| | F85-32-C | D1.77 | FS2X2LG6NM | C1.17 | FSF75-8-D | D1.74 |
| | F86-18-C | D1.77 | FS2X3LG6NM | C1.17 | FSF76-10-D | D1.74 |
| | F86-20-C | D1.77 | FS2X4LG6NM | C1.17 | FSF76-12-D | D1.74 |
| | F86-25-C | D1.77 | FS3X1LG6NM | C1.17 | FSF76-6-D | D1.74 |
| | F86-32-C | D1.77 | FS3X2LG6NM | C1.17 | FSF76-8-D | D1.74 |
| | F87-18-C | D1.77 | FS3X3LG6NM | C1.17 | FSF77-10-D | D1.74 |
| | F87-22-C | D1.77 | FS3X4LG6NM | C1.17 | FSF77-12-D | D1.74 |
| C3. Abrasion Protection | F87-25-C | D1.77 | FS3X5LG6NM | C1.17 | FSF77-6-D | D1.74 |
| | F87-32-C | D1.77 | FS4X2LG6NM | C1.17 | FSF77-8-D | D1.74 |
| | FBA10IW-X | C2.79 | FS4X3LG6NM | C1.17 | FSF78-10-D | D1.74 |
| | FBA5IW-X | C2.79 | FS4X4LG6NM | C1.17 | FSF78-12-D | D1.74 |
| | FCB11-A-C20 | B2.25 | FS4X5LG6NM | C1.17 | FSF78-18-D | D1.74 |
| | FCB11-S10-C20 | B2.25 | FS6X4LG6NM | C1.17 | FSF78-6-D | D1.74 |
| | FCB12-A-C20 | B2.25 | FS75-8-5K3 | D1.142 | FSF78-8-D | D1.74 |
| | FCB12-S10-C20 | B2.25 | FS75-8-DSL3 | D1.75, D1.141 | FSF79-8-D | D1.74 |
| | FCB13-A-C20 | B2.25 | FS76-8-5K10 | D1.142 | FSF80-12-D | D1.74 |
| | FCB13-S10-C20 | B2.25 | FS76-8-5K7 | D1.142 | FSF80-18-D | D1.74 |
| C4. Cable Management | FCC-A-C8 | B2.39 | FS76-8-DSL10 | D1.75, D1.141 | FSF80-8-D | D1.74 |
| | FCC5-A-C8 | B2.39 | FS76-8-DSL7 | D1.75, D1.141 | FSF81-10-D | D1.74 |
| | FCF2X2YL | C1.56 | FS77-8-5K4 | D1.142 | FSF81-12-C | D1.74 |
| | FCF4X4YL | C1.56 | FS77-8-DSL4 | D1.75, D1.141 | FSF81-18-C | D1.74 |
| | FCH2-A-C14 | B2.38 | FS78-8-5K2 | D1.142 | FSF82-12-C | D1.74 |
| | FCH2-S6-C14 | B2.38 | FS78-8-DSL2 | D1.75, D1.141 | FSF82-18-C | D1.74 |
| | FCM1-A-C14 | B2.38 | FS80-8-3K8 | D1.142 | FSF83-12-C | D1.74 |
| | FCM1-S6-C14 | B2.38 | FS80-8-DSL8 | D1.75, D1.141 | FSF83-18-C | D1.74 |
| | FCM1.2-A-C14 | B2.38 | FSD72-6-D | D1.73 | FSF84-12-C | D1.74 |
| | FCM1.2-S6-C14 | B2.38 | FSD72-8-D | D1.73 | FSF84-18-C | D1.74 |
| D1. Terminals | FCM2-A-C14 | B2.38 | FSD73-6-D | D1.73 | FSF85-16-L | D1.74 |
| | FCM2-S6-C14 | B2.38 | FSD73-8-D | D1.73 | FSF85-18-L | D1.74 |
| | FCM3.25-A-L14 | B2.38 | FSD74-6-D | D1.73 | FSF85-22-L | D1.74 |
| | FCM3.25-S6-L14 | B2.38 | FSD74-8-D | D1.73 | FSF86-16-L | D1.74 |
| | FCPI1-C20 | B2.25 | FSD74-8-D | D1.73 | FSF86-18-L | D1.74 |
| | FCPI2-C20 | B2.25 | FSD75-10-D | D1.73 | FSF86-25-L | D1.74 |
| | FCPI3-C20 | B2.25 | FSD75-6-D | D1.73 | FSF87-20-L | D1.74 |
| | FEC2X2YL | C1.57 | FSD75-8-5K10 | D1.142 | FSF87-25-Q | D1.74 |
| | FEC4X4YL | C1.57 | FSD75-8-D | D1.73 | FSH40-X | B2.50 |
| | FEIAB58 | C1.61 | FSD75-8-DSL10 | D1.75, D1.141 | FSSH-X | B2.50 |
| D2. Power Connectors | FFWC2X2YL | C1.57 | FSD76-10-D | D1.73 | FT2X2YL | C1.57 |
| | FFWC4X4YL | C1.57 | FSD76-12-D | D1.73 | FT4X4YL | C1.57 |
| | FG1EI50-A | C2.83 | FSD76-6-D | D1.73 | FTD75-8-D | D1.75 |
| | FG1EI6-A | C2.83 | FSD76-8-5K8 | D1.142 | FTD76-10-D | D1.75 |
| | FG3EI50-A | C2.83 | FSD76-8-D | D1.73 | FTD76-8-D | D1.75 |
| | FG3EI6S-A | C2.83 | FSD76-8-DSL8 | D1.75, D1.141 | FTD77-10-D | D1.75 |
| | FSD77-10-D | D1.73 | FSD77-10-D | D1.73 | | |
| | | | | | | |
| | | | | | | |
| | | | | | | |

PANDUIT® ELECTRICAL SOLUTIONS

| Part Number | Page Number |
|--------------------|--------------|
| FTD77-8-D | D1.75 |
| FTD78-12-D | D1.75 |
| FTD78-8-D | D1.75 |
| FTD80-10-TL | D1.75 |
| FTD80-13-TL | D1.75 |
| FTD81-12-C | D1.75 |
| FTD82-14-C | D1.75 |
| FTR2X2YL | C1.58 |
| FTR4X4YL | C1.58 |
| FTRBE12 | C1.60 |
| FTRBE12M | C1.60 |
| FTRBE58 | C1.60 |
| FTRBN12 | C1.60 |
| FTRBN12M | C1.60 |
| FTRBN58 | C1.60 |
| FUSB | C1.60 |
| FVT4X4YL | C1.58 |
| FVTHD2X2YL | C1.58 |
| FWR-C | C1.29 |
| FZBA1.5X4 | C1.60 |
| FZBLP | C1.60 |

G

| | |
|----------------|-------------|
| G.5X.5LG6 | C1.9 |
| G.5X1LG6 | C1.9 |
| G.5X2LG6 | C1.9 |
| G.5X4LG6 | C1.9 |
| G.75X.75LG6 | C1.9 |
| G.75X1.5LG6 | C1.9 |
| G.75X1LG6 | C1.9 |
| G.75X2LG6 | C1.9 |
| G1.5X1.5LG6 | C1.9 |
| G1.5X1LG6 | C1.9 |
| G1.5X2LG6 | C1.9 |
| G1.5X3LG6 | C1.9 |
| G1.5X4LG6 | C1.9 |
| G1X1.5LG6 | C1.9 |
| G1X1LG6 | C1.9 |
| G1X2LG6 | C1.9 |
| G1X3LG6 | C1.9 |
| G1X4LG6 | C1.9 |
| G2.5X3LG6 | C1.9 |
| G2X1.5LG6 | C1.9 |
| G2X1LG6 | C1.9 |
| G2X2LG6 | C1.9 |
| G2X3LG6 | C1.9 |
| G2X4LG6 | C1.9 |
| G2X5LG6 | C1.9 |
| G3X1LG6 | C1.9 |
| G3X2LG6 | C1.9 |
| G3X3LG6 | C1.9 |
| G3X4LG6 | C1.9 |
| G3X5LG6 | C1.9 |
| G4X1.5LG6 | C1.9 |
| G4X2LG6 | C1.9 |
| G4X3LG6 | C1.9 |
| G4X4LG6 | C1.9 |
| G4X5LG6 | C1.9 |
| G6X4LG6 | C1.9 |
| GB2B0304TPI-1 | D3.5 |
| GB2B0306TPI-1 | D3.5 |
| GB2B0312TPI-1 | D3.5 |
| GB4B0612TPI-1 | D3.5 |
| GB4B0624TPI-1 | D3.5 |
| GC-15A-Q | D3.25 |
| GC-18A-X | D3.25 |
| GC-22A-4 | D3.25 |
| GE128-C | C3.10 |
| GE128-C69 | C3.10 |
| GE192-L | C3.10 |
| GE192-L69 | C3.10 |
| GE255-L | C3.10 |
| GE318-L | C3.10 |
| GE380-Q | C3.10 |
| GE510-Q | C3.10 |
| GE52-C | C3.10 |
| GE52-C69 | C3.10 |
| GE85-C | C3.10 |
| GE85-C69 | C3.10 |
| GEE134N-C | C3.10 |
| GEE144F-A-C | C3.9 |
| GEE144F-A-C0 | C3.9 |
| GEE144F-C | C3.8 |
| GEE144F-C0 | C3.8 |
| GEE144FR-C | C3.9 |
| GEE36F-C | C3.8 |
| GEE36F-C0 | C3.8 |
| GEE36FR-C | C3.9 |
| GEE47N-C | C3.10 |
| GEE55N-C | C3.10 |
| GEE62F-A-C | C3.9 |
| GEE62F-A-C0 | C3.9 |
| GEE62F-C | C3.8 |
| GEE62F-C0 | C3.8 |
| GEE62FR-C | C3.9 |
| GEE71N-C | C3.10 |
| GEE98N-C | C3.10 |
| GEE99F-A-C | C3.9 |
| GEE99F-A-C0 | C3.9 |
| GEE99F-C | C3.8 |
| GEE99F-C0 | C3.8 |
| GEE99FR-C | C3.9 |
| GES144F-A-C | C3.9 |
| GES144F-A-C0 | C3.9 |
| GES144F-C | C3.9 |
| GES144F-C0 | C3.9 |
| GES144FR-C | C3.10 |
| GES189F-C | C3.9 |
| GES189F-C0 | C3.9 |
| GES36F-C | C3.9 |
| GES36F-C0 | C3.9 |
| GES36FR-C | C3.10 |
| GES62F-A-C | C3.9 |
| GES62F-A-C0 | C3.9 |
| GES62F-C | C3.9 |
| GES62F-C0 | C3.9 |
| GES62FR-C | C3.10 |
| GES99F-A-C | C3.9 |
| GES99F-A-C0 | C3.9 |
| GES99F-C | C3.9 |
| GES99F-C0 | C3.9 |
| GES99FR-C | C3.10 |
| GHH | B1.112 |
| GM-2-Q | D3.26 |
| GM-3-Q | D3.26 |
| GMS-1-X | D3.26 |
| GMS-2-Q | D3.26 |
| GMS-3-Q | D3.26 |
| GPL-10-Q | D3.22 |
| GPL-14-X | D3.22 |
| GPL-15-X | D3.22 |
| GPL-16-X | D3.22 |
| GPL-20-X | D3.22 |
| GPL-21-X | D3.22 |
| GPL-22-X | D3.22 |
| GPL-26-X | D3.22 |
| GPL-27-X | D3.22 |
| GPL-28-X | D3.22 |
| GPL-32-3 | D3.22 |
| GPL-33-3 | D3.22 |
| GPL-34-3 | D3.22 |
| GPL-39-3 | D3.22 |
| GPL-4-Q | D3.22 |
| GPL-40-3 | D3.22 |
| GPL-44-1 | D3.22 |
| GPL-45-1 | D3.22 |
| GPL-46-1 | D3.22 |
| GPL-5-Q | D3.22 |
| GPL-51-1 | D3.22 |
| GPL-52-1 | D3.22 |
| GPL-57-1 | D3.22 |
| GPL-58-1 | D3.22 |
| GPL-6-Q | D3.22 |
| GPL-8-Q | D3.22 |
| GPL-9-Q | D3.22 |
| GPQC1/0 | D3.4 |
| GS2B | B1.109 |
| GS4EH | B1.109 |
| GS4H | B1.109 |
| GS4MT | B3.14 |
| GTH | B1.109 |
| GTS | B1.109 |
| GTSL | B1.109 |
| GU-13-3 | D3.23 |
| GU-2-X | D3.23 |
| GU-4-X | D3.23 |

H

| | |
|-------------|------|
| H000X025H1C | E1.6 |
| H000X025H2C | E1.6 |

| Part Number | Page Number |
|---------------|-------------|
| H000X034H1C | E1.6 |
| H000X034H2C | E1.6 |
| H000X044H1C | E1.6 |
| H000X044H2C | E1.6 |
| H000X084H1C | E1.6 |
| H000X084H2C | E1.6 |
| H050X025F1T | E2.11 |
| H050X025F1T-B | E2.11 |
| H050X025F2T | E2.11 |
| H050X025H1T | E2.13 |
| H050X025H1T-B | E2.13 |
| H050X025H2T | E2.13 |
| H050X034F1T | E2.11 |
| H050X034F1T-B | E2.11 |
| H050X034F2T | E2.11 |
| H050X034H1T | E2.13 |
| H050X034H1T-B | E2.13 |
| H050X034H2T | E2.13 |
| H050X044F1T | E2.11 |
| H050X044F1T-B | E2.11 |
| H050X044F2T | E2.11 |
| H050X044H1T | E2.13 |
| H050X044H1T-B | E2.13 |
| H050X044H2T | E2.13 |
| H050X064F1T | E2.11 |
| H050X064F1T-B | E2.11 |
| H050X064H1T | E2.13 |
| H050X064H1T-B | E2.13 |
| H075X025F1T | E2.11 |
| H075X025H1T | E2.13 |
| H075X025H1T-B | E2.13 |
| H075X034F1T | E2.11 |
| H075X034H1T | E2.13 |
| H075X044F1T | E2.11 |
| H075X044H1T | E2.13 |
| H1.5X2LG6 | C1.7 |
| H1.5X3LG6 | C1.7 |
| H100X025F1T | E2.11 |
| H100X025F1T-B | E2.11 |
| H100X025F2T | E2.11 |
| H100X025H1C | E1.7 |
| H100X025H1T | E2.13 |
| H100X025H1T-B | E2.13 |
| H100X025H2C | E1.7 |
| H100X025H2T | E2.13 |
| H100X034F1T | E2.12 |
| H100X034F1T-B | E2.12 |
| H100X034F2T | E2.12 |
| H100X034H1C | E1.7 |
| H100X034H1T | E2.13 |
| H100X034H1T-B | E2.13 |
| H100X034H2C | E1.7 |
| H100X034H2T | E2.13 |
| H100X044F1T | E2.12 |
| H100X044F1T-B | E2.12 |
| H100X044F2T | E2.12 |
| H100X044H1C | E1.7 |
| H100X044H1T | E2.14 |
| H100X044H1T-B | E2.14 |
| H100X044H2C | E1.7 |
| H100X044H2C | E1.7 |
| H100X044H2T | E2.14 |
| H100X064F1T | E2.12 |
| H100X064F1T-B | E2.12 |
| H100X064H1T | E2.12 |
| H100X064H1T-B | E2.14 |
| H100X084F1T | E2.12 |
| H100X084F2T | E2.12 |
| H100X084H1C | E1.7 |
| H100X084H1T | E2.14 |
| H100X084H2C | E1.7 |
| H100X084H2T | E2.14 |
| H100X165F1T | E2.12 |
| H100X165F2T | E2.12 |
| H100X165H1T | E2.14 |
| H100X165H2T | E2.14 |
| H150X025F1T | E2.12 |
| H150X025H1T | E2.14 |
| H150X025H1T-B | E2.12 |
| H150X025F2T | E2.12 |
| H150X025H1T | E2.14 |
| H150X025H1T-B | E2.12 |
| H200X025F1T | E2.12 |
| H200X025F1T-B | E2.12 |
| H200X025F2T | E2.12 |
| H200X025H1T | E2.14 |
| H200X025H1T-B | E2.14 |

A.
System
Overview

B1.
Cable Ties

B2.
Cable
Accessories

B3.
Stainless
Steel Ties

C1.
Wiring
Duct

C2.
Surface
Raceway

C3.
Abrasion
Protection

C4.
Cable
Management

D1.
Terminals

D2.
Power
Connectors

D3.
Grounding
Connectors

E1.
Labeling
Systems

E2.
Labels

E3.
Pre-Printed
& Write-On
Markers

E4.
Permanent
Identification

E5.
Lockout/
Tagout
& Safety
Solutions

F.
Index

PANDUIT® ELECTRICAL SOLUTIONS

| A. System Overview | Part Number | Page Number | Part Number | Page Number | Part Number | Page Number | |
|---------------------------------------|-----------------------|--------------|-------------------|--------------|---------------|---------------|-------|
| B1. Cable Ties | H200X025H2T | E2.14 | HLS-15R0 | B1.87 | HSTT05-M | C3.22 | |
| | H200X034F1T | E2.12 | HLS-75R0 | B1.87 | HSTT05-Q | C3.23 | |
| | H200X034F1T-B | E2.12 | HL51.5S-X0 | B1.87 | HSTT06-48-Q | C3.22 | |
| | H200X034F2T | E2.12 | HL33S-X0 | B1.87 | HSTT06-48-TL | C3.22 | |
| | H200X034H1T | E2.14 | HL55S-X0 | B1.87 | HSTT06-C | C3.22 | |
| B2. Cable Accessories | H200X034H1T-B | E2.14 | HLSP1.5S-X0 | B1.88 | HSTT06-M | C3.22 | |
| | H200X034H2T | E2.14 | HLSP1.5S-X12 | B1.88 | HSTT06-Q | C3.23 | |
| | H200X044F1T | E2.12 | HLSP3S-X0 | B1.88 | HSTT06-Y | C3.24 | |
| | H200X044F1T-B | E2.12 | HLSP3S-X12 | B1.88 | HSTT06-YK1 | C3.24 | |
| | H200X044F2T | E2.12 | HLSF5S-X0 | B1.88 | HSTT09-48-Q | C3.22 | |
| B3. Stainless Steel Ties | H200X044H1T | E2.14 | HLSF5S-X12 | B1.88 | HSTT09-48-TL | C3.22 | |
| | H200X044H1T-B | E2.14 | HLT2I-X0 | B1.87 | HSTT09-C | C3.22 | |
| | H200X044H2T | E2.14 | HLT3I-X0 | B1.87 | HSTT09-M | C3.22 | |
| | H200X064F1T | E2.12 | HLTP2I-X0 | B1.88 | HSTT09-Q | C3.23 | |
| | H200X064F1T-B | E2.12 | HLTP2I-X12 | B1.88 | HSTT09-Y | C3.24 | |
| C1. Wiring Duct | H200X064H1T | E2.14 | HLTP3I-X0 | B1.88 | HSTT09-YK1 | C3.24 | |
| | H200X064H1T-B | E2.14 | HLTP3I-X12 | B1.88 | HSTT100-48-5 | C3.23 | |
| | H200X084F1T | E2.12 | HN1.5X2LG6 | C1.7 | HSTT100-48-LQ | C3.23 | |
| | H200X084F2T | E2.12 | HN1.5X3LG6 | C1.7 | HSTT100-C | C3.23 | |
| | H200X084H1T | E2.14 | HN2X2LG6 | C1.7 | HSTT100-Y | C3.24 | |
| C2. Surface Raceway | H200X084H2T | E2.14 | HN2X3LG6 | C1.7 | HSTT100-YK1 | C3.24 | |
| | H200X165F1T | E2.12 | HN2X4LG6 | C1.7 | HSTT12-48-Q | C3.22 | |
| | H200X165F2T | E2.12 | HN3X3LG6 | C1.7 | HSTT12-48-TL | C3.22 | |
| | H200X165H1T | E2.14 | HN3X4LG6 | C1.7 | HSTT12-C | C3.22 | |
| | H200X165H2T | E2.14 | HN4X4LG6 | C1.7 | HSTT12-M | C3.22 | |
| C3. Abrasion Protection | H2L13-2N-2 | D2.140 | HS1.5X2LG6NM | C1.7 | HSTT12-Q | C3.23 | |
| | H2L21-2N-2 | D2.140 | HS1.5X3LG6NM | C1.7 | HSTT12-Y | C3.24 | |
| | H2L30-2N-1 | D2.140 | HS2X2LG6NM | C1.7 | HSTT12-YK1 | C3.24 | |
| | H2L4-2N-X | D2.140 | HS2X3LG6NM | C1.7 | HSTT150-48-5 | C3.23 | |
| | H2L8-2N-2 | D2.140 | HS2X4LG6NM | C1.7 | HSTT150-C | C3.23 | |
| C4. Cable Management | H2X2LG6 | C1.7 | HS3X3LG6NM | C1.7 | HSTT19-48-Q | C3.22 | |
| | H2X3LG6 | C1.7 | HS3X4LG6NM | C1.7 | HSTT19-48-TL | C3.22 | |
| | H2X4LG6 | C1.7 | HS4X4LG6NM | C1.7 | HSTT19-C | C3.22 | |
| | H3X3LG6 | C1.7 | HSC.25-L | B2.42 | HSTT19-M | C3.22 | |
| | H3X4LG6 | C1.7 | HSC.25-L100 | B2.42 | HSTT19-Q | C3.23 | |
| D1. Terminals | H4X4LG6 | C1.7 | HSEC0.5-X | C3.37 | HSTT19-Y | C3.24 | |
| | HB2SP19-X | B2.51 | HSEC0.8-X | C3.37 | HSTT19-YK1 | C3.24 | |
| | HB2SP25-X | B2.51 | HSEC1.0-X | C3.37 | HSTT200-48-5 | C3.23 | |
| | HBN.75-T | B2.49 | HSEC1.5-5 | C3.37 | HSTT200-L | C3.23 | |
| | HBN1-T | B2.49 | HSEC2.0-5 | C3.37 | HSTT25-48-Q | C3.22 | |
| D2. Power Connectors | HBN1.5-T | B2.49 | HSEC4.0-2 | C3.37 | HSTT25-48-TL | C3.22 | |
| | HBN2-T | B2.49 | HSECFR0.5-X | C3.37 | HSTT25-C | C3.22 | |
| | HBN2.5-T | B2.49 | HSECFR0.8-X | C3.37 | HSTT25-D | C3.22 | |
| | HBN3-T | B2.49 | HSECFR1.0-X | C3.37 | HSTT25-Q | C3.23 | |
| | HBN4-T | B2.49 | HSECFR1.5-5 | C3.37 | HSTT25-Y | C3.24 | |
| D3. Grounding Connectors | HBUA-X | B2.51 | HSECFR2.0-5 | C3.37 | HSTT25-YK1 | C3.24 | |
| | HC13-3 | D2.141 | HSG-115V-650 | C3.38, E2.14 | HSTT300-48-2 | C3.23 | |
| | HC21-1 | D2.141 | HSG-A1 | C3.38, E2.14 | HSTT300-L | C3.23 | |
| | HC30-1 | D2.141 | HSG-A2 | C3.38, E2.14 | HSTT38-48-Q | C3.22 | |
| | HC4-3 | D2.141 | HSG-A3 | C3.38, E2.14 | HSTT38-48-TL | C3.22 | |
| E1. Labeling Systems | HC50-1 | D2.141 | HSG-A4 | C3.38, E2.14 | HSTT38-C | C3.22 | |
| | HC8-3 | D2.141 | HSG-P1 | C3.38, E2.14 | HSTT38-Q | C3.23 | |
| | HCME04Y09-C30 | B2.45 | HSG-P2 | C3.38, E2.14 | HSTT38-T | C3.22 | |
| | HCME06A12-C130 | B2.45 | HSG-P3 | C3.38, E2.14 | HSTT38-Y | C3.24 | |
| | HCME06Y12-C30 | B2.45 | HSG-P7 | C3.38, E2.14 | HSTT38-YK1 | C3.24 | |
| E2. Labels | HCMP06B12-C20 | B2.44 | HST0.4-3-Q | C3.35 | HSTT400-48-2 | C3.23 | |
| | HCMP06C12-C20 | B2.44 | HST0.4-48-5 | C3.35 | HSTT400-L | C3.23 | |
| | HHL13-2N-5 | C2.139 | HST0.4-6-3 | C3.35 | HSTT50-48-L | C3.23 | |
| | HHL21-2N-5 | C2.139 | HST0.4-6-X | C3.35 | HSTT50-48-T | C3.23 | |
| | HHL30-22N-1 | C2.139 | HST0.8-12-5 | C3.36 | HSTT50-C | C3.23 | |
| E3. Pre-Printed & Write-On Markers | HHL8-2N-X | C2.139 | HST0.8-48-5 | C3.36 | HSTT50-Q | C3.23 | |
| | HKBS | C3.14 | HST0.8-6-3 | C3.36 | HSTT50-T | C3.23 | |
| | HL1-2-25-X | D2.138 | HST0.8-6-X | C3.36 | HSTT50-Y | C3.24 | |
| | HL1-25-X | D2.136 | HST0.8-9-X | C3.36 | HSTT50-YK1 | C3.24 | |
| | HL13-1-5 | D2.136 | HST1.1-12-5 | C3.36 | HSTT75-48-5 | C3.23 | |
| E4. Permanent Identification | HL13-2-5 | D2.138 | HST1.1-48-5 | C3.36 | HSTT75-48-CQ | C3.23 | |
| | HL13-2N-5 | D2.139 | HST1.1-6-3 | C3.36 | HSTT75-Q | C3.23 | |
| | HL21-1-5 | D2.136 | HST1.1-6-X | C3.36 | HSTT75-T | C3.23 | |
| | HL21-2-5 | D2.138 | HST1.1-9-2 | C3.36 | HSTT75-Y | C3.24 | |
| | HL21-2N-5 | D2.139 | HST1.1-9-X | C3.36 | HSTT75-YK1 | C3.24 | |
| E5. Lockout/Tagout & Safety Solutions | HL30-1-2 | D2.136 | HST1.5-12-1 | C3.36 | HSTTA100-48-5 | C3.34 | |
| | HL30-2-2 | D2.138 | HST1.5-12-5 | C3.36 | HSTTA100-48-L | C3.34 | |
| | HL30-2N-2 | D2.139 | HST1.5-48-5 | C3.36 | HSTTA100-Y | C3.34 | |
| | HL4-1-X | D2.136 | HST1.5-9-X | C3.36 | HSTTA150-48-5 | C3.34 | |
| | HL4-2-X | D2.138 | HST2.0-12-2 | C3.36 | HSTTA150-48-Q | C3.34 | |
| F. Index | HL50-1-2 | D2.136 | HST2.0-48-2 | C3.36 | HSTTA150-Y | C3.34 | |
| | HL50-2-2 | D2.138 | HST2.0-9-5 | C3.36 | HSTTA19-48-Q | C3.34 | |
| | HL8-1-X | D2.136 | HST3.0-12-2 | C3.36 | HSTTA19-Y | C3.34 | |
| | HL8-2-X | D2.138 | HST3.0-48-2 | C3.36 | HSTTA25-48-Q | C3.34 | |
| | HL8-2N-X | D2.139 | HSTT-YK1 | C3.25 | HSTTA25-48-TL | C3.34 | |
| | | | | | | HSTTA25-Y | C3.34 |
| | | | | | | HSTTA38-48-Q | C3.34 |
| | | | | | | HSTTA38-48-TL | C3.34 |
| | | | | | | HSTTA38-Y | C3.34 |
| | | | | | | HSTTA50-48-5 | C3.34 |
| | | | | | | HSTTA50-48-T | C3.34 |
| | | | | | | | |

PANDUIT® ELECTRICAL SOLUTIONS

| Part Number | Page Number | Part Number | Page Number | Part Number | Page Number |
|-----------------|-------------|----------------|-------------|-----------------|-------------|
| HSTTA50-Y | C3.34 | HSTTT150-48-2 | C3.32 | HSTTV50-T2 | C3.28 |
| HSTTA75-48-5 | C3.34 | HSTTT19-48-Q | C3.32 | HSTTV50-T4 | C3.28 |
| HSTTA75-48-C | C3.34 | HSTTT24-48-Q | C3.32 | HSTTV50-T6 | C3.28 |
| HSTTA75-Y | C3.34 | HSTTT30-48-Q | C3.32 | HSTTV50-Y | C3.29 |
| HSTTK05-48-Q | C3.33 | HSTTT37-48-Q | C3.32 | HSTTV75-48-5 | C3.26 |
| HSTTK06-48-Q | C3.33 | HSTTT43-48-Q | C3.32 | HSTTV75-48-CQ | C3.26 |
| HSTTK09-48-Q | C3.33 | HSTTT47-48-Q | C3.32 | HSTTV75-C | C3.27 |
| HSTTK100-48-5 | C3.33 | HSTTT56-48-5 | C3.32 | HSTTV75-Q | C3.29 |
| HSTTK12-48-Q | C3.33 | HSTTT66-48-5 | C3.32 | HSTTV75-T | C3.28 |
| HSTTK19-48-Q | C3.33 | HSTTT75-48-5 | C3.32 | HSTTV75-T2 | C3.28 |
| HSTTK25-48-Q | C3.33 | HSTTT93-48-5 | C3.32 | HSTTV75-T4 | C3.28 |
| HSTTK38-48-Q | C3.33 | HSTTV05-48-Q | C3.26 | HSTTV75-T6 | C3.28 |
| HSTTK50-48-5 | C3.33 | HSTTV05-48-TL | C3.26 | HSTTV75-Y | C3.29 |
| HSTTK75-48-5 | C3.33 | HSTTV05-C | C3.27 | HSTTV100-48-5 | C3.33 |
| HSTTN100-C | C3.31 | HSTTV05-M | C3.28 | HSTTV100-Y | C3.34 |
| HSTTN125-C | C3.31 | HSTTV05-M2 | C3.28 | HSTTV12-48-Q | C3.33 |
| HSTTN150-C | C3.31 | HSTTV05-M4 | C3.28 | HSTTV12-Y | C3.34 |
| HSTTN200-Q | C3.31 | HSTTV05-M6 | C3.28 | HSTTV150-48-5 | C3.33 |
| HSTTN25-C | C3.31 | HSTTV05-Q | C3.29 | HSTTV19-48-Q | C3.33 |
| HSTTN300-Q | C3.31 | HSTTV05-Y | C3.29 | HSTTV19-Y | C3.34 |
| HSTTN38-C | C3.31 | HSTTV06-48-Q | C3.26 | HSTTV25-48-Q | C3.33 |
| HSTTN50-C | C3.31 | HSTTV06-48-TL | C3.26 | HSTTV25-Y | C3.34 |
| HSTTN63-C | C3.31 | HSTTV06-C | C3.27 | HSTTV38-48-Q | C3.33 |
| HSTTN75-C | C3.31 | HSTTV06-M | C3.28 | HSTTV38-Y | C3.34 |
| HSTTN88-C | C3.31 | HSTTV06-M2 | C3.28 | HSTTV50-48-5 | C3.33 |
| HSTTP05-CY | C3.30 | HSTTV06-M4 | C3.28 | HSTTV50-Y | C3.34 |
| HSTTP05-MY | C3.30 | HSTTV06-M6 | C3.28 | HSTTV75-48-5 | C3.33 |
| HSTTP05-QY | C3.30 | HSTTV06-Q | C3.29 | HSTTV75-Y | C3.34 |
| HSTTP06-CY | C3.30 | HSTTV06-Y | C3.29 | HT2-BLU | E5.32 |
| HSTTP06-MY | C3.30 | HSTTV09-48-Q | C3.26 | HT2-GRN | E5.32 |
| HSTTP06-QY | C3.30 | HSTTV09-48-TL | C3.26 | HT2-ORN | E5.32 |
| HSTTP09-CY | C3.30 | HSTTV09-C | C3.27 | HT2-RED | E5.32 |
| HSTTP09-MY | C3.30 | HSTTV09-M | C3.28 | HT2-WHT | E5.32 |
| HSTTP09-QY | C3.30 | HSTTV09-M2 | C3.28 | HT2-YEL | E5.32 |
| HSTTP100-CY | C3.30 | HSTTV09-M4 | C3.28 | HT2S-BLK-YEL | E5.31 |
| HSTTP100-QY | C3.30 | HSTTV09-M6 | C3.28 | HT2S-RED-WHT | E5.31 |
| HSTTP12-CY | C3.30 | HSTTV09-Q | C3.29 | HT3S-BLK-YEL | E5.31 |
| HSTTP12-MY | C3.30 | HSTTV09-Y | C3.29 | HT3S-RED-WHT | E5.31 |
| HSTTP12-QY | C3.30 | HSTTV100-48-5 | C3.26 | HTAP1-1-Q | D2.122 |
| HSTTP150-CY | C3.30 | HSTTV100-48-LQ | C3.26 | HTAP1/0-1-Q | D2.122 |
| HSTTP150-QY | C3.30 | HSTTV100-C | C3.27 | HTAP2-8-L | D2.122 |
| HSTTP19-CY | C3.30 | HSTTV100-Q | C3.29 | HTAP2/0-1-Q | D2.122 |
| HSTTP19-MY | C3.30 | HSTTV100-Y | C3.29 | HTAP3/0-1-Q | D2.122 |
| HSTTP19-QY | C3.30 | HSTTV12-48-Q | C3.26 | HTAP3/0-3/0-Q | D2.122 |
| HSTTP200-QY | C3.30 | HSTTV12-48-TL | C3.26 | HTAP4/0-2-Q | D2.122 |
| HSTTP25-CY | C3.30 | HSTTV12-C | C3.27 | HTAP4/0-3/0-Q | D2.122 |
| HSTTP25-DY | C3.30 | HSTTV12-M | C3.28 | HTAP4/0-4/0-Q | D2.122 |
| HSTTP25-QY | C3.30 | HSTTV12-M2 | C3.28 | HTAP500-4/0-X | D2.122 |
| HSTTP38-CY | C3.30 | HSTTV12-M4 | C3.28 | HTAP500-500-X | D2.122 |
| HSTTP38-QY | C3.30 | HSTTV12-M6 | C3.28 | HTB3-C-M | E5.34 |
| HSTTP38-TY | C3.30 | HSTTV12-Q | C3.29 | HTB3-DNE-M | E5.34 |
| HSTTP50-CY | C3.30 | HSTTV12-Y | C3.29 | HTB3-HV-M | E5.34 |
| HSTTP50-QY | C3.30 | HSTTV150-48-5 | C3.26 | HTCT1000-1000-1 | D3.10 |
| HSTTP75-CY | C3.30 | HSTTV150-C | C3.27 | HTCT1000-250-1 | D3.10 |
| HSTTP75-QY | C3.30 | HSTTV19-48-Q | C3.26 | HTCT2-2-1 | D3.9 |
| HSTTPN100-775-Q | C3.31 | HSTTV19-48-TL | C3.26 | HTCT250-2-1 | D3.9 |
| HSTTPN100-CC | C3.31 | HSTTV19-C | C3.27 | HTCT250-250-1 | D3.9 |
| HSTTPN150-925-X | C3.31 | HSTTV19-M | C3.28 | HTCT250-8-1 | D3.9 |
| HSTTPN150-CC | C3.31 | HSTTV19-M2 | C3.28 | HTCT500-250-1 | D3.10 |
| HSTTPN200-950-X | C3.31 | HSTTV19-M4 | C3.28 | HTCT500-500-1 | D3.10 |
| HSTTPN200-CC | C3.31 | HSTTV19-M6 | C3.28 | HTCT6-6-1 | D3.9 |
| HSTTPN50-438-L | C3.31 | HSTTV19-Q | C3.29 | HTCT750-4/0-1 | D3.10 |
| HSTTPN50-713-Q | C3.31 | HSTTV19-Y | C3.29 | HTCT750-750-1 | D3.10 |
| HSTTPN50-CC | C3.31 | HSTTV25-48-Q | C3.26 | HTCT8-8-1 | D3.9 |
| HSTTPN62-750-Q | C3.31 | HSTTV25-48-TL | C3.26 | HTDU2B-W | E5.33 |
| HSTTPN62-CC | C3.31 | HSTTV25-C | C3.27 | HTDU2O-FO | E5.33 |
| HSTTPN75-775-Q | C3.31 | HSTTV25-D | C3.28 | HTDU2O-T | E5.33 |
| HSTTPN75-CC | C3.31 | HSTTV25-D2 | C3.28 | HTDU2R-E | E5.33 |
| HSTTRA100-48-5 | C3.35 | HSTTV25-D4 | C3.28 | HTDU3O-FO | E5.33 |
| HSTTRA12-48-Q | C3.35 | HSTTV25-D6 | C3.28 | HTDU3O-T | E5.33 |
| HSTTRA19-48-Q | C3.35 | HSTTV25-Q | C3.29 | HTDU3R-E | E5.33 |
| HSTTRA25-48-Q | C3.35 | HSTTV25-Y | C3.29 | HTDU6O-FO | E5.33 |
| HSTTRA38-48-Q | C3.35 | HSTTV38-48-Q | C3.26 | HTDU6O-T | E5.33 |
| HSTTRA50-48-5 | C3.35 | HSTTV38-48-TL | C3.26 | HTDU6R-E | E5.33 |
| HSTTT03-48-Q | C3.32 | HSTTV38-C | C3.27 | HTMT | B3.15 |
| HSTTT04-48-Q | C3.32 | HSTTV38-Q | C3.29 | HTU3G-T-M | E5.33 |
| HSTTT046-48-Q | C3.32 | HSTTV38-T | C3.28 | HTU3O-FO-M | E5.33 |
| HSTTT05-48-Q | C3.32 | HSTTV38-T2 | C3.28 | HTU3O-T-M | E5.33 |
| HSTTT055-48-Q | C3.32 | HSTTV38-T4 | C3.28 | HTU3R-E-M | E5.33 |
| HSTTT06-48-Q | C3.32 | HSTTV38-T6 | C3.28 | HTU3Y-E-M | E5.33 |
| HSTTT08-48-Q | C3.32 | HSTTV38-Y | C3.29 | HTU6O-FO | E5.33 |
| HSTTT09-48-Q | C3.32 | HSTTV50-48-Q | C3.26 | HTU6O-T | E5.33 |
| HSTTT112-48-5 | C3.32 | HSTTV50-48-T | C3.26 | HTU6O-TV | E5.33 |
| HSTTT12-48-Q | C3.32 | HSTTV50-C | C3.27 | HTU6R-E | E5.33 |
| HSTTT131-48-2 | C3.32 | HSTTV50-Q | C3.29 | HTU6Y-E | E5.33 |
| HSTTT15-48-Q | C3.32 | HSTTV50-T | C3.28 | HTU6Y-G | E5.33 |

| |
|---------------------------------------|
| A. System Overview |
| B1. Cable Ties |
| B2. Cable Accessories |
| B3. Stainless Steel Ties |
| C1. Wiring Duct |
| C2. Surface Raceway |
| C3. Abrasion Protection |
| C4. Cable Management |
| D1. Terminals |
| D2. Power Connectors |
| D3. Grounding Connectors |
| E1. Labeling Systems |
| E2. Labels |
| E3. Pre-Printed & Write-On Markers |
| E4. Permanent Identification |
| E5. Lockout/Tagout & Safety Solutions |
| F. Index |

PANDUIT® ELECTRICAL SOLUTIONS

| A. System Overview | Part Number | Page Number | Part Number | Page Number | Part Number | Page Number |
|---------------------------------------|--------------------|---------------------|-----------------|--------------|----------------|---------------|
| B1. Cable Ties | HTWC1000-1000-1 | D3.12 | JBP2IW | C2.57, C2.58 | K1-PNKIT | D1.38 |
| | HTWC1000-250-1 | D3.12 | JBP2SIW | C2.58 | K2-BLD2 | B1.112 |
| | HTWC2-2-1 | D3.11 | JBX3510IW-A | C2.57 | K2-PVKITY | D1.38 |
| | HTWC250-2-1 | D3.11 | JMCB-X | C4.7 | K4EH-BLD | B1.112 |
| | HTWC250-250-1 | D3.11 | JMCM25-1-X | C4.7 | K4H-BLD | B1.112 |
| | HTWC250-8-1 | D3.11 | JMCM25-3-X | C4.7 | K4M-BLD | B3.14 |
| | HTWC500-250-1 | D3.12 | JMDWB-1-X | C4.7 | K4MTG | B3.14 |
| | HTWC500-500-1 | D3.12 | JMDWB-3-X | C4.7 | K600-A | D1.86 |
| | HTWC6-6-1 | D3.11 | JMJH2-X20 | C4.7 | KB-550 | B1.84 |
| | HTWC750-4/0-1 | D3.12 | JMJH2W-X20 | C4.7 | KB-551 | B1.84 |
| B2. Cable Accessories | HTWC750-750-1 | D3.12 | JMN2-C | D1.69 | KGTHBLD | B1.112 |
| | HTWC8-8-1 | D3.11 | JMN6-C | D1.69 | KGTHSLV | B1.112 |
| | HV9100-C0 | B1.62 | JMSBCB87-1-X | C4.7 | KGTHTL | B1.112 |
| | HV9150-C0 | B1.62 | JMSBCB87-3-X | C4.7 | KGTSBLD | B1.112 |
| | HV9250-C0 | B1.62 | JMTRB38-1-X | C4.7 | KGTSLSV | B1.112 |
| | HV965-C0 | B1.62 | JMTRB38-3-X | C4.7 | KGSTSL | B1.112 |
| | HVMPM32-C0 | B1.62, B2.21 | JN218-216-C | D1.67 | KH-1-L | D3.24 |
| | HVTM3S10-C0 | B1.62, B2.13 | JN224-318-C | D1.67 | KH-2-L | D3.24 |
| | HWS2819-C | B2.43 | JN314-412-C | D1.67 | KIMS-H366-C2 | B2.14 |
| | | | JN418-212-C | D1.67 | KIMS-H430-C6 | B2.14 |
| C1. Wiring Duct | | | JP131CM-L20 | C4.4 | KIMS-H500-C4 | B2.14 |
| | | | JP131CP-L20 | C4.6 | KLM14-250Y | D2.153 |
| | | | JP131DW-L20 | C4.4 | KLM350-800Y | D2.153 |
| | | | JP131HBC25R-L20 | C4.5 | KLM6-250Y | D2.153 |
| | | | JP131HBC50R-L20 | C4.5 | KLM6-600Y | D2.153 |
| | | | JP131HBC75R-L20 | C4.5 | KLM6-800Y | D2.153 |
| | | | JP131SBC50-L20 | C4.5 | KLS-0-Q | D3.24 |
| | | | JP131SBC50R-L20 | C4.5 | KLS-1-Q | D3.24 |
| | | | JP131SBC87-L20 | C4.5 | KLS-1A-X | D3.24 |
| | | | JP131SBC87R-L20 | C4.5 | KMTRTH | B3.20 |
| C2. Surface Raceway | | | JP131UF100-L20 | C4.6 | KMTRTLs | B3.20 |
| | | | JP131WP-L20 | C4.4 | KP-1000 | D1.36 |
| | | | JP131ZP-L20 | C4.6 | KP-1075Y | D1.36 |
| | | | JP2CM-L20 | C4.4 | KP-1165Y | D1.36 |
| | | | JP2CP-L20 | C4.6 | KP-1166 | D1.36 |
| | | | JP2DW-L20 | C4.4 | KP-506A | B1.84 |
| | | | JP2HBC25R-L20 | C4.5 | KP-506A-0 | B1.84 |
| | | | JP2HBC50R-L20 | C4.5 | KP-509 | B1.84 |
| | | | JP2HBC75R-L20 | C4.5 | KP-F1 | D1.78 |
| | | | JP2SBC50-L20 | C4.5 | KP-F2 | D1.78 |
| C3. Abrasion Protection | | | JP2SBC50R-L20 | C4.5 | KP-FSD1 | D1.78 |
| | | | JP2SBC87-L20 | C4.5 | KP-FSD2 | D1.78 |
| | | | JP2SBC87R-L20 | C4.5 | KP-FSD3 | D1.78 |
| | | | JP2UF100-L20 | C4.6 | KP-HSTT1 | C3.38 |
| | | | JP2W-L20 | C4.4 | KP-HSTT2 | C3.38 |
| | | | JP2WP-L20 | C4.4 | KP-HSTTA | C3.38 |
| | | | JP2ZP-L20 | C4.6 | KP1-C | D3.23 |
| | | | JP4CM-X20 | C4.4 | KP2-L | D3.23 |
| | | | JP4CP-X20 | C4.6 | KPPTMTG | B3.16 |
| | | | JP4HBC25R-X20 | C4.5 | KPPTMTB | B3.16 |
| C4. Cable Management | | | JP4HBC50R-X20 | C4.5 | KPTHBLD | B1.112 |
| | | | JP4HBC75R-X20 | C4.5 | KPTSTL | B1.112 |
| | | | JP4SBC50-X20 | C4.5 | | |
| | | | JP4SBC50R-X20 | C4.5 | | |
| | | | JP4SBC87-X20 | C4.5 | | |
| | | | JP4SBC87R-X20 | C4.5 | | |
| | | | JP4UF100-X20 | C4.6 | | |
| | | | JP4W-X20 | C4.4 | | |
| | | | JP4WP-X20 | C4.4 | | |
| | | | JP4ZP-X20 | C4.6 | | |
| D1. Terminals | | | JP75CM-L20 | C4.4 | | |
| | | | JP75CP-L20 | C4.6 | | |
| | | | JP75DW-L20 | C4.4 | | |
| | | | JP75HBC25R-L20 | C4.5 | | |
| | | | JP75HBC50R-L20 | C4.5 | | |
| | | | JP75HBC75R-L20 | C4.5 | | |
| | | | JP75SBC50-L20 | C4.5 | | |
| | | | JP75SBC50R-L20 | C4.5 | | |
| | | | JP75SBC87-L20 | C4.5 | | |
| | | | JP75SBC87R-L20 | C4.5 | | |
| D2. Power Connectors | | | JP75UF100-L20 | C4.6 | | |
| | | | JP75WP-L20 | C4.4 | | |
| | | | JP75ZP-L20 | C4.6 | | |
| | | | K-1000 | D1.37 | | |
| | | | K-1001 | D1.37 | | |
| | | | K-1100 | D1.37 | | |
| | | | K-1102Y | D1.37 | | |
| | | | K-1103Y | D1.37 | | |
| | | | K-1104 | D1.37 | | |
| | | | K-205 | B1.83, D1.38 | | |
| D3. Grounding Connectors | | | K-504 | B1.83 | | |
| | | | | | | |
| | | | | | | |
| | | | | | | |
| | | | | | | |
| | | | | | | |
| | | | | | | |
| | | | | | | |
| | | | | | | |
| | | | | | | |
| E1. Labeling Systems | | | | | | |
| | | | | | | |
| | | | | | | |
| | | | | | | |
| | | | | | | |
| | | | | | | |
| | | | | | | |
| | | | | | | |
| | | | | | | |
| | | | | | | |
| E2. Labels | | | | | | |
| | | | | | | |
| | | | | | | |
| | | | | | | |
| | | | | | | |
| | | | | | | |
| | | | | | | |
| | | | | | | |
| | | | | | | |
| | | | | | | |
| E3. Pre-Printed & Write-On Markers | | | | | | |
| | | | | | | |
| | | | | | | |
| | | | | | | |
| | | | | | | |
| | | | | | | |
| | | | | | | |
| | | | | | | |
| | | | | | | |
| | | | | | | |
| E4. Permanent Identification | | | | | | |
| | | | | | | |
| | | | | | | |
| | | | | | | |
| | | | | | | |
| | | | | | | |
| | | | | | | |
| | | | | | | |
| | | | | | | |
| | | | | | | |
| E5. Lockout/Tagout & Safety Solutions | | | | | | |
| | | | | | | |
| | | | | | | |
| | | | | | | |
| | | | | | | |
| | | | | | | |
| | | | | | | |
| | | | | | | |
| | | | | | | |
| | | | | | | |
| F. Index | | | | | | |
| | | | | | | |
| | | | | | | |
| | | | | | | |
| | | | | | | |
| | | | | | | |
| | | | | | | |
| | | | | | | |
| | | | | | | |
| | | | | | | |

PANDUIT® ELECTRICAL SOLUTIONS

| Part Number | Page Number | Part Number | Page Number | Part Number | Page Number | A. System Overview |
|-----------------|-------------|--------------|-------------|--------------|-------------|-------------------------|
| LAB1000-12-1 | D2.117 | LCA1/0-38-X | D2.14 | LCA350-38H-X | D2.16 | B1. Cable Ties |
| LAB2/0-12-5 | D2.117 | LCA1/0-38F-X | D2.17 | LCA350-58-X | D2.14 | |
| LAB250-12-5 | D2.117 | LCA1/0-38H-X | D2.16 | LCA350-58F-X | D2.18 | |
| LAB3/0-12-5 | D2.117 | LCA1/0-56-X | D2.14 | LCA350-58H-X | D2.16 | |
| LAB300-12-2 | D2.117 | LCA1/0-56F-X | D2.17 | LCA350-78-X | D2.14 | |
| LAB350-12-2 | D2.117 | LCA1/0-56H-X | D2.16 | LCA350-78F-X | D2.18 | |
| LAB4/0-12-5 | D2.117 | LCA10-10-L | D2.13 | LCA350-78H-X | D2.16 | |
| LAB400-12-2 | D2.117 | LCA10-14-L | D2.13 | LCA4-00-L | D2.21 | |
| LAB500-12-2 | D2.117 | LCA10-14F-L | D2.17 | LCA4-10-L | D2.13 | |
| LAB600-12-2 | D2.117 | LCA10-14H-L | D2.15 | LCA4-10F-L | D2.17 | |
| LAB750-12-1 | D2.117 | LCA10-38-L | D2.13 | LCA4-10H-L | D2.15 | B2. Cable Accessories |
| LAB800-12-1 | D2.117 | LCA10-56-L | D2.13 | LCA4-14-L | D2.13 | |
| LAM2A1/0-14-6Y | D2.148 | LCA10-56L | D2.13 | LCA4-14F-L | D2.17 | |
| LAM2A1000-58-6Y | D2.148 | LCA2-00-Q | D2.21 | LCA4-14H-L | D2.15 | |
| LAM2A2/0-14-6Y | D2.148 | LCA2-12-Q | D2.13 | LCA4-38-L | D2.13 | |
| LAM2A250-38-6Y | D2.148 | LCA2-12F-Q | D2.17 | LCA4-38F-L | D2.17 | |
| LAM2A350-12-6Y | D2.148 | LCA2-12H-Q | D2.15 | LCA4-38H-L | D2.15 | |
| LAM2A600-12-6Y | D2.148 | LCA2-14-Q | D2.13 | LCA4-56-L | D2.13 | |
| LAM2A800-58-6Y | D2.148 | LCA2-14F-Q | D2.17 | LCA4-56F-L | D2.17 | |
| LAM2B350-12-3Y | D2.149 | LCA2-14H-Q | D2.15 | LCA4-56H-L | D2.15 | |
| LAM2B600-12-3Y | D2.149 | LCA2-38-Q | D2.13 | LCA4/0-00-X | D2.21 | C1. Wiring Duct |
| LAM2LB800-12-3Y | D2.149 | LCA2-38F-Q | D2.17 | LCA4/0-12-X | D2.14 | |
| LAM2SA300-56-3 | D2.149 | LCA2-38H-Q | D2.15 | LCA4/0-12F-X | D2.18 | |
| LAM2SB600-38-1Y | D2.150 | LCA2-56-Q | D2.13 | LCA4/0-12H-X | D2.16 | |
| LAM2SB750-38-1Y | D2.150 | LCA2-56F-Q | D2.17 | LCA4/0-14-X | D2.14 | |
| LAM2SSB500-141Y | D2.150 | LCA2-56H-Q | D2.15 | LCA4/0-14F-X | D2.18 | |
| LAM3B1/0-38-6Y | D2.150 | LCA2/0-00-X | D2.21 | LCA4/0-14H-X | D2.16 | |
| LAM3B2-14-6Y | D2.150 | LCA2/0-12-X | D2.14 | LCA4/0-38-X | D2.14 | |
| LAM3B250-12-1Y | D2.150 | LCA2/0-12F-X | D2.17 | LCA4/0-38F-X | D2.18 | |
| LAM3B3/0-12-3Y | D2.150 | LCA2/0-12H-X | D2.16 | LCA4/0-38H-X | D2.16 | |
| LAM3B350-12-1Y | D2.150 | LCA2/0-14-X | D2.14 | LCA4/0-56-X | D2.14 | |
| LAM3B600-12-1Y | D2.150 | LCA2/0-14F-X | D2.17 | LCA4/0-56F-X | D2.18 | |
| LAM3D250-12-1Y | D2.151 | LCA2/0-14H-X | D2.16 | LCA4/0-56H-X | D2.16 | C2. Surface Raceway |
| LAM3D3/0-12-3Y | D2.151 | LCA2/0-34H-X | D2.16 | LCA400-00-6 | D2.21 | |
| LAM3D350-12-1Y | D2.151 | LCA2/0-38-X | D2.14 | LCA400-12-6 | D2.14 | |
| LAM3D600-12-1Y | D2.151 | LCA2/0-38F-X | D2.17 | LCA400-12F-6 | D2.18 | |
| LAM3LB1000-121Y | D2.150 | LCA2/0-38H-X | D2.16 | LCA400-12H-6 | D2.16 | |
| LAM3LB800-12-1Y | D2.150 | LCA2/0-56-X | D2.14 | LCA400-38-6 | D2.14 | |
| LAM3LD1000-121Y | D2.151 | LCA2/0-56F-X | D2.17 | LCA400-38F-6 | D2.18 | |
| LAM3LD800-12-1Y | D2.151 | LCA2/0-56H-X | D2.16 | LCA400-38H-6 | D2.16 | |
| LAM3SB600-38-1Y | D2.151 | LCA250-12-X | D2.14 | LCA400-58-6 | D2.14 | |
| LAM3SB750-38-1Y | D2.151 | LCA250-12F-X | D2.18 | LCA400-58F-6 | D2.18 | |
| LAM4D250-12-1Y | D2.152 | LCA250-12H-X | D2.16 | LCA400-58H-6 | D2.16 | |
| LAM4D350-12-1Y | D2.152 | LCA250-14-X | D2.14 | LCA400-78-6 | D2.14 | |
| LAM4D600-12-1Y | D2.152 | LCA250-14F-X | D2.18 | LCA400-78F-6 | D2.18 | |
| LAM4LD800-12-1Y | D2.152 | LCA250-14H-X | D2.16 | LCA400-78H-6 | D2.16 | C3. Abrasion Protection |
| LAM4SB600-38-1Y | D2.152 | LCA250-38-X | D2.14 | LCA500-00-6 | D2.21 | |
| LAM4SB750-38-1Y | D2.152 | LCA250-38F-X | D2.18 | LCA500-1-6 | D2.14 | |
| LAMA1/0-14-QY | D2.147 | LCA250-38H-X | D2.16 | LCA500-12-6 | D2.14 | |
| LAMA1000-58-6Y | D2.147 | LCA250-56-X | D2.14 | LCA500-12F-6 | D2.18 | |
| LAMA2-14-QY | D2.147 | LCA250-56F-X | D2.18 | LCA500-12H-6 | D2.16 | |
| LAMA2/0-14-QY | D2.147 | LCA250-56H-X | D2.16 | LCA500-1F-6 | D2.18 | |
| LAMA250-56-QY | D2.147 | LCA3/0-00-X | D2.21 | LCA500-1H-6 | D2.16 | |
| LAMA300-56-QY | D2.147 | LCA3/0-12-X | D2.14 | LCA500-34-6 | D2.14 | |
| LAMA350-38-QY | D2.147 | LCA3/0-12F-X | D2.18 | LCA500-34F-6 | D2.18 | |
| LAMA500-38-6Y | D2.147 | LCA3/0-12H-X | D2.16 | LCA500-34H-6 | D2.16 | |
| LAMA6-14-QY | D2.147 | LCA3/0-14-X | D2.14 | LCA500-38-6 | D2.14 | |
| LAMA600-38-6Y | D2.147 | LCA3/0-14F-X | D2.18 | LCA500-38F-6 | D2.18 | |
| LAMA600S-38-6Y | D2.147 | LCA3/0-14H-X | D2.16 | LCA500-38H-6 | D2.16 | |
| LAMA800-58-6Y | D2.147 | LCA3/0-38-X | D2.14 | LCA500-58-6 | D2.14 | |
| LAMB350-12-6Y | D2.148 | LCA3/0-38F-X | D2.18 | LCA500-58F-6 | D2.18 | |
| LAMB600-12-3Y | D2.148 | LCA3/0-38H-X | D2.16 | LCA500-58H-6 | D2.16 | |
| LAMLB800-12-3Y | D2.148 | LCA3/0-56-X | D2.14 | LCA500-78-6 | D2.14 | |
| LC10-A-L8 | B2.37 | LCA3/0-56F-X | D2.18 | LCA500-78F-6 | D2.18 | |
| LC3-A-C8 | B2.37 | LCA3/0-56H-X | D2.16 | LCA500-78H-6 | D2.16 | |
| LC5-A-C8 | B2.37 | LCA300-00-X | D2.21 | LCA6-00-L | D2.21 | |
| LCA1-00-E | D2.21 | LCA300-12-X | D2.14 | LCA6-10-L | D2.13 | |
| LCA1-12-E | D2.13 | LCA300-12F-X | D2.18 | LCA6-10F-L | D2.17 | |
| LCA1-12F-E | D2.17 | LCA300-12H-X | D2.16 | LCA6-10H-L | D2.15 | |
| LCA1-12H-E | D2.16 | LCA300-38-X | D2.14 | LCA6-14-L | D2.13 | |
| LCA1-14-E | D2.13 | LCA300-38F-X | D2.18 | LCA6-14F-L | D2.17 | |
| LCA1-14F-E | D2.17 | LCA300-38H-X | D2.16 | LCA6-14H-L | D2.15 | |
| LCA1-14H-E | D2.16 | LCA300-56-X | D2.14 | LCA6-38-L | D2.13 | |
| LCA1-38-E | D2.13 | LCA300-56F-X | D2.18 | LCA6-38F-L | D2.17 | |
| LCA1-38F-E | D2.17 | LCA300-56H-X | D2.16 | LCA6-38H-L | D2.15 | |
| LCA1-38H-E | D2.16 | LCA300-58-X | D2.14 | LCA6-56-L | D2.13 | |
| LCA1-56-E | D2.13 | LCA300-58F-X | D2.18 | LCA6-56F-L | D2.17 | |
| LCA1-56F-E | D2.17 | LCA300-58H-X | D2.16 | LCA6-56H-L | D2.15 | |
| LCA1-56H-E | D2.16 | LCA300-78-X | D2.14 | LCA600-00-6 | D2.21 | |
| LCA1/0-00-X | D2.21 | LCA300-78F-X | D2.18 | LCA600-12-6 | D2.14 | |
| LCA1/0-12-X | D2.14 | LCA300-78H-X | D2.16 | LCA600-12F-6 | D2.18 | |
| LCA1/0-12F-X | D2.17 | LCA350-00-X | D2.21 | LCA600-12H-6 | D2.16 | |
| LCA1/0-12H-X | D2.16 | LCA350-12-X | D2.14 | LCA600-58-6 | D2.14 | |
| LCA1/0-14-X | D2.14 | LCA350-12F-X | D2.18 | LCA600-58F-6 | D2.18 | |
| LCA1/0-14F-X | D2.17 | LCA350-12H-X | D2.16 | LCA600-58H-6 | D2.16 | |
| LCA1/0-14H-X | D2.16 | LCA350-38-X | D2.14 | LCA600-78-6 | D2.14 | |
| | | LCA350-38F-X | D2.18 | | | |

PANDUIT® ELECTRICAL SOLUTIONS

| A. System Overview | Part Number | Page Number | Part Number | Page Number | Part Number | Page Number |
|---------------------------------------|---------------|--------------|---------------|---------------|---------------|-------------|
| B1. Cable Ties | LCA600-78F-6 | D2.18 | LCAF3/0-56F-X | D2.79 | LCAF8-14-L | D2.74 |
| | LCA600-78H-6 | D2.16 | LCAF3/0-56H-X | D2.77 | LCAF8-14F-L | D2.78 |
| | LCA750-58-6 | D2.14 | LCAF300-12-6 | D2.75 | LCAF8-14H-L | D2.76 |
| | LCA8-00-L | D2.21 | LCAF300-12F-6 | D2.79 | LCAF8-38-L | D2.74 |
| | LCA8-10-L | D2.13 | LCAF300-12H-6 | D2.77 | LCAF8-38F-L | D2.78 |
| B2. Cable Accessories | LCA8-10F-L | D2.17 | LCAF300-38-6 | D2.75 | LCAF8-38H-L | D2.76 |
| | LCA8-10H-L | D2.15 | LCAF300-38F-6 | D2.79 | LCAF8-56-L | D2.74 |
| | LCA8-14-L | D2.13 | LCAF300-38H-6 | D2.77 | LCAF8-56F-L | D2.78 |
| | LCA8-14F-L | D2.17 | LCAF300-58-6 | D2.75 | LCAF8-56H-L | D2.76 |
| | LCA8-14H-L | D2.15 | LCAF300-58F-6 | D2.79 | LCAN1-10-E | D2.19 |
| B3. Stainless Steel Ties | LCA8-38-L | D2.13 | LCAF300-58H-6 | D2.77 | LCAN1-14-E | D2.19 |
| | LCA8-38F-L | D2.17 | LCAF300-78-6 | D2.75 | LCAN1/0-10-X | D2.19 |
| | LCA8-38H-L | D2.15 | LCAF300-78F-6 | D2.79 | LCAN1/0-14-X | D2.19 |
| | LCA8-56-L | D2.13 | LCAF300-78H-6 | D2.77 | LCAN1/0-56-X | D2.19 |
| | LCA8-56F-L | D2.17 | LCAF350-1-6 | D2.75 | LCAN2-10-Q | D2.19 |
| C1. Wiring Duct | LCA8-56H-L | D2.15 | LCAF350-12-6 | D2.75 | LCAN2-14-Q | D2.19 |
| | LCAF1-12-X | D2.74 | LCAF350-12F-6 | D2.79 | LCAN2/0-10-X | D2.19 |
| | LCAF1-12F-X | D2.78 | LCAF350-12H-6 | D2.77 | LCAN2/0-14-X | D2.19 |
| | LCAF1-12H-X | D2.76 | LCAF350-1F-6 | D2.79 | LCAN2/0-38-X | D2.19 |
| | LCAF1-14-X | D2.74 | LCAF350-1H-6 | D2.77 | LCAN2/0-56-X | D2.19 |
| C2. Surface Raceway | LCAF1-14F-X | D2.78 | LCAF350-34-6 | D2.75 | LCAN250-14-X | D2.20 |
| | LCAF1-14H-X | D2.76 | LCAF350-34F-6 | D2.79 | LCAN250-38-X | D2.20 |
| | LCAF1-38-X | D2.74 | LCAF350-34H-6 | D2.77 | LCAN3/0-14-X | D2.19 |
| | LCAF1-38F-X | D2.78 | LCAF350-38-6 | D2.75 | LCAN3/0-38-X | D2.19 |
| | LCAF1-38H-X | D2.76 | LCAF350-38F-6 | D2.79 | LCAN3/0-56-X | D2.19 |
| C3. Abrasion Protection | LCAF1-56-X | D2.74 | LCAF350-38H-6 | D2.77 | LCAN300-14-X | D2.20 |
| | LCAF1-56F-X | D2.78 | LCAF350-58-6 | D2.75 | LCAN300-38-X | D2.20 |
| | LCAF1-56H-X | D2.76 | LCAF350-58F-6 | D2.79 | LCAN350-12-X | D2.20 |
| | LCAF1/0-12-X | D2.74 | LCAF350-58H-6 | D2.77 | LCAN350-38-X | D2.20 |
| | LCAF1/0-12F-X | D2.78 | LCAF350-78-6 | D2.75 | LCAN4-10-L | D2.19 |
| C4. Cable Management | LCAF1/0-12H-X | D2.76 | LCAF350-78F-6 | D2.79 | LCAN4-14-L | D2.19 |
| | LCAF1/0-14-X | D2.74 | LCAF350-78H-6 | D2.77 | LCAN4/0-14-X | D2.19 |
| | LCAF1/0-14F-X | D2.78 | LCAF4-10-L | D2.74 | LCAN4/0-38-X | D2.19 |
| | LCAF1/0-14H-X | D2.76 | LCAF4-10F-L | D2.78 | LCAN4/0-56-X | D2.19 |
| | LCAF1/0-38-X | D2.74 | LCAF4-10H-L | D2.76 | LCAN400-12-6 | D2.20 |
| D1. Terminals | LCAF1/0-38F-X | D2.78 | LCAF4-14-L | D2.74 | LCAN400-38-6 | D2.20 |
| | LCAF1/0-38H-X | D2.76 | LCAF4-14F-L | D2.78 | LCAN500-12-6 | D2.20 |
| | LCAF1/0-56-X | D2.74 | LCAF4-14H-L | D2.76 | LCAN500-38-6 | D2.20 |
| | LCAF1/0-56F-X | D2.78 | LCAF4-38-L | D2.74 | LCAN6-6-L | D2.19 |
| | LCAF1/0-56H-X | D2.76 | LCAF4-38F-L | D2.78 | LCAN600-12-6 | D2.20 |
| D2. Power Connectors | LCAF2-12-E | D2.74 | LCAF4-38H-L | D2.76 | LCAN600-38-6 | D2.20 |
| | LCAF2-12F-E | D2.78 | LCAF4-56-L | D2.74 | LCAN750-12-6 | D2.20 |
| | LCAF2-12H-E | D2.76 | LCAF4-56F-L | D2.78 | LCAN750-38-6 | D2.20 |
| | LCAF2-14-E | D2.74 | LCAF4-56H-L | D2.76 | LCAN750-58-6 | D2.20 |
| | LCAF2-14F-E | D2.78 | LCAF4/0-12-X | D2.75 | LCAN8-6-L | D2.19 |
| D3. Grounding Connectors | LCAF2-14H-E | D2.76 | LCAF4/0-12F-X | D2.79 | LCAS1-12-E | D2.7 |
| | LCAF2-38-E | D2.74 | LCAF4/0-12H-X | D2.77 | LCAS1-12F-E | D2.11 |
| | LCAF2-38F-E | D2.78 | LCAF4/0-14-X | D2.75 | LCAS1-12H-E | D2.9 |
| | LCAF2-38H-E | D2.76 | LCAF4/0-14F-X | D2.79 | LCAS1-14-E | D2.7 |
| | LCAF2-56-E | D2.74 | LCAF4/0-14H-X | D2.77 | LCAS1-14F-E | D2.11 |
| E1. Labeling Systems | LCAF2-56F-E | D2.78 | LCAF4/0-38-X | D2.75 | LCAS1-14H-E | D2.9 |
| | LCAF2-56H-E | D2.76 | LCAF4/0-38F-X | D2.79 | LCAS1-38-E | D2.7 |
| | LCAF2/0-12-X | D2.74 | LCAF4/0-38H-X | D2.77 | LCAS1-38F-E | D2.11 |
| | LCAF2/0-12F-X | D2.78 | LCAF4/0-56-X | D2.75 | LCAS1-38H-E | D2.9 |
| | LCAF2/0-12H-X | D2.76 | LCAF4/0-56F-X | D2.79 | LCAS1-56-E | D2.7 |
| E2. Labels | LCAF2/0-14-X | D2.74 | LCAF4/0-56H-X | D2.77 | LCAS1-56F-E | D2.11 |
| | LCAF2/0-14F-X | D2.78 | LCAF400-12-6 | D2.75 | LCAS1-56H-E | D2.9 |
| | LCAF2/0-14H-X | D2.76 | LCAF400-12F-6 | D2.79 | LCAS1/0-12-X | D2.7 |
| | LCAF2/0-38-X | D2.74 | LCAF400-12H-6 | D2.77 | LCAS1/0-12F-X | D2.11 |
| | LCAF2/0-38F-X | D2.78 | LCAF400-58-6 | D2.75 | LCAS1/0-12H-X | D2.9 |
| E3. Pre-Printed & Write-On Markers | LCAF2/0-38H-X | D2.76 | LCAF400-58F-6 | D2.79 | LCAS1/0-14-X | D2.7 |
| | LCAF2/0-56-X | D2.74 | LCAF400-58H-6 | D2.77 | LCAS1/0-14F-X | D2.11 |
| | LCAF2/0-56F-X | D2.78 | LCAF400-78-6 | D2.75 | LCAS1/0-14H-X | D2.9 |
| | LCAF2/0-56H-X | D2.76 | LCAF400-78F-6 | D2.79 | LCAS1/0-38-X | D2.7 |
| | LCAF250-12-X | D2.75 | LCAF400-78H-6 | D2.77 | LCAS1/0-38F-X | D2.11 |
| E4. Permanent Identification | LCAF250-12F-X | D2.79 | LCAF500-12-6 | D2.75 | LCAS1/0-38H-X | D2.9 |
| | LCAF250-12H-X | D2.77 | LCAF500-58-6 | D2.75 | LCAS1/0-56-X | D2.7 |
| | LCAF250-38-X | D2.75 | LCAF6-10-L | D2.74 | LCAS1/0-56F-X | D2.11 |
| | LCAF250-38F-X | D2.79 | LCAF6-10F-L | D2.78 | LCAS1/0-56H-X | D2.9 |
| | LCAF250-38H-X | D2.77 | LCAF6-10H-L | D2.76 | LCAS2-12-Q | D2.7 |
| E5. Lockout/Tagout & Safety Solutions | LCAF250-58-X | D2.75 | LCAF6-14-L | D2.74 | LCAS2-12F-Q | D2.11 |
| | LCAF250-58F-X | D2.79 | LCAF6-14F-L | D2.78 | LCAS2-12H-Q | D2.9 |
| | LCAF250-58H-X | D2.77 | LCAF6-14H-L | D2.76 | LCAS2-14-Q | D2.7 |
| | LCAF250-78-X | D2.75 | LCAF6-38-L | D2.74 | LCAS2-14F-Q | D2.11 |
| | LCAF250-78F-X | D2.79 | LCAF6-38F-L | D2.78 | LCAS2-14H-Q | D2.9 |
| F. Index | LCAF250-78H-X | D2.77 | LCAF6-38H-L | D2.76 | LCAS2-38-Q | D2.7 |
| | LCAF3/0-12-X | D2.75 | LCAF6-56-L | D2.74 | LCAS2-38F-Q | D2.11 |
| | LCAF3/0-12F-X | D2.79 | LCAF6-56F-L | D2.78 | LCAS2-38H-Q | D2.9 |
| | LCAF3/0-12H-X | D2.77 | LCAF6-56H-L | D2.76 | LCAS2-56-Q | D2.7 |
| | LCAF3/0-14-X | D2.75 | LCAF600-12-6 | D2.75 | LCAS2-56F-Q | D2.11 |
| LCAF3/0-14F-X | D2.79 | LCAF600-58-6 | D2.75 | LCAS2-56H-Q | D2.9 | |
| LCAF3/0-14H-X | D2.77 | LCAF750-12-3 | D2.75 | LCAS2/0-12-X | D2.7 | |
| LCAF3/0-38-X | D2.75 | LCAF750-58-3 | D2.75 | LCAS2/0-12F-X | D2.11 | |
| LCAF3/0-38F-X | D2.79 | LCAF8-10-L | D2.74 | LCAS2/0-12H-X | D2.9 | |
| LCAF3/0-38H-X | D2.77 | LCAF8-10F-L | D2.78 | LCAS2/0-14-X | D2.7 | |
| LCAF3/0-56-X | D2.75 | LCAF8-10H-L | D2.76 | LCAS2/0-14F-X | D2.11 | |

PANDUIT® ELECTRICAL SOLUTIONS

| Part Number | Page Number | Part Number | Page Number | Part Number | Page Number |
|---------------|-------------|---------------|-------------|---------------|-------------|
| LCAS2/0-14H-X | D2.9 | LCAX1-14F-X | D2.70 | LCAX3/0-56-X | D2.67 |
| LCAS2/0-38-X | D2.7 | LCAX1-14H-X | D2.68 | LCAX3/0-56F-X | D2.71 |
| LCAS2/0-38F-X | D2.11 | LCAX1-38-X | D2.66 | LCAX3/0-56H-X | D2.69 |
| LCAS2/0-38H-X | D2.9 | LCAX1-38F-X | D2.70 | LCAX300-12-6 | D2.67 |
| LCAS2/0-56-X | D2.7 | LCAX1-38H-X | D2.68 | LCAX300-12F-6 | D2.71 |
| LCAS2/0-56F-X | D2.11 | LCAX1-56-X | D2.66 | LCAX300-12H-6 | D2.69 |
| LCAS2/0-56H-X | D2.9 | LCAX1-56F-X | D2.70 | LCAX300-38-6 | D2.67 |
| LCAS250-12-X | D2.8 | LCAX1-56H-X | D2.68 | LCAX300-38F-6 | D2.71 |
| LCAS250-12F-X | D2.12 | LCAX1/0-12-X | D2.66 | LCAX300-38H-6 | D2.69 |
| LCAS250-12H-X | D2.10 | LCAX1/0-12F-X | D2.70 | LCAX300-58-6 | D2.67 |
| LCAS250-14-X | D2.8 | LCAX1/0-12H-X | D2.68 | LCAX300-58F-6 | D2.71 |
| LCAS250-14F-X | D2.12 | LCAX1/0-14-X | D2.66 | LCAX300-58H-6 | D2.69 |
| LCAS250-14H-X | D2.10 | LCAX1/0-14F-X | D2.70 | LCAX350-12-6 | D2.67 |
| LCAS250-38-X | D2.8 | LCAX1/0-14H-X | D2.68 | LCAX350-12F-6 | D2.71 |
| LCAS250-38F-X | D2.12 | LCAX1/0-38-X | D2.66 | LCAX350-12H-6 | D2.69 |
| LCAS250-38H-X | D2.10 | LCAX1/0-38F-X | D2.70 | LCAX350-38-6 | D2.67 |
| LCAS250-56-X | D2.8 | LCAX1/0-38H-X | D2.68 | LCAX350-38F-6 | D2.71 |
| LCAS250-56F-X | D2.12 | LCAX1/0-56-X | D2.66 | LCAX350-38H-6 | D2.69 |
| LCAS250-56H-X | D2.10 | LCAX1/0-56F-X | D2.70 | LCAX350-56-6 | D2.67 |
| LCAS3/0-12-X | D2.8 | LCAX1/0-56H-X | D2.68 | LCAX350-56F-6 | D2.71 |
| LCAS3/0-12F-X | D2.12 | LCAX2-10-E | D2.66 | LCAX350-56H-6 | D2.69 |
| LCAS3/0-12H-X | D2.10 | LCAX2-10F-E | D2.70 | LCAX350-58-6 | D2.67 |
| LCAS3/0-14-X | D2.8 | LCAX2-10H-E | D2.68 | LCAX350-58F-6 | D2.71 |
| LCAS3/0-14F-X | D2.12 | LCAX2-12-E | D2.66 | LCAX350-58H-6 | D2.69 |
| LCAS3/0-14H-X | D2.10 | LCAX2-12F-E | D2.70 | LCAX4-10-L | D2.66 |
| LCAS3/0-38-X | D2.8 | LCAX2-12H-E | D2.68 | LCAX4-10F-L | D2.70 |
| LCAS3/0-38F-X | D2.12 | LCAX2-14-E | D2.66 | LCAX4-10H-L | D2.68 |
| LCAS3/0-38H-X | D2.10 | LCAX2-14F-E | D2.70 | LCAX4-14-L | D2.66 |
| LCAS3/0-56-X | D2.8 | LCAX2-14H-E | D2.68 | LCAX4-14F-L | D2.70 |
| LCAS3/0-56F-X | D2.12 | LCAX2-38-E | D2.66 | LCAX4-14H-L | D2.68 |
| LCAS3/0-56H-X | D2.10 | LCAX2-38F-E | D2.70 | LCAX4-38-L | D2.66 |
| LCAS4-10-L | D2.7 | LCAX2-38H-E | D2.68 | LCAX4-38F-L | D2.70 |
| LCAS4-10F-L | D2.11 | LCAX2-56-E | D2.66 | LCAX4-38H-L | D2.68 |
| LCAS4-10H-L | D2.9 | LCAX2-56F-E | D2.70 | LCAX4-56-L | D2.66 |
| LCAS4-14-L | D2.7 | LCAX2-56H-E | D2.68 | LCAX4-56F-L | D2.70 |
| LCAS4-14F-L | D2.11 | LCAX2/0-10-X | D2.67 | LCAX4-56H-L | D2.68 |
| LCAS4-14H-L | D2.9 | LCAX2/0-10F-X | D2.71 | LCAX4/0-12-X | D2.67 |
| LCAS4-38-L | D2.7 | LCAX2/0-10H-X | D2.69 | LCAX4/0-12F-X | D2.71 |
| LCAS4-38F-L | D2.11 | LCAX2/0-12-X | D2.67 | LCAX4/0-12H-X | D2.69 |
| LCAS4-38H-L | D2.9 | LCAX2/0-12F-X | D2.71 | LCAX4/0-14-X | D2.67 |
| LCAS4-56-L | D2.7 | LCAX2/0-12H-X | D2.69 | LCAX4/0-14F-X | D2.71 |
| LCAS4-56F-L | D2.11 | LCAX2/0-14-X | D2.67 | LCAX4/0-14H-X | D2.69 |
| LCAS4-56H-L | D2.9 | LCAX2/0-14F-X | D2.71 | LCAX4/0-34-X | D2.67 |
| LCAS4/0-12-X | D2.8 | LCAX2/0-14H-X | D2.69 | LCAX4/0-34F-X | D2.71 |
| LCAS4/0-12F-X | D2.12 | LCAX2/0-34-X | D2.67 | LCAX4/0-34H-X | D2.69 |
| LCAS4/0-12H-X | D2.10 | LCAX2/0-34F-X | D2.71 | LCAX4/0-38-X | D2.67 |
| LCAS4/0-14-X | D2.8 | LCAX2/0-34H-X | D2.69 | LCAX4/0-38F-X | D2.71 |
| LCAS4/0-14F-X | D2.12 | LCAX2/0-38-X | D2.67 | LCAX4/0-38H-X | D2.69 |
| LCAS4/0-14H-X | D2.10 | LCAX2/0-38F-X | D2.71 | LCAX4/0-56-X | D2.67 |
| LCAS4/0-38-X | D2.8 | LCAX2/0-38H-X | D2.69 | LCAX4/0-56F-X | D2.71 |
| LCAS4/0-38F-X | D2.12 | LCAX2/0-56-X | D2.67 | LCAX4/0-56H-X | D2.69 |
| LCAS4/0-38H-X | D2.10 | LCAX2/0-56F-X | D2.71 | LCAX4/0-58-X | D2.67 |
| LCAS4/0-56-X | D2.8 | LCAX2/0-56H-X | D2.69 | LCAX4/0-58F-X | D2.71 |
| LCAS4/0-56F-X | D2.12 | LCAX2/0-58-X | D2.67 | LCAX4/0-58H-X | D2.69 |
| LCAS4/0-56H-X | D2.10 | LCAX2/0-58F-X | D2.71 | LCAX450-12-6 | D2.67 |
| LCAS6-10-L | D2.7 | LCAX2/0-58H-X | D2.69 | LCAX450-12F-6 | D2.71 |
| LCAS6-10F-L | D2.11 | LCAX250-12-X | D2.67 | LCAX450-12H-6 | D2.69 |
| LCAS6-10H-L | D2.9 | LCAX250-12F-X | D2.71 | LCAX450-58-6 | D2.67 |
| LCAS6-14-L | D2.7 | LCAX250-12H-X | D2.69 | LCAX450-58F-6 | D2.71 |
| LCAS6-14F-L | D2.11 | LCAX250-14-X | D2.67 | LCAX450-58H-6 | D2.69 |
| LCAS6-14H-L | D2.9 | LCAX250-14F-X | D2.71 | LCAX500-12-6 | D2.67 |
| LCAS6-38-L | D2.7 | LCAX250-14H-X | D2.69 | LCAX500-12F-6 | D2.71 |
| LCAS6-38F-L | D2.11 | LCAX250-34-X | D2.67 | LCAX500-12H-6 | D2.69 |
| LCAS6-38H-L | D2.9 | LCAX250-34F-X | D2.71 | LCAX500-38-6 | D2.67 |
| LCAS6-56-L | D2.7 | LCAX250-34H-X | D2.69 | LCAX500-38F-6 | D2.71 |
| LCAS6-56F-L | D2.11 | LCAX250-38-X | D2.67 | LCAX500-38H-6 | D2.69 |
| LCAS6-56H-L | D2.9 | LCAX250-38F-X | D2.71 | LCAX500-56-6 | D2.67 |
| LCAS8-10-L | D2.7 | LCAX250-38H-X | D2.69 | LCAX500-56F-6 | D2.71 |
| LCAS8-10F-L | D2.11 | LCAX250-56-X | D2.67 | LCAX500-56H-6 | D2.69 |
| LCAS8-10H-L | D2.9 | LCAX250-56F-X | D2.71 | LCAX500-58-6 | D2.67 |
| LCAS8-14-L | D2.7 | LCAX250-56H-X | D2.69 | LCAX500-58F-6 | D2.71 |
| LCAS8-14F-L | D2.11 | LCAX250-58-X | D2.67 | LCAX500-58H-6 | D2.69 |
| LCAS8-14H-L | D2.9 | LCAX250-58F-X | D2.71 | LCAX6-10-L | D2.66 |
| LCAS8-38-L | D2.7 | LCAX250-58H-X | D2.69 | LCAX6-10F-L | D2.70 |
| LCAS8-38F-L | D2.11 | LCAX3/0-10-X | D2.67 | LCAX6-10H-L | D2.68 |
| LCAS8-38H-L | D2.9 | LCAX3/0-10F-X | D2.71 | LCAX6-14-L | D2.66 |
| LCAS8-56-L | D2.7 | LCAX3/0-10H-X | D2.69 | LCAX6-14F-L | D2.70 |
| LCAS8-56F-L | D2.11 | LCAX3/0-12-X | D2.67 | LCAX6-14H-L | D2.68 |
| LCAS8-56H-L | D2.9 | LCAX3/0-12F-X | D2.71 | LCAX6-38-L | D2.66 |
| LCAX1-10-X | D2.66 | LCAX3/0-12H-X | D2.69 | LCAX6-38F-L | D2.70 |
| LCAX1-10F-X | D2.70 | LCAX3/0-14-X | D2.67 | LCAX6-38H-L | D2.68 |
| LCAX1-10H-X | D2.68 | LCAX3/0-14F-X | D2.71 | LCAX6-56-L | D2.66 |
| LCAX1-12-X | D2.66 | LCAX3/0-14H-X | D2.69 | LCAX6-56F-L | D2.70 |
| LCAX1-12F-X | D2.70 | LCAX3/0-38-X | D2.67 | LCAX6-56H-L | D2.68 |
| LCAX1-12H-X | D2.68 | LCAX3/0-38F-X | D2.71 | LCAX650-12-6 | D2.67 |
| LCAX1-14-X | D2.66 | LCAX3/0-38H-X | D2.69 | LCAX650-12F-6 | D2.71 |

A. System Overview

B1. Cable Ties

B2. Cable Accessories

B3. Stainless Steel Ties

C1. Wiring Duct

C2. Surface Raceway

C3. Abrasion Protection

C4. Cable Management

D1. Terminals

D2. Power Connectors

D3. Grounding Connectors

E1. Labeling Systems

E2. Labels

E3. Pre-Printed & Write-On Markers

E4. Permanent Identification

E5. Lockout/Tagout & Safety Solutions

F. Index

PANDUIT® ELECTRICAL SOLUTIONS

| A. System Overview | Part Number | Page Number | Part Number | Page Number | Part Number | Page Number |
|---------------------------------------|----------------|-------------|--------------|-------------|---------------|-------------|
| B1. Cable Ties | LCAX650-12H-6 | D2.69 | LCB300-38F-X | D2.27 | LCBX1-38-X | D2.80 |
| | LCAX650-38-6 | D2.67 | LCB300-38H-X | D2.25 | LCBX1-38F-X | D2.82 |
| | LCAX650-38F-6 | D2.71 | LCB300-56-X | D2.23 | LCBX1-38H-X | D2.81 |
| | LCAX650-38H-6 | D2.69 | LCB300-56F-X | D2.27 | LCBX1-56-X | D2.80 |
| B2. Cable Accessories | LCAX650-56-6 | D2.67 | LCB300-56H-X | D2.25 | LCBX1-56F-X | D2.82 |
| | LCAX650-56F-6 | D2.71 | LCB350-12-X | D2.23 | LCBX1-56H-X | D2.81 |
| | LCAX650-56H-6 | D2.69 | LCB350-12F-X | D2.27 | LCBX1/0-12-X | D2.80 |
| | LCAX650-58-6 | D2.67 | LCB350-12H-X | D2.25 | LCBX1/0-12F-X | D2.82 |
| | LCAX650-58F-6 | D2.71 | LCB350-78-X | D2.23 | LCBX1/0-12H-X | D2.81 |
| | LCAX650-58H-6 | D2.69 | LCB350-78F-X | D2.27 | LCBX1/0-14-X | D2.80 |
| B3. Stainless Steel Ties | LCAX750-12-3 | D2.67 | LCB350-78H-X | D2.25 | LCBX1/0-14F-X | D2.82 |
| | LCAX750-12F-3 | D2.71 | LCB4-10-L | D2.22 | LCBX1/0-14H-X | D2.81 |
| | LCAX750-12H-3 | D2.69 | LCB4-10F-L | D2.26 | LCBX1/0-38-X | D2.80 |
| | LCAX750-58-3 | D2.67 | LCB4-10H-L | D2.24 | LCBX1/0-38F-X | D2.82 |
| | LCAX750-58F-3 | D2.71 | LCB4-14-L | D2.22 | LCBX1/0-38H-X | D2.81 |
| | LCAX750-58H-3 | D2.69 | LCB4-14F-L | D2.26 | LCBX2-12-E | D2.80 |
| C1. Wiring Duct | LCAX8-10-L | D2.66 | LCB4-14H-L | D2.24 | LCBX2-12F-E | D2.82 |
| | LCAX8-10F-L | D2.70 | LCB4-38-L | D2.22 | LCBX2-12H-E | D2.81 |
| | LCAX8-10H-L | D2.68 | LCB4-56-L | D2.22 | LCBX2-14-E | D2.80 |
| | LCAX8-14-L | D2.66 | LCB4/0-12-X | D2.23 | LCBX2-14F-E | D2.82 |
| | LCAX8-14F-L | D2.70 | LCB4/0-12F-X | D2.26 | LCBX2-14H-E | D2.81 |
| | LCAX8-14H-L | D2.68 | LCB4/0-12H-X | D2.25 | LCBX2-38-E | D2.80 |
| C2. Surface Raceway | LCAX8-38-L | D2.66 | LCB4/0-38-X | D2.23 | LCBX2-38F-E | D2.82 |
| | LCAX8-38F-L | D2.70 | LCB4/0-38F-X | D2.26 | LCBX2-38H-E | D2.81 |
| | LCAX8-38H-L | D2.68 | LCB4/0-38H-X | D2.25 | LCBX2/0-12-X | D2.80 |
| | LCAX8-56-L | D2.66 | LCB400-12-6 | D2.23 | LCBX2/0-12F-X | D2.82 |
| | LCAX8-56F-L | D2.70 | LCB400-12F-6 | D2.27 | LCBX2/0-12H-X | D2.81 |
| | LCAX8-56H-L | D2.68 | LCB400-12H-6 | D2.25 | LCBX2/0-14-X | D2.80 |
| C3. Abrasion Protection | LCAXN250-12-X | D2.72 | LCB400-38-6 | D2.23 | LCBX2/0-14F-X | D2.82 |
| | LCAXN250-12F-X | D2.73 | LCB400-58-6 | D2.23 | LCBX2/0-14H-X | D2.81 |
| | LCAXN250-12H-X | D2.72 | LCB400-58F-6 | D2.27 | LCBX2/0-38-X | D2.80 |
| | LCB1-10-E | D2.22 | LCB400-58H-6 | D2.25 | LCBX2/0-38F-X | D2.82 |
| | LCB1-10F-E | D2.26 | LCB400-78-6 | D2.23 | LCBX2/0-38H-X | D2.81 |
| | LCB1-10H-E | D2.24 | LCB400-78F-6 | D2.27 | LCBX250-38-X | D2.80 |
| C4. Cable Management | LCB1-38-E | D2.22 | LCB400-78H-6 | D2.25 | LCBX250-38F-X | D2.82 |
| | LCB1-56-E | D2.22 | LCB500-12-6 | D2.23 | LCBX250-38H-X | D2.81 |
| | LCB1-56F-E | D2.26 | LCB500-12F-6 | D2.27 | LCBX3/0-38-X | D2.80 |
| | LCB1-56H-E | D2.24 | LCB500-12H-6 | D2.25 | LCBX3/0-38F-X | D2.82 |
| | LCB1/0-10-X | D2.22 | LCB500-58-6 | D2.23 | LCBX3/0-38H-X | D2.81 |
| | LCB1/0-10F-X | D2.26 | LCB500-58F-6 | D2.27 | LCBX300-12F-6 | D2.82 |
| D1. Terminals | LCB1/0-10H-X | D2.24 | LCB500-58H-6 | D2.25 | LCBX300-12H-6 | D2.81 |
| | LCB1/0-12-X | D2.22 | LCB500-78-6 | D2.23 | LCBX300-38-6 | D2.80 |
| | LCB1/0-12F-X | D2.26 | LCB500-78F-6 | D2.27 | LCBX300-38F-6 | D2.82 |
| | LCB1/0-12H-X | D2.24 | LCB500-78H-6 | D2.25 | LCBX300-38H-6 | D2.81 |
| | LCB1/0-38-X | D2.22 | LCB6-10-L | D2.22 | LCBX350-12-6 | D2.80 |
| | LCB1/0-38F-X | D2.26 | LCB6-10F-L | D2.26 | LCBX350-12F-6 | D2.82 |
| D2. Power Connectors | LCB1/0-38H-X | D2.24 | LCB6-10H-L | D2.24 | LCBX350-12H-6 | D2.81 |
| | LCB1/0-56-X | D2.22 | LCB6-14-L | D2.22 | LCBX350-38-6 | D2.80 |
| | LCB1/0-56F-X | D2.26 | LCB6-14F-L | D2.26 | LCBX350-38F-6 | D2.82 |
| | LCB1/0-56H-X | D2.24 | LCB6-14H-L | D2.24 | LCBX350-38H-6 | D2.81 |
| | LCB10-14W-L | D2.28 | LCB6-38-L | D2.22 | LCBX4-14-L | D2.80 |
| | LCB10-14WF-L | D2.29 | LCB6-38F-L | D2.26 | LCBX4-14F-L | D2.82 |
| D3. Grounding Connectors | LCB10-14WH-L | D2.29 | LCB6-38H-L | D2.24 | LCBX4-14H-L | D2.81 |
| | LCB1000-12W-3 | D2.28 | LCB600-12-6 | D2.23 | LCBX4-38-L | D2.80 |
| | LCB1000-38W-3 | D2.28 | LCB600-12F-6 | D2.27 | LCBX4-38F-L | D2.82 |
| | LCB1000-58-3 | D2.23 | LCB600-12H-6 | D2.25 | LCBX4-38H-L | D2.81 |
| | LCB1000-58W-3 | D2.28 | LCB600-58-6 | D2.23 | LCBX4/0-12-X | D2.80 |
| | LCB2-10-Q | D2.22 | LCB600-58F-6 | D2.27 | LCBX4/0-12F-X | D2.82 |
| E1. Labeling Systems | LCB2-10F-Q | D2.26 | LCB600-58H-6 | D2.25 | LCBX4/0-12H-X | D2.81 |
| | LCB2-10H-Q | D2.24 | LCB750-12W-6 | D2.28 | LCBX4/0-38-X | D2.80 |
| | LCB2-38-Q | D2.22 | LCB750-38W-6 | D2.28 | LCBX4/0-38F-X | D2.82 |
| | LCB2-56-Q | D2.22 | LCB750-58-6 | D2.23 | LCBX4/0-38H-X | D2.81 |
| | LCB2-56F-Q | D2.26 | LCB750-58W-6 | D2.28 | LCBX450-38-6 | D2.80 |
| | LCB2-56H-Q | D2.24 | LCB750-78-6 | D2.23 | LCBX450-38F-6 | D2.82 |
| E2. Labels | LCB2/0-12-X | D2.23 | LCB750-78W-6 | D2.28 | LCBX450-38H-6 | D2.81 |
| | LCB2/0-12F-X | D2.26 | LCB8-10-L | D2.22 | LCBX500-12-6 | D2.80 |
| | LCB2/0-12H-X | D2.24 | LCB8-10F-L | D2.26 | LCBX500-12F-6 | D2.82 |
| | LCB2/0-38-X | D2.23 | LCB8-10H-L | D2.24 | LCBX500-12H-6 | D2.81 |
| | LCB2/0-38F-X | D2.26 | LCB8-14-L | D2.22 | LCBX500-38-6 | D2.80 |
| | LCB2/0-38H-X | D2.24 | LCB8-14F-L | D2.26 | LCBX500-38F-6 | D2.82 |
| E3. Pre-Printed & Write-On Markers | LCB250-12-X | D2.23 | LCB8-14H-L | D2.24 | LCBX500-38H-6 | D2.81 |
| | LCB250-12F-X | D2.27 | LCB8-38-L | D2.22 | LCBX6-14-L | D2.80 |
| | LCB250-12H-X | D2.25 | LCB800-12W-6 | D2.28 | LCBX6-14F-L | D2.82 |
| | LCB250-78-X | D2.23 | LCB800-58-6 | D2.23 | LCBX6-14H-L | D2.81 |
| | LCB250-78F-X | D2.27 | LCB800-58W-6 | D2.28 | LCBX6-38-L | D2.80 |
| | LCB250-78H-X | D2.25 | LCBH1-38-E | D2.30 | LCBX6-38F-L | D2.82 |
| E4. Permanent Identification | LCB3/0-12-X | D2.23 | LCBH1/0-38-X | D2.30 | LCBX6-38H-L | D2.81 |
| | LCB3/0-12F-X | D2.26 | LCBH2-38-Q | D2.30 | LCBX8-10-L | D2.80 |
| | LCB3/0-12H-X | D2.24 | LCBH2/0-12-X | D2.30 | LCBX8-10F-L | D2.82 |
| | LCB3/0-38-X | D2.23 | LCBH250-12-X | D2.30 | LCBX8-10H-L | D2.81 |
| | LCB3/0-38F-X | D2.26 | LCBH3/0-12-X | D2.30 | LCBX8-14-L | D2.80 |
| | LCB3/0-38H-X | D2.24 | LCBH4-38-L | D2.30 | LCBX8-14F-L | D2.82 |
| E5. Lockout/Tagout & Safety Solutions | LCB300-12-X | D2.23 | LCBH4/0-12-X | D2.30 | LCBX8-14H-L | D2.81 |
| | LCB300-12F-X | D2.27 | LCBX1-14-X | D2.80 | LCBX8-38-L | D2.80 |
| | LCB300-12H-X | D2.25 | LCBX1-14F-X | D2.82 | LCBX8-38F-L | D2.82 |
| | LCB300-38-X | D2.23 | LCBX1-14H-X | D2.81 | LCBX8-38H-L | D2.81 |
| | | | | | | |
| | | | | | | |
| F. Index | | | | | | |
| | | | | | | |

PANDUIT® ELECTRICAL SOLUTIONS

| Part Number | Page Number | Part Number | Page Number | Part Number | Page Number |
|----------------|-------------|----------------|-------------|----------------|-------------|
| LCC1-00-E | D2.57 | LCC10-14BWF-L | D2.53 | LCC2/0-14AW-X | D2.48 |
| LCC1-00W-E | D2.58 | LCC10-14BWH-L | D2.50 | LCC2/0-14AWF-X | D2.54 |
| LCC1-12-E | D2.41 | LCC10-14JAW-L | D2.47 | LCC2/0-14AWH-X | D2.51 |
| LCC1-12F-E | D2.46 | LCC10-14JAWF-L | D2.53 | LCC2/0-14B-X | D2.42 |
| LCC1-12H-E | D2.44 | LCC10-14JAWH-L | D2.50 | LCC2/0-14BF-X | D2.46 |
| LCC1-12W-E | D2.48 | LCC1000-00-3 | D2.57 | LCC2/0-14BH-X | D2.44 |
| LCC1-12WF-E | D2.54 | LCC1000-12-3 | D2.42 | LCC2/0-14BW-X | D2.48 |
| LCC1-12WH-E | D2.51 | LCC1000-12W-3 | D2.49 | LCC2/0-14BWF-X | D2.54 |
| LCC1-14A-E | D2.41 | LCC1000-38D-3 | D2.42 | LCC2/0-14BWH-X | D2.51 |
| LCC1-14AF-E | D2.46 | LCC1000-38DW-3 | D2.49 | LCC2/0-38D-X | D2.42 |
| LCC1-14AH-E | D2.44 | LCC2-00-Q | D2.57 | LCC2/0-38DF-X | D2.46 |
| LCC1-14AW-E | D2.48 | LCC2-00W-Q | D2.58 | LCC2/0-38DH-X | D2.44 |
| LCC1-14AWF-E | D2.54 | LCC2-10AW-Q | D2.48 | LCC2/0-38DW-X | D2.48 |
| LCC1-14AWH-E | D2.51 | LCC2-10AWF-Q | D2.54 | LCC2/0-38DWF-X | D2.54 |
| LCC1-14B-E | D2.41 | LCC2-10AWH-Q | D2.51 | LCC2/0-38DWH-X | D2.51 |
| LCC1-14BF-E | D2.46 | LCC2-10BW-Q | D2.48 | LCC2/0-56D-X | D2.42 |
| LCC1-14BH-E | D2.44 | LCC2-10BWF-Q | D2.54 | LCC2/0-56DF-X | D2.46 |
| LCC1-14BW-E | D2.48 | LCC2-10BWH-Q | D2.51 | LCC2/0-56DH-X | D2.44 |
| LCC1-14BWF-E | D2.54 | LCC2-12-Q | D2.41 | LCC2/0-56DW-X | D2.48 |
| LCC1-14BWH-E | D2.51 | LCC2-12F-Q | D2.45 | LCC2/0-56DWF-X | D2.54 |
| LCC1-38D-E | D2.41 | LCC2-12H-Q | D2.43 | LCC2/0-56DWH-X | D2.51 |
| LCC1-38DF-E | D2.46 | LCC2-12W-Q | D2.48 | LCC250-00-X | D2.57 |
| LCC1-38DH-E | D2.44 | LCC2-12WF-Q | D2.54 | LCC250-00W-X | D2.58 |
| LCC1-38DW-E | D2.48 | LCC2-12WH-Q | D2.51 | LCC250-12-X | D2.42 |
| LCC1-38DWF-E | D2.54 | LCC2-14A-Q | D2.41 | LCC250-12D-X | D2.42 |
| LCC1-38DWH-E | D2.51 | LCC2-14AF-Q | D2.45 | LCC250-12DF-X | D2.46 |
| LCC1-56B-E | D2.41 | LCC2-14AH-Q | D2.43 | LCC250-12DH-X | D2.44 |
| LCC1-56BF-E | D2.46 | LCC2-14AW-Q | D2.48 | LCC250-12DW-X | D2.49 |
| LCC1-56BH-E | D2.44 | LCC2-14AWF-Q | D2.54 | LCC250-12DWF-X | D2.55 |
| LCC1-56BW-E | D2.48 | LCC2-14AWH-Q | D2.51 | LCC250-12DWH-X | D2.52 |
| LCC1-56BWF-E | D2.54 | LCC2-14B-Q | D2.41 | LCC250-12F-X | D2.46 |
| LCC1-56BWH-E | D2.51 | LCC2-14BF-Q | D2.45 | LCC250-12H-X | D2.44 |
| LCC1-56C-E | D2.41 | LCC2-14BH-Q | D2.43 | LCC250-12W-X | D2.49 |
| LCC1-56CF-E | D2.46 | LCC2-14BW-Q | D2.48 | LCC250-12WF-X | D2.55 |
| LCC1-56CH-E | D2.44 | LCC2-14BWF-Q | D2.54 | LCC250-12WH-X | D2.52 |
| LCC1-56CW-E | D2.48 | LCC2-14BWH-Q | D2.51 | LCC250-38D-X | D2.42 |
| LCC1-56CWF-E | D2.54 | LCC2-14DW-Q | D2.48 | LCC250-38DF-X | D2.46 |
| LCC1-56CWH-E | D2.51 | LCC2-14DWF-Q | D2.54 | LCC250-38DH-X | D2.44 |
| LCC1/0-00-X | D2.57 | LCC2-14DWH-Q | D2.51 | LCC250-38DW-X | D2.49 |
| LCC1/0-00W-X | D2.58 | LCC2-38-Q | D2.41 | LCC250-38DWF-X | D2.55 |
| LCC1/0-12-X | D2.42 | LCC2-38BW-Q | D2.48 | LCC250-38DWH-X | D2.52 |
| LCC1/0-12D-X | D2.42 | LCC2-38BWF-Q | D2.54 | LCC250-56DW-X | D2.49 |
| LCC1/0-12DF-X | D2.46 | LCC2-38BWH-Q | D2.51 | LCC250-56DWF-X | D2.55 |
| LCC1/0-12DH-X | D2.44 | LCC2-38CW-Q | D2.48 | LCC250-56DWH-X | D2.52 |
| LCC1/0-12DW-X | D2.48 | LCC2-38CWF-Q | D2.54 | LCC3/0-00-X | D2.57 |
| LCC1/0-12DWF-X | D2.54 | LCC2-38CWH-Q | D2.51 | LCC3/0-00W-X | D2.58 |
| LCC1/0-12DWH-X | D2.51 | LCC2-38D-Q | D2.41 | LCC3/0-12-X | D2.42 |
| LCC1/0-12F-X | D2.46 | LCC2-38DF-Q | D2.45 | LCC3/0-12D-X | D2.42 |
| LCC1/0-12H-X | D2.44 | LCC2-38DH-Q | D2.43 | LCC3/0-12DF-X | D2.46 |
| LCC1/0-12W-X | D2.48 | LCC2-38DW-Q | D2.48 | LCC3/0-12DH-X | D2.44 |
| LCC1/0-12WF-X | D2.54 | LCC2-38DWF-Q | D2.54 | LCC3/0-12DW-X | D2.49 |
| LCC1/0-12WH-X | D2.51 | LCC2-38DWH-Q | D2.51 | LCC3/0-12DWF-X | D2.54 |
| LCC1/0-14A-X | D2.42 | LCC2-38F-Q | D2.45 | LCC3/0-12DWH-X | D2.51 |
| LCC1/0-14AF-X | D2.46 | LCC2-38H-Q | D2.43 | LCC3/0-12F-X | D2.46 |
| LCC1/0-14AH-X | D2.44 | LCC2-38W-Q | D2.48 | LCC3/0-12H-X | D2.44 |
| LCC1/0-14AW-X | D2.48 | LCC2-38WF-Q | D2.54 | LCC3/0-12W-X | D2.49 |
| LCC1/0-14AWF-X | D2.54 | LCC2-38WH-Q | D2.51 | LCC3/0-12WF-X | D2.54 |
| LCC1/0-14AWH-X | D2.51 | LCC2-56B-Q | D2.41 | LCC3/0-12WH-X | D2.51 |
| LCC1/0-14B-X | D2.42 | LCC2-56BF-Q | D2.45 | LCC3/0-14B-X | D2.42 |
| LCC1/0-14BF-X | D2.46 | LCC2-56BH-Q | D2.43 | LCC3/0-14BF-X | D2.46 |
| LCC1/0-14BH-X | D2.44 | LCC2-56BW-Q | D2.48 | LCC3/0-14BH-X | D2.44 |
| LCC1/0-14BW-X | D2.48 | LCC2-56BWF-Q | D2.54 | LCC3/0-14BW-X | D2.49 |
| LCC1/0-14BWF-X | D2.54 | LCC2-56BWH-Q | D2.51 | LCC3/0-14BWF-X | D2.54 |
| LCC1/0-14BWH-X | D2.51 | LCC2-56C-Q | D2.41 | LCC3/0-14BWH-X | D2.51 |
| LCC1/0-14DW-X | D2.48 | LCC2-56CF-Q | D2.45 | LCC3/0-38D-X | D2.42 |
| LCC1/0-14DWF-X | D2.54 | LCC2-56CH-Q | D2.43 | LCC3/0-38DF-X | D2.46 |
| LCC1/0-14DWH-X | D2.51 | LCC2-56CW-Q | D2.48 | LCC3/0-38DH-X | D2.44 |
| LCC1/0-38D-X | D2.42 | LCC2-56CWF-Q | D2.54 | LCC3/0-38DW-X | D2.49 |
| LCC1/0-38DF-X | D2.46 | LCC2-56CWH-Q | D2.51 | LCC3/0-38DWF-X | D2.54 |
| LCC1/0-38DH-X | D2.44 | LCC2/0-00-X | D2.57 | LCC3/0-38DWH-X | D2.51 |
| LCC1/0-38DW-X | D2.48 | LCC2/0-00W-X | D2.58 | LCC3/0-56DW-X | D2.49 |
| LCC1/0-38DWF-X | D2.54 | LCC2/0-12-X | D2.42 | LCC3/0-56DWF-X | D2.54 |
| LCC1/0-38DWH-X | D2.51 | LCC2/0-12D-X | D2.42 | LCC3/0-56DWH-X | D2.51 |
| LCC1/0-38W-X | D2.48 | LCC2/0-12DF-X | D2.46 | LCC300-00-X | D2.57 |
| LCC1/0-38WF-X | D2.54 | LCC2/0-12DH-X | D2.44 | LCC300-00W-X | D2.58 |
| LCC1/0-38WH-X | D2.51 | LCC2/0-12DW-X | D2.48 | LCC300-12-X | D2.42 |
| LCC1/0-56C-X | D2.42 | LCC2/0-12DWF-X | D2.54 | LCC300-12F-X | D2.46 |
| LCC1/0-56CF-X | D2.46 | LCC2/0-12DWH-X | D2.51 | LCC300-12H-X | D2.44 |
| LCC1/0-56CH-X | D2.44 | LCC2/0-12F-X | D2.46 | LCC300-12W-X | D2.49 |
| LCC1/0-56D-X | D2.42 | LCC2/0-12H-X | D2.44 | LCC300-12WF-X | D2.55 |
| LCC1/0-56DF-X | D2.46 | LCC2/0-12W-X | D2.48 | LCC300-12WH-X | D2.52 |
| LCC1/0-56DH-X | D2.44 | LCC2/0-12WF-X | D2.54 | LCC300-38D-X | D2.42 |
| LCC10-14AW-L | D2.47 | LCC2/0-12WH-X | D2.51 | LCC300-38DF-X | D2.46 |
| LCC10-14AWF-L | D2.53 | LCC2/0-14A-X | D2.42 | LCC300-38DH-X | D2.44 |
| LCC10-14AWH-L | D2.50 | LCC2/0-14AF-X | D2.46 | LCC300-38DW-X | D2.49 |
| LCC10-14BW-L | D2.47 | LCC2/0-14AH-X | D2.44 | LCC300-38DWF-X | D2.55 |

| |
|---------------------------------------|
| A. System Overview |
| B1. Cable Ties |
| B2. Cable Accessories |
| B3. Stainless Steel Ties |
| C1. Wiring Duct |
| C2. Surface Raceway |
| C3. Abrasion Protection |
| C4. Cable Management |
| D1. Terminals |
| D2. Power Connectors |
| D3. Grounding Connectors |
| E1. Labeling Systems |
| E2. Labels |
| E3. Pre-Printed & Write-On Markers |
| E4. Permanent Identification |
| E5. Lockout/Tagout & Safety Solutions |
| F. Index |

PANDUIT® ELECTRICAL SOLUTIONS

| A. System Overview | Part Number | Page Number | Part Number | Page Number | Part Number | Page Number |
|---------------------------------------|----------------|-------------|----------------|-------------|----------------|-------------|
| B1. Cable Ties | LCC300-38DWH-X | D2.52 | LCC4/0-56D-X | D2.42 | LCC6-14JWF-L | D2.53 |
| | LCC350-00-X | D2.57 | LCC4/0-56DF-X | D2.46 | LCC6-14JWH-L | D2.50 |
| | LCC350-00W-X | D2.58 | LCC4/0-56DH-X | D2.44 | LCC6-14W-L | D2.47 |
| | LCC350-12-X | D2.42 | LCC4/0-56DW-X | D2.49 | LCC6-38BDW-L | D2.47 |
| | LCC350-12F-X | D2.46 | LCC4/0-56DWF-X | D2.54 | LCC6-38BW-L | D2.47 |
| B2. Cable Accessories | LCC350-12H-X | D2.44 | LCC4/0-56DWH-X | D2.51 | LCC6-38BWF-L | D2.53 |
| | LCC350-12W-X | D2.49 | LCC400-00-6 | D2.57 | LCC6-38BWH-L | D2.50 |
| | LCC350-12WF-X | D2.55 | LCC400-00W-6 | D2.58 | LCC6-38CW-L | D2.47 |
| | LCC350-12WH-X | D2.52 | LCC400-12-6 | D2.42 | LCC6-38CWF-L | D2.53 |
| | LCC350-14B-X | D2.42 | LCC400-12F-6 | D2.46 | LCC6-38CWH-L | D2.50 |
| B3. Stainless Steel Ties | LCC350-14BF-X | D2.46 | LCC400-12H-6 | D2.44 | LCC6-38D-L | D2.41 |
| | LCC350-14BH-X | D2.44 | LCC400-12W-6 | D2.49 | LCC6-38DF-L | D2.45 |
| | LCC350-14BW-X | D2.49 | LCC400-12WF-6 | D2.55 | LCC6-38DH-L | D2.43 |
| | LCC350-14BWF-X | D2.55 | LCC400-12WH-6 | D2.52 | LCC6-38DW-L | D2.47 |
| | LCC350-14BWH-X | D2.52 | LCC400-14B-6 | D2.42 | LCC6-38DWF-L | D2.53 |
| C1. Wiring Duct | LCC350-38D-X | D2.42 | LCC400-14BF-6 | D2.46 | LCC6-38DWH-L | D2.50 |
| | LCC350-38DF-X | D2.46 | LCC400-14BH-6 | D2.44 | LCC6-56BW-L | D2.47 |
| | LCC350-38DH-X | D2.44 | LCC400-14BW-6 | D2.49 | LCC6-56BWF-L | D2.53 |
| | LCC350-38DW-X | D2.49 | LCC400-14BWF-6 | D2.55 | LCC6-56BWH-L | D2.50 |
| | LCC350-38DWF-X | D2.55 | LCC400-14BWH-6 | D2.52 | LCC600-00-6 | D2.57 |
| C2. Surface Raceway | LCC350-38DWH-X | D2.52 | LCC400-38D-6 | D2.42 | LCC600-00W-6 | D2.58 |
| | LCC4-00-L | D2.57 | LCC400-38DF-6 | D2.46 | LCC600-12-6 | D2.42 |
| | LCC4-00W-L | D2.58 | LCC400-38DH-6 | D2.44 | LCC600-12F-6 | D2.46 |
| | LCC4-10AW-L | D2.48 | LCC400-38DW-6 | D2.49 | LCC600-12H-6 | D2.44 |
| | LCC4-10AWF-L | D2.54 | LCC400-38DWF-6 | D2.55 | LCC600-12W-6 | D2.49 |
| C3. Abrasion Protection | LCC4-10AWH-L | D2.51 | LCC400-38DWH-6 | D2.52 | LCC600-12WF-6 | D2.55 |
| | LCC4-10BW-L | D2.48 | LCC500-00-6 | D2.57 | LCC600-12WH-6 | D2.52 |
| | LCC4-10BWF-L | D2.54 | LCC500-00W-6 | D2.58 | LCC600-38D-6 | D2.42 |
| | LCC4-10BWH-L | D2.51 | LCC500-12-6 | D2.42 | LCC600-38DF-6 | D2.46 |
| | LCC4-12-L | D2.41 | LCC500-12F-6 | D2.46 | LCC600-38DH-6 | D2.44 |
| C4. Cable Management | LCC4-12W-L | D2.48 | LCC500-12H-6 | D2.44 | LCC600-38DW-6 | D2.49 |
| | LCC4-14A-L | D2.41 | LCC500-12W-6 | D2.49 | LCC600-38DWF-6 | D2.55 |
| | LCC4-14ADW-L | D2.48 | LCC500-12WF-6 | D2.55 | LCC600-38DWH-6 | D2.52 |
| | LCC4-14AF-L | D2.45 | LCC500-12WH-6 | D2.52 | LCC750-00-6 | D2.57 |
| | LCC4-14AH-L | D2.43 | LCC500-14B-6 | D2.42 | LCC750-12-6 | D2.42 |
| D1. Terminals | LCC4-14AW-L | D2.48 | LCC500-14BF-6 | D2.46 | LCC750-12W-6 | D2.49 |
| | LCC4-14AWF-L | D2.54 | LCC500-14BH-6 | D2.44 | LCC750-38D-6 | D2.42 |
| | LCC4-14AWH-L | D2.51 | LCC500-14BW-6 | D2.49 | LCC750-38DW-6 | D2.49 |
| | LCC4-14B-L | D2.41 | LCC500-14BWF-6 | D2.55 | LCC8-00-L | D2.57 |
| | LCC4-14BF-L | D2.45 | LCC500-14BWH-6 | D2.52 | LCC8-00W-L | D2.58 |
| D2. Power Connectors | LCC4-14BH-L | D2.43 | LCC500-38D-6 | D2.42 | LCC8-10A-L | D2.41 |
| | LCC4-14BW-L | D2.48 | LCC500-38DF-6 | D2.46 | LCC8-10ABW-L | D2.47 |
| | LCC4-14BWF-L | D2.54 | LCC500-38DH-6 | D2.44 | LCC8-10AF-L | D2.45 |
| | LCC4-14BWH-L | D2.51 | LCC500-38DW-6 | D2.49 | LCC8-10AH-L | D2.43 |
| | LCC4-14DW-L | D2.48 | LCC500-38DWF-6 | D2.55 | LCC8-10AW-L | D2.47 |
| D3. Grounding Connectors | LCC4-38D-L | D2.41 | LCC500-38DWH-6 | D2.52 | LCC8-10AWF-L | D2.53 |
| | LCC4-38DF-L | D2.45 | LCC6-00-L | D2.57 | LCC8-10AWH-L | D2.50 |
| | LCC4-38DH-L | D2.43 | LCC6-00W-L | D2.58 | LCC8-10BW-L | D2.47 |
| | LCC4-38DW-L | D2.48 | LCC6-10A-L | D2.41 | LCC8-10BWF-L | D2.53 |
| | LCC4-38DWF-L | D2.54 | LCC6-10ABW-L | D2.47 | LCC8-10BWH-L | D2.50 |
| E1. Labeling Systems | LCC4-38DWH-L | D2.51 | LCC6-10AF-L | D2.45 | LCC8-14A-L | D2.41 |
| | LCC4/0-00-X | D2.57 | LCC6-10AH-L | D2.43 | LCC8-14ABW-L | D2.47 |
| | LCC4/0-00W-X | D2.58 | LCC6-10AW-L | D2.47 | LCC8-14AF-L | D2.45 |
| | LCC4/0-12-X | D2.42 | LCC6-10AWF-L | D2.53 | LCC8-14AH-L | D2.43 |
| | LCC4/0-12D-X | D2.42 | LCC6-10AWH-L | D2.50 | LCC8-14AW-L | D2.47 |
| E2. Labels | LCC4/0-12DF-X | D2.46 | LCC6-10BW-L | D2.47 | LCC8-14AWF-L | D2.53 |
| | LCC4/0-12DH-X | D2.44 | LCC6-10BWF-L | D2.53 | LCC8-14AWH-L | D2.50 |
| | LCC4/0-12DW-X | D2.49 | LCC6-10BWH-L | D2.50 | LCC8-14B-L | D2.41 |
| | LCC4/0-12DWF-X | D2.54 | LCC6-12-L | D2.41 | LCC8-14BF-L | D2.45 |
| | LCC4/0-12DWH-X | D2.51 | LCC6-12W-L | D2.47 | LCC8-14BH-L | D2.43 |
| E3. Pre-Printed & Write-On Markers | LCC4/0-12F-X | D2.46 | LCC6-14A-L | D2.41 | LCC8-14BW-L | D2.47 |
| | LCC4/0-12H-X | D2.44 | LCC6-14AF-L | D2.45 | LCC8-14BWF-L | D2.53 |
| | LCC4/0-12W-X | D2.49 | LCC6-14AH-L | D2.43 | LCC8-14BWH-L | D2.50 |
| | LCC4/0-12WF-X | D2.54 | LCC6-14AW-L | D2.47 | LCC8-14D-L | D2.41 |
| | LCC4/0-12WH-X | D2.51 | LCC6-14AWF-L | D2.53 | LCC8-14DF-L | D2.45 |
| E4. Permanent Identification | LCC4/0-14AW-X | D2.49 | LCC6-14AWH-L | D2.50 | LCC8-14DH-L | D2.43 |
| | LCC4/0-14AWF-X | D2.54 | LCC6-14B-L | D2.41 | LCC8-14DW-L | D2.47 |
| | LCC4/0-14AWH-X | D2.51 | LCC6-14BDW-L | D2.47 | LCC8-14DWF-L | D2.53 |
| | LCC4/0-14B-X | D2.42 | LCC6-14BF-L | D2.45 | LCC8-14DWH-L | D2.50 |
| | LCC4/0-14BF-X | D2.46 | LCC6-14BH-L | D2.43 | LCC8-38D-L | D2.41 |
| E5. Lockout/Tagout & Safety Solutions | LCC4/0-14BH-X | D2.44 | LCC6-14BW-L | D2.47 | LCC8-38DF-L | D2.45 |
| | LCC4/0-14BW-X | D2.49 | LCC6-14BWF-L | D2.53 | LCC8-38DH-L | D2.43 |
| | LCC4/0-14BWF-X | D2.54 | LCC6-14BWH-L | D2.50 | LCC8-38DW-L | D2.47 |
| | LCC4/0-14BWH-X | D2.51 | LCC6-14D-L | D2.41 | LCC8-38DWF-L | D2.53 |
| | LCC4/0-38-X | D2.42 | LCC6-14DF-L | D2.45 | LCC8-38DWH-L | D2.50 |
| F. Index | LCC4/0-38D-X | D2.42 | LCC6-14DH-L | D2.43 | LCC800-12-6 | D2.42 |
| | LCC4/0-38DF-X | D2.46 | LCC6-14DW-L | D2.47 | LCC800-12W-6 | D2.49 |
| | LCC4/0-38DH-X | D2.44 | LCC6-14DWF-L | D2.53 | LCCF1-12-X | D2.97 |
| | LCC4/0-38DW-X | D2.49 | LCC6-14DWH-L | D2.50 | LCCF1-12F-X | D2.101 |
| | LCC4/0-38DWF-X | D2.54 | LCC6-14EW-L | D2.47 | LCCF1-12H-X | D2.99 |
| | LCC4/0-38DWH-X | D2.51 | LCC6-14EWF-L | D2.53 | LCCF1-14A-X | D2.97 |
| | LCC4/0-38F-X | D2.46 | LCC6-14EWH-L | D2.50 | LCCF1-14AF-X | D2.101 |
| | LCC4/0-38H-X | D2.44 | LCC6-14JAW-L | D2.47 | LCCF1-14AH-X | D2.99 |
| | LCC4/0-38W-X | D2.49 | LCC6-14JAWF-L | D2.53 | LCCF1-14B-X | D2.97 |
| | LCC4/0-38WF-X | D2.54 | LCC6-14JAWH-L | D2.50 | LCCF1-14BF-X | D2.101 |
| | LCC4/0-38WH-X | D2.51 | LCC6-14JW-L | D2.47 | LCCF1-14BH-X | D2.99 |

PANDUIT® ELECTRICAL SOLUTIONS

| Part Number | Page Number | Part Number | Page Number | Part Number | Page Number |
|----------------|-------------|----------------|-------------|----------------|-------------|
| LCCF1-38D-X | D2.97 | LCCF350-38D-6 | D2.98 | LCCX1-56CF-X | D2.95 |
| LCCF1-38DF-X | D2.101 | LCCF350-38DF-6 | D2.102 | LCCX1-56CH-X | D2.93 |
| LCCF1-38DH-X | D2.99 | LCCF350-38DH-6 | D2.100 | LCCX1-56D-X | D2.92 |
| LCCF1-56C-X | D2.97 | LCCF4-14A-L | D2.97 | LCCX1-56DF-X | D2.95 |
| LCCF1-56CF-X | D2.101 | LCCF4-14AF-L | D2.101 | LCCX1-56DH-X | D2.93 |
| LCCF1-56CH-X | D2.99 | LCCF4-14AH-L | D2.99 | LCCX1/0-12-X | D2.92 |
| LCCF1/0-12-X | D2.98 | LCCF4-14B-L | D2.97 | LCCX1/0-12F-X | D2.95 |
| LCCF1/0-12F-X | D2.101 | LCCF4-14BF-L | D2.101 | LCCX1/0-12H-X | D2.94 |
| LCCF1/0-12H-X | D2.99 | LCCF4-14BH-L | D2.99 | LCCX1/0-14A-X | D2.92 |
| LCCF1/0-14A-X | D2.98 | LCCF4-38D-L | D2.97 | LCCX1/0-14AF-X | D2.95 |
| LCCF1/0-14AF-X | D2.101 | LCCF4-38DH-L | D2.99 | LCCX1/0-14AH-X | D2.94 |
| LCCF1/0-14AH-X | D2.99 | LCCF4/0-12-X | D2.98 | LCCX1/0-14B-X | D2.92 |
| LCCF1/0-14B-X | D2.98 | LCCF4/0-12F-X | D2.102 | LCCX1/0-14BF-X | D2.95 |
| LCCF1/0-14BF-X | D2.101 | LCCF4/0-12H-X | D2.100 | LCCX1/0-14BH-X | D2.94 |
| LCCF1/0-14BH-X | D2.99 | LCCF4/0-14B-X | D2.98 | LCCX1/0-38D-X | D2.92 |
| LCCF1/0-38D-X | D2.98 | LCCF4/0-14BF-X | D2.102 | LCCX1/0-38DF-X | D2.95 |
| LCCF1/0-38DF-X | D2.101 | LCCF4/0-14BH-X | D2.100 | LCCX1/0-38DH-X | D2.94 |
| LCCF1/0-38DH-X | D2.99 | LCCF4/0-38-X | D2.98 | LCCX2-12-E | D2.91 |
| LCCF1/0-56C-X | D2.98 | LCCF4/0-38D-X | D2.98 | LCCX2-12F-E | D2.95 |
| LCCF1/0-56CF-X | D2.101 | LCCF4/0-38DF-X | D2.102 | LCCX2-12H-E | D2.93 |
| LCCF1/0-56CH-X | D2.99 | LCCF4/0-38DH-X | D2.100 | LCCX2-14A-E | D2.91 |
| LCCF2-12-E | D2.97 | LCCF4/0-38F-X | D2.102 | LCCX2-14AF-E | D2.95 |
| LCCF2-12F-E | D2.101 | LCCF4/0-38H-X | D2.100 | LCCX2-14AH-E | D2.93 |
| LCCF2-12H-E | D2.99 | LCCF400-12-6 | D2.98 | LCCX2-14B-E | D2.91 |
| LCCF2-14A-E | D2.97 | LCCF400-12F-6 | D2.102 | LCCX2-14BF-E | D2.95 |
| LCCF2-14AH-E | D2.99 | LCCF400-12H-6 | D2.100 | LCCX2-14BH-E | D2.93 |
| LCCF2-14B-E | D2.97 | LCCF400-38D-6 | D2.98 | LCCX2-38D-E | D2.91 |
| LCCF2-14BF-E | D2.101 | LCCF400-38DF-6 | D2.102 | LCCX2-38DF-E | D2.95 |
| LCCF2-14BH-E | D2.99 | LCCF400-38DH-6 | D2.100 | LCCX2-38DH-E | D2.93 |
| LCCF2-38D-E | D2.97 | LCCF500-12-6 | D2.98 | LCCX2/0-12-X | D2.92 |
| LCCF2-38DF-E | D2.101 | LCCF500-12F-6 | D2.102 | LCCX2/0-12F-X | D2.96 |
| LCCF2-38DH-E | D2.99 | LCCF500-12H-6 | D2.100 | LCCX2/0-12H-X | D2.94 |
| LCCF2-56B-E | D2.97 | LCCF6-14A-L | D2.97 | LCCX2/0-14A-X | D2.92 |
| LCCF2-56BF-E | D2.101 | LCCF6-14AF-L | D2.101 | LCCX2/0-14AF-X | D2.96 |
| LCCF2-56BH-E | D2.99 | LCCF6-14AH-L | D2.99 | LCCX2/0-14AH-X | D2.94 |
| LCCF2/0-12-X | D2.98 | LCCF6-14B-L | D2.97 | LCCX2/0-14B-X | D2.92 |
| LCCF2/0-12F-X | D2.101 | LCCF6-14BF-L | D2.101 | LCCX2/0-14BF-X | D2.96 |
| LCCF2/0-12H-X | D2.99 | LCCF6-14BH-L | D2.99 | LCCX2/0-14BH-X | D2.94 |
| LCCF2/0-14A-X | D2.98 | LCCF6-38D-L | D2.97 | LCCX2/0-38D-X | D2.92 |
| LCCF2/0-14AF-X | D2.101 | LCCF6-38DF-L | D2.101 | LCCX2/0-38DF-X | D2.96 |
| LCCF2/0-14AH-X | D2.99 | LCCF6-38DH-L | D2.99 | LCCX2/0-38DH-X | D2.94 |
| LCCF2/0-14B-X | D2.98 | LCCF600-12-6 | D2.98 | LCCX250-14B-X | D2.92 |
| LCCF2/0-14BF-X | D2.101 | LCCF600-12F-6 | D2.102 | LCCX250-14BF-X | D2.96 |
| LCCF2/0-14BH-X | D2.99 | LCCF600-12H-6 | D2.100 | LCCX250-14BH-X | D2.94 |
| LCCF2/0-38D-X | D2.98 | LCCF750-12-3 | D2.98 | LCCX250-38D-X | D2.92 |
| LCCF2/0-38DF-X | D2.101 | LCCF750-12F-3 | D2.102 | LCCX250-38DF-X | D2.96 |
| LCCF2/0-38DH-X | D2.99 | LCCF750-12H-3 | D2.100 | LCCX250-38DH-X | D2.94 |
| LCCF250-12-X | D2.98 | LCCF750-38D-3 | D2.98 | LCCX3/0-14B-X | D2.92 |
| LCCF250-12E-X | D2.98 | LCCF750-38DF-3 | D2.102 | LCCX3/0-14BF-X | D2.96 |
| LCCF250-12EF-X | D2.102 | LCCF750-38DH-3 | D2.100 | LCCX3/0-14BH-X | D2.94 |
| LCCF250-12EH-X | D2.100 | LCCF8-14A-L | D2.97 | LCCX3/0-38D-X | D2.92 |
| LCCF250-12F-X | D2.102 | LCCF8-14AF-L | D2.101 | LCCX3/0-38DF-X | D2.96 |
| LCCF250-12H-X | D2.100 | LCCF8-14AH-L | D2.99 | LCCX3/0-38DH-X | D2.94 |
| LCCF250-14B-X | D2.98 | LCCF8-14B-L | D2.97 | LCCX300-38D-6 | D2.92 |
| LCCF250-14BF-X | D2.102 | LCCF8-14BF-L | D2.101 | LCCX300-38DF-6 | D2.96 |
| LCCF250-14BH-X | D2.100 | LCCF8-14BH-L | D2.99 | LCCX300-38DH-6 | D2.94 |
| LCCF250-38D-X | D2.98 | LCCF8-38D-L | D2.97 | LCCX350-12-6 | D2.92 |
| LCCF250-38DF-X | D2.102 | LCCF8-38DF-L | D2.101 | LCCX350-12F-6 | D2.96 |
| LCCF250-38DH-X | D2.100 | LCCF8-38DH-L | D2.99 | LCCX350-12H-6 | D2.94 |
| LCCF3/0-12-X | D2.98 | LCCH1/0-12-X | D2.56 | LCCX350-14B-6 | D2.92 |
| LCCF3/0-12F-X | D2.101 | LCCH1000-12-3 | D2.56 | LCCX350-14BF-6 | D2.96 |
| LCCF3/0-12H-X | D2.99 | LCCH2/0-12-X | D2.56 | LCCX350-14BH-6 | D2.94 |
| LCCF3/0-14B-X | D2.98 | LCCH250-12-X | D2.56 | LCCX350-38D-6 | D2.92 |
| LCCF3/0-14BF-X | D2.101 | LCCH3/0-12-X | D2.56 | LCCX350-38DF-6 | D2.96 |
| LCCF3/0-14BH-X | D2.99 | LCCH300-12-X | D2.56 | LCCX350-38DH-6 | D2.94 |
| LCCF3/0-38D-X | D2.98 | LCCH350-12-X | D2.56 | LCCX4-14A-L | D2.91 |
| LCCF3/0-38DF-X | D2.101 | LCCH4/0-12-X | D2.56 | LCCX4-14AB-L | D2.91 |
| LCCF3/0-38DH-X | D2.99 | LCCH400-12-6 | D2.56 | LCCX4-14AF-L | D2.95 |
| LCCF300-12-6 | D2.98 | LCCH500-12-6 | D2.56 | LCCX4-14AH-L | D2.93 |
| LCCF300-12F-6 | D2.102 | LCCH600-12-6 | D2.56 | LCCX4-14B-L | D2.91 |
| LCCF300-12H-6 | D2.100 | LCCH750-12-6 | D2.56 | LCCX4-14BF-L | D2.95 |
| LCCF300-14B-6 | D2.98 | LCCN750-12W-6 | D2.55 | LCCX4-14BH-L | D2.93 |
| LCCF300-14BF-6 | D2.102 | LCCN750-38DW-6 | D2.55 | LCCX4-38B-L | D2.91 |
| LCCF300-14BH-6 | D2.100 | LCCX1-14A-X | D2.92 | LCCX4-38BD-L | D2.91 |
| LCCF300-38D-6 | D2.98 | LCCX1-14AF-X | D2.95 | LCCX4-38BF-L | D2.95 |
| LCCF300-38DF-6 | D2.102 | LCCX1-14AH-X | D2.93 | LCCX4-38BH-L | D2.93 |
| LCCF300-38DH-6 | D2.100 | LCCX1-14B-X | D2.92 | LCCX4-38D-L | D2.91 |
| LCCF350-12-6 | D2.98 | LCCX1-14BF-X | D2.95 | LCCX4-38DF-L | D2.95 |
| LCCF350-12E-6 | D2.98 | LCCX1-14BH-X | D2.93 | LCCX4-38DH-L | D2.93 |
| LCCF350-12EF-6 | D2.102 | LCCX1-14D-X | D2.92 | LCCX4/0-12-X | D2.92 |
| LCCF350-12EH-6 | D2.100 | LCCX1-14DF-X | D2.95 | LCCX4/0-12F-X | D2.96 |
| LCCF350-12F-6 | D2.102 | LCCX1-14DH-X | D2.93 | LCCX4/0-12H-X | D2.94 |
| LCCF350-12H-6 | D2.100 | LCCX1-38D-X | D2.92 | LCCX4/0-14B-X | D2.92 |
| LCCF350-14B-6 | D2.98 | LCCX1-38DF-X | D2.95 | LCCX4/0-14BF-X | D2.96 |
| LCCF350-14BF-6 | D2.102 | LCCX1-38DH-X | D2.93 | LCCX4/0-14BH-X | D2.94 |
| LCCF350-14BH-6 | D2.100 | LCCX1-56C-X | D2.92 | LCCX4/0-38D-X | D2.92 |

A. System Overview

B1. Cable Ties

B2. Cable Accessories

B3. Stainless Steel Ties

C1. Wiring Duct

C2. Surface Raceway

C3. Abrasion Protection

C4. Cable Management

D1. Terminals

D2. Power Connectors

D3. Grounding Connectors

E1. Labeling Systems

E2. Labels

E3. Pre-Printed & Write-On Markers

E4. Permanent Identification

E5. Lockout/Tagout & Safety Solutions

F. Index

PANDUIT® ELECTRICAL SOLUTIONS

| A. System Overview | Part Number | Page Number | Part Number | Page Number | Part Number | Page Number |
|---------------------------------------|----------------|-------------|---------------|-------------|---------------|-------------|
| B1. Cable Ties | LCCX4/0-38DF-X | D2.96 | LCD10-38DF-L | D2.35 | LCD4-14AF-L | D2.35 |
| | LCCX4/0-38DH-X | D2.94 | LCD10-38DH-L | D2.33 | LCD4-14AH-L | D2.33 |
| | LCCX500-12-6 | D2.92 | LCD1000-00-3 | D2.40 | LCD4-14B-L | D2.31 |
| | LCCX6-10B-L | D2.91 | LCD1000-12-3 | D2.32 | LCD4-14BF-L | D2.35 |
| | LCCX6-10BF-L | D2.95 | LCD1000-12E-3 | D2.32 | LCD4-14BH-L | D2.33 |
| B2. Cable Accessories | LCCX6-10BH-L | D2.93 | LCD2-12-Q | D2.31 | LCD4-14D-L | D2.31 |
| | LCCX6-14A-L | D2.91 | LCD2-12F-Q | D2.35 | LCD4-14DF-L | D2.35 |
| | LCCX6-14AB-L | D2.91 | LCD2-12H-Q | D2.34 | LCD4-14DH-L | D2.33 |
| | LCCX6-14AF-L | D2.95 | LCD2-14A-Q | D2.31 | LCD4-38D-L | D2.31 |
| | LCCX6-14AH-L | D2.93 | LCD2-14AF-Q | D2.35 | LCD4-38DF-L | D2.35 |
| B3. Stainless Steel Ties | LCCX6-14B-L | D2.91 | LCD2-14AH-Q | D2.34 | LCD4-38DH-L | D2.33 |
| | LCCX6-14BF-L | D2.95 | LCD2-14B-Q | D2.31 | LCD4/0-00-X | D2.40 |
| | LCCX6-14BH-L | D2.93 | LCD2-14BF-Q | D2.35 | LCD4/0-12-X | D2.32 |
| | LCCX6-14D-L | D2.91 | LCD2-14BH-Q | D2.34 | LCD4/0-12F-X | D2.36 |
| | LCCX6-14DF-L | D2.95 | LCD2-14D-Q | D2.31 | LCD4/0-12H-X | D2.34 |
| C1. Wiring Duct | LCCX6-14DH-L | D2.93 | LCD2-14DF-Q | D2.35 | LCD4/0-14B-X | D2.32 |
| | LCCX6-38A-L | D2.91 | LCD2-14DH-Q | D2.34 | LCD4/0-14BF-X | D2.36 |
| | LCCX6-38AC-L | D2.91 | LCD2-38D-Q | D2.31 | LCD4/0-14BH-X | D2.34 |
| | LCCX6-38AF-L | D2.95 | LCD2-38DF-Q | D2.35 | LCD4/0-38D-X | D2.32 |
| | LCCX6-38AH-L | D2.93 | LCD2-38DH-Q | D2.34 | LCD4/0-38DF-X | D2.36 |
| C2. Surface Raceway | LCCX6-38C-L | D2.91 | LCD2-56B-Q | D2.31 | LCD4/0-38DH-X | D2.34 |
| | LCCX6-38CF-L | D2.95 | LCD2-56BF-Q | D2.35 | LCD400-00-6 | D2.40 |
| | LCCX6-38CH-L | D2.93 | LCD2-56BH-Q | D2.34 | LCD400-12-6 | D2.32 |
| | LCCX6-38D-L | D2.91 | LCD2/0-00-X | D2.40 | LCD400-12F-6 | D2.36 |
| | LCCX6-38DF-L | D2.95 | LCD2/0-12-X | D2.32 | LCD400-12H-6 | D2.34 |
| C3. Abrasion Protection | LCCX6-38DH-L | D2.93 | LCD2/0-12F-X | D2.36 | LCD400-38D-6 | D2.32 |
| | LCCX8-10A-L | D2.91 | LCD2/0-12H-X | D2.34 | LCD400-38DF-6 | D2.36 |
| | LCCX8-10AB-L | D2.91 | LCD2/0-14A-X | D2.32 | LCD400-38DH-6 | D2.34 |
| | LCCX8-10AF-L | D2.95 | LCD2/0-14AF-X | D2.36 | LCD500-00-6 | D2.40 |
| | LCCX8-10AH-L | D2.93 | LCD2/0-14AH-X | D2.34 | LCD500-12-6 | D2.32 |
| C4. Cable Management | LCCX8-10B-L | D2.91 | LCD2/0-14B-X | D2.32 | LCD500-12E-6 | D2.32 |
| | LCCX8-10BF-L | D2.95 | LCD2/0-14BF-X | D2.36 | LCD500-12EF-6 | D2.36 |
| | LCCX8-10BH-L | D2.93 | LCD2/0-14BH-X | D2.34 | LCD500-12EH-6 | D2.34 |
| | LCCX8-14A-L | D2.91 | LCD2/0-38D-X | D2.32 | LCD500-12F-6 | D2.36 |
| | LCCX8-14AB-L | D2.91 | LCD2/0-38DF-X | D2.36 | LCD500-12H-6 | D2.34 |
| D1. Terminals | LCCX8-14AF-L | D2.95 | LCD2/0-38DH-X | D2.34 | LCD500-14B-6 | D2.32 |
| | LCCX8-14AH-L | D2.93 | LCD2/0-56C-X | D2.32 | LCD500-14BF-6 | D2.36 |
| | LCCX8-14B-L | D2.91 | LCD2/0-56CF-X | D2.36 | LCD500-14BH-6 | D2.34 |
| | LCCX8-14BF-L | D2.95 | LCD2/0-56CH-X | D2.34 | LCD500-38D-6 | D2.32 |
| | LCCX8-14BH-L | D2.93 | LCD250-00-X | D2.40 | LCD500-38DF-6 | D2.36 |
| D2. Power Connectors | LCCX8-14D-L | D2.91 | LCD250-12-X | D2.32 | LCD500-38DH-6 | D2.34 |
| | LCCX8-14DF-L | D2.95 | LCD250-12F-X | D2.36 | LCD6-10A-L | D2.31 |
| | LCCX8-14DH-L | D2.93 | LCD250-12H-X | D2.34 | LCD6-10AF-L | D2.35 |
| | LCCX8-38D-L | D2.91 | LCD250-38D-X | D2.32 | LCD6-10AH-L | D2.33 |
| | LCCX8-38DF-L | D2.95 | LCD250-38DF-X | D2.36 | LCD6-10B-L | D2.31 |
| D3. Grounding Connectors | LCCX8-38DH-L | D2.93 | LCD250-38DH-X | D2.34 | LCD6-10BF-L | D2.35 |
| | LCD1-12-E | D2.32 | LCD3/0-00-X | D2.40 | LCD6-10BH-L | D2.33 |
| | LCD1-12F-E | D2.36 | LCD3/0-12-X | D2.32 | LCD6-10D-L | D2.31 |
| | LCD1-12H-E | D2.34 | LCD3/0-12F-X | D2.36 | LCD6-10DF-L | D2.35 |
| | LCD1-14A-E | D2.32 | LCD3/0-12H-X | D2.34 | LCD6-10DH-L | D2.33 |
| E1. Labeling Systems | LCD1-14AF-E | D2.36 | LCD3/0-14B-X | D2.32 | LCD6-14A-L | D2.31 |
| | LCD1-14AH-E | D2.34 | LCD3/0-14BF-X | D2.36 | LCD6-14AF-L | D2.35 |
| | LCD1-14B-E | D2.32 | LCD3/0-14BH-X | D2.34 | LCD6-14AH-L | D2.33 |
| | LCD1-14BF-E | D2.36 | LCD3/0-38D-X | D2.32 | LCD6-14B-L | D2.31 |
| | LCD1-14BH-E | D2.34 | LCD3/0-38DF-X | D2.36 | LCD6-14BF-L | D2.35 |
| E2. Labels | LCD1-38D-E | D2.32 | LCD3/0-38DF-X | D2.36 | LCD6-14BH-L | D2.33 |
| | LCD1-38DF-E | D2.36 | LCD3/0-38DH-X | D2.34 | LCD6-14D-L | D2.31 |
| | LCD1-38DH-E | D2.34 | LCD3/0-56D-X | D2.32 | LCD6-14DF-L | D2.35 |
| | LCD1-56C-E | D2.32 | LCD3/0-56DF-X | D2.36 | LCD6-14DH-L | D2.33 |
| | LCD1-56CF-E | D2.36 | LCD3/0-56DH-X | D2.34 | LCD6-38D-L | D2.31 |
| E3. Pre-Printed & Write-On Markers | LCD1-56CH-E | D2.34 | LCD300-00-X | D2.40 | LCD6-38DF-L | D2.35 |
| | LCD1/0-00-X | D2.40 | LCD300-12-X | D2.32 | LCD6-38DH-L | D2.33 |
| | LCD1/0-12-X | D2.32 | LCD300-12F-X | D2.36 | LCD6-56D-L | D2.31 |
| | LCD1/0-12F-X | D2.36 | LCD300-12H-X | D2.34 | LCD6-56DF-L | D2.35 |
| | LCD1/0-12H-X | D2.34 | LCD300-38D-X | D2.32 | LCD6-56DH-L | D2.33 |
| E4. Permanent Identification | LCD1/0-14A-X | D2.32 | LCD300-38DF-X | D2.36 | LCD600-00-6 | D2.40 |
| | LCD1/0-14AH-X | D2.34 | LCD300-38DH-X | D2.34 | LCD600-12-6 | D2.32 |
| | LCD1/0-14B-X | D2.32 | LCD350-00-X | D2.40 | LCD600-12F-6 | D2.36 |
| | LCD1/0-14BF-X | D2.36 | LCD350-12-X | D2.32 | LCD600-12H-6 | D2.34 |
| | LCD1/0-14BH-X | D2.34 | LCD350-12E-X | D2.32 | LCD600-38D-6 | D2.32 |
| E5. Lockout/Tagout & Safety Solutions | LCD1/0-14D-X | D2.36 | LCD350-12EF-X | D2.36 | LCD600-38DF-6 | D2.36 |
| | LCD1/0-14DF-X | D2.34 | LCD350-12EH-X | D2.34 | LCD600-38DH-6 | D2.34 |
| | LCD1/0-14DH-X | D2.32 | LCD350-12F-X | D2.36 | LCD750-00-6 | D2.40 |
| | LCD1/0-38D-X | D2.32 | LCD350-12H-X | D2.34 | LCD750-12-6 | D2.32 |
| | LCD1/0-38DF-X | D2.36 | LCD350-14B-X | D2.32 | LCD750-38D-6 | D2.32 |
| F. Index | LCD1/0-38DH-X | D2.34 | LCD350-14BF-X | D2.36 | LCD8-10A-L | D2.31 |
| | LCD1/0-56C-X | D2.32 | LCD350-14BH-X | D2.34 | LCD8-10AF-L | D2.35 |
| | LCD1/0-56CF-X | D2.36 | LCD350-38D-X | D2.32 | LCD8-10AH-L | D2.33 |
| | LCD1/0-56CH-X | D2.34 | LCD350-38DF-X | D2.36 | LCD8-14A-L | D2.31 |
| | LCD10-10A-L | D2.31 | LCD350-38DH-X | D2.34 | LCD8-14AF-L | D2.35 |
| LCD10-10AF-L | D2.35 | LCD4-10A-L | D2.31 | LCD8-14AH-L | D2.33 | |
| LCD10-10AH-L | D2.33 | LCD4-10AF-L | D2.35 | LCD8-14B-L | D2.31 | |
| LCD10-14A-L | D2.31 | LCD4-10AH-L | D2.33 | LCD8-14BF-L | D2.35 | |
| LCD10-14AF-L | D2.35 | LCD4-10B-L | D2.31 | LCD8-14BH-L | D2.33 | |
| LCD10-14AH-L | D2.33 | LCD4-10BF-L | D2.35 | LCD8-14D-L | D2.31 | |
| LCD10-14B-L | D2.31 | LCD4-10BH-L | D2.33 | | | |
| LCD10-14D-L | D2.31 | LCD4-14A-L | D2.31 | | | |
| LCD10-38D-L | D2.31 | | | | | |

PANDUIT® ELECTRICAL SOLUTIONS

| Part Number | Page Number | Part Number | Page Number | Part Number | Page Number |
|----------------|-------------|----------------|-------------|----------------|-------------|
| LCD8-14DF-L | D2.35 | LCDX2-56D-E | D2.83 | LCDX4/0-12EF-X | D2.88 |
| LCD8-14DH-L | D2.33 | LCDX2-56DF-E | D2.87 | LCDX4/0-12EH-X | D2.86 |
| LCD8-38D-L | D2.31 | LCDX2-56DH-E | D2.85 | LCDX4/0-12F-X | D2.88 |
| LCD8-38DF-L | D2.35 | LCDX2/0-12-X | D2.84 | LCDX4/0-12H-X | D2.86 |
| LCD8-38DH-L | D2.33 | LCDX2/0-12D-X | D2.84 | LCDX4/0-14A-X | D2.84 |
| LCDN1-14B-E | D2.37 | LCDX2/0-12DF-X | D2.88 | LCDX4/0-14AF-X | D2.88 |
| LCDN1/0-14D-X | D2.37 | LCDX2/0-12DH-X | D2.86 | LCDX4/0-14AH-X | D2.86 |
| LCDN1/0-14DF-X | D2.39 | LCDX2/0-12F-X | D2.88 | LCDX4/0-14B-X | D2.84 |
| LCDN1/0-14DH-X | D2.38 | LCDX2/0-12H-X | D2.86 | LCDX4/0-14BF-X | D2.88 |
| LCDN1/0-56D-X | D2.37 | LCDX2/0-14A-X | D2.84 | LCDX4/0-14BH-X | D2.86 |
| LCDN1/0-56DF-X | D2.39 | LCDX2/0-14AF-X | D2.88 | LCDX4/0-38D-X | D2.84 |
| LCDN1/0-56DH-X | D2.38 | LCDX2/0-14AH-X | D2.86 | LCDX4/0-38DF-X | D2.88 |
| LCDN2-14A-Q | D2.37 | LCDX2/0-14B-X | D2.84 | LCDX4/0-38DH-X | D2.86 |
| LCDN2-14AF-Q | D2.39 | LCDX2/0-14BF-X | D2.88 | LCDX4/0-56D-X | D2.84 |
| LCDN2-14AH-Q | D2.38 | LCDX2/0-14BH-X | D2.86 | LCDX4/0-56DF-X | D2.88 |
| LCDN2-14B-Q | D2.37 | LCDX2/0-38D-X | D2.84 | LCDX4/0-56DH-X | D2.86 |
| LCDN2-14D-Q | D2.37 | LCDX2/0-38DF-X | D2.88 | LCDX450-12-6 | D2.84 |
| LCDN2-14DF-Q | D2.39 | LCDX2/0-38DH-X | D2.86 | LCDX450-12F-6 | D2.88 |
| LCDN2-14DH-Q | D2.38 | LCDX2/0-56D-X | D2.84 | LCDX450-12H-6 | D2.86 |
| LCDN2/0-14A-X | D2.37 | LCDX2/0-56DF-X | D2.88 | LCDX450-38D-6 | D2.84 |
| LCDN2/0-14D-X | D2.37 | LCDX2/0-56DH-X | D2.86 | LCDX450-38DF-6 | D2.88 |
| LCDN2/0-56A-X | D2.37 | LCDX250-12-X | D2.84 | LCDX450-38DH-6 | D2.86 |
| LCDN2/0-56D-X | D2.37 | LCDX250-12E-X | D2.84 | LCDX500-12-6 | D2.84 |
| LCDN350-38D-X | D2.37 | LCDX250-12EF-X | D2.88 | LCDX500-12E-6 | D2.84 |
| LCDN500-12D-6 | D2.37 | LCDX250-12EH-X | D2.86 | LCDX500-12EF-6 | D2.88 |
| LCDN500-38D-6 | D2.37 | LCDX250-12F-X | D2.88 | LCDX500-12EH-6 | D2.86 |
| LCDN750-12D-6 | D2.37 | LCDX250-12H-X | D2.86 | LCDX500-12F-6 | D2.88 |
| LCDN750-12DF-6 | D2.39 | LCDX250-38-X | D2.84 | LCDX500-12H-6 | D2.86 |
| LCDN750-12DH-6 | D2.38 | LCDX250-38D-X | D2.84 | LCDX500-38D-6 | D2.84 |
| LCDN750-38D-6 | D2.37 | LCDX250-38DF-X | D2.88 | LCDX500-38DF-6 | D2.88 |
| LCDN750-38DF-6 | D2.39 | LCDX250-38DH-X | D2.86 | LCDX500-38DH-6 | D2.86 |
| LCDN750-38DH-6 | D2.38 | LCDX250-38F-X | D2.88 | LCDX500-56D-6 | D2.84 |
| LCDX1-12-X | D2.83 | LCDX250-38H-X | D2.86 | LCDX500-56DF-6 | D2.88 |
| LCDX1-12F-X | D2.87 | LCDX3/0-12-X | D2.84 | LCDX500-56DH-6 | D2.86 |
| LCDX1-12H-X | D2.85 | LCDX3/0-12F-X | D2.88 | LCDX6-10A-L | D2.83 |
| LCDX1-14A-X | D2.83 | LCDX3/0-12H-X | D2.86 | LCDX6-10AF-L | D2.87 |
| LCDX1-14AF-X | D2.87 | LCDX3/0-14A-X | D2.84 | LCDX6-10AH-L | D2.85 |
| LCDX1-14AH-X | D2.85 | LCDX3/0-14AF-X | D2.88 | LCDX6-10B-L | D2.83 |
| LCDX1-14B-X | D2.83 | LCDX3/0-14AH-X | D2.86 | LCDX6-10BF-L | D2.87 |
| LCDX1-14BF-X | D2.87 | LCDX3/0-38D-X | D2.84 | LCDX6-10BH-L | D2.85 |
| LCDX1-14BH-X | D2.85 | LCDX3/0-38DF-X | D2.88 | LCDX6-10G-L | D2.83 |
| LCDX1-14D-X | D2.83 | LCDX3/0-38DH-X | D2.86 | LCDX6-10GF-L | D2.87 |
| LCDX1-14DF-X | D2.87 | LCDX3/0-56D-X | D2.84 | LCDX6-10GH-L | D2.85 |
| LCDX1-14DH-X | D2.85 | LCDX3/0-56DF-X | D2.88 | LCDX6-10P-L | D2.83 |
| LCDX1-38D-X | D2.83 | LCDX3/0-56DH-X | D2.86 | LCDX6-10PF-L | D2.87 |
| LCDX1-38DF-X | D2.87 | LCDX300-12-6 | D2.84 | LCDX6-10PH-L | D2.85 |
| LCDX1-38DH-X | D2.85 | LCDX300-12F-6 | D2.88 | LCDX6-14A-L | D2.83 |
| LCDX1-56D-X | D2.83 | LCDX300-12H-6 | D2.86 | LCDX6-14AF-L | D2.87 |
| LCDX1-56DF-X | D2.87 | LCDX300-38D-6 | D2.84 | LCDX6-14AH-L | D2.85 |
| LCDX1-56DH-X | D2.85 | LCDX300-38DF-6 | D2.88 | LCDX6-14B-L | D2.83 |
| LCDX1/0-12-X | D2.84 | LCDX300-38DH-6 | D2.86 | LCDX6-14BF-L | D2.87 |
| LCDX1/0-12D-X | D2.84 | LCDX350-12-6 | D2.84 | LCDX6-14BH-L | D2.85 |
| LCDX1/0-12DF-X | D2.88 | LCDX350-12E-6 | D2.84 | LCDX6-14D-L | D2.83 |
| LCDX1/0-12DH-X | D2.86 | LCDX350-12EF-6 | D2.88 | LCDX6-14DF-L | D2.87 |
| LCDX1/0-12F-X | D2.88 | LCDX350-12EH-6 | D2.86 | LCDX6-14DH-L | D2.85 |
| LCDX1/0-12H-X | D2.86 | LCDX350-12F-6 | D2.88 | LCDX6-38D-L | D2.83 |
| LCDX1/0-14A-X | D2.84 | LCDX350-12H-6 | D2.86 | LCDX6-38DF-L | D2.87 |
| LCDX1/0-14AF-X | D2.88 | LCDX350-38-6 | D2.84 | LCDX6-38DH-L | D2.85 |
| LCDX1/0-14AH-X | D2.86 | LCDX350-38D-6 | D2.84 | LCDX6-56D-L | D2.83 |
| LCDX1/0-14B-X | D2.84 | LCDX350-38DF-6 | D2.88 | LCDX6-56DF-L | D2.87 |
| LCDX1/0-14BF-X | D2.88 | LCDX350-38DH-6 | D2.86 | LCDX6-56DH-L | D2.85 |
| LCDX1/0-14BH-X | D2.86 | LCDX350-38F-6 | D2.88 | LCDX600-12-6 | D2.84 |
| LCDX1/0-38D-X | D2.84 | LCDX350-38H-6 | D2.86 | LCDX600-12F-6 | D2.88 |
| LCDX1/0-38DF-X | D2.88 | LCDX350-56D-6 | D2.84 | LCDX600-12H-6 | D2.86 |
| LCDX1/0-38DH-X | D2.86 | LCDX350-56DF-6 | D2.88 | LCDX650-12-6 | D2.84 |
| LCDX1/0-56B-X | D2.84 | LCDX350-56DH-6 | D2.86 | LCDX650-12F-6 | D2.88 |
| LCDX1/0-56BF-X | D2.88 | LCDX4-14A-L | D2.83 | LCDX650-12H-6 | D2.86 |
| LCDX1/0-56BH-X | D2.86 | LCDX4-14AF-L | D2.87 | LCDX650-38D-6 | D2.84 |
| LCDX1/0-56D-X | D2.84 | LCDX4-14AH-L | D2.85 | LCDX650-38DF-6 | D2.88 |
| LCDX1/0-56DF-X | D2.88 | LCDX4-14B-L | D2.83 | LCDX650-38DH-6 | D2.86 |
| LCDX1/0-56DH-X | D2.86 | LCDX4-14BF-L | D2.87 | LCDX750-12-3 | D2.84 |
| LCDX2-12-E | D2.83 | LCDX4-14BH-L | D2.85 | LCDX750-12E-3 | D2.84 |
| LCDX2-12F-E | D2.87 | LCDX4-14D-L | D2.83 | LCDX750-12EF-3 | D2.88 |
| LCDX2-12H-E | D2.85 | LCDX4-14DF-L | D2.87 | LCDX750-12EH-3 | D2.86 |
| LCDX2-14A-E | D2.83 | LCDX4-14DH-L | D2.85 | LCDX750-12F-3 | D2.88 |
| LCDX2-14AF-E | D2.87 | LCDX4-38D-L | D2.83 | LCDX750-12G-3 | D2.84 |
| LCDX2-14AH-E | D2.85 | LCDX4-38DF-L | D2.87 | LCDX750-12GF-3 | D2.88 |
| LCDX2-14B-E | D2.83 | LCDX4-38DH-L | D2.85 | LCDX750-12GH-3 | D2.86 |
| LCDX2-14BF-E | D2.87 | LCDX4-56D-L | D2.83 | LCDX750-12H-3 | D2.86 |
| LCDX2-14BH-E | D2.85 | LCDX4-56DF-L | D2.87 | LCDX750-38D-3 | D2.84 |
| LCDX2-14D-E | D2.83 | LCDX4-56DH-L | D2.85 | LCDX750-38DF-3 | D2.88 |
| LCDX2-14DF-E | D2.87 | LCDX4/0-12-X | D2.84 | LCDX750-38DH-3 | D2.86 |
| LCDX2-14DH-E | D2.85 | LCDX4/0-12D-X | D2.84 | LCDX750-58G-3 | D2.84 |
| LCDX2-38D-E | D2.83 | LCDX4/0-12DF-X | D2.88 | LCDX750-58GF-3 | D2.88 |
| LCDX2-38DF-E | D2.87 | LCDX4/0-12DH-X | D2.86 | LCDX750-58GH-3 | D2.86 |
| LCDX2-38DH-E | D2.85 | LCDX4/0-12E-X | D2.84 | LCDX8-10A-L | D2.83 |

| |
|---------------------------------------|
| A. System Overview |
| B1. Cable Ties |
| B2. Cable Accessories |
| B3. Stainless Steel Ties |
| C1. Wiring Duct |
| C2. Surface Raceway |
| C3. Abrasion Protection |
| C4. Cable Management |
| D1. Terminals |
| D2. Power Connectors |
| D3. Grounding Connectors |
| E1. Labeling Systems |
| E2. Labels |
| E3. Pre-Printed & Write-On Markers |
| E4. Permanent Identification |
| E5. Lockout/Tagout & Safety Solutions |
| F. Index |

PANDUIT® ELECTRICAL SOLUTIONS

| A. System Overview | Part Number | Page Number | Part Number | Page Number | Part Number | Page Number |
|---------------------------------------|---------------------|---------------|-----------------------|---------------|------------------|-------------|
| B1. Cable Ties | LCDX8-10AF-L | D2.87 | LCMD120-00-X | D2.110 | LPMM-S2-C | B2.13 |
| | LCDX8-10AH-L | D2.85 | LCMD120-10CD-X | D2.110 | LPMM-S5-C | B2.13 |
| | LCDX8-14A-L | D2.83 | LCMD120-12-X | D2.110 | LPMS-S8-C | B2.13 |
| | LCDX8-14AF-L | D2.87 | LCMD120-14-X | D2.110 | LS8-CASE | E1.2 |
| B2. Cable Accessories | LCDX8-14AH-L | D2.85 | LCMD150-00-X | D2.110 | LS8-CLN | E1.2 |
| | LCDX8-14B-L | D2.83 | LCMD150-10CD-X | D2.110 | LS8-IB | E1.2 |
| | LCDX8-14BF-L | D2.87 | LCMD150-12-X | D2.110 | LS8-PCKIT | E1.2 |
| | LCDX8-14BH-L | D2.85 | LCMD150-14-X | D2.110 | LS8-WS | E1.2 |
| | LCDX8-14D-L | D2.83 | LCMD16-00-Q | D2.110 | LS8E | E1.2 |
| | LCDX8-14DF-L | D2.87 | LCMD16-6CD-Q | D2.110 | LS8E-ACS | E1.2 |
| | LCDX8-14DH-L | D2.85 | LCMD16-8-Q | D2.110 | LS8E-KIT | E1.2 |
| | LCDX8-38D-L | D2.83 | LCMD185-00-X | D2.111 | LS9 | E1.2 |
| | LCDX8-38DF-L | D2.87 | LCMD185-10CD-X | D2.111 | LS9-ACS | E1.2 |
| | LCDX8-38DH-L | D2.85 | LCMD185-12-X | D2.111 | LS9-CASE | E1.2 |
| B3. Stainless Steel Ties | LCDXN2-14A-E | D2.89 | LCMD185-14-X | D2.111 | LS9-CLN | E1.2 |
| | LCDXN350-38D-6 | D2.89 | LCMD240-00-5 | D2.111 | LS9-IB | E1.2 |
| | LCDXN4/0-38D-X | D2.89 | LCMD240-10CD-5 | D2.111 | LS9-WS | E1.2 |
| | LCDXN500-38D-6 | D2.89 | LCMD240-12-5 | D2.111 | LYK | D3.5 |
| C1. Wiring Duct | LCDXN750-12-3 | D2.89 | LCMD240-14-5 | D2.111 | LWC100-A-L | B2.34 |
| | LCDXN750-38D-3 | D2.89 | LCMD25-00-Q | D2.110 | LWC100-A-L14 | B2.34 |
| | LCDXN750-38DF-3 | D2.90 | LCMD25-10-Q | D2.110 | LWC100-A-L20 | B2.34 |
| | LCDXN750-38DH-3 | D2.90 | LCMD25-12-Q | D2.110 | LWC100-H25-L | B2.34 |
| C2. Surface Raceway | LCMA10-10-C | D2.109 | LCMD25-8-Q | D2.110 | LWC100-H25-L14 | B2.34 |
| | LCMA10-5-C | D2.109 | LCMD25-8CD-Q | D2.110 | LWC100-H25-L20 | B2.34 |
| | LCMA10-6-C | D2.109 | LCMD300-00-5 | D2.111 | LWC19-A-C | B2.34 |
| | LCMA10-8-C | D2.109 | LCMD300-12-5 | D2.111 | LWC19-A-C14 | B2.34 |
| | LCMA120-10-L | D2.109 | LCMD300-14-5 | D2.111 | LWC19-A-C20 | B2.34 |
| | LCMA120-12-L | D2.109 | LCMD35-00-Q | D2.110 | LWC19-H25-C | B2.34 |
| | LCMA120-16-L | D2.109 | LCMD35-10-Q | D2.110 | LWC19-H25-C14 | B2.34 |
| | LCMA120-8-L | D2.109 | LCMD35-12-Q | D2.110 | LWC25-A-C | B2.34 |
| | LCMA150-10-X | D2.109 | LCMD35-8CD-Q | D2.110 | LWC25-A-C14 | B2.34 |
| | LCMA150-12-X | D2.109 | LCMD400-00-5 | D2.111 | LWC25-A-C20 | B2.34 |
| C3. Abrasion Protection | LCMA150-16-X | D2.109 | LCMD400-12-5 | D2.111 | LWC25-H25-C | B2.34 |
| | LCMA150-20-X | D2.109 | LCMD400-14-5 | D2.111 | LWC25-H25-C14 | B2.34 |
| | LCMA150-8-X | D2.109 | LCMD400-16-5 | D2.111 | LWC25-H25-C20 | B2.34 |
| | LCMA16-10-C | D2.109 | LCMD50-00-X | D2.110 | LWC38-A-C | B2.34 |
| | LCMA16-5-C | D2.109 | LCMD50-10-X | D2.110 | LWC38-A-C14 | B2.34 |
| | LCMA16-6-C | D2.109 | LCMD50-10CD-X | D2.110 | LWC38-A-C20 | B2.34 |
| | LCMA16-8-C | D2.109 | LCMD50-12-X | D2.110 | LWC38-H25-C | B2.34 |
| | LCMA185-10-X | D2.109 | LCMD500-00-1 | D2.111 | LWC38-H25-C14 | B2.34 |
| | LCMA185-12-X | D2.109 | LCMD500-12-1 | D2.111 | LWC38-H25-C20 | B2.34 |
| | LCMA185-16-X | D2.109 | LCMD500-14-1 | D2.111 | LWC50-A-L | B2.34 |
| C4. Cable Management | LCMA185-20-X | D2.109 | LCMD500-16-1 | D2.111 | LWC50-A-L14 | B2.34 |
| | LCMA240-10-X | D2.109 | LCMD6-5CD-Q | D2.110 | LWC50-A-L20 | B2.34 |
| | LCMA240-12-X | D2.109 | LCMD630-00-1 | D2.111 | LWC50-H25-L | B2.34 |
| | LCMA240-16-X | D2.109 | LCMD630-12-1 | D2.111 | LWC50-H25-L14 | B2.34 |
| | LCMA240-20-X | D2.109 | LCMD630-14-1 | D2.111 | LWC50-H25-L20 | B2.34 |
| | LCMA25-10-C | D2.109 | LCMD630-16-1 | D2.111 | LWC75-A-L | B2.34 |
| | LCMA25-6-C | D2.109 | LCMD70-00-X | D2.110 | LWC75-A-L14 | B2.34 |
| | LCMA25-8-C | D2.109 | LCMD70-10-X | D2.110 | LWC75-A-L20 | B2.34 |
| | LCMA300-10-5 | D2.109 | LCMD70-10CD-X | D2.110 | LWC75-H25-L | B2.34 |
| | LCMA300-12-5 | D2.109 | LCMD70-12-X | D2.110 | LWC75-H25-L14 | B2.34 |
| D1. Terminals | LCMA300-16-5 | D2.109 | LCMD95-00-X | D2.110 | LWC75-H25-L20 | B2.34 |
| | LCMA300-20-5 | D2.109 | LCMD95-10CD-X | D2.110 | | |
| | LCMA35-10-C | D2.109 | LCMD95-12-X | D2.110 | | |
| | LCMA35-12-C | D2.109 | LCMD95-14-X | D2.110 | | |
| | LCMA35-6-C | D2.109 | LD10IW10-A | C2.76 | M200X050Y6T | E2.9 |
| | LCMA35-8-C | D2.109 | LD10IW6-A | C2.76 | M200X050Y7T | E2.9 |
| | LCMA400-12-5 | D2.109 | LD10IW8-A | C2.76 | M200X100Y6T | E2.9 |
| | LCMA400-16-5 | D2.109 | LD2P10IW10-A | C2.75 | M200X100Y7T | E2.9 |
| | LCMA400-20-5 | D2.109 | LD2P10IW8-A | C2.75 | M300X050Y6T | E2.9 |
| | LCMA50-10-L | D2.109 | LD3IW10-A | C2.76 | M300X050Y7T | E2.9 |
| D2. Power Connectors | LCMA50-12-L | D2.109 | LD3IW6-A | C2.76 | M300X100Y6T | E2.9 |
| | LCMA50-6-L | D2.109 | LD3IW8-A | C2.76 | M300X100Y7T | E2.9 |
| | LCMA50-8-L | D2.109 | LD5IW10-A | C2.76 | MACC25-A-C | B2.33 |
| | LCMA500-00-1 | D2.109 | LD5IW6-A | C2.76 | MACC62-A-C | B2.33 |
| | LCMA500-12-1 | D2.109 | LD5IW8-A | C2.76 | MBCEH-QR316 | B3.13 |
| | LCMA500-16-1 | D2.109 | LDPH10IW10-A | C2.77 | MBCH-QR316 | B3.12 |
| | LCMA500-20-1 | D2.109 | LDPH10IW8-A | C2.77 | MBCSH-QR316 | B3.13 |
| | LCMA6-5-C | D2.108 | LDPH3IW10-A | C2.77 | MBEH-TLR | B3.12 |
| | LCMA6-6-C | D2.108 | LDPH3IW8-A | C2.77 | MBEH-TLR316 | B3.12 |
| | LCMA6-8-C | D2.108 | LDPH5IW10-A | C2.77 | MBH-MR | B3.12 |
| D3. Grounding Connectors | LCMA630-00-1 | D2.109 | LDPH5IW8-A | C2.77 | MBH-MR316 | B3.12 |
| | LCMA630-16-1 | D2.109 | LDS3IW10-A | C2.78 | MBH-TLR | B3.12 |
| | LCMA630-20-1 | D2.109 | LDS5IW10-A | C2.78 | MBH-TLR316 | B3.12 |
| | LCMA70-10-L | D2.109 | LHMS-S10-D | B2.17 | MBM-H25-Q | B3.28 |
| | LCMA70-12-L | D2.109 | LHMS-S5-D | B2.17 | MBMS-S10-CY | B2.18 |
| | LCMA70-6-L | D2.109 | LHMS-S6-D | B2.17 | MBS-MR | B3.12 |
| | LCMA70-8-L | D2.109 | LI-112S-L | D3.21 | MBS-MR316 | B3.12 |
| | LCMA95-10-L | D2.109 | LI-252S-Q | D3.21 | MBS-TLR | B3.12 |
| | LCMA95-12-L | D2.109 | LI-50S-C | D3.21 | MBS-TLR316 | B3.12 |
| | LCMA95-16-L | D2.109 | LMD3IW-Q | C2.78 | MBSH-TR | B3.12 |
| E1. Labeling Systems | LCMA95-8-L | D2.109 | LMD5IW-Q | C2.78 | MBSH-TR316 | B3.12 |
| | LCMA95-8-L | D2.109 | LPFCM14-A-C14 | B2.37 | MC100X100IG2 | C1.15 |
| | LCMA95-10-L | D2.109 | LPFCM22-A-C14 | B2.37 | MC100X50IG2 | C1.15 |
| | LCMA95-12-L | D2.109 | LPFCM34-A-C14 | B2.37 | MC100X62IG2 | C1.15 |
| | LCMA95-16-L | D2.109 | | | | |
| | LCMA95-8-L | D2.109 | | | | |
| | LCMD10-00-Q | D2.110 | | | | |
| | LCMD10-6CD-Q | D2.110 | | | | |
| | LCMD10-8-Q | D2.110 | | | | |
| | E2. Labels | | | | | |
| | | | | | | |
| | | | | | | |
| | | | | | | |
| | | | | | | |
| | | | | | | |
| | | | | | | |
| | | | | | | |
| | | | | | | |
| | | | | | | |
| E3. Pre-Printed & Write-On Markers | | | | | | |
| | | | | | | |
| | | | | | | |
| | | | | | | |
| | | | | | | |
| | | | | | | |
| | | | | | | |
| | | | | | | |
| | | | | | | |
| | | | | | | |
| E4. Permanent Identification | | | | | | |
| | | | | | | |
| | | | | | | |
| | | | | | | |
| | | | | | | |
| | | | | | | |
| | | | | | | |
| | | | | | | |
| | | | | | | |
| | | | | | | |
| E5. Lockout/Tagout & Safety Solutions | | | | | | |
| | | | | | | |
| | | | | | | |
| | | | | | | |
| | | | | | | |
| | | | | | | |
| | | | | | | |
| | | | | | | |
| | | | | | | |
| | | | | | | |
| F. Index | | | | | | |
| | | | | | | |
| | | | | | | |
| | | | | | | |
| | | | | | | |
| | | | | | | |
| | | | | | | |
| | | | | | | |
| | | | | | | |
| | | | | | | |

M

PANDUIT® ELECTRICAL SOLUTIONS

| Part Number | Page Number | Part Number | Page Number | Part Number | Page Number |
|---------------------|--------------|---------------------|--------------|----------------------|--------------|
| MC100X75IG2 | C1.15 | MLT4DH-L | B3.11 | MMP350DB-C | E4.3 |
| MC25X25IG2 | C1.15 | MLT4DSH-Q | B3.11 | MMP350DB-C316 | E4.3 |
| MC25X37IG2 | C1.15 | MLT4DSH-Q316 | B3.11 | MMP350H-C | E4.3 |
| MC25X50IG2 | C1.15 | MLT4EH-LP | B3.6 | MMP350H-C316 | E4.3 |
| MC25X62IG2 | C1.15 | MLT4EH-LP316 | B3.7 | MMP350H-CAL | E4.5 |
| MC25X75IG2 | C1.15 | MLT4EH15-LP | B3.6 | MMP350H-CALBL | E4.5 |
| MC37X37IG2 | C1.15 | MLT4EH15-LP316 | B3.7 | MMP350H-CALBU | E4.5 |
| MC37X50IG2 | C1.15 | MLT4H-LP | B3.6 | MMP350H-CALGR | E4.5 |
| MC37X62IG2 | C1.15 | MLT4H-LP316 | B3.7 | MMP350H-CALRD | E4.5 |
| MC37X75IG2 | C1.15 | MLT4H-LPAL | B3.10 | MMP350H-CALYL | E4.5 |
| MC50X100IG2 | C1.15 | MLT4H-LPALBL | B3.10 | MMP350W17-Q | E4.3 |
| MC50X50IG2 | C1.15 | MLT4H-LPALBU | B3.10 | MMP350W38-C | E4.3 |
| MC50X75IG2 | C1.15 | MLT4H-LPALGR | B3.10 | MMP350W38-C316 | E4.3 |
| MC62X37IG2 | C1.15 | MLT4H-LPALRD | B3.10 | MP150-C | B2.29 |
| MC62X62IG2 | C1.15 | MLT4H-LPALYL | B3.10 | MP150-C0 | B2.29 |
| MC75X100IG2 | C1.15 | MLT4LH-LP | B3.6 | MP150-R | B2.29 |
| MC75X50IG2 | C1.15 | MLT4LH-LP316 | B3.6 | MP175-C | B2.29 |
| MC75X62IG2 | C1.15 | MLT4S-CP | B3.5 | MP175-C0 | B2.29 |
| MC75X75IG2 | C1.15 | MLT4S-CP316 | B3.6 | MP175-R | B2.29 |
| MCEH-S25-C0 | B1.24 | MLT4S-L | B3.5 | MP1G106WH | C2.17 |
| MCMS12-P-C | B2.18 | MLT4SH-LP | B3.6 | MP1GBWH | C2.17 |
| MCMS25-P-C | B2.18 | MLT4SH-LP316 | B3.7 | MP1GRWH | C2.17 |
| MCMS30-P-C | B2.18 | MLT5DH-L | B3.11 | MP1TSWH | C2.17 |
| MEHT | E4.5 | MLT6DEH-Q | B3.11 | MP200-C | B2.29 |
| META-X | E4.5 | MLT6DEH-Q316 | B3.11 | MP200-C0 | B2.29 |
| METS3-X | E4.5 | MLT6DEH15-Q | B3.11 | MP200-R | B2.29 |
| METS4-X | E4.5 | MLT6DEH15-Q316 | B3.11 | MP250-C | B2.29 |
| MIM094 | E4.6 | MLT6DH-Q | B3.11 | MP250-C0 | B2.29 |
| MIM125 | E4.6 | MLT6DSH-Q | B3.11 | MP250-R | B2.29 |
| MIM187 | E4.6 | MLT6DSH-Q316 | B3.11 | MP250W175-C | B2.29 |
| MIW094 | E4.6 | MLT6EH-LP | B3.6 | MP2G106BWH | C2.17 |
| MIW125 | E4.6 | MLT6EH-LP316 | B3.7 | MP2G106RWH | C2.17 |
| MIW187 | E4.6 | MLT6EH15-LP | B3.6 | MP2G106TWH | C2.17 |
| ML10-O-LY | D2.134 | MLT6EH15-LP316 | B3.7 | MP2G106WH | C2.17 |
| ML10T-LY | D2.135 | MLT6H-LP | B3.6 | MP2GBWH | C2.17 |
| ML250-QY | D2.134 | MLT6H-LP316 | B3.7 | MP2GRBWH | C2.17 |
| ML250T-Qy | D2.135 | MLT6LH-LP | B3.6 | MP2GRTSWH | C2.17 |
| ML4-CY | D2.134 | MLT6LH-LP316 | B3.6 | MP2GRWH | C2.17 |
| ML4T-CY | D2.135 | MLT6S-CP | B3.5 | MP2TSWH | C2.17 |
| ML8-CY | D2.134 | MLT6S-CP316 | B3.6 | MP350-C | B2.29 |
| ML8T-CY | D2.135 | MLT6SH-LP | B3.6 | MP350-C0 | B2.29 |
| MLT10EH-LP | B3.6 | MLT6SH-LP316 | B3.7 | MP3G1062TSWH | C2.17 |
| MLT10EH15-LP | B3.6 | MLT8DEH-Q | B3.11 | MP3G106WH | C2.17 |
| MLT10H-LP | B3.6 | MLT8DEH-Q316 | B3.11 | MP3GRWH | C2.17 |
| MLT10H-LP316 | B3.7 | MLT8DEH15-Q | B3.11 | MP3TSWH | C2.17 |
| MLT10S-CP | B3.5 | MLT8DEH15-Q316 | B3.11 | MPMH38-L0 | B2.20 |
| MLT10S-CP316 | B3.6 | MLT8DSH-Q | B3.11 | MPMS19-C0 | B2.20 |
| MLT10SH-LP | B3.6 | MLT8DSH-Q316 | B3.11 | MPMS25-C0 | B2.20 |
| MLT12EH-Q | B3.6 | MLT8EH-LP | B3.6 | MPMWH32-L0 | B2.20 |
| MLT12EH15-Q | B3.6 | MLT8EH-LP316 | B3.7 | MPWM-H56-Q | B3.27 |
| MLT12H-Q | B3.6 | MLT8H-LP | B3.6 | MRS1.5H-L4 | B3.19 |
| MLT12S-Q | B3.5 | MLT8H-LP316 | B3.7 | MRS1.5H-L6 | B3.19 |
| MLT12SH-Q | B3.6 | MLT8LH-LP | B3.6 | MRS1.5LH-L4 | B3.19 |
| MLT14H-Q | B3.6 | MLT8LH-LP316 | B3.6 | MRS1.5LH-L6 | B3.19 |
| MLT14S-Q | B3.5 | MLT8SH-LP | B3.6 | MRS1S-C4 | B3.19 |
| MLT15S-Q | B3.5 | MLT8SH-LP316 | B3.7 | MRS1S-C6 | B3.19 |
| MLT1H-LPAL | B3.10 | MLT8S-CP | B3.5 | MRS2H-L4 | B3.19 |
| MLT1H-LPALBL | B3.10 | MLT8S-CP316 | B3.6 | MRS2H-L6 | B3.19 |
| MLT1H-LPALBU | B3.10 | MLT8SH-LP | B3.6 | MRS2LH-L4 | B3.19 |
| MLT1H-LPALGR | B3.10 | MLT8SH-LP316 | B3.7 | MRS2LH-L6 | B3.19 |
| MLT1H-LPALRD | B3.10 | MLTC10H-LP316 | B3.9 | MRS2S-C4 | B3.19 |
| MLT1H-LPALYL | B3.10 | MLTC2H-LP316 | B3.9 | MRS2S-C6 | B3.19 |
| MLT1S-CP | B3.5 | MLTC4H-LP316 | B3.9 | MRS4H-L4 | B3.19 |
| MLT1S-CP316 | B3.6 | MLTC6H-LP316 | B3.9 | MRS4H-L6 | B3.19 |
| MLT2.7H-LP | B3.6 | MLTC8H-LP316 | B3.9 | MRS4LH-L4 | B3.19 |
| MLT2.7H-LP316 | B3.7 | MLTFC2H-LP316 | B3.8 | MRS4LH-L6 | B3.19 |
| MLT2.7S-CP | B3.5 | MLTFC2S-CP316 | B3.8 | MRS4S-C4 | B3.19 |
| MLT2.7S-CP316 | B3.6 | MLTFC4EH-LP316 | B3.8 | MRS4S-C6 | B3.19 |
| MLT2DH-L | B3.11 | MLTFC4H-LP316 | B3.8 | MRS6H-L4 | B3.19 |
| MLT2H-LP | B3.6 | MLTFC4S-CP316 | B3.8 | MRS6H-L6 | B3.19 |
| MLT2H-LP316 | B3.7 | MLTFC4SH-LP316 | B3.8 | MRS6LH-L4 | B3.19 |
| MLT2H-LPAL | B3.10 | MLTFC6EH-LP316 | B3.8 | MRS6LH-L6 | B3.19 |
| MLT2H-LPALBL | B3.10 | MLTFC6H-LP316 | B3.8 | MRS6S-C4 | B3.19 |
| MLT2H-LPALBU | B3.10 | MLTFC6S-CP316 | B3.8 | MRS6S-C6 | B3.19 |
| MLT2H-LPALGR | B3.10 | MLTFC6SH-LP316 | B3.8 | MRT1.5H-L4 | B3.18 |
| MLT2H-LPALRD | B3.10 | MLTFC8EH-LP316 | B3.8 | MRT1.5H-L6 | B3.18 |
| MLT2H-LPALYL | B3.10 | MLTFC8H-LP316 | B3.8 | MRT1.5LH-L4 | B3.18 |
| MLT2LH-LP | B3.6 | MLTFC8S-CP316 | B3.8 | MRT1.5LH-L6 | B3.18 |
| MLT2LH-LP316 | B3.6 | MLTFC8SH-LP316 | B3.8 | MRT1S-C4 | B3.18 |
| MLT2S-CP | B3.5 | MMP172-C | E4.3 | MRT1S-C6 | B3.18 |
| MLT2S-CP316 | B3.6 | MMP172-C316 | E4.3 | MRT2H-L4 | B3.18 |
| MLT2S-L | B3.5 | MMP172W38-C | E4.3 | MRT2H-L6 | B3.18 |
| MLT4DEH-Q | B3.11 | MMP172W38-C316 | E4.3 | MRT2LH-L4 | B3.18 |
| MLT4DEH-Q316 | B3.11 | MMP338W21-Q | E4.3 | MRT2LH-L6 | B3.18 |
| MLT4DEH15-Q | B3.11 | MMP350-C | E4.3 | MRT2S-C4 | B3.18 |
| MLT4DEH15-Q316 | B3.11 | MMP350-C316 | E4.3 | MRT2S-C6 | B3.18 |

| |
|---------------------------------------|
| A. System Overview |
| B1. Cable Ties |
| B2. Cable Accessories |
| B3. Stainless Steel Ties |
| C1. Wiring Duct |
| C2. Surface Raceway |
| C3. Abrasion Protection |
| C4. Cable Management |
| D1. Terminals |
| D2. Power Connectors |
| D3. Grounding Connectors |
| E1. Labeling Systems |
| E2. Labels |
| E3. Pre-Printed & Write-On Markers |
| E4. Permanent Identification |
| E5. Lockout/Tagout & Safety Solutions |
| F. Index |

PANDUIT® ELECTRICAL SOLUTIONS

| A. System Overview | Part Number | Page Number | Part Number | Page Number | Part Number | Page Number |
|---------------------------------------|------------------|--------------|----------------|--------------|---------------|--------------|
| B1. Cable Ties | MRT4H-L4 | B3.18 | MTHEH-C | B3.13 | NE.5X1WH6 | C1.24 |
| | MRT4H-L6 | B3.18 | MTHEH-C316 | B3.13 | NE1.5X1.5WH6 | C1.24 |
| | MRT4LH-L4 | B3.18 | MTHH-C | B3.13 | NE1.5X2WH6 | C1.24 |
| | MRT4LH-L6 | B3.18 | MTHH-C316 | B3.13 | NE1.5X3WH6 | C1.24 |
| | MRT4S-C4 | B3.18 | MTHS-C | B3.13 | NE1.5X4WH6 | C1.24 |
| | MRT4S-C6 | B3.18 | MTHS-C316 | B3.13 | NE1X1.5WH6 | C1.24 |
| B2. Cable Accessories | MRT6H-L4 | B3.18 | MTHSH-C | B3.13 | NE1X1WH6 | C1.24 |
| | MRT6H-L6 | B3.18 | MTHSH-C316 | B3.13 | NE1X2WH6 | C1.24 |
| | MRT6LH-L4 | B3.18 | MTM1H-C | B3.27 | NE1X3WH6 | C1.24 |
| | MRT6LH-L6 | B3.18 | MTM1H10-C | B3.27 | NE1X4WH6 | C1.24 |
| | MRT6S-C4 | B3.18 | MTM1H25-C | B3.27 | NE2X1WH6 | C1.24 |
| | MRT6S-C6 | B3.18 | MTM2H-Q | B3.28 | NE2X2WH6 | C1.24 |
| B3. Stainless Steel Ties | MS10W38T15-L4 | B3.23 | MTMBH-Q | B3.29 | NE2X3WH6 | C1.24 |
| | MS10W38T15-L6 | B3.23 | MTP1H-E10-C | B2.15 | NE2X4WH6 | C1.24 |
| | MS10W50T15-L4 | B3.23 | MTP1H-E6-C | B2.15 | NE3X1WH6 | C1.24 |
| | MS10W50T15-L6 | B3.23 | MTP1S-E10-C | B2.15 | NE3X2WH6 | C1.24 |
| | MS10W63T15-L4 | B3.23 | MTP1S-E6-C | B2.15 | NE3X3WH6 | C1.24 |
| | MS10W63T15-L6 | B3.23 | MTP2H-E10-C | B2.15 | NE3X4WH6 | C1.24 |
| C1. Wiring Duct | MS2W38T15-L4 | B3.23 | MTP2H-E6-C | B2.15 | NE3X5WH6 | C1.24 |
| | MS2W38T15-L6 | B3.23 | MTP2S-E10-C | B2.15 | NE4X2WH6 | C1.24 |
| | MS4W38T15-L4 | B3.23 | MTP2S-E6-C | B2.15 | NE4X3WH6 | C1.24 |
| | MS4W38T15-L6 | B3.23 | MTP3H-E10-C | B2.16 | NE4X4WH6 | C1.24 |
| | MS4W50T15-L4 | B3.23 | MTP3H-E6-C | B2.16 | NE4X5WH6 | C1.24 |
| | MS4W50T15-L6 | B3.23 | MTP3S-E10-C | B2.16 | NK2HSRFIW | C2.54 |
| C2. Surface Raceway | MS4W63T15-L4 | B3.23 | MTP3S-E6-C | B2.16 | NK4HSRFIW | C2.54 |
| | MS4W63T15-L6 | B3.23 | MTP4H-E10-C | B2.16 | NK4VSRFIW | C2.54 |
| | MS6W38T15-L4 | B3.23 | MTP4H-E6-C | B2.16 | NNC100X100LG2 | C1.21 |
| | MS6W38T15-L6 | B3.23 | MTP4S-E10-C | B2.16 | NNC100X50LG2 | C1.21 |
| | MS6W50T15-L4 | B3.23 | MTP4S-E6-C | B2.16 | NNC100X75LG2 | C1.21 |
| | MS6W50T15-L6 | B3.23 | MTP5H-E10-C | B2.16 | NNC25X25LG2 | C1.21 |
| C3. Abrasion Protection | MS6W63T15-L4 | B3.23 | MTP5H-E6-C | B2.16 | NNC25X37LG2 | C1.21 |
| | MS6W63T15-L6 | B3.23 | MTP5S-E10-C | B2.16 | NNC25X50LG2 | C1.21 |
| | MS8W38T15-L4 | B3.23 | MTP5S-E6-C | B2.16 | NNC25X75LG2 | C1.21 |
| | MS8W38T15-L6 | B3.23 | MTP6H-E10-C | B2.16 | NNC37X37LG2 | C1.21 |
| | MS8W50T15-L4 | B3.23 | MTP6H-E6-C | B2.16 | NNC37X50LG2 | C1.21 |
| | MS8W50T15-L6 | B3.23 | MTPC1H-E10-C39 | B2.16 | NNC37X75LG2 | C1.21 |
| C4. Cable Management | MS8W63T15-L4 | B3.23 | MTPC2H-E10-C39 | B2.16 | NNC50DWH2 | C1.21, C1.27 |
| | MS8W63T15-L6 | B3.23 | MTPC3H-E10-C39 | B2.16 | NNC50X100LG2 | C1.21 |
| | MSBW38-C4 | B3.25 | MTPC4H-E10-C39 | B2.16 | NNC50X50LG2 | C1.21 |
| | MSBW38-C6 | B3.25 | MTPC5H-E10-C39 | B2.16 | NNC50X75LG2 | C1.21 |
| | MSBW50-C4 | B3.25 | MTPC6H-E10-C39 | B2.16 | NNC75DWH2 | C1.21, C1.27 |
| | MSBW50-C6 | B3.25 | MTRTH | B3.20 | NNC75X75LG2 | C1.21 |
| D1. Terminals | MSBW63-C4 | B3.25 | MTRTLS | B3.20 | NR1-C | C1.34 |
| | MSBW63-C6 | B3.25 | | | NR1-M | C1.34 |
| | MSC10W38T15-L6 | B3.24 | | | NR2WH-L | C1.59 |
| | MSC10W50T15-L6 | B3.24 | | | NR4BL-L | C1.59 |
| | MSC10W63T15-L6 | B3.24 | | | | |
| | MSC2W38T15-L6 | B3.24 | | | | |
| D2. Power Connectors | MSC4W38T15-L6 | B3.24 | | | | |
| | MSC4W50T15-L6 | B3.24 | | | | |
| | MSC4W63T15-L6 | B3.24 | | | | |
| | MSC6W38T15-L6 | B3.24 | | | | |
| | MSC6W50T15-L6 | B3.24 | | | | |
| | MSC6W63T15-L6 | B3.24 | | | | |
| D3. Grounding Connectors | MSC8W38T15-L6 | B3.24 | | | | |
| | MSC8W50T15-L6 | B3.24 | | | | |
| | MSC8W63T15-L6 | B3.24 | | | | |
| | MSCN150T15-QR6 | B3.25 | | | | |
| | MSCN150T15-QR6 | B3.25 | | | | |
| | MSCN150T15-QR6 | B3.25 | | | | |
| E1. Labeling Systems | MSW38T15-CR4 | B3.25 | | | | |
| | MSW38T15-CR6 | B3.25 | | | | |
| | MSW50T15-CR4 | B3.25 | | | | |
| | MSW50T15-CR6 | B3.25 | | | | |
| | MSW63T15-CR4 | B3.25 | | | | |
| | MSW63T15-CR6 | B3.25 | | | | |
| E2. Labels | MT125S-Q | E4.4 | | | | |
| | MT150D-Q | E4.4 | | | | |
| | MT150D-Q316 | E4.4 | | | | |
| | MT172-C | E4.4 | | | | |
| | MT172-C316 | E4.4 | | | | |
| | MT172W38-C | E4.4, E5.14 | | | | |
| E3. Pre-Printed & Write-On Markers | MT1D-Q | E4.4 | | | | |
| | MT1D-Q316 | E4.4 | | | | |
| | MT213D-Q | E4.4 | | | | |
| | MT213D-Q316 | E4.4 | | | | |
| | MT338W21-Q | E4.4 | | | | |
| | MT350-C | E4.4 | | | | |
| E4. Permanent Identification | MT350-C316 | E4.4 | | | | |
| | MT350W17-Q | E4.4 | | | | |
| | MTB150D-Q | E4.4 | | | | |
| | MTB1D-Q | E4.4, E5.14 | | | | |
| | MTB213D-Q | E4.4 | | | | |
| | MTHCEH-C316 | B3.13 | | | | |
| E5. Lockout/Tagout & Safety Solutions | MTHCH-C316 | B3.13 | | | | |
| | MTHCSH-C316 | B3.13 | | | | |
| | | | | | | |
| | | | | | | |
| | | | | | | |
| | | | | | | |
| F. Index | | | | | | |
| | | | | | | |
| | | | | | | |
| | | | | | | |
| | | | | | | |
| | | | | | | |

PANDUIT® ELECTRICAL SOLUTIONS

| Part Number | Page Number | Part Number | Page Number | Part Number | Page Number |
|--------------|-------------|----------------|--------------|-------------|-------------|
| OFR20WEOB | C2.100 | P18-6RHT6-C | D1.18 | PCA07-MIN | E3.11 |
| OFVR5OBB6 | C2.98 | P18-6RN-C | D1.17 | PCA07-PLS | E3.11 |
| P | | P18-8SLF-C | D1.31 | PCA07-U-Z | E3.11 |
| P10-10F-L | D1.29 | P18-8F-C | D1.29 | PCA07-Z | E3.11 |
| P10-10FF-L | D1.30 | P18-8FF-C | D1.30 | PCA11-0 | E3.12 |
| P10-10LF-L | D1.30 | P18-8LF-C | D1.30 | PCA11-0-9 | E3.12 |
| P10-10R-L | D1.17 | P18-8R-C | D1.17 | PCA11-9 | E3.12 |
| P10-10RHT6-L | D1.18 | P18-8RHT6-C | D1.18 | PCA11-A | E3.12 |
| P10-10SLF-L | D1.31 | P18-8SLF-C | D1.31 | PCA11-A-J | E3.12 |
| P10-12R-L | D1.17 | P18-P47-C | D1.54 | PCA11-K-T | E3.12 |
| P10-14F-L | D1.29 | P2-10R-X | D1.19 | PCA11-MIN | E3.12 |
| P10-14LF-L | D1.30 | P2-12R-X | D1.19 | PCA11-PLS | E3.12 |
| P10-14R-L | D1.17 | P2-14R-X | D1.19 | PCA11-U-Z | E3.12 |
| P10-14RHT6-L | D1.18 | P2-38R-X | D1.19 | PCA11-Z | E3.12 |
| P10-14SLF-L | D1.31 | P2-56R-X | D1.19 | PCA13-0 | E3.12 |
| P10-38R-L | D1.17 | P22-10R-C | D1.17 | PCA13-0-9 | E3.12 |
| P10-56R-L | D1.17 | P22-2F-C | D1.29 | PCA13-9 | E3.12 |
| P10-5SLF-L | D1.31 | P22-2R-C | D1.17 | PCA13-A | E3.12 |
| P10-610R-L | D1.18 | P22-4F-C | D1.29 | PCA13-A-J | E3.12 |
| P10-6F-L | D1.29 | P22-4R-C | D1.17 | PCA13-K-T | E3.12 |
| P10-6LF-L | D1.30 | P22-6F-C | D1.29 | PCA13-MIN | E3.12 |
| P10-6R-L | D1.17 | P22-6R-C | D1.17 | PCA13-PLS | E3.12 |
| P10-6RHT6-L | D1.18 | P22-8R-C | D1.17 | PCA13-U-Z | E3.12 |
| P10-8F-L | D1.29 | P2NLT-500-3 | D2.140 | PCA13-Z | E3.12 |
| P10-8LF-L | D1.30 | P32W2A2-100-7 | C2.84 | PCA18-0 | E3.12 |
| P10-8R-L | D1.17 | P32W2A2-100-72 | C2.84 | PCA18-0-9 | E3.12 |
| P10-8RHT6-L | D1.18 | P32W2A2-50-7 | C1.32, C2.84 | PCA18-9 | E3.12 |
| P10-8SLF-L | D1.31 | P32W2A2-50-72 | C1.32, C2.84 | PCA18-A | E3.12 |
| P10-P55-L | D1.54 | P32W2A2-75-7 | C1.32, C2.84 | PCA18-A-J | E3.12 |
| P12-10HDR-L | D1.19 | P32W2A2-75-72 | C1.32, C2.84 | PCA18-K-T | E3.12 |
| P12-14HDR-L | D1.19 | P32W2R1-100-7 | C2.84 | PCA18-MIN | E3.12 |
| P12-38HDR-L | D1.19 | P32W2R1-100-72 | C2.84 | PCA18-PLS | E3.12 |
| P12-56HDR-L | D1.19 | P32W2R1-150-72 | C2.84 | PCA18-U-Z | E3.12 |
| P12-6HDR-L | D1.19 | P32W2R1-50-7 | C2.84 | PCA18-Z | E3.12 |
| P12-8HDR-L | D1.19 | P32W2R1-50-72 | C2.84 | PCA23-0 | E3.12 |
| P14-10F-C | D1.29 | P32W2R1-75-7 | C2.84 | PCA23-0-3 | E3.12 |
| P14-10FN-C | D1.29 | P4-10R-E | D1.19 | PCA23-4-7 | E3.12 |
| P14-10LF-C | D1.30 | P4-12R-E | D1.19 | PCA23-8-9 | E3.12 |
| P14-10LFN-C | D1.30 | P4-14R-E | D1.19 | PCA23-9 | E3.12 |
| P14-10R-C | D1.17 | P4-38R-E | D1.19 | PCA23-A | E3.12 |
| P14-10RHT6-C | D1.18 | P4-56R-E | D1.19 | PCA23-A-D | E3.12 |
| P14-10SLF-C | D1.31 | P6-10R-E | D1.19 | PCA23-E-H | E3.12 |
| P14-12R-L | D1.17 | P6-12R-E | D1.19 | PCA23-I-L | E3.12 |
| P14-14F-C | D1.29 | P6-14R-E | D1.19 | PCA23-M-P | E3.12 |
| P14-14F-C | D1.29 | P6-38R-E | D1.19 | PCA23-MIN | E3.12 |
| P14-14R-C | D1.17 | P6-56R-E | D1.19 | PCA23-PLS | E3.12 |
| P14-14SLF-C | D1.31 | P6-8R-E | D1.19 | PCA23-Q-T | E3.12 |
| P14-38R-C | D1.17 | P8-10R-Q | D1.19 | PCA23-U-X | E3.12 |
| P14-4R-C | D1.17 | P8-12R-Q | D1.19 | PCA23-Y-Z | E3.12 |
| P14-56R-C | D1.17 | P8-14R-Q | D1.19 | PCA23-Z | E3.12 |
| P14-610R-C | D1.18 | P8-38R-Q | D1.19 | PCL037-0 | E5.35 |
| P14-6F-C | D1.29 | P8-56R-Q | D1.19 | PCL037-0-9 | E5.35 |
| P14-6FF-C | D1.30 | P8-8R-Q | D1.19 | PCL037-1 | E5.35 |
| P14-6FN-C | D1.29 | PARW125-RED | E5.29 | PCL037-9 | E5.35 |
| P14-6LF-C | D1.30 | PARW125-YEL | E5.29 | PCL037-A | E5.35 |
| P14-6LFW-C | D1.30 | PAT1.5M | B1.115 | PCL037-A-Z | E5.35 |
| P14-6R-C | D1.17 | PAT1M | B1.115 | PCL037-Z | E5.35 |
| P14-6RHT6-C | D1.18 | PAT2S | B1.115 | PCL062-0 | E5.35 |
| P14-6SLF-C | D1.31 | PAT2SBM | B1.117 | PCL062-0-9 | E5.35 |
| P14-8F-C | D1.29 | PATMBM | B1.117 | PCL062-1 | E5.35 |
| P14-8FF-C | D1.30 | PBDC | C1.34 | PCL062-9 | E5.35 |
| P14-8LF-C | D1.30 | PBMS-H25-C | B2.19 | PCL062-A | E5.35 |
| P14-8R-C | D1.17 | PBMS-H25-C14 | B2.19 | PCL062-A-Z | E5.35 |
| P14-8RHT6-C | D1.18 | PBMS-H25-M0 | B2.19 | PCL062-DSH | E5.35 |
| P14-8SLF-C | D1.31 | PBMS-H25-M30 | B2.19 | PCL062-Z | E5.35 |
| P14-P47-C | D1.54 | PBMSL-H25-C30 | B2.19 | PCL100-0 | E5.35 |
| P18-10F-C | D1.29 | PBMSL-H25-M30 | B2.19 | PCL100-0-9 | E5.35 |
| P18-10FN-C | D1.29 | PBSC1-X | B2.50 | PCL100-1 | E5.35 |
| P18-10LF-C | D1.30 | PBSC12-X | B2.50 | PCL100-9 | E5.35 |
| P18-10LFN-C | D1.30 | PBSC3-X | B2.50 | PCL100-1 | E5.35 |
| P18-10R-C | D1.17 | PBSC6-X | B2.50 | PCL100-A | E5.35 |
| P18-10RHT6-C | D1.18 | PC038-H25D-C0 | B2.39 | PCL100-A-J | E5.35 |
| P18-10SLF-C | D1.31 | PC050-H25D-C0 | B2.39 | PCL100-DSH | E5.35 |
| P18-12R-C | D1.17 | PC062-H25D-C0 | B2.39 | PCL100-K-T | E5.35 |
| P18-14F-C | D1.29 | PC075-H25D-C0 | B2.39 | PCL100-U-Z | E5.35 |
| P18-14R-C | D1.17 | PC087-H25D-C0 | B2.39 | PCL100-Z | E5.35 |
| P18-38R-C | D1.17 | PC100-H25D-C0 | B2.39 | PCL200-0 | E5.35 |
| P18-4R-C | D1.17 | PC112-H25D-C0 | B2.39 | PCL200-0-9 | E5.35 |
| P18-56R-C | D1.17 | PC125-H25D-C0 | B2.39 | PCL200-1 | E5.35 |
| P18-610R-C | D1.18 | PCA07-0 | E3.11 | PCL200-9 | E5.35 |
| P18-6F-C | D1.29 | PCA07-0-9 | E3.11 | PCL200-A | E5.35 |
| P18-6FN-C | D1.29 | PCA07-9 | E3.11 | PCL200-A-J | E5.35 |
| P18-6LF-C | D1.30 | PCA07-A | E3.11 | PCL200-DSH | E5.35 |
| P18-6LFW-C | D1.30 | PCA07-A-J | E3.11 | PCL200-K-T | E5.35 |
| P18-6R-C | D1.17 | PCA07-K-T | E3.11 | PCL200-U-Z | E5.35 |
| | | | | PCL200-Z | E5.35 |
| | | | | PCL300-0 | E5.36 |

| |
|---------------------------------------|
| A. System Overview |
| B1. Cable Ties |
| B2. Cable Accessories |
| B3. Stainless Steel Ties |
| C1. Wiring Duct |
| C2. Surface Raceway |
| C3. Abrasion Protection |
| C4. Cable Management |
| D1. Terminals |
| D2. Power Connectors |
| D3. Grounding Connectors |
| E1. Labeling Systems |
| E2. Labels |
| E3. Pre-Printed & Write-On Markers |
| E4. Permanent Identification |
| E5. Lockout/Tagout & Safety Solutions |
| F. Index |

PANDUIT® ELECTRICAL SOLUTIONS

| A. System Overview | Part Number | Page Number | Part Number | Page Number | Part Number | Page Number |
|---------------------------------------|--------------|---------------|----------------|-----------------|-----------------|-------------|
| B1. Cable Ties | PCL300-1 | E5.36 | PCMB-13 | E3.2 | PCSB350-6-2 | D2.157 |
| | PCL300-9 | E5.36 | PCMB-14 | E3.2 | PCSB350-6S-2Y | D2.155 |
| | PCL300-A | E5.36 | PCMB-15 | E3.2 | PCSB350-7-2 | D2.157 |
| | PCL300-DSH | E5.36 | PCMB-16 | E3.2 | PCSB350-8-2 | D2.157 |
| | PCL300-Z | E5.36 | PCMB-2 | E3.2 | PCSB350-8S-2Y | D2.155 |
| B2. Cable Accessories | PCLCP037-0-9 | E5.35 | PCMB-25 | E3.2 | PCSB4-10-4Y | D2.156 |
| | PCLCP037-A-Z | E5.35 | PCMB-3 | E3.2 | PCSB4-10S-4Y | D2.155 |
| | PCLCP062-0-9 | E5.35 | PCMB-4 | E3.2 | PCSB4-12-3Y | D2.156 |
| | PCLCP062-A-Z | E5.35 | PCMB-5 | E3.2 | PCSB4-12S-3Y | D2.155 |
| | PCLCP100-0-9 | E5.35 | PCMB-6 | E3.2 | PCSB4-14-2Y | D2.156 |
| B3. Stainless Steel Ties | PCLCP100-A-Z | E5.35 | PCMB-7 | E3.2 | PCSB4-14S-2Y | D2.155 |
| | PCLCP200-0-9 | E5.35 | PCMB-8 | E3.2 | PCSB4-2-12Y | D2.156 |
| | PCLCP200-A-Z | E5.35 | PCMB-9 | E3.2 | PCSB4-2S-12Y | D2.155 |
| | PCLCP300-0-9 | E5.36 | PCMCP-1-25 | E3.6 | PCSB4-3-12Y | D2.156 |
| | PCLCP300-A-Z | E5.36 | PCMCP-101-125 | E3.6 | PCSB4-3S-12Y | D2.155 |
| C1. Wiring Duct | PCM-0 | E3.4 | PCMCP-126-150 | E3.6 | PCSB4-4-6Y | D2.156 |
| | PCM-0-9 | E3.4 | PCMCP-26-50 | E3.6 | PCSB4-4S-6Y | D2.155 |
| | PCM-1-10 | E3.4 | PCMCP-51-75 | E3.6 | PCSB4-5-6Y | D2.156 |
| | PCM-1-12 | E3.4 | PCMCP-76-100 | E3.6 | PCSB4-5S-6Y | D2.155 |
| | PCM-1-16 | E3.4 | PCMCP-A-Z | E3.6 | PCSB4-6-6Y | D2.156 |
| C2. Surface Raceway | PCM-1-18 | E3.4 | PCMH-0 | E3.4 | PCSB4-6S-6Y | D2.155 |
| | PCM-1-3 | E3.4 | PCMH-25 | E3.4 | PCSB4-7-4Y | D2.156 |
| | PCM-1-33 | E3.4 | PCPA11IW | C2.107 | PCSB4-8-4Y | D2.156 |
| | PCM-1-4 | E3.4 | PCPA11R20IW | C2.104 | PCSB500-2-4Y | D2.157 |
| | PCM-1-5 | E3.4 | PCPA13IW | C2.107 | PCSB500-3-3Y | D2.157 |
| C3. Abrasion Protection | PCM-1-6 | E3.4 | PCPA13R20IW | C2.104 | PCSB500-4-2Y | D2.157 |
| | PCM-1-8 | E3.4 | PCPAK16IW | C2.110 | PCSB500-5-2Y | D2.157 |
| | PCM-1-9 | E3.4 | PCPAK22IW | C2.110 | PCSB500-6-2Y | D2.157 |
| | PCM-100 | E3.4 | PCPAKR20IW | C2.110 | PCSB500-7-2Y | D2.157 |
| | PCM-100-124 | E3.4 | PCPAKR1W | C2.110 | PCSB500-8-2Y | D2.157 |
| C4. Cable Management | PCM-125-149 | E3.4 | PCPBRC | C2.111 | PCSB600-10-1Y | D2.157 |
| | PCM-150-174 | E3.4 | PCPECIW | C2.111 | PCSB600-10S-1Y | D2.155 |
| | PCM-175-199 | E3.4 | PCPKITIW | C2.111 | PCSB600-12-1Y | D2.157 |
| | PCM-19-36 | E3.4 | PCPTPIW | C2.111 | PCSB600-12S-1Y | D2.155 |
| | PCM-202 | E3.4 | PCSB2/0-10-2Y | D2.156 | PCSB600-14-1Y | D2.157 |
| D1. Terminals | PCM-34-66 | E3.4 | PCSB2/0-10S-2Y | D2.155 | PCSB600-14S-1Y | D2.155 |
| | PCM-67-99 | E3.4 | PCSB2/0-12-2Y | D2.156 | PCSB600-2-4Y | D2.157 |
| | PCM-99 | E3.4 | PCSB2/0-12S-1Y | D2.155 | PCSB600-2S-4Y | D2.155 |
| | PCM-A | E3.5 | PCSB2/0-14-1Y | D2.156 | PCSB600-3-3Y | D2.157 |
| | PCM-A-Z | E3.5 | PCSB2/0-14S-1Y | D2.155 | PCSB600-3S-3Y | D2.155 |
| D2. Power Connectors | PCM-A-Z-0-9 | E3.5 | PCSB2/0-2-12 | D2.156 | PCSB600-4-2Y | D2.157 |
| | PCM-A1 | E3.5 | PCSB2/0-2S-6 | D2.155 | PCSB600-4S-2Y | D2.155 |
| | PCM-A4 | E3.5 | PCSB2/0-3-6 | D2.156 | PCSB600-5-2 | D2.157 |
| | PCM-B1 | E3.5 | PCSB2/0-3S-6Y | D2.155 | PCSB600-5S-2Y | D2.155 |
| | PCM-B5 | E3.5 | PCSB2/0-4-6 | D2.156 | PCSB600-6-2Y | D2.157 |
| D3. Grounding Connectors | PCM-BLK | E3.6 | PCSB2/0-4S-6Y | D2.155 | PCSB600-6S-2Y | D2.155 |
| | PCM-BRN | E3.6 | PCSB2/0-5-6 | D2.156 | PCSB600-8-2Y | D2.157 |
| | PCM-C1 | E3.5 | PCSB2/0-5S-4Y | D2.155 | PCSB600-8S-2Y | D2.155 |
| | PCM-C4 | E3.5 | PCSB2/0-6-6 | D2.156 | PCSB750-10-1Y | D2.157 |
| | PCM-DBL | E3.6 | PCSB2/0-6S-4Y | D2.155 | PCSB750-2-2Y | D2.157 |
| E1. Labeling Systems | PCM-DGN | E3.6 | PCSB2/0-7-4 | D2.156 | PCSB750-3-2Y | D2.157 |
| | PCM-E1 | E3.5 | PCSB2/0-8-4 | D2.156 | PCSB750-4-2Y | D2.157 |
| | PCM-E3 | E3.5 | PCSB2/0-8S-3 | D2.155 | PCSB750-5-1Y | D2.157 |
| | PCM-F1 | E3.5 | PCSB250-10-2Y | D2.156 | PCSB750-6-1Y | D2.157 |
| | PCM-F4 | E3.5 | PCSB250-10S-2Y | D2.155 | PCSB750-7-1Y | D2.157 |
| E2. Labels | PCM-GRY | E3.6 | PCSB250-12-2Y | D2.156 | PCSB750-8-1Y | D2.157 |
| | PCM-H1 | E3.5 | PCSB250-12S-2Y | D2.155 | PCSB750-9-1Y | D2.157 |
| | PCM-H5 | E3.5 | PCSB250-14-1Y | D2.156 | PCSBMT2/0-10-2Y | D2.160 |
| | PCM-L1 | E3.5 | PCSB250-14S-1Y | D2.155 | PCSBMT2/0-10S2Y | D2.159 |
| | PCM-L5 | E3.5 | PCSB250-2-6Y | D2.156 | PCSBMT2/0-12-1Y | D2.160 |
| E3. Pre-Printed & Write-On Markers | PCM-LBL | E3.6 | PCSB250-2S-6Y | D2.155 | PCSBMT2/0-12S1Y | D2.159 |
| | PCM-LGN | E3.6 | PCSB250-3-6Y | D2.156 | PCSBMT2/0-4-3Y | D2.160 |
| | PCM-M1 | E3.5 | PCSB250-3S-6Y | D2.155 | PCSBMT2/0-8-2Y | D2.160 |
| | PCM-M2 | E3.5 | PCSB250-4-6Y | D2.156 | PCSBMT2/0-8S-2Y | D2.159 |
| | PCM-ORN | E3.6 | PCSB250-4S-6Y | D2.155 | PCSBMT2/0-6-2Y | D2.160 |
| E4. Permanent Identification | PCM-P1 | E3.5 | PCSB250-5-4Y | D2.156 | PCSBMT2/0-6S-2Y | D2.159 |
| | PCM-P3 | E3.5 | PCSB250-5S-4Y | D2.155 | PCSBMT2/0-8-2Y | D2.160 |
| | PCM-PNK | E3.6 | PCSB250-6-4Y | D2.156 | PCSBMT2/0-8S-2Y | D2.159 |
| | PCM-PUR | E3.6 | PCSB250-6S-4Y | D2.155 | PCSBMT250-10-2Y | D2.160 |
| | PCM-R1 | E3.5 | PCSB250-7-3Y | D2.156 | PCSBMT250-10S2Y | D2.159 |
| E5. Lockout/Tagout & Safety Solutions | PCM-R5 | E3.5 | PCSB250-7-3Y | D2.156 | PCSBMT250-12-1Y | D2.160 |
| | PCM-RED | E3.6 | PCSB250-8-3Y | D2.156 | PCSBMT250-12S1Y | D2.159 |
| | PCM-S1 | E3.5 | PCSB250-8S-3Y | D2.155 | PCSBMT250-4-2Y | D2.160 |
| | PCM-S5 | E3.5 | PCSB350-10-2Y | D2.157 | PCSBMT250-4S-2Y | D2.159 |
| | PCM-T1 | E3.5 | PCSB350-10S-2Y | D2.155 | PCSBMT250-6-2Y | D2.160 |
| F. Index | PCM-T9 | E3.5 | PCSB350-12-1Y | D2.157 | PCSBMT250-6S-2Y | D2.159 |
| | PCM-TAN | E3.6 | PCSB350-12S-1Y | D2.155 | PCSBMT250-8-2Y | D2.160 |
| | PCM-WHT | E3.6 | PCSB350-14-1Y | D2.157 | PCSBMT250-8S-2Y | D2.159 |
| | PCM-X1 | E3.5 | PCSB350-14S-1Y | D2.155 | PCSBMT350-10-1Y | D2.160 |
| | PCM-X4 | E3.5 | PCSB350-2-4 | D2.157 | PCSBMT350-10S1Y | D2.159 |
| PCM-YEL | E3.6 | PCSB350-2S-4Y | D2.155 | PCSBMT350-12-1Y | D2.160 | |
| PCM-Z | E3.5 | PCSB350-3-4 | D2.157 | PCSBMT350-12S1Y | D2.159 | |
| PCMB-1 | E3.2 | PCSB350-3S-4Y | D2.155 | PCSBMT350-4-2Y | D2.160 | |
| PCMB-10 | E3.2 | PCSB350-4-3 | D2.157 | PCSBMT350-4S-2Y | D2.159 | |
| PCMB-11 | E3.2 | PCSB350-4S-3Y | D2.155 | PCSBMT350-6-2Y | D2.160 | |
| PCMB-12 | E3.2 | PCSB350-5-3 | D2.157 | PCSBMT350-6S-2Y | D2.159 | |
| | | | PCSB350-5S-3Y | D2.155 | PCSBMT350-8-2Y | D2.160 |

PANDUIT® ELECTRICAL SOLUTIONS

| Part Number | Page Number | Part Number | Page Number | Part Number | Page Number |
|-----------------|-------------|--------------|-------------|-------------|---------------------|
| PCSBMT350-8S-2Y | D2.159 | PCV-415A | E5.30 | PESC-H-E | E5.23 |
| PCSBMT600-10-1Y | D2.160 | PCV-415AY | E5.30 | PESC-H-EC | E5.23 |
| PCSBMT600-10S1Y | D2.159 | PCV-415B | E5.30 | PESC-H-HT | E5.23 |
| PCSBMT600-12-1Y | D2.160 | PCV-415BY | E5.30 | PESC-H-PE | E5.23 |
| PCSBMT600-12S1Y | D2.159 | PCV-415CY | E5.30 | PESC-J-AT | E5.23 |
| PCSBMT600-4-2Y | D2.160 | PCV-4160A | E5.30 | PESC-J-E | E5.23 |
| PCSBMT600-4S-2Y | D2.159 | PCV-4160AY | E5.30 | PESC-J-EC | E5.23 |
| PCSBMT600-6-2Y | D2.160 | PCV-4160BY | E5.30 | PESC-J-HT | E5.23 |
| PCSBMT600-6S-2Y | D2.159 | PCV-4160CY | E5.30 | PESC-J-PE | E5.23 |
| PCSBMT600-8-2Y | D2.160 | PCV-440A | E5.30 | PESS-A-CE | E5.24 |
| PCSBMT600-8S-2Y | D2.159 | PCV-440AY | E5.30 | PESS-A-ES | E5.24 |
| PCSH-B-CR | B3.26 | PCV-440BY | E5.30 | PESS-A-L1 | E5.24 |
| PCSS-B-CR | B3.26 | PCV-440CY | E5.30 | PESS-A-L2 | E5.24 |
| PCSSH-B-CR | B3.26 | PCV-460A | E5.30 | PESS-A-L3 | E5.24 |
| PCV-110A | E5.30 | PCV-460AY | E5.30 | PESS-A-LF | E5.24 |
| PCV-110AY | E5.30 | PCV-460BY | E5.30 | PESS-A-N | E5.24 |
| PCV-110BY | E5.30 | PCV-460CY | E5.30 | PESS-A-PE | E5.24 |
| PCV-110CY | E5.30 | PCV-480A | E5.30 | PESS-A-ROHS | E5.24 |
| PCV-115A | E5.30 | PCV-480AY | E5.30 | PESS-A-SS | E5.24 |
| PCV-115AY | E5.30 | PCV-480BY | E5.30 | PESS-B-CE | E5.24 |
| PCV-115BY | E5.30 | PCV-480CY | E5.30 | PESS-B-ES | E5.24 |
| PCV-115CY | E5.30 | PCV-600A | E5.30 | PESS-B-L1 | E5.24 |
| PCV-120/208A | E5.30 | PCV-600AY | E5.30 | PESS-B-L2 | E5.24 |
| PCV-120/208AY | E5.30 | PCV-600BY | E5.30 | PESS-B-L3 | E5.24 |
| PCV-120/208BY | E5.30 | PCV-600CY | E5.30 | PESS-B-N | E5.24 |
| PCV-120/208CY | E5.30 | PCV-BLANKA | E5.30 | PESS-B-SS | E5.24 |
| PCV-120A | E5.30 | PCV-BLANKAY | E5.30 | PESS-C-CE | E5.24 |
| PCV-120AY | E5.30 | PCV-BLANKBY | E5.30 | PESS-C-ES | E5.24 |
| PCV-120BY | E5.30 | PCV-BLANKCY | E5.30 | PESS-C-L1 | E5.24 |
| PCV-120CY | E5.30 | PCV-ESA | E5.30 | PESS-C-L2 | E5.24 |
| PCV-12470A | E5.30 | PCV-ESAY | E5.30 | PESS-C-L3 | E5.24 |
| PCV-12470AY | E5.30 | PCV-ESBY | E5.30 | PESS-C-N | E5.24 |
| PCV-12470BY | E5.30 | PCV-ESCY | E5.30 | PESS-C-SS | E5.24 |
| PCV-12470CY | E5.30 | PCV-FAA | E5.30 | PESS-D-CE | E5.24 |
| PCV-13200A | E5.30 | PCV-FAAY | E5.30 | PESS-D-ES | E5.24 |
| PCV-13200AY | E5.30 | PCV-FABY | E5.30 | PESS-D-L1 | E5.24 |
| PCV-13200BY | E5.30 | PCV-FAC | E5.30 | PESS-D-L2 | E5.24 |
| PCV-13200CY | E5.30 | PCV-FACY | E5.30 | PESS-D-L3 | E5.24 |
| PCV-13800A | E5.30 | PCV-FOA | E5.30 | PESS-D-N | E5.24 |
| PCV-13800AY | E5.30 | PCV-FOAY | E5.30 | PESS-D-SS | E5.24 |
| PCV-13800BY | E5.30 | PCV-FOBY | E5.30 | PESS-E-CE | E5.24 |
| PCV-13800CY | E5.30 | PCV-FOCA | E5.30 | PESS-E-ES | E5.24 |
| PCV-1PHA | E5.30 | PCV-FOCAY | E5.30 | PESS-E-L1 | E5.24 |
| PCV-1PHAY | E5.30 | PCV-FOCBY | E5.30 | PESS-E-L2 | E5.24 |
| PCV-1PHBY | E5.30 | PCV-FOCCY | E5.30 | PESS-E-L3 | E5.24 |
| PCV-1PHCY | E5.30 | PCV-FOCY | E5.30 | PESW-A-1 | E5.25 |
| PCV-208A | E5.30 | PCV-MAINA | E5.30 | PESW-A-11 | E5.25 |
| PCV-208AY | E5.30 | PCV-MAINAY | E5.30 | PESW-A-11Y | E5.25 |
| PCV-208BY | E5.30 | PCV-MAINBY | E5.30 | PESW-A-1Y | E5.25 |
| PCV-208CY | E5.30 | PCV-MAINCY | E5.30 | PESW-A-6 | E5.25 |
| PCV-220A | E5.30 | PCV-TELEA | E5.30 | PESW-A-6Y | E5.25 |
| PCV-220AY | E5.30 | PCV-TELEAY | E5.30 | PESW-A-8 | E5.25 |
| PCV-220BY | E5.30 | PCV-TELEBY | E5.30 | PESW-A-8Y | E5.25 |
| PCV-220CY | E5.30 | PCV-TELECY | E5.30 | PESW-A-9 | E5.25 |
| PCV-2300A | E5.30 | PCVB-110 | E5.31 | PESW-A-9Y | E5.25 |
| PCV-2300AY | E5.30 | PCVB-220 | E5.31 | PESW-B-1 | E5.25 |
| PCV-2300BY | E5.30 | PCVB-277 | E5.31 | PESW-B-11Y | E5.25 |
| PCV-2300CY | E5.30 | PCVB-277/480 | E5.31 | PESW-B-1Y | E5.25 |
| PCV-230A | E5.30 | PCVB-4160 | E5.31 | PESW-B-6Y | E5.25 |
| PCV-230AY | E5.30 | PCVB-440 | E5.31 | PESW-B-8Y | E5.25 |
| PCV-230BY | E5.30 | PCVB-480 | E5.31 | PESW-B-9Y | E5.25 |
| PCV-230CY | E5.30 | PCWL-ACC | E5.27 | PESW-C-11Y | E5.25 |
| PCV-2400A | E5.30 | PCWL-BL | E5.27 | PESW-C-1Y | E5.25 |
| PCV-2400AY | E5.30 | PCWL-CAL | E5.27 | PESW-C-6Y | E5.25 |
| PCV-2400BY | E5.30 | PCWL-CALD | E5.27 | PESW-C-8Y | E5.25 |
| PCV-2400CY | E5.30 | PCWL-ICAL | E5.27 | PESW-C-9Y | E5.25 |
| PCV-240A | E5.30 | PCWL-REJ | E5.27 | PESW-D-11Y | E5.25 |
| PCV-240AY | E5.30 | PD-DIA | B1.117 | PESW-D-1Y | E5.25 |
| PCV-240BY | E5.30 | PD-600-A | D1.86 | PESW-D-6Y | E5.25 |
| PCV-240CY | E5.30 | PDH10-37 | B1.117 | PESW-D-8Y | E5.25 |
| PCV-277/480A | E5.30 | PDM | B1.115 | PESW-D-9Y | E5.25 |
| PCV-277/480AY | E5.30 | PDM-DI | B1.117 | PESW-E-11Y | E5.25 |
| PCV-277/480BY | E5.30 | PDS | B1.115 | PESW-E-1Y | E5.25 |
| PCV-277/480CY | E5.30 | PDS-DI | B1.117 | PESW-E-6Y | E5.25 |
| PCV-277A | E5.30 | PDSF | B1.116 | PESW-E-8Y | E5.25 |
| PCV-277AY | E5.30 | PEIP-A-08Y | E5.29 | PESW-E-9Y | E5.25 |
| PCV-277BY | E5.30 | PEIP-A-09Y | E5.29 | PFX-0 | B1.51, B2.28, E5.20 |
| PCV-277CY | E5.30 | PEIP-A-10Y | E5.29 | PFX-2 | B1.51, B2.28, E5.20 |
| PCV-380A | E5.30 | PEIP-A-11Y | E5.29 | PG-1 | D3.51 |
| PCV-380AY | E5.30 | PEIP-C-08-DY | E5.29 | PG-1SC | D3.51 |
| PCV-380BY | E5.30 | PEIP-D-08Y | E5.29 | PH10-10F-E | D1.31 |
| PCV-380CY | E5.30 | PEIP-D-09Y | E5.29 | PH10-10R-E | D1.13 |
| PCV-3PHA | E5.30 | PEIP-D-10Y | E5.29 | PH10-12R-E | D1.13 |
| PCV-3PHAY | E5.30 | PEIP-D-11Y | E5.29 | PH10-14R-E | D1.13 |
| PCV-3PHBY | E5.30 | PES-S1 | E5.10 | PH10-38R-E | D1.13 |
| PCV-3PHCY | E5.30 | PESC-H-AT | E5.23 | PH10-8F-E | D1.31 |

| |
|---------------------------------------|
| A. System Overview |
| B1. Cable Ties |
| B2. Cable Accessories |
| B3. Stainless Steel Ties |
| C1. Wiring Duct |
| C2. Surface Raceway |
| C3. Abrasion Protection |
| C4. Cable Management |
| D1. Terminals |
| D2. Power Connectors |
| D3. Grounding Connectors |
| E1. Labeling Systems |
| E2. Labels |
| E3. Pre-Printed & Write-On Markers |
| E4. Permanent Identification |
| E5. Lockout/Tagout & Safety Solutions |
| F. Index |

PANDUIT® ELECTRICAL SOLUTIONS

| A. System Overview | Part Number | Page Number | Part Number | Page Number | Part Number | Page Number | |
|--------------------------|--------------------------|----------------------|-----------------|------------------------------------|------------------------------|---------------------------------------|----------|
| B1. Cable Ties | PH10-8R-E | D1.13 | PLD-12 | E5.26 | PLT1.5S-M30 | B1.12 | |
| | PH14-10F-Q | D1.31 | PLD-17 | E5.28 | PLT10EH-C | B1.9 | |
| | PH14-10R-Q | D1.13 | PLD-18 | E5.28 | PLT10EH-Q0 | B1.11 | |
| | PH14-14R-Q | D1.13 | PLD-22 | E5.28 | PLT10LH-L | B1.8 | |
| | PH14-38R-Q | D1.13 | PLD-28 | E5.28 | PLT12EH-C | B1.9 | |
| | PH14-56R-Q | D1.13 | PLD-29 | E5.28 | PLT12EH-Q0 | B1.11 | |
| | PH14-6F-Q | D1.31 | PLD-3 | E5.28 | PLT13H-Q | B1.8 | |
| | PH14-6R-Q | D1.13 | PLD-30 | E5.26 | PLT13H-Q0 | B1.10 | |
| | PH14-8F-Q | D1.31 | PLD-36 | E5.26 | PLT1M-C | B1.8 | |
| | PH14-8R-Q | D1.13 | PLD-37 | E5.26 | PLT1M-C0 | B1.10 | |
| B2. Cable Accessories | PH18-10F-Q | D1.31 | PLD-38 | E5.26 | PLT1M-C30 | B1.12 | |
| | PH18-10R-Q | D1.13 | PLD-4 | E5.28 | PLT1M-C702Y | B1.18 | |
| | PH18-14R-Q | D1.13 | PLD-43 | E5.26 | PLT1M-C76 | B1.19 | |
| | PH18-6F-Q | D1.31 | PLD-45 | E5.26 | PLT1M-C86 | B1.21 | |
| | PH18-6R-Q | D1.13 | PLD-46 | E5.26 | PLT1M-L0 | B1.82 | |
| | PH18-8F-Q | D1.31 | PLD-47 | E5.26 | PLT1M-L1 | B1.82 | |
| | PH18-8R-Q | D1.13 | PLD-52 | E5.26 | PLT1M-L1-0 | B1.82 | |
| | PHCAQ | B1.111 | PLD-56 | E5.26 | PLT1M-L1-10 | B1.82 | |
| | PHCAT | B1.111 | PLD-57 | E5.26 | PLT1M-L1-2 | B1.82 | |
| | PHM1 | B1.116 | PLD-58 | E5.26 | PLT1M-L1-4 | B1.82 | |
| B3. Stainless Steel Ties | PHM2 | B1.116 | PLD-60 | E5.26 | PLT1M-L1-7 | B1.82 | |
| | PHM3 | B1.116 | PLD-67 | E5.26 | PLT1M-L2 | B1.82 | |
| | PHM4 | B1.116 | PLD-68 | E5.26 | PLT1M-L3 | B1.82 | |
| | PHS2 | B1.116 | PLD-7 | E5.28 | PLT1M-L3-0 | B1.82 | |
| | PHS3 | B1.116 | PLD-71 | E5.26 | PLT1M-L3-10 | B1.82 | |
| | PISR1/0-1 | D2.158 | PLD-72 | E5.26 | PLT1M-L3-2 | B1.82 | |
| | PISR2-1 | D2.158 | PLD-74 | E5.26 | PLT1M-L3-4 | B1.82 | |
| | PISR250-1 | D2.158 | PLD-80 | E5.26 | PLT1M-L3-7 | B1.82 | |
| | PISR350-1 | D2.158 | PLD-81 | E5.26 | PLT1M-L4Y | B1.82 | |
| | PISR500-1 | D2.158 | PLD-91 | E5.26 | PLT1M-L5 | B1.82 | |
| C1. Wiring Duct | PK10-10R-L | D1.12 | PLF1M-C | B1.34 | PLT1M-L5-0 | B1.82 | |
| | PK10-14R-L | D1.12 | PLF1M-C0 | B1.34 | PLT1M-L5-10 | B1.82 | |
| | PK10-6R-L | D1.12 | PLF1M-M69 | B1.34 | PLT1M-L5-2 | B1.82 | |
| | PK10-8R-L | D1.12 | PLF1MA-C | B1.34 | PLT1M-L5-4 | B1.82 | |
| | PK14-10R-C | D1.12 | PLF1MA-M0 | B1.34 | PLT1M-L5-7 | B1.82 | |
| | PK14-14R-C | D1.12 | PLF1MB-C | B1.34 | PLT1M-L6 | B1.82 | |
| | PK14-4R-C | D1.12 | PLF1MC-M | B1.34 | PLT1M-L6-0 | B1.82 | |
| | PK14-6R-C | D1.12 | PLM1M-C | B1.34 | PLT1M-L6-10 | B1.82 | |
| | PK14-8R-C | D1.12 | PLM1M-C0 | B1.34 | PLT1M-L6-2 | B1.82 | |
| | PK18-10R-C | D1.12 | PLM1M-M69 | B1.34 | PLT1M-L6-4 | B1.82 | |
| C2. Surface Raceway | PK18-4R-C | D1.12 | PLM2M-C | B1.34 | PLT1M-L6-7 | B1.82 | |
| | PK18-6R-C | D1.12 | PLM2M-M0 | B1.34 | PLT1M-L8 | B1.82 | |
| | PK18-8R-C | D1.12 | PLM2S-C | B1.34 | PLT1M-L8-0 | B1.82 | |
| | PL283N1 | B1.117 | PLM2S-C0 | B1.34 | PLT1M-L8-10 | B1.82 | |
| | PL289N1 | B1.111, B3.16 | PLM4S-C | B1.34 | PLT1M-L8-2 | B1.82 | |
| | PL2M2S-L | B1.34 | PLM4S-D0 | B1.34 | PLT1M-L8-4 | B1.82 | |
| | PL2M2S-L0 | B1.34 | PLMA14Y | E3.3 | PLT1M-L8-7 | B1.82 | |
| | PL3B5EH-C0 | B1.78 | PLMA1Y | E3.3 | PLT1M-M100 | B1.17 | |
| | PL3M2S-D0 | B1.34 | PLMA2Y | E3.3 | PLT1M-M109 | B1.16 | |
| | PL3M2S-L | B1.34 | PLMA3Y | E3.3 | PLT1M-M300 | B1.13 | |
| C3. Abrasion Protection | PLA2S-A-Q | B2.6 | PLP1.5I-C | B1.33 | PLT1M-M60 | B1.14 | |
| | PLB2S-C | B1.76 | PLP1.5I-M0 | B1.33 | PLT1M-M69 | B1.14 | |
| | PLB2S-C0 | B1.76 | PLP1.5I-M30 | B1.33 | PLT1M-XMR | B1.119 | |
| | PLB2S-M30 | B1.76 | PLP1.5S-M | B1.33 | PLT1M-XMR0 | B1.119 | |
| | PLB3S-C | B1.76 | PLP1S-M | B1.33 | PLT1M-XMR00 | B1.119 | |
| | PLB3S-C0 | B1.76 | PLP1S-M0 | B1.33 | PLT1M-XMR1 | B1.119 | |
| | PLB3S-M30 | B1.76 | PLP1S-M30 | B1.33 | PLT1M-XMR10 | B1.119 | |
| | PLB4H-TL | B1.76 | PLP2S-C | B1.33 | PLT1M-XMR2 | B1.119 | |
| | PLB4H-TL0 | B1.76 | PLP2S-M0 | B1.33 | PLT1M-XMR3 | B1.119 | |
| | PLB4H-TL30 | B1.76 | PLP2S-M30 | B1.33 | PLT1M-XMR30 | B1.119 | |
| C4. Cable Management | PLB4S-C | B1.76 | PLST30SC-D30 | B1.74 | PLT1M-XMR4Y | B1.119 | |
| | PLB4S-M0 | B1.76 | PLST4HS25-TL300 | B1.74 | PLT1M-XMR5 | B1.119 | |
| | PLB4S-M30 | B1.76 | PLST50SC-D30 | B1.74 | PLT1M-XMR6 | B1.119 | |
| | PLC1.5I-S8-C | B1.26 | PLT.6SM-C | B1.8 | PLT1M-XMR7 | B1.119 | |
| | PLC1.5I-S8-C0 | B1.27 | PLT.6SM-C0 | B1.10 | PLT1M-XMR8 | B1.119 | |
| | PLC1.5I-S8-M30 | B1.27 | PLT.6SM-M30 | B1.12 | PLT1S-C | B1.8 | |
| | PLC1M-S4-C | B1.26 | PLT.7M-C | B1.8 | PLT1S-C0 | B1.10 | |
| | PLC1M-S4-C0 | B1.27 | PLT.7M-M0 | B1.10 | PLT1S-M30 | B1.12 | |
| | PLC1M-S4-M30 | B1.27 | PLT.7M-M30 | B1.12 | PLT1S-M300 | B1.13 | |
| | PLC2H-S25-L | B1.26 | PLT1.5I-C | B1.8 | PLT2.5H-L | B1.8 | |
| D1. Terminals | PLC2H-S25-TL0 | B1.27 | PLT1.5I-C0 | B1.10 | PLT2.5H-L0 | B1.10 | |
| | PLC2H-S25-TL30 | B1.27 | PLT1.5I-C30 | B1.12 | PLT2.5I-C | B1.8 | |
| | PLC2S-S10-C | B1.26 | PLT1.5I-M100 | B1.17 | PLT2.5I-C0 | B1.10 | |
| | PLC2S-S10-C0 | B1.27 | PLT1.5I-M109 | B1.16 | PLT2.5S-C | B1.8 | |
| | PLC2S-S10-M30 | B1.27 | PLT1.5I-M120 | B1.15 | PLT2.5S-C0 | B1.10 | |
| | PLC2S-S6-C | B1.26 | PLT1.5I-M300 | B1.13 | PLT2.5S-M30 | B1.12 | |
| | PLC2S-S6-C0 | B1.27 | PLT1.5I-M69 | B1.14 | PLT2EH-C | B1.9 | |
| | PLC3S-S10-C | B1.26 | PLT1.5M-C | B1.8 | PLT2EH-Q0 | B1.11 | |
| | PLC3S-S10-C0 | B1.27 | PLT1.5M-C0 | B1.10 | PLT2H-L | B1.8 | |
| | PLC4H-S25-L | B1.26 | PLT1.5M-M30 | B1.12 | PLT2H-L0 | B1.10 | |
| D2. Power Connectors | PLC4H-S25-L0 | B1.27 | PLT1.5M-XMR | B1.119 | PLT2H-TL100 | B1.17 | |
| | PLC4H-S25-TL30 | B1.27 | PLT1.5M-XMR0 | B1.119 | PLT2H-TL109 | B1.16 | |
| | PLC4S-S10-C | B1.26 | PLT1.5M-XMR00 | B1.119 | PLT2H-TL30 | B1.12 | |
| | PLC4S-S10-C0 | B1.27 | PLT1.5M-XMR30 | B1.119 | PLT2H-TL300 | B1.13 | |
| | PLC4S-S10-M30 | B1.27 | PLT1.5S-C | B1.8 | PLT2I-C | B1.8 | |
| | PLD-11 | E5.28 | PLT1.5S-C0 | B1.10 | PLT2I-C0 | B1.10 | |
| | D3. Grounding Connectors | E1. Labeling Systems | E2. Labels | E3. Pre-Printed & Write-On Markers | E4. Permanent Identification | E5. Lockout/Tagout & Safety Solutions | F. Index |

PANDUIT® ELECTRICAL SOLUTIONS

| Part Number | Page Number |
|-------------------|---------------|
| PLT2I-C30 | B1.12 |
| PLT2I-C76 | B1.19 |
| PLT2I-C86 | B1.21 |
| PLT2I-M300 | B1.13 |
| PLT2I-M69 | B1.14 |
| PLT2M-C | B1.8 |
| PLT2M-C0 | B1.10 |
| PLT2M-M30 | B1.12 |
| PLT2M-M69 | B1.14 |
| PLT2S-C | B1.8 |
| PLT2S-C0 | B1.10 |
| PLT2S-C30 | B1.12 |
| PLT2S-C702Y | B1.18 |
| PLT2S-C71 | B1.20 |
| PLT2S-C76 | B1.19 |
| PLT2S-C86 | B1.21 |
| PLT2S-M100 | B1.17 |
| PLT2S-M109 | B1.16 |
| PLT2S-M120 | B1.15 |
| PLT2S-M300 | B1.13 |
| PLT2S-M39 | B1.12 |
| PLT2S-M60 | B1.14 |
| PLT2S-M69 | B1.14 |
| PLT2S-VMR | B1.120 |
| PLT2S-VMR0 | B1.120 |
| PLT2S-VMR30 | B1.120 |
| PLT3EH-NB-C0 | B1.11 |
| PLT3H-L | B1.8 |
| PLT3H-L0 | B1.10 |
| PLT3H-L76 | B1.19 |
| PLT3H-L86 | B1.21 |
| PLT3H-TL100 | B1.17 |
| PLT3H-TL109 | B1.16 |
| PLT3H-TL30 | B1.12 |
| PLT3I-C | B1.8 |
| PLT3I-C0 | B1.10 |
| PLT3I-M30 | B1.12 |
| PLT3S-C | B1.8 |
| PLT3S-C0 | B1.10 |
| PLT3S-C30 | B1.12 |
| PLT3S-C702Y | B1.18 |
| PLT3S-C76 | B1.19 |
| PLT3S-C86 | B1.21 |
| PLT3S-M100 | B1.17 |
| PLT3S-M109 | B1.16 |
| PLT4.5S-C | B1.8 |
| PLT4.5S-C0 | B1.10 |
| PLT4H-L | B1.8 |
| PLT4H-L0 | B1.10 |
| PLT4H-L76 | B1.19 |
| PLT4H-L86 | B1.21 |
| PLT4H-TL100 | B1.17 |
| PLT4H-TL109 | B1.16 |
| PLT4H-TL120 | B1.15 |
| PLT4H-TL30 | B1.12 |
| PLT4H-TL300 | B1.13 |
| PLT4H-TL69 | B1.14 |
| PLT4I-C | B1.8 |
| PLT4I-C0 | B1.10 |
| PLT4I-M30 | B1.12 |
| PLT4S-C | B1.8 |
| PLT4S-C0 | B1.10 |
| PLT4S-C30 | B1.12 |
| PLT4S-C76 | B1.19 |
| PLT4S-C86 | B1.21 |
| PLT4S-M100 | B1.17 |
| PLT4S-M109 | B1.16 |
| PLT4S-M120 | B1.15 |
| PLT4S-M300 | B1.13 |
| PLT4S-M69 | B1.14 |
| PLT5EH-NB-C0 | B1.11 |
| PLT5EH-Q | B1.9 |
| PLT5EH-Q0 | B1.11 |
| PLT5H-C30 | B1.12 |
| PLT5H-L | B1.8 |
| PLT5H-L0 | B1.10 |
| PLT5S-C | B1.8 |
| PLT5S-C0 | B1.10 |
| PLT5S-M30 | B1.12 |
| PLT6EH-NB-C0 | B1.11 |
| PLT6EH-Q | B1.9 |
| PLT6EH-Q0 | B1.11 |
| PLT6H-C30 | B1.12 |
| PLT6H-L | B1.8 |
| PLT6H-L0 | B1.10 |
| PLT6LH-L | B1.8 |

| Part Number | Page Number |
|--------------|-------------|
| PLT6LH-L0 | B1.10 |
| PLT7LH-C30 | B1.12 |
| PLT7LH-L | B1.8 |
| PLT7LH-L0 | B1.10 |
| PLT8EH-C | B1.9 |
| PLT8EH-Q0 | B1.11 |
| PLT8H-C30 | B1.12 |
| PLT8H-L | B1.8 |
| PLT8H-L0 | B1.10 |
| PLT8LH-C120 | B1.15 |
| PLT8LH-L | B1.8 |
| PLT8LH-L0 | B1.10 |
| PLT9LH-C30 | B1.12 |
| PLT9LH-L | B1.8 |
| PLT9LH-L0 | B1.10 |
| PLUP40S-D30 | B1.32 |
| PLUP40SE-D | B1.32 |
| PLUP40SE-D30 | B1.32 |
| PLWP1.5I-C | B1.28 |
| PLWP1.5I-D30 | B1.29 |
| PLWP1.5S-D | B1.28 |
| PLWP1.5S-D30 | B1.29 |
| PLWP1.5SA-D | B1.28 |
| PLWP1M-C | B1.28 |
| PLWP1M-D0 | B1.29 |
| PLWP1M-D30 | B1.29 |
| PLWP1S-C | B1.28 |
| PLWP1S-C0 | B1.29 |
| PLWP1S-D30 | B1.29 |
| PLWP1SA-D | B1.28 |
| PLWP1SB-D | B1.28 |
| PLWP2H-TL | B1.28 |
| PLWP2H-TL0 | B1.29 |
| PLWP2H-TL30 | B1.29 |
| PLWP2S-C | B1.28 |
| PLWP2S-C0 | B1.29 |
| PLWP2S-D30 | B1.29 |
| PLWP2SA-D | B1.28 |
| PLWP2SB-D | B1.28 |
| PLWP30SC-D30 | B1.31 |
| PLWP3H-TL | B1.28 |
| PLWP3H-TL0 | B1.29 |
| PLWP40SC-D30 | B1.31 |
| PLWP40SD-D30 | B1.31 |
| PLWP50SC-D30 | B1.31 |
| PLWP50SE-D30 | B1.31 |
| PM1-3F-C | D1.36 |
| PM1-3R-C | D1.34 |
| PM1-4F-C | D1.36 |
| PM1-4R-C | D1.34 |
| PM1-5F-C | D1.36 |
| PM1-5R-C | D1.34 |
| PM1-P10-C | D1.60 |
| PM2-3F-C | D1.36 |
| PM2-3R-C | D1.34 |
| PM2-4F-C | D1.36 |
| PM2-4R-C | D1.34 |
| PM2-5F-C | D1.36 |
| PM2-5R-C | D1.34 |
| PM2-P10-C | D1.60 |
| PM2H25-C | B2.19 |
| PM2H25-M0 | B2.19 |
| PM2H25-M30 | B2.19 |
| PM6-3R-L | D1.34 |
| PM6-4R-L | D1.34 |
| PM6-5F-L | D1.36 |
| PM6-5R-L | D1.34 |
| PM6-6F-L | D1.36 |
| PM6-6R-L | D1.34 |
| PM6-8R-L | D1.34 |
| PM6-P10-L | D1.60 |
| PMCC38H25-C | B2.31 |
| PMCC38H25-M0 | B2.31 |
| PMD | E3.9 |
| PMD-0-9 | E3.9 |
| PMD-NEMA | E3.9 |
| PMDR-0 | E3.10 |
| PMDR-0-9 | E3.10 |
| PMDR-9 | E3.10 |
| PMDR-90-99 | E3.10 |
| PMDR-A | E3.10 |
| PMDR-BL | E3.10 |
| PMDR-BLK | E3.10 |
| PMDR-BRN | E3.10 |
| PMDR-GRN | E3.10 |
| PMDR-GRS | E3.10 |

| Part Number | Page Number |
|---------------------|---------------|
| PMDR-GRY | E3.10 |
| PMDR-L1 | E3.10 |
| PMDR-L3 | E3.10 |
| PMDR-MIN | E3.10 |
| PMDR-NEMA | E3.10 |
| PMDR-ORN | E3.10 |
| PMDR-PLS | E3.10 |
| PMDR-PUR | E3.10 |
| PMDR-RED | E3.10 |
| PMDR-T1 | E3.10 |
| PMDR-T3 | E3.10 |
| PMDR-WHT | E3.10 |
| PMDR-YEL | E3.10 |
| PMDR-Z | E3.10 |
| PMN1-35R-3K | D1.116 |
| PMN1-3F-3K | D1.119 |
| PMN1-3R-3K | D1.116 |
| PMN1-4F-3K | D1.119 |
| PMN1-4R-3K | D1.116 |
| PMN1-5F-3K | D1.119 |
| PMN1-5R-3K | D1.116 |
| PMN1-6F-3K | D1.119 |
| PMN1-6R-3K | D1.116 |
| PMN2-35R-3K | D1.116 |
| PMN2-3F-3K | D1.119 |
| PMN2-3R-3K | D1.116 |
| PMN2-4F-3K | D1.119 |
| PMN2-4R-3K | D1.116 |
| PMN2-5F-3K | D1.119 |
| PMN2-5R-3K | D1.116 |
| PMN2-6F-3K | D1.119 |
| PMN2-6R-3K | D1.116 |
| PMN6-35R-2K | D1.116 |
| PMN6-3R-2K | D1.116 |
| PMN6-4F-2K | D1.119 |
| PMN6-4R-2K | D1.116 |
| PMN6-5F-2K | D1.119 |
| PMN6-5R-2K | D1.116 |
| PMN6-6F-2K | D1.119 |
| PMN6-6R-2K | D1.116 |
| PMN6-8R-2K | D1.116 |
| PMNF1-35R-3K | D1.117 |
| PMNF1-3F-3K | D1.119 |
| PMNF1-3F-C | D1.35 |
| PMNF1-3R-3K | D1.117 |
| PMNF1-3R-C | D1.33 |
| PMNF1-4F-3K | D1.119 |
| PMNF1-4F-C | D1.35 |
| PMNF1-4R-3K | D1.117 |
| PMNF1-4R-C | D1.33 |
| PMNF1-5F-3K | D1.119 |
| PMNF1-5F-C | D1.35 |
| PMNF1-5R-3K | D1.117 |
| PMNF1-5R-C | D1.33 |
| PMNF1-6F-3K | D1.119 |
| PMNF1-6F-C | D1.35 |
| PMNF1-6R-3K | D1.117 |
| PMNF1-6R-C | D1.33 |
| PMNF2-35R-3K | D1.117 |
| PMNF2-3F-3K | D1.119 |
| PMNF2-3F-C | D1.35 |
| PMNF2-3R-3K | D1.117 |
| PMNF2-3R-C | D1.33 |
| PMNF2-4F-3K | D1.119 |
| PMNF2-4F-C | D1.35 |
| PMNF2-4R-3K | D1.117 |
| PMNF2-4R-C | D1.33 |
| PMNF2-5F-3K | D1.119 |
| PMNF2-5F-C | D1.35 |
| PMNF2-5R-3K | D1.117 |
| PMNF2-5R-C | D1.33 |
| PMNF2-6F-3K | D1.119 |
| PMNF2-6F-C | D1.35 |
| PMNF2-6R-3K | D1.117 |
| PMNF2-6R-C | D1.33 |
| PMNF6-35R-2K | D1.117 |
| PMNF6-3R-2K | D1.117 |
| PMNF6-3R-L | D1.33 |
| PMNF6-4F-2K | D1.119 |
| PMNF6-4F-L | D1.35 |
| PMNF6-4R-2K | D1.117 |
| PMNF6-4R-L | D1.33 |
| PMNF6-5F-2K | D1.119 |
| PMNF6-5F-L | D1.35 |
| PMNF6-5R-2K | D1.117 |
| PMNF6-5R-L | D1.33 |

| A. System Overview |
|---------------------------------------|
| B1. Cable Ties |
| B2. Cable Accessories |
| B3. Stainless Steel Ties |
| C1. Wiring Duct |
| C2. Surface Raceway |
| C3. Abrasion Protection |
| C4. Cable Management |
| D1. Terminals |
| D2. Power Connectors |
| D3. Grounding Connectors |
| E1. Labeling Systems |
| E2. Labels |
| E3. Pre-Printed & Write-On Markers |
| E4. Permanent Identification |
| E5. Lockout/Tagout & Safety Solutions |
| F. Index |

PANDUIT® ELECTRICAL SOLUTIONS

| A. System Overview | Part Number | Page Number | Part Number | Page Number | Part Number | Page Number |
|----------------------|----------------------|---------------------|-------------------|---------------|--------------|-------------|
| B1. Cable Ties | PMNF6-6F-2K | D1.119 | PMR5WPB-X | C2.11 | PN10-14RX-L | D1.7 |
| | PMNF6-6F-L | D1.35 | PMR7CCWH-X | C2.12 | PN10-14SLF-L | D1.26 |
| | PMNF6-6R-2K | D1.117 | PMR7DAWH | C2.12 | PN10-38R-2K | D1.103 |
| | PMNF6-6R-L | D1.33 | PMR7ICWH | C2.12 | PN10-38R-L | D1.6 |
| | PMNF6-8R-2K | D1.117 | PMR7MSWH-X | C2.11 | PN10-38RX-L | D1.7 |
| | PMNF6-8R-L | D1.33 | PMR7OCWH | C2.12 | PN10-56R-2K | D1.103 |
| | PMR40BC | C2.5 | PMR7RAWH | C2.12 | PN10-56R-L | D1.6 |
| | PMR40BFWH | C2.6 | PMR7TRWH | C2.12 | PN10-56RX-L | D1.7 |
| | PMR40BWH10 | C2.5 | PMR7WH10 | C2.11 | PN10-5SLF-L | D1.26 |
| | PMR40CWH13.75 | C2.5 | PMR7WH5 | C2.11 | PN10-610R-L | D1.9 |
| PMR40CWH19.75 | C2.5 | PMR7WPB-X | C2.11 | PN10-6F-2K | D1.107 | |
| PMR40CWH31.75 | C2.5 | PMRTUPAL | C2.13 | PN10-6F-L | D1.21 | |
| PMR40CWH5 | C2.5 | PMRTUPWH | C2.13 | PN10-6LF-2K | D1.110 | |
| PMR40CWH7.75 | C2.5 | PMV1-35RB-3K | D1.118 | PN10-6LF-L | D1.24 | |
| PMR40DB50 | C2.6 | PMV1-3FB-3K | D1.120 | PN10-6R-2K | D1.103 | |
| PMR40DC-X | C2.5 | PMV1-3FB-CY | D1.35 | PN10-6R-L | D1.6 | |
| PMR40DP50WH | C2.6 | PMV1-3RB-3K | D1.118 | PN10-6RX-L | D1.7 | |
| PMR40DW5 | C2.5 | PMV1-3RB-CY | D1.34 | PN10-6SLF-L | D1.26 | |
| PMR40E45EWH | C2.6 | PMV1-4FB-3K | D1.120 | PN10-8F-2K | D1.107 | |
| PMR40ECWH | C2.6 | PMV1-4FB-CY | D1.35 | PN10-8F-L | D1.21 | |
| PMR40EEWH | C2.6 | PMV1-4RB-3K | D1.118 | PN10-8FF-2K | D1.113 | |
| PMR40FH2WH | C2.6 | PMV1-4RB-CY | D1.34 | PN10-8FF-L | D1.28 | |
| PMR40FH4WH | C2.6 | PMV1-5FB-3K | D1.120 | PN10-8LF-2K | D1.110 | |
| PMR40I45EWH | C2.6 | PMV1-5FB-CY | D1.35 | PN10-8LF-L | D1.24 | |
| PMR40ICC | C2.6 | PMV1-5RB-3K | D1.118 | PN10-8R-2K | D1.103 | |
| PMR40ICWH | C2.6 | PMV1-5RB-CY | D1.34 | PN10-8R-L | D1.6 | |
| PMR40KH2WH | C2.6 | PMV1-6FB-3K | D1.120 | PN10-8RX-L | D1.7 | |
| PMR40KH4WH | C2.6 | PMV1-6FB-CY | D1.35 | PN10-8SLF-2K | D1.112 | |
| PMR40OCWH | C2.6 | PMV1-6RB-3K | D1.118 | PN10-8SLF-L | D1.26 | |
| PMR40PCWH | C2.6 | PMV1-6RB-CY | D1.34 | PN12-10HDR-2K | D1.106 | |
| PMR40RAWH | C2.5 | PMV1-P10-CY | D1.60 | PN12-10HDR-L | D1.13 | |
| PMR40SIC | C2.5 | PMV1-P12B-3K | D1.138 | PN12-14HDR-2K | D1.106 | |
| PMR40SOCWH | C2.6 | PMV2-35RB-3K | D1.118 | PN12-14HDR-L | D1.13 | |
| PMR40T50 | C2.6 | PMV2-3FB-3K | D1.120 | PN12-38HDR-2K | D1.106 | |
| PMR40TRWH | C2.6 | PMV2-3FB-C | D1.35 | PN12-38HDR-L | D1.13 | |
| PMR40TWH | C2.6 | PMV2-3RB-3K | D1.118 | PN12-56HDR-2K | D1.106 | |
| PMR40WR-X | C2.6 | PMV2-3RB-C | D1.34 | PN12-56HDR-L | D1.13 | |
| PMR5737AWH | C2.16 | PMV2-4FB-3K | D1.120 | PN12-6HDR-2K | D1.106 | |
| PMR5737WH | C2.16 | PMV2-4FB-C | D1.35 | PN12-8HDR-2K | D1.106 | |
| PMR5738AWH | C2.16 | PMV2-4RB-3K | D1.118 | PN12-8HDR-L | D1.13 | |
| PMR5738WH | C2.16 | PMV2-4RB-C | D1.34 | PN14-10F-3K | D1.107 | |
| PMR5739AWH | C2.16 | PMV2-5FB-3K | D1.120 | PN14-10F-C | D1.21 | |
| PMR5739WH | C2.16 | PMV2-5FB-C | D1.35 | PN14-10FF-3K | D1.113 | |
| PMR5744-2WH | C2.16 | PMV2-5RB-3K | D1.118 | PN14-10FF-C | D1.28 | |
| PMR5744-3WH | C2.16 | PMV2-5RB-C | D1.34 | PN14-10FN-3K | D1.107 | |
| PMR5744S-2WH | C2.15 | PMV2-6FB-3K | D1.120 | PN14-10FN-C | D1.21 | |
| PMR5744S-3WH | C2.16 | PMV2-6FB-C | D1.35 | PN14-10LF-3K | D1.110 | |
| PMR5744SWH | C2.15 | PMV2-6RB-3K | D1.118 | PN14-10LF-C | D1.24 | |
| PMR5744WH | C2.16 | PMV2-6RB-C | D1.34 | PN14-10LFN-C | D1.24 | |
| PMR5747-2WH | C2.15 | PMV2-P10-C | D1.60 | PN14-10R-3K | D1.103 | |
| PMR5747-3WH | C2.15 | PMV2-P12B-3K | D1.138 | PN14-10R-C | D1.6 | |
| PMR5747WH | C2.15 | PMV6-35RB-2K | D1.118 | PN14-10RX-C | D1.7 | |
| PMR5748-2WH | C2.15 | PMV6-3R-L | D1.34 | PN14-10SLF-3K | D1.112 | |
| PMR5748-3WH | C2.15 | PMV6-3RB-2K | D1.118 | PN14-10SLF-C | D1.26 | |
| PMR5748WH | C2.15 | PMV6-4F-L | D1.35 | PN14-12R-L | D1.6 | |
| PMR5751-2WH | C2.15 | PMV6-4FB-2K | D1.120 | PN14-14F-3K | D1.107 | |
| PMR5751-3WH | C2.15 | PMV6-4R-L | D1.34 | PN14-14F-C | D1.21 | |
| PMR5751WH | C2.15 | PMV6-4RB-2K | D1.118 | PN14-14R-3K | D1.103 | |
| PMR5752RD | C2.16 | PMV6-5F-L | D1.35 | PN14-14R-C | D1.6 | |
| PMR5753RD | C2.16 | PMV6-5FB-2K | D1.120 | PN14-14RX-C | D1.7 | |
| PMR5760WH | C2.15 | PMV6-5R-L | D1.34 | PN14-14SLF-C | D1.26 | |
| PMR57AOCWH | C2.12 | PMV6-5RB-2K | D1.118 | PN14-38R-L | D1.6 | |
| PMR57CBWH | C2.12 | PMV6-6F-L | D1.35 | PN14-4R-3K | D1.103 | |
| PMR57CC50-X | C2.12 | PMV6-6FB-2K | D1.120 | PN14-4R-C | D1.6 | |
| PMR57CC75-X | C2.12 | PMV6-6R-L | D1.34 | PN14-56R-C | D1.6 | |
| PMR57EBCWH | C2.12 | PMV6-6RB-2K | D1.118 | PN14-5SLF-3K | D1.112 | |
| PMR57ECCWH | C2.12 | PMV6-8R-L | D1.34 | PN14-5SLF-C | D1.26 | |
| PMR57EEWH | C2.12 | PMV6-8RB-2K | D1.118 | PN14-610R-C | D1.9 | |
| PMR57GC-X | C2.11 | PMV6-P10-L | D1.60 | PN14-6F-3K | D1.107 | |
| PMR57JBC50-X | C2.12 | PN10-10F-2K | D1.107 | PN14-6F-C | D1.21 | |
| PMR57JBC75-X | C2.12 | PN10-10F-L | D1.21 | PN14-6FF-3K | D1.113 | |
| PMR57JC-X | C2.12 | PN10-10FF-2K | D1.113 | PN14-6FF-C | D1.28 | |
| PMR57LTEWH | C2.11 | PN10-10FF-L | D1.28 | PN14-6FN-3K | D1.107 | |
| PMR57MRT | C2.13 | PN10-10LF-2K | D1.110 | PN14-6FN-C | D1.21 | |
| PMR57RTEWH | C2.12 | PN10-10LF-L | D1.24 | PN14-6LF-3K | D1.110 | |
| PMR57SC-X | C2.11 | PN10-10R-2K | D1.103 | PN14-6LF-C | D1.24 | |
| PMR57TWH | C2.12 | PN10-10R-L | D1.6 | PN14-6LFW-C | D1.24 | |
| PMR5CCWH-X | C2.12 | PN10-10RX-L | D1.7 | PN14-6R-3K | D1.103 | |
| PMR5DAWH | C2.12 | PN10-10SLF-2K | D1.112 | PN14-6R-C | D1.6 | |
| PMR5ICWH | C2.12 | PN10-10SLF-L | D1.26 | PN14-6RN-3K | D1.103 | |
| PMR5MSWH-X | C2.11 | PN10-12R-L | D1.6 | PN14-6RN-C | D1.6 | |
| PMR5OCWH | C2.12 | PN10-14F-2K | D1.107 | PN14-6RX-C | D1.7 | |
| PMR5RAWH | C2.12 | PN10-14F-L | D1.21 | PN14-6SLF-3K | D1.112 | |
| PMR5TRWH | C2.12 | PN10-14LF-L | D1.24 | PN14-6SLF-C | D1.26 | |
| PMR5WH10 | C2.11 | PN10-14R-2K | D1.103 | PN14-8F-3K | D1.107 | |
| PMR5WH5 | C2.11 | PN10-14R-L | D1.6 | PN14-8F-C | D1.21 | |

| Part Number | Page Number |
|----------------|-------------|
| PN14-8FF-3K | D1.113 |
| PN14-8FF-C | D1.28 |
| PN14-8LF-3K | D1.110 |
| PN14-8LF-C | D1.24 |
| PN14-8R-3K | D1.103 |
| PN14-8R-C | D1.6 |
| PN14-8RX-C | D1.7 |
| PN14-8SLF-3K | D1.112 |
| PN14-8SLF-C | D1.26 |
| PN18-10F-3K | D1.107 |
| PN18-10F-C | D1.21 |
| PN18-10FF-3K | D1.113 |
| PN18-10FF-C | D1.28 |
| PN18-10FN-3K | D1.107 |
| PN18-10FN-C | D1.21 |
| PN18-10LF-3K | D1.110 |
| PN18-10LF-C | D1.24 |
| PN18-10LFN-C | D1.24 |
| PN18-10R-3K | D1.103 |
| PN18-10R-C | D1.6 |
| PN18-10SLF-3K | D1.112 |
| PN18-10SLF-C | D1.26 |
| PN18-12R-C | D1.6 |
| PN18-14F-3K | D1.107 |
| PN18-14F-C | D1.21 |
| PN18-14R-3K | D1.103 |
| PN18-14R-C | D1.6 |
| PN18-38R-C | D1.6 |
| PN18-4R-3K | D1.103 |
| PN18-4R-C | D1.6 |
| PN18-4RN-C | D1.6 |
| PN18-56R-C | D1.6 |
| PN18-5SLF-3K | D1.112 |
| PN18-5SLF-C | D1.26 |
| PN18-610R-C | D1.9 |
| PN18-6F-3K | D1.107 |
| PN18-6F-C | D1.21 |
| PN18-6FF-3K | D1.113 |
| PN18-6FF-C | D1.28 |
| PN18-6FN-3K | D1.107 |
| PN18-6FN-C | D1.21 |
| PN18-6LF-3K | D1.110 |
| PN18-6LF-C | D1.24 |
| PN18-6LFW-C | D1.24 |
| PN18-6R-3K | D1.103 |
| PN18-6R-C | D1.6 |
| PN18-6RN-3K | D1.103 |
| PN18-6RN-C | D1.6 |
| PN18-6SLF-3K | D1.112 |
| PN18-6SLF-C | D1.26 |
| PN18-8F-3K | D1.107 |
| PN18-8F-C | D1.21 |
| PN18-8FF-3K | D1.113 |
| PN18-8FF-C | D1.28 |
| PN18-8LF-3K | D1.110 |
| PN18-8LF-C | D1.24 |
| PN18-8R-3K | D1.103 |
| PN18-8R-C | D1.6 |
| PN18-8SLF-3K | D1.112 |
| PN18-8SLF-C | D1.26 |
| PN22-10R-C | D1.6 |
| PN22-2F-C | D1.21 |
| PN22-2R-C | D1.6 |
| PN22-4F-C | D1.21 |
| PN22-4R-C | D1.6 |
| PN22-6F-C | D1.21 |
| PN22-6R-C | D1.6 |
| PN22-8R-C | D1.6 |
| PNF10-10F-2K | D1.108 |
| PNF10-10F-L | D1.22 |
| PNF10-10FF-2K | D1.114 |
| PNF10-10LF-2K | D1.110 |
| PNF10-10LF-L | D1.25 |
| PNF10-10R-2K | D1.104 |
| PNF10-10R-L | D1.8 |
| PNF10-10SLF-2K | D1.112 |
| PNF10-10SLF-L | D1.27 |
| PNF10-14F-2K | D1.108 |
| PNF10-14F-L | D1.22 |
| PNF10-14R-2K | D1.104 |
| PNF10-14R-L | D1.8 |
| PNF10-14SLF-L | D1.27 |
| PNF10-38R-2K | D1.104 |
| PNF10-38R-L | D1.8 |

| Part Number | Page Number |
|----------------|-------------|
| PNF10-56R-2K | D1.104 |
| PNF10-56R-L | D1.8 |
| PNF10-6F-2K | D1.108 |
| PNF10-6F-L | D1.22 |
| PNF10-6LF-2K | D1.110 |
| PNF10-6LF-L | D1.25 |
| PNF10-6R-2K | D1.104 |
| PNF10-6R-L | D1.8 |
| PNF10-6SLF-2K | D1.112 |
| PNF10-6SLF-L | D1.27 |
| PNF10-8F-2K | D1.108 |
| PNF10-8F-L | D1.22 |
| PNF10-8FF-2K | D1.114 |
| PNF10-8LF-2K | D1.110 |
| PNF10-8LF-L | D1.25 |
| PNF10-8R-2K | D1.104 |
| PNF10-8R-L | D1.8 |
| PNF10-8SLF-2K | D1.112 |
| PNF10-8SLF-L | D1.27 |
| PNF14-10F-3K | D1.108 |
| PNF14-10F-C | D1.22 |
| PNF14-10FF-3K | D1.114 |
| PNF14-10LF-3K | D1.110 |
| PNF14-10LF-C | D1.25 |
| PNF14-10LFN-3K | D1.110 |
| PNF14-10R-3K | D1.104 |
| PNF14-10R-C | D1.8 |
| PNF14-10SLF-3K | D1.112 |
| PNF14-10SLF-C | D1.27 |
| PNF14-14F-3K | D1.108 |
| PNF14-14F-C | D1.22 |
| PNF14-14R-3K | D1.104 |
| PNF14-14R-C | D1.8 |
| PNF14-14SLF-C | D1.27 |
| PNF14-38R-L | D1.8 |
| PNF14-4R-3K | D1.104 |
| PNF14-4R-C | D1.8 |
| PNF14-56R-C | D1.8 |
| PNF14-5SLF-C | D1.27 |
| PNF14-6F-3K | D1.108 |
| PNF14-6F-C | D1.22 |
| PNF14-6FF-3K | D1.114 |
| PNF14-6FN-3K | D1.108 |
| PNF14-6LF-3K | D1.110 |
| PNF14-6LF-C | D1.25 |
| PNF14-6LFW-C | D1.25 |
| PNF14-6R-3K | D1.104 |
| PNF14-6R-C | D1.8 |
| PNF14-6RN-3K | D1.104 |
| PNF14-6RN-C | D1.8 |
| PNF14-6SLF-3K | D1.112 |
| PNF14-6SLF-C | D1.27 |
| PNF14-8F-3K | D1.108 |
| PNF14-8F-C | D1.22 |
| PNF14-8FF-3K | D1.114 |
| PNF14-8LF-C | D1.25 |
| PNF14-8R-3K | D1.104 |
| PNF14-8R-C | D1.8 |
| PNF14-8SLF-C | D1.27 |
| PNF18-10F-3K | D1.108 |
| PNF18-10F-C | D1.22 |
| PNF18-10FF-3K | D1.114 |
| PNF18-10LF-3K | D1.110 |
| PNF18-10LF-C | D1.25 |
| PNF18-10R-3K | D1.104 |
| PNF18-10R-C | D1.8 |
| PNF18-10SLF-3K | D1.112 |
| PNF18-10SLF-C | D1.27 |
| PNF18-14F-3K | D1.108 |
| PNF18-14F-C | D1.22 |
| PNF18-14R-3K | D1.104 |
| PNF18-14R-C | D1.8 |
| PNF18-38R-C | D1.8 |
| PNF18-4R-3K | D1.104 |
| PNF18-4R-C | D1.8 |
| PNF18-4RN-3K | D1.104 |
| PNF18-56R-C | D1.8 |
| PNF18-5SLF-3K | D1.112 |
| PNF18-5SLF-C | D1.27 |
| PNF18-6F-3K | D1.108 |
| PNF18-6F-C | D1.22 |
| PNF18-6FF-3K | D1.114 |
| PNF18-6FN-3K | D1.108 |
| PNF18-6LF-3K | D1.110 |
| PNF18-6LF-C | D1.25 |

| Part Number | Page Number |
|---------------------|---------------|
| PNF18-6LFW-3K | D1.110 |
| PNF18-6LFW-C | D1.25 |
| PNF18-6R-3K | D1.104 |
| PNF18-6R-C | D1.8 |
| PNF18-6RN-3K | D1.104 |
| PNF18-6RN-C | D1.8 |
| PNF18-6SLF-3K | D1.112 |
| PNF18-6SLF-C | D1.27 |
| PNF18-8F-3K | D1.108 |
| PNF18-8F-C | D1.22 |
| PNF18-8FF-3K | D1.114 |
| PNF18-8LF-3K | D1.110 |
| PNF18-8LF-C | D1.25 |
| PNF18-8R-3K | D1.104 |
| PNF18-8R-C | D1.8 |
| PNF18-8SLF-3K | D1.112 |
| PNF18-8SLF-C | D1.27 |
| PNL-1000-2-3 | D2.137 |
| PNL-1000-3 | D2.135 |
| PNL-1/0-L | D2.135 |
| PNL-1/0-2-L | D2.137 |
| PNL-250-2-Q | D2.137 |
| PNL-250-Q | D2.135 |
| PNL-4-C | D2.135 |
| PNL-500-2-3 | D2.137 |
| PNL-500-3 | D2.135 |
| PNL-8-C | D2.135 |
| PNLC-1/0-3 | D2.141 |
| PNLC-250-1 | D2.141 |
| PNLC-500-1 | D2.141 |
| PP1S-S10-X | B2.23 |
| PP1S-S12-X | B2.23 |
| PP2S-S10-X | B2.23 |
| PP2S-S12-X | B2.23 |
| PP5X50F | B1.83 |
| PPC25X50 | B1.83 |
| PPC25X50F | B1.83 |
| PPF2S-S25-V | B2.24, C4.11 |
| PPF2S-S25-V69 | B2.24, C4.11 |
| PPF2SV-S25-V | B2.24, C4.11 |
| PPF2SV-S25-V69 | B2.24, C4.11 |
| PPH10 | B1.111, B3.16 |
| PPM-0 | E3.8 |
| PPM-1-33 | E3.8 |
| PPM-A | E3.8 |
| PPS0305W2200 | E5.23 |
| PPS0507W2200 | E5.23 |
| PPS0710G001 | E5.23 |
| PPS0710G020 | E5.23 |
| PPS1014G002 | E5.23 |
| PPS1209G010 | E5.23 |
| PPS1209G011 | E5.23 |
| PPS1209G012 | E5.23 |
| PPTMT | B3.16 |
| PRA2S-A-Q | B2.6 |
| PRL100BY-0 | E5.36 |
| PRL100BY-18KIT | E5.36 |
| PRL100BY-36KIT | E5.36 |
| PRL100BY-9 | E5.36 |
| PRL100BY-A | E5.36 |
| PRL100BY-BLNK | E5.36 |
| PRL100BY-DSH | E5.36 |
| PRL100BY-Z | E5.36 |
| PRL150YB-0 | E5.36 |
| PRL150YB-9 | E5.36 |
| PRL150YB-A | E5.36 |
| PRL150YB-DSH | E5.36 |
| PRL150YB-Z | E5.36 |
| PRL250YB-0 | E5.36 |
| PRL250YB-9 | E5.36 |
| PRL250YB-A | E5.36 |
| PRL250YB-DSH | E5.36 |
| PRL250YB-Z | E5.36 |
| PRLWP30S-D30 | B1.32 |
| PRLWP50S-D30 | B1.32 |
| PROG-CCCD | E1.14 |
| PROG-EMCD | E1.14 |
| PROG-EMCD3 | E1.14 |
| PRST30S-S14-M30 | B1.75 |
| PRST40SC-D30 | B1.74 |
| PRT1.5S-C | B1.22 |
| PRT1.5S-C0 | B1.23 |
| PRT1.5S-M30 | B1.23 |
| PRT10EH-C | B1.22 |
| PRT10EH-Q0 | B1.24 |
| PRT12EH-C | B1.22 |

| |
|---------------------------------------|
| A. System Overview |
| B1. Cable Ties |
| B2. Cable Accessories |
| B3. Stainless Steel Ties |
| C1. Wiring Duct |
| C2. Surface Raceway |
| C3. Abrasion Protection |
| C4. Cable Management |
| D1. Terminals |
| D2. Power Connectors |
| D3. Grounding Connectors |
| E1. Labeling Systems |
| E2. Labels |
| E3. Pre-Printed & Write-On Markers |
| E4. Permanent Identification |
| E5. Lockout/Tagout & Safety Solutions |
| F. Index |

PANDUIT® ELECTRICAL SOLUTIONS

| A. System Overview | Part Number | Page Number | Part Number | Page Number | Part Number | Page Number |
|---------------------------------------|------------------|--------------|---------------------|---------------|-----------------------|--------------|
| B1. Cable Ties | PRT12EH-Q0 | B1.24 | PSL-4BLK | E5.11 | PSL-SC | E5.14 |
| | PRT15S-C | B1.22 | PSL-4BLK-LB | E5.11 | PSL-STATION | E5.9 |
| | PRT15S-C0 | B1.23 | PSL-4BLU | E5.11 | PSL-STEPS | E5.3 |
| | PRT2EH-C | B1.22 | PSL-4BLU-LB | E5.11 | PSL-TG1 | E5.14 |
| | PRT2EH-C100 | B1.25 | PSL-4GRN | E5.11 | PSL-V13 | E5.5 |
| B2. Cable Accessories | PRT2EH-Q0 | B1.24 | PSL-4GRN-LB | E5.11 | PSL-V2A | E5.5 |
| | PRT2H-L | B1.22 | PSL-4ORG | E5.11 | PSL-V6A | E5.5 |
| | PRT2H-L0 | B1.23 | PSL-4ORG-LB | E5.11 | PSL-V9 | E5.5 |
| | PRT2S-C | B1.22 | PSL-4PRP | E5.11 | PSL-WS | E5.5 |
| | PRT2S-C0 | B1.23 | PSL-4PRP-LB | E5.11 | PSL-WS1A | E5.5 |
| B3. Stainless Steel Ties | PRT3H-L | B1.22 | PSL-4RED | E5.11 | PSM-0-9-Y | E3.7 |
| | PRT3H-L0 | B1.23 | PSL-4RED-LB | E5.11 | PSM-0-Y | E3.7 |
| | PRT3S-C | B1.22 | PSL-4S | E5.9 | PSM-1-33-Y | E3.7 |
| | PRT3S-C0 | B1.23 | PSL-4SWC | E5.9 | PSM-34-66-Y | E3.7 |
| | PRT4H-L | B1.22 | PSL-4TEL | E5.11 | PSM-67-99-Y | E3.7 |
| C1. Wiring Duct | PRT4H-L0 | B1.23 | PSL-4TEL-LB | E5.11 | PSM-A-Y | E3.7 |
| | PRT4S-C | B1.22 | PSL-4YEL | E5.11 | PSM-A-Z-Y | E3.7 |
| | PRT4S-C0 | B1.23 | PSL-4YEL-LB | E5.11 | PSN12-L | D1.66 |
| | PRT5EH-C100 | B1.25 | PSL-5BLK | E5.12 | PSN16-C | D1.66 |
| | PRT5EH-Q | B1.22 | PSL-5BLU | E5.12 | PSN18-C | D1.66 |
| C2. Surface Raceway | PRT5EH-Q0 | B1.24 | PSL-5GRN | E5.12 | PSSB-13 | E5.31 |
| | PRT6EH-C100 | B1.25 | PSL-5RED | E5.12 | PSWM-1500Y | E3.9 |
| | PRT6EH-Q | B1.22 | PSL-5RED-LS | E5.12 | PSWM-375Y | E3.9 |
| | PRT6EH-Q0 | B1.24 | PSL-5WHT | E5.12 | PSWM-750Y | E3.9 |
| | PRT8EH-C | B1.22 | PSL-5YEL | E5.12 | PSWMH-375Y | E3.9 |
| C3. Abrasion Protection | PRT8EH-C100 | B1.25 | PSL-BV1 | E5.6 | PSWMH-750Y | E3.9 |
| | PRT8EH-Q0 | B1.24 | PSL-BV2 | E5.6 | PT10-10R-L | D1.12 |
| | PRWP1.5S-D | B1.30 | PSL-CB | E5.3 | PT10-14R-L | D1.12 |
| | PRWP1.5S-D0 | B1.30 | PSL-CBIL | E5.3 | PT10-6R-L | D1.12 |
| | PRWP1.5S-D30 | B1.30 | PSL-CBILNT | E5.3 | PT10-8R-L | D1.12 |
| C4. Cable Management | PRWP1S-C | B1.30 | PSL-CBL | E5.4 | PT14-10R-C | D1.12 |
| | PRWP1S-D0 | B1.30 | PSL-CBNT | E5.3 | PT14-14R-C | D1.12 |
| | PRWP1SA-D | B1.30 | PSL-CBWL | E5.10 | PT14-4R-C | D1.12 |
| | PRWP1SB-D | B1.30 | PSL-CL110 | E5.4 | PT14-6R-C | D1.12 |
| | PRWP2H-TL | B1.30 | PSL-CL480 | E5.4 | PT14-8R-C | D1.12 |
| D1. Terminals | PRWP2S-D | B1.30 | PSL-DCJB | E5.7 | PT18-10R-C | D1.12 |
| | PRWP2S-D0 | B1.30 | PSL-DCJB-BL | E5.7 | PT18-4R-C | D1.12 |
| | PS12-L | D1.67 | PSL-DCJB-BU | E5.7 | PT18-6R-C | D1.12 |
| | PS16-C | D1.67 | PSL-DCJB-GR | E5.7 | PT18-8R-C | D1.12 |
| | PS18-C | D1.67 | PSL-DCJB-IW | E5.7 | PT2S-ARW | E5.32 |
| D2. Power Connectors | PS-CBLK-Q | D2.64 | PSL-DCJB-YL | E5.7 | PT2S-BLK | E5.32 |
| | PS-CBLU-L | D2.64 | PSL-DCPL | E5.7 | PT2S-RED | E5.32 |
| | PS-CBRN-L | D2.64 | PSL-DCPL-BL | E5.7 | PTH | B1.111 |
| | PSCC-3 | E3.9 | PSL-DCPL-BU | E5.7 | PTR-CLN | E1.11 |
| | PSCC-3Y | E3.9 | PSL-DCPL-GR | E5.7 | PTS | B1.111 |
| D3. Grounding Connectors | PSCC-5Y | E3.9 | PSL-DCPL-IW | E5.7 | PUM-049-2S-D30 | B2.22 |
| | PSCGRN-L | D2.64 | PSL-DCPL-YL | E5.7 | PUM-049-M30 | B2.22 |
| | PSCGRY-L | D2.64 | PSL-DCPLR | E5.7 | PUM-071-2S-D30 | B2.22 |
| | PSCORG-Q | D2.64 | PSL-DCPLR-BL | E5.7 | PUM-071-M30 | B2.22 |
| | PSCPNK-L | D2.64 | PSL-DCPLR-BU | E5.7 | PUM-100-2S-D30 | B2.22 |
| E1. Labeling Systems | PSCPUR-Q | D2.64 | PSL-DCPLR-GR | E5.7 | PUM-100-M30 | B2.22 |
| | PSCRED-L | D2.64 | PSL-DCPLR-IW | E5.7 | PUM-925-2S-D30 | B2.22 |
| | PSCYEL-Q | D2.64 | PSL-DCPLR-YL | E5.7 | PUM-925-M30 | B2.22 |
| | PSJBXIW | C2.58 | PSL-ERB | E5.5 | PV10-10F-L | D1.23 |
| | PSL-1 | E5.13 | PSL-GLB | E5.9 | PV10-10FB-2K | D1.109 |
| E2. Labels | PSL-1.5 | E5.13 | PSL-HD1 | E5.13 | PV10-10FF-L | D1.28 |
| | PSL-1.5A | E5.13 | PSL-HD2.4 | E5.13 | PV10-10FFB-2K | D1.114 |
| | PSL-10S | E5.9 | PSL-HD3 | E5.13 | PV10-10FX-L | D1.24 |
| | PSL-10SWC | E5.9 | PSL-KT-CONA | E5.8 | PV10-10LF-L | D1.25 |
| | PSL-11BLK | E5.11 | PSL-KT-MROA | E5.8 | PV10-10LFB-2K | D1.111 |
| E3. Pre-Printed & Write-On Markers | PSL-11BLK-LS | E5.11 | PSL-KT-PWR | E5.8 | PV10-10LFX-L | D1.26 |
| | PSL-11BLU | E5.11 | PSL-LCM | E5.2 | PV10-10R-L | D1.10 |
| | PSL-11BLU-LS | E5.11 | PSL-LTM | E5.2 | PV10-10RB-2K | D1.105 |
| | PSL-11GRN | E5.11 | PSL-LTMGP | E5.2 | PV10-10RX-L | D1.11 |
| | PSL-11GRN-LS | E5.11 | PSL-LTMS | E5.2 | PV10-10SLF-L | D1.27 |
| E4. Permanent Identification | PSL-11ORNG | E5.11 | PSL-LTP | E5.2 | PV10-10SLFB-2K | D1.113 |
| | PSL-11ORNG-LS | E5.11 | PSL-LTPGP | E5.2 | PV10-12R-L | D1.10 |
| | PSL-11RED | E5.11 | PSL-LTPS | E5.2 | PV10-14F-L | D1.23 |
| | PSL-11RED-LS | E5.11 | PSL-LTV | E5.2 | PV10-14FB-2K | D1.109 |
| | PSL-11YEL | E5.11 | PSL-LTV-DVD | E5.2 | PV10-14FX-L | D1.24 |
| E5. Lockout/Tagout & Safety Solutions | PSL-11YEL-LS | E5.11 | PSL-MLD | E5.6, E5.13 | PV10-14LF-L | D1.25 |
| | PSL-1A | E5.13 | PSL-MLDC | E5.6 | PV10-14LFB-2K | D1.111 |
| | PSL-20S | E5.9 | PSL-MLDC200 | E5.6 | PV10-14LFX-L | D1.26 |
| | PSL-20SWC | E5.9 | PSL-MLDH-X | E5.6, E5.13 | PV10-14R-L | D1.10 |
| | PSL-3BLACK | E5.12 | PSL-P | E5.4 | PV10-14RB-2K | D1.105 |
| F. Index | PSL-3BLACK-LS | E5.12 | PSL-PC | E5.14 | PV10-14RX-L | D1.11 |
| | PSL-3BLUE | E5.12 | PSL-PE1 | E5.14 | PV10-14SLF-L | D1.27 |
| | PSL-3BLUE-LS | E5.12 | PSL-PE2 | E5.14 | PV10-38R-L | D1.10 |
| | PSL-3GREEN | E5.12 | PSL-PEL | E5.6 | PV10-38RB-2K | D1.105 |
| | PSL-3GREEN-LS | E5.12 | PSL-PK-EA | E5.8 | PV10-38RX-L | D1.11 |
| PSL-3RED | E5.12 | PSL-PL1BLKY | E5.13 | PV10-56R-L | D1.10 | |
| PSL-3RED-LS | E5.12 | PSL-PL1BLUY | E5.13 | PV10-56RB-2K | D1.105 | |
| PSL-3WHITE | E5.12 | PSL-PL1GRNY | E5.13 | PV10-56RX-L | D1.11 | |
| PSL-3WHITE-LS | E5.12 | PSL-PL1REDY | E5.13 | PV10-5SLF-L | D1.27 | |
| PSL-3YELLOW | E5.12 | PSL-PL1WHTY | E5.13 | PV10-610R-L | D1.12 | |
| PSL-3YELLOW-LS | E5.12 | PSL-PL1YELY | E5.13 | PV10-610RB-2K | D1.105 | |

PANDUIT® ELECTRICAL SOLUTIONS

| Part Number | Page Number | Part Number | Page Number | Part Number | Page Number |
|----------------|-------------|----------------|-------------|----------------|-------------|
| PV10-6F-L | D1.23 | PV14-6LFB-3K | D1.111 | PV18-8LFX-CY | D1.26 |
| PV10-6FB-2K | D1.109 | PV14-6LFW-C | D1.25 | PV18-8R-CY | D1.10 |
| PV10-6LF-L | D1.25 | PV14-6LFWB-3K | D1.111 | PV18-8RB-3K | D1.105 |
| PV10-6LFB-2K | D1.111 | PV14-6LFX-C | D1.26 | PV18-8RX-CY | D1.11 |
| PV10-6LFX-L | D1.26 | PV14-6R-C | D1.10 | PV18-8SLF-CY | D1.27 |
| PV10-6R-L | D1.10 | PV14-6RB-3K | D1.105 | PV18-8SLFB-3K | D1.113 |
| PV10-6RB-2K | D1.105 | PV14-6RN-C | D1.10 | PV18-P47-CY | D1.54 |
| PV10-6RX-L | D1.11 | PV14-6RNB-3K | D1.105 | PV18-P47B-3K | D1.130 |
| PV10-6SLF-L | D1.27 | PV14-6RX-C | D1.11 | PV2-10R-XY | D1.15 |
| PV10-6SLFB-2K | D1.113 | PV14-6SFF-C | D1.27 | PV2-10RX-XY | D1.16 |
| PV10-8F-L | D1.23 | PV14-6SLFB-3K | D1.113 | PV2-12R-XY | D1.15 |
| PV10-8FB-2K | D1.109 | PV14-8F-C | D1.23 | PV2-12RX-XY | D1.16 |
| PV10-8FF-L | D1.28 | PV14-8FB-3K | D1.109 | PV2-14R-XY | D1.15 |
| PV10-8FFB-2K | D1.114 | PV14-8FF-C | D1.28 | PV2-14RX-XY | D1.16 |
| PV10-8FX-L | D1.24 | PV14-8FFB-3K | D1.114 | PV2-38R-XY | D1.15 |
| PV10-8LF-L | D1.25 | PV14-8FX-C | D1.24 | PV2-38RX-XY | D1.16 |
| PV10-8LFB-2K | D1.111 | PV14-8LF-C | D1.25 | PV2-56R-XY | D1.15 |
| PV10-8LFX-L | D1.26 | PV14-8LFB-3K | D1.111 | PV2-56RX-XY | D1.16 |
| PV10-8R-L | D1.10 | PV14-8LFX-C | D1.26 | PV22-10R-C | D1.10 |
| PV10-8RB-2K | D1.105 | PV14-8R-C | D1.10 | PV22-2F-C | D1.23 |
| PV10-8RX-L | D1.11 | PV14-8RB-3K | D1.105 | PV22-2R-C | D1.10 |
| PV10-8SLF-L | D1.27 | PV14-8RX-C | D1.11 | PV22-4F-C | D1.23 |
| PV10-8SLFB-2K | D1.113 | PV14-8SLF-C | D1.27 | PV22-4R-C | D1.10 |
| PV10-P55-L | D1.54 | PV14-8SLFB-3K | D1.113 | PV22-6F-C | D1.23 |
| PV12-10HDR-L | D1.14 | PV14-P47-C | D1.54 | PV22-6R-C | D1.10 |
| PV12-10HDRB-2K | D1.106 | PV14-P47B-3K | D1.130 | PV22-8R-C | D1.10 |
| PV12-10HDRX-L | D1.14 | PV18-10F-CY | D1.23 | PV4-10R-E | D1.15 |
| PV12-14HDR-L | D1.14 | PV18-10FB-3K | D1.109 | PV4-10RX-E | D1.16 |
| PV12-14HDRB-2K | D1.106 | PV18-10FF-CY | D1.28 | PV4-12R-E | D1.15 |
| PV12-14HDRX-L | D1.14 | PV18-10FFB-3K | D1.114 | PV4-12RX-E | D1.16 |
| PV12-38HDR-L | D1.14 | PV18-10FN-CY | D1.23 | PV4-14R-E | D1.15 |
| PV12-38HDRB-2K | D1.106 | PV18-10FX-CY | D1.24 | PV4-14RX-E | D1.16 |
| PV12-38HDRX-L | D1.14 | PV18-10LF-CY | D1.25 | PV4-38R-E | D1.15 |
| PV12-56HDR-L | D1.14 | PV18-10LFB-3K | D1.111 | PV4-38RX-E | D1.16 |
| PV12-56HDRB-2K | D1.106 | PV18-10LFN-CY | D1.25 | PV4-56R-E | D1.15 |
| PV12-56HDRX-L | D1.14 | PV18-10LFNB-3K | D1.111 | PV4-56RX-E | D1.16 |
| PV12-6HDR-L | D1.14 | PV18-10LFX-CY | D1.26 | PV6-10R-E | D1.15 |
| PV12-6HDRB-2K | D1.106 | PV18-10R-CY | D1.10 | PV6-10RX-E | D1.16 |
| PV12-6HDRX-L | D1.14 | PV18-10RB-3K | D1.105 | PV6-12R-E | D1.15 |
| PV12-8HDR-L | D1.14 | PV18-10RX-CY | D1.11 | PV6-12RX-E | D1.16 |
| PV12-8HDRB-2K | D1.106 | PV18-10SLF-CY | D1.27 | PV6-14R-E | D1.15 |
| PV12-8HDRX-L | D1.14 | PV18-10SLFB-3K | D1.113 | PV6-14RX-E | D1.16 |
| PV14-10F-C | D1.23 | PV18-12R-CY | D1.10 | PV6-38R-E | D1.15 |
| PV14-10FB-3K | D1.109 | PV18-14FB-3K | D1.109 | PV6-38RX-E | D1.16 |
| PV14-10FF-C | D1.28 | PV18-14R-CY | D1.10 | PV6-56R-E | D1.15 |
| PV14-10FFB-3K | D1.114 | PV18-14RB-3K | D1.105 | PV6-56RX-E | D1.16 |
| PV14-10FN-C | D1.23 | PV18-14RX-CY | D1.11 | PV6-8R-E | D1.15 |
| PV14-10FNB-3K | D1.109 | PV18-38R-CY | D1.10 | PV6-8RX-E | D1.16 |
| PV14-10FX-C | D1.24 | PV18-38RB-2K | D1.105 | PV8-10R-QY | D1.15 |
| PV14-10LF-C | D1.25 | PV18-38RX-CY | D1.11 | PV8-10RX-QY | D1.16 |
| PV14-10LFB-3K | D1.111 | PV18-4R-CY | D1.10 | PV8-12R-QY | D1.15 |
| PV14-10LFN-C | D1.25 | PV18-4RB-3K | D1.105 | PV8-12RX-QY | D1.16 |
| PV14-10LFX-C | D1.26 | PV18-4RNB-3K | D1.105 | PV8-14R-QY | D1.15 |
| PV14-10R-C | D1.10 | PV18-4RX-CY | D1.11 | PV8-14RX-QY | D1.16 |
| PV14-10RB-3K | D1.105 | PV18-56R-CY | D1.10 | PV8-38R-QY | D1.15 |
| PV14-10RX-C | D1.11 | PV18-56RB-2K | D1.105 | PV8-38RX-QY | D1.16 |
| PV14-10SLF-C | D1.27 | PV18-56RX-CY | D1.11 | PV8-56R-QY | D1.15 |
| PV14-10SLFB-3K | D1.113 | PV18-5SLF-CY | D1.27 | PV8-56RX-QY | D1.16 |
| PV14-12R-L | D1.10 | PV18-5SLFB-3K | D1.113 | PV8-8R-QY | D1.15 |
| PV14-14F-C | D1.23 | PV18-610R-CY | D1.12 | PV8-8RX-QY | D1.16 |
| PV14-14FB-3K | D1.109 | PV18-610RB-3K | D1.105 | PVL100BY-0 | E5.34 |
| PV14-14R-C | D1.10 | PV18-6F-CY | D1.23 | PVL100BY-0-Y | E5.34 |
| PV14-14RB-3K | D1.105 | PV18-6FB-3K | D1.109 | PVL100BY-1 | E5.34 |
| PV14-14RX-C | D1.11 | PV18-6FF-CY | D1.28 | PVL100BY-1-Y | E5.34 |
| PV14-14SLF-C | D1.27 | PV18-6FFB-3K | D1.114 | PVL100BY-9 | E5.34 |
| PV14-14SLFB-3K | D1.113 | PV18-6FN-CY | D1.23 | PVL100BY-9-Y | E5.34 |
| PV14-38R-L | D1.10 | PV18-6FNB-3K | D1.109 | PVL100BY-A | E5.34 |
| PV14-38RB-2K | D1.105 | PV18-6FX-CY | D1.24 | PVL100BY-A-Y | E5.34 |
| PV14-38RX-L | D1.11 | PV18-6LF-CY | D1.25 | PVL100BY-DSH | E5.34 |
| PV14-4R-C | D1.10 | PV18-6LFB-3K | D1.111 | PVL100BY-DSH-Y | E5.34 |
| PV14-4RB-3K | D1.105 | PV18-6LFW-CY | D1.25 | PVL100BY-Z | E5.34 |
| PV14-4RX-C | D1.11 | PV18-6LFWB-3K | D1.111 | PVL100BY-Z-Y | E5.34 |
| PV14-56R-C | D1.10 | PV18-6LFX-CY | D1.26 | PVL200BY-0 | E5.34 |
| PV14-56RB-2K | D1.105 | PV18-6R-CY | D1.10 | PVL200BY-0-Y | E5.34 |
| PV14-56RX-C | D1.11 | PV18-6RB-3K | D1.105 | PVL200BY-1 | E5.34 |
| PV14-5SLF-C | D1.27 | PV18-6RNB-3K | D1.105 | PVL200BY-1-Y | E5.34 |
| PV14-610R-C | D1.12 | PV18-6RX-CY | D1.11 | PVL200BY-9 | E5.34 |
| PV14-610RB-3K | D1.105 | PV18-6SLF-CY | D1.27 | PVL200BY-9-Y | E5.34 |
| PV14-6F-C | D1.23 | PV18-6SLFB-3K | D1.113 | PVL200BY-A | E5.34 |
| PV14-6FB-3K | D1.109 | PV18-8F-CY | D1.23 | PVL200BY-A-Y | E5.34 |
| PV14-6FF-C | D1.28 | PV18-8FB-3K | D1.109 | PVL200BY-DSH | E5.34 |
| PV14-6FFB-3K | D1.114 | PV18-8FF-CY | D1.28 | PVL200BY-DSH-Y | E5.34 |
| PV14-6FN-C | D1.23 | PV18-8FFB-3K | D1.114 | PVL200BY-Z | E5.34 |
| PV14-6FNB-3K | D1.109 | PV18-8FX-CY | D1.24 | PVL200BY-Z-Y | E5.34 |
| PV14-6FX-C | D1.24 | PV18-8LF-CY | D1.25 | PW100F-C | C3.2 |
| PV14-6LF-C | D1.25 | PV18-8LFB-3K | D1.111 | PW100F-C20 | C3.2 |

| |
|---------------------------------------|
| A. System Overview |
| B1. Cable Ties |
| B2. Cable Accessories |
| B3. Stainless Steel Ties |
| C1. Wiring Duct |
| C2. Surface Raceway |
| C3. Abrasion Protection |
| C4. Cable Management |
| D1. Terminals |
| D2. Power Connectors |
| D3. Grounding Connectors |
| E1. Labeling Systems |
| E2. Labels |
| E3. Pre-Printed & Write-On Markers |
| E4. Permanent Identification |
| E5. Lockout/Tagout & Safety Solutions |
| F. Index |

PANDUIT® ELECTRICAL SOLUTIONS

| A. System Overview | Part Number | Page Number | Part Number | Page Number | Part Number | Page Number |
|---------------------------------------|-------------|--------------|----------------|--------------|--------------|-------------|
| B1. Cable Ties | PW100FR-C | C3.2 | RSC4-6-L | D2.106 | S100X125VADY | E2.20 |
| | PW100FR-C20 | C3.2 | RSC4/0-1/0-X | D2.106 | S100X125VAFY | E3.11 |
| | PW150F-L | C3.2 | RSC4/0-2/0-X | D2.106 | S100X125VARY | E3.11 |
| | PW150F-L20 | C3.2 | RSC4/0-4-X | D2.106 | S100X125VATY | E2.7 |
| | PW150F-Q | C3.2 | RSC4/0-6-X | D2.106 | S100X125VAJ | E2.2 |
| | PW150F-Q20 | C3.2 | RSC500-X350-6 | D2.106 | S100X150TAD | E2.20 |
| | PW150FR-L | C3.2 | RSC500-X4/0-6 | D2.106 | S100X150TAT | E2.7 |
| | PW150FR-L20 | C3.2 | RSC750-4/0-6 | D2.107 | S100X150V0TY | E2.7 |
| | PW150FR-Q | C3.2 | RSC750-500-6 | D2.107 | S100X150V9TY | E2.7 |
| | PW150FR-Q20 | C3.2 | RSC750-750-6 | D2.107 | S100X150VA1Y | E2.7 |
| B2. Cable Accessories | PW50F-T | C3.2 | RSC750-X350-6 | D2.107 | S100X150VAC | E1.4 |
| | PW50F-T20 | C3.2 | RSC750-X4/0-6 | D2.107 | S100X150VADY | E2.20 |
| | PW50FR-T | C3.2 | RSC750-X500-6 | D2.107 | S100X150VATY | E2.7 |
| | PW50FR-T20 | C3.2 | RSCK1/0-4-1 | D2.104 | S100X150VBC | E1.4 |
| | PW75F-C | C3.2 | RSCK1/0-6-1 | D2.104 | S100X150VBTY | E2.7 |
| | PW75F-C20 | C3.2 | RSCK2-4-1 | D2.104 | S100X150VCTY | E2.7 |
| | PW75FR-C | C3.2 | RSCK2-6-1 | D2.104 | S100X150VDC | E1.4 |
| | PW75FR-C20 | C3.2 | RSCK2/0-4-1 | D2.104 | S100X150VDTY | E2.7 |
| | PWMS-H25-C | B2.18 | RSCK2/0-6-1 | D2.104 | S100X150VETY | E2.7 |
| | PWMS-H25-M0 | B2.18 | RSCK4-6-1 | D2.104 | S100X150VFTY | E2.7 |
| C1. Wiring Duct | PWT100 | C3.2 | RSCK4/0-1/0-1 | D2.105 | S100X150VGTY | E2.7 |
| | PWT150 | C3.2 | RSCK4/0-2/0-1 | D2.105 | S100X150VHC | E1.4 |
| | PWT50 | C3.2 | RSCK4/0-4-1 | D2.104 | S100X150VHTY | E2.7 |
| | PWT75 | C3.2 | RSCK4/0-6-1 | D2.104 | S100X150VIC | E1.4 |
| | PX-0 | B1.51, B2.28 | RSCK500-X350-1 | D2.105 | S100X150VITY | E2.7 |
| | PX-10 | B1.51, B2.28 | RSCK500-X4/0-1 | D2.105 | S100X150YAJ | E2.2 |
| | PX-2 | B1.51, B2.28 | RSCK750-4/0-1 | D2.105 | S100X225TAD | E2.21 |
| | | | RSCK750-500-1 | D2.105 | S100X225TAT | E2.7 |
| | | | RSCK750-750-1 | D2.105 | S100X225V0TY | E2.8 |
| | | | RSCK750-X350-1 | D2.105 | S100X225V9TY | E2.8 |
| C2. Surface Raceway | | | RSCK750-X4/0-1 | D2.105 | S100X225VA1Y | E2.7 |
| | | | RSCK750-X500-1 | D2.105 | S100X225VAC | E1.4 |
| | | | RSCKX750-4/0-1 | D2.105 | S100X225VADY | E2.21 |
| | | | RSCKX750-750-1 | D2.105 | S100X225VAFY | E3.11 |
| | | | RSCX750-4/0-3 | D2.107 | S100X225VARY | E3.11 |
| | | | RSCX750-750-3 | D2.107 | S100X225VATY | E2.7 |
| | | | RT1HT | B3.15 | S100X225VBC | E1.4 |
| | | | RT1HTN | B3.15 | S100X225VBTY | E2.7 |
| | | | | | S100X225VCTY | E2.7 |
| | | | | | S100X225VDC | E1.4 |
| C3. Abrasion Protection | | | | | S100X225VDTY | E2.8 |
| | | | | | S100X225VETY | E2.8 |
| | | | | | S100X225VFTY | E2.8 |
| | | | | | S100X225VGTY | E2.8 |
| | | | | | S100X225VHC | E1.4 |
| | | | | | S100X225VHTY | E2.8 |
| | | | | | S100X225VIC | E1.4 |
| | | | | | S100X225VITY | E2.8 |
| | | | | | S100X225VJTY | E2.2 |
| | | | | | S100X400TAD | E2.21 |
| C4. Cable Management | | | | | S100X400VA1Y | E2.8 |
| | | | | | S100X400VAC | E1.4 |
| | | | | | S100X400VADY | E2.21 |
| | | | | | S100X400VATY | E2.8 |
| | | | | | S100X400YAJ | E2.2 |
| | | | | | S100X650TAD | E2.21 |
| | | | | | S100X650VA1Y | E2.8 |
| | | | | | S100X650VAC | E1.4 |
| | | | | | S100X650VADY | E2.21 |
| | | | | | S100X650VATY | E2.8 |
| D1. Terminals | | | | | S100X650YAJ | E2.2 |
| | | | | | S150X150VATY | E2.8 |
| | | | | | S150X225VATY | E2.8 |
| | | | | | S150X400VATY | E2.8 |
| | | | | | S1F-C | C1.31 |
| | | | | | S2-10R-X | D1.20 |
| | | | | | S2-12R-X | D1.20 |
| | | | | | S2-14R-X | D1.20 |
| | | | | | S2-38R-X | D1.20 |
| | | | | | S2-56R-X | D1.20 |
| D2. Power Connectors | | | | | S2/0-12R-X | D1.20 |
| | | | | | S2/0-14R-X | D1.20 |
| | | | | | S2/0-38R-X | D1.20 |
| | | | | | S2/0-56R-X | D1.20 |
| | | | | | S2/0-76R-X | D1.20 |
| | | | | | S200X225TAD | E2.21 |
| | | | | | S200X225VA1Y | E2.8 |
| | | | | | S200X225VADY | E2.21 |
| | | | | | S200X225VATY | E2.8 |
| | | | | | S200X225YAJ | E2.2 |
| D3. Grounding Connectors | | | | | S200X400TAD | E2.21 |
| | | | | | S200X400TAT | E2.8 |
| | | | | | S200X400VA1Y | E2.8 |
| | | | | | S200X400VADY | E2.21 |
| | | | | | S200X400VATY | E2.8 |
| | | | | | S200X400VDTY | E2.8 |
| | | | | | S200X400VET | E2.8 |
| | | | | | S200X400VFTY | E2.8 |
| | | | | | S200X400VGTY | E2.8 |
| | | | | | S200X400VHTY | E2.8 |
| E1. Labeling Systems | | | | | S200X400VITY | E2.8 |
| | | | | | S200X400VJTY | E2.2 |
| | | | | | S200X400VKT | E2.8 |
| | | | | | S200X400VLT | E2.8 |
| | | | | | S200X400VMT | E2.8 |
| | | | | | S200X400VNT | E2.8 |
| | | | | | S200X400VOT | E2.8 |
| | | | | | S200X400VPT | E2.8 |
| | | | | | S200X400VQT | E2.8 |
| | | | | | S200X400VRT | E2.8 |
| E2. Labels | | | | | S200X400VST | E2.8 |
| | | | | | S200X400VTT | E2.8 |
| | | | | | S200X400VUT | E2.8 |
| | | | | | S200X400VVT | E2.8 |
| | | | | | S200X400VWT | E2.8 |
| | | | | | S200X400VXT | E2.8 |
| | | | | | S200X400VYT | E2.8 |
| | | | | | S200X400VZT | E2.8 |
| | | | | | S200X400VAT | E2.8 |
| | | | | | S200X400VBT | E2.8 |
| E3. Pre-Printed & Write-On Markers | | | | | S200X400VCT | E2.8 |
| | | | | | S200X400VDT | E2.8 |
| | | | | | S200X400VET | E2.8 |
| | | | | | S200X400VFT | E2.8 |
| | | | | | S200X400VGT | E2.8 |
| | | | | | S200X400VHT | E2.8 |
| | | | | | S200X400VIT | E2.8 |
| | | | | | S200X400VJT | E2.2 |
| | | | | | S200X400VKT | E2.8 |
| | | | | | S200X400VLT | E2.8 |
| E4. Permanent Identification | | | | | S200X400VMT | E2.8 |
| | | | | | S200X400VNT | E2.8 |
| | | | | | S200X400VOT | E2.8 |
| | | | | | S200X400VPT | E2.8 |
| | | | | | S200X400VQT | E2.8 |
| | | | | | S200X400VRT | E2.8 |
| | | | | | S200X400VST | E2.8 |
| | | | | | S200X400VTT | E2.8 |
| | | | | | S200X400VUT | E2.8 |
| | | | | | S200X400VVT | E2.8 |
| E5. Lockout/Tagout & Safety Solutions | | | | | S200X400VWT | E2.8 |
| | | | | | S200X400VXT | E2.8 |
| | | | | | S200X400VYT | E2.8 |
| | | | | | S200X400VZT | E2.8 |
| | | | | | S200X400VAT | E2.8 |
| | | | | | S200X400VBT | E2.8 |
| | | | | | S200X400VCT | E2.8 |
| | | | | | S200X400VDT | E2.8 |
| | | | | | S200X400VET | E2.8 |
| | | | | | S200X400VFT | E2.8 |
| F. Index | | | | | S200X400VGT | E2.8 |
| | | | | | S200X400VHT | E2.8 |
| | | | | | S200X400VIT | E2.8 |
| | | | | | S200X400VJT | E2.2 |
| | | | | | S200X400VKT | E2.8 |
| | | | | | S200X400VLT | E2.8 |
| | | | | | S200X400VMT | E2.8 |
| | | | | | S200X400VNT | E2.8 |
| | | | | | S200X400VOT | E2.8 |
| | | | | | S200X400VPT | E2.8 |

PANDUIT® ELECTRICAL SOLUTIONS

| Part Number | Page Number | Part Number | Page Number | Part Number | Page Number |
|--------------|--------------|------------------|---------------|---------------|-------------|
| S200X400YAJ | E2.2 | SBC8L-C | D2.131 | SCSF4/0-X | D2.103 |
| S200X650TAD | E2.21 | SBCT10-C | D2.132 | SCSF6-L | D2.103 |
| S200X650VA1Y | E2.8 | SBCT1/0-L | D2.132 | SCSF8-L | D2.103 |
| S200X650VADY | E2.21 | SBCT1000-1 | D2.132 | SCSS1-Q | D2.59 |
| S200X650VATY | E2.8 | SBCT2-C | D2.132 | SCSS1/0-X | D2.59 |
| S200X650YAJ | E2.2 | SBCT2/0-Q | D2.132 | SCSS2-Q | D2.59 |
| S250-12R-5 | D1.20 | SBCT250-Q | D2.132 | SCSS2/0-X | D2.59 |
| S250-38R-5 | D1.20 | SBCT3-C | D2.132 | SCSS250-X | D2.59 |
| S250-56R-5 | D1.20 | SBCT3/0-Q | D2.132 | SCSS3/0-X | D2.59 |
| S250-76R-5 | D1.20 | SBCT350-1 | D2.132 | SCSS4-L | D2.59 |
| S2F-C | C1.31 | SBCT500-1 | D2.132 | SCSS4/0-X | D2.59 |
| S2X2YL6NM | C1.56 | SBCT6-C | D2.132 | SCSS6-L | D2.59 |
| S3/0-12R-5 | D1.20 | SBCT750-1 | D2.132 | SCSS8-L | D2.59 |
| S3/0-14R-5 | D1.20 | SBCT8-C | D2.132 | SCT1/0-1/0 | D2.63 |
| S3/0-38R-5 | D1.20 | SCH1-E | D2.62 | SCT2-2 | D2.63 |
| S3/0-56R-5 | D1.20 | SCH1/0-X | D2.62 | SCT2/0-2/0 | D2.63 |
| S3/0-76R-5 | D1.20 | SCH1000-3 | D2.62 | SCT250-250 | D2.63 |
| S3F-C | C1.31 | SCH2-Q | D2.62 | SCT300-300 | D2.63 |
| S4-10R-E | D1.20 | SCH2/0-X | D2.62 | SCT350-350 | D2.63 |
| S4-14R-E | D1.20 | SCH250-X | D2.62 | SCT4/0-1/0 | D2.63 |
| S4-38R-E | D1.20 | SCH3/0-X | D2.62 | SCT4/0-4/0 | D2.63 |
| S4-56R-E | D1.20 | SCH300-X | D2.62 | SCT500-4/0 | D2.63 |
| S4/0-12R-5 | D1.20 | SCH350-X | D2.62 | SCT500-500 | D2.63 |
| S4/0-38R-5 | D1.20 | SCH4-L | D2.62 | SD2H6 | C1.26 |
| S4/0-56R-5 | D1.20 | SCH4/0-X | D2.62 | SD2HWH6 | C1.26 |
| S4/0-76R-5 | D1.20 | SCH500-6 | D2.62 | SD3H6 | C1.26 |
| S4F-C | C1.31 | SCH6-L | D2.62 | SD3HWH6 | C1.26 |
| S4X4YL6NM | C1.56 | SCH750-6 | D2.62 | SD4H6 | C1.26 |
| S6-10R-E | D1.20 | SCL1-E | D2.61 | SD4HWH6 | C1.26 |
| S6-14R-E | D1.20 | SCL1/0-X | D2.61 | SE125P-LR0 | C3.13 |
| S6-38R-E | D1.20 | SCL1000-3 | D2.61 | SE125P-LR8 | C3.13 |
| S6-56R-E | D1.20 | SCL2-Q | D2.61 | SE125P-TR0 | C3.13 |
| S8-10R-Q | D1.20 | SCL2/0-X | D2.61 | SE125P-TR10 | C3.13 |
| S8-14R-Q | D1.20 | SCL250-X | D2.61 | SE125P-TR8 | C3.13 |
| S8-38R-Q | D1.20 | SCL3/0-X | D2.61 | SE125PFR-LR0 | C3.14 |
| S8-56R-Q | D1.20 | SCL300-X | D2.61 | SE125PFR-LR8 | C3.14 |
| SA1-X | D2.119 | SCL350-X | D2.61 | SE125PFR-TR0 | C3.14 |
| SA1/0-X | D2.119 | SCL4-L | D2.61 | SE125PFR-TR10 | C3.14 |
| SA1000-1 | D2.119 | SCL4/0-X | D2.61 | SE125PFR-TR8 | C3.14 |
| SA2-X | D2.119 | SCL400-6 | D2.61 | SE125PSC-LR0 | C3.15 |
| SA2/0-5 | D2.119 | SCL500-6 | D2.61 | SE12P-MR0 | C3.13 |
| SA250-5 | D2.119 | SCL6-L | D2.61 | SE12P-MR10 | C3.13 |
| SA3/0-5 | D2.119 | SCL600-6 | D2.61 | SE12P-MR8 | C3.13 |
| SA300-2 | D2.119 | SCL750-6 | D2.61 | SE12P-TR0 | C3.13 |
| SA350-2 | D2.119 | SCL8-L | D2.61 | SE12P-TR8 | C3.13 |
| SA4-X | D2.119 | SCMS10-C | D2.112 | SE12PFR-MR0 | C3.14 |
| SA4/0-5 | D2.119 | SCMS120-Q | D2.112 | SE12PFR-MR10 | C3.14 |
| SA400-2 | D2.119 | SCMS150-X | D2.112 | SE12PFR-MR8 | C3.14 |
| SA500-2 | D2.119 | SCMS16-C | D2.112 | SE12PFR-TR0 | C3.14 |
| SA6-X | D2.119 | SCMS185-X | D2.112 | SE12PFR-TR8 | C3.14 |
| SA600-2 | D2.119 | SCMS240-X | D2.112 | SE12PSC-TR0 | C3.15 |
| SA750-1 | D2.119 | SCMS25-L | D2.112 | SE150P-LR0 | C3.13 |
| SA800-1 | D2.119 | SCMS300-5 | D2.112 | SE150P-LR8 | C3.13 |
| SACS50-T100 | B1.54, B2.27 | SCMS35-L | D2.112 | SE150P-TR0 | C3.13 |
| SAR1/0-2-X | D2.120 | SCMS400-5 | D2.112 | SE150P-TR10 | C3.13 |
| SAR2-4-X | D2.120 | SCMS50-L | D2.112 | SE150P-TR8 | C3.13 |
| SAR3/0-1/0-5 | D2.120 | SCMS500-6 | D2.112 | SE150PFR-LR0 | C3.14 |
| SAR350-4/0-2 | D2.120 | SCMS630-6 | D2.112 | SE150PFR-LR8 | C3.14 |
| SAR4/0-2/0-5 | D2.120 | SCMS70-L | D2.112 | SE150PFR-TR0 | C3.14 |
| SAR500-350-2 | D2.120 | SCMS95-Q | D2.112 | SE150PFR-TR10 | C3.14 |
| SAR600-500-2 | D2.120 | SCS1-E | D2.60 | SE150PFR-TR8 | C3.14 |
| SAR750-600-2 | D2.120 | SCS1/0-X | D2.60 | SE150PSC-LR0 | C3.15 |
| SBA1/0-Q | D2.133 | SCS1000-3 | D2.60 | SE175P-TR0 | C3.13 |
| SBA2-C | D2.133 | SCS2-Q | D2.60 | SE175PFR-TR0 | C3.14 |
| SBA2/0-Q | D2.133 | SCS2/0-X | D2.60 | SE25P-MR0 | C3.13 |
| SBA350-1 | D2.133 | SCS250-X | D2.60 | SE25P-MR10 | C3.13 |
| SBA4-C | D2.133 | SCS3/0-X | D2.60 | SE25P-MR8 | C3.13 |
| SBA4/0-Q | D2.133 | SCS300-X | D2.60 | SE25P-TR0 | C3.13 |
| SBA500-1 | D2.133 | SCS350-X | D2.60 | SE25P-TR8 | C3.13 |
| SBA6-C | D2.133 | SCS4-L | D2.60 | SE25PFR-MR0 | C3.14 |
| SBC1/0-L | D2.131 | SCS4/0-X | D2.60 | SE25PFR-MR10 | C3.14 |
| SBC1000-1 | D2.131 | SCS400-6 | D2.60 | SE25PFR-MR8 | C3.14 |
| SBC2-C | D2.131 | SCS500-6 | D2.60 | SE25PFR-TR0 | C3.14 |
| SBC2L-3 | D2.131 | SCS6-L | D2.60 | SE25PFR-TR8 | C3.14 |
| SBC2/0-Q | D2.131 | SCS600-6 | D2.60 | SE25PSC-TR0 | C3.15 |
| SBC250-Q | D2.131 | SCS750-6 | D2.60 | SE38P-MR0 | C3.13 |
| SCC3-C | D2.131 | SCS8-L | D2.60 | SE38P-MR10 | C3.13 |
| SBC3/0-Q | D2.131 | SCSF1-X | D2.103 | SE38P-MR8 | C3.13 |
| SBC350-1 | D2.131 | SCSF1/0-X | D2.103 | SE38P-TR0 | C3.13 |
| SBC4S-C | D2.131 | SCSF2-E | D2.103 | SE38P-TR8 | C3.13 |
| SBC4SL-C | D2.131 | SCSF2/0-X | D2.103 | SE38PFR-MR10 | C3.14 |
| SBC500-1 | D2.131 | SCSF250-X | D2.103 | SE38PFR-MR8 | C3.14 |
| SBC6S-C | D2.131 | SCSF3/0-X | D2.103 | SE38PSC-TR0 | C3.15 |
| SBC6SL-C | D2.131 | SCSF300-6 | D2.103 | SE50P-CR0 | C3.13 |
| SBC750-1 | D2.131 | SCSF350-6 | D2.103 | SE50P-CR8 | C3.13 |
| SBC8-C | D2.131 | SCSF4-L | D2.103 | SE50P-DR0 | C3.13 |

| |
|---------------------------------------|
| A. System Overview |
| B1. Cable Ties |
| B2. Cable Accessories |
| B3. Stainless Steel Ties |
| C1. Wiring Duct |
| C2. Surface Raceway |
| C3. Abrasion Protection |
| C4. Cable Management |
| D1. Terminals |
| D2. Power Connectors |
| D3. Grounding Connectors |
| E1. Labeling Systems |
| E2. Labels |
| E3. Pre-Printed & Write-On Markers |
| E4. Permanent Identification |
| E5. Lockout/Tagout & Safety Solutions |
| F. Index |

PANDUIT® ELECTRICAL SOLUTIONS

| A. System Overview | Part Number | Page Number | Part Number | Page Number | Part Number | Page Number | |
|-------------------------|--------------------------|-----------------|----------------|--------------|----------------|---------------|-------|
| B1. Cable Ties | SE50P-DR10 | C3.13 | SNS37F-C | C1.31 | SSC4H-S25-D0 | B1.70 | |
| | SE50P-DR8 | C3.13 | SNS50F-C | C1.31 | SSC4H-S25-D30 | B1.70 | |
| | SE50PFR-CR0 | C3.14 | SNS62F-C | C1.31 | SSC4H-S25-L | B1.70 | |
| | SE50PFR-CR8 | C3.14 | SNS75F-C | C1.31 | SSC4S-S10-C | B1.70 | |
| | SE50PFR-DR0 | C3.14 | SP1-1/0-L | D3.17 | SSC4S-S10-M0 | B1.70 | |
| | SE50PFR-DR10 | C3.14 | SP1-1/0L-L | D3.17 | SSM2S-C | B1.71 | |
| | SE50PFR-DR8 | C3.14 | SP1-2-C | D3.17 | SSM2S-D0 | B1.71 | |
| | SE50PSC-CR0 | C3.15 | SP1-2/0-Q | D3.17 | SSM4S-D | B1.71 | |
| | SE75P-CR0 | C3.13 | SP1-2/0L-Q | D3.17 | SSPM2.5H-L300 | B1.79 | |
| | SE75P-CR8 | C3.13 | SP1-2L-C | D3.17 | SSPM2.5HP-L300 | B1.79 | |
| B2. Cable Accessories | SE75P-DR0 | C3.13 | SP1-3-C | D3.17 | SSPM4H-L300 | B1.79 | |
| | SE75P-DR10 | C3.13 | SP1-350-12 | D3.17 | SSPM4HLP-TL300 | B1.79 | |
| | SE75P-DR8 | C3.13 | SP1-350L-12 | D3.17 | SSPM4HP-L300 | B1.79 | |
| | SE75PFR-CR0 | C3.14 | SP1-3L-C | D3.17 | SST1.5I-C | B1.67 | |
| | SE75PFR-CR8 | C3.14 | SP1-4-C | D3.17 | SST1.5I-M0 | B1.68 | |
| | SE75PFR-DR0 | C3.14 | SP1-4/0-Q | D3.17 | SST1.5M-C | B1.67 | |
| | SE75PFR-DR10 | C3.14 | SP1-4/0L-Q | D3.17 | SST1.5M-M0 | B1.68 | |
| | SE75PFR-DR8 | C3.14 | SP1-4L-C | D3.17 | SST1.5M-M30 | B1.69 | |
| | SE75PSC-CR0 | C3.15 | SP1-500-12 | D3.17 | SST1.5S-M | B1.67 | |
| | B3. Stainless Steel Ties | SEZ-1CLL | E5.38 | SP1-500L-12 | D3.17 | SST1.5S-M0 | B1.68 |
| SEZ-1DLL | | E5.38 | SP1-7-C | D3.17 | SST1M-C | B1.67 | |
| SEZ-1NLL | | E5.38 | SP1-7L-C | D3.17 | SST1M-C0 | B1.68 | |
| SEZ-1WHLL | | E5.38 | SP1-8-C | D3.17 | SST1M-M30 | B1.69 | |
| SEZ-1WLL | | E5.38 | SP1-8L-C | D3.17 | SST2H-D | B1.67 | |
| SEZ-1YLL | | E5.38 | SP2-1/0-L | D3.18 | SST2H-D0 | B1.68 | |
| SG100M-C | | B1.40 | SP2-1/0L-L | D3.18 | SST2HH-D30 | B1.69 | |
| SG100M-C0 | | B1.41 | SP2-2-C | D3.18 | SST2I-C | B1.67 | |
| SG150I-C | | B1.40 | SP2-2/0-Q | D3.18 | SST2I-M0 | B1.68 | |
| SG150I-C0 | | B1.41 | SP2-2/0L-Q | D3.18 | SST2S-C | B1.67 | |
| C1. Wiring Duct | SG200S-C | B1.40 | SP2-2L-C | D3.18 | SST2S-C0 | B1.68 | |
| | SG200S-C0 | B1.41 | SP2-3-C | D3.18 | SST2S-M30 | B1.69 | |
| | SG200S-M30 | B1.41 | SP2-350-12 | D3.18 | SST3I-C | B1.67 | |
| | SG250S-C | B1.40 | SP2-350L-12 | D3.18 | SST3I-C0 | B1.68 | |
| | SG250S-C0 | B1.41 | SP2-3L-C | D3.18 | SST3S-C | B1.67 | |
| | SG300S-C | B1.40 | SP2-4-C | D3.18 | SST3S-C0 | B1.68 | |
| | SG300S-C0 | B1.41 | SP2-4/0-Q | D3.18 | SST3S-M30 | B1.69 | |
| | SG300S-M30 | B1.41 | SP2-4/0L-Q | D3.18 | SST4H-D30 | B1.69 | |
| | SG350LH-L | B1.40 | SP2-4L-C | D3.18 | SST4H-L | B1.67 | |
| | SG350LH-L0 | B1.41 | SP2-500-12 | D3.18 | SST4H-L0 | B1.68 | |
| C2. Surface Raceway | SG350LH-TL30 | B1.41 | SP2-500L-12 | D3.18 | SST4HH-D30 | B1.69 | |
| | SG370S-C | B1.40 | SP2-7-C | D3.18 | SST4I-C | B1.67 | |
| | SG370S-C0 | B1.41 | SP2-7L-C | D3.18 | SST4I-M0 | B1.68 | |
| | SG450H-L | B1.40 | SP2-8-C | D3.18 | SST4S-C | B1.67 | |
| | SG450H-L0 | B1.41 | SP2-8L-C | D3.18 | SST4S-C0 | B1.68 | |
| | SGABM20-A-C | B2.5 | SPF1-1/0-L | D3.19 | SST4S-M30 | B1.69 | |
| | SGABM20-AT-C0 | B2.5 | SPF1-2-C | D3.19 | SST8H-D30 | B1.69 | |
| | SGABM25-A-C | B2.5 | SPF1-2/0-Q | D3.19 | SST8H-L | B1.67 | |
| | SGABM25-AT-C0 | B2.5 | SPF1-3-C | D3.19 | SST8H-L0 | B1.68 | |
| | SGABM25-S6-C | B2.5 | SPF1-350-12 | D3.19 | ST2MT | B3.15 | |
| C3. Abrasion Protection | SGABM25-S6-C0 | B2.5 | SPF1-4-C | D3.19 | ST3EH | B1.110 | |
| | SGABM30-A-C | B2.5 | SPF1-4/0-Q | D3.19 | STH2 | B1.110 | |
| | SGABM30-AT-C0 | B2.5 | SPF1-500-12 | D3.19 | STHV | B1.110 | |
| | SGABM40-A-L | B2.5 | SPF1-7-C | D3.19 | STK12 | E4.6 | |
| | SGABM40-AT-L0 | B2.5 | SPF1-8-C | D3.19 | STS2 | B1.110 | |
| | SGABM50-A-L | B2.5 | SPF2-1/0-L | D3.20 | | | |
| | SGABM50-AT-L0 | B2.5 | SPF2-2-C | D3.20 | | | |
| | SGMPMH38-LO | B2.20 | SPF2-2/0-Q | D3.20 | | | |
| | SGMPMS19-C0 | B2.20 | SPF2-3-C | D3.20 | | | |
| | SGMPMS25-C0 | B2.20 | SPF2-350-12 | D3.20 | | | |
| C4. Cable Management | SGMPMWH32-LO | B2.20 | SPF2-4-C | D3.20 | | | |
| | SGTA1S8-C | B2.12 | SPF2-4/0-Q | D3.20 | | | |
| | SGTM1S6-C | B2.14 | SPF2-500-12 | D3.20 | | | |
| | SGTM1S6-C0 | B2.14 | SPF2-7-C | D3.20 | | | |
| | SGTM2S8-C | B2.14 | SPF2-8-C | D3.20 | | | |
| | SGTM2S8-C0 | B2.14 | SR-0-XY | D2.154 | | | |
| | SGTM3S10-C | B2.14 | SR-1000-1Y | D2.154 | | | |
| | SGTM3S10-C0 | B2.14 | SR-2-XY | D2.154 | | | |
| | SHH1-S8-X | B2.50 | SR-250-XY | D2.154 | | | |
| | SHH3-S8-X | B2.50 | SR-350-XY | D2.154 | | | |
| D1. Terminals | SICH100-C | B2.43 | SR-4/0-XY | D2.154 | | | |
| | SICH150-C | B2.43 | SR-500-3Y | D2.154 | | | |
| | SICH25-C | B2.43 | SR-750-1Y | D2.154 | | | |
| | SICH38-C | B2.43 | SR2 | B1.83, D1.37 | | | |
| | SICH50-C | B2.43 | SR4 | D1.37 | | | |
| | SICH75-C | B2.43 | SR6 | D1.37 | | | |
| | SMS-A-C | B2.6 | SRT | C2.83 | | | |
| | SMS-A-C14 | B2.6 | SS-1 | D3.49 | | | |
| | SMS-A-C15 | B2.6 | SS-1GAGE | D3.49 | | | |
| | SMS-S6-D | B2.6 | SSB2S-C | B1.77 | | | |
| D2. Power Connectors | SNS.5-C | C1.31 | SSB2S-M0 | B1.77 | | | |
| | SNS.75-C | C1.31 | SSB2S-M30 | B1.77 | | | |
| | SNS1-C | C1.31 | SSC2S-S10-C | B1.70 | | | |
| | SNS1.5-C | C1.31 | SSC2S-S10-M0 | B1.70 | | | |
| | SNS2-C | C1.31 | SSC2S-S10-M30 | B1.70 | | | |
| | SNS25F-C | C1.31 | SSC2S-S6-C | B1.70 | | | |
| | SNS3-C | C1.31 | SSC2S-S6-M0 | B1.70 | | | |
| | D3. Grounding Connectors | T | | | | | |
| | | | T024X000FJC-BK | E1.9 | | | |
| | | | T031X000FJC-BK | E1.9 | | | |
| T038X000FJC-BK | | | E1.9 | | | | |
| T038X000VPC-BK | | | E1.10 | | | | |
| T038X000VYC-WH | | | E1.10 | | | | |
| T038X000YKC-BK | | | E1.10 | | | | |
| T050X000CBC-BK | | | E1.5 | | | | |
| T050X000VPC-BK | | | E1.10 | | | | |
| T050X000VQC-BK | | | E1.10 | | | | |
| T050X000VQC-WH | E1.10 | | | | | | |
| T050X000VSC-BK | E1.10 | | | | | | |
| T050X000VSC-WH | E1.10 | | | | | | |
| T050X000VUC-BK | E1.10 | | | | | | |
| T050X000VVC-BK | E1.10 | | | | | | |
| T050X000VVC-WH | E1.10 | | | | | | |
| T050X000VXC-BK | E1.10 | | | | | | |
| T050X000VYC-WH | E1.10 | | | | | | |
| T050X000YKC-BK | E1.10 | | | | | | |
| T050X000YKC-WH | E1.10 | | | | | | |
| T075X000VPC-BK | E1.10 | | | | | | |
| T075X000YKC-BK | E1.10 | | | | | | |
| T100F-C | C3.5 | | | | | | |
| T100F-C0 | C3.5 | | | | | | |
| T100FR-C | C3.6 | | | | | | |
| T100FR-C20 | C3.6 | | | | | | |
| T100N-C | C3.7 | | | | | | |
| T100N-C0 | C3.7 | | | | | | |
| T100R-CY | C3.6 | | | | | | |
| T100T-X | C3.7 | | | | | | |
| D2. Power Connectors | F. Index | | | | | | |
| | | | | | | | |
| | | | | | | | |
| | | | | | | | |
| | | | | | | | |
| | | | | | | | |
| | | | | | | | |
| | | | | | | | |
| | | | | | | | |
| | | | | | | | |
| | | | | | | | |

PANDUIT® ELECTRICAL SOLUTIONS

| Part Number | Page Number | Part Number | Page Number | Part Number | Page Number |
|----------------|-------------|--------------------|---------------------|---------------|---------------------------------|
| T100X000CBC-BK | E1.5 | T400X000VX1Y | E2.19 | T70FH2IW | C2.52 |
| T100X000VP1Y | E2.19 | T400X000VY1Y | E2.19 | T70FH4IW | C2.52 |
| T100X000VPC-BK | E1.10 | T400X000Y2T | E5.32 | T70FSB | C2.40 |
| T100X000VQ1Y | E2.19 | T425X000YK1 | E2.19 | T70FV2IW | C2.52 |
| T100X000VQC-BK | E1.10 | T400X000YX1 | E5.23 | T70FV4IW | C2.52 |
| T100X000VQC-WH | E1.10 | T45BIW10 | C2.48 | T70HB-X | C2.40 |
| T100X000VS1Y | E2.19 | T45BIW10-A | C2.48 | T70HB3-X | C2.40 |
| T100X000VSC-BK | E1.10 | T45BIW8 | C2.48 | T70HB3GFCI-X | C2.40 |
| T100X000VSC-WH | E1.10 | T45BIW8-A | C2.48 | T70ICIW | C2.36 |
| T100X000VU1Y | E2.19 | T45CCIW-X | C2.49 | T70KW2IW | C2.54 |
| T100X000VUC-BK | E1.10 | T45CIW10 | C2.48 | T70KW4IW | C2.54 |
| T100X000VUC-WH | E1.10 | T45CIW8 | C2.48 | T70L2IW | C2.55 |
| T100X000VW1Y | E2.19 | T45DW10 | C2.48 | T70L4IW | C2.55 |
| T100X000VWC-BK | E1.10 | T45DW8 | C2.48 | T70LV2IW | C2.55 |
| T100X000VWC-WH | E1.10 | T45ECIW | C2.49 | T70LV4IW | C2.55 |
| T100X000VX1Y | E2.19 | T45EEIW | C2.49 | T70N2IW | C2.56 |
| T100X000VXC-BK | E1.10 | T45HDBIW | C2.49 | T70N4IW | C2.56 |
| T100X000VXC-WH | E1.10 | T45HEBIW | C2.49 | T70NV2IW | C2.56 |
| T100X000VY1Y | E2.19 | T45HEGBIW | C2.49 | T70NV4IW | C2.56 |
| T100X000VYC-WH | E1.10 | T45ICIW | C2.49 | T70OCIW | C2.37 |
| T100X000YKC-BK | E1.10 | T45OCIW | C2.49 | T70PGIW | C2.53 |
| T100X000YKC-WH | E1.10 | T45RAIW | C2.49 | T70PGSIW | C2.53 |
| T12F-C | C3.4 | T45RLDIW | C2.49 | T70PIW | C2.53 |
| T12F-C0 | C3.5 | T45TD | C2.49 | T70PNIW | C2.53 |
| T12FR-C | C3.6 | T45TIW | C2.49 | T70PSIW | C2.53 |
| T12FR-C20 | C3.6 | T45TRI | C2.49 | T70RAIW | C2.36 |
| T12N-C | C3.6 | T45WC2IW | C2.49 | T70S-X | C2.40 |
| T12N-C0 | C3.7 | T45WCIW | C2.49 | T70SDB-X | C2.26, C2.40, C2.101, C2.110 |
| T12R-CY | C3.5 | T45WR-X | C2.49 | T70TD | C2.37 |
| T12T-C | C3.7 | T50F-C | C3.4 | T70TIW | C2.37 |
| T19F-C | C3.4 | T50F-C0 | C3.5 | T70TRCIW | C2.37 |
| T19F-C0 | C3.5 | T50F-C1 | C3.4 | T70TRI | C2.37 |
| T19FR-C | C3.6 | T50F-C10 | C3.4 | T70TRIW | C2.37 |
| T19FR-C20 | C3.6 | T50F-C16 | C3.5 | T70WC2IW | C2.37 |
| T19N-C | C3.6 | T50F-C2 | C3.5 | T70WCIW | C2.37 |
| T19N-C0 | C3.7 | T50F-C3Y | C3.5 | T70WM40TRIW | C2.37 |
| T19R-CY | C3.5 | T50F-C4Y | C3.5 | T70WR-X | C2.40 |
| T19T-C | C3.7 | T50F-C5 | C3.5 | T75F-C | C3.5 |
| T200X000VP1Y | E2.19 | T50F-C6 | C3.5 | T75F-C0 | C3.5 |
| T200X000VQ1 | E2.19 | T50F-C7 | C3.5 | T75FR-C | C3.6 |
| T200X000VQ1Y | E2.19 | T50F-C8 | C3.5 | T75FR-C20 | C3.6 |
| T200X000VS1Y | E2.19 | T50F-X | C3.4 | T75N-C | C3.7 |
| T200X000VT1Y | E2.19 | T50F-X0 | C3.5 | T75N-C0 | C3.7 |
| T200X000VU1Y | E2.19 | T50FR-C | C3.6 | T75R-CY | C3.6 |
| T200X000VV1Y | E2.19 | T50FR-C20 | C3.6 | T75T-X | C3.7 |
| T200X000VW1Y | E2.19 | T50N-C | C3.7 | TA1S10-C | B2.12 |
| T200X000VX1Y | E2.19 | T50N-C0 | C3.7 | TA1S10-M0 | B2.12 |
| T200X000VY1Y | E2.19 | T50R-CY | C3.5 | TA1S8-C | B2.12 |
| T200X000Y2T | E5.32 | T50T-Q | C3.7 | TA1S8-M0 | B2.12 |
| T200X000YK1 | E2.19 | T62F-C | C3.5 | TA1S8-M30 | B2.12 |
| T225X000YK1 | E2.19 | T62F-C0 | C3.5 | TA1S8-M69 | B2.12 |
| T25F-C | C3.4 | T62FR-C | C3.6 | TA2-C | B2.13 |
| T25F-C0 | C3.5 | T62FR-C20 | C3.6 | TA2-M | B2.13 |
| T25F-C1 | C3.4 | T62N-C | C3.7 | TAPC2-2/0-X | D2.123, D3.8 |
| T25F-C10 | C3.4 | T62N-C0 | C3.7 | TAPC3/0-4/0-5 | D2.123, D3.8 |
| T25F-C16 | C3.4 | T62R-CY | C3.6 | TAPC500-2 | D2.123, D3.8 |
| T25F-C2 | C3.4 | T62T-Q | C3.7 | TC10-14-C100 | B2.41 |
| T25F-C3Y | C3.4 | T702BCIW-X | C2.39 | TC14-20-C100 | B2.41 |
| T25F-C4Y | C3.4 | T702BIW10 | C2.38 | TC3-5-C100 | B2.41 |
| T25F-C5 | C3.4 | T702BIW8 | C2.38 | TC5-7-C100 | B2.41 |
| T25F-C6 | C3.4 | T702ECIW | C2.39 | TC5X8-C100 | B2.41 |
| T25F-C7 | C3.4 | T702EEIW | C2.39 | TC6X10-C100 | B2.41 |
| T25F-C8 | C3.4 | T702ICIW | C2.39 | TC7-10-C100 | B2.41 |
| T25F-X0 | C3.5 | T702OCIW | C2.39 | TC7X14-C100 | B2.41 |
| T25FR-C | C3.6 | T702RAIW | C2.39 | TC9X18-C100 | B2.41 |
| T25FR-C20 | C3.6 | T702TIW | C2.39 | TDP42HY | E1.12 |
| T25N-C | C3.6 | T702TRI | C2.39 | TDP43HY | E1.12 |
| T25N-C0 | C3.7 | T702TRIW | C2.39 | TDP43M-AC | E1.11 |
| T25R-C20Y | C3.5 | T702TRLIW | C2.39 | TDP43M-CASE | E1.11 |
| T25R-CY | C3.5 | T70B1IW | C2.53 | TDP43M-RS | E1.11 |
| T25T-L | C3.7 | T70B2IW | C2.53 | TDP43MY | E1.11 |
| T38F-C | C3.4 | T70BCIW-X | C2.36 | TDP46HY | E1.12 |
| T38F-C0 | C3.5 | T70BFI | C2.37 | TF10IW-X | C2.79 |
| T38FR-C | C3.6 | T70BFIW | C2.37 | TF3IW-E | C2.79 |
| T38FR-C20 | C3.6 | T70BH1IW | C2.53 | TF5IW-E | C2.79 |
| T38N-C | C3.6 | T70BH2IW | C2.53 | TFC10IW-X | C2.80 |
| T38N-C0 | C3.7 | T70BIW10 | C2.36 | TFC3IW-X | C2.80 |
| T38R-CY | C3.5 | T70BIW8 | C2.36 | TFC5IW-X | C2.80 |
| T400X000VP1Y | E2.19 | T70CCIW-X | C2.25, C2.36, C2.39 | TFX10IW-X | C2.81 |
| T400X000VQ1 | E2.19 | T70CIW10 | C2.24, C2.36, C2.38 | TFX3IW-X | C2.81 |
| T400X000VQ1Y | E2.19 | T70CIW8 | C2.24, C2.36, C2.38 | TFX5IW-X | C2.81 |
| T400X000VS1Y | E2.19 | T70DB-X | C2.26, C2.40 | TFXD10IW-X | C2.75 |
| T400X000VT1Y | E2.19 | T70DW10 | C2.36, C2.38 | TG70BCIW-X | C2.25 |
| T400X000VU1Y | E2.19 | T70DW8 | C2.36, C2.38 | TG70HB3-X | C2.26 |
| T400X000VV1Y | E2.19 | T70ECIW | C2.37 | TG70HB3GFCI-X | C2.26 |
| T400X000VW1Y | E2.19 | T70EEIW | C2.37 | | |

A. System Overview

B1. Cable Ties

B2. Cable Accessories

B3. Stainless Steel Ties

C1. Wiring Duct

C2. Surface Raceway

C3. Abrasion Protection

C4. Cable Management

D1. Terminals

D2. Power Connectors

D3. Grounding Connectors

E1. Labeling Systems

E2. Labels

E3. Pre-Printed & Write-On Markers

E4. Permanent Identification

E5. Lockout/Tagout & Safety Solutions

F. Index

PANDUIT® ELECTRICAL SOLUTIONS

| A. System Overview | Part Number | Page Number | Part Number | Page Number | Part Number | Page Number | |
|---------------------------------------|------------------------------|----------------|-------------|-------------|-------------|-------------|-------|
| B1. Cable Ties | TG70IW10 | C2.24 | TV105-12MY | C3.16 | WR2-C | C1.28 | |
| | TG70IW8 | C2.24 | TV105-1M20Y | C3.16 | WR2H-C | C1.28 | |
| | TG70WR-X | C2.26 | TV105-1MY | C3.16 | WR3-C | C1.28 | |
| | TGBFI | C2.25 | TV105-3M20Y | C3.16 | WR4-C | C1.28 | |
| | TGBFIW | C2.25 | TV105-3MY | C3.16 | WR5-C | C1.28 | |
| | TGDW10 | C2.24 | TV105-6M20Y | C3.16 | WRS-A-C10 | C1.28 | |
| | TGDW8 | C2.24 | TV105-6MY | C3.16 | WS25-25-C | B2.42 | |
| | TGECIW | C2.25 | TWR-C | B2.41 | WS25-50-C | B2.42 | |
| | TGEEIW | C2.25 | TWR-C0 | B2.41 | WS25-75-C | B2.42 | |
| | TGFSB | C2.26 | | | WS35-25-C | B2.42 | |
| B2. Cable Accessories | TGICIW | C2.25 | U | | | WS35-50-C | B2.42 |
| | TGOCIW | C2.25 | UCT3S-X0 | B1.89 | WS35-75-C | B2.42 | |
| | TGRAIW | C2.25 | UCT5S-X0 | B1.89 | WS50-25-C | B2.42 | |
| | TGSICIW | C2.25 | UCTGS1224-X | B1.89 | WS50-50-C | B2.42 | |
| | TGSOCIW | C2.25 | UCTGSM5-X | B1.89 | WS50-75-C | B2.42 | |
| | TGTD | C2.25 | UCTGSM6-X | B1.89 | WS75-25-C | B2.42 | |
| | TGTIW | C2.25 | UGCTC3S-X0 | B1.89 | WS75-50-C | B2.42 | |
| | TGTRIW | C2.25 | UGCTC5S-X0 | B1.89 | WS75-75-C | B2.42 | |
| | THM1SC-C | B1.120 | UGTE3S-X0 | B1.89 | | | |
| | THM1SC-C30 | B1.120 | UGTE5S-X0 | B1.89 | | | |
| B3. Stainless Steel Ties | THMSP20-C | B1.121 | V | | | | |
| | THMSP20-C30 | B1.121 | VCC25-A-C | B2.36 | | | |
| | THMSP20F-C | B1.121 | VCC50-A-C | B2.36 | | | |
| | THMSP20F-C30 | B1.121 | VSC.25-L | B2.42 | | | |
| | THMSP25-C | B1.121 | VSC.25-L100 | B2.42 | | | |
| | THMSP25-C30 | B1.121 | VT-0-Q | D2.133 | | | |
| | THMSP25F-C | B1.121 | VT-1-Q | D2.133 | | | |
| | THMSP25F-C30 | B1.121 | VT-2-Q | D2.133 | | | |
| | TJF-X | B2.48 | VT3-12 | D2.133 | | | |
| | TM1A-C | B2.11 | VT4-12 | D2.133 | | | |
| C1. Wiring Duct | TM1S4-C | B2.9 | VT5-6 | D2.133 | | | |
| | TM1S4-M69 | B1.14, B2.9 | VT6-6 | D2.133 | | | |
| | TM1S6-M69 | B1.14, B2.9 | VTA-0-Q | D2.134 | | | |
| | TM2A-C | B2.11 | VTA-1-Q | D2.134 | | | |
| | TM2PWH25-C | B2.18 | VTA-2-Q | D2.134 | | | |
| | TM2S6-C | B2.9 | VTA-3-12 | D2.134 | | | |
| | TM2S6-M69 | B1.14, B2.9 | VTA-4-12 | D2.134 | | | |
| | TM2S8-C76 | B1.19 | VTA-5-6 | D2.134 | | | |
| | TM2S8-M69 | B1.14, B2.9 | VTA-6-6 | D2.134 | | | |
| | TM3-X2-C0Y | B2.11 | VWS106-C | B2.44 | | | |
| C2. Surface Raceway | TM3A-C | B2.11 | VWS42105-C | B2.43 | | | |
| | TM3S10-C76 | B1.19 | VWS4218-C | B2.43 | | | |
| | TM3S10-M69 | B1.14, B2.9 | VWS4238-C | B2.43 | | | |
| | TM3S8-C | B2.9 | VWS4274-C | B2.43 | | | |
| | TM3S8-C69 | B1.14, B2.9 | VWSDC-C | B2.44 | | | |
| | TM3S8-C76 | B1.19 | W | | | | |
| | TMC100X50BR2 | C1.23 | WB12-L | D3.25 | | | |
| | TMC100X75BR2 | C1.23 | WB34-X | D3.25 | | | |
| | TMC25X37BR2 | C1.23 | WB58-Q | D3.25 | | | |
| | TMC37X37BR2 | C1.23 | WBS6-Q | B2.45 | | | |
| TMC50DW2 | C1.23, C1.27 | WCM35BFIW | C2.91 | | | | |
| C3. Abrasion Protection | TMC50X50BR2 | C1.23 | WCM35BIW8 | C2.90 | | | |
| | TMC75DW2 | C1.23, C1.27 | WCM35CCIW-X | C2.91 | | | |
| | TMC75X50BR2 | C1.23 | WCM35CIW8 | C2.90 | | | |
| | TMC75X75BR2 | C1.23 | WCM35DBFIW | C2.91 | | | |
| | TMEH-S10-C100 | B2.10 | WCM35DW8 | C2.90 | | | |
| | TMEH-S10-C109 | B2.10 | WCM35ECIW | C2.91 | | | |
| | TMEH-S10-Q0 | B2.10 | WCM35ICIW | C2.91 | | | |
| | TMEH-S25-Q0 | B2.10 | WCM35OCIW | C2.91 | | | |
| | TMEH-S8-Q0 | B2.10 | WCM35TI | C2.91 | | | |
| | TMEH-X2-L0Y | B2.11 | WCM35TIW | C2.91 | | | |
| C4. Cable Management | TMSTHS10-D0 | B2.12 | WCM35TR10IW | C2.91 | | | |
| | TMSTHS13-D0 | B2.12 | WCM35TR5IW | C2.91 | | | |
| | TMSTHS16-D0 | B2.12 | WCM35TR70IW | C2.91 | | | |
| | TMSTHS19-D0 | B2.12 | WCM35TRIW | C2.91 | | | |
| | TMSTLHS6-M0 | B2.12 | WCM35WR-X | C2.91 | | | |
| | TMSTLHS8-M0 | B2.12 | WEH-E8-C | B2.49 | | | |
| | TNR | C1.34 | WL1 | E5.25 | | | |
| | TP2-C | B2.15 | WL25 | E5.25 | | | |
| | TP4H-C | B2.15 | WL3 | E5.25 | | | |
| | TRC18FR-X8 | C4.10 | WL32 | E5.25 | | | |
| D1. Terminals | TRC2BL | C1.59 | WL32Y | E5.25 | | | |
| | TRC4BL | C1.59 | WL33 | E5.25 | | | |
| | TTLK3 | B1.112, B3.14 | WL33Y | E5.25 | | | |
| | TTS-20R0 | B1.88 | WL35 | E5.25 | | | |
| | TTS-35R3-0 | B1.88 | WL35Y | E5.25 | | | |
| | TTS-35RX0 | B1.88 | WL36 | E5.25 | | | |
| | TV105-.38D20Y | C3.16 | WL36Y | E5.25 | | | |
| | TV105-.38DY | C3.16 | WPMH-C | B2.21 | | | |
| | TV105-.50D20Y | C3.16 | WPS-20 | C2.60 | | | |
| | TV105-.50DY | C3.16 | WPS-202 | C2.60 | | | |
| D2. Power Connectors | TV105-.75TL20Y | C3.16 | | | | | |
| | TV105-.75TLY | C3.16 | | | | | |
| | TV105-1.0C20Y | C3.16 | | | | | |
| | TV105-1.0CY | C3.16 | | | | | |
| | TV105-12M20Y | C3.16 | | | | | |
| | D3. Grounding Connectors | TV105-38D20Y | C3.16 | | | | |
| | | TV105-38DY | C3.16 | | | | |
| | | TV105-50D20Y | C3.16 | | | | |
| | | TV105-50DY | C3.16 | | | | |
| | | TV105-.75TL20Y | C3.16 | | | | |
| TV105-.75TLY | | C3.16 | | | | | |
| TV105-1.0C20Y | | C3.16 | | | | | |
| TV105-1.0CY | | C3.16 | | | | | |
| TV105-12M20Y | | C3.16 | | | | | |
| E1. Labeling Systems | | TV105-38D20Y | C3.16 | | | | |
| | TV105-38DY | C3.16 | | | | | |
| | TV105-50D20Y | C3.16 | | | | | |
| | TV105-50DY | C3.16 | | | | | |
| | TV105-.75TL20Y | C3.16 | | | | | |
| | TV105-.75TLY | C3.16 | | | | | |
| | TV105-1.0C20Y | C3.16 | | | | | |
| | TV105-1.0CY | C3.16 | | | | | |
| | TV105-12M20Y | C3.16 | | | | | |
| | E2. Labels | TV105-38D20Y | C3.16 | | | | |
| TV105-38DY | | C3.16 | | | | | |
| TV105-50D20Y | | C3.16 | | | | | |
| TV105-50DY | | C3.16 | | | | | |
| TV105-.75TL20Y | | C3.16 | | | | | |
| TV105-.75TLY | | C3.16 | | | | | |
| TV105-1.0C20Y | | C3.16 | | | | | |
| TV105-1.0CY | | C3.16 | | | | | |
| TV105-12M20Y | | C3.16 | | | | | |
| E3. Pre-Printed & Write-On Markers | | TV105-38D20Y | C3.16 | | | | |
| | TV105-38DY | C3.16 | | | | | |
| | TV105-50D20Y | C3.16 | | | | | |
| | TV105-50DY | C3.16 | | | | | |
| | TV105-.75TL20Y | C3.16 | | | | | |
| | TV105-.75TLY | C3.16 | | | | | |
| | TV105-1.0C20Y | C3.16 | | | | | |
| | TV105-1.0CY | C3.16 | | | | | |
| | TV105-12M20Y | C3.16 | | | | | |
| | E4. Permanent Identification | TV105-38D20Y | C3.16 | | | | |
| TV105-38DY | | C3.16 | | | | | |
| TV105-50D20Y | | C3.16 | | | | | |
| TV105-50DY | | C3.16 | | | | | |
| TV105-.75TL20Y | | C3.16 | | | | | |
| TV105-.75TLY | | C3.16 | | | | | |
| TV105-1.0C20Y | | C3.16 | | | | | |
| TV105-1.0CY | | C3.16 | | | | | |
| TV105-12M20Y | | C3.16 | | | | | |
| E5. Lockout/Tagout & Safety Solutions | | TV105-38D20Y | C3.16 | | | | |
| | TV105-38DY | C3.16 | | | | | |
| | TV105-50D20Y | C3.16 | | | | | |
| | TV105-50DY | C3.16 | | | | | |
| | TV105-.75TL20Y | C3.16 | | | | | |
| | TV105-.75TLY | C3.16 | | | | | |
| | TV105-1.0C20Y | C3.16 | | | | | |
| | TV105-1.0CY | C3.16 | | | | | |
| | TV105-12M20Y | C3.16 | | | | | |
| | F. Index | TV105-38D20Y | C3.16 | | | | |
| TV105-38DY | | C3.16 | | | | | |
| TV105-50D20Y | | C3.16 | | | | | |
| TV105-50DY | | C3.16 | | | | | |
| TV105-.75TL20Y | | C3.16 | | | | | |
| TV105-.75TLY | | C3.16 | | | | | |
| TV105-1.0C20Y | | C3.16 | | | | | |
| TV105-1.0CY | | C3.16 | | | | | |
| TV105-12M20Y | | C3.16 | | | | | |
| | | | | | | | |

NOTES

A.
System
Overview

B1.
Cable Ties

B2.
Cable
Accessories

B3.
Stainless
Steel Ties

C1.
Wiring
Duct

C2.
Surface
Raceway

C3.
Abrasion
Protection

C4.
Cable
Management

D1.
Terminals

D2.
Power
Connectors

D3.
Grounding
Connectors

E1.
Labeling
Systems

E2.
Labels

E3.
Pre-Printed
& Write-On
Markers

E4.
Permanent
Identification

E5.
Lockout/
Tagout/
& Safety
Solutions

F.
Index

PANDUIT is a global leader in cabling and communication products, delivering end-to-end solutions in support of demanding electrical and networking requirements.

PANDUIT Catalogs

Network Connectivity

SA-NCCB46



- Cable
- Modules
- Work Area Outlet Solutions
- Surface Raceway
- Zone Cabling Systems
- Wireless Solutions
- Copper Patch Panels, Cords, and Punchdowns
- Fiber Connectors, Enclosures, and Patch Cords
- Overhead and Underfloor Routing Systems
- Cabinets, Racks, and Cable Management
- Grounding and Bonding
- Managed System Solutions
- Industrial
- Labeling and Identification
- Wiring Duct
- Cable Ties and Accessories

Searching by Part Numbers in this Catalog PDF

1. To search for a Part Number in this Catalog PDF, either press the Control key and the letter F (Ctrl-F) at the same time OR from the menu bar, select Edit, and then select Find/Change.

2. The screen will spit into two parts. In the first window on the right side, type in the part number you wish to find. For example, if you wish to find LCCF300-12H-6, type as shown. There is no need to be case sensitive in your typing.

3. When you are done typing, press the "Search" button.

If you want to be less precise in your search, and find all instances of similar part numbers, you could type in just part of the number. For example, if you want to find all the LCCF300 numbers, just type in LCCF300.

4. The right side of the screen, under "Results", will now display all occurrences of the part number. Select any of the choices to be taken to that page.

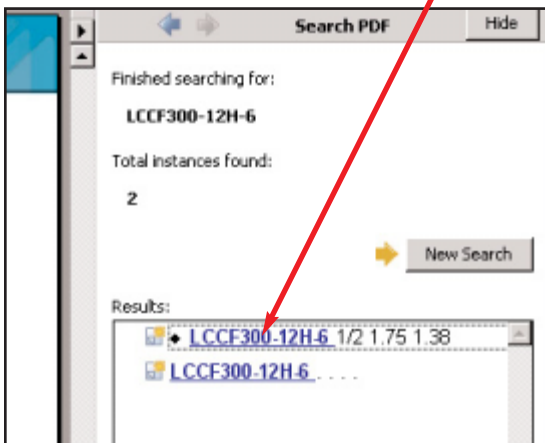
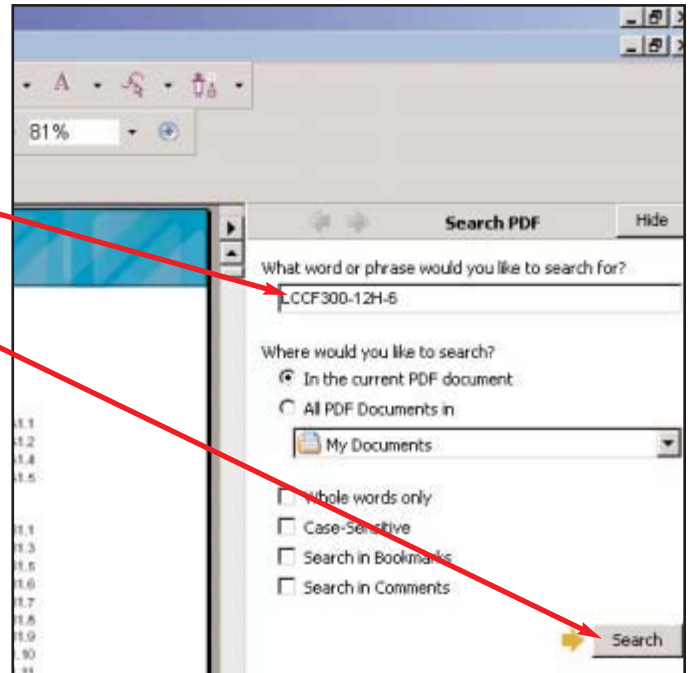

5. The left side of your screen will now show the page with the part number, and the part number will be highlighted (see below).

| Part Number | Class K & M | Locomotive | W | B | T | L | Code | | |
|----------------|-------------|-------------|------|------|------|------|------|------|--------|
| LCCF40-14BH-X | | | 1.14 | 0.75 | 1.17 | 1.81 | 14 | 5.06 | Yellow |
| LCCF40-18DH-X | | | 3.8 | 1.00 | 1.17 | 1.81 | 14 | 5.55 | Yellow |
| LCCF40-18H-X | 40 AWG | 40 AWG | 3.8 | 1.75 | 1.17 | 1.81 | 14 | 4.30 | Yellow |
| LCCF40-12H-X | | | 1.2 | 1.75 | 1.17 | 1.81 | 14 | 4.69 | Yellow |
| LCCF250-14BH-X | | | 1.14 | 0.75 | 1.28 | 2.24 | 17 | 5.88 | White |
| LCCF250-38DH-X | | | 3.8 | 1.00 | 1.28 | 2.24 | 17 | 4.14 | White |
| LCCF250-12BH-X | 250 kcmil | 202.6 kcmil | 1.2 | 1.25 | 1.28 | 2.24 | 17 | 4.82 | White |
| LCCF250-12H-X | | | 1.2 | 1.75 | 1.28 | 2.24 | 17 | 5.32 | White |
| LCCF300-14BH-E | | | 1.14 | 0.75 | 1.38 | 2.30 | 18 | 5.77 | Red |
| LCCF300-38DH-E | | | 3.8 | 1.00 | 1.38 | 2.30 | 18 | 4.25 | Red |
| LCCF300-12H-E | 300 kcmil | 313.1 kcmil | 1.2 | 1.75 | 1.38 | 2.30 | 18 | 5.43 | Red |
| LCCF350-14BH-E | | | 1.14 | 0.75 | 1.55 | 2.50 | 22 | 5.98 | Blue |
| LCCF350-38DH-E | | | 3.8 | 1.00 | 1.55 | 2.50 | 22 | 4.46 | Blue |
| LCCF350-12BH-E | 350 kcmil | 373.7 kcmil | 1.2 | 1.25 | 1.55 | 2.50 | 22 | 5.14 | Blue |
| LCCF350-12H-E | | | 1.2 | 1.75 | 1.55 | 2.50 | 22 | 5.64 | Blue |
| LCCF400-38DH-E | | | 3.8 | 1.00 | 1.70 | 2.69 | 26 | 4.99 | Brown |
| LCCF400-12H-E | 400 kcmil | 444.4 kcmil | 1.2 | 1.75 | 1.70 | 2.69 | 26 | 5.94 | Brown |
| LCCF500-12H-E | 500 kcmil | 535.3 kcmil | 1.2 | 1.75 | 1.89 | 2.88 | 26 | 6.16 | Pink |
| LCCF600-12H-E | --- | 640.4 kcmil | 1.2 | 1.75 | 1.95 | 2.94 | 29 | 6.25 | Black |
| LCCF750-38DH-3 | --- | --- | 3.8 | 1.00 | 2.17 | 3.00 | 32 | 5.45 | Orange |
| LCCF750-12H-3 | --- | --- | 1.2 | 1.75 | 2.17 | 3.00 | 32 | 6.39 | Orange |

6. To return to a full screen view, select the "Hide" button. To keep the "Search PDF" screen and search for more part numbers, select the "New Search" button (see below).

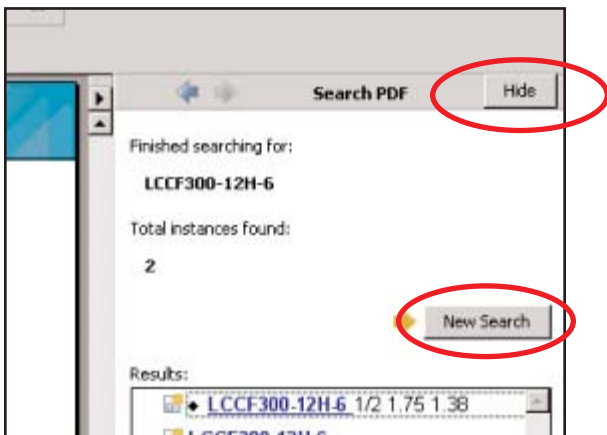

Note: An alternative is to look in the Part Number Index at the back of this PDF and find the part number manually, then manually scroll to the page indicated.

[Click Here to Return to the Table of Contents](#)

USER TIPS / HELP

- ▶ Acrobat Alert: "This file may contain newer..."
- ▶ Links not working, pop-up blocker
- ▶ Windows XP links not working, security alerts
- ▶ View with Browser or Reader Application
- ▶ Bookmarks: quick, easy table of contents
- ▶ Acrobat navigation Next / Previous buttons
- ▶ View facing pages
- ▶ Acrobat Search options

RETURN TO CATALOG

PROGRAM LINKS

Obtain programs that may be necessary to use content on this disc.

CONTACT US

Acrobat Alert "...may contain newer information than this viewer can support..."

When opening PDF documents on this disc, you may see this alert.



Check the **Do not show...** box and click OK. PDF files on this disc are formatted to be completely functional with Acrobat Reader version 5 or higher. As long as the PDF file opens, all required features will be available.

If you wish to upgrade to a newer version of Acrobat (now Adobe) Reader, click the Program Links button to the left.

[TOP](#)

Links not working (Pop-Up Blockers)

Some links will open a new browser window. If you have a pop-up blocker installed in your browser, it may see new linked windows as pop-ups. Setting the blocker to allow pop-ups from this site (CD) should resolve this problem.

[TOP](#)

Links not working / security alerts (Windows XP)

If you have installed Service Pack 2 (SP2) for Windows XP (Home or Professional) you are aware of the very high level of security enforced by the system. It is particularly aggressive in protecting you against "active links". Virtually every file on this CD has active links that allow you to move between pages and open other documents. As a result, some documents may seem to have links that don't work or pages that open blank. If this happens, look at the top of the web page for this alert:

Allow Blocked Content...

What's the Risk?

Information Bar Help

[TOP](#)

USER TIPS / HELP

- ▶ Acrobat Alert: "This file may contain newer..."
- ▶ Links not working, pop-up blocker
- ▶ Windows XP links not working, security alerts
- ▶ View with Browser or Reader Application
- ▶ Bookmarks: quick, easy table of contents
- ▶ Acrobat navigation Next / Previous buttons
- ▶ View facing pages
- ▶ Acrobat Search options

RETURN TO CATALOG

PROGRAM LINKS

Obtain programs that may be necessary to use content on this disc.

CONTACT US

Adobe Reader Application or Browser Options

When you install Acrobat Reader, it installs both an Application (stand-alone program) and a plug-in for your browser program(s). By default it will be configured to open PDF files in your Internet browser. You may setup Acrobat to open documents in either your browser window or to open them in the standard Reader application window.

What's the Difference?

| INTERNET BROWSER WINDOW | APPLICATION WINDOW |
|---|---|
| ▶ Can have only one PDF Document open at a time | ▶ Can have multiple documents open simultaneously |
| ▶ Search may be limited by support provided at the site of the PDF file | ▶ Support for full Search of the site/CD contents |
| ▶ Potential security alert in Windows XP (SP2) everytime you link to a new document | ▶ No Security alerts |

This option can be easily changed in the Reader application. To open the application window, look for the Adobe icon on your Start menu or Desktop. This option can only be edited within the application. These instructions apply to version 5 through 7.

- Select Edit/Preferences
- From the list in the left pane select Internet
- Check "Display PDF in Browser" to have PDF file open in your Browser; uncheck it to have PDF files open in the Reader application.

[TOP](#)

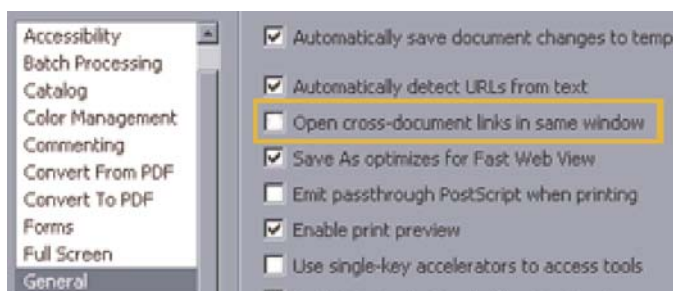
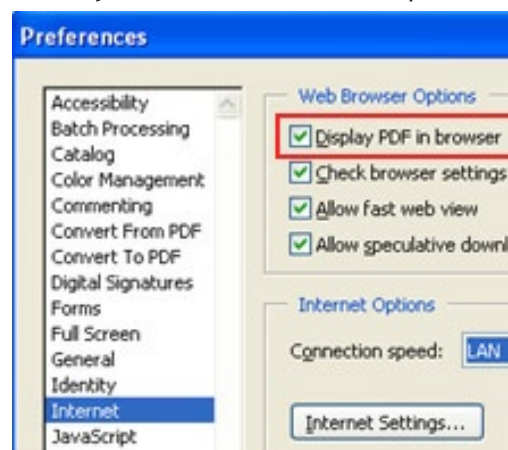

[TOP](#)

The Reader application offers you the option of having links between documents open to replace the original window or open as a new window. While in the Preferences area of Reader, select the General option in the left pane.

Default (checked) is to have links open in the same window. Uncheck "Open cross-document links in same window" if you prefer to have links open in a new window.

Adobe®, Acrobat® and Adobe Reader® are registered or registered tradenames of Adobe Systems, Inc. in the United States and other countries.

USER TIPS / HELP

- ▶ Acrobat Alert: "This file may contain newer..."
- ▶ Links not working, pop-up blocker
- ▶ Windows XP links not working, security alerts
- ▶ View with Browser or Reader Application
- ▶ Bookmarks: quick, easy table of contents
- ▶ Acrobat navigation Next / Previous buttons
- ▶ View facing pages
- ▶ Acrobat Search options

RETURN TO CATALOG

PROGRAM LINKS

Obtain programs that may be necessary to use content on this disc.

CONTACT US

Bookmarks - Hyper Table of Contents

In very large PDF files, Acrobat bookmarks become a much faster and more convenient than searching through massive Table of Content listings.

Bookmarks can be toggled on or off by selecting the appropriate tab on the left side of the page.

Bookmarks contain nested listings so you can locate major categories, then drill down to specific products types.

Click the "+" or "-" in front of the listing to expand or collapse a category.

Click on a bookmark link at any level to jump to that specific location.

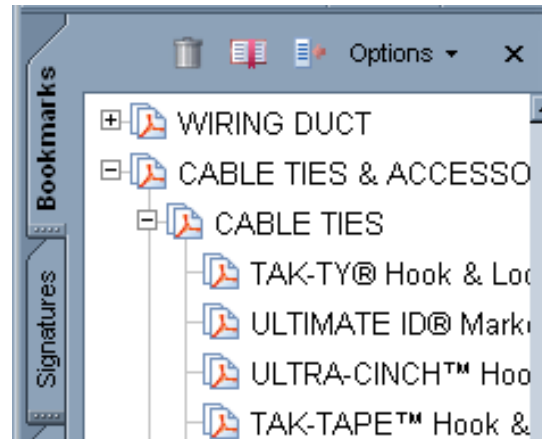

[TOP](#)

Navigation / Page View Options

Acrobat enhances your experience in PDF catalogs with two sets of navigation buttons. The arrow buttons work just like the Next and Previous buttons in a web browser.

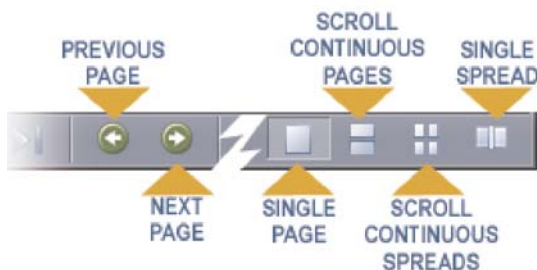

[TOP](#)

Page view buttons allow you to choose to view one page at a time or scroll so you can see portions of the bottom of one page and the top of the next.

Some pages, like Roadmaps in *PANDUIT* catalogs, are best viewed as spreads (side-by-side pages). You can choose this option with the page view buttons.

USER TIPS / HELP

- ▶ Acrobat Alert: "This file may contain newer..."
- ▶ Links not working, pop-up blocker
- ▶ Windows XP links not working, security alerts
- ▶ View with Browser or Reader Application
- ▶ Bookmarks: quick, easy table of contents
- ▶ Acrobat navigation Next / Previous buttons
- ▶ View facing pages
- ▶ Acrobat Search options

RETURN TO CATALOG

PROGRAM LINKS

Obtain programs that may be necessary to use content on this disc.

CONTACT US

Using Acrobat Find or Search

In Acrobat, Find and Search are distinct functions.

- Find scans the currently selected document for matches to your criteria
- Search can be configured to include one or multiple documents on a disc computer or server, then return results that appear in any of those documents.

Acrobat Version 6 or 7

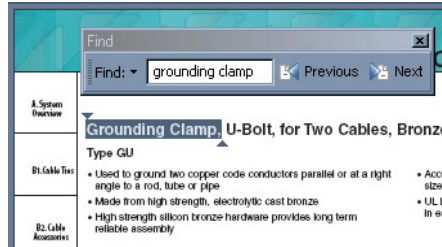

Find is accessed with the Ctrl+F key combo (Edit>Find). Type in the search criteria and click Next. If there are matches to your criteria, a page will appear with the results highlighted. Continuing to click Next or Previous changes pages and highlight locations.

Open **Search** by clicking the binocular button Search (Ctrl+Shift+F). The Search dialog offers the option of selecting locations to be included (1).

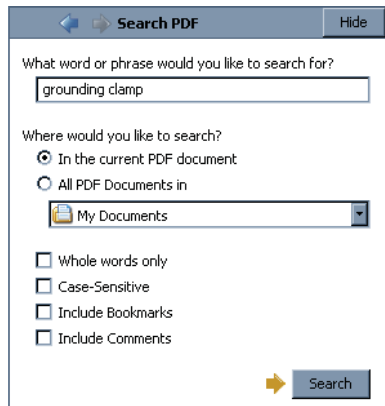

Enter your search criteria, click the search button.

TOP

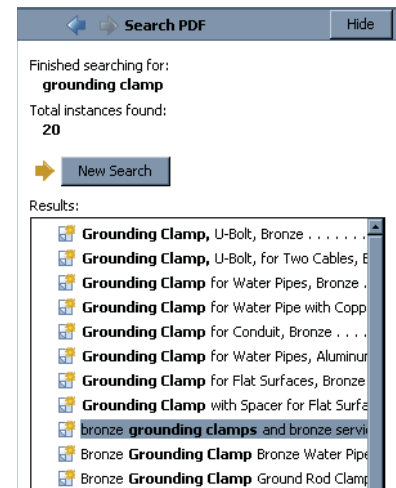

Results will appear as a list. Each item is an active link to that location in the document where it was found. Click a link to jump to that location.

TOP

USER TIPS / HELP

- ▶ Acrobat Alert: "This file may contain newer..."
- ▶ Links not working, pop-up blocker
- ▶ Windows XP links not working, security alerts
- ▶ View with Browser or Reader Application
- ▶ Bookmarks: quick, easy table of contents
- ▶ Acrobat navigation Next / Previous buttons
- ▶ View facing pages
- ▶ Acrobat Search options

RETURN TO CATALOG

PROGRAM LINKS

Obtain programs that may be necessary to use content on this disc.

CONTACT US

Optional Installation Programs & Links

PDF files on this optimized for use with Acrobat 5 or higher.

Installing Acrobat / Adobe Reader

If you don't already have Acrobat Reader, it is always recommended that you download the most current version from the Adobe website. Click the logo under Third Party Links (below) to go the the download page. The name of the program was changed from Acrobat Reader to Adobe Reader starting with Version 6.x. The version on this CD is 7.0.5 (U.S. English, Windows only) and is made available for those who do not have ready access to the internet. To install from this disc, browse the CD folders and open Programs.

Installation Cautions

Adobe strongly recommends that only one version of Reader be installed on any computer. Please uninstall previous versions before you install. Uninstalling a previous version after installing a newer one can also delete files required by the newer one.

Free Third Party Links (if needed)

PANDUIT Web sites, CDs and DVDs may contain multimedia programs that require your computer to have one or more of the following programs or plugins installed. Selecting a file or link requiring one of these programs will alert you of the program required. All these programs are free by way of the Internet links below. If you frequent the Internet, you probably already have some or all of these programs installed.

[TOP](#)



VISIO®, Windows®, 98SE®, Windows 2000® and Windows XP® are trademarks of Microsoft Corporation and may be registered in some jurisdictions.

Adobe® Acrobat® and Reader® are registered or registered tradenames of Adobe Systems, Inc. in the United States and other countries.

Macromedia®, Flash® and Shockwave® are trademarks of Macromedia, Inc.

USER TIPS / HELP

- ▶ Acrobat Alert: "This file may contain newer..."
- ▶ Links not working, pop-up blocker
- ▶ Windows XP links not working, security alerts
- ▶ View with Browser or Reader Application
- ▶ Bookmarks: quick, easy table of contents
- ▶ Acrobat navigation Next / Previous buttons
- ▶ View facing pages
- ▶ Acrobat Search options

RETURN TO CATALOG

PROGRAM LINKS

Obtain programs that may be necessary to use content on this disc.

CONTACT US

Visit PANDUIT on the Web

Get all the latest news about PANDUIT products, services, training and events. Locate distributors. View the always up-to-date online catalog, more downloadable PDF catalogs or request printed materials. Register for newsletters, designer/installer certification; enjoy special catalog features like Favorites and saved Bills of Material

Contact Information

PANDUIT® Corporate Headquarters (North America)

| | | |
|-----------------------------------|-----------|------------------------------------|
| PANDUIT Corp. | Telephone | 888-506-5400 / 708-532-1800 |
| 17301 Ridgeland Avenue | Fax | 708-532-1811 |
| Tinley Park, IL 60477-3091 | eMail | cs@panduit.com |
| U.S.A. | | |

If connected, [click here](#) to view complete, current Sales Office information on our website. Current PANDUIT [warranty information](#) is available on our website.

PANDUIT Latin America Headquarters (Central and South America)

| | | |
|---------------------------------|-----------|---------------------------|
| PANDUIT Latin America | Telephone | 52 333 666 2501 |
| Av. Lazaro Cardenas 2785 | Fax | 52 33 3666 2510 |
| Col. Alamo Industrial | eMail | mkt@panduit.com.mx |
| Guadalajara , Jal 44490 | | |
| Mexico | | |

[TOP](#)

PANDUIT Europe Headquarters (Europe / Middle East / Africa)

| | | |
|---------------------------------|-----------|------------------------|
| PANDUIT Europe Ltd. | Telephone | 44 20 8601 7200 |
| West World | Fax | 44 20 8601 7209 |
| Westgate , London W5 1XP | eMail | cs@panduit.com |
| United Kingdom | | |

[TOP](#)

PANDUIT Aisa/Pacific Headquarters

| | | |
|---------------------------------------|-----------|------------------------------|
| PANDUIT Asia Pacific Pte. Ltd. | Telephone | 65 6379 6700 |
| 60 Tuas Avenue 11 | Fax | 65 6379 6759 |
| Singapore, | eMail | sgp-sales@panduit.com |
| Republic of Singapore 639106 | | |

[TOP](#)